

ADEQ

ARKANSAS
Department of Environmental Quality

September 25, 2009

Clarice Hanusz
Environmental Specialist
Albemarle Corporation
P.O. Box 729
Magnolia, AR 71754-0729

Dear Ms. Hanusz:

The enclosed Permit No. 0762-AOP-R16 is issued pursuant to the Arkansas Operating Permit Program, Regulation # 26.

After considering the facts and requirements of A.C.A. §8-4-101 et seq., and implementing regulations, I have determined that Permit No. 0762-AOP-R16 for the construction, operation and maintenance of an air pollution control system for Albemarle Corporation to be issued and effective on the date specified in the permit, unless a Commission review has been properly requested under Arkansas Department of Pollution Control & Ecology Commission's Administrative Procedures, Regulation 8.603, within thirty (30) days after service of this decision.

All persons submitting written comments during this thirty (30) day period, and all other persons entitled to do so, may request an adjudicatory hearing and Commission review on whether the decision of the Director should be reversed or modified. Such a request shall be in the form and manner required by Regulation 8.603.

Sincerely,



Mike Bates
Chief, Air Division

ADEQ OPERATING AIR PERMIT

Pursuant to the Regulations of the Arkansas Operating Air Permit Program, Regulation 26:

Permit No. : 0762-AOP-R16

IS ISSUED TO:

Albemarle Corporation
Highway 79, approximately 6 Miles South of Magnolia
Magnolia, AR 71753
Columbia County
AFIN: 14-00028

THIS PERMIT AUTHORIZES THE ABOVE REFERENCED PERMITTEE TO INSTALL, OPERATE, AND MAINTAIN THE EQUIPMENT AND EMISSION UNITS DESCRIBED IN THE PERMIT APPLICATION AND ON THE FOLLOWING PAGES. THIS PERMIT IS VALID BETWEEN:

June 30, 2005 AND June 29, 2010

THE PERMITTEE IS SUBJECT TO ALL LIMITS AND CONDITIONS CONTAINED HEREIN.

Signed:

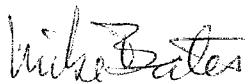

Mike Bates
Chief, Air Division

September 25, 2009

Date

Table of Contents

SECTION I: FACILITY INFORMATION 4

SECTION II: INTRODUCTION 5

Summary of Permit Activity 5

Process Description 5

Regulations 5

Emission Summary 7

SECTION III: PERMIT HISTORY 21

SECTION IV: SPECIFIC CONDITIONS 33

 Bromine (Br₂) Production 33

 Sulfur Production 36

 Clear Completion Fluids 39

 Diethylchlorothiophosphate (DECTP) Production 43

 Alkyl Amines Process 48

 Alkyl Bromides Process 53

 NC-12 Flame Retardant Process 55

 NC-14 Flame Retardant Production 58

 NC-15 Flame Retardant Process 61

 NC-17 Flame Retardant Process 64

 Boilers 70

 NC-21 Flame Retardant Process 72

 NC-22 Production 74

 NC-23 Production 77

 Brine Management Process 81

 Di-(methyl-thio)-toluene-diamine (DMTDA) 84

 Maintenance and Support Facilities 86

 95ND141/Stabrom 909 Production at NC-14 92

 Alternate Control Device for SN-BR-12 93

 Generator Usage 94

 NaBr Production in NC-14 Reactor 95

 EtBr at NC-14 96

 Oil Separator Tank – T-292 98

 HCl Loading Operation Scenarios 99

 NC-24 Production 101

 Vent Gas Incinerator (SN-21-01) and Vent Gas Oxidizer (SN-16-18) Testing Scenario 104

 NC-15 Area Scrubber (SN-15-12) Testing Scenario 106

 Methyl Bromide Production at NC-23 107

SECTION V: COMPLIANCE PLAN AND SCHEDULE 131

SECTION VI: PLANTWIDE CONDITIONS 132

 Acid Rain (Title IV) 136

 Title VI Provisions 136

 Permit Shield 137

SECTION VII: INSIGNIFICANT ACTIVITIES 140

SECTION VIII: GENERAL PROVISIONS 145

Albemarle Corporation
Permit #: 0762-AOP-R16
AFIN: 14-00028

List of Acronyms and Abbreviations

A.C.A.	Arkansas Code Annotated
AFIN	ADEQ Facility Identification Number
CFR	Code of Federal Regulations
CO	Carbon Monoxide
HAP	Hazardous Air Pollutant
lb/hr	Pound Per Hour
MVAC	Motor Vehicle Air Conditioner
No.	Number
NO _x	Nitrogen Oxide
PM	Particulate Matter
PM ₁₀	Particulate Matter Smaller Than Ten Microns
SNAP	Significant New Alternatives Program (SNAP)
SO ₂	Sulfur Dioxide
SSM	Startup, Shutdown, and Malfunction Plan
Tpy	Tons Per Year
UTM	Universal Transverse Mercator
VOC	Volatile Organic Compound

Albemarle Corporation
Permit #: 0762-AOP-R16
AFIN: 14-00028

SECTION I: FACILITY INFORMATION

PERMITTEE: Albemarle Corporation

AFIN: 14-00028

PERMIT NUMBER: 0762-AOP-R16

FACILITY ADDRESS: Highway 79, approximately 6 Miles South of Magnolia
Magnolia, AR 71753

MAILING ADDRESS: P.O. Box 729
Magnolia, AR 71754-0729

COUNTY: Columbia County

CONTACT NAME: Clarice Hanusz

CONTACT POSITION: Environmental Specialist

TELEPHONE NUMBER: 870-235-6291

REVIEWING ENGINEER: Charles Hurt, P.E.

UTM North South (Y): Zone 15: 3670978.66 m

UTM East West (X): Zone 15: 479859.65 m

Albemarle Corporation
 Permit #: 0762-AOP-R16
 AFIN: 14-00028

SECTION II: INTRODUCTION

Summary of Permit Activity

Albemarle Corporation – South Plant (AFIN: 14-00028) owns and operates a chemical manufacturing facility (P.O. Box 729) on Highway 79, approximately seven miles south of Magnolia, Arkansas 71753. Albemarle requested permission to modify the NC-23 production unit in order to produce Methyl Bromide. Albemarle also requested the NC-14 Methyl Bromide production scenario be removed. The increase in emissions due to the modification is 21.01 tpy VOC, 0.10 tpy sulfuric acid, 0.02 tpy ethylene glycol, 9.83 tpy methanol, and 8.25 tpy methyl bromide.

Process Description

Bromine-containing brine is extracted from geological formations via wells, and is pumped to a treatment area where the bromine is separated through chlorination, steam stripping, and condensation. The sour gas from the brine is treated in a sulfur-removal process, and is then either used for boiler fuel or flared.

Once the bromine has been isolated from the brine, it may be routed to one or more chemical processing units, where it is used in the manufacture of several different products: bromine chloride, ethylene dibromide, calcium bromide, zinc bromide, hydrogen bromide, alkyl amines, alkyl bromides, flame retardant materials, and other bromine-related by-products.

Regulations

The following table contains the regulations applicable to this permit.

Regulations		
<i>Arkansas Air Pollution Control Code, Regulation 18, effective January 25, 2009</i>		
<i>Regulations of the Arkansas Plan of Implementation for Air Pollution Control, Regulation 19, effective July 18, 2009</i>		
<i>Regulations of the Arkansas Operating Air Permit Program, Regulation 26, effective January 25, 2009</i>		
All sources or units subject to a 40 CFR Part 64 standard	40 CFR Part 63, Subpart A	National Emission Standards for Hazardous Air Pollutants for Source Categories, General Provisions
AB-15	40 CFR Part 63, Subpart F	National Emission Standards for Hazardous Air Pollutants from the Synthetic Organic Chemical Manufacturing Industry

Albemarle Corporation
 Permit #: 0762-AOP-R16
 AFIN: 14-00028

Regulations		
AB-15	40 CFR Part 63, Subpart G	National Emission Standards for Hazardous Air Pollutants from the Synthetic Organic Chemical Manufacturing Industry for Process Vents, Storage Vessels, Transfer Operations, and Wastewater
AB-15	40 CFR Part 63, Subpart H	National Emission Standards for Organic Hazardous Air Pollutants for Equipment Leaks
TB-29	40 CFR Part 60, Subpart VV	Standards of Performance for Equipment Leaks of VOC in the Synthetic Organic Chemicals Manufacturing Industry
TB-03 TB-11 TB-17 TB-25 TB-29 TB-30 TB-31 TB-32 TB-34 TB-35 WW-01	40 CFR Part 63, Subpart F 40 CFR Part 63, Subpart G 40 CFR Part 63, Subpart H	National Emission Standards for Hazardous Air Pollutants from the Synthetic Organic Chemical Manufacturing Industry National Emission Standards for Hazardous Air Pollutants from the Synthetic Organic Chemical Manufacturing Industry for Process Vents, Storage Vessels, Transfer Operations, and Wastewater National Emission Standards for Organic Hazardous Air Pollutants for Equipment Leaks
NC-14 Process	40 CFR Part 82, Subpart A	Protection of Stratospheric Ozone, Production and Consumption Controls
NC-14 Process	40 CFR Part 82, Subpart E	Protection of Stratospheric Ozone, The Labeling of Products Using Ozone-Depleting Substances
NC-17 CMPU	40 CFR Part 63, Subpart F	National Emission Standards for Hazardous Air Pollutants from the Synthetic Organic Chemical Manufacturing Industry
NC-17 CMPU	40 CFR Part 63, Subpart G	National Emission Standards for Hazardous Air Pollutants from the Synthetic Organic Chemical Manufacturing Industry for Process Vents, Storage Vessels, Transfer Operations, and Wastewater
NC-17 CMPU	40 CFR Part 63, Subpart H	National Emission Standards for Organic Hazardous Air Pollutants for Equipment Leaks
21-01 21-02	40 CFR Part 61, Subpart A	National Emission Standards for Hazardous Air Pollutants, General Provisions
21-01 21-02	40 CFR Part 61, Subpart J	National Emission Standards for Equipment Leaks (Fugitive Emission Sources) of Benzene
21-01 21-02	40 CFR Part 61, Subpart V	National Emission Standards for Equipment Leaks (Fugitive Emission Sources)

Albemarle Corporation
 Permit #: 0762-AOP-R16
 AFIN: 14-00028

Regulations		
21-01 21-02	40 CFR Part 61, Subpart Y	National Emission Standards for Benzene Emissions from Benzene Storage Vessels
21-01 21-02	40 CFR Part 61, Subpart FF	National Emission Standards for Benzene Waste Operations
MS-05	40 CFR Part 63, Subpart JJ	National Emission Standards for Wood Furniture Manufacturing Operations
Facility	40 CFR Part 82, Subpart E	Protection of Stratospheric Ozone, The Labeling of Products Using Ozone-Depleting Substances
MCPU's: DECTP DMTDA NC-12 NC-15 NC-17 NC-21 NC-23	40 CFR Part 63, Subpart FFFF	National Emission Standards for Hazardous Air Pollutants: Miscellaneous Organic Chemical Manufacturing
CB-04 All Ethylene Glycol Storage	40 CFR Part 63, Subpart EEEE	National Emission Standards for Hazardous Air Pollutants: Organic Liquids Distribution (Non-Gasoline)

Note: As of this writing, the Department has not received delegation from the Environmental Protection Agency (EPA) in order to implement the program associated with 40 CFR Part 68, Chemical Accident Prevention Provisions. However, the facility is subject to this part, and has submitted related documentation to the EPA.

Emission Summary

The following table is a summary of emissions from the facility. This table, in itself, is not an enforceable condition of the permit.

EMISSION SUMMARY				
KEY: PM ₁₀ =Particulate <10 microns. SO ₂ =Sulfur Dioxide. VOC=Volatile Organic Compounds. CO=Carbon Monoxide. NO _x =Oxides of Nitrogen. HAP=Hazardous Air Pollutant. NCAC=Non-Criteria Air Contaminant				
Source Number	Description	Pollutant	Emission Rates	
			lb/hr	tpy
Total Allowable Emissions Criteria Air Pollutants		PM ₁₀	34.01	117.83
		SO ₂	12,817.81	3,312.34
		VOC	562.71	576.56
		CO	237.92	209.24
		NO _x	179.48	471.57

Albemarle Corporation
 Permit #: 0762-AOP-R16
 AFIN: 14-00028

EMISSION SUMMARY				
KEY: PM ₁₀ =Particulate <10 microns. SO ₂ =Sulfur Dioxide. VOC=Volatile Organic Compounds. CO=Carbon Monoxide. NO _x =Oxides of Nitrogen. HAP=Hazardous Air Pollutant. NCAC=Non-Criteria Air Contaminant				
Source Number	Description	Pollutant	Emission Rates	
			lb/hr	tpy
Total Allowable Emissions Hazardous Air Pollutants (HAPs) *HAP emissions are included in VOC rates, except HCl, Cl ₂ , and (Cl ₂ +Br ₂).		Ethyl Benzene + Xylene	3.51	15.35
		1,1-Dichloroethane	0.09	0.39
		1,2-Epoxybutane	1.50	0.30
		Acetaldehyde	0.41	1.80
		Benzene	7.82	7.91
		Bromoform	2.95	4.15
		Chloroethane	3.34	2.95
		Chloroform	0.09	0.39
		Chlorine (Cl ₂)	0.78	3.42
		Cl ₂ or Halogens	3.02	13.22
		Br ₂ + Cl ₂	1.60	0.10
		Dimethyl Formamide	0.09	0.39
		Ethylene Chloride	0.20	0.88
		Ethyl Benzene	0.02	0.01
		Ethylene Dibromide	2.30	5.50
		Ethylene Dichloride	0.19	0.50
		Ethylene Glycol	1.27	5.23
		HCl	14.12	38.81
		Hexane	3.35	0.05
		Iso-Octane	0.29	0.01
		Dichloromethane	1.74	7.70
		Methanol	59.93	21.87
		Methyl Bromide	4.17	18.31
		Methyl Naphthalene	1.36	5.59
		Phenol	0.02	0.09
		Phthalic Anhydride	3.93	1.24
		Toluene Diamine	0.08	0.35
		Toluene	47.97	24.78
		Xylene	0.36	0.02
	Total Allowable Emissions: Non-Criteria Air Contaminants (NCACs, State-regulated)		PM	36.53
		Br ₂ +HBr	18.40	80.76
		Acetone	0.30	0.40
		Ammonia (NH ₃)	12.54	48.40
		Br ₂	6.02	26.76
		BrCl	0.20	0.88
		H ₂ O ₂	2.11	9.30
		H ₂ S	257.61	4.04
		H ₂ SO ₄	0.03	0.11
	HBr	3.60	11.92	
BR-01	#1 Bromine Tower Vent Scrubber C-3042	VOC	1.50	6.60
		Cl ₂	0.06	0.26
		Br ₂	0.26	1.14
BR-04	#2 Bromine Tower Vent Scrubber C-3043	VOC	3.81	16.70
		Cl ₂	0.03	0.13
		Br ₂	0.14	0.61
BR-08	Recycle HCl Storage Tank	VOC	0.28	1.21
		Benzene	0.28	1.21
		HCl	0.07	0.31

Albemarle Corporation
 Permit #: 0762-AOP-R16
 AFIN: 14-00028

EMISSION SUMMARY				
KEY: PM ₁₀ =Particulate <10 microns. SO ₂ =Sulfur Dioxide. VOC=Volatile Organic Compounds. CO=Carbon Monoxide. NO _x =Oxides of Nitrogen. HAP=Hazardous Air Pollutant. NCAC=Non-Criteria Air Contaminant				
Source Number	Description	Pollutant	Emission Rates	
			lb/hr	tpy
BR-09	Recycle HBr Storage Tank, Vent Scrubber C-3036	Br ₂	0.02	0.09
		HBr	0.02	0.09
BR-12	Bromine Area Scrubber C-3049	Cl ₂	0.10	0.44
		Br ₂	0.30	1.31
BR-14	Bromine Fugitive Emissions	VOC	0.50	2.20
		Cl ₂	0.04	0.18
		Br ₂	1.39	6.09
BR-15	Caustic Drum	Br ₂ + Cl ₂	1.60	0.10
SL-01	Gas Sweetening Process Flare	PM/PM ₁₀	0.01*	0.05
		SO ₂	0.01*	0.05
		VOC	0.01*	0.05
		CO	0.01*	0.05
		NO _x	0.02*	0.10
SL-01	Gas Sweetening Process Flare – Emergency Flaring of Brinefield Gas	PM/PM ₁₀	2.2*	0.11
		SO ₂	5.6*	0.27
		VOC	2.2*	0.11
		CO	7.8*	0.38
		NO _x	18.4*	0.89
SL-01	Gas Sweetening Process Flare – Emergency Flaring of Brinefield Gas	PM/PM ₁₀	3.70	0.02
		SO ₂	12066.00	36.00
		VOC	3.70	0.02
		CO	13.40	0.04
SL-02	Sulfinol Storage Tank	NO _x	31.40	0.10
		VOC	0.12	0.60
		PM/PM ₁₀	0.07	0.31
		SO ₂	727.00	3184.00
SR-01	Tail Gas Incinerator	VOC	0.07	0.31
		CO	0.25	1.10
		NO _x	0.60	2.60
		SO ₂	242.60	2.82
SR-01	Tail Gas Incinerator –Pilot Flame Deviation (<1200 °F)	H ₂ S	257.40	3.09
		VOC	0.50	2.20
SR-02	Sulfur Area Fugitives	Methanol	0.06	0.26
		PM/PM ₁₀	0.10	0.44
CB-02	R-21 Vent Scrubber (South)	VOC	0.27	1.18
		Ammonia	1.00	1.10
		Methyl Bromide	0.20	0.88
		Methanol	0.07	0.30
		Br ₂	0.10	0.44
CB-04	Methanol Storage Tank	VOC	26.00	0.40
		Methanol	26.00	0.40
CB-16	R-22 Vent Scrubber (North)	VOC	0.27	1.18
		Ammonia	1.00	1.10
		Methyl Bromide	0.20	0.88
		Methanol	0.07	0.30
		Br ₂	0.10	0.44

Albemarle Corporation
 Permit #: 0762-AOP-R16
 AFIN: 14-00028

EMISSION SUMMARY				
KEY: PM ₁₀ =Particulate <10 microns. SO ₂ =Sulfur Dioxide. VOC=Volatile Organic Compounds. CO=Carbon Monoxide. NO _x =Oxides of Nitrogen. HAP=Hazardous Air Pollutant. NCAC=Non-Criteria Air Contaminant				
Source Number	Description	Pollutant	Emission Rates	
			lb/hr	tpy
CB-17	CCF Fugitive Emissions	VOC	1.80	7.90
		Methanol	1.30	5.70
		Br ₂ +HBr	2.40	10.50
CB-18	Raw Material Baghouse	PM/PM ₁₀	0.10	0.44
CB-02 CB-16	R-21 and R-22 Vent Scrubbers <i>Alternate Operating Scenario</i>	VOC	9.00	22.20
		Methyl Bromide	2.30	8.30
		Methanol	2.30	0.80
		Bromoform	2.30	1.30
		Ethylene Dibromide	2.30	5.50
		HBr	0.10	0.22
DE-01	ADMA Brine Storage Tank	VOC	0.50	2.10
	<i>Additional ADMA Storage Scenario</i>			
DE-04	Crude Product Storage Tank	VOC	8.96	3.93
		Toluene	8.80	3.85
		Methyl Naphthalene	0.01	0.01
DE-06	Product Rundown Storage Tank	VOC	0.62	0.28
DE-07	Product Rundown Storage Tank	VOC	0.62	0.28
DE-08	Product Rundown Storage Tank	VOC	0.62	0.28
DE-10	Product Rundown Storage Tank	VOC	0.62	0.28
DE-11	Chaser Bulk Storage, T-302	VOC	0.39	1.71
		Methyl Naphthalene	0.12	0.53
DE-12	Recovered Oil Storage Tank	VOC	0.20	0.10
		Toluene	0.04	0.02
		Methyl Naphthalene	0.01	0.01
DE-17	Process Safety Flare Emergency Use Only XF-2461 (Continuous Pilot)	PM/PM ₁₀	0.01	0.05
		SO ₂	0.06	0.05
		VOC	0.01	0.05
		CO	0.04	0.18
		NO _x	0.05	0.22
DE-18	Reactor Safety Blowdown System Vent Line (Continuous Pilot)	PM/PM ₁₀	0.01	0.05
		SO ₂	0.01	0.05
		VOC	0.01	0.05
		CO	0.07	0.31
		NO _x	0.10	0.44
DE-19	Sulfur Trailer Knockout Drum	VOC	8.00	3.50
		Toluene	8.00	3.50
DE-20	Isopropanol Storage Tank	VOC	9.40	4.10
DE-21	Vent Gas Oxidizer (VGO)	PM/PM ₁₀	2.20	9.64
		SO ₂	7.00	30.70
		VOC	0.60*	2.63
		CO	2.00	8.76
		NO _x	1.00	4.38
		Cl ₂	0.30	1.31
		HCl	6.72	29.40
		Toluene	0.40*	1.76
Ethylene Chloride	0.20	0.88		

Albemarle Corporation
 Permit #: 0762-AOP-R16
 AFIN: 14-00028

EMISSION SUMMARY				
KEY: PM ₁₀ =Particulate <10 microns. SO ₂ =Sulfur Dioxide. VOC=Volatile Organic Compounds. CO=Carbon Monoxide. NO _x =Oxides of Nitrogen. HAP=Hazardous Air Pollutant. NCAC=Non-Criteria Air Contaminant				
Source Number	Description	Pollutant	Emission Rates	
			lb/hr	tpy
DE-22	DECTP Fugitive Emissions	VOC	9.40	41.10
		Cl ₂	0.05	0.22
		HCl	1.00	4.40
		Toluene	0.55	2.40
		Methyl Naphthalene	1.13	5.00
DE-23	DECTP Purification Process	VOC	2.83	1.24
		HCl	0.34	0.15
		Chloroethane	2.60	1.14
DE-24	MC-2431, Centrifuge	VOC	12.70	5.60
		Toluene	12.70	5.60
DE-28	Vent Header (for DE-01, 02, 03, 09, 25)	VOC	23.60	10.40
		Toluene	11.00	4.82
		Methyl Naphthalene	0.09	0.04
AD-01	Olefins Storage Tank #1, T-1501	VOC	0.16	0.71
AD-02	Olefins Storage Tank #2, T-1503	VOC	0.16	0.71
AD-03	Alkyl Amines Storage Tank, T1502	VOC	0.26	1.14
AD-05	Acid Vent Scrubber , C-1531 (CD-AD-05, also formerly SC-03)	VOC	0.20	0.88
		Br ₂ +HBr	0.05	0.22
		HCl	0.10	0.50
AD-07	Alkyl Amines Rundown Tank T-1534A	VOC	0.05	0.22
AD-08	Alkyl Amines Rundown Tank T-1534B	VOC	0.05	0.22
AD-09	Alkyl Amines Rundown Tank T-1534	VOC	0.05	0.22
AD-10	Alkyl Amines Storage Tank, T-1537	VOC	0.26	1.14
AD-11	Alkyl Amines Storage Tank, T-1537	VOC	0.26	1.14
AD-12	Alkyl Amines Storage Tank, T-1535	VOC	0.26	1.14
AD-13	Alkyl Amines Storage Tank, T-1536	VOC	0.26	1.14
AD-14	Alkyl Amines Storage Tank, T-1538	VOC	0.26	1.14
AD-15	Alkyl Amines Storage Tank, T-1539	VOC	0.26	1.14
AD-17	Alkyl Amines Blend Tank, T-1540	VOC	0.26	1.14
AD-18	Sodium Bromide Brine for Recycle, T-1409	VOC	0.26	1.14
AD-20	Olefins Storage Tank, T-1405A	VOC	0.16	0.71
AD-21	Olefins Storage Tank, T-1405B	VOC	3.45	15.08
AD-23	Alkyl Amines Storage Tanks T-1408A, B	VOC	0.03	0.14
AD-24	Product Storage: Alkyl Amines T-1542	VOC	0.26	1.14
AD-25	Product Storage: Alkyl Amines T-1542	VOC	0.26	1.14
AD-26	ADMA Flare <i>Alkyl Amines Scenario Emergency Flaring Events</i>	PM/PM ₁₀	0.12	0.07
		SO ₂	0.06	0.15
		VOC	0.62	0.16
		CO	0.06	0.15
		NO _x	0.38	0.20
		Br ₂	0.02	0.01

Albemarle Corporation
 Permit #: 0762-AOP-R16
 AFIN: 14-00028

EMISSION SUMMARY				
KEY: PM ₁₀ =Particulate <10 microns. SO ₂ =Sulfur Dioxide. VOC=Volatile Organic Compounds. CO=Carbon Monoxide. NO _x =Oxides of Nitrogen. HAP=Hazardous Air Pollutant. NCAC=Non-Criteria Air Contaminant				
Source Number	Description	Pollutant	Emission Rates	
			lb/hr	tpy
AD-26	ADMA Flare <i>Alkyl Amines Scenario Non-Emergency Events</i>	PM/PM ₁₀	0.80	0.10
		SO ₂	0.10	0.10
		VOC	48.50	0.60
		CO	18.90	0.30
		NO _x	3.50	0.10
AD-26	ADMA Flare <i>NC-24 Production Scenario</i>	PM/PM ₁₀	0.80	0.10
		SO ₂	0.10	0.10
		VOC	48.50	0.60
		CO	18.90	0.30
		NO _x	3.50	0.10
AD-27	Recycle Brine Storage Tank, T-1407	VOC	0.26	1.14
AD-28	Stripped Recycle Brine Tank, T-1541	VOC	0.08	0.35
AD-29	Stripped Recycle Brine Tank, T-1544	VOC	0.08	0.35
AD-35	Alkyl Amines Odor Control Vent Gas Oxidizer (VGO)	PM/PM ₁₀	0.22	0.97
		SO ₂	0.09	0.40
		VOC	1.22	5.35
		CO	0.06	0.27
		NO _x	0.70	3.07
		Br ₂	0.03	0.14
AD-36	Fugitive Emissions Including Product Loading	VOC	4.13	18.14
		Br ₂ +HBr	3.76	16.47
		Ethylene Glycol	0.06	0.30
AD-37	ADMA Condensate Collection Tank	VOC	0.05	0.17
AD-39	ADMA Brine Loadout <i>Additional ADMA Storage Scenario</i>	VOC	0.10	0.40
AD-40	Mixed ADMA Final Product Storage Tank, T-9965	VOC	0.26	1.14
AD-41	Mixed ADMA Final Product Storage Tanks, T-1408A and T-1408B	VOC	0.52	2.28
AB-15	Carbon Bed Adsorbers (CB-304 and CB-305)	VOC	1.20	5.30
		Dichloromethane	0.24	1.10
AB-16	Alkyl Bromide Fugitive Emissions	VOC	7.50	32.90
		Dichloromethane	1.50	6.60
DB-01	Vent Scrubber	VOC	0.28	1.23
		Br ₂ +HBr	0.44	1.93
DB-04	Product Dryer Filter	PM/PM ₁₀	1.80	7.90
		SO ₂	0.14	0.61
		VOC	0.96	4.20
		CO	3.60	15.80
		NO _x	1.60	7.00
		Br ₂ +HBr	1.65	7.20
DB-05	Product Vent Filter Silo Baghouse	PM/PM ₁₀	0.30	1.30
DB-06	Product Vent Filter Silo Baghouse	PM/PM ₁₀	0.30	1.30
DB-07	Raw Material Storage Tank	VOC	0.10	0.44
		HCl	5.10	0.50
DB-08	Product Vent Filter	PM/PM ₁₀	1.10	4.80

Albemarle Corporation
 Permit #: 0762-AOP-R16
 AFIN: 14-00028

EMISSION SUMMARY				
KEY: PM ₁₀ =Particulate <10 microns. SO ₂ =Sulfur Dioxide. VOC=Volatile Organic Compounds. CO=Carbon Monoxide. NO _x =Oxides of Nitrogen. HAP=Hazardous Air Pollutant. NCAC=Non-Criteria Air Contaminant				
Source Number	Description	Pollutant	Emission Rates	
			lb/hr	tpy
DB-10	Ethylene Glycol Storage Tank	VOC	0.01	0.04
		Ethylene Glycol	0.01	0.04
DB-16	NC-12 Fugitive Emissions	VOC	1.40	6.10
		Br ₂ +HBr	5.81	25.44
DB-17	Back-up Water Scrubber	Br ₂ +HBr	0.10	0.44
DB-18	Receiving Baghouse	PM/PM ₁₀	0.30	1.40
DB-19	Product Dryer Scrubber	PM/PM ₁₀	0.98	4.30
		SO ₂	0.14	0.61
		VOC	0.96	4.20
		CO	3.60	15.80
		NO _x	1.60	7.00
		Br ₂ +HBr	1.00	4.38
DB-20	DPE Storage Tank, D-2515 <i>During NC-15 Production Alt. Op Scenario</i>	VOC	0.32	1.41
DB-22	NC-12 Central Vacuum System	PM/PM ₁₀	0.10	0.20
TB-03	Area Process Scrubber <i>NaBr Production</i>	Br ₂ +HBr	0.10	0.44
TB-03	Area Process Scrubber (Ethyl Bromide Recovery Unit) <i>EtBr Production</i>	VOC	10.70	7.50
TB-04	NC-22 Product Baghouse <i>NC-22 Production Scenario A</i>	PM	0.90	4.00
		PM ₁₀	0.90	4.00
		VOC	0.21	0.92
		HBr	2.00	6.16
TB-08	Dust Collector <i>NC-22 Production Scenarios A and B</i>	PM	0.30	1.40
		PM ₁₀	0.30	1.40
TB-11	ADMA Brine Storage Tank <i>Additional ADMA Storage Scenario</i>	VOC	0.10	0.40
TB-12	Spent Sulfuric Acid Storage <i>EtBr Production Scenario</i>	VOC	0.53	0.38
		H ₂ SO ₄	0.01	0.01
TB-14	Caustic Scrubber <i>95ND141/Stabrom 909 Production Scenario</i>	Br ₂	0.10	0.44
		BrCl	0.10	0.44
		Cl ₂	0.10	0.44
TB-14	Bromine Scrubber <i>NC-22 Production Scenarios A and B</i>	Br ₂	0.10	0.44
TB-25	Refrigerated Vent Condenser <i>NC-23 MeBr Production Scenario</i>	VOC	0.45	2.00
		Methanol	0.45	2.00
TB-25	Refrigerated Vent Condenser <i>NC-24 Production Scenario</i>	VOC	47.70	5.80
		HBr	0.10	0.10
		Acetone	0.10	0.10
		HCl	0.10	0.10
		1,2-Epoxybutane	1.30	0.10
TB-29	NC-22 Fugitive Emissions <i>95ND141/Stabrom 909 Production Scenario</i>	Br ₂	0.10	0.44
		BrCl	0.10	0.44
		Cl ₂	0.10	0.44

Albemarle Corporation
 Permit #: 0762-AOP-R16
 AFIN: 14-00028

EMISSION SUMMARY				
KEY: PM ₁₀ =Particulate <10 microns. SO ₂ =Sulfur Dioxide. VOC=Volatile Organic Compounds. CO=Carbon Monoxide. NO _x =Oxides of Nitrogen. HAP=Hazardous Air Pollutant. NCAC=Non-Criteria Air Contaminant				
Source Number	Description	Pollutant	Emission Rates	
			lb/hr	tpy
TB-29	NC-14 Fugitive Emissions <i>EtBr Production Scenario</i>	VOC	3.47	2.40
		Br ₂ +HBr	0.46	0.32
TB-29	NC-22 Fugitive Emissions <i>NC-22 Production A Scenario</i>	VOC	1.33	5.76
		Ethylene Glycol	0.08	0.34
		Br ₂ +HBr	0.44	1.92
TB-29	NC-22 Fugitive Emissions <i>NC-22 Production B Scenario</i>	HCl	0.06	0.24
		VOC	1.37	5.90
		Ethylene Glycol	0.08	0.34
TB-29	NC-22 Fugitive Emissions <i>NC-22 Production B Scenario</i>	Br ₂ +HBr	0.44	1.92
		HCl	0.06	0.24
		VOC	1.37	5.90
TB-30	Fresh Sulfuric Acid Storage Tank <i>NC-23 MeBr Production Scenario</i>	H ₂ SO ₄	0.01	0.05
TB-30	Methanol Storage Tank <i>EtBr Production Scenario</i>	VOC	11.30	6.30
TB-37	Raw Material Recovery <i>EtBr Production Scenario</i>	VOC	1.34	0.94
		HBr	0.10	0.10
TB-41	(2) Carbon Bed Solvent Recovery Units <i>NC-22 Production Scenario A</i>	VOC	6.40	8.30
		HCl	0.07	0.10
		HBr	0.02	0.02
TB-41	(2) Carbon Bed Solvent Recovery Units <i>NC-22 Production Scenario B</i>	VOC	9.70	12.80
		HCl	0.07	0.15
		HBr	0.04	0.05
TB-42	HBr Solution Storage Tank <i>NC-22 Production Scenarios A and B</i>	HBr	0.25	0.40
TB-43	Centrate Holdup Drum	VOC	0.63	1.10
TB-01	ADMA Storage Tank	VOC	7.20	7.20
TB-04	Product Baghouse	Reserved for future use	--	--
TB-08	Dust Collector Baghouse	Reserved for future use	--	--
TB-15	Water Tank	Reserved for future use	--	--
TB-18	Column Bottoms Tank	Reserved for future use	--	--
TB-22	BPA Storage Silo	Reserved for future use	--	--
TB-23	BPA Weigh Hopper Baghouse	Reserved for future use	--	--
TB-28	Hydrochloric Acid Scrubber	Reserved for future use	--	--
15-02	Process Scrubber	Br ₂	0.10	0.44
		HBr	0.10	0.44
15-09	Refrigerated Coolant Storage	VOC	0.03	0.13
		Ethylene Glycol	0.03	0.13
15-12	NC-15 Area Scrubber	PM/PM ₁₀	2.17	9.51
		SO ₂	0.01	0.05
		VOC	2.20	9.64
		CO	0.15	0.66
		NO _x	0.18	0.79
15-13	Raw Material Storage Tanks D-9965, D-9966	Br ₂ +HBr	1.09	4.78
		VOC	0.07	0.31

Albemarle Corporation
 Permit #: 0762-AOP-R16
 AFIN: 14-00028

EMISSION SUMMARY				
KEY: PM ₁₀ =Particulate <10 microns. SO ₂ =Sulfur Dioxide. VOC=Volatile Organic Compounds. CO=Carbon Monoxide. NO _x =Oxides of Nitrogen. HAP=Hazardous Air Pollutant. NCAC=Non-Criteria Air Contaminant				
Source Number	Description	Pollutant	Emission Rates	
			lb/hr	tpy
15-15	Fugitive Emissions	PM/PM ₁₀	0.03	0.13
		VOC	4.23	18.30
		Br ₂ +HBr	1.54	6.72
15-16	Pollution Control Dust Scrubber J-99601 CD-15-16	PM/PM ₁₀	1.20	5.30
15-17	Rail Car Vent	VOC	0.69	3.03
15-18	DPE Byproduct/Heavy Organics Storage Tank (serving NC-21)	VOC	0.10	0.10
15-19	NC-15 Central Vacuum System	PM/PM ₁₀	0.1	0.2
16-01	TBPA Production Packed Scrubber	SO ₂	0.50	2.19
		PM/PM ₁₀	0.10	0.44
		Phthalic Anhydride	0.10	0.44
16-02	TBPA Production Off Gas Scrubber	SO ₂	0.40	1.75
		VOC	0.10	0.44
		Br ₂	0.10	0.44
16-05	EBTBP Production Packed Scrubber	VOC	0.10	0.44
16-06	EBTBP Production Converter Scrubber	VOC	0.10	0.44
		PM/PM ₁₀	0.40	1.75
16-07	EBTBP Production In Process Storage Silo Vent Filter	PM/PM ₁₀	0.30	1.32
16-08	EBTBP Production Product Transfer and Storage Fabric Filter	PM/PM ₁₀	0.30	1.32
16-10	Product Transfer and Storage Fabric Filter	PM/PM ₁₀	0.50	2.19
		SO ₂	0.10	0.44
16-11	TBPA Production Packaging Filter	PM/PM ₁₀	0.10	0.44
16-12	TBPA Weigh Hopper Filter	PM/PM ₁₀	0.10	0.44
16-13	TBPA Production Vacuum Pump	SO ₂	0.10	0.44
16-14	Ethylene Diamine Storage Tank	VOC	0.01	0.04
16-15	Propanoic Acid Storage Tank	VOC	0.01	0.04
16-16	TBPA Neutralization Tank	SO ₂	0.10	0.44
16-17	Ethylene Glycol Tank	VOC	0.02	0.09
		Ethylene Glycol	0.02	0.09
16-18	Vent Gas Oxidizer	PM/PM ₁₀	0.05	0.22
		SO ₂	0.07	0.31
		NO _x	0.64	2.80
		CO	0.86	3.77
		VOC	0.66	2.89
		Ethyl Benzene + Xylene	0.52	2.28
16-19	Charge Hopper Vent	PM/PM ₁₀	0.30	1.32
		SO ₂	0.10	0.44

Albemarle Corporation
 Permit #: 0762-AOP-R16
 AFIN: 14-00028

EMISSION SUMMARY				
KEY: PM ₁₀ =Particulate <10 microns. SO ₂ =Sulfur Dioxide. VOC=Volatile Organic Compounds. CO=Carbon Monoxide. NO _x =Oxides of Nitrogen. HAP=Hazardous Air Pollutant. NCAC=Non-Criteria Air Contaminant				
Source Number	Description	Pollutant	Emission Rates	
			lb/hr	tpy
16-20	Heat Exchange Heater	PM/PM ₁₀	0.04	0.18
		SO ₂	0.06	0.27
		NO _x	0.50	2.18
		CO	0.19	0.83
		VOC	0.13	0.57
16-21	Product Storage Hopper	PM/PM ₁₀	0.20	0.88
		VOC	0.40	1.76
		Ethyl Benzene + Xylene	0.28	1.23
16-22	By-Product Powder Packaging	PM/PM ₁₀	0.01	0.04
		VOC	0.01	0.04
		Ethyl Benzene + Xylene	0.01	0.04
16-23	NC-17 Operation Fugitive Emissions	PM/PM ₁₀	0.32	1.40
		SO ₂	1.02	4.47
		VOC	6.60	28.53
		Ethyl Benzene + Xylene	2.70	11.80
		Ethylene Glycol	0.41	1.80
		Br ₂	0.34	1.49
16-24	Raw Material Unloading, Brinks (Limited Hours of Operation)	SO ₂	1.80	1.58
16-25	Wet Scrubber	PM/PM ₁₀	0.40	1.75
		VOC	1.02	3.46
16-26	EBTBP or TBBPA Rework Transfer and Storage Filter	PM/PM ₁₀	0.30	1.32
16-27	Reactor Weight Hopper Filter	PM/PM ₁₀	0.30	1.32
16-28	TBPA Neutralization Tank	SO ₂	0.10	0.44
16-31	Molten Phthalic Anhydride Storage Tank	VOC	3.83	0.80
		Phthalic Anhydride	3.83	0.80
BH-01	#1 Boiler 340 MMBTU/hr Natural Gas Fired	PM	3.40	--
		PM ₁₀	2.59	--
		SO ₂	--	--
		VOC	1.87	--
		CO	13.60	--
		NO _x	47.60	--
BH-02	#2 Boiler 340 MMBTU/hr Natural Gas Fired	PM	3.40	--
		PM ₁₀	2.59	--
		SO ₂	--	--
		VOC	1.87	--
		CO	13.60	--
		NO _x	47.60	--
BH-01 And BH-02	Combined Boiler Emissions	PM	--	29.78
		PM ₁₀	--	22.64
		SO ₂	5.60	24.60
		VOC	--	16.38
		CO	--	119.20
		NO _x	--	417.00

Albemarle Corporation
 Permit #: 0762-AOP-R16
 AFIN: 14-00028

EMISSION SUMMARY				
KEY: PM ₁₀ =Particulate <10 microns. SO ₂ =Sulfur Dioxide. VOC=Volatile Organic Compounds. CO=Carbon Monoxide. NO _x =Oxides of Nitrogen. HAP=Hazardous Air Pollutant. NCAC=Non-Criteria Air Contaminant				
Source Number	Description	Pollutant	Emission Rates	
			lb/hr	tpy
21-01	Emission Control Vent Gas Incinerator (FL-3671)(CD-21-01)	PM/PM ₁₀	0.10	0.44
		SO ₂	0.01	0.04
		VOC	1.71	2.50
		CO	5.00	21.90
		NO _x	0.50	2.20
		Benzene	1.71	2.50
		HCl	0.35	1.54
		Ethylene Dichloride	0.10	0.10
21-02	NC-21 Fugitive Emissions	VOC	3.71	16.22
		Benzene	0.90	3.94
		HCl	0.05	0.22
		Ethylene Dichloride	0.09	0.40
21-03	Waste Water Effluent	VOC	0.01	0.01
		Benzene	0.01	0.01
21-04	HCl Loading Operation	VOC	0.80	0.20
		Benzene	0.80	0.20
		HCl	0.30	0.10
23-01	NC-23 Fugitive Emissions	VOC	1.12	4.91
		Br ₂	0.22	0.97
		HBr	0.11	0.49
		Chloroethane	0.03	0.13
23-01	NC-23 Fugitive Emissions <i>MeBr Production Scenario</i>	VOC	2.33	10.21
		Methanol	0.97	4.25
		Methyl Bromide	0.97	4.25
23-02	Raw Material Unloading Baghouse (VOC,HBr, Acetaldehyde, Chloroethane emissions limits are for all NC-23 baghouses)	PM	0.20	0.88
		PM ₁₀	0.10	0.44
		VOC	3.80	16.60
		HBr	0.23	0.97
		Acetaldehyde	0.10	0.44
		Chloroethane	0.20	0.88
23-03	Raw Material Scrubber	VOC	0.35	1.53
		HBr	0.35	1.50
		Chloroethane	0.02	0.09
23-03	Raw Material Scrubber <i>MeBr Production Scenario</i>	VOC	27.37	1.68
		Methanol	27.37	1.68
23-04	By- Product Loading	VOC	0.44	1.93
23-05	Vent Absorber	VOC	2.90	12.70
		Phenol	0.02	0.09
		Bromoform	0.12	0.53
		Acetaldehyde	0.03	0.13
		Chloroethane	0.49	0.71
		VOC	1.60	7.00
23-05	Vent Absorber <i>MeBr Production Scenario</i>	Methanol	0.40	1.80
		Methyl Bromide	0.90	4.00
23-06	Receiving Silo Baghouse	PM	0.60	2.64
23-07	Blending Silo Baghouse	PM ₁₀	0.30	1.32
23-08	Discharging Silo Baghouse	VOC	3.8*	16.60*

Albemarle Corporation
 Permit #: 0762-AOP-R16
 AFIN: 14-00028

EMISSION SUMMARY				
KEY: PM ₁₀ =Particulate <10 microns. SO ₂ =Sulfur Dioxide. VOC=Volatile Organic Compounds. CO=Carbon Monoxide. NO _x =Oxides of Nitrogen. HAP=Hazardous Air Pollutant. NCAC=Non-Criteria Air Contaminant				
Source Number	Description	Pollutant	Emission Rates	
			lb/hr	tpy
23-09	Product Packaging Baghouse	PM	0.20	0.88
		PM ₁₀	0.10	0.44
		VOC	3.80*	16.60*
23-10	Product Dust Collection	PM	0.20	0.88
		PM ₁₀	0.10	0.44
		VOC	3.80*	16.60*
23-11A	Product Loading Baghouse	PM	0.20	0.88
23-11B	Product Loading Railcar	PM ₁₀	0.10	0.44
		VOC	3.80*	16.60*
23-12A	Product Loading Baghouse	PM	0.20	0.88
23-12B	Product Loading Railcar	PM ₁₀	0.10	0.44
		VOC	3.80*	16.60*
23-13	Floor Vacuum Baghouse	PM	0.20	0.88
		PM ₁₀	0.10	0.44
		VOC	3.80*	16.60*
23-16	Spent Sulfuric Acid Storage	VOC	0.10	0.10
		Methanol	0.10	0.10
		H ₂ SO ₄	0.01	0.05
23-17	Refrigerant Water Storage Tank	VOC	0.01	0.01
		Ethylene Glycol	0.01	0.01
23-18	Refrigerant Water Storage Tank	VOC	0.01	0.01
		Ethylene Glycol	0.01	0.01
23-15	Phenol Storage Tank 6,500 gal	Emissions Routed to 23-05	--	--
BT-01	Feed Brine Oil Separator/Surge Tank V-3011	VOC	0.01	0.05
		H ₂ S	0.14	0.61
BT-11	Neutralization Tank T-3110	VOC	0.01	0.05
		H ₂ S	0.01	0.05
		NH ₃	0.20	0.90
		Cl ₂ or Halogens	0.03	0.13
BT-12	Tail Brine Line Vent	VOC	0.01	0.05
		NH ₃	0.01	0.05
		Cl ₂ or Halogens	0.01	0.05
BT-13	Tail Brine Tank T-3101	VOC	0.01	0.05
		H ₂ S	0.01	0.05
		NH ₃	0.02	0.09
		Cl ₂ or Halogens	0.01	0.05
BT-16	Brinefield Oil/Water Separator T-7001	VOC	30.00	1.80
		H ₂ S	0.01	0.05
BT-17	Brinefield Oil Storage Tank T-7002	VOC	16.40	1.70
		H ₂ S	0.01	0.05
BT-21	Four Tail Brine Cooling Towers Y-3120, Y-3121, Y-3122, Y-3123	PM/PM ₁₀	4.12	18.09
		VOC	3.37	14.72
		NH ₃	10.23	44.77
		Cl ₂ or Halogens	2.89	12.60

Albemarle Corporation
 Permit #: 0762-AOP-R16
 AFIN: 14-00028

EMISSION SUMMARY				
KEY: PM ₁₀ =Particulate <10 microns. SO ₂ =Sulfur Dioxide. VOC=Volatile Organic Compounds. CO=Carbon Monoxide. NO _x =Oxides of Nitrogen. HAP=Hazardous Air Pollutant. NCAC=Non-Criteria Air Contaminant				
Source Number	Description	Pollutant	Emission Rates	
			lb/hr	tpy
BT-22	Brine Management, Fugitive Emissions Including Ground Brine Ponds	VOC	0.02	0.09
		H ₂ S	0.02	0.09
		NH ₃	0.02	0.09
		Cl ₂ or Halogens	0.02	0.09
BT-23	Line Vent	VOC	0.01	0.05
		NH ₃	0.01	0.05
		Cl ₂ or Halogens	0.01	0.05
BT-24	Line Vent	VOC	0.01	0.05
		NH ₃	0.01	0.05
		Cl ₂ or Halogens	0.01	0.05
BT-25	DRT Tail Brine Line Vent	VOC	0.01	0.05
		NH ₃	0.01	0.05
		Cl ₂ or Halogens	0.01	0.05
BT-26	DRT Tail Brine Line Vent	VOC	0.01	0.05
		NH ₃	0.01	0.05
		Cl ₂ or Halogens	0.01	0.05
BT-27	Tail Brine Line Vent	VOC	0.01	0.05
		NH ₃	0.01	0.05
		Cl ₂ or Halogens	0.01	0.05
BT-28	Tail Brine Line Vent	VOC	0.01	0.05
		NH ₃	0.01	0.05
		Cl ₂ or Halogens	0.01	0.05
BT-29	Oil Separator Tank T-292	VOC	30.00	1.95
		H ₂ S	0.01	0.05
		Benzene	3.87	0.04
		Toluene	1.34	0.02
		Xylene	0.28	0.01
		Hexane	3.12	0.04
DM-01	Ethylene Glycol Tank	VOC	0.03	0.11
		Ethylene Glycol	0.03	0.11
DM-02	Thermal Oxidizer	PM/PM ₁₀	0.20	0.88
		SO ₂	4.00	17.50
		VOC	0.10	0.44
		CO	0.10	0.44
		NO _x	0.31	1.40
DM-03	Hydrogen Peroxide Tank 1	H ₂ O ₂	0.81	3.55
DM-06	Hydrogen Peroxide Tank 2	H ₂ O ₂	0.81	3.55
DM-07	Fugitive Emissions	VOC	3.18	13.95
		Toluene Diamine	0.08	0.35
		Dimethyl Formamide	0.09	0.39
		Ethylene Glycol	0.41	1.80
		H ₂ O ₂	0.49	2.20

Albemarle Corporation
 Permit #: 0762-AOP-R16
 AFIN: 14-00028

EMISSION SUMMARY				
KEY: PM ₁₀ =Particulate <10 microns. SO ₂ =Sulfur Dioxide. VOC=Volatile Organic Compounds. CO=Carbon Monoxide. NO _x =Oxides of Nitrogen. HAP=Hazardous Air Pollutant. NCAC=Non-Criteria Air Contaminant				
Source Number	Description	Pollutant	Emission Rates	
			lb/hr	tpy
MS-01	Extraneous Water System	VOC	4.00	17.60
		Bromoform	0.53	2.32
		Chloroform	0.09	0.39
		1,1-Dichloroethane	0.09	0.39
		Toluene	0.25	1.10
		Acetaldehyde	0.28	1.23
		Methanol	0.98	4.28
MS-02	Drying Bed	VOC	0.10	0.44
MS-03	French Drain Sump Bubble	VOC	0.30	1.32
		Br ₂	2.70	11.83
MS-05	Carpenter's Shop Fugitive Emissions	VOC	0.67	2.20
MS-06	South Landfill	SO ₂	0.50	0.17
		VOC	7.00	2.40
		Toluene	5.00	1.70
MS-07	Gasoline Storage Tank	VOC	47.70	1.00
		Benzene	0.25	0.01
		Hexane	0.23	0.01
		Toluene	0.29	0.01
		Xylene	0.08	0.01
		Ethyl Benzene	0.02	0.01
		Iso-octane	0.29	0.01
MS-08	Electric Generators	PM/PM ₁₀	3.00	1.40
		SO ₂	2.80	1.30
		VOC	8.10	13.20
		CO	162.50	19.00
		NO _x	41.60	19.00
MS-12	Plantwide Fugitive Refrigerant Emissions	VOC	1.06	4.64
24-01	Wash Column (Primary Operating Scenario)	VOC	48.50	17.70
		HBr	0.10	0.50
		Acetone	0.10	0.10
		HCl	0.10	0.50
		1,2-Epoxybutane	0.10	0.10
24-01	Wash Column (Alternate Scenario)	VOC	48.50*	0.60
		HBr	0.10	0.50
		Acetone	0.10	0.10
		HCl	0.10	0.50
24-02	NC-24 Fugitives	VOC	1.20	5.10
		HBr	0.10	0.40
		Acetone	0.10	0.10
		HCl	0.10	0.20
		Ethylene Glycol	0.20	0.60
		1,2-Epoxybutane	0.10	0.10

Albemarle Corporation
 Permit #: 0762-AOP-R16
 AFIN: 14-00028

SECTION III: PERMIT HISTORY

The following timetable summarizes the Department's permitting actions related to this facility from 1973 until it received its initial Title V permit.

Date	Permit Number	Purpose (summary)
3/10/00	762-AOP-R0	First operating air permit; incorporated limits and provisions for all minor modifications initiated by the facility from 1992 through August, 1999
06/28/73	164-A	Issued for Sulfinol Gas Sweetening unit.
12/04/74	273-A	Issued for Tail Gas Incinerator.
03/26/76	324-A	Issued for CBN production.
09/24/76	363-A	Issued for NC-9 Alkyl Amine Production plant.
09/23/77	424-A	Issued for production of Pyrochek (MG-3).
09/23/77	425-A	Issued for DECTP plant.
11/22/78	273-AR-1	Modification issued for addition of MDEA unit.
03/23/79	425-AR-1	Modification issued for production of DMCTP.
05/30/79	552-A	Issued for Calcium and Zinc Bromide production.
11/26/79	552-AR-1	Modification issued for Calcium Bromide.
07/24/81	353-AI	Issued for incineration of office waste.
08/11/81	708-A	Issued for NC-14 process.
04/05/82	424-AR-1	Issued for NC-12 process.
07/22/83	708-AR-1	Modification issued for Sodium Bromide production.
02/08/84	728-A	Issued for Bromine Chloride production.
02/23/86	762-A	Issued to Ethyl as the original consolidated air permit for the site.
05/26/87	832-A	Issued for NC-16 process.
09/15/87	846-A	Issued for NC-15 process.
03/17/88	762-AR-1	Modification issued for the DBDPO process.
11/01/88	762-AR-2	Modification issued for an expansion of the TBBPA (NC-14) process.
11/09/88	832-AR-1	Modification and expansion to the existing NC-16 process.
01/11/89	922-A	Issued to allow construction of the Alkyl Bromides process.
02/13/89	933-A	Issued to allow construction of the BRU. The unit later was brought under RCRA BIF regulations.
11/15/89	832-AR-2	Issued for the NC-17 process.
04/30/90	398-IR-1	Issued for the Air Curtain Incinerator.
05/10/91	922-AR-1	Modification issued for the Alkyl Bromides process. Consolidated 913-A and 922-A.
11/18/91	762-AR-3	Consolidated all existing air permits for the facility.
11/04/92	762-AR-4	Modification issued for NC-21 construction.
02/19/93	762-AR-5	Modification issued for NC-14.
09/10/93	762-AR-6	Modification issued for NC-16, and allowed construction of NC-17, NC-18.
12/08/93	762-AR-7	Issued to allow Feed Brine Tank construction.
04/08/94	762-AR-8	Issued to allow DECTP and VGO construction.
01/26/96	762-AR-9	Issued to resolve 762-AR-8 appeal.
3/10/00	762-AOP-R0	First operating air permit; incorporated limits and provisions for all minor modifications initiated by the facility from 1992 through August, 1999

Albemarle Corporation
 Permit #: 0762-AOP-R16
 AFIN: 14-00028

The following table summarizes the changes made in Permit No. 762-AOP-R0.

Change	Type of change	Application date
NC-14, 95ND141/ Stabrom 909 - New scenario increases bromine and chlorine each by 0.88 tons per year.	Minor modification	5/1/00
Alkyl Amines Area, Alcohol addition system - A-3 insignificant storage tank and various instrumentation were added to insignificant list.	Administrative Amendment (Insignificant source)	5/25/00
NC-12, New heated air blower (SN-DB-04) & Backup scrubber (SN-DB-17) are permitted at Decabrom unit. PM/PM ₁₀ increases by 5.3 tpy each. Br ₂ +HBr emissions from SN DB-04 increased by 2.4 tpy, and new HBr emissions from SN-DB-17 were 0.44 tpy.	Minor modification	6/9/00
NC-17, Specific Condition 151 error - A source was referenced in error.	Administrative Amendment	6/15/00
NC-17, Specific Condition 152 removal - Requirement was removed to maintain minimum acid strength for SO _x scrubber SN-16-13. This requirement didn't make sense because lower acid strength would only allow better removal. A scrubber flow requirements are already in place as a compliance mechanism.	Administrative Amendment	6/15/00
Boilers, Specific Condition 170 - Testing requirement is removed PM/PM ₁₀ testing at #1 and #2 Boilers (SN-BH-01 & SN-BH-02) Testing was determined to be unnecessary due to reliability of the factors used.	Modification	7/13/00
DECTP, higher purity and emissions reroute - Purification (SN-DE-23) emissions are routed to the VGO (SN-DE-21). VGO HCl emissions increase by 25 tpy. This was determined to not be a MACT issue because no affected process units are constructed or reconstructed as part of the modification. Purification had the capacity for the higher purity product beforehand. Only the emissions vent header will be constructed which allows the emissions to be routed to the VGO. Other emissions from these two sources change slightly.	Modification	8/11/00
NC-23, emissions updates - SN-23-06, 07, and 08 emission bubble is changed to allow higher VOC and HBr emissions. Stack testing showed some occurrences of exceedances during multiple test runs. VOC is increased by 1.8 tpy and HBr is increased by 0.5 tpy. SN-23-03 emissions are lowered to reflect test data.	Modification	8/29/00
NC-12, increase Decabrom Product Dryer firing rate (SN-DB-04), increase DPO annual dry rate at storage tank (SN-DB-07), allow Decabrom usage of TBBPA packaging equipment - At SN-DB-04 combustion emissions increase slightly. At the same source PM/PM ₁₀ emissions increase by 2.1 tpy and VOC is increased by 2.1 tpy. At SN-DB-07, HCl emissions increase by 0.6 tpy.	Minor modification	10/4/00

Albemarle Corporation
 Permit #: 0762-AOP-R16
 AFIN: 14-00028

Change	Type of change	Application date
NC-17, New xylene formulation - At SN-16-18, 21, 22, and 23 xylene emissions are changed to include the possibility of mixed xylene or ethyl benzene.	Minor modification	11/17/00
NC-14, Bleach production - This is an additional change related to the 5/1/00 minor mod. Bleach production is permitted at the NC-14 reactor under existing permit limits.	Minor modification	12/6/00
Clear Completion Fluids - VOC emissions at SN-CB-02 and 16 are reduced to reflect test data. Annual SN-CB-04 VOC emissions were reduced to reflect updated emission calculation methodology and annual methanol throughput limit.	Administrative amendment	1/9/01
NC-14, Tank (SN-TB-26) - This tank is allowed ethylene glycol storage use. During these periods emissions are insignificant.	Administrative amendment	2/21/01
NC-23, Solvent tote bin (SN-23-14) - VOC emissions increase by 1.53 tpy.	Minor modification	3/15/01
Bromine area -Caustic drum (SN-BR-15) and generator usage (SN-MS-08) - Caustic Drum is allowed as an alternate control for periods when Bromine Area Scrubber is down. Additional Cl ₂ and Br ₂ emissions are 0.1 tpy each. Combustion emissions increase due to generator allowance with the greatest being NO _x and CO at 19.0 tpy each.	Minor modification	5/15/01
NC-14, NaBr production - This scenario is permits NaBr production increasing Br ₂ and HBr emissions by 0.44 tpy each at SN-TB-03.	Minor modification	6/11/01
NC-15, update bromine rate at SN-15-02 and alternative compliance with SN-15-02 and SN-15-12 bromine rates - HBr and Br ₂ rates at SN-15-02 are increases by 0.3 tpy each.	Minor modification	7/24/01
NC-23, Phenol Storage Tank (SN-23-15) - Emissions are routed to existing Vent Absorber (SN-23-05). VOC and phenol emissions at SN-23-05 increase by 0.4 tpy.	Minor modification	12/13/01
Bleach storage tank - a 6,000 gallon bleach storage tank was listed as an insignificant activity. No regulated emissions result from this activity.	Administrative amendment	1/9/02
DECTP, Vent header - SN-DE-01, 02, 03, 09, and 25 combine to SN-DE-28. No changes result only emissions are bubbled into new source (SN-DE-28).	Minor modification	2/14/02
NC-21, HCl tank and gasoline through put - A new 10,000 gallon HCl tank is permitted with emissions routed to Incinerator (SN-21-01). Increased throughput at Gasoline Storage Tank (SN-MS-07) is permitted. Extra combustion emissions result at SN-21-01. VOC increases 0.7 tpy at SN-MS-07 along with various HAPs.	Minor modification	2/14/02
NC-14, Ethyl bromide production scenario - EtBr scenario is permitted under existing MeBr emission limits with some exceptions. Exceptions result in a VOC increase of 1.2 tpy and HBr increase of 0.1 tpy.	Minor modification	4/19/02

Albemarle Corporation
 Permit #: 0762-AOP-R16
 AFIN: 14-00028

Change	Type of change	Application date
NC-17, Phthalic Anhydride (PA) Tank (SN-16-31) - PA tank is no longer vented to Scrubber (SN-16-02). PA emissions removed from the scrubber vent. PA and VOC emissions from SN-16-31 are listed at 0.8 tpy each resulting in a 0.4 tpy increase of the PA emissions.	Minor Modification	5/6/02
NC-23, Caustic Addition - The permittee is allowed to add caustic to recirculating solvent for corrosion prevention. This project allows 19.2 tpy of additional VOC. This project may or may not be related to other projects at NC-23 since the unit's construction in 1998 which have allowed total VOC increases of 39.3 tpy. Additional increases at this unit may trigger PSD review by causing total VOC increases exceeding 40 tpy depending on the relationship between past and future projects. Bromoform is increased by 1.9 tpy and acetaldehyde ins increased by 0.9 tpy.	Minor Modification	5/7/02
Boilers, H2S Monitoring Protocol - Specific Condition 169 regarding SN-BH-01 and 02 (Boilers) is adjusted to allow a decrease in monitoring frequency from every 15 minutes to every 6 hours. This is deemed appropriate after reviewing historical data from the past four quarterly reports of 15 minute data. The reports show low variance in emission rates and indicate little chance of exceeding permitted rates.	Modification	6/19/02
NC-17, Sulfuric Acid Storage Tank - T-9315 - This tank is now vented to the atmosphere and listed as an insignificant source (SN-16-32).	Administrative amendment	7/3/02
Molten Sulfur Tank - T9369	Administrative amendment	1/21/03
Brine Treatment Area - SN-BT-10 (T-292) is removed from Insignificant Activities list and listed as a permitted source to allow heat treatment of the tank contents.	Minor Modification	1/21/03
Alkyl Bromides Area - SN-AB-15 - Storage tank (T-83403B) is replaced with a new 11,130 gallon tank making it subject to NSPS Subpart Kb. Emissions are not affected as they remain routed to SN-AB-15.	Minor Modification	1/30/03
NC-12 Process Area - SN-DB-01 is changed out with a similar scrubber. No changes to emission rates or compliance mechanisms.	Minor Modification	2/21/03
Insignificant Activities List - Hot Oil Expansion Tank (T-9354) added for use at NC-16 & 17; Six Emergency use generators and fire pumps added; Hot oil Surge Tank (D-3490) added for use at NC-16 & 17; Molten Sulfur Pit and Loadout added for use at the Sulfur recovery area.	Administrative amendment	3/17/03
Sulfur Recovery Area (Gas Sweetening) - Sulfinol Storage Tank (SN-SL-02) is added. Emissions of VOC are increased by 0.6 tpy.	Minor Modification	3/17/03
NC-12 & NC-15 - Product Packaging is automated. Higher air flows at SN-15-16 increase PM/PM ₁₀ emissions by 2.1 tons per year.	Minor Modification	4/14/03

Albemarle Corporation
 Permit #: 0762-AOP-R16
 AFIN: 14-00028

Change	Type of change	Application date
Backup Power Generators - A change is made to the original minor modification dated 5/15/01. A larger total capacity is allowed while firing of diesel fuel affecting pound per hour emission rates. Limits remain in effect for annual operation that limits generator usage below PSD thresholds. Annual emissions are unaffected.	Minor Modification	4/24/03
An alternative chemical reaction was identified and used to manufacture products in the clear completion fluids process. The alternative reaction replaces methanol with ammonia hydroxide resulting in ammonia emissions of 2.0 lb/hr and 2.2 tpy.	Minor Modification	02/18/2004
Albemarle has the option of installing a new distillation column to be used to recover benzene from the co-product HCl (HCl Loading Operation, SN-21-04) for reuse in the NC-21 process unit. Permitted emissions will increase by 0.8 lb/hr and 0.2 tpy, Benzene and VOC by 0.3 lb/hr and 0.1 tpy, HCl.	Minor Modification	07/13/04

Permit #762-AOP-R5 was issued on June 30, 2005. This was the first renewal issued to Albemarle under the Title V program. The following table lists the changes requested in the renewal application:

Process Name	Modification
Br ₂ Production	<ol style="list-style-type: none"> 1. Revised description for SN-BR-14 2. Revised description for SN-BR-13 (Insignificant Activity) 3. Added SN-ED-04 to Insignificant Activity List 4. Revised emission rates and description for SN-BR-05 (Insignificant Activity) 5. Added Hot Water Tank, B-3010 to Insignificant Activity List 6. Revised the equipment description in Specific Condition #9 7. Revised the annual Br₂ emission limit for SN-BR-09 from 0.06 tpy to 0.09 tpy
Sulfur Production	<ol style="list-style-type: none"> 1. Deleted Specific Condition #20a, Sulfinol Storage Tank no longer subject to NSPS Subpart Kb. 2. Added SN-SL-03 (Sulfinol Storage Sump), SN-SL-04 (MDEA Storage Tank), and SN-SR-03 (Molten Sulfur Pit and Loadout) to Insignificant Activity List 3. Added 3-hour SO₂ limit for Emergency Flaring of Brinefield Gas at SN-SL-01 to Specific Conditions #17 and #18
Clear Completion Fluids	<ol style="list-style-type: none"> 1. Added source numbers to the Ammonium Hydroxide (SN-CB-19) and the Formic Acid Bins (SN-CB-20) insignificant activities. 2. Removed Methanol Storage Tank (SN-CB-04) emission limits from Specific Condition #29 3. Rounded up VOC emissions limits in Specific Conditions #21 and #22 for consistency 4. Revised the HBr and Br₂ emission limits for Alternate Operating Scenario for R-21 Vent Scrubber (SN-CB02/16) to 0.22 tpy and 0.44 tpy, respectively

Process Name	Modification
DECTP Production	<ol style="list-style-type: none"> Deleted Specific Condition #47 because the tanks are no longer subject to NSPS Subpart Kb For SN-DE-21, revised the annual emission limit for SO₂ to 30.7 tpy and add emission limits for Toluene (0.40 lb/hr and 1.76 tpy) and Ethyl Chloride (0.20 lb/hr and 0.88 tpy) Added DECTP process sewers to the Insignificant Activity List Revised the CO emission limits for SN-DE-17 (0.04 lb/hr and 0.18 tpy) and SN-DE-18 (0.07 lb/hr and 0.31 tpy)
Alkyl Amines Production	<ol style="list-style-type: none"> Deleted Specific Condition #59 because tanks are no longer subject to NSPS Subpart Kb and SN-AD-35 is not a storage vessel. Added ethylene glycol emission limits (0.06 lb/hr and 0.30 tpy) to SN-AD-36 Revised emission limits for SN-AD-26 based on updated AP-42 natural gas combustion limits Revised the HBr and Br₂ emission limits for SN-AD-05 Changed the source designation for SN-AD-37 to SN-AD-38 Added Liquid Hydrogen Pressurized Tank (SN-AD-31) to Insignificant Activity List
Alkyl Bromides Production	<ol style="list-style-type: none"> Deleted Specific Conditions #79 and #257 because tanks are no longer subject to NSPS Subpart Kb Added SN-AB-17 and SN-AB-18 Insignificant Activities List
NC-12 Production	<ol style="list-style-type: none"> Deleted Specific Condition #85 because tank is no longer subject to NSPS Subpart Kb
NC-14 Processes	<ol style="list-style-type: none"> Deleted Specific Conditions #91 through #104 because TBBPA production has been discontinued Revised emission limit for VOC, Methanol, Methyl bromide to 0.93 lb/hr and 4.07 tpy, each Removed Brine Stripper Column Vent (SN-TB-20) from Insignificant Activity List because source has been removed from service Revised source description for 6,000 gallon Bleach Storage Tank (Insignificant Activity)
NC-15 Production	<ol style="list-style-type: none"> Removed Toluene emission limits from SN-15-15 because process emitting Toluene has been discontinued Revised CO emission rates for SN-15-12 to 0.15 lb/hr and 0.66 tpy Revised VOC emission rates for SN-15-13 to 0.07 lb/hr and 0.31 tpy Revised the PM/PM₁₀ emission rates for SN-15-16 to 1.20 lb/hr and 5.30 tpy
NC-17 Production	<ol style="list-style-type: none"> Added Sulfuric Acid Storage Tank, T-9315 (SN-16-34) to Insignificant Activity List Revised SO₂ emission limits for SN-16-10 to 0.10 lb/hr and 0.44 tpy Revised PM/PM₁₀ emission limits for SN-16-11 to 0.10 lb/hr and 0.44 tpy Revised CO (0.86 lb/hr and 3.77 tpy) and PM/PM₁₀ (0.05 lb/hr and 0.22 tpy) emission limits for SN-16-18 Revised PM/PM₁₀ emission limits for SN-16-20 to 0.04 lb/hr and 0.18 tpy Removed Phthalic Anhydride emission limits from SN-16-02 because the process generating the emissions has been discontinued
NC-21 Production	<ol style="list-style-type: none"> Added statement to Specific Condition #177 that a formal RATA is not required for the continuous parametric monitoring system on SN-21-01.
Boilers	<ol style="list-style-type: none"> Revised PM, PM₁₀, and VOC emission rates based on updated AP-42 natural gas combustion factors Added Boiler Water Treatment Chemicals Storage Tank to Insignificant Activity List

Albemarle Corporation
 Permit #: 0762-AOP-R16
 AFIN: 14-00028

Process Name	Modification
Brine Management	<ol style="list-style-type: none"> Updated the process description to reflect the construction of the tail brine tank system has been completed and operation approved. Revised hourly VOC emission limit for SN-BT-17 to 16.40 based on updated estimate Added existing Line Vents SN-BT-25 through SN-BT-28 Assigned source designation SN-BT-29 to the alternate operating scenario for Oil Separator Tank, T-292 and restored SN-BT-10 to Insignificant Activity List
DMTDA Production	<ol style="list-style-type: none"> Added Bleach Storage Tank (SN-DM-08) to Insignificant Activity List Revised CO emission rates for SN-DM-02 to 0.10 lb/hr to 0.44 tpy
Maintenance and Support Operations	<ol style="list-style-type: none"> Revised insignificant activity Gasoline Storage Tank (SN-MS-10) source description to a capacity of 2,000 gallon Revised VOC and HAP emission limits for the Extraneous Water Systems (SN-MS-01) Revised SN-MS-03 source description to French Drain Sump Bubble Revised emission rates for Cooling Towers (Insignificant Activity, SN-MS-11) Included all fugitive refrigerant annual emissions under one plantwide bubble (Specific Condition #219) Added the following sources to the Insignificant Activity List: Drinking Water Treatment and Distribution, Quality Control Laboratory, Pave Plant Roads and Parking Areas, Unpaved Plant Roads, Building Air Conditioning Systems, Filter Aid Tanks T-1306 and T-1307, Sulfuric Acid Tank Added Plantwide Condition 28 requiring records demonstrating that all reciprocating internal combustion engines (RICE) are exempt from 40 CFR Part 63, Subpart ZZZZ.

In addition to the renewal application Albemarle submitted a request for a minor modification involving two flame retardant process units, NC-14 production unit and NC-22 production unit, permitted at the facility. The NC-22 production unit was never built, and portions of NC-14 have not operated for a few years. Albemarle proposed to use exiting equipment at NC-14 along with some new equipment to produce NC-22 as an alternate operating scenario. Also, Albemarle requested the TBBPA alternate operating scenario for NC-14 be removed from the permit.

The new equipment installed included two carbon bed solvent recovery units (SN-TB-41), distillation columns, as well as several pumps, heat exchangers, other small process vessels, and new refrigeration unit. Five existing tanks that were purchased but never installed for the NC-22 process unit were taken from storage and placed into operation. All non-fugitive emissions from the new equipment are routed to the carbon bed solvent recovery units or the caustic scrubber (SN-TB-14). Due to the requested modifications, permitted PM/PM₁₀ annual emissions decreased by 9.5 tpy, and permitted VOC and HAP annual emissions increased by 1.5 tpy and 0.63 tpy, respectively.

Permit #762-AOP-R6 was issued on September 7, 2005. Albemarle submitted requests for four separate modifications.

- The first modification addressed an increase in production at the NC-15 and NC-21 process units. Albemarle requested to install additional process equipment (several pumps, heat exchangers, condensers, and a process tank) at the NC-15 and NC-21 production areas.

Albemarle Corporation
Permit #: 0762-AOP-R16
AFIN: 14-00028

None of the new equipment vents directly to the atmosphere, and it is controlled by either the Emission Control Vent Gas Incinerator (SN-21-01) or the NC-15 Area Scrubber (SN-15-12). No new point sources were associated with this modification, but the throughput to SN-21-01 and NC-15-12 increased by approximately 13.5 %.

- The second modification addressed installation of an alternate control device and an alternate operating scenario at SN-TB-41. Albemarle proposed to use an alternate, but equivalent, control device for the Carbon Bed/Tote Solvent Recovery Units (SN-TB-41). The alternate control device is a carbon adsorption system contained in portable totes (a.k.a. Carbon Totes). Unlike the existing carbon beds which will remain in a fixed position, the carbon totes are shipped off site for regeneration. With the appropriate recordkeeping, Albemarle may switch between the fixed carbon beds and the carbon tote adsorption systems.

Albemarle also proposed an alternate operating scenario for SN-TB-41. The alternate scenario addressed NC-22 production when only solvent storage and solvent drying is being performed. VOC vapors sent to the adsorption system while operating under the alternate scenario are less than 48 lb/day in comparison to 993 lbs/day during normal operation.

- The third modification addresses a request to use an alternate brominating raw material (ABRM1) for the NC-23 production unit. The use of ABRM1 resulted in a chloroethane production rate that is 20 percent of the current ethyl bromide production rate. No additional VOCs are emitted from the use of ABRM1. Therefore, permitted VOC emission limits do not need to be increased.
- The fourth modification addressed a request to increase the number of possible products at the NC-12 production unit. Other products can be produced by changing the raw material in the reaction. No additional equipment is required, and downstream collection and purification processes do not need to be modified because the additional products are similar to the existing.
- Due to the requested modifications, permitted emission limits increased for VOC and benzene by 0.4 tpy, CO by 5.3 tpy, HCl by 0.23 tpy, PM/PM₁₀ by 0.9 tpy, and chloroethane by 1.81 tpy.

Permit #762-AOP-R7 was issued on April 12, 2006. Albemarle proposed production of a product designated as NC-24. The NC-24 production unit consists of pre-existing and proposed equipment. The pre-existing equipment is used as part of an alternate operating scenario for the production of NC-24, includes the Emergency Flare (SN-AD-26), the Wash Water Tank (SN-CB-10), and the Refrigerated Vent Condensers at (SN-TB-25). The equipment installed included a Wash Column (SN-24-01) as well as a number of distillation columns, flash drums, pumps, and heat exchangers which do not vent directly to the atmosphere. The estimated emission rates for the requested modification were 18.8 tpy VOC, 0.7 tpy HCl, 1.0 tpy HBr, 0.3 tpy Acetone, 0.2 tpy 1,2 Epoxybutane, 0.5 tpy Ethylene Glycol, 0.3 tpy CO, 0.1 tpy SO₂, 0.1 tpy NO_x, and 0.1 tpy PM/PM₁₀.

Albemarle Corporation
Permit #: 0762-AOP-R16
AFIN: 14-00028

Permit No. 762-AOP-R8 was issued on August 10, 2006. Four separate minor modification applications were submitted. The following changes were requested:

- Albemarle proposed a permit modification to increase the throughput for DPE Byproduct/Heavy Organic Storage (SN-15-18) and the maximum allowable DPE (1,2-Diphenylethane) in the byproduct stream. Albemarle proposed a revised method of calculating emissions from SN-15-18. The total VOC emission associated with this modification is 0.1 tpy of VOC.
- Albemarle proposed a permit modification to allow the use of DECTP Ethanol Storage Tank (SN-DE-01) and NC-14 Unit Feed Tank (SN-TB-11) under an alternate operating scenario as additional ADMA brine storage tanks. Permitted VOC emissions increased by 2.9 tpy.
- Albemarle requested permission to install an additional baghouse (SN-DB-18). The new baghouse will be located downstream of the product dryer (SN-DB-04), and it will be used to separate conveyance air from dried product. Permitted PM/PM₁₀ emission limits increased by 0.3 lb/hr and 1.4 tpy.
- Albemarle proposed an alternate operating scenario when the NC-24 reactor loses reaction. When this happens, the raw material vapors (propylene and hydrogen bromide) must be vented before re-initiating the reaction. The vapors are vented to the Wash Column (SN-24-01), which absorbs the hydrogen bromide just as in the primary operating scenario. Propylene will pass through the wash column unaffected.
- The process will be controlled such that the flaring (SN-AD-26) and depressurization of the reactor will not occur at the same time. The pressure control valve on the NC-24 reactor will be designed to allow no more than 48.5 lb/hr of VOC which is the same rate VOC would otherwise be routed to the flare in the primary operating scenario. No HBr beyond what is already permitted will be emitted during the alternate operating scenario. Permitted VOC emission limits increased by 0.60 tpy.

Permit No. 762-AOP-R9 was issued on January 1, 2007. Three separate minor modifications applications were submitted. The following changes were requested:

Albemarle proposed a permit modification to increase NC-15 production with a portion of the additional NC-15 production under an alternate operating scenario which uses NC-12 equipment, to install at the NC-12 process unit a 19,800 gallon Diphenyl Oxide storage tank, and to install a caustic scrubber. The caustic scrubber (SN-DB-19) was installed immediately after the product dry filter (SN-DB-04) to provide additional PM/PM₁₀ and Br₂ + HBr control while operating in the alternate scenario. Permitted VOC limits increased by 1.10 tpy, while permitted PM/PM₁₀ and Br₂ + HBr limits decreased by 2.77 tpy and 1.01 tpy, respectively. Albemarle requested the limits for the ADMA Flare (SN-AD-26) be revised while operating as an emergency control device for the alkyl amines process. The purpose of increasing the emission limits is to allow and to account for non-emergency operation of the flare such as

Albemarle Corporation
Permit #: 0762-AOP-R16
AFIN: 14-00028

cleaning and/or maintenance. Permitted PM/PM₁₀, VOC, CO limits increase by 0.03 tpy, 0.44 tpy, and 0.15 tpy, and permitted SO₂ and NO_x limits decreased by 0.05 tpy and 0.10 tpy.

Albemarle proposed a permit modification to allow an alternate operating scenario (Scenario B) for NC-22 production and to increase the maximum number of batches to 1,925 batches rolling 12-month period. The existing process (hereafter referred to as Operating Scenario A) has two VOC control scenarios which will also be utilized to control VOC emissions from Scenario B. The new scenario utilizes a different processing method to isolate the final product. In Scenario B, the product is not centrifuged; therefore the centrate hold-up drum (SN-TB-43) is not used to store centrate. Instead, process water is stored in the hold-up drum, and the drum is an insignificant activity under Scenario B. Also, Scenario B results in the product being formed into pellets rather than powder. The pellets do not require the product baghouse (SN-TB-04) to be collected. Since, Scenario B is the worst case for VOC and HCl the permitted emission limits will increase by 2.72 tpy VOC and 0.05 tpy HCl.

Permit No. 762-AOP-R10 was issued on April 13, 2007. Albemarle requested the following changes:

- Added an emission source (SN-DB-20) for drum D-2515 at the NC-12 Unit. During the NC-15 Production Alternate Operating Scenario the drum stores diphenyl ethane (DPE). Potential emissions from the drum increased by 0.32 lb/hr and 1.41 tpy of VOC;
- Installed and operated a temporary (rental) scrubber (SN-DB-19T) for the NC-12 Unit for operation under the NC-15 Production Alternate Operating Scenario. The temporary scrubber enabled Albemarle to begin NC-15 production before the permanent scrubber (SN-DB-19) was completed. The control efficiency for Br₂ + HBr is 40% which was a higher efficiency than the permanent scrubber was expected to achieve. The control efficiency for PM/PM₁₀ for SN-DB-19T was expected to be less than expected for the permanent scrubber. Albemarle proposed limiting operation of the scrubber to 1,080 hours per consecutive 12-month period. Permitted emissions increased by 2.00 tpy PM/PM₁₀;
- Revised Plantwide Condition #28 to address RICE units which are not exempt from Subpart ZZZZ but the only applicable requirement is the initial notification; and
- Installed a heat transfer fluid system expansion tank (SN-TB-44), an insignificant activity.

Permit No. 762-AOP-R11 was issued on November 1, 2007. Albemarle requested three separate minor modifications:

- Use an existing 16,000 gallon tank (SN-AD-40) to store mixed ADMA final products. Permitted VOC emissions increased by 1.14 tpy.
- Increased production of NC-15 product at both the NC-12 and NC-15 production units, permitted use of the NC-12 Product Dryer Scrubber (SN-DB-19) in all NC-12 operating scenarios, and removed the NC-12 Temporary Product Dryer Scrubber (SN-DB-19T) since

Albemarle Corporation
Permit #: 0762-AOP-R16
AFIN: 14-00028

the permanent scrubber is in operation. Permitted PM/PM₁₀ emissions increased by 0.77 lb/hr and 3.38 tpy.

- Revised the assignment of VOC and HAP emissions from the NC-23 production unit and removed the Solvent Tote Bin (SN-23-14).

Albemarle determined that approximately 33% less chloroethane, a HAP that can be generated from the raw material, enters the system of baghouses controlling the handling of NC-23 product. The difference is reassigned to the Raw Material Scrubber (SN-23-03) and the Vent Absorber (SN-23-05). Albemarle did not propose to increase the total chloroethane emission limit. Acetaldehyde, bromoform, and phenol emission limits for SN-23-05 decreased.

Permit No. 762-AOP-R12 was issued on March 12, 2008. Albemarle submitted four separate applications:

- Albemarle proposed two operating scenarios which permit the testing of three identified sources where the sources are to be operated under conditions other than normal operation for the purpose of conducting the tests. The first operating scenario is for demonstrating that Vent Gas Oxidizer (SN-16-18) and the Vent Gas Incinerator (SN-21-01) meet the HAP reduction required by 40 CFR Part 63, Subpart FFFF, the MON MACT. The second operating scenario permits operating and testing of the NC-15 Area Scrubber (SN-15-12) while the scrubber is utilizing fresh water in the top portion of the column rather than recirculating a portion of the spent scrubbing solution. Permitted annual emission limits were not increased.
- Albemarle proposed to change the supply of HCl for SN-BR-08 (Recycle HCl Storage Tank) and revise the HAP speciation for SN-MS-07 (Gasoline Storage Tank).

The supply of HCl could potentially contain up to 30 ppm benzene which resulted in potential VOC and benzene emissions of 0.28 lb/hr and 1.21 tpy. Potential HCl emissions from SN-BR-08 remained unchanged. The HAP speciation for emissions from the gasoline storage tank was revised which resulted in lower hourly and annual HAP emission limits.

- Albemarle returned to service two 4,000 gallon existing storage tanks (SN-AD-41). Permitted emission limits are based on maximum pump rate and the worst-case ADMA product. Permitted VOC emissions increased by 2.28 tpy.
- NC-21 process was expanded through various equipment additions/upgrades (e.g., piping, additional instrumentation, meters, and controls) and process changes (e.g., increasing reboiler capacity, and changing service of existing equipment). The permitted VOC, Benzene, and Ethylene Dichloride emissions increased by 1.88 tpy, 1.88 tpy, and 0.10 tpy, respectively.

Permit No. 762-AOP-R13 was issued on July 17, 2008. The modification incorporated all applicable requirements of 40 CFR Part 63, Subpart FFFF – *National Emission Standards for*

Albemarle Corporation
Permit #: 0762-AOP-R16
AFIN: 14-00028

Hazardous Air Pollutants Miscellaneous Organic Chemical Manufacturing and Miscellaneous Coating Manufacturing. The short term emission limits under the MON required testing scenarios were revised. Due to the modification permitted HCl emissions decreased by 1.1 tpy.

Permit No. 762-AOP-R14 was issued on March 19, 2009. The permit was modified to increase the production at the NC-24 unit to 2,800,000 gallons of NC-24 product through a combination of installing new equipment (i.e., heat exchangers, drums, expansion pots, pumps, compressors, and associated piping) and addressing process efficiency (i.e., raw material supply interruptions, reactor heat removal rates, washed reaction crude drying capacity, etc.). Permitted VOC and HCl emissions increased by 10.7 tpy and 0.10 tpy, respectively.

Permit No. 762-AOP-R15 was issued on TBD. Albemarle requested permission to install central vacuum systems at NC-12 (SN-DB-22) and NC-15 (SN-15-19) to collect off-spec products. Permitted PM/PM₁₀ increased by 0.4 tpy.

SECTION IV: SPECIFIC CONDITIONS

Bromine (Br₂) Production

Bromine Production

Bromine-containing brine occurs naturally in specific south Arkansas geological formations. The separation of bromine from the brine takes place in two bromine towers.

When the brine first comes out of the ground, it contains sour natural gas and sodium bromide. This gas is separated from the sodium bromide and sent to the sulfur recovery processes. The degassed brine is fed directly to the bromine towers through a feed brine tank. In the bromine towers, the brine is mixed with chlorine. Liquid chlorine is unloaded directly from railcars and passed through a vaporizer (the chlorine railcar unloading takes place under pressure, so negligible losses result). The chlorine gas is injected into the bromine towers. There is no permanent chlorine storage at this plant.

In the bromine towers, the brine is chlorinated to produce the bromine. The bromine vapors are condensed, purified, and then packaged.

Each bromine tower has an atmospheric scrubber. Scrubbers SN-BR-01 and SN-BR-04 are associated with the bromine towers, while SN-BR-02 and SN-BR-03 are associated with the common purification train. SN-BR-02 and SN-BR-03 do not vent directly to the atmosphere. The gases leaving these two scrubbers are sent to a third scrubber, the bromine area scrubber, SN-BR-12.

Bromine vapors displaced during the packaging and loading operations are vented back to the bromine purification train scrubbers. If a bromine shipping container needs to be completely purged of bromine vapors (for internal inspection or repair), nitrogen is blown into the container and the vapors are vented to the bromine purification train scrubbers.

Compliance with permitted emission rates shall be demonstrated through stack testing, parametric monitoring, and record keeping requirements.

Specific Conditions

- The permittee shall not exceed the emission rates set forth in the following table:
 [Regulation No. 19 §19.501 *et seq.* and 40 CFR Part 52, Subpart E]

SN-#	Description	Pollutant	lb/hr	tpy
BR-01	#1 Bromine Tower Vent Scrubber C-3042	VOC	1.50	6.60
BR-04	#2 Bromine Tower Vent Scrubber C-3043	VOC	3.81	16.70
BR-08	Recycle HCl Storage Tank	VOC	0.28	1.21
BR-14	Br ₂ Fugitive Emissions	VOC	0.50	2.20

- The permittee shall not exceed the non-criteria emission rates set forth in the following table. [Regulation No. 18 §18.801 and A.C.A §8-4-203 as referenced by §8-4-304 and §8-4-311]

SN-#	Description	Pollutant	lb/hr	tpy
BR-01	#1 Bromine Tower Vent Scrubber C-3042	Cl ₂	0.06	0.26
		Br ₂	0.26	1.14
BR-04	#2 Bromine Tower Vent Scrubber C-3043	Cl ₂	0.03	0.13
		Br ₂	0.14	0.61
BR-08	Recycle HCl Storage Tank	HCl	0.07	0.31
		Benzene	0.28	1.21
BR-09	Recycle HBr Storage Tank, Vent Scrubber C-3036	Br ₂	0.02	0.09
		HBr	0.02	0.09
BR-12	Bromine Area Scrubber C-3049	Cl ₂	0.10	0.44
		Br ₂	0.30	1.31
BR-14	Br ₂ Fugitive Emissions	Cl ₂	0.04	0.18
		Br ₂	1.39	6.09

3. The following sources shall not exceed 5% opacity: SN-BR-01, SN-BR-04, SN-BR-09, and SN-BR-12. [Regulation No. 18 §18.501 and A.C.A §8-4-203 as referenced by §8-4-304 and §8-4-311]
4. All bromine vapors displaced during loading shall be vented back to the bromine purification train scrubber (SN-BR-03), in such manner that no vapors are released to the atmosphere. In the event a shipping container requires purging of bromine or other vapors, such activity shall be performed so that no vapors are emitted. [Regulation No. 18 §18.1004 and A.C.A §8-4-203 as referenced by §8-4-304 and §8-4-311]
5. The permittee shall calculate Br₂ and HBr emissions from SN-BR-09 once every six months. The calculation method shall be the same as presented in the permit application, or a method otherwise pre-approved by the Department. Emission estimates shall be quantified as lb/hr and ton/yr using worst-case parameters for hourly emissions and a rolling twelve-month total for annual figures. The calculations shall be kept on-site and made available to Department personnel upon request. [Regulation No. 18 §18.1004 and A.C.A. §8-4-203 as referenced by §8-4-304 and §8-4-311]
6. The permittee shall test SN-BR-01 and SN-BR-04 for VOC, using EPA Reference Method 25A or EPA Method 18. Testing shall be conducted within 10% of maximum source throughput capacity. It shall be performed in 2005 and every five years thereafter. [Regulation No. 19 §19.702 and 40 CFR Part 52, Subpart E]
7. The permittee shall test SN-BR-01, SN-BR-04, and SN-BR-12 for bromine and chlorine, using EPA Reference Method 26A. Testing for bromine shall be done during calendar year 2002 and every five years thereafter, and testing for chlorine shall be done during calendar year 2002 and every five years thereafter. Throughput during the testing events shall be within 10% of maximum capacity. [Regulation No. 18 §18.1002 and A.C.A §8-4-203 as referenced by §8-4-304 and §8-4-311]
8. The permittee shall install and operate a continuous flow monitor alarm at SN-BR-01 and SN-BR-04, which shall indicate when the scrubber brine solution flow rate fails to meet the established compliant parameter value. The flow rates measured at the most recent satisfactory test event shall be recorded and established as a sufficient parameter for

Albemarle Corporation
Permit #: 0762-AOP-R16
AFIN: 14-00028

demonstration of continuous compliance until the next test is performed. Proposed parametric set points and allowable operating ranges shall be submitted with the test report. A log of alarm incidents and corrective action shall be maintained on site and made available to Department personnel upon request. [Regulation No. 18 §18.1004 and A.C.A. §8-4-203 as referenced by §8-4-304 and §8-4-311]

9. The permittee shall record, every three hours, the pump discharge valve position and pump run light at SN-BR-12. The pump discharge valve position at the most recent satisfactory test event shall be recorded and established as a sufficient parameter for demonstration of continuous compliance until the next test is performed. Proposed parametric set points and allowable operating ranges shall be submitted with the test report. The pump discharge valve position/pump light records shall be maintained on site and made available to Department personnel upon request. [Regulation No. 18 §18.1004 and A.C.A. §8-4-203 as referenced by §8-4-304 and §8-4-311]
10. The permittee shall measure and record the caustic concentration of the scrubber media used for SN-BR-12 at least once per 12-hour shift. Each caustic changeout shall be logged as performed. Both caustic strength and changeout records corresponding to the most recent approved satisfactory test event shall be kept on site and made available to Department personnel upon request. [Regulation No. 18 §18.1004 and A.C.A. §8-4-203 as referenced by §8-4-304 and §8-4-311]

Sulfur Production

Introduction

Sour gas is co-produced with brine. The hydrogen sulfide (which makes the gas sour) is removed in the gas sweetening plants. These plants use solvents to remove the hydrogen sulfide from the sour gas. The treated gas is sent to the boilers where it is burned as fuel. The acid gas from the sweetening units, the gas which contains the hydrogen sulfide, is sent to a sulfur recovery plant for conversion to sulfur. Part of this sulfur is sold, and part is used in the diethylchlorothiophosphate (DECTP) process. The tail gas from the sulfur recovery plant is incinerated. Hydrogen sulfide from the DECTP process is recycled to the sulfur plant.

Gas Sweetening Plants

The gas sweetening plants are absorption processes. In these processes, the sour gas enters the bottom of the contactor. The absorption solution absorbs the H₂S contained in the gas. The desulfurized gas leaves the top of the absorber, while the rich solution (the solution which contains the H₂S) is sent to the regenerator column. In the regenerator, the volatile H₂S is separated by steam stripping. The regenerated solution is recycled to the contactor. The acid gas, which now contains the H₂S, is sent to the sulfur plant. A flare (SN-SL-01) is used during emergencies to burn vent gases when either equipment malfunction or power failure occur.

Sulfur Recovery Plant

The acid gas from the Gas Sweetening Plants is sent to a sulfur recovery plant. The sulfur recovery plant uses the Claus process, where exothermic reactions convert H₂S to elemental sulfur. The Claus plant at Albemarle removes 93% of the sulfur from the sour gas. The sulfur is sold as a product. The tail gas is sent to an incinerator (SN-SR-01). The Claus plant itself has no emissions.

Tail Gas Incinerator

Vent gases from the sulfur recovery plant and the DECTP scrubber are burned in the tail gas incinerator. The tail gas incinerator is designed for a minimum exhaust temperature of 1200°F.

Compliance with permitted emission rates shall be demonstrated through stack testing, parametric monitoring, record keeping, and reporting requirements.

Alternate Operating Scenarios

There are two alternate operating scenarios for SN-SL-01: (1) emergency flaring of “sour” brinefield gas and (2) emergency flaring of “sweet” gas. There is also one alternate operating scenario for SN-SR-01 that covers the situation when the incinerator operating temperature falls below 1,200°F. Specific Conditions # 17 through #20 set forth the requirements for these alternate operating scenarios.

Specific Conditions

11. The permittee shall not exceed the emission rates set forth in the following table.
[Regulation No. 19 §19.501 *et seq.* and 40 CFR Part 52, Subpart E]

SN-#	Description	Pollutant	lb/hr	tpy
SL-01	Gas Sweetening Process Flare	PM ₁₀	0.01	0.05
		SO ₂	0.01	0.05
		VOC	0.01	0.05
		CO	0.01	0.05
		NO _x	0.02	0.10
SL-02	Sulfinol Storage Tank	VOC	0.12	0.60
SR-01	Tail Gas Incinerator	PM ₁₀	0.07	0.31
		SO ₂	727.00	3184.0
		VOC	0.07	0.31
		CO	0.25	1.10
		NO _x	0.60	2.60
SR-02	Sulfur Area Fugitives	VOC	0.50	2.20

12. The permittee shall not exceed the non-criteria emission rates set forth in the following table: [Regulation No. 18 §18.801 and A.C.A. §8-4-203 as referenced by §8-4-304 and §8-4-311]

SN-#	Description	Pollutant	lb/hr	tpy
SL-01	Gas Sweetening Process Flare	PM	0.01	0.05
SR-01	Tail Gas Incinerator	PM	0.07	0.31
SR-02	Sulfur Area Fugitives	Methanol	0.06	0.26

13. The following sources shall not exceed 5% opacity: SN-SL-01 and SN-SR-01. [Regulation No. 18 §18.801 and A.C.A. §8-4-203 as referenced by §8-4-304 and §8-4-311]
14. Any flare event where non-pipeline quality gas is burned at SN-SL-01, with the exception of those instances outlined in Specific Condition #17, shall be reported in accordance with the requirements of General Provision 8. [Regulation No. 26 §26.701 and 40 CFR 70.6(a)(3)(iii)(B)]
15. The permittee shall operate and maintain a device to continuously monitor and record the temperature of the exhaust from the tail gas incinerator (SN-SR-01). This temperature shall be maintained at or above 1200°F during those periods when sulfur-bearing gases are being incinerated. [Regulation No. 19 §19.703, 40 CFR Part 52, Subpart E, and A.C.A. §8-4-203 as referenced by §8-4-304 and §8-4-311]
16. The permittee shall test SN-SR-01 for lb/hr emissions of SO₂, using EPA Reference Method 6C. The testing shall be performed in 2005, and every five years thereafter. [Regulation No. 19 §19.702 and 40 CFR Part 52, Subpart E]
17. During times of equipment malfunction or power failure, the permittee shall be allowed to operate under the following alternate scenarios within the limits outlined for each. [Regulation No. 19 §19.705, 40 CFR Part 52, Subpart E, and A.C.A. §8-4-203 as referenced by §8-4-304 and §8-4-311]

Source	Scenario	Emission Limits			Operating Limits
		Pollutant	lb/hr	ton/yr	
SN-SL-01	Emergency Flaring of Brinefield Gas	PM ₁₀	3.70	0.02	Actual emissions shall be calculated and recorded for each event.
		SO ₂	12,066.00*	36.00	
		VOC	3.70	0.02	
		CO	13.40	0.04	
		NO _x	31.40	0.10	
SN-SL-01	Emergency Flaring of Sweet Gas	PM ₁₀	2.20	0.11	Not to exceed 96 hours per year.
		SO ₂	5.60	0.27	
		VOC	2.20	0.11	
		CO	7.80	0.38	
		NO _x	18.40	0.89	
SN-SR-01	Tail Gas Pilot Flame Deviation (<1200°F)	SO ₂	242.6	2.82	Not to exceed 24 hours per year.

* One-hour maximum emission rate. The 3-hour average limit is 7,500 lb/hr.

18. The permittee shall maintain records which document compliance with the operating limits of the above listed scenarios. To demonstrate compliance with the limits given for emergency flaring of brinefield gas, the records must show that emissions were less than 12,066 pounds for any event lasting one hour or less. For events lasting longer than one hour, the records must show that emissions were less than 12,066 pounds for each hour and less than 22,500 pounds for any consecutive 3-hour period (i.e., 7,500 lb/hr on a 3-hour average). The records shall be updated as performed, kept on site, and made available to Department personnel upon request. If SO₂ emissions exceed these limits, the emissions must be reported in accordance with §19.601 or §19.602, as applicable. [Regulation No. 19 §19.705 and 40 CFR Part 52, Subpart E]
19. During times of equipment malfunction or power failure, the permittee shall not exceed the non-criteria emission rates set forth in the following table. [Regulation No. 18 §18.501 and A.C.A. §8-4-203 as referenced by §8-4-304 and §8-4-311]

Source	Scenario	Emission Limits			Operating Limits
		Pollutant	lb/hr	ton/yr	
SN-SL-01	Emergency Flaring of Brinefield Gas	PM	3.7	0.02	Actual emissions shall be calculated and recorded for each event.
SN-SL-01	Emergency Flaring of Sweet Gas	PM	2.2	0.11	Not to exceed 96 hours per year.
SN-SR-01	Tail Gas Pilot Flame Deviation (<1200°F)	H ₂ S	257.4	3.09	Not to exceed 24 hours per year.

20. The permittee shall maintain records which document compliance with the operating limits of the above listed scenarios. The records shall be updated as performed, kept on-site, and made available to Department personnel upon request. [Regulation No. 18 §18.1004 and A.C.A. §8-4-203 as referenced by §8-4-304 and §8-4-311]

Clear Completion Fluids

Calcium, Zinc, and Sodium Bromide Process Description

Calcium, zinc, and sodium bromide are produced in a batch process by reacting lime, zinc oxide, or sodium hydroxide with hydrobromic acid and elemental bromine. Albemarle can also produce these bromides by reacting the metal, or metal hydroxide, bromine, and methanol. These processes are capable of producing a number of bromine salts, depending on the metal, metal oxide, or metal hydroxide used as a starting material. However, Albemarle is only permitted to manufacture those compounds listed here. Vapors generated during the reaction are controlled by two scrubbers (SN-CB-02, SN-CB-16). Particulate emissions from raw material handling are controlled by two baghouses (SN-CB-01, SN-CB-18).

Calcium Bromide Alternate Operating Scenario

The alternate operating scenario for the Clear Completion Fluids process area employs Br₂, methanol (MeOH), and calcium hydroxide (Ca(OH)₂) as feedstocks for batch CaBr₂ production. Calcium hydroxide reacts with the Br₂/MeOH in an exothermic reaction to yield CaBr₂ product. Condensates entrained in the vapor leaving the reactor are collected in a knockout pot. Periodically, these condensates are drained and neutralized before being piped to an extraneous water system. The remaining vapor is routed to a caustic (NaOH) scrubber before being vented to the atmosphere. The spent caustic scrubber water is drained and piped to an extraneous water system. Approximate batch time for CaBr₂ production using Br₂/MeOH is six hours.

Compliance with permitted emission rates for the Clear Completion Fluids processes shall be demonstrated through stack testing, parametric monitoring, and record keeping requirements.

Specific Conditions

21. The permittee shall not exceed the emission rates set forth in the following table. [Regulation No. 19 §19.501 *et seq.* and 40 CFR Part 52, Subpart E]

SN-#	Description	Pollutant	lb/hr	tpy
CB-01	Raw Material Silo	PM ₁₀	0.10	0.44
CB-02	R-21 Vent Scrubber (South)	VOC	0.27	1.18
CB-04	Methanol Storage Tank	VOC	26.00	0.40
CB-16	R-21 Vent Scrubber (North)	VOC	0.27	1.18
CB-17	CCF Fugitive Emissions	VOC	1.80	7.90
CB-18	Raw Material Baghouse	PM ₁₀	0.10	0.44

22. The permittee shall not exceed the non-criteria emission rates set forth in the following table. [Regulation No. 18 §18.801 and A.C.A §8-4-203 as referenced by §8-4-304 and §8-4-311]

SN-#	Description	Pollutant	lb/hr	tpy
CB-01	Raw Material Silo	PM	0.10	0.44
CB-02	R-21 Vent Scrubber (South)	Ammonia	1.00	1.10
		Methyl Bromide	0.20	0.88
		Methanol	0.07	0.30
		Br ₂	0.10	0.44

SN-#	Description	Pollutant	lb/hr	tpy
CB-04	Methanol Storage Tank	Methanol	26.00	0.40
CB-16	R-21 Vent Scrubber (North)	Ammonia	1.00	1.10
		Methyl Bromide	0.20	0.88
		Methanol	0.07	0.30
		Br ₂	0.10	0.44
CB-17	CCF Fugitive Emissions	Methanol	1.30	5.70
		(Br ₂ +HBr)	2.40	10.50
CB-18	Raw Material Baghouse	PM	0.10	0.44

23. The following sources shall not exceed 5% opacity: SN-CB-01, SN-CB-02, SN-CB-16, and SN-CB-18. [Regulation No. 18 §18.501 and A.C.A §8-4-203 as referenced by §8-4-304 and §8-4-311]
24. The permittee shall conduct stack testing for bromine (Br₂) at SN-CB-02 and SN-CB-16. The testing shall be performed in 2002, and every five years thereafter, using EPA Reference Method 26A. [Regulation No. 18 §18.1002 and A.C.A §8-4-203 as referenced by §8-4-304 and §8-4-311]
25. The permittee shall perform a visual inspection of the pumps driving the scrubber media at SN-CB-02 and SN-CB-16 at least once per batch, to ensure that sufficient flow is maintained. Inspection results shall be recorded in a log. These records shall be kept on site and made available to Department personnel upon request. [Regulation No. 18 §18.1004 and A.C.A. §8-4-203 as referenced by §8-4-304 and §8-4-311]
26. The permittee shall use fresh caustic with every zinc bromide batch at scrubbers SN-CB-02 and SN-CB-16. For calcium bromide and sodium bromide, the pH shall be tested once per batch, and caustic changeouts performed as needed. Each pH test and caustic changeout shall be logged as performed. Both pH and changeout records corresponding to the most recent satisfactory test event shall be kept on site and made available to Department personnel upon request. [Regulation No. 18 §18.1004 and A.C.A. §8-4-203 as referenced by §8-4-304 and §8-4-311]
27. The permittee shall calculate methyl bromide and methanol emissions from SN-CB-02 and SN-CB-16 once every six months. Emission estimates shall be quantified as lb/hr and ton/yr, using worst-case parameters for hourly emissions and a rolling twelve-month total for annual figures. The calculations shall be kept on site and made available to Department personnel upon request. The calculations shall indicate compliance status with regard to both normal and alternate operating scenarios. [Regulation No. 18 §18.1004 and A.C.A. §8-4-203 as referenced by §8-4-304 and §8-4-311]
- 27a. The permittee shall demonstrate compliance with SN-CB-04 emission rates by not exceeding a throughput of 1,000,000 gallons of methanol or other less volatile VOC per twelve consecutive months at this tank. [Regulation No. 19 §19.705, Regulation No. 18 §18.1004, 40 CFR Part 70.6, and A.C.A §8-4-203 as referenced by §8-4-304 and §8-4-311]

- 27b. The permittee shall maintain monthly records demonstrating compliance with Specific Condition #27a. Records shall be updated by the 15th day following the month to which the records pertain, made available to Department personnel upon request, and otherwise in accordance with General Provision 7. [Regulation No. 19 §19.705, Regulation No. 18 §18.1004, 40 CFR Part 52, Subpart E, and A.C.A §8-4-203 as referenced by §8-4-304 and §8-4-311]

Additional conditions for Calcium Bromide Alternate Operating Scenario:

28. The permittee shall not exceed the emission rates set forth in the following table. The permittee shall not operate under this scenario at this time pursuant to Plantwide Condition #29. [Regulation No. 19 §19.501 *et seq.* and 40 CFR Part 52, Subpart E]

SN-#	Description	Pollutant	lb/hr	tpy
CB-02 CB-16	R-21 Vent Scrubber (South) & R-21 Vent Scrubber (North)	VOC	9.00	22.20

29. The permittee shall not exceed the non-criteria emission rates set forth in the following table. The permittee shall not operate under this scenario at this time pursuant to Plantwide Condition #29. [Regulation No. 18 §18.801 and A.C.A §8-4-203 as referenced by §8-4-304 and §8-4-311]

SN-#	Description	Pollutant	lb/hr	tpy
CB-02	R-21 Vent Scrubber (South)	Methyl Bromide	2.30	8.30
		Methanol	2.30	0.80
CB-16	R-21 Vent Scrubber (North)	Bromoform	2.30	1.30
		Ethylene Dibromide	2.30	5.50
		HBr	0.10	0.22
		Br ₂	0.10	0.44

30. The permittee shall perform a visual inspection of the pumps driving the scrubber media at SN-CB-02 and SN-CB-16 at least once per alternate scenario batch, to ensure that sufficient flow is maintained. Inspection results shall be recorded in a log. These records shall be kept on site and made available to Department personnel upon request. [Regulation No. 18 §18.1004 and A.C.A. §8-4-203 as referenced by §8-4-304 and §8-4-311]
31. The permittee shall use fresh caustic with each alternate scenario batch SN-CB-02 and SN-CB-16. Each caustic changeout shall be logged as performed. Both caustic strength and changeout records shall be kept on site and made available to Department personnel upon request. [Regulation No. 18 §18.1004 of and A.C.A. §8-4-203 as referenced by §8-4-304 and §8-4-311]
32. The permittee shall be limited to 1460 total batches under the alternate operating scenario per rolling 12-month period. Monthly records documenting batch totals shall be maintained on site and made available to Department personnel upon request. [Regulation No. 18 §18.1004 and A.C.A. §8-4-203 as referenced by §8-4-304 and §8-4-311]

Albemarle Corporation
 Permit #: 0762-AOP-R16
 AFIN: 14-00028

33. The permittee shall only use one Clear Completion Fluids reactor at any given time under the alternate scenario. [Regulation No. 18 §18.1004 and A.C.A. §8-4-203 as referenced by §8-4-304 and §8-4-311]
34. The permittee shall conduct stack testing on the Clear Completion Fluids reactor scrubber vents according to the following methods and schedule: [Regulation No. 19 §19.702 and 40 CFR Part 52, Subpart E]

SN	Pollutant	EPA Reference Method	Schedule
CB-02	VOC	18 or 25A	Within 270 operating days under this alternate scenario and every 365 operating days thereafter.
CB-16	VOC	18 or 25A	Within 180 operating days under this alternate scenario and every 365 operating days thereafter.

The testing shall be performed while the reactors are operating under the alternate CaBr scenario.

35. The permittee shall conduct stack testing for methyl bromide at either SN-CB-02 or SN-CB-16. The test for MeBr shall be conducted on whichever source (SN-CB-02 or SN-CB-16) is involved in the alternate CaBr operating scenario, as described above, at the time of testing. The test shall be performed within 180 operating days of this alternate scenario, and within every 730 operating days thereafter, using EPA Reference Method 18. [Regulation No. 18 §18.1002 and A.C.A §8-4-203 as referenced by §8-4-304 and §8-4-311]

Diethylchlorothiophosphate (DECTP) Production

Raw materials and solvent are added to the reactors. Two by-products are formed during the main reactions: H₂S and HCl. The H₂S evolved during initial stages of the batch is compressed and stored. A portion of this H₂S is later recycled back to the reactor, and the remainder is sent to the sulfur plant to be converted to elemental sulfur. The HCl evolved is scrubbed with water, and the aqueous HCl is sent to a storage tank in the bromine area. Both H₂S and HCl are vented from the reactor during the latter part of the batch. The HCl is scrubbed with water and the H₂S is neutralized in a vent scrubber.

The crude product is centrifuged to remove elemental sulfur. The sulfur is melted, and a vacuum is applied to remove organics. The sulfur is transferred to the sulfur trailer and finally to the landfill. The sulfur trailer vents to the vent gas oxidizer (VGO, SN-DE-21).

The crude product is purified via distillation. The solvent is recovered and recycled, and the purified product is either sent directly to bulk product storage, or further purified before final storage. The vent gases and liquid wastes from the purification process are neutralized with caustic. The vent gases from the final purification operation are scrubbed in a packed aqueous scrubber. The aqueous waste is disposed of by deep well injection, and the organic waste is sent off site.

In the event of an emergency, gases are vented to the flare system (SN-DE-17), to be combusted before their release to the atmosphere. Any liquids or solids discharged from the reactor or crystallizer are routed to the blowdown pit (SN-DE-18), where they are burned.

The vent gases from raw material storage, product storage, and waste oil storage are routed through the VGO, where 99% of the vent gases are destroyed before being released to the atmosphere.

A product purification area is in operation. Emissions are controlled by a reactive vent scrubber, employing an aqueous solution of sodium hydroxide. The vent from this operation is routed to the VGO during normal operation; however, during VGO downtime, exhausts are designated as SN-DE-23. VGO downtime is limited to a maximum of 876 hours per year.

Compliance with permitted emission rates shall be demonstrated through stack testing, parametric monitoring, recordkeeping, and reporting requirements.

Specific Conditions

36. The permittee shall not exceed the emission rates set forth in the following table.
 [Regulation No. 19 §19.501 *et seq.* and 40 CFR Part 52, Subpart E]

SN-#	Description	Pollutant	lb/hr	tpy
DE-01	Ethanol Storage Tank**	Routed to SN-DE-28		
DE-02	Toluene Storage Tank			
DE-03	Chaser Storage Tank			
DE-04	Crude Product Storage Tank	VOC	8.96	3.93*
DE-06	Product Rundown Storage Tank	VOC	0.62	0.28*
DE-07	Product Rundown Storage Tank	VOC	0.62	0.28*

SN-#	Description	Pollutant	lb/hr	tpy
DE-08	Product Rundown Storage Tank	VOC	0.62	0.28*
DE-09	Product Bulk Storage Tank	Routed to SN-DE-28		
DE-10	Product Rundown Storage Tank	VOC	0.62	0.28*
DE-11	Chaser Bulk Storage, T-302	VOC	0.39	1.71
DE-12	Recovered Oil Storage Tank	VOC	0.20	0.10*
DE-17	Process Safety Flare, Emergency Use Only, XF-2461 (Continuous Pilot)	PM ₁₀	0.01	0.05
		SO ₂	0.06	0.05
		VOC	0.01	0.05
		CO	0.04	0.18
		NO _x	0.05	0.22
DE-18	Reactor Safety Blowdown System Vent Line (Continuous Pilot)	PM ₁₀	0.01	0.05
		SO ₂	0.01	0.05
		VOC	0.01	0.05
		CO	0.07	0.31
		NO _x	0.10	0.44
DE-19	Sulfur Trailer Knockout Drum	VOC	8.00	3.50*
DE-20	Isopropanol Storage Tank	VOC	9.40	4.10*
DE-21	Vent Gas Oxidizer (VGO) Basic Environmental Eng., Inc. Model T075 (99.0% efficient)	PM ₁₀	2.20	9.64
		SO ₂	7.00	30.70
		VOC	0.60	2.63
		CO	2.00	8.76
		NO _x	1.00	4.38
DE-22	DECTP Fugitive Emissions	VOC	9.40	41.10
DE-23	DECTP Purification Process	VOC	2.83	1.24*
DE-24	MC-2431, Centrifuge	VOC	12.70	5.60*
DE-25	Product Storage Tank	Routed to SN-DE-28		
DE-28	Vent Header	VOC	23.60	10.40*

* See Specific Condition #39

** An alternate operating scenario exists for this source. The tank is used as additional storage for ADMA brine or any non-HAP material with a vapor pressure less than 0.0120 psia. (Specific Condition #56)

37. The permittee shall not exceed the non-criteria emission rates set forth in the following table. [Regulation No. 18 §18.801 and A.C.A §8-4-203 as referenced by §8-4-304 and §8-4-311]

SN-#	Description	Pollutant	lb/hr	tpy
DE-02	Toluene Storage Tank	Routed to SN-DE-28		
DE-03	Chaser Storage Tank			
DE-04	Crude Product Storage Tank	Toluene	8.80	3.85*
		Methyl Naphthalene	0.01	0.01*
DE-11	Chaser Bulk Storage, T-302	Methyl Naphthalene	0.12	0.53
DE-12	Recovered Oil Storage Tank	Toluene	0.04	0.02*
		Methyl Naphthalene	0.01	0.01*

SN-#	Description	Pollutant	lb/hr	tpy
DE-17	Process Safety Flare, Emergency Use Only, XF-2461 (Continuous Pilot)	PM	0.01	0.05
DE-18	Reactor Safety Blowdown System Vent Line (Continuous Pilot)	PM	0.01	0.05
DE-19	Sulfur Trailer Caustic Drum	Toluene	8.00	3.50*
DE-21	Vent Gas Oxidizer (VGO) Basic Environmental Eng., Inc., Model T075 (99% efficient)	PM	2.20	9.64
		Cl ₂	0.30	1.31
		HCl	6.72	29.4
		Toluene	0.40	1.76
		Ethylene Chloride	0.20	0.88
DE-22	DECTP Fugitive Emissions	Cl ₂	0.05	0.22
		HCl	1.00	4.40
		Toluene	0.55	2.40
		Methyl Naphthalene	1.13	5.00
DE-23	DECTP Purification Process	HCl	0.34	0.15*
		Chloroethane	2.60	1.14*
DE-24	MC-2431, Centrifuge	Toluene	12.70	5.60*
DE-28	Vent Header	Toluene	11.00	4.82*
		Methyl Naphthalene	0.09	0.04*

* See Specific Condition #39

38. The following sources shall not exceed 5% opacity: SN-DE-17, SN-DE-18, SN-DE-21, and SN-DE-23. [Regulation No. 18 §18.501 and A.C.A §8-4-203 as referenced by §8-4-304 and §8-4-311]
39. All sources marked with an asterisk (*) in the tables following Specific Conditions #36 and #37 shall be vented to the Vent Gas Oxidizer (VGO), SN-DE-21, under Scenario I. Scenario I may be operated 8760 hours per year. However, in the event of a VGO shutdown (Scenario II), the marked sources shall be permitted individually for the emissions shown. Scenario II, an alternate operating scenario, shall only be in effect when the VGO is down, and shall not exceed 876 hours per year. [Pursuant to §19.705, 40 CFR Part 70.6, and A.C.A. §8-4-203 as referenced by §8-4-304 and §8-4-311]
40. The permittee shall keep monthly records of operating hours for Scenario II (“VGO Down”). The records shall be updated by the 5th day of the month following the recorded month, and shall include a rolling twelve-month total of the operating hours. [Regulation No. 19 §19.705 and 40 CFR Part 52, Subpart E]
41. RESERVED
42. RESERVED
43. Operation of the Emergency Flare (SN-DE-17) is authorized for emergency and maintenance use only. Operation of this control device for emergency use shall not exceed 30 minutes, in the aggregate, during any 24-hour period. Any emergency use

exceeding this requirement shall be recorded as an upset condition, in accordance with General Provision 8 of this permit. Operation for maintenance use shall not exceed 24 hours per year. Flare operation time logs shall be required for both emergency events and maintenance operations. Calculated emission records shall only be required for emergency events. All aforementioned documentation shall be updated on an as-performed basis, maintained on site, and made available to Department personnel upon request. [40 CFR Part 70.6 and A.C.A. §8-4-203 as referenced by §8-4-304 and §8-4-311]

44. Operation of the Blowdown Pit (SN-DE-18) is authorized for emergency use only. Any time this source is activated, the permittee shall report the occurrence as an upset condition, in accordance with General Provision 8. [40 CFR Part 70.6 and A.C.A. §8-4-203 as referenced by §8-4-304 and §8-4-311]
45. The Vent Gas Oxidizer (SN-DE-21) shall be designed and operated such that the VOC emissions routed to it are maintained at a minimum combustion zone temperature of 1400°F. The combustion zone temperature shall be continuously monitored by a monitoring and recording device that is operated, calibrated, and maintained according to the manufacturer's specifications and recommendations for use. [Regulation No. 19 §19.703, 40 CFR Part 52, Subpart E, and A.C.A. §8-4-203 as referenced by §8-4-304 and §8-4-311]
46. The permittee shall maintain an operating log for the Vent Gas Oxidizer showing all periods during which the minimum temperature is not maintained while operating in the "VGO Up" scenario (Scenario I). The permittee shall report all such occurrences in accordance with General Provision 8. [Regulation No. 19 §19.705 and 40 CFR Part 52, Subpart E]
47. RESERVED
48. The permittee shall keep all applicable benzene waste stream records as outlined by §61.356 (b). [Regulation No. 19 §19.304 and 40 CFR Part 61, Subpart FF (see Appendix A)]
49. The permittee shall comply with all applicable benzene waste stream reporting requirements as outlined by §61.357 (c). [Regulation No. 19 §19.304 and 40 CFR Part 61, Subpart FF]
50. The permittee shall measure and record the liquid flow rate of the scrubber media at SN-DE-23 every four hours. These records shall be kept on site and made available to Department personnel upon request. The flow value measured at the most recent satisfactory test event shall be established as minimum for purposes of continuous compliance until the next test is performed. [Regulation No. 19 §19.703, 40 CFR Part 52, Subpart E, and A.C.A. §8-4-203 as referenced by §8-4-304 and §8-4-311]
51. The permittee shall measure and record the caustic concentration of the scrubber media used for SN-DE-23 prior to each caustic changeout. The caustic shall be changed at SN-DE-23 at least once every two operating hours. Each caustic changeout shall be logged as performed. Both caustic strength and changeout records shall be kept on site and made

Albemarle Corporation
Permit #: 0762-AOP-R16
AFIN: 14-00028

available to Department personnel upon request. [Regulation No. 19 §19.703, 40 CFR Part 52, Subpart E, and A.C.A. §8-4-203 as referenced by §8-4-304 and §8-4-311]

52. RESERVED

53. RESERVED

54. The permittee shall test SN-DE-21 for VOC using EPA Reference Method 18 or 25A. The testing shall be conducted in 2005 and every five years thereafter. The testing shall be coordinated in advance with the Compliance Inspector Supervisor. [Regulation No. 19 §19.702 and 40 CFR Part 52, Subpart E]

55. The permittee shall calculate worst-case lb/hr emissions for toluene and DECTP at SN-DE-24 every 100 hours of operation. This applies only to operation during the VGO downtime scenario. These calculations shall be kept on site and made available to Department personnel upon request. [Regulation No. 18 §18. and A.C.A. §8-4-203 as referenced by §8-4-304 and §8-4-311]

Alkyl Amines Process

Alkyl amines are produced by the reaction of primary or secondary amines with alkyl bromides in the presence of sodium hydroxide.

The raw materials used in the production of alkyl amines are primary and/or secondary amines, which are purchased as raw materials from an outside supplier, and olefins. The olefins are selected from the group of olefins that have eight or more carbon atoms in their structure. These olefins are also purchased from off-site suppliers. The olefins are converted to an alkyl bromide by reaction with hydrogen bromide produced on-site. The alkyl bromides thus produced are reacted with a primary and/or secondary amine in the presence of sodium hydroxide to produce the desired product alkyl amine. The choice of the starting amine(s) and alkyl bromide(s) determines the structure of the product, which is a secondary or tertiary alkyl amine. The product amine is thus “tailored” to the needs of the user. Product amines are, by nature of the production process, statistical distributions of alkyl amines, depending on the initial raw materials.

By-products from this process are mixtures of alkyl amines and olefins and an aqueous solution of sodium bromide. The by-products can often be sold as product, depending on market demand. By-products that cannot be sold or internally transferred as product are disposed off-site.

By-product sodium bromide brines are recycled to the bromine plant for conversion to bromine. Bromine from the bromine plant is the ultimate source of the hydrogen bromide used to make the alkyl bromides mentioned above.

Hydrogen bromide is produced within the Alkyl Amines facility in an integrated process by directly reacting hydrogen and bromine. Part of this hydrogen bromide is used to produce hydrobromic acid, which may be used on-site or transferred off-site as product.

Under the product recovery process, the bottoms waste stream from the ADMA product distillation column is collected in a tank and sent batchwise to a wiped film evaporator, where the product is flashed overhead and condensed in a heat exchanger. The condensate drains by gravity to a collection drum, from which it would be pumped to a storage tank (D-1534). Recovered material would be pumped to existing ADMA storage tanks. Evaporator bottoms would be sent to the existing waste tank.

The only emission point affected by this scenario is the tank’s vent, SN-AD-37. The emissions involved are volatile organic compounds, at a rate of 0.05 lb/hr and 0.17 ton/yr. The volatile emissions are not considered hazardous air pollutants.

Emission control devices for the Alkyl Amines process include the Acid Vent Scrubber (SN-AD-05), the Emergency Flare (SN-AD-26), and the Alkyl Amines Area Odor Control Vent Gas Oxidizer (SN-AD-35).

Compliance with permitted emission rates shall be demonstrated through stack testing, parametric monitoring, record keeping, and reporting requirements.

Specific Conditions

56. The permittee shall not exceed the emission rates set forth in the following table.
 [Regulation No. 19 §19.501 *et seq.* and 40 CFR Part 52, Subpart E]

SN-#	Description	Pollutant	lb/hr	tpy
AD-01	Olefins Storage Tank #1: T-1501	VOC	0.16	0.71
AD-02	Olefins Storage Tank #2: T-1503	VOC	0.16	0.71
AD-03	Alkyl Amines Storage Tank: T-1502	VOC	0.26	1.14
AD-05	Acid Vent Scrubber: C-1531 (CD-AD-05, also formerly SB-03).	VOC	0.20	0.88
AD-07	Alkyl Amine Rundown Tank: T-1534A	VOC	0.05	0.22
AD-08	Alkyl Amines Rundown Tank: T-1534B	VOC	0.05	0.22
AD-09	Alkyl Amines Rundown Tank: T-1534C	VOC	0.05	0.22
AD-10	Alkyl Amines Storage Tank: T-1537	VOC	0.26	1.14
AD-11	Alkyl Amines Storage Tank: T-1535	VOC	0.26	1.14
AD-12	Alkyl Amines Storage Tank: T-1536	VOC	0.26	1.14
AD-13	Alkyl Amines Storage Tank: T-1538	VOC	0.26	1.14
AD-14	Alkyl Amines Storage Tank: T-1539	VOC	0.26	1.14
AD-15	Alkyl Amines Storage Tank: T-1540	VOC	0.26	1.14
AD-17	Alkyl Amines Blend Tank: D2427-A	VOC	0.26	1.14
AD-18	Sodium Bromide Brine for Recycle: T-1409	VOC	0.26	1.14
AD-20	Olefins Storage Tank: T-1405A	VOC	0.16	0.71
AD-21	Olefins Storage Tank: T-1405B	VOC	3.45	15.08
AD-23	Alkyl Amines Storage Tanks: T-1408 A, B	VOC	0.03	0.14
AD-24	Product Storage: Alkyl Amines: T-1542	VOC	0.26	1.14
AD-25	Product Storage: Alkyl Amines: T-1543	VOC	0.26	1.14
AD-26	ADMA Flare <i>Alkyl Amines Scenario Emergency Flaring Events</i>	PM ₁₀	0.12	0.07
		SO ₂	0.06	0.15
		VOC	0.62	0.16
		CO	0.06	0.15
		NO _x	0.38	0.20
AD-26	ADMA Flare <i>Alkyl Amines Scenario Non-Emergency Flaring Events</i>	PM ₁₀	0.80	0.10
		SO ₂	0.10	0.10
		VOC	48.50	0.60
		CO	18.90	0.30
		NO _x	3.50	0.10
AD-27	Recycle Brine Storage Tank: T-1407	VOC	0.26	1.14
AD-28	Stripped Recycle Brine Storage Tank: T-1541	VOC	0.08	0.35
AD-29	Stripped Recycle Brine Tank: T-1544	VOC	0.08	0.35

SN-#	Description	Pollutant	lb/hr	tpy
AD-35	Alkyl Amines Area Odor Control Vent Gas Oxidizer (VGO)	PM ₁₀	0.22	0.97
		SO ₂	0.09	0.40
		VOC	1.22	5.35
		CO	0.06	0.27
		NO _x	0.70	3.07
AD-36	Fugitive Emissions, Including Product Loading	VOC	4.13	18.14
AD-37	ADMA Condensate Collection Tank	VOC	0.05	0.17
AD-39	ADMA Brine Load Out***	VOC*	0.10	0.40
AD-40	Mixed ADMA Final Product Storage Tank, T-9965	VOC	0.26	1.14
AD-41	Mixed ADMA Final Product Storage Tanks, T-1408A and T-1408B	VOC	0.52	2.28
DE-01	ADMA Brine Storage Tank**	VOC*	0.50	2.10
TB-11	ADMA Brine Storage Tank**	VOC*	0.10	0.40

* ADMA brine or any non-HAP material with a vapor pressure less than or equal to 0.0120psia may be stored and loaded out.

** ADMA brine service is not the primary operating scenario for these sources. The primary operating scenario for DE-01 and TB-11 are DECTP Production and MeBr Primary Production Scenario, respectively.

*** AD-39 is the emissions from the loadout of both DE-01 and TB-11 in ADMA brine service.

57. The permittee shall not exceed the non-criteria emission rates set forth in the following table. [Regulation No. 18 §18.801 and A.C.A §8-4-203 as referenced by §8-4-304 and §8-4-311]

SN-#	Description	Pollutant	lb/hr	tpy
AD-05	Acid Vent Scrubber: C-1531 (CD-AD-05, also formerly SB-03)	Br ₂ +HBr	0.05	0.22
		HCl	0.10	0.50
AD-26	ADMA Flare <i>Alkyl Amines Scenario Emergency Flaring Events</i>	PM	0.12	0.07
		Br ₂	0.02	0.01
AD-26	ADMA Flare <i>Alkyl Amines Scenario Non-Emergency Flaring Events</i>	PM	0.80	0.10
AD-35	Alkyl Amines Area Odor Control Vent Gas Oxidizer (VGO)	PM	0.22	0.97
		Br ₂	0.03	0.14
AD-36	Fugitive Emissions, Including Product Loading	Br ₂ +HBr	3.76	16.47
		Ethylene Glycol	0.06	0.30

58. The following sources shall not exceed 5% opacity: SN-AD-05, SN-AD-26 and SN-AD-35. [Regulation No. 18 §18.501 and A.C.A. §8-4-203 as referenced by §8-4-304 and §8-4-311]

59. The permittee shall document the time SN-DE-01 and SN-TB-11 are in ADMA brine service and calculate the emissions from each tank and loadout (SN-AD-39). The permittee shall include in the documentation the time and date for the beginning and end, the vapor pressure of the material, and VOC emitted for each period of ADMA brine

- service. These records shall be kept on site and made available to Department personnel upon request. [Regulation No. 19 §19.705 and 40 CFR Part 52, Subpart E]
60. The permittee shall maintain readily accessible records which document that storage of C8 olefin at SN-AD-21 does not exceed 4380 hours per rolling 12-month time frame. [Regulation No. 19 §19.705 and 40 CFR Part 52, Subpart E]
 61. Operation of the Emergency Flare (SN-AD-26) for emergency use shall not exceed 30 minutes, in the aggregate, during any 24-hour period. See Specific Condition #62 for operation of the flare during non-emergency events. [Regulation No. 19 §19.705, 40 CFR Part 70.6, and A.C.A. §8-4-203 as referenced by §8-4-304 and §8-4-311]
 62. The permittee shall maintain records of each venting event to SN-AD-26, both emergency and non-emergency. Acceptable non-emergency events are cleaning and maintenance of equipment where emissions of such activities are routed to the flare. These records shall contain the date, time, reason, duration of each event, and total duration per rolling twelve month period. The permittee shall calculate the emissions for each event in order to demonstrate compliance with the limits in Specific Conditions #56 and #57. These records shall be updated following each event, kept onsite, and made available to Department personnel upon request. Any emergency use exceeding the requirement set forth in the previous condition shall be an upset condition, in accordance with General Provision 8 of this permit. [Regulation No. 19 §19.705 and 40 CFR Part 52, Subpart E]
 63. The permittee shall test SN-AD-05 for VOC in 2006 and every five years thereafter. The testing shall be performed in accordance with EPA Reference Method 18 or 25A. [Regulation No. 19 §19.702 and 40 CFR Part 52, Subpart E]
 64. The permittee shall measure and record the flow rate of the scrubber media at SN-AD-05 every four hours. These records shall be kept on site and made available to Department personnel upon request. The flow value measured at the most recent satisfactory test event shall be established as minimum for purposes of continuous compliance until the next test is performed. [Regulation No. 19 §19.703, 40 CFR Part 52, Subpart E, and A.C.A. §8-4-203 as referenced by §8-4-304 and §8-4-311]
 65. The permittee shall measure and record the caustic concentration of the scrubber media used for SN-AD-05 once per twelve-hour shift. Each caustic changeout shall be logged as performed. Both caustic strength and changeout records shall be kept on site and made available to Department personnel upon request. The caustic concentration and changeout schedule corresponding to the most recent satisfactory test event shall be established as minimum for purposes of continuous compliance until the next test is performed. [Regulation No. 19 §19.703, 40 CFR Part 52, Subpart E, and A.C.A. §8-4-203 as referenced by §8-4-304 and §8-4-311]
 66. The permittee shall test SN-AD-35 for the following compounds in 2002 and every two years thereafter. Applicable test methods are listed in the right column of the table. [Regulation No. 19 §19.702 and 40 CFR Part 52, Subpart E]

Albemarle Corporation
 Permit #: 0762-AOP-R16
 AFIN: 14-00028

Pollutant	EPA Reference Method
PM ₁₀	5
SO ₂	6C
VOC	18 or 25A
CO	10B
NO _x	7E

67. The permittee shall operate and maintain a device to continuously monitor and record the temperature of the exhaust from the vent incinerator (SN-AD-35). This temperature shall be maintained at or above 1500°F during those periods when any process gases are being incinerated. [Regulation No. 19 §19.703, 40 C FR Part 52, Subpart E, and A.C.A. §8-4-203 as referenced by §8-4-304 and §8-4-311]
68. The permittee shall test SN-AD-05 and SN-AD-35 for the following compounds in calendar year 2002 and every five years thereafter. Applicable test methods are listed in the right column of the table. [Regulation No. 18 §18.1002 and A.C.A §8-4-203 as referenced by §8-4-304 and §8-4-311]

Source	Pollutant	EPA Reference Method
SN-AD-05	HBr	26A
SN-AD-35	Br ₂	26A

Alternative test methods may be submitted to the Compliance Inspector Supervisor at least 30 days in advance of planned testing. These methods must receive Department approval prior to the testing event.

Alkyl Bromides Process

Alkyl bromides (RBr) can be produced by the action of hydrogen bromide (HBr) on the corresponding alkyl chloride (RCl). An example is to react HBr with dichloromethane (commonly called methylene chloride) to produce a mixture of bromochloromethane (BCM) and dibromomethane (methylene dibromide, MDB). The product mixture can be separated by distillation and stored. The alkyl bromide product finds use on the plant site as a process solvent, and is sold into various markets.

The alkyl chlorides used as raw materials are low boiling liquids. The alkyl bromide products are higher boiling liquids, and can thus be separated by batch distillation from the other constituents in the product mixture. The hydrogen bromide used as a raw material is a gas at ordinary temperatures and pressures.

Emission control at the Alkyl Bromides Process is facilitated by a carbon bed adsorption system, which vents at SN-AB-15.

Compliance with permitted emission rates shall be demonstrated through parametric monitoring, record keeping, and reporting requirements.

Specific Conditions

69. The permittee shall not exceed the emission rates set forth in the following table. [Regulation No. 19 §19.501 *et seq.* and 40 CFR Part 52, Subpart E]

SN-#	Description	Pollutant	lb/hr	tpy
AB-15	Emission Control: Carbon Bed Adsorbers (CB-304 and CB-05)	VOC	1.20	5.30
AB-16	Alkyl Bromide Fugitive Emissions	VOC	7.50	32.90

70. The permittee shall not exceed the non-criteria emission rates set forth in the following table. [Regulation No. 18 §18.801 and A.C.A §8-4-203 as referenced by §8-4-304 and §8-4-311]

SN-#	Description	Pollutant	lb/hr	tpy
AB-15	Emission Control: Carbon Bed Adsorbers (CB-304 and CB-05)	Dichloromethane	0.24	1.10
AB-16	Alkyl Bromide Fugitive Emissions	Dichloromethane	1.50	6.60

71. All methylene chloride/water heat exchangers shall be operated with the minimum pressure on the cooling side at least 35 kPa greater than the maximum pressure on the process side. [Regulation No. 19 §19.304 and 40 CFR Part 63, Subpart F, 63.104(a)(1) (see Appendix A)]
72. The pressure differential between the cooling and process sides of the methylene chloride/water heat exchangers shall be measured once daily and recorded in a log. This record shall be kept on site as a verification of compliance with 63.104(a)(1), and shall be made available to Department personnel upon request. [Regulation No. 18 §18.1003 and A.C.A §8-4-203 as referenced by §8-4-304 and §8-4-311]

73. A maintenance wastewater procedure shall be prepared and followed for this process. Details of the requirements of this procedure are contained in 40 CFR 63.105(b) through (e). [Regulation No. 19 §19.304 and 40 CFR Part 63, Subpart F, 63.105]
74. Total Resource Effectiveness (TRE) calculations shall be performed and maintained for all process vents (all Subpart G vents in this process area are Group 2 vents). The TRE calculations shall be updated whenever process changes are made. If the TRE index value is less than or equal to 4.0, the permittee shall follow the procedures outlined in 40 CFR 63.115(d) (1)(ii). [Regulation No. 19 §19.304 and 40 CFR Part 63, Subpart G, 63.115(d)(1)(i) (see Appendix A)]
75. The following records shall be maintained: [Regulation No. 19 §19.304 and 40 CFR Part 63, Subpart G]
 - a. TRE calculations and all backup information [63.117(b)].
 - b. Records of process changes and TRE recalculations [63.118(c)(1)&(2)].
 - c. Records of MeCl₂ storage vessel dimensions and capacity [63.123(a)].
76. The permittee shall submit reports of compliance status and process changes as outlined in paragraphs 63.117(b), 63.118(g), and 63.118(h). [Regulation No. 19 §19.304 and 40 CFR Part 63, Subpart G]
77. All equipment in MeCl₂ service shall comply with the requirements of the National Emission Standards for Organic Hazardous Air Pollutants for Equipment Leaks, as outlined in paragraphs 63.160 through 63.182. These sections specify standards for pumps in light liquid service, compressors, pressure relief devices in gas/vapor service, sampling connection systems, open-ended valves or lines, and valves in gas/vapor service and light liquid service. [Regulation No. 19 §19.304 and 40 CFR Part 63, Subpart H]
78. The permittee shall follow the recordkeeping and reporting procedures for equipment leaks as outlined in paragraphs 63.181 and 63.182. [Regulation No. 19 §19.304 and 40 CFR Part 63, Subpart H (see Appendix A)]
79. RESERVED
80. The control equipment maintained on source SN-AB-15 shall be comprised of a minimum of two carbon adsorption units, each having a 2' diameter and a 4.7' column length. The carbon shall be regenerated once per 12 hours of operating time. Only steam shall be used to regenerate the carbon. Upon completion of regeneration, only air shall be used to cool the carbon. The carbon shall be replaced as needed, but no less frequently than every 10,220 hours of actual source operation. [Regulation No. 19 §19.705, 40 CFR Part 70.6, A.C.A. §8-4-203 as referenced by §8-4-304 and §8-4-311]
81. Records of all carbon regeneration and replacement shall be maintained, updated as performed, and made available to Department personnel upon request. [Regulation No. 19 §19.705 and 40 CFR Part 52, Subpart E]

NC-12 Flame Retardant Process

Flame retardant products are produced by reacting diphenyl oxide or other similar raw materials with bromine. This reaction forms hydrogen bromide as a by-product. The hydrogen bromide is purified and stored under pressure, or absorbed in water to make hydrobromic acid. The flame retardant product is a solid. Dust generated by the handling and packaging of the product is controlled by fabric filters (SN-DB-05, SN-DB-06).

Back-up Scrubber (SN-DB-17) is used during periods when Vent Scrubber (SN-DB-01) is down. The Back-up Scrubber controls emissions resulting from the nitrogen purge system at the NC-12 HBr compression equipment.

The NC-12 production unit has an alternate operating scenario to produce NC-15 product. The scrubber (SN-DB-19) follows the product dryer filter (SN-DB-04). When producing NC-15 product, the emissions from the product dryer will be routed through SN-DB-04 to SN-DB-19. For all other permitted operating scenarios, the emissions may vent directly from SN-DB-04 or be routed, although not required, to SN-DB-19 for additional control.

Compliance with permitted emission rates shall be demonstrated through stack testing, parametric monitoring, and record keeping requirements.

Specific Conditions

82. The permittee shall not exceed the emission rates set forth in the following table.
 [Regulation No. 19 §19.501 *et seq.* and 40 CFR Part 52, Subpart E]

SN-#	Description	Pollutant	lb/hr	tpy
DB-01	Vent Scrubber	VOC	0.28	1.23
DB-04	Product Dryer Filter*	PM ₁₀	1.80	7.90
		SO ₂	0.14	0.61
		VOC	0.96	4.20
		CO	3.60	15.80
		NO _x	1.60	7.00
DB-05	Product Vent Filter Silo Baghouse	PM ₁₀	0.30	1.30
DB-06	Product Vent Filter Silo Baghouse	PM ₁₀	0.30	1.30
DB-07	Raw Material Storage Tank	VOC	0.10	0.44
DB-08	Product Vent Filter	PM ₁₀	1.10	4.80
DB-10	Ethylene Glycol Storage Tank	VOC	0.01	0.04
DB-16	NC-12 Fugitive Emissions	VOC	1.40	6.10
DB-18	Receiving Baghouse	PM ₁₀	0.30	1.40
DB-19	Product Dryer Scrubber	PM ₁₀	0.98	4.30
		SO ₂	0.14	0.61
		VOC	0.96	4.20
		CO	3.60	15.80
		NO _x	1.60	7.00
DB-20	DPE Storage Tank, D-2515 <i>During NC-15 Production Alt. Op Scenario</i>	VOC	0.32	1.41

SN-#	Description	Pollutant	lb/hr	tpy
DB-22	NC-12 Central Vacuum System	PM ₁₀	0.10	0.20

* SN-DB-04 is permitted to route emissions to SN-DB-19 for all NC-12 operating scenarios. However, operation of SN-DB-19 is only required for NC-15 production.

83. The permittee shall not exceed the non-criteria emission rates set forth in the following table. [Regulation No. 18 §18.801 and A.C.A §8-4-203 as referenced by §8-4-304 and §8-4-311]

SN-#	Description	Pollutant	lb/hr	tpy
DB-01	Vent Scrubber	Br ₂ +HBr	0.44	1.93
DB-04	Product Dryer Filter*	PM	1.80	7.90
		Br ₂ +HBr	1.65	7.20
DB-05	Product Vent Filter Silo Baghouse	PM	0.30	1.30
DB-06	Product Vent Filter Silo Baghouse	PM	0.30	1.30
DB-07	Raw Material Storage Tank	HCl	5.10	0.50
DB-08	Product Vent Filter	PM	1.10	4.80
DB-10	Ethylene Glycol Storage Tank	Ethylene Glycol	0.01	0.04
DB-16	NC-12 Fugitive Emissions	Br ₂ +HBr	5.81	25.44
DB-17	Back-up Water Scrubber	Br ₂ +HBr	0.10	0.44
DB-18	Receiving Baghouse	PM	0.30	1.40
DB-19	Product Dryer Scrubber	PM	0.98	4.30
		Br ₂ +HBr	1.00	4.38
DB-22	NC-12 Central Vacuum System	PM	0.10	0.20

* SN-DB-04 is permitted to route emissions to SN-DB-19 for all NC-12 operating scenarios. However, operation of SN-DB-19 is only required for NC-15 production.

84. The following sources shall not exceed 5% opacity: SN-DB-01, SN-DB-04, SN-DB-05, SN-DB-06, SN-DB-08, SN-DB-17, SN-DB-18, SN-DB-19, and SN-DB-22. [Regulation No. 18 §18.501 and A.C.A §8-4-203 as referenced by §8-4-304 and §8-4-311]
85. The permittee shall demonstrate compliance with the HCl limits for SN-DB-07 by maintaining records of the concentration of water in each transfer of DPO and calculating on a monthly basis a twelve month rolling total of HCl generated. These calculations shall be completed by the 15th of the following month, shall be kept on site, and shall be made available to Department personnel upon request. The permittee may at their discretion conduct the sampling or rely upon other records such as bills of lading that show the concentration of water in the DPO received. [Regulation No. 19 §19.304 and 40 CFR §63.2465(b)]
86. The permittee shall test the following sources for the listed compounds in calendar year 2002 for SN-DB-01 and SN-DB-04 and in 2007 for SN-DB-19 and every five years thereafter. Test methods are listed in the following table. [Regulation No. 18 §18.1002 and A.C.A §8-4-203 as referenced by §8-4-304 and §8-4-311]

Source	Compound	EPA Reference Method	Test Criteria / Operating Scenario
SN-DB-01	Br ₂	26A	NC-12 or NC-15 Production
SN-DB-04	Br ₂	26A	NC-12 Production

Source	Compound	EPA Reference Method	Test Criteria / Operating Scenario
SN-DB-19	Br ₂	26A	NC-12 or NC-15 Production

Alternative test methods may be submitted to the Compliance Inspector Supervisor at least 30 days in advance of planned testing. These methods must receive Department approval prior to the testing event.

87. The permittee shall perform a visual inspection of the pumps driving the scrubber media at SN-DB-01 at least once per day, to ensure that sufficient flow is maintained. The permittee shall also perform visual inspection of the pumps driving the scrubber media at SN-DB-19 at least once per day for days when SN-DB-19 is in operation, to ensure that sufficient flow is maintained. Inspection results shall be recorded in a log. These records shall be kept on site and made available to Department personnel upon request. The visual inspection method shall be confirmed by the most recent satisfactory stack test for purposes of continuous compliance until the next test is performed. [Regulation No. 18 §18.1003 and A.C.A. §8-4-203 as referenced by §8-4-304 and §8-4-311]
88. The permittee shall measure and record the caustic concentration of the scrubber media used for SN-DB-01 at least once per twelve-hour shift. The caustic shall be replaced when the concentration falls below 5% strength. [Regulation No. 19 §19.703, 40 CFR Part 52, Subpart E, and A.C.A. §8-4-203 as referenced by §8-4-304 and §8-4-311]
89. The permittee shall perform monthly calculations for worst-case lb/hr and ton/month emissions of Br₂ and HBr at SN-DB-04 and SN-DB-19. These calculations shall be based upon most recent available test data. These calculations shall be completed by the 15th day of the following month, and shall be kept on site and made available to Department personnel upon request. [Regulation No. 18 §18.1004 and A.C.A. §8-4-203 as referenced by §8-4-304 and §8-4-311]
90. The permittee shall be limited to drying 150 tanks of diphenyl oxide (DPO, stored at SN-DB-07) per rolling 12-month period. Records shall be maintained to demonstrate compliance with this limit. The records shall be updated weekly, maintained on site, and made available to Department personnel upon request. [Regulation No. 18 §18.1004 and A.C.A. §8-4-203 as referenced by §8-4-304 and §8-4-311]

NC-14 Flame Retardant Production

Multiple alternate operating scenarios exist for the NC-14 process. The following table lists these additional operating scenarios. Compliance with permitted emission rates in the NC-14 process area shall be demonstrated through stack testing, parametric monitoring, and record keeping requirements. This unit no longer produces MeBr.

Alternate Operating Scenario	Reference Page
NC-22 Production	74
95ND141/Stabrom 909 Production	92
NaBr Production	95
EtBr Production	96

Specific Conditions

91. The permittee shall not exceed the emission rates set forth in the following table. Compliance with this condition shall be demonstrated by the ADMA product being stored having a molecular weight greater than or equal to 157.3 lb/lb mol. Documentation of ADMA material type and molecular weight shall be kept on site and made available to Department personnel upon request. [Regulation No. 19 §19.501 *et seq.* and 40 CFR Part 52, Subpart E]

SN-#	Description	Pollutant	lb/hr	tpy
TB-01	ADMA Storage Tank	VOC	7.20	7.20

- 92. RESERVED
- 93. RESERVED
- 94. RESERVED
- 95. RESERVED
- 96. RESERVED
- 97. RESERVED
- 98. RESERVED
- 99. RESERVED
- 100. RESERVED
- 101. RESERVED
- 102. RESERVED
- 103. RESERVED
- 104. RESERVED

Albemarle Corporation
Permit #: 0762-AOP-R16
AFIN: 14-00028

Conditions for All Production Scenarios

105. The following sources shall not exceed 5% opacity: SN-TB-04, SN-TB-08, SN-TB-14. [Regulation No. 18 §18.501 and A.C.A. §8-4-203 as referenced by §8-4-304 and §8-4-311]
106. The permittee may not produce methyl bromide at any time in a control period (except that are transformed or destroyed domestically or by a person of another party) in excess of the amount of unexpended production allowances or unexpended Article 5 allowances held. [Regulation No. 19 §19.304 and 40 CFR Part 82, Subpart A, Paragraph 82.4(a) (see Appendix A)]
107. The permittee may not produce or (except for transshipments, heels, or used controlled substances) import methyl bromide, at any time in a control period (except for controlled substances that are transformed or destroyed), in excess of unexpended consumption allowances held. [Regulation No. 19 §19.304 and 40 CFR Part 82, Subpart A, Paragraph 82.4(c)]
108. Production and consumption allowances may be adjusted by the procedures in paragraphs 82.9, 82.10, 82.11, and 82.12. [Regulation No. 19 §19.304 and 40 CFR Part 82, Subpart A]
109. The permittee shall conform with the record keeping and reporting practices for methyl bromide as outlined in Paragraph 82.13. [Regulation No. 19 §19.304 and 40 CFR Part 82, Subpart A]
110. All containers in which methyl bromide is stored or transported must be labeled as outlined in Paragraphs 82.106, 82.108, and 82.110. [Regulation No. 19 §19.304 and 40 CFR Part 82, Subpart A]
111. Producer Quarterly Reports must be mailed to the Administrator within 45 days of each calendar quarter, as outlined in Paragraphs 82.13(c) and 82.13(f)(3). [Regulation No. 19 §19.304 and 40 CFR Part 82, Subpart A]
112. RESERVED
113. RESERVED
114. RESERVED
115. RESERVED
116. RESERVED
117. RESERVED
118. RESERVED
119. RESERVED
120. RESERVED
121. RESERVED

Albemarle Corporation
Permit #: 0762-AOP-R16
AFIN: 14-00028

- 122. RESERVED
- 123. RESERVED
- 124. RESERVED
- 125. RESERVED
- 126. RESERVED
- 127. RESERVED
- 128. RESERVED
- 129. RESERVED
- 130. RESERVED
- 131. RESERVED
- 132. RESERVED
- 133. RESERVED
- 134. RESERVED
- 135. RESERVED
- 136. RESERVED

Miscellaneous Requirements

- 137. Spent sulfuric acid shall be the only material permitted for storage in the tanks which vent at SN-TB-12. [A.C.A. §8-4-203 as referenced by §8-4-304 and §8-4-311]

NC-15 Flame Retardant Process

Solvent (if used), bromine, raw material, and catalyst are added to the reactor. The reaction proceeds with external cooling to completion. Hydrogen bromide gas is produced and exits the reactor through a condenser. Bromine carried by the gas is returned to the reactor. The hydrogen bromide (which is not condensed) carries on to a recovery system and is recycled to another plant. Any HBr which is not recovered is neutralized in a caustic scrubber (SN-15-12).

After the reaction is complete, any excess bromine is stripped or neutralized. The stripped bromine is dried and recycled to the process in future batches. Solvent may be added to aid processing.

The stripped or neutralized product is isolated from the solvent or aqueous mixture by various means, such as centrifugation and distillation. The product is dried, ground, and packaged to specifications. If solvent was used in the process, it is recovered and recycled. Tank, T-9962, which vents at SN-15-18, is used to store byproduct diphenyl ethane and heavy organics.

Compliance with permitted emission rates shall be demonstrated through stack testing, parametric monitoring, and record keeping requirements.

Specific Conditions

138. The permittee shall not exceed the emission rates set forth in the following table. [Regulation No. 19 §19.501 *et seq.* and 40 CFR Part 52, Subpart E]

SN-#	Description	Pollutant	lb/hr	tpy
15-09	Refrigerated Coolant Storage	VOC	0.03	0.13
15-12	NC-15 Area Scrubber	PM ₁₀	2.17	9.51
		SO ₂	0.01	0.05
		VOC	2.20	9.64
		CO	0.15	0.66
		NO _x	0.18	0.79
15-13	Raw Material Weigh Tanks D-9965, D-9966	VOC	0.07	0.31
15-15	Fugitive Emissions	PM ₁₀	0.03	0.13
		VOC	4.23	18.30
15-16	Pollution Control: Dust Scrubber J-99601 CD-15-16	PM ₁₀	1.20	5.30
15-17	Rail Car Vent	VOC	0.69	3.03
15-18	DPE Byproduct/Heavy Organics Storage Tank (serving NC-21)	VOC	0.10	0.10
15-19	NC-15 Central Vacuum System	PM ₁₀	0.10	0.20

139. The permittee shall not exceed the non-criteria emission rates set forth in the following table. [Regulation No. 18 §18.801 and A.C.A §8-4-203 as referenced by §8-4-304 and §8-4-311]

SN-#	Description	Pollutant	lb/hr	tpy
15-02	Process Scrubber	Br ₂	0.10	0.44
		HBr	0.10	0.44
15-09	Refrigerated Coolant Storage	Ethylene Glycol	0.03	0.13
15-12	NC-15 Area Scrubber	PM	2.17	9.51
		Br ₂ +HBr	1.09	4.78
15-15	Fugitive Emissions	PM	0.03	0.13
		Br ₂ +HBr	1.54	6.72
15-16	Pollution Control: Dust Scrubber J-99601 CD-15-16	PM	1.20	5.30
15-19	NC-15 Central Vacuum System	PM	0.10	0.20

140. The following sources shall not exceed 5% opacity: SN-15-02, SN-15-12, SN-15-16, and SN-15-19. [Regulation No. 18 §18.501 and A.C.A §8-4-203 as referenced by §8-4-304 and §8-4-311]
141. The permittee shall operate a bromine monitor on SN-15-02 and SN-15-12 at all times when the units are in operation. This monitor shall be maintained and operated in accordance with the latest revised version of the "Preventative Maintenance Plan for the Emission Control Devices." Bromine emission records and a copy of the latest revised version of the Maintenance Plan shall be maintained on site and made available to Department personnel upon request. Specific Conditions #145a and #145b may take the place of this requirement. [Regulation No. 18 §18.1003 and A.C.A §8-4-203 as referenced by §8-4-304 and §8-4-311]
142. The permittee shall conduct stack testing for the following compounds in calendar year 2002, and every two years thereafter. Test methods are listed in the right-hand column of the table. [Regulation No. 19 §19.702 and 40 CFR Part 52, Subpart E]

Source	Compound	EPA Reference Method
SN-15-12	VOC	18 or 25A
SN-15-12	PM/PM ₁₀	5
SN-15-16	PM/PM ₁₀	5

143. The permittee shall conduct stack testing for bromine at SN-15-12 in calendar year 2002, and every five years thereafter. The testing shall be conducted using EPA Reference Method 26A. [Regulation No. 18 §18.1002 and A.C.A §8-4-203 as referenced by §8-4-304 and §8-4-311]

Source	Compound	EPA Reference Method
SN-15-12	Br ₂	26A

Alternative test methods may be submitted to the Compliance Inspector Supervisor at least 30 days in advance of planned testing. These methods must receive Department approval prior to the testing event.

144. RESERVED.

Albemarle Corporation
Permit #: 0762-AOP-R16
AFIN: 14-00028

145. The permittee shall maintain weekly production records of DPE product generated in the NC-21 production unit. A factor of 0.250 lb heavy ends byproduct per lb DPE product shall be applied to the recorded DPE product value. The source SN-15-18 shall be deemed in compliance whenever the resulting calculated byproduct flow does not exceed 69,630 lbs/week. The records (including byproduct calculation) shall be kept on site and made available to Department personnel upon request. [Regulation No. 19 §19.705 and 40 CFR Part 52, Subpart E]

Alternate Scenario - Compliance with Bromine emission limits during loss of Bromine Monitor

The following two conditions may be implemented instead of Specific Condition #141.

- 145a. The permittee shall perform a visual inspection to confirm pump activity of the pumps driving the scrubber media at SN-15-02 and SN-15-12 every three hours, to ensure that sufficient flow is maintained. Inspection results shall be recorded in a log. These records shall be kept on site and made available to Department personnel upon request. [Regulation No. 18 §18.1003 and A.C.A. §8-4-203 as referenced by §8-4-304 and §8-4-311]
- 145b. The permittee shall measure and record the caustic concentration of the scrubber media used at least once per twelve-hour shift at SN-15-02. The caustic shall be replaced when the concentration falls below 5% strength. [Regulation No. 19 §19.703, 40 CFR Part 52, Subpart E, and A.C.A. §8-4-203 as referenced by §8-4-304 and §8-4-311]

NC-17 Flame Retardant Process

Tetrabromophthalic anhydride (TBPA), ethylene-bis-tetrabromophthalimide (EBTBP), and a purified (higher grade) of EBTBP are made at the South Plant in what is known as the NC-17 Production Unit (formerly NC-16).

TBPA and EBTBP are marketed and sold as flame retardants. Additionally, TBPA is used as a raw material in the production of EBTBP. Under this permit, the permittee may produce products either separately or simultaneously.

This permitting action allows the West Plant product HP-7010 to be reworked, granulated, and packaged in the NC-17 process area of the South Plant. Existing equipment will be used to control associated emissions: the Weigh Hopper Filter (SN-16-27) and the Product Transfer and Storage Filter (SN-16-26).

Tetrabromophthalic Anhydride (TBPA)

Tetrabromophthalic anhydride is produced in a batch reaction process by brominating phthalic anhydride in the presence of sulfuric acid and sulfur trioxide. The final product, a solid, is centrifuged, dried, and packaged for shipment or transported for production of EBTBP. Dust generated by these operations is controlled by fabric filters (SN-16-10, SN-16-11, and SN-16-29). Vapors generated are controlled by scrubbers (SN-16-01, SN-16-02, SN-16-13, and SN-16-24). Molten phthalic anhydride is stored in the Molten PA Storage Tank (SN-16-31).

Ethylene-bis-tetrabromophthalimide (EBTBP)

EBTBP and its higher grade equivalent are produced by reacting tetrabromophthalic anhydride with ethylene diamine in the presence of an acid. This reaction forms a solid complex, which is separated from the liquid, washed, and then dried. Emissions generated by the EBTBP process are controlled by scrubbers (SN-16-05, SN-16-06, and SN-16-25), by baghouses (SN-16-07, SN-16-08, SN-16-09, SN-16-12, SN-16-25, SN-16-26, and SN-16-27), or by carbon drums (SN-16-14 and SN-16-15). The higher grade EBTBP process is equipped with a vent gas oxidizer (SN-16-18) and a solvent recovery unit to control VOC emissions, and with three baghouses to control particulates (SN-16-19, SN-16-11, SN-16-22).

Compliance with permitted emission rates shall be demonstrated through stack testing, parametric monitoring, and record keeping requirements.

Specific Conditions

146. The permittee shall not exceed the emission rates set forth in the following table. [Regulation No. 19 §19.501 *et seq.* and 40 CFR Part 52, Subpart E]

SN-#	Description	Pollutant	lb/hr	tpy
16-01	TBPA Production: Packed Scrubber	PM ₁₀	0.10	0.44
		SO ₂	0.50	2.19
16-02	TBPA Production: Off Gas Scrubber	SO ₂	0.40	1.75
		VOC	0.10	0.44
16-05	EBTBP Production: Packed Scrubber	VOC	0.10	0.44

Albemarle Corporation
 Permit #: 0762-AOP-R16
 AFIN: 14-00028

SN-#	Description	Pollutant	lb/hr	tpy
16-06	EBTBP Production: Converter Scrubber	VOC	0.10	0.44
		PM ₁₀	0.40	1.75
16-07	EBTBP Production: In-Process Storage Silo Vent Filter	PM ₁₀	0.30	1.32
16-08	EBTBP Production: Product Transfer and Storage Fabric Filter	PM ₁₀	0.30	1.32
16-10	Product Transfer and Storage Fabric Filter	PM ₁₀	0.50	2.19
		SO ₂	0.10	0.44
16-11	TBPA Production: Packaging Filter	PM ₁₀	0.10	0.44
16-12	TBPA Weigh Hopper Filter	PM ₁₀	0.10	0.44
16-13	TBPA Production: Vacuum Pump	SO ₂	0.10	0.44
16-14	Ethylene Diamine Storage Tank	VOC	0.01	0.04
16-15	Propionic Acid Storage Tank	VOC	0.01	0.04
16-16	TBPA Neutralization Tank	SO ₂	0.10	0.44
16-17	Ethylene Glycol Tank	VOC	0.02	0.09
		PM ₁₀	0.05	0.22
		SO ₂	0.07	0.31
		VOC	0.66	2.89
		CO	0.86	3.77
16-18	Vent Gas Oxidizer	NO _x	0.64	2.80
		PM ₁₀	0.30	1.32
16-19	Charge Hopper Vent	SO ₂	0.10	0.44
		PM ₁₀	0.30	1.32
16-20	Heat Exchange Heater	PM ₁₀	0.04	0.18
		SO ₂	0.06	0.27
		VOC	0.13	0.57
		CO	0.19	0.83
		NO _x	0.50	2.18
16-21	Product Storage Hopper	PM ₁₀	0.20	0.88
		VOC	0.40	1.76
16-22	By-Product Powder Packaging	PM ₁₀	0.01	0.04
		VOC	0.01	0.04
16-23	NC-16 Operation: Fugitive Emissions	PM ₁₀	0.32	1.40
		SO ₂	1.02	4.47
		VOC	6.60	28.53
16-24	Raw Material Unloading, Brinks (Limited Hours of Operation)	SO ₂	1.80	1.58
16-25	Wet Scrubber	PM ₁₀	0.40	1.75
		VOC	1.02	3.46
16-26	EBTBP or TBBPA Rework Transfer and Storage Filter	PM ₁₀	0.30	1.32
16-27	Reactor Weigh Hopper Filter	PM ₁₀	0.30	1.32
16-28	TBPA Neutralization Tank	SO ₂	0.10	0.44
16-31	Molten Phthalic Anhydride Storage Tank	VOC	3.83	0.80

Albemarle Corporation
 Permit #: 0762-AOP-R16
 AFIN: 14-00028

147. The permittee shall not exceed the non-criteria emission rates set forth in the following table. [Regulation No. 18 §18.801 and A.C.A §8-4-203 as referenced by §8-4-304 and §8-4-311]

SN-#	Description	Pollutant	lb/hr	tpy
16-01	TBPA Production: Packed Scrubber	PM	0.10	0.44
		Phthalic Anhydride	0.10	0.44
16-02	TBPA Production: Off Gas Scrubber	Br ₂	0.10	0.44
16-06	EBTBP Production: Converter Scrubber	PM	0.40	1.75
16-07	EBTBP Production: In- Process Storage Silo Vent Filter	PM	0.30	1.32
16-08	EBTBP Production: Product Transfer and Storage Fabric Filter	PM	0.30	1.32
16-10	Product Transfer and Storage Fabric Filter	PM	0.50	2.19
16-11	TBPA Production: Packaging Filter	PM	0.10	0.44
16-12	TBPA Weigh Hopper Filter	PM	0.10	0.44
16-17	Ethylene Glycol Tank	Ethylene Glycol	0.02	0.09
16-18	Vent Gas Oxidizer	PM	0.05	0.22
		Xylene + Ethyl Benzene	0.52	2.28
16-19	Charge Hopper Vent	PM	0.30	1.32
16-20	Heat Exchange Heater	PM	0.04	0.18
16-21	Product Storage Hopper	PM	0.20	0.88
		Xylene + Ethyl Benzene	0.28	1.23
16-22	By-Product Powder Packaging	PM	0.01	0.04
		Xylene + Ethyl Benzene	0.01	0.04
16-23	NC-16 Operation: Fugitive Emissions	PM	0.32	1.40
		Xylene + Ethyl Benzene	2.70	11.80
		Ethylene Glycol	0.41	1.80
		Br ₂	0.34	1.49
16-25	Wet Scrubber	PM	0.40	1.75
16-26	EBTBP or TBBPA Rework Transfer and Storage Filter	PM	0.30	1.32
16-27	Reactor Weigh Hopper Filter	PM	0.30	1.32
16-31	Molten Phthalic Anhydride Storage Tank	Phthalic Anhydride	3.83	0.80

Albemarle Corporation
 Permit #: 0762-AOP-R16
 AFIN: 14-00028

148. The following sources shall not exceed 5% opacity: SN-16-01, SN-16-02, SN-16-06 through SN-16-08, SN-16-10 through SN-16-12, SN-16-18 through SN-16-21, SN-16-22, SN-16-25 through SN-16-27, and SN-16-29. [Regulation No. 18 §18.501 and A.C.A. §8-4-203 as referenced by §8-4-304 and §8-4-311]
149. The permittee shall monitor the scrubber fluid flow of the following sources on a three-hour basis. The recorded flow rates shall be made accessible for Department inspection upon request. [Regulation No. 19 §19.703, 40 CFR Part 52, Subpart E, and A.C.A. §8-4-203 as referenced by §8-4-304 and §8-4-311]

Source	Minimum Scrubbing Fluid Flow (gpm)
SN-16-01	6
SN-16-02	60
SN-16-05	4
SN-16-06	6
SN-16-13	4
SN-16-24	6 (water)
SN-16-25	25

150. The permittee shall replace the carbon canisters at SN-16-14, SN-16-15, and SN-16-22 at least once per year. A log of replacement dates (or notation on the drum) shall be maintained on site and made available to Department personnel upon request. [Regulation No. 19 §19.703, 40 CFR Part 52, Subpart E, and A.C.A. §8-4-203 as referenced by §8-4-304 and §8-4-311]
151. The permittee shall measure and record the pH of the scrubber media used for SN-16-01, SN-16-02, SN-16-05, SN-16-06, and SN-16-25 every three hours. The caustic pH records shall be kept on site and made available to Department personnel upon request. The caustic pH corresponding to the most recent satisfactory test event shall be established as the minimum for purposes of continuous compliance until the next test is performed. [Regulation No. 19 §19.703, 40 CFR Part 52, Subpart E, and A.C.A. §8-4-203 as referenced by §8-4-304 and §8-4-311]
152. RESERVED
153. SN-16-24 shall be limited to 1752 hours of operation per year. The permittee shall maintain accessible records of operating hours at the source, to be updated per event of operation. [Regulation No. 18 §18.1004 and A.C.A. §8-4-203 as referenced by §8-4-304 and §8-4-311]
154. Only one of the sources SN-16-19 and SN-16-29 shall be operated at any given time. [Regulation No. 18 §18.1004 and A.C.A. §8-4-203 as referenced by §8-4-304 and §8-4-311]
155. The combustion zone temperature of the Vent Gas Oxidizer, SN-16-18, shall be maintained at a minimum of 1000 °F. Compliance with this condition shall be facilitated by maintaining a log of automatic shutdowns by the temperature interlock (block valve) system. Each log entry shall include an operator's statement reporting whether the interlock system performed as designed. Additionally, the permittee shall review the logs

each six months and certify that the interlock has functioned correctly during that period. The running logs and 6-month certification shall be kept on site and made available to Department personnel upon request. [Regulation No. 19 §19.703, 40 CFR Part 52, Subpart E, and A.C.A. §8-4-203 as referenced by §8-4-304 and §8-4-311]

156. The permittee shall maintain readily accessible records of the dimensions and capacity of the phthalic anhydride storage vessel, as required by §63.123(a). [Regulation No. 19 §19.304 and 40 CFR Part 63, Subpart G (see Appendix A)]
157. All equipment in phthalic anhydride service must comply with the protocol for equipment leaks as outlined in Section 63.169(a) through (d). (This regulation outlines monitoring and maintenance standards for pumps, valves, connectors, and agitators in heavy liquid service; for instrumentation systems; and for pressure relief devices in liquid service). [Regulation No. 19 §19.304 and 40 CFR Part 63, Subpart H (see Appendix A)]
158. The permittee shall calculate emissions from SN-16-16 every 12 months. Pound per hour emissions shall be based upon worst-case conditions, and ton per year emissions upon a 12-month rolling period or assumed continuous usage. A copy of the calculations shall be kept on site and made available to Department personnel upon request. [Regulation No. 18 §18.1004 and A.C.A §8-4-203 as referenced by §8-4-304 and §8-4-311]
159. The permittee shall calculate VOC emissions from SN-16-21 every 12 months. Pound per hour emissions shall be based upon worst-case conditions, and ton per year emissions upon a 12-month rolling period or assumed continuous usage. A copy of the calculations shall be kept on site and made available to Department personnel upon request. [Regulation No. 19 §19.705 and 40 CFR Part 52, Subpart E]
160. The permittee shall conduct stack testing for SO₂ at SN-16-01 in 2002, at SN-16-02 in 2003, and SN-16-24 in the first calendar year it operates more than 25% per Plantwide Condition #18. A proposed test method shall be submitted to the Compliance Inspector Supervisor at least 30 days in advance of planned testing. The method must receive Department approval prior to the testing event. [Regulation No. 19 §19.702 and 40 CFR Part 52, Subpart E]

Note: As of July 18, 2006, the facility is in compliance with this condition. The testing for 16-01 and 16-02 has been completed. The test at 16-24 has not been conducted because the source has not been operated.

161. The permittee shall conduct stack testing for Br₂ at SN-16-02 in calendar year 2002 and every five years thereafter. Testing shall be performed using EPA Reference Method 26A. Alternative test methods may be submitted to the Compliance Inspector Supervisor at least 30 days in advance of planned testing. These methods must receive Department approval prior to the testing event. [Regulation No. 18 §18.1002 and A.C.A §8-4-203 as referenced by §8-4-304 and §8-4-311]
162. The permittee shall conduct stack testing at SN-16-25 for VOC according to the following parameters. [Regulation No. 19 §19.702, 40 CFR Part 52, Subpart E, §18.10 and A.C.A §8-4-203 as referenced by §8-4-304 and §8-4-311]

Albemarle Corporation
 Permit #: 0762-AOP-R16
 AFIN: 14-00028

Pollutant	EPA Reference Method	Schedule
VOC	25A	Within the calendar year it operates >25% of the time, and bi-annually thereafter.

- 163. The permittee shall unload the HP-7010 super sacks and operate the granulating and packaging procedures only when the pneumatic dust control systems are activated (the systems venting at the SN-16-27 and SN-16-26 filters). [Regulation No. 18 §18.1004 and A.C.A §8-4-203 as referenced by §8-4-304 and §8-4-311]
- 164. The permittee shall not operate the ethylene bis tetrabromophthalimide process while HP-7010 is being granulated and packaged. [Regulation No. 18 §18.1004 and A.C.A §8-4-203 as referenced by §8-4-304 and §8-4-311]
- 164a. The permittee shall not exceed a throughput of 18.25 million pounds per twelve consecutive months at PA Tank (T-9340) (SN-16-31). [Regulation No. 19 §19.705, 40 CFR 70.6, and A.C.A. §8-4-203 as referenced by §8-4-304 and §8-4-311]
- 164b. The permittee shall maintain monthly records demonstrating compliance with Specific Condition #164a. Records shall be updated by the 15th day following the month to which the records pertain, made available to Department personnel upon request, and submitted in accordance with General Provision 7. [Regulation No. 19 §19.705 and Part 52, Subpart E]

Boilers

There are two boilers at the Albemarle South facility. Each boiler has the capacity to produce 200,000 pounds of 225 psig steam per hour. This is equivalent to a heat input of 340 million BTU per hour. The boilers burn natural gas, which has been treated either in the sulfinol or the MDEA plants. They may also burn pipeline quality natural gas. They are not permitted to burn any other fuel.

Emissions generated by the two boilers are permitted under a single bubble. Compliance with permitted emission rates shall be demonstrated through stack testing, parametric monitoring, and record keeping requirements.

Specific Conditions

165. The permittee shall not exceed the emission rates set forth in the following table. [Regulation No. 19 §19.501 *et seq.* and 40 CFR Part 52, Subpart E]

SN-#	Description	Pollutant	lb/hr	tpy
BH-01	#1 Boiler	PM ₁₀	2.59	-
		SO ₂	-	-
		VOC	1.87	-
		CO	13.60	-
		NO _x	47.60	-
BH-02	#2 Boiler	PM ₁₀	2.59	-
		SO ₂	-	-
		VOC	1.87	-
		CO	13.60	-
		NO _x	47.60	-
BH-01 and BH-02	Combined Boiler Emissions	PM ₁₀	-	22.64
		SO ₂	5.6	24.60
		VOC	-	16.38
		CO	-	119.20
		NO _x	-	417.00

166. The permittee shall not exceed the non-criteria emission rates set forth in the following table. [Regulation No. 18 §18.801 and A.C.A §8-4-203 as referenced by §8-4-304 and §8-4-311]

SN-#	Description	Pollutant	lb/hr	tpy
BH-01	#1 Boiler	PM	3.40	-
BH-02	#2 Boiler	PM	3.40	-
BH-01 and BH-02	Combined Boiler Annual Emissions	PM	-	29.78

167. The following sources shall not exceed 5% opacity: SN-BH-01 and SN-BH-02. [Regulation No. 18 §18.501 and A.C.A. §8-4-203 as referenced by §8-4-304 and §8-4-311]

Albemarle Corporation
 Permit #: 0762-AOP-R16
 AFIN: 14-00028

168. The permittee may only burn the following fuels in the boilers: pipeline quality natural gas and process gas that has been treated by the sulfinol and MDEA plants. [Regulation No. 19 §19.705, and 40 CFR Part 70.6, A.C.A. §8-4-203 as referenced by §8-4-304 and §8-4-311]
169. The permittee shall monitor and record the H₂S concentration and the combined gas flow to the boilers at least once every six hours. The measured concentration shall be used to determine the mass emission rate of SO₂ from the boilers assuming a 1:1 molar ratio of sulfur conversion at the boilers. A rolling 30-day average H₂S concentration may be used to calculate the lb/hr emissions for compliance demonstration with the 5.60 lb/hr emission limit of Specific Condition #165. A rolling 12-month total shall be used to calculate tpy for compliance demonstration with the combined 24.53 ton/yr value of Specific Condition #165. A shorter averaging period may be used in lieu of the rolling 30-day average (e.g., if all three-hour rolling averages as currently calculated are below the emission limit, a rolling 30-day average is not required).

All records shall be updated by the 15th day following the month to which the records pertain. Records shall be kept on-site, made available to Department personnel, and otherwise kept in accordance with General Provision #7. [Regulation No. 19 §19.703, 40 CFR Part 52, Subpart E, and A.C.A §8-4-203 as referenced by §8-4-304 and §8-4-311]

170. The permittee shall perform stack testing on SN-BH-01 and SN-BH-02 in 2005 and every five years thereafter. The testing shall be performed while each boiler is operating within 10% of its design capacity. Hourly test results shall be combined for each pollutant to determine compliance with the emission bubble. Compounds and applicable test methods are listed below. [Regulation No. 19 §19.702 and 40 CFR Part 52, Subpart E]

Source	Compound	EPA Reference Method
SN-BH-01, SN-BH-02	SO ₂ *	6C
SN-BH-01, SN-BH-02	VOC	18 or 25A
SN-BH-01, SN-BH-02	CO	10B
SN-BH-01, SN-BH-02	NO _x	7E

* If sulfur dioxide testing is performed during combustion of sweetened gas, 5.6 lb/hr shall be the maximum compliant value for each boiler, instead of 2.8. However, 5.6 lb/hr is also the maximum compliant value for simultaneous emissions from both boilers.

NC-21 Flame Retardant Process

Benzene, 1,2-dichloroethane, and catalyst are added to the reactor. The reaction proceeds, with external heating to completion. Hydrogen chloride gas is produced, and exits the reactor. Hydrogen chloride is neutralized in a caustic scrubber which in turn vents through the incinerator (SN-21-01). Benzene emissions are minimized by vent gas condensers. The condensed gas outlet is routed to the incinerator.

After the reaction is complete, the reaction mass is neutralized. The product is isolated by distillation, and any excess benzene is recovered and recycled. The isolated product is stored in a liquid state, and used for internal and external markets.

All tank vents are routed to the incinerator. All storage vessels are operated under pressure, to minimize emissions. Tank truck loading and unloading operations are performed using closed domes.

Compliance with permitted emission rates shall be demonstrated through parametric monitoring and record keeping requirements.

Specific Conditions

171. The permittee shall not exceed the emission rates set forth in the following table. [Regulation No. 19 §19.501 *et seq.* and 40 CFR Part 52, Subpart E]

SN-#	Description	Pollutant	lb/hr	tpy
21-01	Emission Control: Vent Gas Incinerator (FL-3671) (CD-21-01)	PM ₁₀	0.10	0.44
		SO ₂	0.01	0.04
		VOC	1.71	2.50
		CO	5.00	21.90
		NO _x	0.50	2.20
21-02	NC-21 Fugitive Emissions	VOC	3.71	16.22
21-03	Wastewater Effluent	VOC	0.01	0.01

172. The permittee shall not exceed the non-criteria emission rates set forth in the following table. [Regulation No. 18 §18.801 and A.C.A §8-4-203 as referenced by §8-4-304 and §8-4-311]

SN-#	Description	Pollutant	lb/hr	tpy
21-01	Emission Control: Vent Gas Incinerator (FL-3671) (CD-21-01)	PM	0.10	0.44
		Benzene	1.71	2.50
		HCl	0.35	1.54
		Ethylene Dichloride	0.10	0.10
21-02	NC-21 Fugitive Emissions	Benzene	0.90	3.94
		HCl	0.05	0.22
		Ethylene Dichloride	0.09	0.40
21-03	Wastewater Effluent	Benzene	0.01	0.01

173. SN-21-01 shall not exceed 5% opacity. [Regulation No. 18 §18.501 and A.C.A §8-4-203 as referenced by §8-4-304 and §8-4-311]

Albemarle Corporation
Permit #: 0762-AOP-R16
AFIN: 14-00028

174. The permittee is subject to all applicable provisions of the National Emission Standard for Equipment Leaks (Fugitive Emission Sources) of Benzene. [Regulation No. 19 §19.304 and 40 CFR Part 61 Subpart J (see Appendix A)]
175. The permittee is subject to all applicable provisions of the National Emission Standard for Equipment Leaks (Fugitive Emission Sources). This includes, but is not limited to, the reporting requirements of §61.247 and the performance standards contained in §61.242. [Regulation No. 19 §19.304 and 40 CFR Part 61 Subpart V (see Appendix A)]
176. The permittee is subject to all applicable provisions of the National Emission Standard for Benzene Waste Operations. Because current annual benzene waste quantity for the facility is between 1 Mg and 10 Mg per year, the facility is only subject to the record keeping requirements of 61.356(b) and the reporting requirements of 61.357(c). If the total annual benzene waste quantity becomes equal to or greater than 10 Mg/yr, 61.342(c) will become applicable to this process unit. [Regulation No. 19 §19.304 and 40 CFR Part 61 Subpart FF (see Appendix A)]
177. The permittee shall operate a system capable of monitoring and recording the flow rate of process gases to the Vent Gas Incinerator, and the temperature of its combustion zone. The system will also be capable of continuously converting the temperature and flow rates into calculated residence time to demonstrate compliance with 40 CFR Part 61 Subpart V, 61.242-11(c). A Preventive Maintenance Plan describing the methods used to monitor and control calibration drift and zero drift of components in the monitor system will be kept current and available on site for inspection. A formal RATA is not required since the monitoring system is not a CEM. [Regulation No. 18 §18.1003 and A.C.A §8-4-203 as referenced by §8-4-304 and §8-4-311]
178. The permittee shall calculate all emissions from the Vent Gas Incinerator (SN-21-01) on a semi-annual basis. Pound per hour emissions shall be based upon worst-case conditions, and ton per year emissions upon a 12-month rolling period or assumed continuous usage. A copy of the calculations shall be kept on site and made available to Department personnel upon request. [Regulation No. 18 §18.1004 and A.C.A §8-4-203 as referenced by §8-4-304 and §8-4-311]
179. The vent gas incinerator must provide a minimum residence time of 0.5 seconds when vent streams are being routed to the incinerator. The monitoring data required by the above condition, in conjunction with design data, shall be used to calculate residence time on a continuous basis. [Regulation No. 19 §19.304 and 40 CFR Part 61, Subpart V, 61.242-11(c)]
180. The permittee shall calculate benzene emissions from the wastewater effluent once per year. Pound per hour emissions shall be based upon worst-case conditions, and ton per year emissions upon a 12-month rolling period or assumed continuous usage. A copy of the calculations shall be kept on site and made available to Department personnel upon request. [Regulation No. 18 §18.1004 and A.C.A §8-4-203 as referenced by §8-4-304 and §8-4-311]

NC-22 Production

Bromine and polystyrene are reacted in an organic solvent, in the presence of a catalyst, to form brominated polystyrene. Bromine vapors from raw material storage are abated by the caustic scrubber (SN-TB-14). Under Scenario A, the brominated polystyrene product is centrifuged, the centrate passes through the Centrate Hold-up Drum (SN-TB-43), and the brominated polystyrene product (NC-22) is dried and collected for packaging by the Product Baghouse (SN-TB-04). Under Scenario B, the brominated polystyrene product is recovered by vaporization of the solvent and then the product is processed to its final configuration and packaged. Process water from the product recovery area is collected in the hold up drum (SN-TB-43) under Scenario B. Fugitive dust in the packaging area is collected in the packaging baghouse (SN-TB-08).

The co-product HBr produced from the reaction is absorbed in water and recycled at the South Plant. Before being recycled, aqueous HBr co-product is stored in a tank (HBr solution storage, SN-TB-42). Any HBr vapor not absorbed in the water is routed to a caustic scrubber. The vent stream from this caustic scrubber is routed to a solvent absorption/recovery unit (SN-TB-41) along with other vent streams from the process and storage areas. The primary function of the solvent absorption/recovery unit is to recover the organic solvent used in the process.

Compliance with permitted emission rates shall be demonstrated through stack testing, parametric monitoring, and record keeping requirements. While operating in this scenario Albemarle will continue to comply with the opacity limits set forth in Specific Condition #105 for the affected sources.

Specific Conditions

181. RESERVED

181a. The permittee shall not exceed the emission rates set forth in the following table during NC-22 production under Scenario A. [Regulation No. 19 §19.501 *et seq.* and 40 CFR Part 52, Subpart E]

Scenario A

SN-#	Description	Pollutant	lb/hr	tpy
TB-04	Product Baghouse	PM ₁₀	0.90	4.00
		VOC	0.21	0.92
TB-08	Dust Collector Baghouse	PM ₁₀	0.30	1.40
TB-29	NC-22 Fugitive Emissions	VOC	1.33	5.76
TB-41	Carbon Bed Solvent Recovery Units	VOC	6.40	8.30
TB-43*	Centrate Hold Up Drum	VOC	0.63	1.10

* Emissions are based on maximum average hourly pump capacity.

181b. The permittee shall not exceed the emission rates set forth in the following table during NC-22 production under Scenario B. [Regulation No. 19 §19.501 *et seq.* and 40 CFR Part 52, Subpart E]

Scenario B

SN-#	Description	Pollutant	lb/hr	tpy
TB-08	Dust Collector Baghouse	PM ₁₀	0.30	1.40
TB-29	NC-22 Fugitive Emissions	VOC	1.37	5.90
TB-41	Carbon Bed Solvent Recovery Units	VOC	9.70	12.80

182. RESERVED

182a. The permittee shall not exceed the non-criteria emission rates set forth in the following table during production under Scenario A. [Regulation No. 18 §18.801 and A.C.A §8-4-203 as referenced by §8-4-304 and §8-4-311]

Scenario A

SN-#	Description	Pollutant	lb/hr	tpy
TB-04	Product Baghouse	PM	0.90	4.00
		HBr	2.00	6.16
TB-08	Dust Collector Baghouse	PM	0.30	1.40
TB-14	Bromine Scrubber	Br ₂	0.10	0.44
TB-29	NC-22 Fugitive Emissions	Ethylene Glycol	0.08	0.34
		Br ₂ +HBr	0.44	1.92
		HCl	0.06	0.24
TB-41	Carbon Bed Solvent Recovery Units	HCl	0.07	0.10
		HBr	0.02	0.02
TB-42*	HBr Solution Storage	HBr	0.25	0.40

* Emissions are based on maximum average hourly pump capacity.

182b. The permittee shall not exceed the non-criteria emission rates set forth in the following table during production under scenario B. [Regulation No. 18 §18.801 and A.C.A §8-4-203 as referenced by §8-4-304 and §8-4-311]

Scenario B

SN-#	Description	Pollutant	lb/hr	tpy
TB-08	Dust Collector Baghouse	PM	0.30	1.40
TB-14	Bromine Scrubber	Br ₂	0.10	0.44
TB-29	NC-22 Fugitive Emissions	Ethylene Glycol	0.08	0.34
		Br ₂ +HBr	0.44	1.92
		HCl	0.06	0.24
TB-41	Carbon Bed Solvent Recovery Units	HCl	0.07	0.15
		HBr	0.04	0.05
TB-42*	HBr Solution Storage	HBr	0.25	0.40

* Emissions are based on maximum average hourly pump capacity.

183. The permittee shall maintain a carbon regeneration system at SN-TB-41 capable of completing a minimum of two regeneration for each bed for every 24-hour of bed/source operation. This minimum regeneration rate shall be sustained at all times during

Albemarle Corporation
Permit #: 0762-AOP-R16
AFIN: 14-00028

operation of the NC-22 process. The regeneration system shall be checked no less than once per week, to ensure that the regeneration rate is being met. Records of each inspection shall be maintained, kept on site, and made available to Department personnel upon request. [Regulation No. 19 §19.705, 40 CFR 70.6 and A.C.A. §8-4-203 as referenced by §8-4-304 and §8-4-311]

- 183a. The permittee may use portable carbon totes instead of the carbon beds referred to in Specific Condition #183. The permittee shall maintain records documenting the amount of carbon contained in each tote and the corresponding maximum allowable operating time for the tote. These records shall also include for each carbon tote change-out, the amount of carbon in the tote, maximum allowable operating time, and actual operating time. These records shall be updated with each tote change-out, kept on site, and made available to Department personnel upon request. [Regulation No. 19 §19.705, 40 CFR 70.6 and A.C.A. §8-4-203 as referenced by §8-4-304 and §8-4-311]
- 183b. The permittee, during periods of operation under Solvent Storage/Drying Only scenario, may elect to regenerate the carbon beds and/or change-out the carbon totes less frequently than otherwise required under Specific Condition #183 but no less frequent than 17 days. The permittee must first change-out or regenerate the adsorption system prior to initiating the alternate scenario and immediately following the period of operating under the alternate scenario. The permittee shall maintain records documenting the time starting and ending and the change-out or regeneration prior to and following use of the scenario. These records shall be updated with each use of the scenario, kept onsite, and made available to Department personnel upon request. [Regulation No. 19 §19.705, 40 CFR 70.6 and A.C.A. §8-4-203 as referenced by §8-4-304 and §8-4-311]
184. The permittee shall not produce more than 1,251 batches of NC-22 per rolling 12-month period until such time that the first batch of NC-22 is produced under operating scenario B. Once scenario B is initiated, the permittee shall not produce more than 1,925 batches of NC-22 (total for both scenarios) per rolling 12-month period. A normalization factor of 1.54 shall be applied to all scenario A batches to show compliance with the 1,925 batch/yr limit.
185. The permittee shall maintain records of each batch produced. These records shall be kept on site and made available to Department personnel upon request. Each individual month's batch total and each month's twelve (12) month rolling total shall be updated by the 15th of the month following the month to which the records pertain. A report including each individual month batch total as well as a 12-month rolling total shall be submitted to the Department in accordance with General Provision #7. [Regulation No. 19 §19.705 and 40 CFR Part 52, Subpart E]
186. The permittee shall perform a visual inspection of the pumps driving the scrubber media at SN-TB-14 at least once per batch, to ensure that sufficient flow is maintained. Inspection results shall be recorded in a log. These records shall be kept on site and made available to Department personnel upon request. [Regulation No. 18 §18.1004 and A.C.A. §8-4-203 as referenced by §8-4-304 and §8-4-311]

NC-23 Production

Raw materials are received in the NC-23 process area via truck or railcar, and are stored in tanks, silos, or warehouses (packaged raw materials). VOC emissions from tanks are vented through a common header to a water scrubber designated as SN-23-03.

Tetrabromobisphenol-A (TBBPA) is produced by reacting bisphenol-A (BPA) with bromine in an ethanol solvent. TBBPA is used as a flame retardant. A liquid byproduct of this reaction is ethyl bromide (bromoethane).

Ethanol is recovered from the ethyl bromide and stored in tanks. The vapors are controlled by a recovery system, consisting of condensers, absorbers, and separators. TBBPA is a solid product. Dust generated by the handling and packaging of TBBPA is controlled by fabric filters. Unreacted solvent ethanol is reclaimed and returned to the process origin as a raw material. Brines containing high concentrations of bromides are generated and recycled to produce bromine (raw material). A byproduct stream consisting of TBBPA, underbrominated TBBPA, isomers, and degradation products is also produced. Caustic is added to the process recycle stream to prevent corrosion.

The silo emission bubble (SN-23-06, SN-23-07, and SN-23-08) includes source numbers assigned to three silo processes. Each silo vents to two identical fabric filter baghouses. This permit allows the facility to operate any of three silos at any given time. Fresh production can only be received by one silo at any given time.

Compliance with permitted emission rates shall be demonstrated through stack testing, parametric monitoring, and record keeping requirements.

Specific Conditions

187. The permittee shall not exceed the emission rates set forth in the following table.
 [Regulation No. 19 §19.501 *et seq.* and 40 CFR Part 52, Subpart E]

SN-#	Description	Pollutant	lb/hr	tpy
23-01	NC-23 Fugitive Emissions	VOC	1.12	4.91
23-02	Raw Material Unloading Baghouse	PM ₁₀	0.10	0.44
		VOC	3.80*	16.60*
23-03	Raw Material Scrubber	VOC	0.35	1.53
23-04	By-product Loading	VOC	0.44	1.93
23-05	Vent Absorber	VOC	2.90	12.70
23-06	Receiving Silo Baghouse	PM ₁₀ VOC	0.30 3.80*	1.32 16.60*
23-07	Blending Silo Baghouse			
23-08	Discharging Silo Baghouse (emission bubble)			
23-09	Product Packaging Baghouse	PM ₁₀	0.10	0.44
		VOC	3.80*	16.60*
23-10	Product Packaging Dust Collection	PM ₁₀	0.10	0.44
		VOC	3.80*	16.60*
23-11A	Product Loading Baghouse	PM ₁₀	0.10	0.44

SN-#	Description	Pollutant	lb/hr	tpy
23-11B	Product Loading (Railcar)	VOC	3.80*	16.60*
23-12A	Product Loading Baghouse	PM ₁₀	0.10	0.44
23-12B	Product Loading (Truck)	VOC	3.80*	16.60*
23-13	Floor Vacuum Baghouse	PM ₁₀	0.10	0.44
		VOC	3.80*	16.60*

* Total emission limit for VOC emitted from NC-23 production unit baghouses.

188. The permittee shall not exceed the non-criteria emission rates set forth in the following table. [Regulation No. 18 §18.801 and A.C.A §8-4-203 as referenced by §8-4-304 and §8-4-311]

SN-#	Description	Pollutant	lb/hr	tpy
23-01	NC-23 Fugitive Emissions	Br ₂	0.22	0.97
		HBr	0.11	0.49
		Chloroethane	0.03	0.13
23-02	Raw Material Unloading Baghouse	PM	0.20	0.88
		HBr	0.23*	0.97*
		Acetaldehyde	0.10*	0.44*
		Chloroethane	0.20*	0.88*
23-03	Raw Material Scrubber	HBr	0.35	1.50
		Chloroethane	0.02	0.09
23-05	Vent Absorber	Phenol	0.02	0.09
		Bromoform	0.12	0.53
		Acetaldehyde	0.03	0.13
		Chloroethane	0.49	0.71
23-06	Receiving Silo Baghouse	PM	0.60	2.64
23-07	Blending Silo Baghouse	HBr	0.23*	0.97*
23-08	Discharging Silo Baghouse	Acetaldehyde	0.10*	0.44*
		Chloroethane	0.20*	0.88*
23-09	Product Packaging Baghouse	PM	0.20	0.88
		HBr	0.23*	0.97*
		Acetaldehyde	0.10*	0.44*
		Chloroethane	0.20*	0.88*
23-10	Product Packaging Dust Collection	PM	0.20	0.88
		HBr	0.23*	0.97*
		Acetaldehyde	0.10*	0.44*
		Chloroethane	0.20*	0.88*
23-11A	Product Loading Baghouse	PM	0.20	0.88
		HBr	0.23*	0.97*
23-11B	Product Loading (Railcar)	Acetaldehyde	0.10*	0.44*
		Chloroethane	0.20*	0.88*

SN-#	Description	Pollutant	lb/hr	tpy
------	-------------	-----------	-------	-----

23-12A	Product Loading Baghouse	PM	0.20	0.88
		HBr	0.23*	0.97*
23-12B	Product Loading (Truck)	Acetaldehyde	0.10*	0.44*
		Chloroethane	0.20*	0.88*
23-13	Floor Vacuum Baghouse	PM	0.20	0.88
		HBr	0.23*	0.97*
		Acetaldehyde	0.10*	0.44*
		Chloroethane	0.20*	0.88*
23-15	Phenol Storage Tank (6,500 gal)	Emissions routed to SN-23-05		

* Total emission limit for HBr, acetaldehyde, chloroethane emitted from NC-23 production unit baghouses.

189. The following sources shall not exceed 5% opacity: SN-23-02, SN-23-06 through SN-23-13 (Each "A" and "B" vent at SN-23-11 and SN-23-12 shall be considered separately). [Regulation No. 18 §18.501 and A.C.A. §8-4-203 as referenced by §8-4-304 and §8-4-311]
190. The permittee shall be allowed to conduct receiving, blending, or discharge for packaging at any of the three silos associated with source numbers SN-23-06, SN-23-07, and SN-23-08 at any given time. [Regulation No. 19 §19.705, 40 CFR Part 70.6, and A.C.A. §8-4-203 as referenced by §8-4-304 and §8-4-311]
191. The permittee shall operate a continuous flow monitor alarm at SN-23-03 (Raw Material Scrubber). A record of the minimum flow set point value for the scrubber shall be maintained. The permittee shall also keep a log of all alarm incidents and subsequent corrective action. These records shall be maintained on site and made available to Department personnel upon request. The flow rate history and alarm monitoring shall be confirmed by the most recent satisfactory test for purposes of continuous compliance until the next test is performed.
192. The permittee shall operate a continuous flow monitor alarm at SN-23-05 (Vent Absorber (scrubber)). A record of the minimum flow set point value for the scrubber shall be maintained. The permittee shall also keep a log of all alarm incidents and subsequent corrective action. These records shall be maintained on site and made available to Department personnel upon request. The flow rate history and alarm monitoring shall be confirmed by the most recent satisfactory test for purposes of continuous compliance until the next test is performed. [Regulation No. 19 §19.703, 40 CFR Part 52, Subpart E, and A.C.A. §8-4-203 as referenced by §8-4-304 and §8-4-311]
193. The permittee shall be limited to 96 total fills per day for the drums venting at SN-23-04. [Regulation No. 19 §19.705, 40 CFR Part 70.6, and A.C.A. §8-4-203 as referenced by §8-4-304 and §8-4-311]
194. The permittee shall maintain daily records of drum fills at SN-23-04 in order to demonstrate compliance with the previous condition. [Regulation No. 19 §19.705 and 40 CFR Part 52, Subpart E]
195. The permittee shall conduct stack testing for VOC at SN-23-03, SN-23-05, and either SN-23-06, SN-23-07, or SN-23-08 (whichever process silo is in receiving mode) in 2005 and every five years thereafter. Testing shall be conducted using EPA Reference Method

Albemarle Corporation
Permit #: 0762-AOP-R16
AFIN: 14-00028

18, and shall be coordinated in advance with the Compliance Inspector Supervisor.
[Regulation No. 19 §19.702 and 40 CFR Part 52, Subpart E]

196. The permittee shall conduct stack testing for HBr at source SN-23-06, SN-23-07, or SN-23-08 (whichever process silo is in receiving mode) in 2005 and every five years thereafter. Testing shall be conducted using EPA Reference Method 26A, and shall be coordinated in advance with the Compliance Inspector Supervisor. [Regulation No. 18 §18.1002 and A.C.A §8-4-203 as referenced by §8-4-304 and §8-4-311]
- 196a. RESERVED
- 196b. RESERVED
- 196c. The permittee shall limit the NC-23 primary reactor throughput of ABRM1 to 1.752 million pounds per consecutive 12-month rolling period. [Regulation No. 18 §18.1004 and A.C.A §8-4-203 as referenced by §8-4-304 and §8-4-311]
- 196d. The permittee shall keep monthly records of the amount of ABRM1 added to the reactor along with a twelve month rolling total. All records shall be updated by the 15th day following the month to which the records pertain. Records shall be kept on-site, made available to Department personnel, and otherwise kept in accordance with General Provision 7. [Regulation No. 18 §18.1004 and A.C.A §8-4-203 as referenced by §8-4-304 and §8-4-311]

Brine Management Process

The feed brine production system produces salt water from the Smackover Lime formation and pumps it to the plant, where the hydrogen sulfide and oil are removed. Brine is also purchased and is pumped to the plant where the hydrogen sulfide and oil are removed.

The feed brine system's main components are two above-ground fiberglass tanks. The bromine in the feed brine is removed in the bromine plant, and the debrominated brine becomes tail brine. The tail brine is neutralized in the neutralization tank, cooled by evaporative cooling in the cooling towers (SN-BT-21), and transferred into the fiberglass tail brine tank. From the tail brine tank, it is pumped through a system of pipelines and injected back into the Smackover Lime formation through the tail brine injection (recycle brine) system. Emissions from this process area have been calculated based upon maximum brine pump rates of system components. Compliance with permitted emission rates shall be demonstrated through process throughput restrictions and record keeping requirements.

Specific Conditions

197. The permittee shall not exceed the emission rates set forth in the following table. [Regulation No. 19 §19.501 *et seq.* and 40 CFR Part 52, Subpart E]

SN-#	Description	Pollutant	lb/hr	tpy
BT-01	Feed Brine Oil Separator/Surge Tank (V-3011)	VOC	0.01	0.05
BT-11	Neutralization Tank (T-3110)	VOC	0.01	0.05
BT-12	Tail Brine Line Vent	VOC	0.01	0.05
BT-13	Tail Brine Tank (T-3101)	VOC	0.01	0.05
BT-16	Brinefield Oil/Water Separator (T-7001)	VOC	30.00	1.80
BT-17	Brinefield Oil Storage Tank (T-7002)	VOC	16.40	1.70
BT-21	Four Tail Brine Cooling Towers (Y-3120, Y-3121, Y-3122, Y-3123)	PM ₁₀ VOC	4.12 3.37	18.09 14.72
BT-22	Brine Management, Fugitive Emissions Included in Ground Brine Ponds	VOC	0.02	0.09
BT-23	Line Vent	VOC	0.01	0.05
BT-24	Line Vent	VOC	0.01	0.05
BT-25	DRT Tail Brine Line Vent	VOC	0.01	0.05
BT-26	DRT Tail Brine Line Vent	VOC	0.01	0.05
BT-27	Tail Brine Line Vent	VOC	0.01	0.05
BT-28	Tail Brine Line Vent	VOC	0.01	0.05

198. The permittee shall not exceed the non-criteria emission rates set forth in the following table. [Regulation No. 18 §18.801 and A.C.A §8-4-203 as referenced by §8-4-304 and §8-4-311]

SN-#	Description	Pollutant	lb/hr	tpy
BT-01	Feed Brine Oil Separator/ Surge Tank (V-3011)	H ₂ S	0.14	0.61
BT-11	Neutralization Tank (T-3110)	H ₂ S	0.01	0.05
		NH ₃	0.20	0.90
		Cl ₂ or Halogens	0.03	0.13
BT-12	Tail Brine Line Vent	NH ₃	0.01	0.05
		Cl ₂ or Halogens	0.01	0.05
BT-13	Tail Brine Tank (T-3101)	H ₂ S	0.01	0.05
		NH ₃	0.02	0.09
		Cl ₂ or Halogens	0.01	0.05
BT-16	Brinefield Oil/Water Separator (T-7001)	H ₂ S	0.01	0.05
BT-17	Brinefield Oil Storage Tank (T-7002)	H ₂ S	0.01	0.05
BT-21	Four Tail Brine Cooling Towers (Y-3120, Y-3121, Y-3122, 6-3123)	PM	4.12	18.09
		NH ₃	10.23	44.77
		Cl ₂ or Halogens	2.89	12.60
BT-22	Brine Management, Fugitive Emissions Included in Ground Brine Ponds	H ₂ S	0.02	0.09
		NH ₃	0.02	0.09
		Cl ₂ or Halogens	0.02	0.09
BT-23	Line Vent	NH ₃	0.01	0.05
		Cl ₂ or Halogens	0.01	0.05
BT-24	Line Vent	NH ₃	0.01	0.05
		Cl ₂ or Halogens	0.01	0.05
BT-25	DRT Tail Brine Line Vent	NH ₃	0.01	0.05
		Cl ₂ or Halogens	0.01	0.05
BT-26	DRT Tail Brine Line Vent	NH ₃	0.01	0.05
		Cl ₂ or Halogens	0.01	0.05
BT-27	Tail Brine Line Vent	NH ₃	0.01	0.05
		Cl ₂ or Halogens	0.01	0.05
BT-28	Tail Brine Line Vent	NH ₃	0.01	0.05
		Cl ₂ or Halogens	0.01	0.05

199. The following sources shall not exceed 5% opacity: SN-BT-11, SN-BT-12, SN-BT-13, and SN-BT-21. [Regulation No. 18 §18.501 and A.C.A §8-4-203 as referenced by §8-4-304 and §8-4-311]
200. The rate of feed brine to be processed at SN-BT-01 shall be limited to 10,200 gallons of brine per minute. [Regulation No. 19 §19.705 et seq., 40 CFR Part 70.6, and A.C.A §8-4-203 as referenced by §8-4-304 and §8-4-311]
201. The rate of tail brine to be processed through the tail brine tank (BT-13) and the cooling towers (SN-BT-21) shall be limited to 10,600 gallons per minute, each. [Regulation No.

Albemarle Corporation
Permit #: 0762-AOP-R16
AFIN: 14-00028

- 19 §19.705 et seq., 40 CFR Part 70.6, and A.C.A §8-4-203 as referenced by §8-4-304 and §8-4-311]
202. The annual throughput of petroleum liquids through the brinefield oil/water separator (SN-BT-16) and brinefield oil storage tank (SN-BT-17) shall not exceed 250,000 gallons per year per source, on a 12-month rolling total. [Regulation No. 19 §19.705 et seq., 40 CFR Part 70.6, and A.C.A §8-4-203 as referenced by §8-4-304 and §8-4-311]
 203. The permittee shall keep readily accessible records on site which document the maximum design capacities of SN-BT-01, SN-BT-13, SN-BT-16, SN-BT-17, and SN-BT-21. [Regulation No. 18 §18.1004 and A.C.A §8-4-203 as referenced by §8-4-304 and §8-4-311]
 204. The permittee shall keep readily accessible records on site which demonstrate compliance with annual throughput limits at SN-BT-16 and SN-BT-17. [Regulation No. 18 §18.1004 and A.C.A §8-4-203 as referenced by §8-4-304 and §8-4-311]

Di-(methyl-thio)-toluene-diamine (DMTDA)

Toluene diamine (TDA) and methyl mercaptan (MeSH) are unloaded from tank cars, while chaser, solvent dimethyl formamide (DMF), and hydrogen peroxide (H₂O₂) are unloaded from tank trucks. Catalyst and product stabilizer are received in bags.

TDA and dimethyl disulfide (DMDS) are reacted with the catalyst to form di-(methyl-thio)-toluene-diamine. MeSH, a reaction byproduct, is combined with purchased MeSH and reacted with H₂O₂ to form DMDS, which can be recycled, disposed, or sold as product.

All vapors emitted from the process and storage areas are vented through a common header to a new thermal oxidizer (SN-DM-02). Insignificant amounts of particulate matter are emitted from the catalyst box and the product stabilizer hopper.

Compliance with permitted emission rates shall be demonstrated through stack testing, parametric monitoring, and record keeping requirements.

Specific Conditions

205. The permittee shall not exceed the emission rates set forth in the following table. [Regulation No. 19 §19.501 *et seq.* and 40 CFR Part 52, Subpart E]

SN-#	Description	Pollutant	lb/hr	tpy
DM-01	Ethylene Glycol Tank	VOC	0.03	0.11
DM-02	Thermal Oxidizer	PM ₁₀	0.20	0.88
		SO ₂	4.00	17.50
		VOC	0.10	0.44
		CO	0.10	0.44
		NO _x	0.31	1.40
DM-07	Fugitive Emissions	VOC	3.18	13.95

206. The permittee shall not exceed the non-criteria emission rates set forth in the following table. [Regulation No. 18 §18.801 and A.C.A §8-4-203 as referenced by §8-4-304 and §8-4-311]

SN-#	Description	Pollutant	lb/hr	tpy
DM-01	Ethylene Glycol Tank	Ethylene Glycol	0.03	0.11
DM-02	Thermal Oxidizer	PM	0.20	0.88
DM-03	Hydrogen Peroxide Tank I	H ₂ O ₂	0.81	3.55
DM-06	Hydrogen Peroxide Tank II	H ₂ O ₂	0.81	3.55
DM-07	Fugitive Emissions	Toluene Diamine	0.08	0.35
		Dimethyl Formamide	0.09	0.39
		Ethylene Glycol	0.41	1.80
		H ₂ O ₂	0.49	2.20

207. SN-DM-02 shall not exceed 5% opacity. [Regulation No. 18 §18.501 and A.C.A §8-4-203 as referenced by §8-4-304 and §8-4-311]
208. The combustion zone temperature of the Thermal Oxidizer (SN-DM-02) shall be maintained at a minimum of 1200 °F. A temperature monitoring device operated in

Albemarle Corporation
Permit #: 0762-AOP-R16
AFIN: 14-00028

accordance with the manufacturer's specifications and recommendations for use shall be the compliance mechanism for this condition. [Regulation No. 19 §19.703, 40 CFR Part 52, Subpart E, and A.C.A. §8-4-203 as referenced by §8-4-304 and §8-4-311]

209. The permittee shall record the combustion zone temperature of SN-DM-02 at least once per 24 hours of operation. The record shall be kept on site and made available to Department personnel upon request. [Regulation No. 19 §19.705 and 40 CFR Part 52, Subpart E]
210. The permittee shall conduct stack testing on SN-DM-02 for the following compounds, using the test methods indicated. [Regulation No. 19 §19.702 and 40 CFR Part 52, Subpart E]

Pollutant	EPA Reference Method
PM ₁₀	5
SO ₂	6C
VOC	18
CO	10B
NO _x	7E

The testing shall be conducted in 2005 and every five years thereafter, except for SO₂ testing, which shall be performed in 2002 and every two years thereafter. All particulate measured shall be assumed to be PM₁₀.

Maintenance and Support Facilities

Extraneous Water System

Process water from all plant operating units is routed to the Extraneous Water Treatment System prior to underground injection in three on-site Class I injection wells. This process water is collected in small unit sumps. Approximately 90% of the water is pumped from these unit sumps into the ADMA collection sump. From this sump, the water can be pumped to either extraneous water storage tanks, T-1305 or T-1300, or to the Extraneous Water Overflow Tank.

The Extraneous Water Overflow Tank is only used during excessive rainfall periods; it is normally empty. Normally, the flow is routed to T-1305, the small extraneous water storage tank. From there the water flows through the large extraneous water storage tank. Solids from these two tanks are sent to the drying bed for dewatering prior to disposal in Solid Waste Vault-2, (SWV-2). The water from the tanks continues on to the clarifier and three filter presses for further solids removal. The solids from the filter presses go directly to SWV-2. The water flows through the injection tank and a cartridge polishing filter prior to injection in one of three on-site Class-I injection wells.

The Extraneous Water Treatment System is being permitted under one emission bubble. Compliance with permitted emission rates shall be demonstrated through record keeping requirements.

Specific Conditions

211. The permittee shall not exceed the emission rates set forth in the following table. In order to demonstrate compliance with the emission limits, the permittee shall calculate annual emissions from the Extraneous Water System every six months. These calculations shall be kept on site and made available to Department personnel upon request. [Regulation No. 19 §19.501 *et seq.* and 40 CFR Part 52, Subpart E]

SN-#	Description	Pollutant	lb/hr	tpy
MS-01	Extraneous Water System	VOC	4.00	17.60

212. The permittee shall not exceed the emission rates set forth in the following table. In order to demonstrate compliance with the emission limits, the permittee shall calculate annual emissions from the Extraneous Water System every six months. These calculations shall be kept on site and made available to Department personnel upon request. [Regulation No. 18 §18.801, §18.1004, and A.C.A. §8-4-203 as referenced by §8-4-304 and §8-4-311]

SN-#	Description	Pollutant	lb/hr	tpy
MS-01	Extraneous Water System	Bromoform	0.53	2.32
		Chloroform	0.09	0.39
		1,1-Dichloroethane	0.09	0.39
		Toluene	0.25	1.10
		Acetaldehyde	0.28	1.23
		Methanol	0.98	4.28

Drying Bed

Solids from the Extraneous Water storage tanks and unit sumps are deposited on the Drying Bed for dewatering prior to disposal in the Solid Waste Vault #2. The water drained from the solids is pumped on level control back to the Extraneous Water storage tanks. The Drying Bed is approximately 100 ft by 300 ft in size.

Compliance with permitted emission rates shall be demonstrated through record keeping requirements.

Specific Conditions

213. The permittee shall not exceed the emission rates set forth in the following table. [Regulation No. 19 §19.501 *et seq.* and 40 CFR Part 52, Subpart E]

SN-#	Description	Pollutant	lb/hr	tpy
MS-02	Drying Bed	VOC	0.10	0.44

214. Records of solids transferred from the drying bed (SN-MS-02) to the landfill (SN-MS-06) shall be maintained and updated on a monthly basis. These records shall be kept on site and made available to Department personnel upon request. [Regulation No. 19 §19.705 and 40 CFR Part 52, Subpart E]
215. The permittee shall calculate annual emissions from the Drying Bed every six months. These calculations shall be kept on site and made available to Department personnel upon request. [Regulation No. 19 §19.705 and 40 CFR Part 52, Subpart E]

French Drain Sumps

Albemarle Corporation operates a system of sumps at the South Plant to collect contaminated groundwater at the plant site. The constituent concentration and pump rates of these sumps vary with hydrology. The recovered groundwater is recycled to the Bromine Process for bromide ion recovery through a process tank. These sumps are being permitted as a bubble. This tank is an insignificant source in the Bromine Process.

Compliance with permitted emission rates shall be demonstrated through record keeping requirements.

Specific Conditions

216. The permittee shall not exceed the emission rates set forth in the following table. [Regulation No. 19 §19.501 *et seq.* and 40 CFR Part 52, Subpart E]

SN-#	Description	Pollutant	lb/hr	tpy
MS-03	French Drain Sump Bubble	VOC	0.30	1.32

217. The permittee shall not exceed the non-criteria emission rates set forth in the following table. [Regulation No. 18 §18.801 and A.C.A §8-4-203 as referenced by §8-4-304 and §8-4-311]

Albemarle Corporation
 Permit #: 0762-AOP-R16
 AFIN: 14-00028

SN-#	Description	Pollutant	lb/hr	tpy
MS-03	French Drain Sump Bubble	Br ₂	2.70	11.83

218. Records of water quantity recovered from the sumps (SN-MS-03) shall be maintained on site, updated monthly, and made available to Department personnel upon request. Recovered water shall be limited to 82.0 million gallons per year from all sumps in the aggregate. [Regulation No. 19 §19.705 and 40 CFR Part 52, Subpart E]

Plantwide Refrigerant Fugitive Emissions

VOC and Non-VOC/Non-HAP refrigerants may be used in the various heat exchange processes at Albemarle. Refrigerant may be emitted from fittings, seals, and other refrigeration system components. The permitted hourly emission rate shown here is an annual-average based on annual refrigerant emissions estimates. Compliance is demonstrated based on work practices, mass balances, and recordkeeping according Plantwide Condition #12.

219. The permittee shall not exceed the emission rates set forth in the following table. [Regulation No. 19 §19.501 *et seq.* and 40 CFR Part 52, Subpart E]

SN-#	Description	Pollutant	lb/hr	tpy
MS-12	Plantwide Fugitive Refrigerant Emissions	VOC	1.06	4.64

220. The permittee shall not exceed the non-criteria emission rates set forth in the following table. [Regulation No. 18 §18.801 and A.C.A §8-4-203 as referenced by §8-4-304 and §8-4-311]

SN-#	Description	Pollutant	lb/hr	tpy
MS-12	Plantwide Fugitive Refrigerant Emissions	Non-VOC/Non-HAP Refrigerant	1.06	4.64

221. RESERVED
 222. RESERVED
 223. RESERVED

Carpenter's Shop

Albemarle Corporation operates an on-site carpenter's shop which makes shelves, cabinets, decks, and any other wood forms necessary to support the chemical manufacturing process operations at the facility.

This operation is subject to all applicable requirements of 40 CFR Part 63, Subpart JJ, National Emission Standards for Wood Furniture Manufacturing Operations.

Compliance with permitted emission rates shall be demonstrated through record keeping requirements.

Specific Conditions

Albemarle Corporation
 Permit #: 0762-AOP-R16
 AFIN: 14-00028

224. The permittee shall not exceed the emission rates set forth in the following table.
 [Regulation No. 19 §19.501 *et seq.* and 40 CFR Part 52, Subpart E]

SN-#	Description	Pollutant	lb/hr	tpy
MS-05	Carpenter's Shop Fugitives	VOC	0.67	2.20

225. Monthly record keeping of the finishing materials and adhesives used in the Carpenter's Shop (SN-MS-05) shall be maintained on site to demonstrate that the facility meets the criteria for an incidental furniture manufacturer. Monthly usage shall be limited to 100 gallons of solvent-based finishing materials and adhesives per month. [Regulation No. 19 §19.304 and 40 CFR Part 63, Subpart JJ, §63.800]

South Landfill

The South Landfill is used mainly for disposal of plant trash and molten sulfur from the DECTP process. Fugitive particulate emissions from this area are estimated to be de minimis. Sulfur disposal will result in emissions of VOC and SO₂.

Specific Conditions

226. The permittee shall not exceed the emission rates set forth in the following table.
 [Regulation No. 19 §19.501 *et seq.* and 40 CFR Part 52, Subpart E]

SN-#	Description	Pollutant	lb/hr	tpy
MS-06	South Landfill	SO ₂	0.50	0.17
		VOC	7.00	2.40

227. The permittee shall not exceed the non-criteria emission rates set forth in the following table. [Regulation No. 18 §18.801 and A.C.A §8-4-203 as referenced by §8-4-304 and §8-4-311]

SN-#	Description	Pollutant	lb/hr	tpy
MS-06	South Landfill	Toluene	5.00	1.70

228. Monthly records of sulfur disposed in the South Landfill (SN-MS-06) shall be maintained, kept on site, and made available to Department personnel upon request. Yearly disposal, on a 12-month rolling total, shall not exceed 24 million pounds per year. [Regulation No. 19 §19.705 and 40 CFR Part 52, Subpart E]

Gasoline Storage Tank

Albemarle Corporation maintains a 3100 gallon gasoline storage tank on the South Plant. This tank is filled periodically by a local vendor. The gasoline is used for plant vehicles and equipment.

Specific Conditions

Albemarle Corporation
 Permit #: 0762-AOP-R16
 AFIN: 14-00028

229. The permittee shall not exceed the emission rates set forth in the following table. [Regulation No. 19 §19.501 *et seq.* and 40 CFR Part 52, Subpart E]

SN-#	Description	Pollutant	lb/hr	tpy
MS-07	Gasoline Storage Tank	VOC	47.70	1.00

230. The permittee shall not exceed the non-criteria emission rates set forth in the following table. [Regulation No. 18 §18.801 and A.C.A §8-4-203 as referenced by §8-4-304 and §8-4-311]

SN-#	Description	Pollutant	lb/hr	tpy
MS-07	Gasoline Storage Tank	Benzene	0.25	0.01
		Hexane	0.23	0.01
		Toluene	0.29	0.01
		Xylene	0.08	0.01
		Ethyl Benzene	0.02	0.01
		Iso-octane	0.29	0.01

231. The gasoline storage tank shall be limited to 200,000 gallons throughput per rolling 12 months. [Regulation No. 19 §19.705, 40 CFR Part 70.6, and A.C.A. §8-4-203 as referenced by §8-4-304 and §8-4-311]
232. Records shall be maintained to demonstrate compliance with the gasoline storage tank throughput limit. The records shall be updated monthly, kept on site, and made available to Department personnel upon request. [Regulation No. 19 §19.705 and 40 CFR Part 52, Subpart E]

Solid Waste Vault No. 2

The Solid Waste Vault No. 2 (SWV-2) is an on-site solid waste landfill. This landfill receives solids from the Drying Bed, the Extraneous Water Filter presses, and numerous solid waste collection points throughout the process units. VOC and particulate emissions from this area are estimated to be de minimis under Group A Number 13 of the Department's Insignificant Activities List.

Outfall 002 Bioreactor

The Outfall 002 Bioreactor is a 30,000 gallon per day package sewage treatment plant, which treats effluents from numerous septic tanks located throughout the plant. The treatment system includes an aeration basin clarifier and chlorine contact chamber. The chlorinator uses swimming pool chlorine tablets for chlorination. This source emits trace amounts of chlorine and methane, and is considered insignificant under Group A Number 13.

PSV-1 Sumps and PSV-1 Leachate Tank

PSV-1 is a closed on-site landfill. This landfill is designed with both primary and secondary liners which underlay the waste. Liquid which collects on top of these liners drains to two in-ground open top collection sumps, one for the primary liner, and one for the secondary liner. The liquid collected in these sumps is pumped to the PSV-1 Leachate Tank, T-9590. The PSV-1 Leachate Tank is an API tank with a nominal capacity of 43,000 gallons. The liquid collected in this tank is trucked off-site for disposal. The liquid which collects in the sumps and tank is

Albemarle Corporation
Permit #: 0762-AOP-R16
AFIN: 14-00028

essentially water with very little contamination. All three of these sources, PSV-1 Primary Liner Sump, PSV-1 Secondary Liner Sump, and PSV-1 Leachate Tank, are insignificant sources under Group A Number 13.

Cooling Towers

The cooling towers on the plant site are treated with a combination of sodium bromide and chlorine. These two chemicals are added simultaneously into a static in-line mixer. The sodium bromide and chlorine react to form sodium chloride and hyperbromus acid. Air emissions for this treatment are estimated to be de minimis under Group A Number 13.

95ND141/Stabrom 909 Production at NC-14

Albemarle will either receive sodium hypochlorite in the process area, or manufacture it between batches in the product reactor. If Albemarle manufactures sodium hypochlorite, it will feed aqueous sodium hydroxide solution to the reactor while gaseous chlorine is bubbled through it. The Caustic Scrubber (SN-TB-14) controls emissions from this process. Finished batches of sodium hypochlorite are pumped to a storage tank for later use. If Albemarle uses purchased sodium hypochlorite it will also be stored in this same tank. The sodium hypochlorite storage tank vents water vapor, nitrogen, and oxygen to the atmosphere.

The inorganic acid used in the process is received in the process area and stored on-site. It is a white crystal with no observed dusting tendencies. Bleach is fed directly to the process, as are bromine, sodium hydroxide, and sodium bromide. Equivalent liquid products can be produced from these new materials.

During these production processes Br₂, BrCl, and Cl₂ may be vented from the reactors to the reactive caustic scrubber (SN-TB-14). Particulate emissions are not expected but quantified for the inorganic acid weighing vessel (SN-TB-40). Oxygen, nitrogen, and water vapor vent from the product storage due to loading and unloading of the product solution and due to breathing losses from daily temperature fluctuations.

Specific Conditions

233. The permittee shall not exceed the non-criteria emission rates set forth in the following table. [Regulation No. 18 §18.801 and A.C.A §8-4-203 as referenced by §8-4-304 and §8-4-311]

SN-#	Description	Pollutant	lb/hr*	tpy*
SN-TB-14	Caustic Scrubber	Br ₂	0.10	0.44
		BrCl	0.10	0.44
		Cl ₂	0.10	0.44
SN-TB-29	Fugitive Emissions	Br ₂	0.10	0.44
		BrCl	0.10	0.44
		Cl ₂	0.10	0.44

* Includes emission estimates for the proposed production scenario only. If methyl-bromide is being produced, these limits may be additive with the new limits listed for the two sources under the other scenarios.

234. The permittee shall conduct initial stack testing for SN-TB-14 within 1500 operating hours following permit issuance of operation of the 95ND141/Stabrom 909 Production Scenario, and every 8760 operating hours thereafter of operation of this scenario. The permittee shall use Method 26A to verify compliance with the Br₂, BrCl, and Cl₂ emission rates set forth in Specific Condition #233. [Regulation No. 18 §18.1002 and A.C.A §8-4-203 as referenced by §8-4-304 and §8-4-311]

Albemarle Corporation
 Permit #: 0762-AOP-R16
 AFIN: 14-00028

Alternate Control Device for SN-BR-12

The permittee may operate the Caustic Drum, SN-BR-15, as an alternative control device during periods when the Bromine Area Scrubber, SN-BR-12, is out of service.

Specific Conditions

235. The permittee shall not exceed the non-criteria emission rates set forth in the following table. [Regulation No. 18 §18.801 and A.C.A §8-4-203 as referenced by §8-4-304 and §8-4-311]

SN-#	Description	Pollutant	lb/hr	tpy
SN-BR-15	Caustic Drum	Br ₂ + Cl ₂	1.60	0.10

236. SN-BR-15 shall not exceed 5% opacity. [Regulation No. 18 §18.501 and A.C.A §8-4-203 as referenced by §8-4-304 and §8-4-311]
237. The permittee shall take immediate corrective action when visible emissions are detectable from SN-BR-15 and shall not operate the source until it is capable of meeting opacity requirements. Records shall be kept of any upset conditions at SN-BR-15 and submitted in accordance with Plantwide Condition 10. [Regulation No. 18 §18.1002 and A.C.A §8-4-203 as referenced by §8-4-304 and §8-4-311]
238. The permittee shall not operate SN-BR-15 more than 120 hours per twelve consecutive months and shall only operate the source during scheduled plant shutdowns or emergency situations where the Bromine Area Scrubber, SN-BR-12, is out of service. [Regulation No. 18 §18.1002 and A.C.A §8-4-203 as referenced by §8-4-304 and §8-4-311]
239. The permittee shall keep records demonstrating compliance with Specific Condition #238. Records shall be updated monthly by the fifteenth day following the month to which the records pertain. The records shall include a twelve month rolling total. Records shall be made available to Department personnel upon request, and otherwise submitted in accordance with General Provision #7. [Regulation No. 18 §18.1002 and A.C.A §8-4-203 as referenced by §8-4-304 and §8-4-311]

Generator Usage

In addition to generators that may be classified as insignificant under ADEQ's insignificant activities list, the permittee may operate diesel, gasoline, butane, propane, or natural gas-fired generators for the purpose of auxiliary power generation.

Specific Conditions

240. The permittee shall not exceed the emission rates set forth in the following table. [Regulation No. 19 §19.501 *et seq.* and 40 CFR Part 52, Subpart E]

SN-#	Description	Pollutant	lb/hr	tpy
SN-MS-08	Electric Generators	PM ₁₀	3.00	1.40
		VOC	8.10	13.20
		SO ₂	2.80	1.30
		NO _x	41.60	19.00
		CO	162.50	19.00

241. The permittee shall not exceed the non-criteria emission rates set forth in the following table. [Regulation No. 18 §18.801 and A.C.A §8-4-203 as referenced by §8-4-304 and §8-4-311]

SN-#	Description	Pollutant	lb/hr	tpy
SN-MS-08	Electric Generators	PM	3.0	1.4

242. The permittee shall not exceed 20% opacity at SN-MS-08. Compliance shall be demonstrated by the use of diesel, gasoline, or butane only. [Regulation No. 19 §19.503 and 40 CFR Part 52, Subpart E]
243. The permittee shall not produce more than a total of 64,500 kW-hrs of electrical power annually. The sum of all generators shall not exceed a total rated power output of 1000 kW using diesel fuel. A maximum of 275.5 kW within the overall 1000 kW limit may be fueled by gasoline or butane. [Regulation No. 19 §19.705, 40 CFR 70.6, and A.C.A§ 8-4-203 as referenced by §8-4-304 and §8-4-311]
244. The permittee shall maintain monthly records of electrical production demonstrating compliance with Specific Condition #243. As an alternative, the permittee may perform monthly calculations using appropriate AP-42 emission factors to verify compliance with the emission rate in Specific Condition #240. Records shall be updated monthly by the fifteenth day following the month to which the records pertain. The records shall include a twelve month rolling total. Records shall be made available to Department personnel upon request, and otherwise submitted in accordance with General Provision #7. [Regulation No. 19 §19.705, 40 CFR 70.6, and A.C.A§ 8-4-203 as referenced by §8-4-304 and §8-4-311]

Albemarle Corporation
Permit #: 0762-AOP-R16
AFIN: 14-00028

NaBr Production in NC-14 Reactor

In this alternate operating scenario, the permittee produces NaBr in either a batch or continuous process in the NC-14 Reactor. The associated area scrubber, SN-TB-03, will be used for emission control.

Specific Conditions

245. The permittee shall not exceed the non-criteria emission rates set forth in the following table. [Regulation No. 18 §18.801 and A.C.A §8-4-203 as referenced by §8-4-304 and §8-4-311]

SN-#	Description	Pollutant	lb/hr	tpy
SN-TB-03	Area Scrubber	Br ₂ +HBr	0.10	0.44

246. The permittee shall conduct initial stack testing for SN-TB-03 within 1500 hours of operation of the NaBr Production Scenario, and every 8760 operating hours thereafter of operation of this scenario. The permittee shall use Method 26A to verify compliance with the Br₂ and HBr emission rates set fourth in Specific Condition #245. [Regulation No. 18 §18.1002 and A.C.A §8-4-203 as referenced by §8-4-304 and §8-4-311]

EtBr at NC-14

Under an alternate operating scenario, Albemarle may produce ethyl bromide (EtBr) at the NC-14 production unit. EtBr may be produced using equipment already in place that is permitted under the MeBr production scenario.

The permittee will operate this scenario under the same emission limits as it would under the MeBr scenario with some exceptions. Permitted emission limits at the spent sulfuric acid tank (SN-TB-12) are increased as a result of the scenario. The permittee may also operate a new source, the Raw Material Recovery/ Disposal (SN-TB-37). At this source effluent from the EtBr production scenario is loaded into trucks and introduced into the NC-23 process or neutralized and disposed in the extraneous water system.

Specific Conditions

247. During EtBr production the permittee shall not exceed the emission rates set forth in the following table. [Regulation No. 19 §19.501 *et seq.* and 40 CFR Part 52, Subpart E]

SN-#	Description	Pollutant	lb/hr	tpy
TB-03	Area Process Scrubber (Ethyl Bromide Recovery Unit)	VOC	10.7	7.50
TB-12	Spent Sulfuric Acid Storage	VOC	0.53	0.38
TB-29	NC-14 Fugitive Emissions	VOC	3.47	2.40
TB-30	Ethanol Storage Tank	VOC	11.30	6.30
TB-37	Raw Material Recovery	VOC	1.34	0.94

248. During EtBr production the permittee shall not exceed the non-criteria emission rates set forth in the following table. [Regulation No. 18 §18.801 and A.C.A §8-4-203 as referenced by §8-4-304 and §8-4-311]

SN-#	Description	Pollutant	lb/hr	tpy
TB-12	Spent Sulfuric Acid Storage	H ₂ SO ₄	0.01	0.01
TB-29	NC-14 Fugitive Emissions	Br ₂ +HBr	0.46	0.32
TB-37	Raw Material Recovery	HBr	0.10	0.10

249. The permittee shall not exceed 5% opacity at SN-TB-37. [Regulation No. 18 §18.501 and A.C.A. §8-4-203 as referenced by §8-4-304 and §8-4-311]
250. The permittee shall not operate the EtBr scenario more than 1400 hours per 12 consecutive months. [Regulation No. 19 §19.705, 40 CFR 70.6, and A.C.A § 8-4-203 as referenced by §8-4-304 and §8-4-311]
251. The permittee shall keep monthly records to demonstrate compliance with Specific Condition #250. Records shall be updated by the 15th day of the month following the month to which the records pertain. A twelve month rolling total shall be kept. Records shall be kept on-site and made available to Department personnel upon request. Records shall be submitted in accordance with General Provision 7. [Regulation No. 19 §19.705 and 40 CFR Part 52, Subpart E]

Albemarle Corporation
Permit #: 0762-AOP-R16
AFIN: 14-00028

252. The permittee shall comply with all applicable provisions §60.482-1 (General), §60.482-2 (Pumps in light liquid service), §60.482-3 (Compressors), §60.482-4 (Pressure relief devices in gas /vapor service), §60.482-5 (Sampling connection systems), §60.482-6 (Open-ended valves or lines), §60.482-7 (Valves in gas vapor service and in light liquid service), §60-482-8 (Pumps and valves in heavy liquid service, pressure relief devices in light liquid or heavy liquid service, and connectors), §60.482-9 (Delay of repair requirements), §60.481-10 (Closed vent systems and control devices), §60.483-1 (Allowable percentage of valves leaking), §60.483-2 (Alternate standards of valves - Skip period leak detection and repair), §60.485 (Test methods and procedures), §60.486 (Recordkeeping), and §60.487 (Reporting). [Regulation No. 19 §19.304 and 40 CFR 60, Subpart VV]

Oil Separator Tank – T-292

Albemarle is allowed the flexibility to heat -treat the contents of SN-BT-29 (T-292). The tank has been removed from the Insignificant Activities list and listed as a permitted source.

Specific Conditions

253. The permittee shall not exceed the emission rates set forth in the following table. [Regulation No. 19 §19.501 *et seq.* and 40 CFR Part 52, Subpart E]

SN	Description	Pollutant	lb/hr	tpy
BT-29	Oil Separator Tank (T-292)	VOC	30.00	1.95

254. The permittee shall not exceed the non-criteria emission rates set forth in the following table. [Regulation No. 18 §18.801 and A.C.A §8-4-203 as referenced by §8-4-304 and §8-4-311]

SN	Description	Pollutant	lb/hr	tpy
BT-29	Oil Separator Tank (T-292)	H ₂ S	0.01	0.05
		Benzene	3.87	0.04
		Toluene	1.34	0.02
		Xylene	0.28	0.01
		Hexane	3.12	0.04

255. The permittee shall not exceed 10 batches per twelve consecutive months at SN-BT-29. [Regulation No. 19 §19.705, 40 CFR 70.6, and A.C.A§ 8-4-203 as referenced by §8-4-304 and §8-4-311]

256. The permittee shall keep monthly records of batch throughput at SN-BT-29. Records shall be updated by the 15th day of the month following the month to which the records pertain. A twelve month rolling total shall be kept. Records shall be kept on-site and made available to Department personnel upon request. Records shall be submitted in accordance with General Provision #7. [Regulation No. 19 §19.705 and 40 CFR Part 52, Subpart E]

257. RESERVED

Albemarle Corporation
 Permit #: 0762-AOP-R16
 AFIN: 14-00028

HCl Loading Operation Scenarios

Albemarle has two options for handling the displaced vapors from the loading of the HCl co-product into tanker trucks. The controlled loading operation ultimately results in the displaced vapors to be routed to the Vent Gas Incinerator (SN-21-01) for the NC-21 flame retardant process.

The second option, an uncontrolled HCl loading operation, involves benzene being recovered and recycled from the co-product HCl stream through the use of a distillation column. After being purified, the benzene concentration in the co-product HCl stream will be 30 ppmw or less. The co-product stream can either be routed to intermediate storage or be loaded out via tank truck. Benzene recovered in the distillation column is condensed and combined with other recovered benzene streams for reuse in the NC-21 process unit. The displaced vapors from the trucks are emitted to the atmosphere.

Albemarle has the option of installing the distillation column or not. Specific Conditions #258 through #261 only apply if the distillation column is operated (second option).

Specific Conditions

258. The permittee shall not exceed the emission rates set forth in the following table. Compliance with this condition shall be demonstrated through compliance with Specific Conditions #260 and #261. [Regulation No. 19 §19.501 et seq. and 40 CFR Part 52, Subpart E]

SN-#	Description	Pollutant	lb/hr	tpy
21-04	HCl Loading Operation (Option #2)	VOC	0.80	0.20

259. The permittee shall not exceed the non-criteria emission rates set forth in the following table. Compliance with this condition shall be demonstrated through compliance with Specific Conditions #260 and #261. [Regulation No. 18 §18.801 and A.C.A §8-4-203 as referenced by §8-4-304 and §8-4-311]

SN-#	Description	Pollutant	lb/hr	tpy
21-04	HCl Loading Operation (Option #2)	Benzene	0.80	0.20
		HCl	0.30	0.10

260. The facility shall use a method approved by the Department to test the HCl co-product stream to demonstrate benzene concentration does not exceed 30 ppmw. This testing shall be performed in accordance with Plantwide Condition #3 and then once every quarter for the first two years after which time the testing shall be performed once every five years coinciding with the submittal of the Title V Renewal application. Each quarterly test must be performed at least 30 days after the previous quarterly test. Within 30 days after testing, a copy of the testing information shall be sent to the address below.

Albemarle Corporation
Permit #: 0762-AOP-R16
AFIN: 14-00028

Arkansas Department of Environmental Quality
Air Division
Attn.: Air Enforcement
Post Office Box 8913
Little Rock, AR 72219

[Regulation No. 18 §18.1002 and A.C.A. §8-4-203 as referenced by §8-4-304 and §8-4-311]

261. The permittee shall calculate benzene and HCl emissions from the HCl Loading operations once per year. Pound per hour emissions shall be based upon worst-case conditions, and ton per year emissions upon a 12-month period. A copy of the calculations shall be kept on site and made available to Department personnel upon request. [Regulation No. 18 §18.1004 and A.C.A §8-4-203 as referenced by §8-4-304 and §8-4-311]
262. The permittee shall route all displaced gas from HCl loading operations to SN-21-01 if the concentration of benzene in the co-product stream is greater than 30 ppmw or if the distillation column at SN-24-01 is not installed. As of July 27, 2004, this distillation column has not been installed. [Regulation No. 18 §18.1004 and A.C.A. §8-4-203 as referenced by §8-4-304 and §8-4-311]

NC-24 Production

The NC-24 process produces two isomers of a desired alkyl bromide product by reacting the base hydrocarbon olefin with HBr. The HBr comes from South Plant facilities. The olefin is stored under pressure with emissions routed to a flare (SN-AD-26). The reaction takes place in a continuously operated reactor where the reactants are added and the crude product is withdrawn simultaneously. As a continuous reactor under pressure, the reactor has no normal vent during the reaction process.

The crude product contains a mixture of HBr and the two alkyl bromide isomers. The organic product is washed with water in the Wash Column (SN-24-01) to remove the residual HBr. HBr is preferentially absorbed into the aqueous phase forming an aqueous acid stream. The organic product retained in the wash water acid is recovered in the Acid Stripper by routing the stripper overheads back to the Wash Column. The organic product is dewatered in the Organic Dryer, and residual organic or acid in the dryer over heads are recovered in the Wash Column. The stripped acid will be stored in the Wash Water Tank (SN-CB-10) before being used elsewhere at the South Plant. The dewatered crude product will be sent downstream for further processing.

After being dewatered, the crude product is fed to two distillation columns in series. The back-end processes operate with two Refrigerated Vent Condensers (SN-TB-25) used to recover product and raw material. The two columns are designed to separate the two alkyl bromide isomers into two distinct product streams and one organic waste stream. One of the isomers is blended with a small amount of 1,2-epoxybutane, and both isomers are stored before being loaded for sale. The organic waste is drummed and will be shipped off-site for processing. Emissions from all of the product purification, storage, and loading operation will be routed to the Refrigerated Vent Condensers (SN-TB-25).

NC-24 Production Alternate Scenario –Periods of No Reaction

When the reactor loses the reaction, the raw material vapors (propylene and hydrogen bromide) may build up and must be vented before re-initiating the reaction. The vapors are vented to the Wash Column (SN-24-01), which absorbs the hydrogen bromide just as in the primary operating scenario. Propylene will pass through the wash column unaffected.

The process will be controlled such that the flaring (SN-AD-26) and depressurization of the reactor will not occur at the same time. The pressure control valve on the NC-24 reactor is designed to allow no more than 48.5 lb/hr of VOC which is the same rate VOC would otherwise be routed to the flare in the primary operating scenario.

Specific Conditions

263. The permittee shall not exceed the emission rates set forth in the following table.
 [Regulation No. 19 §19.501 *et seq.* and 40 CFR Part 52, Subpart E]

SN-#	Description	Pollutant	lb/hr	tpy
24-01	Wash Column (Primary Operating Scenario)	VOC	48.50	17.70
24-01	Wash Column (Alternate Scenario)	VOC	48.50	0.60

SN-#	Description	Pollutant	lb/hr	tpy
24-02	NC-24 Fugitives	VOC	1.20	5.10
AD-26	ADMA Flare*	PM ₁₀	0.80	0.10
		SO ₂	0.10	0.10
		VOC	48.50	0.60
		CO	18.90	0.30
		NO _x	3.50	0.10
TB-25	Refrigerated Vent Condensers	VOC	47.70	5.80

* SN-AD-26 is not operated as an emergency control device in this scenario. Therefore, the operation of this source does not need to be reported as an upset condition as is required under the Alkyl Amines Process (Specific Conditions #61 and #62)

264. The permittee shall not exceed the non-criteria emission rates set forth in the following table. [Regulation No. 18 §18.801 and A.C.A §8-4-203 as referenced by §8-4-304 and §8-4-311]

SN-#	Description	Pollutant	lb/hr	tpy
24-01	Wash Column*** (Primary Operation Scenario)	HBr	0.10	0.50
		Acetone	0.10	0.10
		HCl	0.10	0.50
		1,2-Epoxybutane	0.10	0.10
24-01	Wash Column*** (Alternate Scenario)	HBr	0.10	0.50
		Acetone	0.10	0.10
		HCl	0.10	0.50
24-02	NC-24 Fugitives	HBr	0.10	0.40
		Acetone	0.10	0.10
		HCl	0.10	0.20
		Ethylene Glycol	0.20	0.60
		1,2-Epoxybutane	0.10	0.10
AD-26*	Emergency Flare**	PM	0.80	0.10
TB-25*	Refrigerated Vent Condensers	HBr	0.10	0.10
		Acetone	0.10	0.10
		HCl	0.10	0.10
		1,2-Epoxybutane	1.30	0.10

* This source is used in other production/operating scenarios. The emission limits listed above are only applicable to NC-24 production.

** SN-AD-26 is not operated as an emergency control device in this scenario. Therefore, the operation of this source does not need to be reported as an upset condition as is required under the Alkyl Amines Process (Specific Conditions #61 and #62)

*** The limits are the total emissions between the two operating scenario.

265. The permittee shall demonstrate compliance with the hourly emission limits for SN-24-01 by maintaining a daily average chilled water flow of 1,700 lb/hr or greater and a daily average chilled water temperature of 60 °F or less. [Regulation No. 19 §19.705, 40 CFR Part 70.6, and A.C.A §8-4-203 as referenced by §8-4-304 and §8-4-311]

Albemarle Corporation
Permit #: 0762-AOP-R16
AFIN: 14-00028

266. The permittee shall demonstrate compliance with the hourly emission limits for SN-TB-25 by maintaining a daily average glycol coolant temperature less than or equal to 40 °F while receiving vapors from the process. [Regulation No. 19 §19.705, 40 CFR Part 70.6, and A.C.A §8-4-203 as referenced by §8-4-304 and §8-4-311]
267. The permittee shall maintain daily records which demonstrate compliance with the minimum flow rate of water and maximum temperatures specified in Specific Conditions #265 and #266. These records shall be kept onsite and be made available to Department personnel upon request. [Regulation No. 19 §19.705 and 40 CFR Part 52, Subpart E]
268. The permittee shall not produce more than 2,800,000 gallons per year of NC-24 product. [Regulation No. 19 §19.705, 40 CFR Part 70.6, and A.C.A §8-4-203 as referenced by §8-4-304 and §8-4-311]
269. The permittee shall not use more than 50,000 gallons per year of 1,2-Epoxybutane products. [Regulation No. 19 §19.705, 40 CFR Part 70.6, and A.C.A §8-4-203 as referenced by §8-4-304 and §8-4-311]
270. The permittee shall maintain monthly records demonstrating compliance with Specific Conditions #268 and #269. Records shall be updated by the 15th day following the month to which the records pertain, made available to Department personnel upon request, and otherwise in accordance with General Provision 7. [Regulation No. 19 §19.705, Regulation No. 18 §18.1004, 40 CFR Part 52, Subpart E, and A.C.A §8-4-203 as referenced by §8-4-304 and §8-4-311]
271. The permittee shall maintain records of each raw material venting event to SN-AD-26. These records shall contain the date, time, duration of each event, and total duration per rolling twelve month period. If the total duration exceeds 24 hours in any twelve (12) month period, then the permittee shall calculate the emissions for each event in order to demonstrate compliance with the limits in Specific Conditions #263 and #264. These records shall be updated following each event, kept onsite and made available to Department personnel upon request. Specific Conditions #61 and #62 of the ADMA section of this permit do not apply during the NC-24 alternate operating scenario. [Regulation No. 19 §19.705, Regulation No. 18 §18.1004, 40 CFR Part 52, Subpart E, and A.C.A §8-4-203 as referenced by §8-4-304 and §8-4-311]
272. The permittee shall maintain records of each raw material venting event to SN-24-01. These records shall contain the date, time, duration of each event, and total duration per rolling twelve month period. The permittee shall calculate the VOC, HBr, and HCl emissions for each event in order to demonstrate compliance with the limits in Specific Conditions #263 and #264 when operating under the alternate operating scenario. These records shall be updated following each event, kept onsite and made available to Department personnel upon request. [Regulation No. 19 §19.705, Regulation No. 18 §18.1004, 40 CFR Part 52, Subpart E, and A.C.A §8-4-203 as referenced by §8-4-304 and §8-4-311]

Vent Gas Incinerator (SN-21-01) and Vent Gas Oxidizer (SN-16-18) Testing Scenario

During the alternate testing scenario, all normal process operations at the NC-16 or NC-21 process units will be shutdown except for the vent gas oxidizer (SN-16-18) or vent gas oxidizer (SN-21-01), which will be fed a known mass feed rate in a synthetic vent stream in order to simulate worst-case inlet pollutant loading.

Specific Conditions

273. The permittee shall not exceed the emission rates set forth in the following table. These emission limits are applicable only for the purpose of conducting performance tests to determine if the control devices can comply with the emission standards in 40 CFR Part 63, Subpart FFFF while operating at worse case conditions. [Regulation No. 19 §19.501 *et seq.* and 40 CFR Part 52, Subpart E]

SN-#	Description	Pollutant	lb/day
21-01	Vent Gas Incinerator	VOC	41.1
		Benzene	41.1
16-18	Vent Gas Oxidizer	VOC	27.4
		Xylene + Ethyl Benzene	24.0

274. The permittee shall perform all testing under this scenario identified as the worst case operating conditions and test methods according to the site specific test plan that has been approved by the EPA. Testing under this condition shall not exceed 72 hours and requires prior approval from ADEQ. [Regulation No. 18 §18.1002 and A.C.A. §8-4-203 as referenced by §8-4-304 and §8-4-311]
275. The permittee shall submit to ADEQ Air Division Enforcement a notice at least 15 days in advance of this testing. This notice shall be signed by the plant manager and shall contain the following: [Regulation No. 18 §18.1004 and A.C.A. §8-4-203 as referenced by §8-4-304 and §8-4-311]
- a. Identification of the source to be tested;
 - b. A detailed description of the test conditions;
 - c. Anticipated duration of the test;
 - d. Sampling frequency;
 - e. Total amount of hazardous air pollutant to be feed to the tested source;
 - f. A copy of the site specific test plan, and if applicable, any related correspondence to or from EPA regarding the site-specific test plan;
 - g. The anticipated date of the test; and
 - h. An affidavit signed by the plant manager to immediately cease feeding hazardous air pollutants to either of the sources if the limit in Specific #273 will be exceeded before the anticipated duration of the test.

Albemarle Corporation
Permit #: 0762-AOP-R16
AFIN: 14-00028

276. The permittee shall within 30 days of completing the performance test submit a complete test report and calculations that demonstrate emissions did not exceed the limits in Specific Condition #273. [Regulation No. 18 §18.1004 and A.C.A. §8-4-203 as referenced by §8-4-304 and §8-4-311]

NC-15 Area Scrubber (SN-15-12) Testing Scenario

During the alternate testing scenario, the SN-15-12 will be tested while using fresh water instead of a caustic solution in the final spray step.

Specific Conditions

277. The permittee shall not exceed the emission rate set forth in the following table. This emission limit is applicable only for the purpose of testing the scenario when the media in the final spray step is fresh water rather than caustic solution. [Regulation No. 18 §18.1004 and A.C.A. §8-4-203 as referenced by §8-4-304 and §8-4-311]

SN-#	Description	Pollutant	lb/day
15-12	NC-15 Area Scrubber	Br ₂ + HBr	26.16

278. The permittee shall conduct stack testing for bromine at SN-15-12 during the scenario identified in Specific Condition #277. The testing shall be conducted using EPA Reference Method 26A. Testing under this condition require prior approval from ADEQ. [Regulation No. 18 §18.1002 and A.C.A §8-4-203 as referenced by §8-4-304 and §8-4-311]
279. The permittee shall submit to ADEQ Air Division Enforcement a notice at least 15 day in advance of this testing. This notice shall be signed by the plant manager and shall contain the following: [Regulation No. 18 §18.1004 and A.C.A. §8-4-203 as referenced by §8-4-304 and §8-4-311]
- a. Identification of the source to be tested
 - b. A detailed description of the test conditions
 - c. Anticipated duration of the test
 - d. Sampling frequency
 - e. An affidavit signed by the plant manager to immediately return to spraying caustic solution instead of fresh water if the limit in Specific #277 will be exceeded before the anticipated duration of the test or through the combination of the test and normal operation in any consecutive 24 hour period.
280. The permittee shall within 30 days of completing the performance test submit a complete test report and calculations that demonstrate emissions did not exceed the limits in Specific Condition #277. [Regulation No. 18 §18.1004 and A.C.A. §8-4-203 as referenced by §8-4-304 and §8-4-311]

Methyl Bromide Production at NC-23

Methyl bromide (MeBr) is produced by reacting hydrogen bromide with methanol. The reaction product is purified to isolate MeBr. The MeBr is compressed into the liquid state, and temporarily stored before being unloaded into railcars. The vapors from the storage tanks, processing equipment, and transfer operations are controlled by a product recovery system, where the MeBr is recovered and sent back to the purification process. Therefore, the methyl bromide recovery unit also serves as the emission control device for the process. The unreacted methanol (in water solution) is sent to the methanol recovery system, where the methanol is recovered and sent back to be used as feedstock for the reaction.

Under an alternate methanol recovery scenario, methanol introduced in the MeBr recovery system is also routed to the methanol recovery system where the methanol is recovered and recycled for use as feedstock. The water left over from methanol recovery has brine value and; therefore, is piped to the bromine recovery process. Thus, HON process wastewater stream is not generated.

Methyl bromide is a Class I, Group VI, ozone depleting substance (ODS). 40 CFR Part 82, Subpart A, is applicable to the MeBr process. During MeBr production, affected sources in this unit are also subject to the requirements of 40 CFR Part 63, Subparts F, G, and H.

Compliance with permitted emission rates in the NC-23 process area while producing MeBr shall be demonstrated through stack testing, parametric monitoring, and record keeping requirements.

Specific Conditions

281. The permittee shall not exceed the emission rates set forth in the following table. [Regulation No. 19 §19.501 *et seq.* and 40 CFR Part 52, Subpart E]

SN-#	Description	Pollutant	lb/hr	tpy
23-01	NC-23 Fugitives (NC-23 MeBr Production Scenario)	VOC	2.33	10.21
23-03	Raw Material Scrubber (NC-23 MeBr Production Scenario)	VOC	27.37	1.68
23-05	Vent Absorber (NC-23 MeBr Production Scenario)	VOC	1.60	7.00
23-16	Spent Sulfuric Acid Storage Tank (NC-23 MeBr Production Scenario)	VOC	0.10	0.10
23-17	Refrigerant Water Storage Tank (NC-23 MeBr Production Scenario)	VOC	0.01	0.01
23-18	Refrigerant Water Storage Tank (NC-23 MeBr Production Scenario)	VOC	0.01	0.01
TB-25	Refrigerated Vent Condensers (NC-23 MeBr Production Scenario)	VOC	0.45	2.00

Albemarle Corporation
 Permit #: 0762-AOP-R16
 AFIN: 14-00028

282. The permittee shall not exceed the non-criteria emission rates set forth in the following table. [Regulation No. 18 §18.801 and A.C.A §8-4-203 as referenced by §8-4-304 and §8-4-311]

SN-#	Description	Pollutant	lb/hr	tpy
23-01	NC-23 Fugitives (NC-23 MeBr Production Scenario)	Methanol	0.97	4.25
		Methyl Bromide	0.97	4.25
23-03	Raw Material Scrubber (NC-23 MeBr Production Scenario)	Methanol	27.37	1.68
23-05	Vent Absorber (NC-23 MeBr Production Scenario)	Methanol	0.40	1.80
		Methyl Bromide	0.90	4.00
23-16	Spent Sulfuric Acid Storage Tank (NC-23 MeBr Production Scenario)	Methanol	0.10	0.10
		H ₂ SO ₄	0.01	0.05
23-17	Refrigerant Water Storage Tank (NC-23 MeBr Production Scenario)	Ethylene Glycol	0.01	0.01
23-18	Refrigerant Water Storage Tank (NC-23 MeBr Production Scenario)	Ethylene Glycol	0.01	0.01
TB-25	Refrigerated Vent Condensers (NC-23 MeBr Production Scenario)	Methanol	0.45	2.00
TB-30	Fresh Sulfuric Acid Storage Tank (NC-23 MeBr Production Scenario)	H ₂ SO ₄	0.01	0.05

283. The following sources are subject to Subparts F, G, and H (the HON rule). The permittee shall comply with all applicable requirements of the HON, including but not limited to the requirements listed in this permit. [Regulation No. 19 §19.304 and 40 CFR Part 63]

Source Number [†]	Name	HON Source Type	HON Group
23-01	NC-14 Fugitive Emissions	Equipment Leaks	NA (Subpart H)
23-03	Methanol Feed Storage Tank	Storage Vessel	Group 1
23-05	Methyl Bromide Recovery Unit	Process Vent	Group 2
N/A	Methyl Bromide Transfer Rack*	Transfer Operation	Group 1
N/A	Methyl Bromide Storage Tank D-8725*	Storage Vessel	Group 2
N/A	Methyl Bromide Storage Tank D-8726*	Storage Vessel	Group 2
N/A	Methyl Bromide Rundown Tank*	Storage Vessel	Group 2
N/A	Methanol Recovery Column Feed Tank (D-22)*	N/A (See below)	N/A
TB-25	Methanol Recovery Column Vent	Process Vent	Group 2
WW-01	Methanol Recovery Column Water Discharge	Wastewater	Group 2

* These sources are routed to SN-23-05.

† SN-23-16 emits methanol which is a HON regulated pollutant. The storage tank is not subject to HON requirements because methanol occurs as an impurity. The for the purpose of the HON the definition for storage vessel excludes vessels storing organic liquids that contain organic hazardous air pollutants only as impurities.

Albemarle Corporation
Permit #: 0762-AOP-R16
AFIN: 14-00028

General HON Related Conditions

284. The requirements of Subparts G and H apply at all times, except during periods of startup, shutdown, malfunction, or non-operation of the unit resulting in cessation of emissions to which Subparts F and G apply. [Regulation No. 19 §19.304 and 40 CFR §63.102(a)]
285. The permittee shall develop, implement, retain, and revise (as necessary) a written startup, shutdown, and malfunction (SSM) plan that describes, in detail, procedures for operating and maintaining the affected sources during SSM and a program of corrective action for malfunctioning process and air pollution control equipment used to comply with the relevant standard. The SSM plan and any revision to the plan is incorporated by reference and is enforceable as a term and condition of this permit. Any revisions to the plan are automatically incorporated by reference and do not require a permit revision. [Regulation No. 19 §19.304 and 40 CFR §63.6(e)(3)]
286. The permittee shall submit a Notification of Compliance Status (NCS) within 150 calendar days after initial start-up of the methyl bromide production unit. [Regulation No. 19 §19.304 and 40 CFR §63.152(b)]
287. All required Periodic Reports shall be submitted semi-annually no later than 60 days after the end of each 6-month period. Reports shall be submitted no later than 8 months after the date the NCS is due, and shall cover the 6-month period beginning on the date the NCS is due. Subsequent reports are due every six months after the date that the first report was due as long as the MeBr unit operates in this unit. [Regulation No. 19 §19.304 and 40 CFR §63.152(c)(1)]

MeBr Process Vent Conditions

288. The permittee shall recalculate, as applicable, the TRE index value, flow, or organic hazardous air pollutants concentration for each Group 2 process vent whenever process changes are made that could reasonably be expected to change the vent to a Group 1 vent. [Regulation No. 19 §19.304 and 40 CFR §63.115(e)]
289. The NCS shall include documentation of all assumptions and procedures used to determine the TRE index value for the methyl bromide recovery unit process vent (SN-23-05). [Regulation No. 19 §19.304 and 40 CFR §63.117(b)]
290. The NCS shall include documentation of all assumptions and procedures used to determine the TRE index value for the methanol recovery column process vent (SN-TB-25). [Regulation No. 19 §19.304 and 40 CFR §63.117(d)]
291. Emissions during methyl bromide production shall not exceed the limits listed in the following table. Compliance with these emission limits shall be demonstrated by

Albemarle Corporation
 Permit #: 0762-AOP-R16
 AFIN: 14-00028

complying with monitoring, reporting, and record keeping requirements of the HON.
 [Regulation No. 19 §19.304 and 40 CFR Part 63, Subpart G]

SN-#	Description	Pollutant	lb/hr	tpy
23-05	Vent Absorber <i>(NC-23 MeBr Production Scenario)</i>	Methanol	0.40	1.80
		Methyl Bromide	0.90	4.00
TB-25	Refrigerated Vent Condensers <i>(NC-23 MeBr Production Scenario)</i>	Methanol	0.45	2.00

MeBr Storage Vessel Conditions

- 292. Reserved.
- 293. The permittee shall keep readily accessible records for each Group 1 or Group 2 storage vessel showing the dimensions of the storage vessel, and an analysis showing the capacity of the storage vessel. This record shall be kept as long as the storage vessel retains Group 1 or Group 2 status and is in operation. [Regulation No. 19 §19.304 and 40 CFR §63.123(a)]
- 294. The water scrubber associated with the methanol storage tank (SN-23-03) shall reduce emissions of total organic HAP by 95 weight percent. Compliance with this condition shall be demonstrated by the design evaluation included in the NCS and by compliance with Specific Condition #295. The methanol storage tank (SN-23-03) shall be vented to the associated water scrubber at all times, except for the 240 hours per year allowable under 40 CFR §63.119(e). [Regulation No. 19 §19.304 and 40 CFR §63.119(e)]
- 295. The permittee shall monitor the daily average flow to demonstrate compliance with the monitoring plan requirements for storage tanks and maintain records of the results of required monitoring. [Regulation No. 19 §19.304 and 40 CFR §63.120(d)(2)(i)]

Note: A design evaluation showed 500 lb/hr of scrubber water flow will be sufficient to meet the 95% control requirement.

MeBr Transfer Operations

- 296. The methyl bromide recovery unit (SN-23-05) shall be operated at all times when organic HAPs are vented to it. Any deviation from this condition shall be reported in the start-up, shutdown, and malfunction reports required under 40 CFR §63.10(d)(5). [Regulation No. 19 §19.304 and 40 CFR §63.126(a)(3)]
- 297. The methyl bromide recovery unit (SN-23-05) shall reduce emissions of total organic HAPs from methyl bromide loading operations by 98 weight percent. Compliance with this condition is demonstrated by the design evaluation included in the NCS and by compliance with Specific Conditions #298 and #299. [Regulation No. 19 §19.304 and 40 CFR §63.126(b)]

Albemarle Corporation
Permit #: 0762-AOP-R16
AFIN: 14-00028

298. The permittee shall maintain a liquid mass flow rate (in lb/hr) to gas mass flow rate (in lb/hr) ratio in the absorber column of the methyl bromide recovery unit (SN-23-05) equal to or greater than 5.7. [Regulation No. 19 §19.304 and 40 CFR §63.126(b), §63.127(e)]
299. The permittee shall maintain a temperature in the methyl bromide stripper of the methyl bromide recovery unit (SN-23-05) equal to or greater than 170 °F at the top of the stripping section at the operating pressure of 25 psia. [Regulation No. 19 §19.304 and 40 CFR §63.126(b), §63.127(e)]
300. The permittee shall comply with all applicable requirements related to methyl bromide transfer operations. [Regulation No. 19 §19.304 and 40 CFR §63.126(f), (g), (h), and (i)]
301. The permittee shall maintain continuous (as defined in §63.111) records of absorber liquid-to-gas ratio and stripper overhead temperature while the transfer stream is being vented to the methyl bromide recovery unit, and shall maintain records of the daily average value for each parameter for each operating day. [Regulation No. 19 §19.304 and 40 CFR §63.130(a)]
302. The permittee shall submit Periodic Reports as specified in §63.130(d). [Regulation No. 19 §19.304 and 40 CFR Subpart G]
303. The permittee shall maintain the DOT tank certification or Method 27 testing records as required by §63.130(e). [Regulation No. 19 §19.304 and 40 CFR Subpart G]
304. The permittee shall annually update and maintain, in a readily accessible location on site, the transfer rack information required in 40 CFR §63.130(f). [Regulation No. 19 §19.304 and 40 CFR Subpart G]

MeBr Wastewater Conditions, if wastewater is generated (Note: If wastewater is generated, the only organic HAP it will contain above trace quantities is methanol)

305. The permittee shall submit the SN-WW-01 information as required in Table 15 of Subpart G with the NCS. [Regulation No. 19 §19.304 and 40 CFR §63.146(b)(2)]
306. The permittee shall keep readily accessible records documenting how process knowledge was used to determine the annual average organic HAP concentration and/or annual average flow rate of SN-WW-01. [Regulation No. 19 §19.304 and 40 CFR §63.147(f)]

MeBr Equipment Leaks

307. The permittee shall comply with all applicable sections of §63.160 through §63.182. [Regulation No. 19 §19.304 and 40 CFR 63, Subpart H]

Albemarle Corporation
Permit #: 0762-AOP-R16
AFIN: 14-00028

Ozone Depleting Substance (ODS)

308. The permittee may not produce methyl bromide at any time in a control period (except that are transformed or destroyed domestically or by a person of another party) in excess of the amount of unexpended production allowances or unexpended Article 5 allowances held. [Regulation No. 19 §19.304 and 40 CFR Part 82, Subpart A, Paragraph 82.4(a) (see Appendix A)]
309. The permittee may not produce or (except for transshipments, heels, or used controlled substances) import methyl bromide, at any time in a control period (except for controlled substances that are transformed or destroyed), in excess of unexpended consumption allowances held. [Regulation No. 19 §19.304 and 40 CFR Part 82, Subpart A, Paragraph 82.4(c)]
310. Production and consumption allowances may be adjusted by the procedures in paragraphs §82.9, §82.10, §82.11, and §82.12. [Regulation No. 19 §19.304 and 40 CFR Part 82, Subpart A]
311. The permittee shall conform with the record keeping and reporting practices for methyl bromide as outlined in Paragraph §82.13. [Regulation No. 19 §19.304 and 40 CFR Part 82, Subpart A]
312. All containers in which methyl bromide is stored or transported must be labeled as outlined in Paragraphs 82.106, 82.108, and 82.110. [Regulation No. 19 §19.304 and 40 CFR Part 82, Subpart A]
313. Producer Quarterly Reports must be mailed to the Administrator within 45 days of each calendar quarter, as outlined in Paragraphs 82.13(c) and 82.13(f)(3). [Regulation No. 19 §19.304 and 40 CFR Part 82, Subpart A]

Albemarle Corporation
Permit #: 0762-AOP-R16
AFIN: 14-00028

MON MACT Affected Sources

Miscellaneous Organic Chemical Processing Units (MCPU)

The following MCPUs exist at the facility and are subject to the requirements of 40 CFR Part 63, Subpart FFFF:

MON Affected MCPUs	Page Number
Alkyl Amines (ADMA) Unit	118
DMTDA Unit	119
NC-12 Unit	121
NC-15 Unit	121
NC-16 Unit	122
NC-18 Unit (BT-93W Process Only)	122
NC-21 Unit	125
NC-22 Unit	129
NC-23 Unit	129
NC-24 Unit	130

Generally Applicable Subpart A and MON MACT Requirements

The following section outlines the requirements that are generally applicable since at least one MON-affected process unit exists at this facility. Applicable 40 CFR 63, Subpart A general provisions and the generally applicable provisions of 40 CFR Part 63, Subpart FFFF include but are not limited to the following conditions.

Specific Conditions

1. The permittee will comply with the applicable provisions as specified in Title 40 of the Code of Federal Regulations (CFR), Part §63, Subpart A - *General Provisions*. [Regulation No. 19 §19.304 and 40 CFR Part 63, Subpart A]
2. For the MON-affected process units, the permittee must be in compliance with the MON at all times, except during periods startup, shutdown, and malfunction. [Regulation No. 19 §19.304 and 40 CFR §63.2450(a)]
3. The permittee must not exclude monitoring data taken during startup, shutdown, or malfunction. [Regulation No. 19 §19.304 and 40 CFR §63.2450(1)]
4. Opening of a safety device is allowed at any time to avoid unsafe conditions. [Regulation No. 19 §19.304 and 40 CFR §63.2450(p)]
5. The permittee must submit an initial notification not later than 120 calendar days after November 10, 2003. The permittee complied with this requirement on March 5, 2004. [Regulation No. 19 §19.304 and 40 CFR §63.2515(b)]
6. If required to conduct a performance test, the permittee must submit a notification of intent to conduct a performance test at least 60 calendar days before the performance test is scheduled to begin as required in §63.7(b)(l). For any performance test required as part of the initial compliance procedures for batch process vents in Subpart FFFF Table 2 -

Albemarle Corporation
Permit #: 0762-AOP-R16
AFIN: 14-00028

Emission Limits and Work Practice Standards for Batch Process Vents, the permittee must submit the test plan required by §63.7(c) and the emission profile with the notification of the performance test. [Regulation No. 19 §19.304 and 40 CFR §63.2515(c)]

7. The permittee must submit a pre-compliance report to request approval for any of the items in §63.2520(c)(1) through (7). Changes in this information must be submitted 60 days before the planned change is to be implemented. [Regulation No. 19 §19.304 and 40 CFR §63.2520(c)]
8. The permittee must submit the notification of compliance status report no later than 150 days after the applicable compliance date specified in §63.2445. The notification of compliance status report must include the information in §63.2520(d)(2)(i) through (ix). [Regulation No. 19 §19.304 and 40 CFR §63.2520(d)(1)]
9. The compliance report must contain the information specified in §63.2520(e)(1) through (10). The initial compliance report may be submitted according to the schedule given in §63.2520(b)(1) through (b)(4). Subsequent compliance reports will be submitted with the annual compliance certification and semiannual monitoring reports as allowed under §63.2520(b)(5). [Regulation No. 19 §19.304 and 40 CFR §63.2520(e)]
10. Except as specified in §63.2520(e)(10)(ii), whenever a process change, or change in any of the information submitted in the notification of compliance status report or a previous compliance report is made, that is not within the scope of an existing operating scenario, the permittee must document the change in the compliance report. The notification must include all of the information in §63.2520(e)(10)(i)(A) through (C). [Regulation No. 19 §19.304 and 40 CFR §63.2520(e)(10)(i)]
11. The permittee must submit a report 60 days before the scheduled implementation date of any of the changes identified below. [Regulation No. 19 §19.304 and 40 CFR §63.2520(e)(10)(ii)]
 - a. Any change to the information contained in the pre-compliance report.
 - b. Changes in the status of a control device from small to large.
 - c. Changes from Group 2 to Group 1 for any emission point except for batch process vents that meet the conditions specified in §63.2460(b)(6)(i).
12. The permittee must keep a schedule or log of operating scenarios for processes with batch vents from batch operations updated each time a different operating scenario is put into effect. The permittee must keep the records of each operating scenario as specified in §63.2525(b)(1) through (8). [Regulation No. 19 §19.304 and 40 CFR §63.2525(b) and (c)]
13. If the permittee chooses to control any vents to less than the percent reduction requirement, the permittee must retain the information specified in §63.2525(d)(1) and (2) for Group 1 batch process vents in compliance with a percent reduction emission limit in Subpart FFFF Table 2 – *Emission Limits and Work Practice Standards for Batch Process Vents*. [Regulation No. 19 §19.304 and 40 CFR §63.2525(d)]

Albemarle Corporation
Permit #: 0762-AOP-R16
AFIN: 14-00028

14. For any of the MON-affected process units, the permittee must record each time a safety device is opened to avoid unsafe conditions in accordance with §63.2450(s). [Regulation No. 19 §19.304 and 40 CFR §63.2525(f)]
15. For any of the MON-affected process units with MON-required CPMS, the permittee must record the results of each CPMS calibration check and the maintenance performed, as specified in §63.2450(k)(1). [Regulation No. 19 §19.304 and 40 CFR §63.2525(g)]
16. In the SSMP required by §63.6(e)(3), the permittee is not required to include Group 2 emission points, unless those emission points are used in an emissions average. The permittee does not use emissions averaging at this time. For equipment leaks, the SSMP requirement is limited to control devices and is optional for other equipment. [Regulation No. 19 §19.304 and 40 CFR §63.2525(j)]

Closed Vent System Requirements for MON-required Control Devices

1. Each closed vent system must be designed and operated to collect the regulated material vapors from the emission point, and to route the collected vapors to a control device. Closed vent systems used for compliance must be operated at all times when emissions are vented to, or collected by, them. Except for equipment needed for safety purposes, the permittee must comply with the provisions of either §63.983(a)(3)(i) or (ii) for each closed vent system that contains bypass lines that could divert a vent stream to the atmosphere. The permittee must keep a record of the information specified in either §63.998(d)(1)(ii)(A) or (B), as applicable, for closed vent system bypass lines. [Regulation No. 19 §19.304 and 40 CFR §63.983(a)(1), (a)(2), and (a)(3)]
2. For closed vent systems collecting regulated material from a regulated source, the permittee must record the identification of all parts of the closed vent system, that are designated as unsafe or difficult to inspect, an explanation of why the equipment is unsafe or difficult to inspect, and the plan for inspecting the equipment required by §63.983(b)(2)(ii) or (iii). [Regulation No. 19 §19.304 and 40 CFR §63.983(b)(2) and §63.998(d)(1)(i)]
3. For all initial leak inspections, the instrument probe must be traversed around all potential leak interfaces as described in Method 21 of 40 CFR part 60, appendix A. Each closed vent system must be inspected according to the procedures specified in §63.983(c)(1)(i) through (vii). [Regulation No. 19 §19.304 and 40 CFR §63.983(c)(1) and (c)(2)]
4. If there are visible, audible, or olfactory indications of leaks at the time of the annual visual inspections required by §63.983(b)(1)(i)(B), the permittee must follow the procedure specified in either §63.983(d)(1)(i) or (ii). [Regulation No. 19 §19.304 and 40 CFR §63.983(d)(1)]
5. Leaks, as indicated by an instrument reading greater than 500 parts per million by volume above background or by visual inspections, must be repaired as soon as practical, except as provided in §63.983(d)(3) which allows delay of repair for the reasons specified therein. Records must be generated as specified in §63.998(d)(1)(iii)(A) through (F) when a leak is detected. Records must be kept according to §63.998(d)(1)(iv) when no leak is detected. [Regulation No. 19 §19.304 and 40 CFR §63.983(d)(2)]

Monitoring and Recordkeeping Requirements for Control Devices with Continuous Monitoring

1. The following sources – SN-AD-05, SN-16-18, and SN-21-01 were specifically identified as subject to the monitoring and recordkeeping requirements listed below. [Regulation No. 19 §19.304 and 40 CFR §63.996(c)(1)]
2. When one CPMS is used as a backup to another, the permittee must report the results from the CPMS used to meet the monitoring requirements. If both such CPMS's are used during a particular reporting period, the permittee must report the results from each CPMS for the time period the instrument was relied upon to demonstrate compliance. [Regulation No. 19 §19.304 and 40 CFR §63.996(b)(2)]
3. All monitoring equipment must be installed, calibrated, maintained, and operated according to manufacturer's specifications or other procedures that provide adequate assurance that the equipment will monitor accurately. [Regulation No. 19 §19.304 and 40 CFR §63.996(c)(1)]
4. The permittee must maintain and operate each CPMS as specified in this section (§63.996(c)(2)), or in a relevant subpart, and in a manner consistent with good air pollution control practices. [Regulation No. 19 §19.304 and 40 CFR §63.996(c)(2)]
 - a. The permittee must ensure the immediate repair or replacement of CPMS parts to correct "routine" or otherwise predictable CPMS malfunctions. The necessary parts for routine repairs of the affected equipment must be readily available.
 - b. If under the referencing subpart, the permittee has developed a startup, shutdown, and malfunction plan, the plan is followed, and the CPMS is repaired immediately, this action must be recorded as specified in §63.998(c)(1)(ii)(E).
 - c. The Administrator's determination of whether acceptable operation and maintenance procedures are being used for the CPMS will be based on information that may include, but is not limited to, review of operation and maintenance procedures, operation and maintenance records as specified in §63.998(c)(1)(i) and (ii), manufacturer's recommendations and specifications, and inspection of the CPMS.
5. If the permittee conducts performance tests for this control device, all CPMSs must be installed, operational, and have verification of data before or after conducting performance tests. Verification of operational status includes completion of the manufacturer's written specifications or recommendations for installation, operation, and calibration of the system or other written procedures that provide adequate assurance that the equipment would reasonably be expected to monitor accurately. [Regulation No. 19 §19.304 and 40 CFR §63.996(c)(3)]
6. All CPMS's must be installed such that representative measurements of parameters are obtained. [Regulation No. 19 §19.304 and 40 CFR §63.996(c)(4)]
7. The permittee must continually operate all CPMSs when emissions are being routed to the monitored device, except for system breakdowns, repairs, maintenance periods, instrument adjustments, or checks to maintain precision and accuracy, calibration checks, and zero and span adjustments. [Regulation No. 19 §19.304 and 40 CFR §63.996(c)(5)]

8. The permittee must establish a range for monitored parameters that indicates proper operation of the control or recovery device. In order to establish the range, the information required in §63.999(b)(3) must be submitted in the Notification of Compliance Status or the operating permit application or amendment. [Regulation No. 19 §19.304 and 40 CFR §63.996(c)(6)]
9. The permittee may request approval to use alternatives to the continuous operating parameter monitoring and recordkeeping provisions listed in §63.988(c), §63.990(c), §63.993(c), §63.994(c), §63.998(a)(2) through (4), §63.998(c)(2) and (3), as specified in §63.999(d)(1).

In addition, the permittee may request approval to monitor a different parameter than those established or to set unique monitoring parameters if directed by §63.994(c)(2) or §63.995(c), as specified in §63.999(d)(2). [Regulation No. 19 §19.304 and 40 CFR §63.996(d)(1) and (d)(2)]
10. If the permittee conducts performance tests for this control device, the permittee must maintain records necessary to determine the conditions of performance tests performed pursuant to §63.988(b). [Regulation No. 19 §19.304 and 40 CFR §63.998(a)(2)(i)]
11. Where Subpart SS requires a continuous record, the permittee must maintain a record of: [Regulation No. 19 §19.304 and 40 CFR §63.998(b)(1) and (b)(2)]
 - a. Values measured at least once every 15 minutes or each measured value for systems which measure more frequently than once every 15 minutes or 15-minute block average values or once per minute if measured more frequently.
 - b. Where data is collected from an automated continuous parameter monitoring system, the permittee may calculate and retain block hourly average values from each 15-minute block average period or from at least one measured value per minute if measured more frequently than once per minute, and discard all but the most recent three valid hours of continuous (15-minute or shorter) records, if the hourly averages do not exclude periods of CPMS breakdown or malfunction. An automated CPMS records the measured data and calculates the hourly averages through the use of a computerized data acquisition system.
 - c. A record as required by an alternative approved under a referencing subpart.
 - d. Monitoring data recorded during periods identified in paragraphs (b)(2)(i) and (ii) of this section must not be included in any average computed to determine compliance with an emission limit in a referencing subpart.
12. The permittee must record daily calculated average values of each parameter for each operating day and retain for 5 years. As an alternative, the permittee may record that all parameter values are within the determined range and retain this record for 5 years, rather than calculating and recording daily averages. As an additional alternative, the permittee may implement the recordkeeping requirements in §63.998(b)(5)(i) or (ii). If the permittee chooses the alternative in §63.998(b)(5), the permittee must retain each record required by §63.998(b)(5)(i) or (ii). [Regulation No. 19 §19.304 and 40 CFR §63.998(b)(3)(i), (b)(3)(ii), (b)(5), §63.998(c)(2)(i), and §63.998(c)(2)(ii)]

Albemarle Corporation
Permit #: 0762-AOP-R16
AFIN: 14-00028

13. The permittee must record procedure used for calibrating the CPMSs. [Regulation No. 19 §19.304 and 40 CFR §63.998(c)(1)(i)]
14. For a CPMSs used to comply with Subpart SS, the permittee must record the information specified in §63.998(c)(1)(ii)(A) through (H), as indicated in a referencing subpart. [Regulation No. 19 §19.304 and 40 CFR §63.998(c)(1)(ii)]
15. The permittee must record the results of each calibration check and all maintenance performed on the CPMS as specified in §63.998(c)(1)(ii)(A). [Regulation No. 19 §19.304 and 40 CFR §63.2450(k)(1)]
16. The permittee must maintain up-to-date, readily accessible records of periods of operation when the parameter boundaries are exceeded and the cause of these periods. [Regulation No. 19 §19.304 and 40 CFR §63.998(c)(2)(iii) and (d)(5)]
17. The permittee must record the occurrence and duration of each startup, shutdown, and malfunction (excess emissions) of process or air pollution control equipment. [Regulation No. 19 §19.304 and 40 CFR §63.998(d)(3)(i)]
18. The permittee must record that the procedures in the source's startup, shutdown, and malfunction plan (SSMP) were followed and document actions taken that are not consistent with the plan for each startup, shutdown, and malfunction (excess emissions) occurrence. [Regulation No. 19 §19.304 and 40 CFR §63.998(d)(3)(ii)]
19. The permittee is not allowed any excused excursions as described in 40 CFR 63 Subparts G and SS. [Regulation No. 19 §19.304 and 40 CFR §63.2450(m)(3)]

ADMA Unit

The ADMA process unit produces alkyl amines and uses a caustic scrubber for emission control purposes. In one operating scenario, the scrubber receives a process vent stream from an absorber that is used to make HBr product. The vent stream sent to the scrubber during this scenario contains less than 50 ppmv HAP and is thus exempt. Therefore, the scrubber is not required for compliance with the MON during this scenario.

In the second operating scenario, emissions from the reactor are routed directly to the scrubber and these emissions are greater than 50 ppmv and are greater than 1000 lb/yr HCl/Cl₂. Therefore, the vent is subject to the requirements of Subpart FFFF Table 3 - *Emission Limits for Hydrogen Halide and Halogen HAP Emissions or HAP Metals Emissions from Process Vents* and the scrubber is required to comply with the MON during this operating scenario.

Specific Conditions

1. The permittee must determine and sum the uncontrolled hydrogen halide and halogen HAP emissions from each of the process vents within the process using the procedures specified in §63.1257(d)(2)(i) and/or (ii), as appropriate, for any process vents within a process emit hydrogen halide and halogen HAP. When §63.1257(d)(2)(ii)(E) requires documentation to be submitted in the pre-compliance report, it means the notification of compliance status report. [Regulation No. 19 §19.304 and 40 CFR §63.2465(b)]
2. If collective uncontrolled hydrogen halide and halogen HAP emissions from the process vents within a process are greater than or equal to 1,000 pounds per year (lb/yr), the

Albemarle Corporation
Permit #: 0762-AOP-R16
AFIN: 14-00028

- permittee must comply with §63.994, except as specified in §63.2465(c)(I) through (3). The permittee must meet each emission limit in Table 3 - *Emission Limits for Hydrogen Halide and Halogen HAP Emissions or HAP Metals Emissions from Process Vents* that apply and meet each applicable requirement in §63.2465(b) through (d). [Regulation No. 19 §19.304 and 40 CFR §63.2450(e)(3), §63.2465(a), and §63.2465(c)]
3. The permittee must determine if an emission stream is a halogenated vent stream, as defined in §63.2550, by calculating the mass emission rate of halogen atoms in accordance with §63.115(d)(2)(v). Alternatively, the permittee may elect to designate the emission stream as halogenated. [Regulation No. 19 §19.304 and 40 CFR §63.2450(b)]
 4. The permittee must meet the requirements of §63.994 and the requirements referenced therein for halogen reduction devices used to reduce hydrogen halide and halogen HAP emissions from halogenated vent streams. [Regulation No. 19 §19.304 and 40 CFR §63.2450(e)(3)]
 5. Halogen scrubbers and other halogen reduction devices must be operated at all times when emissions are vented to them. [Regulation No. 19 §19.304 and 40 CFR §63.994(a)(2)]
 6. When §63.994(b)(1) requires a performance test, the permittee may elect to conduct a design evaluation in accordance with §63.1257(a)(1). If the permittee chooses to conduct a performance test, the performance test will be conducted according to §63.994(b)(1). [Regulation No. 19 §19.304 and 40 CFR §63.994(b)(1)]
 7. The permittee must install a continuous pH monitoring device on the scrubber effluent. As an alternative to continuously measuring and recording pH as specified in §63.994(c)(1)(i) and §63.998(a)(2)(ii)(D), the permittee may elect to continuously monitor and record the caustic strength of the effluent. For halogen scrubbers used to control only batch process vents, the permittee may elect to monitor and record either the pH or the caustic strength of the scrubber effluent at least once per day. [Regulation No. 19 §19.304 and 40 CFR §63.994(c)(1)(i)]
 8. The permittee must locate a continuous liquid flow meter at the scrubber influent and determine gas stream flow using one of the procedures specified in §63.994(c)(1)(ii)(A) through (D). [Regulation No. 19 §19.304 and 40 CFR §63.994(c)(1)(ii)]
 9. For the ADMA scrubber (SN-AD-05), the permittee must comply with the Monitoring and Recordkeeping Requirements for Control Devices with Continuous Monitoring given in the general MON requirements section. [Regulation No. 19 §19.304 and 40 CFR §63.996(c)(1)]

DMTDA Unit

The DMTDA process unit produces di-(methyl-thio)-toluene-diamine and dimethyl disulfide. During the dimethyl disulfide production scenario, no HAP is used therefore this operating scenario is not subject to the MON. The DMTDA production scenario is subject to the MON because it uses HAP.

The DMTDA production scenario is subject to the requirements for Group 2 continuous and batch process vents (TRE value > 5.0 for continuous process vents and emissions between 200

Albemarle Corporation
Permit #: 0762-AOP-R16
AFIN: 14-00028

and 10,000 lb/yr for batch process vents). The DMTDA production scenario is also subject to the equipment leak provisions and potentially subject to the process condenser requirements. The unit does not use any control devices. The proposed permit conditions are presented below.

Specific Conditions

1. For each continuous process vent, the permittee must either designate the vent as a Group 1 continuous process vent or determine the total resource effectiveness (TRE) index value as specified in §63.115(d), except as specified in §63.2455(b)(1) through (3). [Regulation No. 19 §19.304 and 40 CFR §63.2455(b)]
2. If a process has batch process vents, as defined in §63.2550, the permittee must determine the group status of the batch process vents by determining and summing the uncontrolled organic HAP emissions from each of the batch process vents within the process using the procedures specified in §63.1257(d)(2)(i) and (ii), except as specified in §63.2460(b)(1) through (7). [Regulation No. 19 §19.304 and 40 CFR §63.2460(b)]
3. The permittee may change from Group 2 to Group 1 in accordance with either §63.2460(b)(6)(i) or (ii) and must comply with the requirements of §63.2460 and submit the test report in the next compliance report. [Regulation No. 19 §19.304 and 40 CFR §63.2460(b)(6)]
4. Process condensers, as defined in §63.2550(i), are not considered to be control devices for batch process vents. The permittee must determine whether a condenser is a control device for a batch process vent or a process condenser from which the uncontrolled HAP emissions are evaluated as part of the initial compliance demonstration for each MCPU and report the results with supporting rationale in the notification of compliance status report. [Regulation No. 19 §19.304 and 40 CFR §63.2460(c)(1)]
5. If a process condenser is used for any boiling operations, the permittee must demonstrate that it is properly operated according to the procedures specified in §63.1257(d)(2)(i)(C)(4)(ii) and (d)(3)(iii)(B), and the demonstration must occur only during the boiling operation. As an alternative to measuring the exhaust gas temperature, as required by §63.1257(d)(3)(iii)(B), the permittee may elect to measure the liquid temperature in the receiver. [Regulation No. 19 §19.304 and 40 CFR §63.2460(c)(2)(v)]
6. The permittee must meet the requirements of §63.2480 for equipment leaks. [Regulation No. 19 §19.304 and 40 CFR §63.2480]
7. If the permittee documents in the notification of compliance status report that total uncontrolled organic HAP emissions from the batch process vents in an MCPU will be less than 1,000 lb/yr for the anticipated number of standard batches, then the permittee must keep records of the number of batches operated and calculate a daily rolling annual sum of batches operated no less frequently than monthly.

If the number of batches operated results in organic HAP emissions that exceed 1,000 lb/yr, the permittee must estimate emissions for the preceding 12 months based on the number of batches operated and the estimated emissions for a standard batch, and the permittee must begin recordkeeping as specified in §63.2525 (e)(4). After one year, the permittee may revert to recording only the number of batches if the number of batches

Albemarle Corporation
Permit #: 0762-AOP-R16
AFIN: 14-00028

operated during the year results in less than 1,000 lb of organic HAP emissions.
[Regulation No. 19 §19.304 and 40 CFR §63.2525(e)(3)]

NC-12 Unit

There are two batch process vents at the NC-12 unit, and emissions from one of the process vents is less than 50 ppm (exempt) and the permittee will limit the other process vent to 1,000 lb/yr (Group 2). Otherwise, the NC-12 unit is not subject to any other MON requirements. NC-12 production unit has an alternate operating scenario where the NC-15 product is produced. As is the case with the NC-15 production unit, this operating scenario has one exempt process vent with less than 50 ppm and no other MON-affected emissions.

Specific Conditions

1. If any process vents within a process emit hydrogen halide and halogen HAP, the permittee must determine and sum the uncontrolled hydrogen halide and halogen HAP emissions from each of the process vents within the process using the procedures specified in §63.1257(d)(2)(i) and/or (ii), as appropriate. When §63.1257(d)(2)(ii)(E) requires documentation to be submitted in the pre-compliance report, it means the notification of compliance status report. [Regulation No. 19 §19.304 and 40 CFR §63.2465(b)]
2. The permittee must keep records of the information specified below. [Regulation No. 19 §19.304 and 40 CFR §63.2525(e)(4)]
 - a. The day each batch was completed and/or the operating hours per day for continuous operations with hydrogen halide and halogen emissions.
 - b. Whether each batch operated was considered a standard batch.
 - c. Estimated uncontrolled and controlled emissions for each batch that is considered to be a nonstandard batch.
 - d. The daily 365-day rolling summations of emissions, or alternative records that correlate to the emissions (e.g., number of batches), calculated no less frequently than monthly.

NC-15 Unit

There is a single batch process vent with emissions less than 50 ppm and this unit is exempt from the requirements for a batch process. However, since hydrogen chloride (HCl) is emitted the unit is subject to the requirement below.

Specific Conditions

1. If any process vents within a process emit hydrogen halide and halogen HAP, the permittee must determine and sum the uncontrolled hydrogen halide and halogen HAP emissions from each of the process vents within the process using the procedures specified in §63.1257(d)(2)(i) and/or (ii), as appropriate. When §63.1257(d)(2)(ii)(E) requires documentation to be submitted in the pre-compliance report, it means the notification of compliance status report. [Regulation No. 19 §19.304 and 40 CFR §63.2465(b)]

Albemarle Corporation
Permit #: 0762-AOP-R16
AFIN: 14-00028

NC-16 Unit

The continuous process vents, storage tanks, transfer racks, equipment leaks, wastewater, and heat exchanger equipment, if they exist, are covered under 40 CFR §63, Subpart F, G, and H – *National Emission Standards for Organic Hazardous Air Pollutants* (a.k.a. the HON).

Specific Conditions

1. If any process vents within a process emit hydrogen halide and halogen HAP, the permittee must determine and sum the uncontrolled hydrogen halide and halogen HAP emissions from each of the process vents within the process using the procedures specified in §63.1257(d)(2)(i) and/or (ii), as appropriate. When §63.1257(d)(2)(ii)(E) requires documentation to be submitted in the pre-compliance report, it means the notification of compliance status report. [Regulation No. 19 §19.304 and 40 CFR §63.2465(b)]

NC-18 (BT-93W Process Only)

The only affected process at the NC-18 unit is the production of BT-93W. The BT-93W process contains combined emissions streams with both batch vents and continuous process vents. The permittee will comply with the emission limits and work practice standards for Group 1 batch process vents, based on the hierarchy given in §63.2450(c)(2) of the MON. The BT-93W process is also subject to the Subpart SS requirements for its incinerator control device.

Specific Conditions

1. The permittee must determine the applicable requirements based on the hierarchy presented in §63.2450(c)(2)(i) through (vi). For a combined stream, the applicable requirements are specified in the highest-listed paragraph in the hierarchy that applies to any of the individual streams that make up the combined stream. [Regulation No. 19 §19.304 and 40 CFR §63.2450(c)(2)]
2. The permittee will comply with the requirements of Subpart FFFF Table 2 - *Emission Limits and Work Practice Standards for Batch Process Vents* and §63.2460 for Group 1 batch process vents, including applicable monitoring, recordkeeping, and reporting. Therefore, per §63.2450(c)(2), compliance with these requirements will demonstrate compliance with the requirements for the following types of emission sources: [Regulation No. 19 §19.304 and 40 CFR §63.2450(c)(2)(i)]
 - a. Continuous Process Vents
 - b. Transfer Operations
 - c. Waste Management Units handling Group 1 Wastewater Streams
 - d. Storage Tanks, and
 - e. Continuous Process Vents with Final Recovery Devices
3. The permittee must meet each emission limit in Subpart FFFF Table 2 - *Emission Limits and Work Practice Standards for Batch Process Vents* that apply and meet each applicable requirement specified in §63.2460(b) and (c). [Regulation No. 19 §19.304 and 40 CFR §63.2460(a)]

4. The permittee must determine the group status of batch process vents, as defined in §63.2550, by determining and summing the uncontrolled organic HAP emissions from each of the batch process vents within the process using the procedures specified in §63.1257(d)(2)(i) and (ii), except as specified in §63.2460(b)(1) through (7). [Regulation No. 19 §19.304 and 40 CFR §63.2460(b)]
5. Process condensers, as defined in §63.2550(i), are not considered to be control devices for batch process vents. The permittee must determine whether a condenser is a control device for a batch process vent or a process condenser from which the uncontrolled HAP emissions are evaluated as part of the initial compliance demonstration for each MCPU and report the results with supporting rationale in the notification of compliance status report. [Regulation No. 19 §19.304 and 40 CFR §63.2460(c)(1)]
6. If a process condenser is used for any boiling operations, the permittee must demonstrate that it is properly operated according to the procedures specified in §63.1257(d)(2)(i)(C)(4)(ii) and (d)(3)(iii)(B), and the demonstration must occur only during the boiling operation. As an alternative to measuring the exhaust gas temperature, as required by §63.1257(d)(3)(iii)(B), the permittee may elect to measure the liquid temperature in the receiver. [Regulation No. 19 §19.304 and 40 CFR §63.2460(c)(2)(v)]
7. To demonstrate initial compliance with a percent reduction emission limit in Subpart FFFF Table 2 - *Emission Limits and Work Practice Standards for Batch Process Vents*, the permittee must compare the sums of the controlled and uncontrolled emissions for the applicable Group 1 batch process vents within the process, and show that the specified reduction is met. [Regulation No. 19 §19.304 and 40 CFR §63.2460(c)(2)(i)]
8. When the permittee conducts a performance test or design evaluation for a non-flare control device used to control emissions from batch process vents, the permittee must establish emission profiles and conduct the test under worst-case conditions according to §63.1257(b)(8), instead of under normal operating conditions as specified in §63.7(e)(1). The requirements in §63.997(e)(1)(i) and (iii) also do not apply for performance tests conducted to determine compliance with the emission limits for batch process vents. For references in §63.997(b)(1) to "methods specified in §63.997(e)" include the methods specified in §63.1257(b)(8). [Regulation No. 19 §19.304 and 40 CFR §63.2460(c)(2)(ii)]
9. The permittee must conduct a subsequent performance test or compliance demonstration equivalent to an initial compliance demonstration within 180 days of a change in the worst case conditions. [Regulation No. 19 §19.304 and 40 CFR §63.2460(c)(2)(vi)]
10. The permittee must establish operating limits under the conditions required for the initial compliance demonstration, except the permittee may elect to establish operating limit(s) for conditions other than those under which a performance test was conducted as specified in §63.2460(c)(3)(i) and, if applicable, §63.2460(c)(3)(ii). [Regulation No. 19 §19.304 and 40 CFR §63.2460(c)(3)]
11. If flow to a control device could be intermittent, the permittee must install, calibrate, and operate a flow indicator at the inlet or outlet of the control device to identify periods of no flow. Periods of no flow may not be used in daily or block averages, and it may not

- be used in fulfilling a minimum data availability requirement. [Regulation No. 19 §19.304 and 40 CFR §63.2460(c)(7)]
12. The permittee must meet the requirements of §63.982(c) and the requirements referenced therein, except when complying with §63.2485, if the permittee reduces organic HAP emissions by venting emissions through a closed-vent system to any combination of control devices (except a flare) or recovery devices. The permittee will comply with this requirement by compliance with the Closed Vent System Requirements given in the general MON requirements section. [Regulation No. 19 §19.304 and 40 CFR §63.2450(e)(1)]
 13. For the NC-18 incinerator, the permittee must comply with the Monitoring and Recordkeeping Requirements for Control Devices with Continuous Monitoring given in the general MON requirements section. [Regulation No. 19 §19.304 and 40 CFR §63.996(c)(1)]
 14. The permittee must comply with the requirements specified in §63.2450(g)(1) through (5) for performance tests. [Regulation No. 19 §19.304 and 40 CFR §63.2450(g)]
 15. The permittee may use either §63.2450(i)(1) or (i)(2) to correct for supplemental gas. [Regulation No. 19 §19.304 and 40 CFR §63.2450(i)]
 16. The permittee must operate incinerators at all times when emissions are vented to them. [Regulation No. 19 §19.304 and 40 CFR §63.988(a)(2)]
 17. The permittee must install a temperature monitoring device in the fire box or ductwork downstream of the fire box. [Regulation No. 19 §19.304 and 40 CFR §63.988(c)(1)]
 18. The permittee must maintain records necessary to determine the conditions of performance tests performed pursuant to §63.988(b) must be available upon request. [Regulation No. 19 §19.304 and 40 CFR §63.998(a)(2)(i)]
 19. Where the permittee seeks to demonstrate compliance with a percent reduction requirement or a parts per million by volume requirement using a non-flare combustion device the information specified below must be recorded. [Regulation No. 19 §19.304 and 40 CFR §63.998(a)(2)(ii)(B)]
 - a. The fire box temperature averaged over full period of performance test.
 - b. The percent reduction of organic regulated material, if applicable, or TOC achieved by the incinerator determined as specified in §63.997(e)(2)(iv), as applicable, or the concentration of organic regulated material (parts per million by volume, by compound) determined as specified in §63.997(e)(2)(iii) at the outlet of the incinerator.
 20. The permittee must meet each emission limit in Subpart FFFF Table 1 - *Emission Limits and Work Practice Standards for Continuous Process Vents* that applies to continuous process vents and meet each applicable requirement specified in §63.2455(b) through (c). Per §63.2450(c)(2), compliance with these requirements will be demonstrated per compliance with the requirements for batch process vents. [Regulation No. 19 §19.304 and 40 CFR §63.2455(a)]

Albemarle Corporation
Permit #: 0762-AOP-R16
AFIN: 14-00028

21. The permittee must meet each requirement in Subpart FFFF Table 6 - *Requirements for Equipment Leaks* that applies to equipment leaks, except as specified in §63.2480(b) through (d). [Regulation No. 19 §19.304 and 40 CFR §63.2480(a)]
22. The permittee must meet each requirement in Subpart FFFF Table 7 - *Requirements for Wastewater Streams and Liquid Streams in Open Systems Within a MCPU* that applies to wastewater streams and liquid streams in open systems within a MCPU, except as specified in §63.2485(b) through (o). [Regulation No. 19 §19.304 and 40 CFR §63.2485]
23. The permittee must comply with each requirement in Subpart FFFF Table 10 - *Work Practice Standards for Heat Exchange Systems* that apply to heat exchange systems, except as specified in §63.2490(b) and (c). [Regulation No. 19 §19.304 and 40 CFR §63.2490(a)]

NC-21 Unit

The NC-21 unit is similar to the NC-18 unit. Like the NC-18 unit, NC-21 has combined emission streams (i.e., batch vents, continuous vents, and storage tanks), and the permittee will comply with the emission limits and work practice standards for Group 1 batch process vents, based on the hierarchy of the MON. The NC-21 unit is also subject to the Subpart SS requirements for its incinerator control device.

Specific Conditions

1. The permittee must determine the applicable requirements based on the hierarchy presented in §63.2450(c)(2)(i) through (vi). For a combined stream, the applicable requirements are specified in the highest-listed paragraph in the hierarchy that applies to any of the individual streams that make up the combined stream. [Regulation No. 19 §19.304 and 40 CFR §63.2450(c)(2)]
2. The permittee will comply with the requirements of Subpart FFFF Table 2 - *Emission Limits and Work Practice Standards for Batch Process Vents* and §63.2460 for Group 1 batch process vents, including applicable monitoring, recordkeeping, and reporting. Therefore, per §63.2450(c)(2), compliance with these requirements will demonstrate compliance with the requirements for the following types of emission sources: [Regulation No. 19 §19.304 and 40 CFR §63.2450(c)(2)(i)]
 - a. Continuous Process Vents
 - b. Transfer Operations
 - c. Waste Management Units handling Group I Wastewater Streams
 - d. Storage Tanks
 - e. Continuous Process Vents with Final Recovery Devices
3. The permittee must meet each emission limit in Subpart FFFF Table 2 - *Emission Limits and Work Practice Standards for Batch Process Vents* that apply and meet each applicable requirement specified in §63.2460(b) and (c). [Regulation No. 19 §19.304 and 40 CFR §63.2460(a)]

4. The permittee must determine the group status of batch process vents, as defined in §63.2550, by determining and summing the uncontrolled organic HAP emissions from each of the batch process vents within the process using the procedures specified in §63.1257(d)(2)(i) and (ii), except as specified in §63.2460(b)(1) through (7). [Regulation No. 19 §19.304 and 40 CFR §63.2460(b)]
5. Process condensers, as defined in §63.2550(i), are not considered to be control devices for batch process vents. The permittee must determine whether a condenser is a control device for a batch process vent or a process condenser from which the uncontrolled HAP emissions are evaluated as part of the initial compliance demonstration for each MCPU and report the results with supporting rationale in the notification of compliance status report. [Regulation No. 19 §19.304 and 40 CFR §63.2460(c)(1)]
6. If a process condenser is used for any boiling operations, the permittee must demonstrate that it is properly operated according to the procedures specified in §63.1257(d)(2)(i)(C)(4)(ii) and (d)(3)(iii)(B), and the demonstration must occur only during the boiling operation. As an alternative to measuring the exhaust gas temperature, as required by §63.1257(d)(3)(iii)(B), the permittee may elect to measure the liquid temperature in the receiver. [Regulation No. 19 §19.304 and 40 CFR §63.2460(c)(2)(v)]
7. To demonstrate initial compliance with a percent reduction emission limit in Subpart FFFF Table 2 – *Emission Limits and Work Practice Standards for Batch Process Vents*, the permittee must compare the sums of the controlled and uncontrolled emissions for the applicable Group 1 batch process vents within the process, and show that the specified reduction is met. [Regulation No. 19 §19.304 and 40 CFR §63.2460(c)(2)(i)]
8. When the permittee conducts a performance test or design evaluation for a non-flare control device used to control emissions from batch process vents, the permittee must establish emission profiles and conduct the test under worst-case conditions according to §63.1257(b)(8), instead of under normal operating conditions as specified in §63.7(e)(1). The requirements in §63.997(e)(I)(i) and (iii) also do not apply for performance tests conducted to determine compliance with the emission limits for batch process vents. For references in §63.997(b)(1) to "methods specified in §63.997(e)" include the methods specified in §63.1257(b)(8). [Regulation No. 19 §19.304 and 40 CFR §63.2460(c)(2)(ii)]
9. The permittee must conduct a subsequent performance test or compliance demonstration equivalent to an initial compliance demonstration within 180 days of a change in the worst case conditions. [Regulation No. 19 §19.304 and 40 CFR §63.2460(c)(2)(vi)]
10. The permittee must establish operating limits under the conditions required for the initial compliance demonstration, except the permittee may elect to establish operating limit(s) for conditions other than those under which a performance test was conducted as specified in §63.2460(c)(3)(i) and, if applicable, §63.2460(c)(3)(ii). [Regulation No. 19 §19.304 and 40 CFR §63.2460(c)(3)]
11. If flow to a control device could be intermittent, the permittee must install, calibrate, and operate a flow indicator at the inlet or outlet of the control device to identify periods of no flow. Periods of no flow may not be used in daily or block averages, and it may not

- be used in fulfilling a minimum data availability requirement. [Regulation No. 19 §19.304 and 40 CFR §63.2460(c)(7)]
12. The permittee must meet the requirements of §63.982(c) and the requirements referenced therein, except when complying with §63.2485, if the permittee reduces organic HAP emissions by venting emissions through a closed-vent system to any combination of control devices (except a flare) or recovery devices. The permittee will comply with this requirement by compliance with the Closed Vent System Requirements given in the general MON requirements section. [Regulation No. 19 §19.304 and 40 CFR §63.2450(e)(1)]
 13. For the NC-21 incinerator, the permittee must comply with the Monitoring and Recordkeeping Requirements for Control Devices with Continuous Monitoring given in the general MON requirements section. [Regulation No. 19 §19.304 and 40 CFR §63.996(c)(1)]
 14. The permittee must comply with the requirements specified in §63.2450(g)(1) through (5) for performance tests. [Regulation No. 19 §19.304 and 40 CFR §63.2450(g)]
 15. The permittee may use either §63.2450(i)(1) or (i)(2) to correct for supplemental gas. [Regulation No. 19 §19.304 and 40 CFR §63.2450(i)]
 16. The permittee must operate incinerators at all times when emissions are vented to them. [Regulation No. 19 §19.304 and 40 CFR §63.988(a)(2)]
 17. The permittee must install a temperature monitoring device in the fire box or ductwork downstream of the fire box. [Regulation No. 19 §19.304 and 40 CFR §63.988(c)(1)]
 18. The permittee must maintain records necessary to determine the conditions of performance tests performed pursuant to §63.988(b) and must be available upon request. [Regulation No. 19 §19.304 and 40 CFR §63.998(a)(2)(i)]
 19. Where the permittee seeks to demonstrate compliance with a percent reduction requirement or a parts per million by volume requirement using a nonflare combustion device the information specified below must be recorded. [Regulation No. 19 §19.304 and 40 CFR §63.998(a)(2)(ii)(B)]
 - a. The fire box temperature averaged over full period of performance test.
 - b. The percent reduction of organic regulated material, if applicable, or TOC achieved by the incinerator determined as specified in §63.997(e)(2)(iv), as applicable, or the concentration of organic regulated material (parts per million by volume, by compound) determined as specified in §63.997(e)(2)(iii) at the outlet of the incinerator.
 20. The permittee must meet each emission limit in Subpart FFFF Table 1 - *Emission Limits and Work Practice Standards for Continuous Process Vents* that applies to continuous process vents and meet each applicable requirement specified in §63.2455(b) through (c). Per §63.2450(c)(2), compliance with these requirements will be demonstrated per compliance with the requirements for batch process vents. [Regulation No. 19 §19.304 and 40 CFR §63.2455(a)]

21. If, in the future, a scrubber is used at the NC-21 unit to comply with the requirements of Subpart FFFF Table 3 - *Emission Limits for Hydrogen Halide and Halogen HAP Emissions or HAP Metals Emissions from Process Vents*, then the permittee must comply with the MON requirements specifically applicable to hydrogen halide halogen HAP scrubbers given in proposed Conditions 2 through 9 in the ADMA section. [Regulation No. 19 §19.304 and 40 CFR §63.2450(e)(3), §63.2465(a), and §63.2465(c)]
22. The permittee must meet each emission limit in Subpart FFFF Table 4 - *Emission Limits for Storage Tanks* that applies to storage tanks and meet each applicable requirement specified in §63.2470(b) through (e). Per §63.2450(c)(2), compliance with these requirements will be demonstrated per compliance with the requirements for batch process vents. [Regulation No. 19 §19.304 and 40 CFR §63.2470(a)]
23. For each surge control vessel or bottoms receiver that meets the capacity and vapor pressure thresholds for a Group 1 storage tank, the permittee must meet emission limits and work practice standards specified in Subpart FFFF Table 4 - *Emission Limits for Storage Tanks*. Per §63.2450(c)(2), compliance with these requirements will be demonstrated per compliance with the requirements for batch process vents. [Regulation No. 19 §19.304 and 40 CFR §63.2450(r)]
24. If any process vents within a process emit hydrogen halide and halogen HAP, the permittee must determine and sum the uncontrolled hydrogen halide and halogen HAP emissions from each of the process vents within the process using the procedures specified in §63.1257(d)(2)(i) and/or (ii), as appropriate. When §63.1257(d)(2)(ii)(E) requires documentation to be submitted in the pre-compliance report, it means the notification of compliance status report. [Regulation No. 19 §19.304 and 40 CFR §63.2465(b)]
25. The permittee must meet each requirement in Subpart FFFF Table 6 - *Requirements for Equipment Leaks* that applies to equipment leaks, except as specified in §63.2480(b) through (d). [Regulation No. 19 §19.304 and 40 CFR §63.2480(a)]
26. The permittee must meet each requirement in Subpart FFFF Table 7 - *Requirements for Wastewater Streams and Liquid Streams in Open Systems Within an MCPU* that applies to wastewater streams and liquid streams in open systems within an MCPU, except as specified in §63.2485(b) through (o). [Regulation No. 19 §19.304 and 40 CFR §63.2485]
27. The permittee must comply with each requirement in Subpart FFFF Table 10 - *Work Practice Standards for Heat Exchange Systems* that apply to heat exchange systems, except as specified in §63.2490(b) and (c). [Regulation No. 19 §19.304 and 40 CFR §63.2490(a)]

Albemarle Corporation
Permit #: 0762-AOP-R16
AFIN: 14-00028

NC-22 Unit

The NC-22 unit has four batch process vents with emissions less than 50 ppm and this unit is exempt from the requirements for a batch process. However, since hydrogen chloride (HCL) is emitted the unit is subject to the requirement below.

Specific Conditions

1. If any process vents within a process emit hydrogen halide and halogen HAP, the permittee must determine and sum the uncontrolled hydrogen halide and halogen HAP emissions from each of the process vents within the process using the procedures specified in §63.1257(d)(2)(i) and/or (ii), as appropriate. When §63.1257(d)(2)(ii)(E) requires documentation to be submitted in the pre-compliance report, it means the notification of compliance status report. [Regulation No. 19 §19.304 and 40 CFR §63.2465(b)]

NC-23 Unit

The NC-23 unit contains either exempt continuous process vents or continuous process vents with a TRE greater than 5.0. Therefore, no MON control requirements apply. The batch process vents at this unit are Group 2. The storage tanks contain phenol which has a vapor pressure less than 1.0 psia. Therefore the storage tanks are Group 2.

Specific Conditions

1. For each continuous process vent, the permittee must either designate the vent as a Group 1 continuous process vent or determine the total resource effectiveness (TRE) index value as specified in §63.115(d), except as specified in §63.2455(b)(1) through (3). [Regulation No. 19 §19.304 and 40 CFR §63.2455(b)]
2. If a process has batch process vents, as defined in §63.2550, the permittee must determine the group status of the batch process vents by determining and summing the uncontrolled organic HAP emissions from each of the batch process vents within the process using the procedures specified in §63.1257(d)(2)(i) and (ii), except as specified in §63.2460(b)(1) through (7). [Regulation No. 19 §19.304 and 40 CFR §63.2460(b)]
3. The permittee may change from Group 2 to Group I in accordance with either §63.2460(b)(6)(i) or (ii) and must comply with the requirements of §63.2460 and submit the test report in the next compliance report. [Regulation No. 19 §19.304 and 40 CFR §63.2460(b)(6)]
4. Process condensers, as defined in §63.2550(i), are not considered to be control devices for batch process vents. The permittee must determine whether a condenser is a control device for a batch process vent or a process condenser from which the uncontrolled HAP emissions are evaluated as part of the initial compliance demonstration for each MCPU and report the results with supporting rationale in the notification of compliance status report. [Regulation No. 19 §19.304 and 40 CFR §63.2460(c)(1)]
5. If a process condenser is used for any boiling operations, the permittee must demonstrate that it is properly operated according to the procedures specified in §63.1257(d)(2)(i)(C)(4)(ii) and (d)(3)(iii)(B), and the demonstration must occur only

during the boiling operation. The reference in §63.1257(d)(3)(iii)(B) to the alternative standard in §63.1254(c) means §63.2505. As an alternative to measuring the exhaust gas temperature, as required by §63.1257(d)(3)(iii)(B), the permittee may elect to measure the liquid temperature in the receiver. [Regulation No. 19 §19.304 and 40 CFR §63.2460(c)(2)(v)]

6. The permittee must meet the requirements of §63.2480 for equipment leaks. [Regulation No. 19 §19.304 and 40 CFR §63.2480]
7. The permittee must meet each requirement in Subpart FFFF Table 7 - *Requirements for Wastewater Streams and Liquid Streams in Open Systems Within an MCPU* that applies to wastewater streams and liquid streams in open systems within an MCPU, except as specified in §63.2485(b) through (o). [Regulation No. 19 §19.304 and 40 CFR §63.2485]
8. If the permittee documents in the notification of compliance status report that total uncontrolled organic HAP emissions from the batch process vents in an MCPU will be less than 1,000 lb/yr for the anticipated number of standard batches, then the permittee must keep records of the number of batches operated and calculate a daily rolling annual sum of batches operated no less frequently than monthly. If the number of batches operated results in organic HAP emissions that exceed 1,000 lb/yr, the permittee must estimate emissions for the preceding 12 months based on the number of batches operated and the estimated emissions for a standard batch, and the permittee must begin recordkeeping as specified in §63.2525(e)(4). After 1 year, the permittee may revert to recording only the number of batches if the number of batches operated during the year results in less than 1,000 lb of organic HAP emissions. [Regulation No. 19 §19.304 and 40 CFR §63.2525(e)(3)]

NC-24 Unit

The NC-24 unit has two continuous process vent with emissions less than 50 ppm and batch process vents with less than 200 lb/yr of HAP. Therefore, the NC-24 unit is exempt from the requirements for a batch process. However, since hydrogen chloride (HCl) is emitted the unit is subject to the requirement below.

Specific Conditions

1. If a process has batch process vents, as defined in §63.2550, the permittee must determine the group status of the batch process vents by determining and summing the uncontrolled organic HAP emissions from each of the batch process vents within the process using the procedures specified in §63.1257(d)(2)(i) and (ii), except as specified in §63.2460(b)(1) through (7). [Regulation No. 19 §19.304 and 40 CFR §63.2460(b)]
2. If any process vents within a process emit hydrogen halide and halogen HAP, the permittee must determine and sum the uncontrolled hydrogen halide and halogen HAP emissions from each of the process vents within the process using the procedures specified in §63.1257(d)(2)(i) and/or (ii), as appropriate. When §63.1257(d)(2)(ii)(E) requires documentation to be submitted in the pre-compliance report, it means the notification of compliance status report. [Regulation No. 19 §19.304 and 40 CFR §63.2465(b)]

Albemarle Corporation
Permit #: 0762-AOP-R16
AFIN: 14-00028

SECTION V: COMPLIANCE PLAN AND SCHEDULE

Albemarle Corporation will continue to operate in compliance with those identified regulatory provisions. The facility will examine and analyze future regulations that may apply and determine their applicability with any necessary action taken on a timely basis.

SECTION VI: PLANTWIDE CONDITIONS

1. The permittee shall notify the Director in writing within thirty (30) days after commencing construction, completing construction, first placing the equipment and/or facility in operation, and reaching the equipment and/or facility target production rate. [Regulation 19, §19.704, 40 CFR Part 52, Subpart E, and A.C.A. §8-4-203 as referenced by A.C.A. §8-4-304 and §8-4-311]
2. If the permittee fails to start construction within eighteen months or suspends construction for eighteen months or more, the Director may cancel all or part of this permit. [Regulation 19, §19.410(B) and 40 CFR Part 52, Subpart E]
3. The permittee must test any equipment scheduled for testing, unless otherwise stated in the Specific Conditions of this permit or by any federally regulated requirements, within the following time frames: (1) new equipment or newly modified equipment within sixty (60) days of achieving the maximum production rate, but no later than 180 days after initial start up of the permitted source or (2) operating equipment according to the time frames set forth by the Department or within 180 days of permit issuance if no date is specified. The permittee must notify the Department of the scheduled date of compliance testing at least fifteen (15) days in advance of such test. The permittee shall submit the compliance test results to the Department within thirty (30) days after completing the testing. [Regulation 19, §19.702 and/or Regulation 18 §18.1002 and A.C.A. §8-4-203 as referenced by A.C.A. §8-4-304 and §8-4-311]
4. The permittee must provide:
 - a. Sampling ports adequate for applicable test methods;
 - b. Safe sampling platforms;
 - c. Safe access to sampling platforms; and
 - d. Utilities for sampling and testing equipment.

[Regulation 19, §19.702 and/or Regulation 18, §18.1002 and A.C.A. §8-4-203 as referenced by A.C.A. §8-4-304 and §8-4-311]
5. The permittee must operate the equipment, control apparatus and emission monitoring equipment within the design limitations. The permittee shall maintain the equipment in good condition at all times. [Regulation 19, §19.303 and A.C.A. §8-4-203 as referenced by A.C.A. §8-4-304 and §8-4-311]
6. This permit subsumes and incorporates all previously issued air permits for this facility. [Regulation 26 and A.C.A. §8-4-203 as referenced by A.C.A. §8-4-304 and §8-4-311]
7. The permittee shall submit, on a semiannual basis, a compliance certification statement for all emitted contaminants at all permitted storage vessels at the facility.

The statement shall provide confirmation that all vessels have been operated in the manner outlined in the Title V permit application and subsequent submittals. A summary sheet of vessel parameters is included in Appendix B. Any deviation from submitted parameters, provided permitted emissions are not exceeded, shall be clearly documented with supporting calculations and attached to the statement. Any parameter deviations which will result in emission increases must be requested and permitted in advance. [Regulation No. 19 §19.705 and 40 CFR 52, Subpart E]

8. For any source which this permit requires periodic emission calculations, and where worst-case operating parameters and throughput have not been exceeded during the recorded period, the permittee may substitute the following: 1) a photocopy of the original worst-case emission calculations originally submitted in the Title V application, and 2) a cover letter certifying that the submitted worst-case parameters and throughput have not been exceeded. [Regulation No. 19 §19.705, and 40 CFR 52, Subpart E]
9. Any annual records or annual emission calculations required by this permit shall be based upon a 12-month rolling total. [Regulation No. 19 §19.705, and 40 CFR 52, Subpart E]
10. The permittee shall conduct weekly observations of visible emissions for all sources assigned an opacity limit. [Regulation No. 19 §19.705, and 40 CFR 52, Subpart E] The visible emission observations shall be used as a method of compliance verification for the opacity limits assigned. The observations shall be conducted by personnel familiar with the facility's visible emissions. If during the weekly observations, visible emissions are detected which appear to be in excess of the permitted opacity limit, the permittee shall:
 - a. Take immediate action to identify the cause of the visible emissions.
 - b. Implement all necessary corrective action.
 - c. Reassess the visible emissions after corrective action is taken.
 - i. If excessive visible emissions are still detected, an opacity reading shall be conducted in accordance with EPA Reference Method 9. This reading shall be conducted by personnel trained and certified in the reference method. If the opacity reading exceeds the permitted limit, further corrective measures shall be taken.
 - ii. If no excessive visible emissions are detected, the incident shall be noted in the records as described below.

The permittee shall maintain records related to all visible emission observations and Method 9 Readings. The records shall be updated on an as-performed basis. The records shall be kept on site and made available to Department personnel upon request. The records shall contain the following items:

- a. the date and time of each observation/reading.

- b. any observance of visible emissions appearing to be above permitted limits, or any Method 9 reading which indicates exceedance.
 - c. the cause of any observed exceedance of opacity limits, corrective action taken, and results of the reassessment.
 - d. The name of the person conducting the observation/reading.
11. No record keeping or parametric monitoring shall be required for any permit condition during any period of time when an affected source is not in operation. The shutdown period for the source must be clearly indicated in any required records or reports. [Regulation No. 19 §19.705, 40 CFR Part 52, Subpart E]
12. Where no more stringent federal regulation applies, the permittee will be found in compliance with fugitive emissions limits in this permit when equipment in the affected unit is operated and maintained consistent with good industry practices, where no more stringent federal regulation applies (e.g., NSPS or MACT), and if the permittee calculates all fugitive emissions for each process area once every five years. The results of these calculations shall be summarized and included in each Title V renewal application. The fugitive emissions may be calculated using usage data (for ancillary chemicals, such as refrigerants and heat transfer fluids), monitoring data with EPA stratified factors, and EPA average SOCFMI factors with component counts. Other methods may also be used if prior approval is received from the Department. [Regulation No. 19 §19.705 and 40 CFR Part 52, Subpart E]
13. Any sources identified as subject to specific Subparts of 40 CFR Parts 60, 61, and 63 must also comply with all applicable requirements of the General Provisions contained in Subpart A of each respective Part. [Regulation No. 19 §19.304]
14. The permittee shall fully comply with all applicable requirements of the National Emission Standard for Asbestos. [Regulation No. 19 §19.304 and 40 CFR Part 61, Subpart M]
15. For all processes proposed to be permitted at this facility, Albemarle may propose emission rate ranges in the air permit application. The upper end of these ranges may be significantly higher than the anticipated emissions from the affected sources. Provided no regulatory restrictions prevent the upper end of the proposed ranges from being incorporated into a final air permit, ADEQ shall state the ranges in the permit, and establish the upper ends as limits in the final air permit. Albemarle shall identify, in each application, sources it desires to be subject to this condition, and agrees to test each of these sources within ninety (90) days of permit issuance. Provided that the results of the testing, for each source, indicates that emissions are below the upper end of the established ranges, Albemarle may, at its discretion, submit an appropriate air permit application to establish emission rates reflecting the results of the testing. [Regulation No. 19 §19.702, 40 CFR Part 52 Subpart E]

Albemarle Corporation
Permit #: 0762-AOP-R16
AFIN: 14-00028

16. The permittee shall comply with all emission rates in the permit, and show compliance through the required testing, operating parameters monitoring, or any other associate permit requirements. [Regulation No. 18 §18.801, Regulation No. 19 §19.401, and A.C.A. §8-4-203 as referenced by A.C.A. §8-4-304 and §8-4-311]
In the event the initial stack test for any constituent at any new or modified source demonstrates that unanticipated emissions are present or exceed the applicable emission limitations, the permittee shall not be considered to be in violation of the permit limits, provided that:
- a. the permittee files an excess emission report which complies with the applicable requirements of Regulation 18 and/or Regulation 19;
 - b. the permitted emission rates were established based on the published emission factors or industry-specific test data;
 - c. the excess emissions do not exceed any threshold established in Regulation 18, or Regulation 19 for a de minimis change, the permittee submits an application for a minor modification of its permit within sixty (60) days of the filing of the excess emissions report; and
 - d. the permittee pays permit fees based upon the modified emission rates from the date of initial operation of the new or modified source.

17. The permittee shall comply with all non criteria emission rates in the permit and show compliance through the required testing, operating parameters monitoring, or any other associated permit requirements. [Regulation No. 18 §18.801 and A.C.A. §8-4-203 as referenced by §8-4-304 and §8-4-311]

Certain emission rates listed in this permit were developed using estimates or published emission factors. For emission limits based on published emission factors or industry specific test data, a change in emission factors that affects the estimated emission rates shall not be considered a violation of the permit limits.

This condition does not apply to criteria pollutants or PM. This condition does not apply to pollutants for which test data is already available, or pollutant emission rates established to comply with an NSPS or NESHAP standard. This condition does not apply to sources constructed or modified before May 1, 2000.

18. Stack testing requirements may be waived for any source which has not operated at least 25% of the twelve-month period prior to a scheduled test. In order for this waiver to be applied, the permittee must submit a written request to the Department at least thirty days in advance of the scheduled test. The request must include records of operating hours for the source in question. [Regulation No. 19 §19.702, 40 CFR Part 52, Subpart E]
19. During any required stack testing event, the affected source shall be operated within 10 percent of the rated throughput capacity. If 90 percent of the rated throughput capacity can not be achieved, the permittee shall thenceforth be limited to 10 percent above the actual tested throughput. [Regulation No. 19 §19.702, 40 CFR Part 52 Subpart E]

20. Where applicable, the permittee must prepare and implement a Startup, Shutdown, and Malfunction Plan (SSM). If the Department requests a review of the SSM, the permittee will make the SSM available for review. The permittee must keep a copy of the SSM at the source's location and retain all previous versions of the SSM plan for five years. [Regulation No. 19 §19.304 and 40 CFR 63.6(e)(3)]

Acid Rain (Title IV)

21. The Director prohibits the permittee to cause any emissions exceeding any allowances the source lawfully holds under Title IV of the Act or the regulations promulgated under the Act. No permit revision is required for increases in emissions allowed by allowances acquired pursuant to the acid rain program, if such increases do not require a permit revision under any other applicable requirement. This permit establishes no limit on the number of allowances held by the permittee. However, the source may not use allowances as a defense for noncompliance with any other applicable requirement of this permit or the Act. The permittee will account for any such allowance according to the procedures established in regulations promulgated under Title IV of the Act. A copy of the facility's Acid Rain Permit is attached in an appendix to this Title V permit. [Regulation 26, §26.701 and 40 CFR 70.6(a)(4)]

Title VI Provisions

22. The permittee must comply with the standards for labeling of products using ozone-depleting substances. [40 CFR Part 82, Subpart E]
- a. All containers containing a class I or class II substance stored or transported, all products containing a class I substance, and all products directly manufactured with a class I substance must bear the required warning statement if it is being introduced to interstate commerce pursuant to §82.106.
 - b. The placement of the required warning statement must comply with the requirements pursuant to §82.108.
 - c. The form of the label bearing the required warning must comply with the requirements pursuant to §82.110.
 - d. No person may modify, remove, or interfere with the required warning statement except as described in §82.112.
23. The permittee must comply with the standards for recycling and emissions reduction, except as provided for MVACs in Subpart B. [40 CFR Part 82, Subpart F]
- a. Persons opening appliances for maintenance, service, repair, or disposal must comply with the required practices pursuant to §82.156.
 - b. Equipment used during the maintenance, service, repair, or disposal of appliances must comply with the standards for recycling and recovery equipment pursuant to §82.158.

- c. Persons performing maintenance, service repair, or disposal of appliances must be certified by an approved technician certification program pursuant to §82.161.
- d. Persons disposing of sma II appliances, MVACs, and MVAC like appliances must comply with record keeping requirements pursuant to §82.166. (“MVAC like appliance” as defined at §82.152)
- e. Persons owning commercial or industrial process refrigeration equipment must comply with leak repair requirements pursuant to §82.156.
- f. Owners/operators of appliances normally containing 50 or more pounds of refrigerant must keep records of refrigerant purchased and added to such appliances pursuant to §82.166.

- 24. If the permittee manufactures, transforms, destroys, imports, or exports a class I or class II substance, the permittee is subject to all requirements as specified in 40 CFR Part 82, Subpart A, Production and Consumption Controls.
- 25. If the permittee performs a service on motor (fleet) vehicles when this service involves ozone depleting substance refrigerant (or regulated substitute substance) in the motor vehicle air conditioner (MVAC), the permittee is subject to all the applicable requirements as specified in 40 CFR part 82, Subpart B, Servicing of Motor Vehicle Air Conditioners.

The term “motor vehicle” as used in Subpart B does not include a vehicle in which final assembly of the vehicle has not been completed. The term “MVAC” as used in Subpart B does not include the air tight sealed refrigeration system used as refrigerated cargo, or the system used on passenger buses using HCFC 22 refrigerant.

- 26. The permittee can switch from any ozone depleting substance to any alternative listed in the Significant New Alternatives Program (SNAP) promulgated pursuant to 40 CFR Part 82, Subpart G.

Permit Shield

- 27. Compliance with the conditions of this permit shall be deemed compliance with all applicable requirements, as of the date of permit issuance, included in and specifically identified in the following table of this condition. The permit specifically identifies the following as applicable requirements based upon the information submitted by the permittee in an application dated September 10, 2004.

Applicable Regulations

Source No.	Regulation	Description
Facility	Arkansas Regulation 19	Compilation of Regulations of the Arkansas State Implementation Plan for Air Pollution Control
Facility	Arkansas Regulation 26	Regulations of the Arkansas Operating Air Permit Program
Facility	40 CFR Part 61, Subpart M	National Emission Standard for Asbestos

Albemarle Corporation
 Permit #: 0762-AOP-R16
 AFIN: 14-00028

Source No.	Regulation	Description		
DECTP Process	40 CFR Part 61, Subpart FF	National Emission Standards for Benzene Waste Operations		
All sources or units subject to a 40 CFR Part 64 standard	40 CFR Part 63, Subpart A	National Emission Standards for Hazardous Air Pollutants for Source Categories, General Provisions		
AB-15	40 CFR Part 63, Subpart F	National Emission Standards for Hazardous Air Pollutants from the Synthetic Organic Chemical Manufacturing Industry		
AB-15	40 CFR Part 63, Subpart G	National Emission Standards for Hazardous Air Pollutants from the Synthetic Organic Chemical Manufacturing Industry for Process Vents, Storage Vessels, Transfer Operations, and Wastewater		
AB-15	40 CFR Part 63, Subpart H	National Emission Standards for Organic Hazardous Air Pollutants for Equipment Leaks		
TB-03	40 CFR Part 60, Subpart Kb	Standards of Performance for Volatile Organic Liquid Storage Vessels		
TB-29	40 CFR Part 60, Subpart VV	Standards of Performance for Equipment Leaks of VOC in the Synthetic Organic Chemicals Manufacturing Industry		
TB-03	40 CFR Part 63, Subpart F	National Emission Standards for Hazardous Air Pollutants from the Synthetic Organic Chemical Manufacturing Industry		
TB-11				
TB-17				
TB-25				
TB-29				
TB-30			40 CFR Part 63, Subpart G	National Emission Standards for Hazardous Air Pollutants from the Synthetic Organic Chemical Manufacturing Industry for Process Vents, Storage Vessels, Transfer Operations, and Wastewater
TB-31				
TB-32				
TB-34				
TB-35			40 CFR Part 63, Subpart H	National Emission Standards for Organic Hazardous Air Pollutants for Equipment Leaks
WW-01				
NC-14 Process	40 CFR Part 82, Subpart A	Protection of Stratospheric Ozone, Production and Consumption Controls		
NC-14 Process	40 CFR Part 82, Subpart E	Protection of Stratospheric Ozone, The Labeling of Products Using Ozone-Depleting Substances		
NC-17 CMPU	40 CFR Part 63, Subpart F	National Emission Standards for Hazardous Air Pollutants from the Synthetic Organic Chemical Manufacturing Industry		
NC-17 CMPU	40 CFR Part 63, Subpart G	National Emission Standards for Hazardous Air Pollutants from the Synthetic Organic Chemical Manufacturing Industry for Process Vents, Storage Vessels, Transfer Operations, and Wastewater		
NC-17 CMPU	40 CFR Part 63, Subpart H	National Emission Standards for Organic Hazardous Air Pollutants for Equipment Leaks		
21-01 21-02	40 CFR Part 61, Subpart A	National Emission Standards for Hazardous Air Pollutants, General Provisions		
21-01 21-02	40 CFR Part 61, Subpart J	National Emission Standards for Equipment Leaks (Fugitive Emission Sources) of Benzene		
21-01 21-02	40 CFR Part 61, Subpart V	National Emission Standards for Equipment Leaks (Fugitive Emission Sources)		

Albemarle Corporation
 Permit #: 0762-AOP-R16
 AFIN: 14-00028

Source No.	Regulation	Description
21-01 21-02	40 CFR Part 61, Subpart Y	National Emission Standards for Benzene Emissions from Benzene Storage Vessels
21-01 21-02	40 CFR Part 61, Subpart FF	National Emission Standards for Benzene Waste Operations
MS-05	40 CFR Part 63, Subpart JJ	National Emission Standards for Wood Furniture Manufacturing Operations
Facility	40 CFR Part 82, Subpart E	Protection of Stratospheric Ozone, The Labeling of Products Using Ozone-Depleting Substances
MCPU's: DECTP DMTDA NC-12 NC-15 NC-17 NC-21 NC-23	40 CFR Part 63, Subpart FFFF	National Emission Standards for Hazardous Air Pollutants: Miscellaneous Organic Chemical Manufacturing and Miscellaneous Coating Manufacturing; Compliance Date: May 10, 2008
CB-04 All Ethylene Glycol Storage	40 CFR Part 63, Subpart EEEE	National Emission Standards for Hazardous Air Pollutants: Organic Liquids Distribution (Non-Gasoline)

28. The permittee shall document that all reciprocating internal combustion engines (RICE) are less than 500 brake horsepower or are exempt from 40 CFR Part 63, Subpart ZZZZ per §63.6590(b)(3) or are subject only to the initial notification requirement per §63.6590(b)(1). The permittee shall not begin construction, installation, and/or operation of a RICE subject to any standards or requirements beyond the initial notification requirement under 40 CFR Part 63, Subpart ZZZZ without first submitting and obtaining approval from ADEQ for a permit modification that addresses applicable requirements and compliance. [Regulation No. 19, §19.304 and 40 CFR Part 63, Subpart ZZZZ]
29. The permittee shall not operate the Clear Completion Fluids equipment under the Calcium Bromide Alternate Operating Scenario (Specific Conditions #28 through #35) until such time the permittee demonstrates through air dispersion modeling and analysis acceptable methyl bromide off-site impacts. [Regulation No. 18 18.1004 and A.C.A. §8-4-203 as referenced by §8-4-304 and §8-4-311]

Note: The above condition was placed in the permit at the request of the permittee. During the 2005 Title V Renewal process, MeBr modeling was submitted and accepted. Due to the change in regulatory dispersion modeling from ISCST3 to AERMOD, the modeled MeBr emission rates may result in unacceptable offsite impacts.

SECTION VII: INSIGNIFICANT ACTIVITIES

The following sources are insignificant activities. Any activity that has a state or federal applicable requirement shall be considered a significant activity even if this activity meets the criteria of §26.304 of Regulation 26 or listed in the table below. Insignificant activity determinations rely upon the information submitted by the permittee in an application dated November 20, 2008.

Insignificant Source					
SN	Description	Category	Pollutant	Estimated Losses	
				lb/hr	ton/yr
BR-05	Recovered Groundwater Storage Tank, T-3045	A13	VOC	<0.01	<0.01
			Bromoform	<0.01	<0.01
			Ethylene Dibromide	<0.01	<0.01
			Ethylene Dichloride	<0.01	<0.01
			Toluene	<0.01	<0.01
			Br ₂	<0.01	<0.01
BR-07	Sulfuric Acid Storage Tank, T-3000	B21	H ₂ SO ₄	<0.01	<0.01
			Water Vapor	N/A	N/A
BR-10	Chilled H ₂ O Storage Tank, T-3047	B21	Water Vapor	N/A	N/A
BR-13	Centrate Storage Tank T-3065 (Sodium Bromide)	B21	Water Vapor	N/A	N/A
ED-04	Recycle Sodium Bromide Tank T-4071A	B21	Water Vapor	N/A	N/A
BR-16	C-12 Olefin Storage (up to 10,000 gal total capacity)	A3	VOC	Trace	0.07
-	Hot Water Tank B-3010	B21	Water Vapor	N/A	N/A
SL-03	Sulfinol Storage Sump (S-1901)	A3	Sulfolane	<0.01	<0.01
			DIPA	<0.01	<0.01
SL-04	MDEA Storage Tank (T-5001)	A3	MDEA	<0.01	<0.01
SR-03	Molten Sulfur Pit and Loadout	A13	H ₂ S	0.22	0.96
			SO ₂	0.42	1.80
CB-03	NaOH Storage Tank	B21	Water Vapor	N/A	N/A
CB-05	CaBr ₂ Storage Tank	B21	Water Vapor	N/A	N/A
CB-06	CaBr ₂ Storage Tank	B21	Water Vapor	N/A	N/A
CB-07	Product Rundown Tank	B21	Water Vapor	N/A	N/A
CB-08	Product Rundown Tank	B21	Water Vapor	N/A	N/A
CB-09	Slurry Feed Tank	B21	Water Vapor	N/A	N/A
CB-10	Wash Water Tank	A13	VOC	<0.10	<0.10
			HCl	<0.10	<0.10
			HBr	<0.10	<0.10
			Acetone	<0.10	<0.10
CB-11	Acid Storage Tank	B21	Water Vapor	N/A	N/A
CB-12	Product Storage Tank	B21	Water Vapor	N/A	N/A
CB-13	Product Storage Tank	B21	Water Vapor	N/A	N/A
CB-14	Product Storage Tank	B21	Water Vapor	N/A	N/A
CB-15	Product Storage Tank	B21	Water Vapor	N/A	N/A
CB-19	Ammonium Hydroxide Storage Bins	B21	NH ₄ OH	Trace	Trace
CB-20	Formic Acid Storage Bins	A13	Formic Acid	Trace	<0.01

Albemarle Corporation
 Permit #: 0762-AOP-R16
 AFIN: 14-00028

Insignificant Source					
SN	Description	Category	Pollutant	Estimated Losses	
				lb/hr	ton/yr
-	DECTP Process Sewers	A13	VOC	Trace	Minimal
			Toluene	Trace	Minimal
			Naphthalene	Trace	Minimal
			Methyl Naphthalene	Trace	Minimal
			HCl	Trace	Minimal
			POM	Trace	Minimal
DE-05	Pressure Vessel	A13	No Emissions	N/A	N/A
N/A	Sulfuric Acid Tote Bin	B24/43	H ₂ SO ₄	<0.01	<0.01
			SO ₂	<0.01	<0.01
DE-27	Sodium Sulfite Storage Tank	B21	No Emissions	N/A	N/A
AD-16	Natural Gas-Fired Heater < 10 MMBtu/hr	A1	PM/PM ₁₀	0.03	0.14
			SO ₂	0.01	0.05
			VOC	0.16	0.75
			CO	0.24	1.06
			NO _x	0.28	1.23
AD-31	Liquid Hydrogen Pressurized Tank	B21	No Emissions	N/A	N/A
AD-32	Natural Gas-Fired Heater < 10 MMBtu/hr	A1	PM/PM ₁₀	0.04	0.16
			SO ₂	0.01	0.01
			VOC	0.03	0.14
			CO	0.38	1.66
			NO _x	0.45	1.97
AD-38	Alcohol Addition System	A13	VOC	0.005	0.02
AB-17	T-703 Ethylene Glycol Storage Tank	A3	Ethylene Glycol	0.001	0.001
AB-18	Alkyl Bromide Waste Water	A13	VOC	0.08	0.34
			MeCl ₂ ^{HAP}	0.01	0.06
DB-02	Raw Materials Storage Tank	A3	VOC	0.1	0.44
DB-03	Sulfuric Acid Storage Tank	B21	H ₂ SO ₄	0.01	0.04
DB-11	Slurry Feed Tank	B21	Water Vapor	N/A	N/A
DB-12	Slurry Feed Tank	B21	Water Vapor	N/A	N/A
TB-08	Polymer Transfer	A13	PM	0.03	0.14
			PM ₁₀	0.02	0.07
TB-13	Refrigerant Storage Tank	A3	Ethylene Glycol	<0.01	<0.01
TB-26	Sulfuric Acid Storage Tank Alternate Use: Ethylene Glycol Storage	A3	VOC	0.01	0.04
			H ₂ SO ₄	0.01	0.05
			Ethylene Glycol	0.01	0.04
TB-27	Refrigerant Storage Tank	A3	Ethylene Glycol	<0.01	<0.01
TB-36	Water Scrubber Tank	A3	VOC	0.04	0.03
TB-40	Raw Material Weigh Vessel	A13	PM/PM ₁₀	0.10	0.44
TB-43	During NC-22 Scenario B	A13	VOC	0.10	0.10
TB-44	Heating System Expansion Tank	A13	VOC	<0.01	<0.01
--	Bleach/Product Storage and Mix Tanks (3)	B21	Water Vapor	N/A	N/A
--	Hot Water Tank 67-65-1	A13	Methanol	<0.01	0.02
--	Area Safety Relief Knockout Pot D-9505	A13	Non-VOC Caustic	N/A	N/A

Insignificant Source					
SN	Description	Category	Pollutant	Estimated Losses	
				lb/hr	ton/yr
--	Antifoam Storage Tank, T-95107	A13	Org. Liqs., 3.5 psia	N/A	N/A
--	Hot Water Tank, T-602	A13	VOC	<0.01	0.02
15-14	2 Natural Gas Process Heaters	A1	PM/PM ₁₀	0.02	0.09
			SO ₂	0.01	0.04
			VOC	0.02	0.09
			CO	0.18	0.79
			NO _x	0.30	1.31
--	Pressurized Ethylene Glycol Storage Tank, (D-9972)	A13	None	N/A	N/A
16-09	EBTBP Ambient Dust Collector SF9398	A13	PM/PM ₁₀	0.1	0.3
16-30	Indirect-Fired Gas Heater	A1	PM/PM ₁₀	0.1	0.5
			SO ₂	0.1	0.5
			VOC	0.1	0.1
			CO	0.2	0.8
			NO _x	0.4	1.8
16-32	Sulfuric Acid Tank, T-9315	B21	H ₂ SO ₄ + SO ₃	<0.1	<0.1
16-33	Molten Sulfur Tank, T-9365	A13	H ₂ S	0.10	0.43
			SO ₂	0.19	0.81
16-34	Sulfuric Acid Tank, T-9358	B21	H ₂ SO ₄ + SO ₃	<0.1	<0.1
--	Ethylene Glycol Tanks, T-93952, T-9393, T-9351, T-9359, T-9392	A3	Ethylene Glycol	<0.01	<0.01
--	Tempered Water Tank, T-9368	B21	Water Vapor	N/A	N/A
--	Hot Oil Expansion Tank / Heat Transfer fluid Tank, T-9354	A2	VOC	Trace	0.95
--	Hot Oil Surge Tank, D-3490	A13	VOC	Trace	<0.01
--	Boiler Water Treatment Chemical Storage Tanks	B21	N/A	N/A	N/A
--	Sodium Sulfate Tank	B21	None	N/A	N/A
--	Boiler Dearator	B21	None	N/A	N/A
--	Caustic Tote Bin	B21	None	N/A	N/A
BT-02	Purchased Brine Surge Tank, T-3017	A13	VOC	0.01	0.05
			H ₂ S	0.01	0.05
BT-03	Brine/Oil Separator OS-3002	A13	VOC	0.01	0.05
			H ₂ S	0.02	0.09
BT-04	Feed Brine Pump Suction Header Vent	A13	VOC	0.01	0.05
			H ₂ S	0.01	0.05
BT-05	Overflow Line Vent	A13	VOC	0.01	0.05
			H ₂ S	0.01	0.05
BT-06	Overflow Line Vent	A13	VOC	0.01	0.05
			H ₂ S	0.01	0.05
BT-07	Feed Brine Pump Suction Header Vent	A13	VOC	0.01	0.05
			H ₂ S	0.01	0.05
BT-08	Brine/Oil Separator Outlet Line Vent	A13	VOC	0.01	0.05
			H ₂ S	0.01	0.05
BT-09	Overflow Line Vent	A13	VOC	0.01	0.05
			H ₂ S	0.01	0.05

Albemarle Corporation
 Permit #: 0762-AOP-R16
 AFIN: 14-00028

Insignificant Source					
SN	Description	Category	Pollutant	Estimated Losses	
				lb/hr	ton/yr
BT-10	Brine/Oil Separator Outlet Line Vent (OS-3002)	A13	VOC	0.01	0.05
			H ₂ S	0.01	0.05
BT-14	Vacuum Pump Vent	A13	VOC	0.01	0.05
			H ₂ S	0.01	0.05
BT-15	Overflow Line Vent	A13	VOC	0.01	0.05
			H ₂ S	0.01	0.05
BT-18	Brine Underflow Line Vent	A13	VOC	0.01	0.05
			H ₂ S	0.01	0.05
BT-19	Brine Underflow Line Vent	A13	VOC	0.01	0.05
			H ₂ S	0.01	0.05
BT-20	Brine Underflow Line Vent	A13	VOC	0.01	0.05
			H ₂ S	0.01	0.05
DM-04	Catalyst Loading	A13	PM/PM ₁₀	0.06	0.23
DM-05	Stabilizer Hopper	A13	PM/PM ₁₀	0.03	0.13
DM-08	Bleach Storage Tank (6,000 gallons)	B21	Water Vapor Nitrogen Oxygen	N/A	N/A
--	Solid Waste Vault No. 2	A13	PM/PM ₁₀ VOC	Trace Trace	Trace Trace
--	Outfall 002 Bioreactor	A13	Chlorine ^{HAP}	Trace	Trace
--	PSV-1 Sumps	A13	VOC	0.34	1.51
MS-09	Diesel fuel Storage Tanks (up to 10,000 gallons total capacity)	A3	VOC	N/A	0.12
MS-10	Gasoline Storage Tanks (up to 2,000 gallons total capacity)	A13	VOC	N/A	1.30
			HAPs	N/A	0.07
MS-11	Cooling Towers (Maintenance/Support Facilities)	A13	PM/PM ₁₀ Chlorine ^{HAP}	0.75 Trace	3.29 Trace
--	Drinking Water Treatment and Distribution	A13	N/A	N/A	N/A
--	Quality Control Laboratory	A5	N/A	N/A	N/A
--	Paved Plant Roads and Parking Lot	B74	N/A	N/A	N/A
--	Unpaved Plant Roads	B74	PM	N/A	3.50
			PM ₁₀	N/A	1.07
--	Building Air Conditioning System	B2	N/A	N/A	N/A
--	Filter Aid Tanks T-1306 and T-1307	B21	Water Vapor.	N/A	N/A
--	Sulfuric Acid Tank	B21	Water Vapor	N/A	N/A

Albemarle Corporation
 Permit #: 0762-AOP-R16
 AFIN: 14-00028

Insignificant Source					
SN	Description	Category	Pollutant	Estimated Losses	
				lb/hr	ton/yr
--	A-12 Emergency Systems Generators – Phone System and Admin Bldg Backup, Emergency Fire Pumps (2), Potable Water Supply Backup, Material Analyzer Backup, Outfall Flow Monitor Battery Backup	A12	N/A	N/A	N/A
Totals for Category A1			PM	0.19	0.89
			PM ₁₀	0.19	0.89
			SO ₂	0.13	1.05
			VOC	.31	1.08
			CO	1.00	4.31
			NO _x	1.43	6.31
Totals for Category A2			VOC	N/A	0.95
Totals for Category A3			VOC	0.22	0.80
			H ₂ SO ₄	0.01	0.05
			Sulfolane	0.01	0.01
			DIPA	0.01	0.01
			MDEA	0.01	0.01
			Any Single HAP	0.04	0.07
			Total HAP	0.04	0.07
Totals for Category A13			VOC	1.04	4.92
			PM	1.07	4.54
			PM ₁₀	1.06	4.46
			SO ₂	0.61	2.61
			H ₂ S	0.47	2.13
			Br ₂	0.01	0.01
			HCl	<0.10	<0.10
			HBr	<0.10	<0.10
			Acetone	<0.10	<0.10
			Formic Acid	Trace	0.01
			Any Single HAP	0.01	0.06
			Total HAP	0.06	0.12

SECTION VIII: GENERAL PROVISIONS

1. Any terms or conditions included in this permit which specify and reference Arkansas Pollution Control & Ecology Commission Regulation 18 or the Arkansas Water and Air Pollution Control Act (A.C.A. §8-4-101 et seq.) as the sole origin of and authority for the terms or conditions are not required under the Clean Air Act or any of its applicable requirements, and are not federally enforceable under the Clean Air Act. Arkansas Pollution Control & Ecology Commission Regulation 18 was adopted pursuant to the Arkansas Water and Air Pollution Control Act (A.C.A. §8-4-101 et seq.). Any terms or conditions included in this permit which specify and reference Arkansas Pollution Control & Ecology Commission Regulation 18 or the Arkansas Water and Air Pollution Control Act (A.C.A. §8-4-101 et seq.) as the origin of and authority for the terms or conditions are enforceable under this Arkansas statute. [40 CFR 70.6(b)(2)]
2. This permit shall be valid for a period of five (5) years beginning on the date this permit becomes effective and ending five (5) years later. [40 CFR 70.6(a)(2) and §26.701(B) of the Regulations of the Arkansas Operating Air Permit Program (Regulation 26)]
3. The permittee must submit a complete application for permit renewal at least six (6) months before permit expiration. Permit expiration terminates the permittee's right to operate unless the permittee submitted a complete renewal application at least six (6) months before permit expiration. If the permittee submits a complete application, the existing permit will remain in effect until the Department takes final action on the renewal application. The Department will not necessarily notify the permittee when the permit renewal application is due. [Regulation 26, §26.406]
4. Where an applicable requirement of the Clean Air Act, as amended, 42 U.S.C. 7401, et seq. (Act) is more stringent than an applicable requirement of regulations promulgated under Title IV of the Act, the permit incorporates both provisions into the permit, and the Director or the Administrator can enforce both provisions. [40 CFR 70.6(a)(1)(ii) and Regulation 26, §26.701(A)(2)]
5. The permittee must maintain the following records of monitoring information as required by this permit.
 - a. The date, place as defined in this permit, and time of sampling or measurements;
 - b. The date(s) analyses performed;
 - c. The company or entity performing the analyses;
 - d. The analytical techniques or methods used;
 - e. The results of such analyses; and
 - f. The operating conditions existing at the time of sampling or measurement.

[40 CFR 70.6(a)(3)(ii)(A) and Regulation 26, §26.701(C)(2)]

Albemarle Corporation
Permit #: 0762-AOP-R16
AFIN: 14-00028

6. The permittee must retain the records of all required monitoring data and support information for at least five (5) years from the date of the monitoring sample, measurement, report, or application. Support information includes all calibration and maintenance records and all original strip chart recordings for continuous monitoring instrumentation, and copies of all reports required by this permit. [40 CFR 70.6(a)(3)(ii)(B) and Regulation 26, §26.701(C)(2)(b)]
7. The permittee must submit reports of all required monitoring every six (6) months. If permit establishes no other reporting period, the reporting period shall end on the last day of the anniversary month of the initial Title V permit. The report is due within thirty (30) days of the end of the reporting period. Although the reports are due every six months, each report shall contain a full year of data. The report must clearly identify all instances of deviations from permit requirements. A responsible official as defined in Regulation No. 26, §26.2 must certify all required reports. The permittee will send the reports to the address below:

Arkansas Department of Environmental Quality
Air Division
ATTN: Compliance Inspector Supervisor
5301 Northshore Drive
North Little Rock, AR 72118-5317

[40 C.F.R. 70.6(a)(3)(iii)(A) and Regulation 26, §26.701(C)(3)(a)]

8. The permittee shall report to the Department all deviations from permit requirements, including those attributable to upset conditions as defined in the permit.
 - a. For all upset conditions (as defined in Regulation 19, § 19.601), the permittee will make an initial report to the Department by the next business day after the discovery of the occurrence. The initial report may be made by telephone and shall include:
 - i. The facility name and location;
 - ii. The process unit or emission source deviating from the permit limit;
 - iii. The permit limit, including the identification of pollutants, from which deviation occurs;
 - iv. The date and time the deviation started;
 - v. The duration of the deviation;
 - vi. The average emissions during the deviation;
 - vii. The probable cause of such deviations;
 - viii. Any corrective actions or preventive measures taken or being taken to prevent such deviations in the future; and
 - ix. The name of the person submitting the report.

Albemarle Corporation
Permit #: 0762-AOP-R16
AFIN: 14-00028

The permittee shall make a full report in writing to the Department within five (5) business days of discovery of the occurrence. The report must include, in addition to the information required by the initial report, a schedule of actions taken or planned to eliminate future occurrences and/or to minimize the amount the permit's limits were exceeded and to reduce the length of time the limits were exceeded. The permittee may submit a full report in writing (by facsimile, overnight courier, or other means) by the next business day after discovery of the occurrence, and the report will serve as both the initial report and full report.

- b. For all deviations, the permittee shall report such events in semi-annual reporting and annual certifications required in this permit. This includes all upset conditions reported in 8a above. The semi-annual report must include all the information as required by the initial and full reports required in 8a.

[Regulation 19, §19.601 and §19.602, Regulation 26, §26.701(C)(3)(b), and 40 CFR 70.6(a)(3)(iii)(B)]

9. If any provision of the permit or the application thereof to any person or circumstance is held invalid, such invalidity will not affect other provisions or applications hereof which can be given effect without the invalid provision or application, and to this end, provisions of this Regulation are declared to be separable and severable. [40 CFR 70.6(a)(5), Regulation 26, §26.701(E), and A.C.A. §8-4-203 as referenced by A.C.A. §8-4-304 and §8-4-311]
10. The permittee must comply with all conditions of this Part 70 permit. Any permit noncompliance with applicable requirements as defined in Regulation 26 constitutes a violation of the Clean Air Act, as amended, 42 U.S.C. §7401, et seq. and is grounds for enforcement action; for permit termination, revocation and reissuance, for permit modification; or for denial of a permit renewal application. [40 CFR 70.6(a)(6)(i) and Regulation 26, §26.701(F)(1)]
11. It shall not be a defense for a permittee in an enforcement action that it would have been necessary to halt or reduce the permitted activity to maintain compliance with the conditions of this permit. [40 CFR 70.6(a)(6)(ii) and Regulation 26, §26.701(F)(2)]
12. The Department may modify, revoke, reopen and reissue the permit or terminate the permit for cause. The filing of a request by the permittee for a permit modification, revocation and reissuance, termination, or of a notification of planned changes or anticipated noncompliance does not stay any permit condition. [40 CFR 70.6(a)(6)(iii) and Regulation 26, §26.701(F)(3)]
13. This permit does not convey any property rights of any sort, or any exclusive privilege. [40 CFR 70.6(a)(6)(iv) and Regulation 26, §26.701(F)(4)]

Albemarle Corporation
Permit #: 0762-AOP-R16
AFIN: 14-00028

14. The permittee must furnish to the Director, within the time specified by the Director, any information that the Director may request in writing to determine whether cause exists for modifying, revoking and reissuing, or terminating the permit or to determine compliance with the permit. Upon request, the permittee must also furnish to the Director copies of records required by the permit. For information the permittee claims confidentiality, the Department may require the permittee to furnish such records directly to the Director along with a claim of confidentiality. [40 CFR 70.6(a)(6)(v) and Regulation 26, §26.701(F)(5)]
15. The permittee must pay all permit fees in accordance with the procedures established in Regulation 9. [40 CFR 70.6(a)(7) and Regulation 26, §26.701(G)]
16. No permit revision shall be required, under any approved economic incentives, marketable permits, emissions trading and other similar programs or processes for changes provided for elsewhere in this permit. [40 CFR 70.6(a)(8) and Regulation 26, §26.701(H)]
17. If the permit allows different operating scenarios, the permittee shall, contemporaneously with making a change from one operating scenario to another, record in a log at the permitted facility a record of the operational scenario. [40 CFR 70.6(a)(9)(i) and Regulation 26, §26.701(I)(1)]
18. The Administrator and citizens may enforce under the Act all terms and conditions in this permit, including any provisions designed to limit a source's potential to emit, unless the Department specifically designates terms and conditions of the permit as being federally unenforceable under the Act or under any of its applicable requirements. [40 CFR 70.6(b) and Regulation 26, §26.702(A) and (B)]
19. Any document (including reports) required by this permit must contain a certification by a responsible official as defined in Regulation 26, §26.2. [40 CFR 70.6(c)(1) and Regulation 26, §26.703(A)]
20. The permittee must allow an authorized representative of the Department, upon presentation of credentials, to perform the following: [40 CFR 70.6(c)(2) and Regulation 26, §26.703(B)]
 - a. Enter upon the permittee's premises where the permitted source is located or emissions related activity is conducted, or where records must be kept under the conditions of this permit;
 - b. Have access to and copy, at reasonable times, any records required under the conditions of this permit;
 - c. Inspect at reasonable times any facilities, equipment (including monitoring and air pollution control equipment), practices, or operations regulated or required under this permit; and

- d. As authorized by the Act, sample or monitor at reasonable times substances or parameters for assuring compliance with this permit or applicable requirements.
21. The permittee shall submit a compliance certification with the terms and conditions contained in the permit, including emission limitations, standards, or work practices. The permittee must submit the compliance certification annually within 30 days following the last day of the anniversary month of the initial Title V permit. The permittee must also submit the compliance certification to the Administrator as well as to the Department. All compliance certifications required by this permit must include the following: [40 CFR 70.6(c)(5) and Regulation 26, §26.703(E)(3)]
 - a. The identification of each term or condition of the permit that is the basis of the certification;
 - b. The compliance status;
 - c. Whether compliance was continuous or intermittent;
 - d. The method(s) used for determining the compliance status of the source, currently and over the reporting period established by the monitoring requirements of this permit; and
 - e. Such other facts as the Department may require elsewhere in this permit or by §114(a)(3) and §504(b) of the Act.
 22. Nothing in this permit will alter or affect the following: [Regulation 26, §26.704(C)]
 - a. The provisions of Section 303 of the Act (emergency orders), including the authority of the Administrator under that section;
 - b. The liability of the permittee for any violation of applicable requirements prior to or at the time of permit issuance;
 - c. The applicable requirements of the acid rain program, consistent with §408(a) of the Act; or
 - d. The ability of EPA to obtain information from a source pursuant to §114 of the Act.
 23. This permit authorizes only those pollutant emitting activities addressed in this permit. [A.C.A. §8-4-203 as referenced by A.C.A. §8-4-304 and §8-4-311]
 24. The permittee may request in writing and at least 15 days in advance of the deadline, an extension to any testing, compliance or other dates in this permit. No such extensions are authorized until the permittee receives written Department approval. The Department may grant such a request, at its discretion in the following circumstances:
 - a. Such an extension does not violate a federal requirement;
 - b. The permittee demonstrates the need for the extension; and
 - c. The permittee documents that all reasonable measures have been taken to meet the current deadline and documents reasons it cannot be met.

Albemarle Corporation
Permit #: 0762-AOP-R16
AFIN: 14-00028

[Regulation 18, §18.314(A), Regulation 19, §19.416(A), Regulation 26, §26.1013(A), A.C.A. §8-4-203 as referenced by A.C.A. §8-4-304 and §8-4-311, and 40 CFR Part 52, Subpart E]

25. The permittee may request in writing and at least 30 days in advance, temporary emissions and/or testing that would otherwise exceed an emission rate, throughput requirement, or other limit in this permit. No such activities are authorized until the permittee receives written Department approval. Any such emissions shall be included in the facility's total emissions and reported as such. The Department may grant such a request, at its discretion under the following conditions:
- a. Such a request does not violate a federal requirement;
 - b. Such a request is temporary in nature;
 - c. Such a request will not result in a condition of air pollution;
 - d. The request contains such information necessary for the Department to evaluate the request, including but not limited to, quantification of such emissions and the date/time such emission will occur;
 - e. Such a request will result in increased emissions less than five tons of any individual criteria pollutant, one ton of any single HAP and 2.5 tons of total HAPs; and
 - f. The permittee maintains records of the dates and results of such temporary emissions/testing.

[Regulation 18, §18.314(B), Regulation 19, §19.416(B), Regulation 26, §26.1013(B), A.C.A. §8-4-203 as referenced by A.C.A. §8-4-304 and §8-4-311, and 40 CFR Part 52, Subpart E]

26. The permittee may request in writing and at least 30 days in advance, an alternative to the specified monitoring in this permit. No such alternatives are authorized until the permittee receives written Department approval. The Department may grant such a request, at its discretion under the following conditions:
- a. The request does not violate a federal requirement;
 - b. The request provides an equivalent or greater degree of actual monitoring to the current requirements; and
 - c. Any such request, if approved, is incorporated in the next permit modification application by the permittee.

[Regulation 18, §18.314(C), Regulation 19, §19.416(C), Regulation 26, §26.1013(C), A.C.A. §8-4-203 as referenced by A.C.A. §8-4-304 and §8-4-311, and 40 CFR Part 52, Subpart E]

APPENDIX A

Applicable Federal Regulations

40 CFR Part 60 Subpart Kb
40 CFR Part 60 Subpart VV

40 CFR Part 61 Subpart J
40 CFR Part 61 Subpart M
40 CFR Part 61 Subpart V
40 CFR Part 61 Subpart Y
40 CFR Part 61 Subpart FF

40 CFR Part 63 Subpart F
40 CFR Part 63 Subpart G
40 CFR Part 63 Subpart H
40 CFR Part 63 Subpart I
40 CFR Part 63 Subpart JJ
40 CFR Part 63 Subpart EEEE
40 CFR Part 63 Subpart FFFF

40 CFR Part 82 Subpart A
40 CFR Part 82 Subpart E

[Home Page](#) > [Executive Branch](#) > [Code of Federal Regulations](#) > [Electronic Code of Federal Regulations](#)

Electronic Code of Federal Regulations

e-CFR
TM

e-CFR Data is current as of August 1, 2007

Title 40: Protection of Environment

PART 60—STANDARDS OF PERFORMANCE FOR NEW STATIONARY SOURCES

[Browse Previous](#) | [Browse Next](#)

Subpart Kb—Standards of Performance for Volatile Organic Liquid Storage Vessels (Including Petroleum Liquid Storage Vessels) for Which Construction, Reconstruction, or Modification Commenced After July 23, 1984

Source: 52 FR 11429, Apr. 8, 1987, unless otherwise noted.

§ 60.110b Applicability and designation of affected facility.

(a) Except as provided in paragraph (b) of this section, the affected facility to which this subpart applies is each storage vessel with a capacity greater than or equal to 75 cubic meters (m³) that is used to store volatile organic liquids (VOL) for which construction, reconstruction, or modification is commenced after July 23, 1984.

(b) This subpart does not apply to storage vessels with a capacity greater than or equal to 151 m³ storing a liquid with a maximum true vapor pressure less than 3.5 kilopascals (kPa) or with a capacity greater than or equal to 75 m³ but less than 151 m³ storing a liquid with a maximum true vapor pressure less than 15.0 kPa.

(c) [Reserved]

(d) This subpart does not apply to the following:

(1) Vessels at coke oven by-product plants.

(2) Pressure vessels designed to operate in excess of 204.9 kPa and without emissions to the atmosphere.

(3) Vessels permanently attached to mobile vehicles such as trucks, railcars, barges, or ships.

(4) Vessels with a design capacity less than or equal to 1,589.874 m³ used for petroleum or condensate stored, processed, or treated prior to custody transfer.

(5) Vessels located at bulk gasoline plants.

(6) Storage vessels located at gasoline service stations.

(7) Vessels used to store beverage alcohol.

(8) Vessels subject to subpart GGGG of 40 CFR part 63.

(e) *Alternative means of compliance* —(1) *Option to comply with part 65.* Owners or operators may choose to comply with 40 CFR part 65, subpart C, to satisfy the requirements of §§60.112b through 60.117b for storage vessels that are subject to this subpart that meet the specifications in paragraphs (e)(1)(i) and (ii) of this section. When choosing to comply with 40 CFR part 65, subpart C, the monitoring requirements of §60.116b(c), (e), (f)(1), and (g) still apply. Other provisions applying to owners or operators who choose to comply with 40 CFR part 65 are provided in 40 CFR 65.1.

(i) A storage vessel with a design capacity greater than or equal to 151 m³ containing a VOL that, as stored, has a maximum true vapor pressure equal to or greater than 5.2 kPa; or

(ii) A storage vessel with a design capacity greater than 75 m³ but less than 151 m³ containing a VOL that, as stored, has a maximum true vapor pressure equal to or greater than 27.6 kPa.

(2) *Part 60, subpart A.* Owners or operators who choose to comply with 40 CFR part 65, subpart C, must also comply with §§60.1, 60.2, 60.5, 60.6, 60.7(a)(1) and (4), 60.14, 60.15, and 60.16 for those storage vessels. All sections and paragraphs of subpart A of this part that are not mentioned in this paragraph (e)(2) do not apply to owners or operators of storage vessels complying with 40 CFR part 65, subpart C, except that provisions required to be met prior to implementing 40 CFR part 65 still apply. Owners and operators who choose to comply with 40 CFR part 65, subpart C, must comply with 40 CFR part 65, subpart A.

(3) *Internal floating roof report.* If an owner or operator installs an internal floating roof and, at initial startup, chooses to comply with 40 CFR part 65, subpart C, a report shall be furnished to the Administrator stating that the control equipment meets the specifications of 40 CFR 65.43. This report shall be an attachment to the notification required by 40 CFR 65.5(b).

(4) *External floating roof report.* If an owner or operator installs an external floating roof and, at initial startup, chooses to comply with 40 CFR part 65, subpart C, a report shall be furnished to the Administrator stating that the control equipment meets the specifications of 40 CFR 65.44. This report shall be an attachment to the notification required by 40 CFR 65.5(b).

[52 FR 11429, Apr. 8, 1987, as amended at 54 FR 32973, Aug. 11, 1989; 65 FR 78275, Dec. 14, 2000; 68 FR 59332, Oct. 15, 2003]

§ 60.111b Definitions.

Terms used in this subpart are defined in the Act, in subpart A of this part, or in this subpart as follows:

Bulk gasoline plant means any gasoline distribution facility that has a gasoline throughput less than or equal to 75,700 liters per day. Gasoline throughput shall be the maximum calculated design throughput as may be limited by compliance with an enforceable condition under Federal requirement or Federal, State or local law, and discoverable by the Administrator and any other person.

Condensate means hydrocarbon liquid separated from natural gas that condenses due to changes in the temperature or pressure, or both, and remains liquid at standard conditions.

Custody transfer means the transfer of produced petroleum and/or condensate, after processing and/or treatment in the producing operations, from storage vessels or automatic transfer facilities to pipelines or any other forms of transportation.

Fill means the introduction of VOL into a storage vessel but not necessarily to complete capacity.

Gasoline service station means any site where gasoline is dispensed to motor vehicle fuel tanks from stationary storage tanks.

Maximum true vapor pressure means the equilibrium partial pressure exerted by the volatile organic compounds (as defined in 40 CFR 51.100) in the stored VOL at the temperature equal to the highest calendar-month average of the VOL storage temperature for VOL's stored above or below the ambient

temperature or at the local maximum monthly average temperature as reported by the National Weather Service for VOL's stored at the ambient temperature, as determined:

(1) In accordance with methods described in American Petroleum Institute Bulletin 2517, Evaporation Loss From External Floating Roof Tanks, (incorporated by reference—see §60.17); or

(2) As obtained from standard reference texts; or

(3) As determined by ASTM D2879–83, 96, or 97 (incorporated by reference—see §60.17);

(4) Any other method approved by the Administrator.

Petroleum means the crude oil removed from the earth and the oils derived from tar sands, shale, and coal.

Petroleum liquids means petroleum, condensate, and any finished or intermediate products manufactured in a petroleum refinery.

Process tank means a tank that is used within a process (including a solvent or raw material recovery process) to collect material discharged from a feedstock storage vessel or equipment within the process before the material is transferred to other equipment within the process, to a product or by-product storage vessel, or to a vessel used to store recovered solvent or raw material. In many process tanks, unit operations such as reactions and blending are conducted. Other process tanks, such as surge control vessels and bottoms receivers, however, may not involve unit operations.

Reid vapor pressure means the absolute vapor pressure of volatile crude oil and volatile nonviscous petroleum liquids except liquified petroleum gases, as determined by ASTM D323–82 or 94 (incorporated by reference—see §60.17).

Storage vessel means each tank, reservoir, or container used for the storage of volatile organic liquids but does not include:

(1) Frames, housing, auxiliary supports, or other components that are not directly involved in the containment of liquids or vapors;

(2) Subsurface caverns or porous rock reservoirs; or

(3) Process tanks.

Volatile organic liquid (VOL) means any organic liquid which can emit volatile organic compounds (as defined in 40 CFR 51.100) into the atmosphere.

Waste means any liquid resulting from industrial, commercial, mining or agricultural operations, or from community activities that is discarded or is being accumulated, stored, or physically, chemically, or biologically treated prior to being discarded or recycled.

[52 FR 11429, Apr. 8, 1987, as amended at 54 FR 32973, Aug. 11, 1989; 65 FR 61756, Oct. 17, 2000; 68 FR 59333, Oct. 15, 2003]

§ 60.112b Standard for volatile organic compounds (VOC).

(a) The owner or operator of each storage vessel either with a design capacity greater than or equal to 151 m³ containing a VOL that, as stored, has a maximum true vapor pressure equal to or greater than 5.2 kPa but less than 76.6 kPa or with a design capacity greater than or equal to 75 m³ but less than 151 m³ containing a VOL that, as stored, has a maximum true vapor pressure equal to or greater than 27.6 kPa but less than 76.6 kPa, shall equip each storage vessel with one of the following:

(1) A fixed roof in combination with an internal floating roof meeting the following specifications:

(i) The internal floating roof shall rest or float on the liquid surface (but not necessarily in complete contact with it) inside a storage vessel that has a fixed roof. The internal floating roof shall be floating on the liquid surface at all times, except during initial fill and during those intervals when the storage vessel is completely emptied or subsequently emptied and refilled. When the roof is resting on the leg supports, the process of filling, emptying, or refilling shall be continuous and shall be accomplished as rapidly as possible.

(ii) Each internal floating roof shall be equipped with one of the following closure devices between the wall of the storage vessel and the edge of the internal floating roof:

(A) A foam- or liquid-filled seal mounted in contact with the liquid (liquid-mounted seal). A liquid-mounted seal means a foam- or liquid-filled seal mounted in contact with the liquid between the wall of the storage vessel and the floating roof continuously around the circumference of the tank.

(B) Two seals mounted one above the other so that each forms a continuous closure that completely covers the space between the wall of the storage vessel and the edge of the internal floating roof. The lower seal may be vapor-mounted, but both must be continuous.

(C) A mechanical shoe seal. A mechanical shoe seal is a metal sheet held vertically against the wall of the storage vessel by springs or weighted levers and is connected by braces to the floating roof. A flexible coated fabric (envelope) spans the annular space between the metal sheet and the floating roof.

(iii) Each opening in a noncontact internal floating roof except for automatic bleeder vents (vacuum breaker vents) and the rim space vents is to provide a projection below the liquid surface.

(iv) Each opening in the internal floating roof except for leg sleeves, automatic bleeder vents, rim space vents, column wells, ladder wells, sample wells, and stub drains is to be equipped with a cover or lid which is to be maintained in a closed position at all times (i.e., no visible gap) except when the device is in actual use. The cover or lid shall be equipped with a gasket. Covers on each access hatch and automatic gauge float well shall be bolted except when they are in use.

(v) Automatic bleeder vents shall be equipped with a gasket and are to be closed at all times when the roof is floating except when the roof is being floated off or is being landed on the roof leg supports.

(vi) Rim space vents shall be equipped with a gasket and are to be set to open only when the internal floating roof is not floating or at the manufacturer's recommended setting.

(vii) Each penetration of the internal floating roof for the purpose of sampling shall be a sample well. The sample well shall have a slit fabric cover that covers at least 90 percent of the opening.

(viii) Each penetration of the internal floating roof that allows for passage of a column supporting the fixed roof shall have a flexible fabric sleeve seal or a gasketed sliding cover.

(ix) Each penetration of the internal floating roof that allows for passage of a ladder shall have a gasketed sliding cover.

(2) An external floating roof. An external floating roof means a pontoon-type or double-deck type cover that rests on the liquid surface in a vessel with no fixed roof. Each external floating roof must meet the following specifications:

(i) Each external floating roof shall be equipped with a closure device between the wall of the storage vessel and the roof edge. The closure device is to consist of two seals, one above the other. The lower seal is referred to as the primary seal, and the upper seal is referred to as the secondary seal.

(A) The primary seal shall be either a mechanical shoe seal or a liquid-mounted seal. Except as provided in §60.113b(b)(4), the seal shall completely cover the annular space between the edge of the floating roof and tank wall.

(B) The secondary seal shall completely cover the annular space between the external floating roof and the wall of the storage vessel in a continuous fashion except as allowed in §60.113b(b)(4).

(ii) Except for automatic bleeder vents and rim space vents, each opening in a noncontact external floating roof shall provide a projection below the liquid surface. Except for automatic bleeder vents, rim space vents, roof drains, and leg sleeves, each opening in the roof is to be equipped with a gasketed cover, seal, or lid that is to be maintained in a closed position at all times (i.e., no visible gap) except when the device is in actual use. Automatic bleeder vents are to be closed at all times when the roof is floating except when the roof is being floated off or is being landed on the roof leg supports. Rim vents are to be set to open when the roof is being floated off the roof legs supports or at the manufacturer's recommended setting. Automatic bleeder vents and rim space vents are to be gasketed. Each emergency roof drain is to be provided with a slotted membrane fabric cover that covers at least 90 percent of the area of the opening.

(iii) The roof shall be floating on the liquid at all times (i.e., off the roof leg supports) except during initial fill until the roof is lifted off leg supports and when the tank is completely emptied and subsequently refilled. The process of filling, emptying, or refilling when the roof is resting on the leg supports shall be continuous and shall be accomplished as rapidly as possible.

(3) A closed vent system and control device meeting the following specifications:

(i) The closed vent system shall be designed to collect all VOC vapors and gases discharged from the storage vessel and operated with no detectable emissions as indicated by an instrument reading of less than 500 ppm above background and visual inspections, as determined in part 60, subpart VV, §60.485 (b).

(ii) The control device shall be designed and operated to reduce inlet VOC emissions by 95 percent or greater. If a flare is used as the control device, it shall meet the specifications described in the general control device requirements (§60.18) of the General Provisions.

(4) A system equivalent to those described in paragraphs (a)(1), (a)(2), or (a)(3) of this section as provided in §60.114b of this subpart.

(b) The owner or operator of each storage vessel with a design capacity greater than or equal to 75 m³ which contains a VOL that, as stored, has a maximum true vapor pressure greater than or equal to 76.6 kPa shall equip each storage vessel with one of the following:

(1) A closed vent system and control device as specified in §60.112b(a)(3).

(2) A system equivalent to that described in paragraph (b)(1) as provided in §60.114b of this subpart.

(c) *Site-specific standard for Merck & Co., Inc.'s Stonewall Plant in Elkton, Virginia.* This paragraph applies only to the pharmaceutical manufacturing facility, commonly referred to as the Stonewall Plant, located at Route 340 South, in Elkton, Virginia ("site").

(1) For any storage vessel that otherwise would be subject to the control technology requirements of paragraphs (a) or (b) of this section, the site shall have the option of either complying directly with the requirements of this subpart, or reducing the site-wide total criteria pollutant emissions cap (total emissions cap) in accordance with the procedures set forth in a permit issued pursuant to 40 CFR 52.2454. If the site chooses the option of reducing the total emissions cap in accordance with the procedures set forth in such permit, the requirements of such permit shall apply in lieu of the otherwise applicable requirements of this subpart for such storage vessel.

(2) For any storage vessel at the site not subject to the requirements of 40 CFR 60.112b (a) or (b), the requirements of 40 CFR 60.116b (b) and (c) and the General Provisions (subpart A of this part) shall not apply.

[52 FR 11429, Apr. 8, 1987, as amended at 62 FR 52641, Oct. 8, 1997]

§ 60.113b Testing and procedures.

The owner or operator of each storage vessel as specified in §60.112b(a) shall meet the requirements of paragraph (a), (b), or (c) of this section. The applicable paragraph for a particular storage vessel

depends on the control equipment installed to meet the requirements of §60.112b.

(a) After installing the control equipment required to meet §60.112b(a)(1) (permanently affixed roof and internal floating roof), each owner or operator shall:

(1) Visually inspect the internal floating roof, the primary seal, and the secondary seal (if one is in service), prior to filling the storage vessel with VOL. If there are holes, tears, or other openings in the primary seal, the secondary seal, or the seal fabric or defects in the internal floating roof, or both, the owner or operator shall repair the items before filling the storage vessel.

(2) For Vessels equipped with a liquid-mounted or mechanical shoe primary seal, visually inspect the internal floating roof and the primary seal or the secondary seal (if one is in service) through manholes and roof hatches on the fixed roof at least once every 12 months after initial fill. If the internal floating roof is not resting on the surface of the VOL inside the storage vessel, or there is liquid accumulated on the roof, or the seal is detached, or there are holes or tears in the seal fabric, the owner or operator shall repair the items or empty and remove the storage vessel from service within 45 days. If a failure that is detected during inspections required in this paragraph cannot be repaired within 45 days and if the vessel cannot be emptied within 45 days, a 30-day extension may be requested from the Administrator in the inspection report required in §60.115b(a)(3). Such a request for an extension must document that alternate storage capacity is unavailable and specify a schedule of actions the company will take that will assure that the control equipment will be repaired or the vessel will be emptied as soon as possible.

(3) For vessels equipped with a double-seal system as specified in §60.112b(a)(1)(ii)(B):

(i) Visually inspect the vessel as specified in paragraph (a)(4) of this section at least every 5 years; or

(ii) Visually inspect the vessel as specified in paragraph (a)(2) of this section.

(4) Visually inspect the internal floating roof, the primary seal, the secondary seal (if one is in service), gaskets, slotted membranes and sleeve seals (if any) each time the storage vessel is emptied and degassed. If the internal floating roof has defects, the primary seal has holes, tears, or other openings in the seal or the seal fabric, or the secondary seal has holes, tears, or other openings in the seal or the seal fabric, or the gaskets no longer close off the liquid surfaces from the atmosphere, or the slotted membrane has more than 10 percent open area, the owner or operator shall repair the items as necessary so that none of the conditions specified in this paragraph exist before refilling the storage vessel with VOL. In no event shall inspections conducted in accordance with this provision occur at intervals greater than 10 years in the case of vessels conducting the annual visual inspection as specified in paragraphs (a)(2) and (a)(3)(ii) of this section and at intervals no greater than 5 years in the case of vessels specified in paragraph (a)(3)(i) of this section.

(5) Notify the Administrator in writing at least 30 days prior to the filling or refilling of each storage vessel for which an inspection is required by paragraphs (a)(1) and (a)(4) of this section to afford the Administrator the opportunity to have an observer present. If the inspection required by paragraph (a)(4) of this section is not planned and the owner or operator could not have known about the inspection 30 days in advance or refilling the tank, the owner or operator shall notify the Administrator at least 7 days prior to the refilling of the storage vessel. Notification shall be made by telephone immediately followed by written documentation demonstrating why the inspection was unplanned. Alternatively, this notification including the written documentation may be made in writing and sent by express mail so that it is received by the Administrator at least 7 days prior to the refilling.

(b) After installing the control equipment required to meet §60.112b(a)(2) (external floating roof), the owner or operator shall:

(1) Determine the gap areas and maximum gap widths, between the primary seal and the wall of the storage vessel and between the secondary seal and the wall of the storage vessel according to the following frequency.

(i) Measurements of gaps between the tank wall and the primary seal (seal gaps) shall be performed during the hydrostatic testing of the vessel or within 60 days of the initial fill with VOL and at least once every 5 years thereafter.

(ii) Measurements of gaps between the tank wall and the secondary seal shall be performed within 60 days of the initial fill with VOL and at least once per year thereafter.

(iii) If any source ceases to store VOL for a period of 1 year or more, subsequent introduction of VOL into the vessel shall be considered an initial fill for the purposes of paragraphs (b)(1)(i) and (b)(1)(ii) of this section.

(2) Determine gap widths and areas in the primary and secondary seals individually by the following procedures:

(i) Measure seal gaps, if any, at one or more floating roof levels when the roof is floating off the roof leg supports.

(ii) Measure seal gaps around the entire circumference of the tank in each place where a 0.32-cm diameter uniform probe passes freely (without forcing or binding against seal) between the seal and the wall of the storage vessel and measure the circumferential distance of each such location.

(iii) The total surface area of each gap described in paragraph (b)(2)(ii) of this section shall be determined by using probes of various widths to measure accurately the actual distance from the tank wall to the seal and multiplying each such width by its respective circumferential distance.

(3) Add the gap surface area of each gap location for the primary seal and the secondary seal individually and divide the sum for each seal by the nominal diameter of the tank and compare each ratio to the respective standards in paragraph (b)(4) of this section.

(4) Make necessary repairs or empty the storage vessel within 45 days of identification in any inspection for seals not meeting the requirements listed in (b)(4) (i) and (ii) of this section:

(i) The accumulated area of gaps between the tank wall and the mechanical shoe or liquid-mounted primary seal shall not exceed 212 Cm² per meter of tank diameter, and the width of any portion of any gap shall not exceed 3.81 cm.

(A) One end of the mechanical shoe is to extend into the stored liquid, and the other end is to extend a minimum vertical distance of 61 cm above the stored liquid surface.

(B) There are to be no holes, tears, or other openings in the shoe, seal fabric, or seal envelope.

(ii) The secondary seal is to meet the following requirements:

(A) The secondary seal is to be installed above the primary seal so that it completely covers the space between the roof edge and the tank wall except as provided in paragraph (b)(2)(iii) of this section.

(B) The accumulated area of gaps between the tank wall and the secondary seal shall not exceed 21.2 cm² per meter of tank diameter, and the width of any portion of any gap shall not exceed 1.27 cm.

(C) There are to be no holes, tears, or other openings in the seal or seal fabric.

(iii) If a failure that is detected during inspections required in paragraph (b)(1) of §60.113b(b) cannot be repaired within 45 days and if the vessel cannot be emptied within 45 days, a 30-day extension may be requested from the Administrator in the inspection report required in §60.115b(b)(4). Such extension request must include a demonstration of unavailability of alternate storage capacity and a specification of a schedule that will assure that the control equipment will be repaired or the vessel will be emptied as soon as possible.

(5) Notify the Administrator 30 days in advance of any gap measurements required by paragraph (b)(1) of this section to afford the Administrator the opportunity to have an observer present.

(6) Visually inspect the external floating roof, the primary seal, secondary seal, and fittings each time the vessel is emptied and degassed.

(i) If the external floating roof has defects, the primary seal has holes, tears, or other openings in the seal or the seal fabric, or the secondary seal has holes, tears, or other openings in the seal or the seal fabric, the owner or operator shall repair the items as necessary so that none of the conditions specified in this paragraph exist before filling or refilling the storage vessel with VOL.

(ii) For all the inspections required by paragraph (b)(6) of this section, the owner or operator shall notify the Administrator in writing at least 30 days prior to the filling or refilling of each storage vessel to afford the Administrator the opportunity to inspect the storage vessel prior to refilling. If the inspection required by paragraph (b)(6) of this section is not planned and the owner or operator could not have known about the inspection 30 days in advance of refilling the tank, the owner or operator shall notify the Administrator at least 7 days prior to the refilling of the storage vessel. Notification shall be made by telephone immediately followed by written documentation demonstrating why the inspection was unplanned. Alternatively, this notification including the written documentation may be made in writing and sent by express mail so that it is received by the Administrator at least 7 days prior to the refilling.

(c) The owner or operator of each source that is equipped with a closed vent system and control device as required in §60.112b (a)(3) or (b)(2) (other than a flare) is exempt from §60.8 of the General Provisions and shall meet the following requirements.

(1) Submit for approval by the Administrator as an attachment to the notification required by §60.7(a)(1) or, if the facility is exempt from §60.7(a)(1), as an attachment to the notification required by §60.7(a)(2), an operating plan containing the information listed below.

(i) Documentation demonstrating that the control device will achieve the required control efficiency during maximum loading conditions. This documentation is to include a description of the gas stream which enters the control device, including flow and VOC content under varying liquid level conditions (dynamic and static) and manufacturer's design specifications for the control device. If the control device or the closed vent capture system receives vapors, gases, or liquids other than fuels from sources that are not designated sources under this subpart, the efficiency demonstration is to include consideration of all vapors, gases, and liquids received by the closed vent capture system and control device. If an enclosed combustion device with a minimum residence time of 0.75 seconds and a minimum temperature of 816 °C is used to meet the 95 percent requirement, documentation that those conditions will exist is sufficient to meet the requirements of this paragraph.

(ii) A description of the parameter or parameters to be monitored to ensure that the control device will be operated in conformance with its design and an explanation of the criteria used for selection of that parameter (or parameters).

(2) Operate the closed vent system and control device and monitor the parameters of the closed vent system and control device in accordance with the operating plan submitted to the Administrator in accordance with paragraph (c)(1) of this section, unless the plan was modified by the Administrator during the review process. In this case, the modified plan applies.

(d) The owner or operator of each source that is equipped with a closed vent system and a flare to meet the requirements in §60.112b (a)(3) or (b)(2) shall meet the requirements as specified in the general control device requirements, §60.18 (e) and (f).

[52 FR 11429, Apr. 8, 1987, as amended at 54 FR 32973, Aug. 11, 1989]

§ 60.114b Alternative means of emission limitation.

(a) If, in the Administrator's judgment, an alternative means of emission limitation will achieve a reduction in emissions at least equivalent to the reduction in emissions achieved by any requirement in §60.112b, the Administrator will publish in the Federal Register a notice permitting the use of the alternative means for purposes of compliance with that requirement.

(b) Any notice under paragraph (a) of this section will be published only after notice and an opportunity for a hearing.

(c) Any person seeking permission under this section shall submit to the Administrator a written application including:

(1) An actual emissions test that uses a full-sized or scale-model storage vessel that accurately collects and measures all VOC emissions from a given control device and that accurately simulates wind and accounts for other emission variables such as temperature and barometric pressure.

(2) An engineering evaluation that the Administrator determines is an accurate method of determining equivalence.

(d) The Administrator may condition the permission on requirements that may be necessary to ensure operation and maintenance to achieve the same emissions reduction as specified in §60.112b.

§ 60.115b Reporting and recordkeeping requirements.

The owner or operator of each storage vessel as specified in §60.112b(a) shall keep records and furnish reports as required by paragraphs (a), (b), or (c) of this section depending upon the control equipment installed to meet the requirements of §60.112b. The owner or operator shall keep copies of all reports and records required by this section, except for the record required by (c)(1), for at least 2 years. The record required by (c)(1) will be kept for the life of the control equipment.

(a) After installing control equipment in accordance with §60.112b(a)(1) (fixed roof and internal floating roof), the owner or operator shall meet the following requirements.

(1) Furnish the Administrator with a report that describes the control equipment and certifies that the control equipment meets the specifications of §60.112b(a)(1) and §60.113b(a)(1). This report shall be an attachment to the notification required by §60.7(a)(3).

(2) Keep a record of each inspection performed as required by §60.113b (a)(1), (a)(2), (a)(3), and (a)(4). Each record shall identify the storage vessel on which the inspection was performed and shall contain the date the vessel was inspected and the observed condition of each component of the control equipment (seals, internal floating roof, and fittings).

(3) If any of the conditions described in §60.113b(a)(2) are detected during the annual visual inspection required by §60.113b(a)(2), a report shall be furnished to the Administrator within 30 days of the inspection. Each report shall identify the storage vessel, the nature of the defects, and the date the storage vessel was emptied or the nature of and date the repair was made.

(4) After each inspection required by §60.113b(a)(3) that finds holes or tears in the seal or seal fabric, or defects in the internal floating roof, or other control equipment defects listed in §60.113b(a)(3)(ii), a report shall be furnished to the Administrator within 30 days of the inspection. The report shall identify the storage vessel and the reason it did not meet the specifications of §60.112b(a)(1) or §60.113b(a)(3) and list each repair made.

(b) After installing control equipment in accordance with §60.112b(a)(2) (external floating roof), the owner or operator shall meet the following requirements.

(1) Furnish the Administrator with a report that describes the control equipment and certifies that the control equipment meets the specifications of §60.112b(a)(2) and §60.113b(b)(2), (b)(3), and (b)(4). This report shall be an attachment to the notification required by §60.7(a)(3).

(2) Within 60 days of performing the seal gap measurements required by §60.113b(b)(1), furnish the Administrator with a report that contains:

(i) The date of measurement.

(ii) The raw data obtained in the measurement.

(iii) The calculations described in §60.113b (b)(2) and (b)(3).

(3) Keep a record of each gap measurement performed as required by §60.113b(b). Each record shall identify the storage vessel in which the measurement was performed and shall contain:

(i) The date of measurement.

(ii) The raw data obtained in the measurement.

(iii) The calculations described in §60.113b (b)(2) and (b)(3).

(4) After each seal gap measurement that detects gaps exceeding the limitations specified by §60.113b (b)(4), submit a report to the Administrator within 30 days of the inspection. The report will identify the vessel and contain the information specified in paragraph (b)(2) of this section and the date the vessel was emptied or the repairs made and date of repair.

(c) After installing control equipment in accordance with §60.112b (a)(3) or (b)(1) (closed vent system and control device other than a flare), the owner or operator shall keep the following records.

(1) A copy of the operating plan.

(2) A record of the measured values of the parameters monitored in accordance with §60.113b(c)(2).

(d) After installing a closed vent system and flare to comply with §60.112b, the owner or operator shall meet the following requirements.

(1) A report containing the measurements required by §60.18(f) (1), (2), (3), (4), (5), and (6) shall be furnished to the Administrator as required by §60.8 of the General Provisions. This report shall be submitted within 6 months of the initial start-up date.

(2) Records shall be kept of all periods of operation during which the flare pilot flame is absent.

(3) Semiannual reports of all periods recorded under §60.115b(d)(2) in which the pilot flame was absent shall be furnished to the Administrator.

§ 60.116b Monitoring of operations.

(a) The owner or operator shall keep copies of all records required by this section, except for the record required by paragraph (b) of this section, for at least 2 years. The record required by paragraph (b) of this section will be kept for the life of the source.

(b) The owner or operator of each storage vessel as specified in §60.110b(a) shall keep readily accessible records showing the dimension of the storage vessel and an analysis showing the capacity of the storage vessel.

(c) Except as provided in paragraphs (f) and (g) of this section, the owner or operator of each storage vessel either with a design capacity greater than or equal to 151 m³ storing a liquid with a maximum true vapor pressure greater than or equal to 3.5 kPa or with a design capacity greater than or equal to 75 m³ but less than 151 m³ storing a liquid with a maximum true vapor pressure greater than or equal to 15.0 kPa shall maintain a record of the VOL stored, the period of storage, and the maximum true vapor pressure of that VOL during the respective storage period.

(d) Except as provided in paragraph (g) of this section, the owner or operator of each storage vessel either with a design capacity greater than or equal to 151 m³ storing a liquid with a maximum true vapor pressure that is normally less than 5.2 kPa or with a design capacity greater than or equal to 75 m³ but less than 151 m³ storing a liquid with a maximum true vapor pressure that is normally less than 27.6 kPa shall notify the Administrator within 30 days when the maximum true vapor pressure of the liquid exceeds the respective maximum true vapor pressure values for each volume range.

(e) Available data on the storage temperature may be used to determine the maximum true vapor pressure as determined below.

(1) For vessels operated above or below ambient temperatures, the maximum true vapor pressure is

calculated based upon the highest expected calendar-month average of the storage temperature. For vessels operated at ambient temperatures, the maximum true vapor pressure is calculated based upon the maximum local monthly average ambient temperature as reported by the National Weather Service.

(2) For crude oil or refined petroleum products the vapor pressure may be obtained by the following:

(i) Available data on the Reid vapor pressure and the maximum expected storage temperature based on the highest expected calendar-month average temperature of the stored product may be used to determine the maximum true vapor pressure from nomographs contained in API Bulletin 2517 (incorporated by reference—see §60.17), unless the Administrator specifically requests that the liquid be sampled, the actual storage temperature determined, and the Reid vapor pressure determined from the sample(s).

(ii) The true vapor pressure of each type of crude oil with a Reid vapor pressure less than 13.8 kPa or with physical properties that preclude determination by the recommended method is to be determined from available data and recorded if the estimated maximum true vapor pressure is greater than 3.5 kPa.

(3) For other liquids, the vapor pressure:

(i) May be obtained from standard reference texts, or

(ii) Determined by ASTM D2879–83, 96, or 97 (incorporated by reference—see §60.17); or

(iii) Measured by an appropriate method approved by the Administrator; or

(iv) Calculated by an appropriate method approved by the Administrator.

(f) The owner or operator of each vessel storing a waste mixture of indeterminate or variable composition shall be subject to the following requirements.

(1) Prior to the initial filling of the vessel, the highest maximum true vapor pressure for the range of anticipated liquid compositions to be stored will be determined using the methods described in paragraph (e) of this section.

(2) For vessels in which the vapor pressure of the anticipated liquid composition is above the cutoff for monitoring but below the cutoff for controls as defined in §60.112b(a), an initial physical test of the vapor pressure is required; and a physical test at least once every 6 months thereafter is required as determined by the following methods:

(i) ASTM D2879–83, 96, or 97 (incorporated by reference—see §60.17); or

(ii) ASTM D323–82 or 94 (incorporated by reference—see §60.17); or

(iii) As measured by an appropriate method as approved by the Administrator.

(g) The owner or operator of each vessel equipped with a closed vent system and control device meeting the specification of §60.112b or with emissions reductions equipment as specified in 40 CFR 65.42(b)(4), (b)(5), (b)(6), or (c) is exempt from the requirements of paragraphs (c) and (d) of this section.

[52 FR 11429, Apr. 8, 1987, as amended at 65 FR 61756, Oct. 17, 2000; 65 FR 78276, Dec. 14, 2000; 68 FR 59333, Oct. 15, 2003]

§ 60.117b Delegation of authority.

(a) In delegating implementation and enforcement authority to a State under section 111(c) of the Act, the authorities contained in paragraph (b) of this section shall be retained by the Administrator and not transferred to a State.

(b) Authorities which will not be delegated to States: §§60.111b(f)(4), 60.114b, 60.116b(e)(3)(iii), 60.116b(e)(3)(iv), and 60.116b(f)(2)(iii).

[52 FR 11429, Apr. 8, 1987, as amended at 52 FR 22780, June 16, 1987]

[Browse Previous](#) | [Browse Next](#)

For questions or comments regarding e-CFR editorial content, features, or design, email ecfr@nara.gov.

For questions concerning e-CFR programming and delivery issues, email webteam@gpo.gov.

[Section 508 / Accessibility](#)

[Home Page](#) > [Executive Branch](#) > [Code of Federal Regulations](#) > [Electronic Code of Federal Regulations](#)

Electronic Code of Federal Regulations

e-CFR

TM

e-CFR Data is current as of August 1, 2007

Title 40: Protection of Environment

PART 60—STANDARDS OF PERFORMANCE FOR NEW STATIONARY SOURCES

[Browse Previous](#) | [Browse Next](#)

Subpart VV—Standards of Performance for Equipment Leaks of VOC in the Synthetic Organic Chemicals Manufacturing Industry

Source: 48 FR 48335, Oct. 18, 1983, unless otherwise noted.

§ 60.480 Applicability and designation of affected facility.

(a)(1) The provisions of this subpart apply to affected facilities in the synthetic organic chemicals manufacturing industry.

(2) The group of all equipment (defined in §60.481) within a process unit is an affected facility.

(b) Any affected facility under paragraph (a) of this section that commences construction or modification after January 5, 1981, shall be subject to the requirements of this subpart.

(c) Addition or replacement of equipment for the purpose of process improvement which is accomplished without a capital expenditure shall not by itself be considered a modification under this subpart.

(d)(1) If an owner or operator applies for one or more of the exemptions in this paragraph, then the owner or operator shall maintain records as required in §60.486(i).

(2) Any affected facility that has the design capacity to produce less than 1,000 Mg/yr (1,102 ton/yr) is exempt from §60.482.

(3) If an affected facility produces heavy liquid chemicals only from heavy liquid feed or raw materials, then it is exempt from §60.482.

(4) Any affected facility that produces beverage alcohol is exempt from §60.482.

(5) Any affected facility that has no equipment in VOC service is exempt from §60.482.

(e) *Alternative means of compliance* —(1) *Option to comply with part 65.* Owners or operators may choose to comply with the provisions of 40 CFR part 65, subpart F, to satisfy the requirements of §§60.482 through 60.487 for an affected facility. When choosing to comply with 40 CFR part 65, subpart F, the requirements of §60.485(d), (e), and (f), and §60.486(i) and (j) still apply. Other provisions applying to an owner or operator who chooses to comply with 40 CFR part 65 are provided in 40 CFR 65.1.

(2) *Part 60, subpart A.* Owners or operators who choose to comply with 40 CFR part 65, subpart F must

also comply with §§60.1, 60.2, 60.5, 60.6, 60.7(a)(1) and (4), 60.14, 60.15, and 60.16 for that equipment. All sections and paragraphs of subpart A of this part that are not mentioned in this paragraph (e)(2) do not apply to owners or operators of equipment subject to this subpart complying with 40 CFR part 65, subpart F, except that provisions required to be met prior to implementing 40 CFR part 65 still apply. Owners and operators who choose to comply with 40 CFR part 65, subpart F, must comply with 40 CFR part 65, subpart A.

[48 FR 48335, Oct. 18, 1983, as amended at 49 FR 22607, May 30, 1984; 65 FR 61762, Oct. 17, 2000; 65 FR 78276, Dec. 14, 2000]

§ 60.481 Definitions.

As used in this subpart, all terms not defined herein shall have the meaning given them in the Act or in subpart A of part 60, and the following terms shall have the specific meanings given them.

Capital expenditure means, in addition to the definition in 40 CFR 60.2, an expenditure for a physical or operational change to an existing facility that:

(a) Exceeds P, the product of the facility's replacement cost, R, and an adjusted annual asset guideline repair allowance, A, as reflected by the following equation: $P = R \times A$, where

(1) The adjusted annual asset guideline repair allowance, A, is the product of the percent of the replacement cost, Y, and the applicable basic annual asset guideline repair allowance, B, divided by 100 as reflected by the following equation:

$$A = Y \times (B \div 100);$$

(2) The percent Y is determined from the following equation: $Y = 1.0 - 0.575 \log X$, where X is 1982 minus the year of construction; and

(3) The applicable basic annual asset guideline repair allowance, B, is selected from the following table consistent with the applicable subpart:

Table for Determining Applicable for B

Subpart applicable to facility	Value of B to be used in equation
VV	12.5
DDD	12.5
GGG	7.0
KKK	4.5

Closed vent system means a system that is not open to the atmosphere and that is composed of hard-piping, ductwork, connections, and, if necessary, flow-inducing devices that transport gas or vapor from a piece or pieces of equipment to a control device or back to a process.

Connector means flanged, screwed, welded, or other joined fittings used to connect two pipe lines or a pipe line and a piece of process equipment.

Control device means an enclosed combustion device, vapor recovery system, or flare.

Distance piece means an open or enclosed casing through which the piston rod travels, separating the compressor cylinder from the crankcase.

Double block and bleed system means two block valves connected in series with a bleed valve or line that can vent the line between the two block valves.

Duct work means a conveyance system such as those commonly used for heating and ventilation systems. It is often made of sheet metal and often has sections connected by screws or crimping. Hard-piping is not ductwork.

Equipment means each pump, compressor, pressure relief device, sampling connection system, open-ended valve or line, valve, and flange or other connector in VOC service and any devices or systems required by this subpart.

First attempt at repair means to take rapid action for the purpose of stopping or reducing leakage of organic material to atmosphere using best practices.

Fuel gas means gases that are combusted to derive useful work or heat.

Fuel gas system means the offsite and onsite piping and flow and pressure control system that gathers gaseous stream(s) generated by onsite operations, may blend them with other sources of gas, and transports the gaseous stream for use as fuel gas in combustion devices or in-process combustion equipment, such as furnaces and gas turbines, either singly or in combination.

Hard-piping means pipe or tubing that is manufactured and properly installed using good engineering judgement and standards such as ASME B31.3, Process Piping (available from the American Society of Mechanical Engineers, PO Box 2900, Fairfield, NJ 07007–2900).

In gas/vapor service means that the piece of equipment contains process fluid that is in the gaseous state at operating conditions.

In heavy liquid service means that the piece of equipment is not in gas/vapor service or in light liquid service.

In light liquid service means that the piece of equipment contains a liquid that meets the conditions specified in §60.485(e).

In-situ sampling systems means nonextractive samplers or in-line samplers.

In vacuum service means that equipment is operating at an internal pressure which is at least 5 kilopascals (kPa)(0.7 psia) below ambient pressure.

In VOC service means that the piece of equipment contains or contacts a process fluid that is at least 10 percent VOC by weight. (The provisions of §60.485(d) specify how to determine that a piece of equipment is not in VOC service.)

Liquids dripping means any visible leakage from the seal including spraying, misting, clouding, and ice formation.

Open-ended valve or line means any valve, except safety relief valves, having one side of the valve seat in contact with process fluid and one side open to the atmosphere, either directly or through open piping.

Pressure release means the emission of materials resulting from system pressure being greater than set pressure of the pressure relief device.

Process improvement means routine changes made for safety and occupational health requirements, for energy savings, for better utility, for ease of maintenance and operation, for correction of design deficiencies, for bottleneck removal, for changing product requirements, or for environmental control.

Process unit means components assembled to produce, as intermediate or final products, one or more of the chemicals listed in §60.489 of this part. A process unit can operate independently if supplied with sufficient feed or raw materials and sufficient storage facilities for the product.

Process unit shutdown means a work practice or operational procedure that stops production from a process unit or part of a process unit. An unscheduled work practice or operational procedure that stops

production from a process unit or part of a process unit for less than 24 hours is not a process unit shutdown. The use of spare equipment and technically feasible bypassing of equipment without stopping production are not process unit shutdowns.

Quarter means a 3-month period; the first quarter concludes on the last day of the last full month during the 180 days following initial startup.

Repaired means that equipment is adjusted, or otherwise altered, in order to eliminate a leak as indicated by one of the following: an instrument reading of 10,000 ppm or greater, indication of liquids dripping, or indication by a sensor that a seal or barrier fluid system has failed.

Replacement cost means the capital needed to purchase all the depreciable components in a facility.

Sampling connection system means an assembly of equipment within a process unit used during periods of representative operation to take samples of the process fluid. Equipment used to take nonroutine grab samples is not considered a sampling connection system.

Sensor means a device that measures a physical quantity or the change in a physical quantity such as temperature, pressure, flow rate, pH, or liquid level.

Synthetic organic chemicals manufacturing industry means the industry that produces, as intermediates or final products, one or more of the chemicals listed in §60.489.

Volatile organic compounds or VOC means, for the purposes of this subpart, any reactive organic compounds as defined in §60.2 Definitions.

[48 FR 48335, Oct. 18, 1983, as amended at 49 FR 22607, May 30, 1984; 49 FR 26738, June 29, 1984; 60 FR 43258, Aug. 18, 1995; 65 FR 61762, Oct. 17, 2000; 65 FR 78276, Dec. 14, 2000]

§ 60.482-1 Standards: General.

(a) Each owner or operator subject to the provisions of this subpart shall demonstrate compliance with the requirements of §§60.482-1 through 60.482-10 or §60.480(e) for all equipment within 180 days of initial startup.

(b) Compliance with §§60.482-1 to 60.482-10 will be determined by review of records and reports, review of performance test results, and inspection using the methods and procedures specified in §60.485.

(c)(1) An owner or operator may request a determination of equivalence of a means of emission limitation to the requirements of §§60.482-2, 60.482-3, 60.482-5, 60.482-6, 60.482-7, 60.482-8, and 60.482-10 as provided in §60.484.

(2) If the Administrator makes a determination that a means of emission limitation is at least equivalent to the requirements of §§60.482-2, 60.482-3, 60.482-5, 60.482-6, 60.482-7, 60.482-8, or 60.482-10, an owner or operator shall comply with the requirements of that determination.

(d) Equipment that is in vacuum service is excluded from the requirements of §§60.482-2 to 60.482-10 if it is identified as required in §60.486(e)(5).

[48 FR 48335, Oct. 18, 1983, as amended at 49 FR 22608, May 30, 1984; 65 FR 78276, Dec. 14, 2000]

§ 60.482-2 Standards: Pumps in light liquid service.

(a)(1) Each pump in light liquid service shall be monitored monthly to detect leaks by the methods specified in §60.485(b), except as provided in §60.482-1(c) and paragraphs (d), (e), and (f) of this section.

(2) Each pump in light liquid service shall be checked by visual inspection each calendar week for

indications of liquids dripping from the pump seal.

(b)(1) If an instrument reading of 10,000 ppm or greater is measured, a leak is detected.

(2) If there are indications of liquids dripping from the pump seal, a leak is detected.

(c)(1) When a leak is detected, it shall be repaired as soon as practicable, but not later than 15 calendar days after it is detected, except as provided in §60.482–9.

(2) A first attempt at repair shall be made no later than 5 calendar days after each leak is detected.

(d) Each pump equipped with a dual mechanical seal system that includes a barrier fluid system is exempt from the requirements of paragraph (a), *Provided* the following requirements are met:

(1) Each dual mechanical seal system is—

(i) Operated with the barrier fluid at a pressure that is at all times greater than the pump stuffing box pressure; or

(ii) Equipment with a barrier fluid degassing reservoir that is routed to a process or fuel gas system or connected by a closed vent system to a control device that complies with the requirements of §60.482–10; or

(iii) Equipped with a system that purges the barrier fluid into a process stream with zero VOC emissions to the atmosphere.

(2) The barrier fluid system is in heavy liquid service or is not in VOC service.

(3) Each barrier fluid system is equipped with a sensor that will detect failure of the seal system, the barrier fluid system, or both.

(4) Each pump is checked by visual inspection, each calendar week, for indications of liquids dripping from the pump seals.

(5)(i) Each sensor as described in paragraph (d)(3) is checked daily or is equipped with an audible alarm, and

(ii) The owner or operator determines, based on design considerations and operating experience, a criterion that indicates failure of the seal system, the barrier fluid system, or both.

(6)(i) If there are indications of liquids dripping from the pump seal or the sensor indicates failure of the seal system, the barrier fluid system, or both based on the criterion determined in paragraph (d)(5)(ii), a leak is detected.

(ii) When a leak is detected, it shall be repaired as soon as practicable, but not later than 15 calendar days after it is detected, except as provided in §60.482–9.

(iii) A first attempt at repair shall be made no later than 5 calendar days after each leak is detected.

(e) Any pump that is designated, as described in §60.486(e)(1) and (2), for no detectable emission, as indicated by an instrument reading of less than 500 ppm above background, is exempt from the requirements of paragraphs (a), (c), and (d) of this section if the pump:

(1) Has no externally actuated shaft penetrating the pump housing,

(2) Is demonstrated to be operating with no detectable emissions as indicated by an instrument reading of less than 500 ppm above background as measured by the methods specified in §60.485(c), and

(3) Is tested for compliance with paragraph (e)(2) of this section initially upon designation, annually, and at other times requested by the Administrator.

(f) If any pump is equipped with a closed vent system capable of capturing and transporting any leakage from the seal or seals to a process or to a fuel gas system or to a control device that complies with the requirements of §60.482-10, it is exempt from paragraphs (a) through (e) of this section.

(g) Any pump that is designated, as described in §60.486(f)(1), as an unsafe-to-monitor pump is exempt from the monitoring and inspection requirements of paragraphs (a) and (d)(4) through (6) of this section if:

(1) The owner or operator of the pump demonstrates that the pump is unsafe-to-monitor because monitoring personnel would be exposed to an immediate danger as a consequence of complying with paragraph (a) of this section; and

(2) The owner or operator of the pump has a written plan that requires monitoring of the pump as frequently as practicable during safe-to-monitor times but not more frequently than the periodic monitoring schedule otherwise applicable, and repair of the equipment according to the procedures in paragraph (c) of this section if a leak is detected.

(h) Any pump that is located within the boundary of an unmanned plant site is exempt from the weekly visual inspection requirement of paragraphs (a)(2) and (d)(4) of this section, and the daily requirements of paragraph (d)(5) of this section, provided that each pump is visually inspected as often as practicable and at least monthly.

[48 FR 48335, Oct. 18, 1983, as amended at 65 FR 61762, Oct. 17, 2000; 65 FR 78276, Dec. 14, 2000]

§ 60.482-3 Standards: Compressors.

(a) Each compressor shall be equipped with a seal system that includes a barrier fluid system and that prevents leakage of VOC to the atmosphere, except as provided in §60.482-1(c) and paragraph (h) and (i) of this section.

(b) Each compressor seal system as required in paragraph (a) shall be:

(1) Operated with the barrier fluid at a pressure that is greater than the compressor stuffing box pressure; or

(2) Equipped with a barrier fluid system degassing reservoir that is routed to a process or fuel gas system or connected by a closed vent system to a control device that complies with the requirements of §60.482-10; or

(3) Equipped with a system that purges the barrier fluid into a process stream with zero VOC emissions to the atmosphere.

(c) The barrier fluid system shall be in heavy liquid service or shall not be in VOC service.

(d) Each barrier fluid system as described in paragraph (a) shall be equipped with a sensor that will detect failure of the seal system, barrier fluid system, or both.

(e)(1) Each sensor as required in paragraph (d) shall be checked daily or shall be equipped with an audible alarm.

(2) The owner or operator shall determine, based on design considerations and operating experience, a criterion that indicates failure of the seal system, the barrier fluid system, or both.

(f) If the sensor indicates failure of the seal system, the barrier system, or both based on the criterion determined under paragraph (e)(2), a leak is detected.

(a) Each sampling connection system shall be equipped with a closed-purged, closed-loop, or closed-vent system, except as provided in §60.482-1(c). Gases displaced during filling of the sample container are not required to be collected or captured.

(b) Each closed-purge, closed-loop, or closed-vent system as required in paragraph (a) of this section shall comply with the requirements specified in paragraphs (b)(1) through (4) of this section:

(1) Return the purged process fluid directly to the process line; or

(2) Collect and recycle the purged process fluid to a process; or

(3) Be designed and operated to capture and transport all the purged process fluid to a control device that complies with the requirements of §60.482-10; or

(4) Collect, store, and transport the purged process fluid to any of the following systems or facilities:

(i) A waste management unit as defined in 40 CFR 63.111, if the waste management unit is subject to, and operated in compliance with the provisions of 40 CFR part 63, subpart G, applicable to Group 1 wastewater streams;

(ii) A treatment, storage, or disposal facility subject to regulation under 40 CFR part 262, 264, 265, or 266; or

(iii) A facility permitted, licensed, or registered by a State to manage municipal or industrial solid waste, if the process fluids are not hazardous waste as defined in 40 CFR part 261.

(c) In situ sampling systems and sampling systems without purges are exempt from the requirements of paragraphs (a) and (b) of this section.

[60 FR 43258, Aug. 18, 1995, as amended at 65 FR 61762, Oct. 17, 2000; 65 FR 78277, Dec. 14, 2000]

§ 60.482-6 Standards: Open-ended valves or lines.

(a)(1) Each open-ended valve or line shall be equipped with a cap, blind flange, plug, or a second valve, except as provided in §60.482-1(c).

(2) The cap, blind flange, plug, or second valve shall seal the open end at all times except during operations requiring process fluid flow through the open-ended valve or line.

(b) Each open-ended valve or line equipped with a second valve shall be operated in a manner such that the valve on the process fluid end is closed before the second valve is closed.

(c) When a double block-and-bleed system is being used, the bleed valve or line may remain open during operations that require venting the line between the block valves but shall comply with paragraph (a) at all other times.

(d) Open-ended valves or lines in an emergency shutdown system which are designed to open automatically in the event of a process upset are exempt from the requirements of paragraphs (a), (b) and (c) of this section.

(e) Open-ended valves or lines containing materials which would autocatalytically polymerize or would present an explosion, serious overpressure, or other safety hazard if capped or equipped with a double block and bleed system as specified in paragraphs (a) through (c) of this section are exempt from the requirements of paragraphs (a) through (c) of this section.

[48 FR 48335, Oct. 18, 1983, as amended at 49 FR 22607, May 30, 1984; 65 FR 78277, Dec. 14, 2000]

§ 60.482-7 Standards: Valves in gas/vapor service and in light liquid service.

(a) Each valve shall be monitored monthly to detect leaks by the methods specified in §60.485(b) and shall comply with paragraphs (b) through (e), except as provided in paragraphs (f), (g), and (h), §60.483–1, 2, and §60.482–1(c).

(b) If an instrument reading of 10,000 ppm or greater is measured, a leak is detected.

(c)(1) Any valve for which a leak is not detected for 2 successive months may be monitored the first month of every quarter, beginning with the next quarter, until a leak is detected.

(2) If a leak is detected, the valve shall be monitored monthly until a leak is not detected for 2 successive months.

(d)(1) When a leak is detected, it shall be repaired as soon as practicable, but no later than 15 calendar days after the leak is detected, except as provided in §60.482–9.

(2) A first attempt at repair shall be made no later than 5 calendar days after each leak is detected.

(e) First attempts at repair include, but are not limited to, the following best practices where practicable:

(1) Tightening of bonnet bolts;

(2) Replacement of bonnet bolts;

(3) Tightening of packing gland nuts;

(4) Injection of lubricant into lubricated packing.

(f) Any valve that is designated, as described in §60.486(e)(2), for no detectable emissions, as indicated by an instrument reading of less than 500 ppm above background, is exempt from the requirements of paragraph (a) if the valve:

(1) Has no external actuating mechanism in contact with the process fluid,

(2) Is operated with emissions less than 500 ppm above background as determined by the method specified in §60.485(c), and

(3) Is tested for compliance with paragraph (f)(2) of this section initially upon designation, annually, and at other times requested by the Administrator.

(g) Any valve that is designated, as described in §60.486(f)(1), as an unsafe-to-monitor valve is exempt from the requirements of paragraph (a) if:

(1) The owner or operator of the valve demonstrates that the valve is unsafe to monitor because monitoring personnel would be exposed to an immediate danger as a consequence of complying with paragraph (a), and

(2) The owner or operator of the valve adheres to a written plan that requires monitoring of the valve as frequently as practicable during safe-to-monitor times.

(h) Any valve that is designated, as described in §60.486(f)(2), as a difficult-to-monitor valve is exempt from the requirements of paragraph (a) if:

(1) The owner or operator of the valve demonstrates that the valve cannot be monitored without elevating the monitoring personnel more than 2 meters above a support surface.

(2) The process unit within which the valve is located either becomes an affected facility through §60.14 or §60.15 or the owner or operator designates less than 3.0 percent of the total number of valves as difficult-to-monitor, and

(3) The owner or operator of the valve follows a written plan that requires monitoring of the valve at least once per calendar year.

[48 FR 48335, Oct. 18, 1983, as amended at 49 FR 22608, May 30, 1984; 65 FR 61762, Oct. 17, 2000]

§ 60.482-8 Standards: Pumps and valves in heavy liquid service, pressure relief devices in light liquid or heavy liquid service, and connectors.

(a) If evidence of a potential leak is found by visual, audible, olfactory, or any other detection method at pumps and valves in heavy liquid service, pressure relief devices in light liquid or heavy liquid service, and connectors, the owner or operator shall follow either one of the following procedures:

(1) The owner or operator shall monitor the equipment within 5 days by the method specified in §60.485 (b) and shall comply with the requirements of paragraphs (b) through (d) of this section.

(2) The owner or operator shall eliminate the visual, audible, olfactory, or other indication of a potential leak.

(b) If an instrument reading of 10,000 ppm or greater is measured, a leak is detected.

(c)(1) When a leak is detected, it shall be repaired as soon as practicable, but not later than 15 calendar days after it is detected, except as provided in §60.482-9.

(2) The first attempt at repair shall be made no later than 5 calendar days after each leak is detected.

(d) First attempts at repair include, but are not limited to, the best practices described under §60.482-7 (e).

[48 CFR 48335, Oct. 18, 1983, as amended at 65 FR 78277, Dec. 14, 2000]

§ 60.482-9 Standards: Delay of repair.

(a) Delay of repair of equipment for which leaks have been detected will be allowed if repair within 15 days is technically infeasible without a process unit shutdown. Repair of this equipment shall occur before the end of the next process unit shutdown.

(b) Delay of repair of equipment will be allowed for equipment which is isolated from the process and which does not remain in VOC service.

(c) Delay of repair for valves will be allowed if:

(1) The owner or operator demonstrates that emissions of purged material resulting from immediate repair are greater than the fugitive emissions likely to result from delay of repair, and

(2) When repair procedures are effected, the purged material is collected and destroyed or recovered in a control device complying with §60.482-10.

(d) Delay of repair for pumps will be allowed if:

(1) Repair requires the use of a dual mechanical seal system that includes a barrier fluid system, and

(2) Repair is completed as soon as practicable, but not later than 6 months after the leak was detected.

(e) Delay of repair beyond a process unit shutdown will be allowed for a valve, if valve assembly replacement is necessary during the process unit shutdown, valve assembly supplies have been depleted, and valve assembly supplies had been sufficiently stocked before the supplies were depleted. Delay of repair beyond the next process unit shutdown will not be allowed unless the next process unit shutdown occurs sooner than 6 months after the first process unit shutdown.

[48 FR 48335, Oct. 18, 1983, as amended at 65 FR 78277, Dec. 14, 2000]

§ 60.482-10 Standards: Closed vent systems and control devices.

- (a) Owners or operators of closed vent systems and control devices used to comply with provisions of this subpart shall comply with the provisions of this section.
- (b) Vapor recovery systems (for example, condensers and absorbers) shall be designed and operated to recover the VOC emissions vented to them with an efficiency of 95 percent or greater, or to an exit concentration of 20 parts per million by volume, whichever is less stringent.
- (c) Enclosed combustion devices shall be designed and operated to reduce the VOC emissions vented to them with an efficiency of 95 percent or greater, or to an exit concentration of 20 parts per million by volume, on a dry basis, corrected to 3 percent oxygen, whichever is less stringent or to provide a minimum residence time of 0.75 seconds at a minimum temperature of 816 °C.
- (d) Flares used to comply with this subpart shall comply with the requirements of §60.18.
- (e) Owners or operators of control devices used to comply with the provisions of this subpart shall monitor these control devices to ensure that they are operated and maintained in conformance with their designs.
- (f) Except as provided in paragraphs (i) through (k) of this section, each closed vent system shall be inspected according to the procedures and schedule specified in paragraphs (f)(1) and (f)(2) of this section.
- (1) If the vapor collection system or closed vent system is constructed of hard-piping, the owner or operator shall comply with the requirements specified in paragraphs (f)(1)(i) and (f)(1)(ii) of this section:
- (i) Conduct an initial inspection according to the procedures in §60.485(b); and
 - (ii) Conduct annual visual inspections for visible, audible, or olfactory indications of leaks.
- (2) If the vapor collection system or closed vent system is constructed of ductwork, the owner or operator shall:
- (i) Conduct an initial inspection according to the procedures in §60.485(b); and
 - (ii) Conduct annual inspections according to the procedures in §60.485(b).
- (g) Leaks, as indicated by an instrument reading greater than 500 parts per million by volume above background or by visual inspections, shall be repaired as soon as practicable except as provided in paragraph (h) of this section.
- (1) A first attempt at repair shall be made no later than 5 calendar days after the leak is detected.
- (2) Repair shall be completed no later than 15 calendar days after the leak is detected.
- (h) Delay of repair of a closed vent system for which leaks have been detected is allowed if the repair is technically infeasible without a process unit shutdown or if the owner or operator determines that emissions resulting from immediate repair would be greater than the fugitive emissions likely to result from delay of repair. Repair of such equipment shall be complete by the end of the next process unit shutdown.
- (i) If a vapor collection system or closed vent system is operated under a vacuum, it is exempt from the inspection requirements of paragraphs (f)(1)(i) and (f)(2) of this section.
- (j) Any parts of the closed vent system that are designated, as described in paragraph (l)(1) of this

section, as unsafe to inspect are exempt from the inspection requirements of paragraphs (f)(1)(i) and (f)(2) of this section if they comply with the requirements specified in paragraphs (j)(1) and (j)(2) of this section:

(1) The owner or operator determines that the equipment is unsafe to inspect because inspecting personnel would be exposed to an imminent or potential danger as a consequence of complying with paragraphs (f)(1)(i) or (f)(2) of this section; and

(2) The owner or operator has a written plan that requires inspection of the equipment as frequently as practicable during safe-to-inspect times.

(k) Any parts of the closed vent system that are designated, as described in paragraph (l)(2) of this section, as difficult to inspect are exempt from the inspection requirements of paragraphs (f)(1)(i) and (f)(2) of this section if they comply with the requirements specified in paragraphs (k)(1) through (k)(3) of this section:

(1) The owner or operator determines that the equipment cannot be inspected without elevating the inspecting personnel more than 2 meters above a support surface; and

(2) The process unit within which the closed vent system is located becomes an affected facility through §§60.14 or 60.15, or the owner or operator designates less than 3.0 percent of the total number of closed vent system equipment as difficult to inspect; and

(3) The owner or operator has a written plan that requires inspection of the equipment at least once every 5 years. A closed vent system is exempt from inspection if it is operated under a vacuum.

(l) The owner or operator shall record the information specified in paragraphs (l)(1) through (l)(5) of this section.

(1) Identification of all parts of the closed vent system that are designated as unsafe to inspect, an explanation of why the equipment is unsafe to inspect, and the plan for inspecting the equipment.

(2) Identification of all parts of the closed vent system that are designated as difficult to inspect, an explanation of why the equipment is difficult to inspect, and the plan for inspecting the equipment.

(3) For each inspection during which a leak is detected, a record of the information specified in §60.486 (c).

(4) For each inspection conducted in accordance with §60.485(b) during which no leaks are detected, a record that the inspection was performed, the date of the inspection, and a statement that no leaks were detected.

(5) For each visual inspection conducted in accordance with paragraph (f)(1)(ii) of this section during which no leaks are detected, a record that the inspection was performed, the date of the inspection, and a statement that no leaks were detected.

(m) Closed vent systems and control devices used to comply with provisions of this subpart shall be operated at all times when emissions may be vented to them.

[48 FR 48335, Oct. 18, 1983, as amended at 51 FR 2702, Jan. 21, 1986; 60 FR 43258, Aug. 18, 1995; 61 FR 29878, June 12, 1996; 65 FR 78277, Dec. 14, 2000]

§ 60.483-1 Alternative standards for valves—allowable percentage of valves leaking.

(a) An owner or operator may elect to comply with an allowable percentage of valves leaking of equal to or less than 2.0 percent.

(b) The following requirements shall be met if an owner or operator wishes to comply with an allowable percentage of valves leaking:

(1) An owner or operator must notify the Administrator that the owner or operator has elected to comply with the allowable percentage of valves leaking before implementing this alternative standard, as specified in §60.487(d).

(2) A performance test as specified in paragraph (c) of this section shall be conducted initially upon designation, annually, and at other times requested by the Administrator.

(3) If a valve leak is detected, it shall be repaired in accordance with §60.482–7(d) and (e).

(c) Performance tests shall be conducted in the following manner:

(1) All valves in gas/vapor and light liquid service within the affected facility shall be monitored within 1 week by the methods specified in §60.485(b).

(2) If an instrument reading of 10,000 ppm or greater is measured, a leak is detected.

(3) The leak percentage shall be determined by dividing the number of valves for which leaks are detected by the number of valves in gas/vapor and light liquid service within the affected facility.

(d) Owners and operators who elect to comply with this alternative standard shall not have an affected facility with a leak percentage greater than 2.0 percent.

[48 FR 48335, Oct. 18, 1983, as amended at 65 FR 61762, Oct. 17, 2000; 65 FR 78278, Dec. 14, 2000]

§ 60.483-2 Alternative standards for valves—skip period leak detection and repair.

(a)(1) An owner or operator may elect to comply with one of the alternative work practices specified in paragraphs (b)(2) and (3) of this section.

(2) An owner or operator must notify the Administrator before implementing one of the alternative work practices, as specified in §60.487(d).

(b)(1) An owner or operator shall comply initially with the requirements for valves in gas/vapor service and valves in light liquid service, as described in §60.482–7.

(2) After 2 consecutive quarterly leak detection periods with the percent of valves leaking equal to or less than 2.0, an owner or operator may begin to skip 1 of the quarterly leak detection periods for the valves in gas/vapor and light liquid service.

(3) After 5 consecutive quarterly leak detection periods with the percent of valves leaking equal to or less than 2.0, an owner or operator may begin to skip 3 of the quarterly leak detection periods for the valves in gas/vapor and light liquid service.

(4) If the percent of valves leaking is greater than 2.0, the owner or operator shall comply with the requirements as described in §60.482–7 but can again elect to use this section.

(5) The percent of valves leaking shall be determined by dividing the sum of valves found leaking during current monitoring and valves for which repair has been delayed by the total number of valves subject to the requirements of this section.

(6) An owner or operator must keep a record of the percent of valves found leaking during each leak detection period.

[48 FR 48335, Oct. 18, 1983, as amended at 65 FR 61762, Oct. 17, 2000; 65 FR 78278, Dec. 14, 2000]

§ 60.484 Equivalence of means of emission limitation.

(a) Each owner or operator subject to the provisions of this subpart may apply to the Administrator for

determination of equivalence for any means of emission limitation that achieves a reduction in emissions of VOC at least equivalent to the reduction in emissions of VOC achieved by the controls required in this subpart.

(b) Determination of equivalence to the equipment, design, and operational requirements of this subpart will be evaluated by the following guidelines:

(1) Each owner or operator applying for an equivalence determination shall be responsible for collecting and verifying test data to demonstrate equivalence of means of emission limitation.

(2) The Administrator will compare test data for the means of emission limitation to test data for the equipment, design, and operational requirements.

(3) The Administrator may condition the approval of equivalence on requirements that may be necessary to assure operation and maintenance to achieve the same emission reduction as the equipment, design, and operational requirements.

(c) Determination of equivalence to the required work practices in this subpart will be evaluated by the following guidelines:

(1) Each owner or operator applying for a determination of equivalence shall be responsible for collecting and verifying test data to demonstrate equivalence of an equivalent means of emission limitation.

(2) For each affected facility for which a determination of equivalence is requested, the emission reduction achieved by the required work practice shall be demonstrated.

(3) For each affected facility, for which a determination of equivalence is requested, the emission reduction achieved by the equivalent means of emission limitation shall be demonstrated.

(4) Each owner or operator applying for a determination of equivalence shall commit in writing to work practice(s) that provide for emission reductions equal to or greater than the emission reductions achieved by the required work practice.

(5) The Administrator will compare the demonstrated emission reduction for the equivalent means of emission limitation to the demonstrated emission reduction for the required work practices and will consider the commitment in paragraph (c)(4).

(6) The Administrator may condition the approval of equivalence on requirements that may be necessary to assure operation and maintenance to achieve the same emission reduction as the required work practice.

(d) An owner or operator may offer a unique approach to demonstrate the equivalence of any equivalent means of emission limitation.

(e)(1) After a request for determination of equivalence is received, the Administrator will publish a notice in the Federal Register and provide the opportunity for public hearing if the Administrator judges that the request may be approved.

(2) After notice and opportunity for public hearing, the Administrator will determine the equivalence of a means of emission limitation and will publish the determination in the Federal Register.

(3) Any equivalent means of emission limitations approved under this section shall constitute a required work practice, equipment, design, or operational standard within the meaning of section 111(h)(1) of the Clean Air Act.

(f)(1) Manufacturers of equipment used to control equipment leaks of VOC may apply to the Administrator for determination of equivalence for any equivalent means of emission limitation that achieves a reduction in emissions of VOC achieved by the equipment, design, and operational requirements of this subpart.

(2) The Administrator will make an equivalence determination according to the provisions of paragraphs (b), (c), (d), and (e) of this section.

[48 FR 48335, Oct. 18, 1983, as amended at 65 FR 61762, Oct. 17, 2000]

§ 60.485 Test methods and procedures.

(a) In conducting the performance tests required in §60.8, the owner or operator shall use as reference methods and procedures the test methods in appendix A of this part or other methods and procedures as specified in this section, except as provided in §60.8(b).

(b) The owner or operator shall determine compliance with the standards in §§60.482, 60.483, and 60.484 as follows:

(1) Method 21 shall be used to determine the presence of leaking sources. The instrument shall be calibrated before use each day of its use by the procedures specified in Method 21. The following calibration gases shall be used:

(i) Zero air (less than 10 ppm of hydrocarbon in air); and

(ii) A mixture of methane or n-hexane and air at a concentration of about, but less than, 10,000 ppm methane or n-hexane.

(c) The owner or operator shall determine compliance with the no detectable emission standards in §§60.482–2(e), 60.482–3(i), 60.482–4, 60.482–7(f), and 60.482–10(e) as follows:

(1) The requirements of paragraph (b) shall apply.

(2) Method 21 shall be used to determine the background level. All potential leak interfaces shall be traversed as close to the interface as possible. The arithmetic difference between the maximum concentration indicated by the instrument and the background level is compared with 500 ppm for determining compliance.

(d) The owner or operator shall test each piece of equipment unless he demonstrates that a process unit is not in VOC service, i.e., that the VOC content would never be reasonably expected to exceed 10 percent by weight. For purposes of this demonstration, the following methods and procedures shall be used:

(1) Procedures that conform to the general methods in ASTM E260–73, 91, or 96, E168–67, 77, or 92, E169–63, 77, or 93 (incorporated by reference—see §60.17) shall be used to determine the percent VOC content in the process fluid that is contained in or contacts a piece of equipment.

(2) Organic compounds that are considered by the Administrator to have negligible photochemical reactivity may be excluded from the total quantity of organic compounds in determining the VOC content of the process fluid.

(3) Engineering judgment may be used to estimate the VOC content, if a piece of equipment had not been shown previously to be in service. If the Administrator disagrees with the judgment, paragraphs (d) (1) and (2) of this section shall be used to resolve the disagreement.

(e) The owner or operator shall demonstrate that an equipment is in light liquid service by showing that all the following conditions apply:

(1) The vapor pressure of one or more of the components is greater than 0.3 kPa at 20 °C (1.2 in. H₂O at 68 °F). Standard reference texts or ASTM D2879–83, 96, or 97 (incorporated by reference—see §60.17) shall be used to determine the vapor pressures.

(2) The total concentration of the pure components having a vapor pressure greater than 0.3 kPa at 20 °C (1.2 in. H₂O at 68 °F) is equal to or greater than 20 percent by weight.

(3) The fluid is a liquid at operating conditions.

(f) Samples used in conjunction with paragraphs (d), (e), and (g) of this section shall be representative of the process fluid that is contained in or contacts the equipment or the gas being combusted in the flare.

(g) The owner or operator shall determine compliance with the standards of flares as follows:

(1) Method 22 shall be used to determine visible emissions.

(2) A thermocouple or any other equivalent device shall be used to monitor the presence of a pilot flame in the flare.

(3) The maximum permitted velocity for air assisted flares shall be computed using the following equation:

$$V_{\max} = K_1 + K_2 H_T$$

Where:

V_{\max} = Maximum permitted velocity, m/sec (ft/sec)

H_T = Net heating value of the gas being combusted, MJ/scm (Btu/scf).

K_1 = 8.706 m/sec (metric units)

= 28.56 ft/sec (English units)

K_2 = 0.7084 m⁴/(MJ-sec) (metric units)

= 0.087 ft⁴/(Btu-sec) (English units)

(4) The net heating value (HT) of the gas being combusted in a flare shall be computed using the following equation:

$$H_T = K \sum_{i=1}^n C_i H_i$$

Where:

K = Conversion constant, 1.740 × 10⁷ (g-mole)(MJ)/ (ppm-scm-kcal) (metric units)

= 4.674 × 10⁸ [(g-mole)(Btu)/(ppm-scf-kcal)] (English units)

C_i = Concentration of sample component "i," ppm

H_i = net heat of combustion of sample component "i" at 25 °C and 760 mm Hg (77 °F and 14.7 psi), kcal/g-mole

(5) Method 18 and ASTM D2504-67, 77, or 88 (Reapproved 1993) (incorporated by reference—see §60.17) shall be used to determine the concentration of sample component "i."

(6) ASTM D2382–76 or 88 or D4809–95 (incorporated by reference—see §60.17) shall be used to determine the net heat of combustion of component “i” if published values are not available or cannot be calculated.

(7) Method 2, 2A, 2C, or 2D, as appropriate, shall be used to determine the actual exit velocity of a flare. If needed, the unobstructed (free) cross-sectional area of the flare tip shall be used.

[54 FR 6678, Feb. 14, 1989, as amended at 54 FR 27016, June 27, 1989; 65 FR 61763, Oct. 17, 2000]

§ 60.486 Recordkeeping requirements.

(a)(1) Each owner or operator subject to the provisions of this subpart shall comply with the recordkeeping requirements of this section.

(2) An owner or operator of more than one affected facility subject to the provisions of this subpart may comply with the recordkeeping requirements for these facilities in one recordkeeping system if the system identifies each record by each facility.

(b) When each leak is detected as specified in §§60.482–2, 60.482–3, 60.482–7, 60.482–8, and 60.483–2, the following requirements apply:

(1) A weatherproof and readily visible identification, marked with the equipment identification number, shall be attached to the leaking equipment.

(2) The identification on a valve may be removed after it has been monitored for 2 successive months as specified in §60.482–7(c) and no leak has been detected during those 2 months.

(3) The identification on equipment except on a valve, may be removed after it has been repaired.

(c) When each leak is detected as specified in §§60.482–2, 60.482–3, 60.482–7, 60.482–8, and 60.483–2, the following information shall be recorded in a log and shall be kept for 2 years in a readily accessible location:

(1) The instrument and operator identification numbers and the equipment identification number.

(2) The date the leak was detected and the dates of each attempt to repair the leak.

(3) Repair methods applied in each attempt to repair the leak.

(4) “Above 10,000” if the maximum instrument reading measured by the methods specified in §60.485(a) after each repair attempt is equal to or greater than 10,000 ppm.

(5) “Repair delayed” and the reason for the delay if a leak is not repaired within 15 calendar days after discovery of the leak.

(6) The signature of the owner or operator (or designate) whose decision it was that repair could not be effected without a process shutdown.

(7) The expected date of successful repair of the leak if a leak is not repaired within 15 days.

(8) Dates of process unit shutdowns that occur while the equipment is unrepaired.

(9) The date of successful repair of the leak.

(d) The following information pertaining to the design requirements for closed vent systems and control devices described in §60.482–10 shall be recorded and kept in a readily accessible location:

(1) Detailed schematics, design specifications, and piping and instrumentation diagrams.

(2) The dates and descriptions of any changes in the design specifications.

(3) A description of the parameter or parameters monitored, as required in §60.482-10(e), to ensure that control devices are operated and maintained in conformance with their design and an explanation of why that parameter (or parameters) was selected for the monitoring.

(4) Periods when the closed vent systems and control devices required in §§60.482-2, 60.482-3, 60.482-4, and 60.482-5 are not operated as designed, including periods when a flare pilot light does not have a flame.

(5) Dates of startups and shutdowns of the closed vent systems and control devices required in §§60.482-2, 60.482-3, 60.482-4, and 60.482-5.

(e) The following information pertaining to all equipment subject to the requirements in §§60.482-1 to 60.482-10 shall be recorded in a log that is kept in a readily accessible location:

(1) A list of identification numbers for equipment subject to the requirements of this subpart.

(2)(i) A list of identification numbers for equipment that are designated for no detectable emissions under the provisions of §§60.482-2(e), 60.482-3(i) and 60.482-7(f).

(ii) The designation of equipment as subject to the requirements of §60.482-2(e), §60.482-3(i), or §60.482-7(f) shall be signed by the owner or operator.

(3) A list of equipment identification numbers for pressure relief devices required to comply with §60.482-4.

(4)(i) The dates of each compliance test as required in §§60.482-2(e), 60.482-3(i), 60.482-4, and 60.482-7(f).

(ii) The background level measured during each compliance test.

(iii) The maximum instrument reading measured at the equipment during each compliance test.

(5) A list of identification numbers for equipment in vacuum service.

(f) The following information pertaining to all valves subject to the requirements of §60.482-7(g) and (h) and to all pumps subject to the requirements of §60.482-2(g) shall be recorded in a log that is kept in a readily accessible location:

(1) A list of identification numbers for valves and pumps that are designated as unsafe-to-monitor, an explanation for each valve or pump stating why the valve or pump is unsafe-to-monitor, and the plan for monitoring each valve or pump.

(2) A list of identification numbers for valves that are designated as difficult-to-monitor, an explanation for each valve stating why the valve is difficult-to-monitor, and the schedule for monitoring each valve.

(g) The following information shall be recorded for valves complying with §60.483-2:

(1) A schedule of monitoring.

(2) The percent of valves found leaking during each monitoring period.

(h) The following information shall be recorded in a log that is kept in a readily accessible location:

(1) Design criterion required in §§60.482-2(d)(5) and 60.482-3(e)(2) and explanation of the design criterion; and

(2) Any changes to this criterion and the reasons for the changes.

(i) The following information shall be recorded in a log that is kept in a readily accessible location for use in determining exemptions as provided in §60.480(d):

(1) An analysis demonstrating the design capacity of the affected facility,

(2) A statement listing the feed or raw materials and products from the affected facilities and an analysis demonstrating whether these chemicals are heavy liquids or beverage alcohol, and

(3) An analysis demonstrating that equipment is not in VOC service.

(j) Information and data used to demonstrate that a piece of equipment is not in VOC service shall be recorded in a log that is kept in a readily accessible location.

(k) The provisions of §60.7 (b) and (d) do not apply to affected facilities subject to this subpart.

[48 FR 48335, Oct. 18, 1983, as amended at 65 FR 61763, Oct. 17, 2000; 65 FR 78278, Dec. 14, 2000]

§ 60.487 Reporting requirements.

(a) Each owner or operator subject to the provisions of this subpart shall submit semiannual reports to the Administrator beginning six months after the initial startup date.

(b) The initial semiannual report to the Administrator shall include the following information:

(1) Process unit identification.

(2) Number of valves subject to the requirements of §60.482–7, excluding those valves designated for no detectable emissions under the provisions of §60.482–7(f).

(3) Number of pumps subject to the requirements of §60.482–2, excluding those pumps designated for no detectable emissions under the provisions of §60.482–2(e) and those pumps complying with §60.482–2(f).

(4) Number of compressors subject to the requirements of §60.482–3, excluding those compressors designated for no detectable emissions under the provisions of §60.482–3(i) and those compressors complying with §60.482–3(h).

(c) All semiannual reports to the Administrator shall include the following information, summarized from the information in §60.486:

(1) Process unit identification.

(2) For each month during the semiannual reporting period,

(i) Number of valves for which leaks were detected as described in §60.482(7)(b) or §60.483–2,

(ii) Number of valves for which leaks were not repaired as required in §60.482–7(d)(1),

(iii) Number of pumps for which leaks were detected as described in §60.482–2(b) and (d)(6)(i),

(iv) Number of pumps for which leaks were not repaired as required in §60.482–2(c)(1) and (d)(6)(ii),

(v) Number of compressors for which leaks were detected as described in §60.482–3(f),

(vi) Number of compressors for which leaks were not repaired as required in §60.482–3(g)(1), and

(vii) The facts that explain each delay of repair and, where appropriate, why a process unit shutdown was technically infeasible.

(3) Dates of process unit shutdowns which occurred within the semiannual reporting period.

(4) Revisions to items reported according to paragraph (b) if changes have occurred since the initial report or subsequent revisions to the initial report.

(d) An owner or operator electing to comply with the provisions of §§60.483–1 or 60.483–2 shall notify the Administrator of the alternative standard selected 90 days before implementing either of the provisions.

(e) An owner or operator shall report the results of all performance tests in accordance with §60.8 of the General Provisions. The provisions of §60.8(d) do not apply to affected facilities subject to the provisions of this subpart except that an owner or operator must notify the Administrator of the schedule for the initial performance tests at least 30 days before the initial performance tests.

(f) The requirements of paragraphs (a) through (c) of this section remain in force until and unless EPA, in delegating enforcement authority to a State under section 111(c) of the Act, approves reporting requirements or an alternative means of compliance surveillance adopted by such State. In that event, affected sources within the State will be relieved of the obligation to comply with the requirements of paragraphs (a) through (c) of this section, provided that they comply with the requirements established by the State.

[48 FR 48335, Oct. 18, 1983, as amended at 49 FR 22608, May 30, 1984; 65 FR 61763, Oct. 17, 2000]

§ 60.488 Reconstruction.

For the purposes of this subpart:

(a) The cost of the following frequently replaced components of the facility shall not be considered in calculating either the “fixed capital cost of the new components” or the “fixed capital costs that would be required to construct a comparable new facility” under §60.15: pump seals, nuts and bolts, rupture disks, and packings.

(b) Under §60.15, the “fixed capital cost of new components” includes the fixed capital cost of all depreciable components (except components specified in §60.488 (a)) which are or will be replaced pursuant to all continuous programs of component replacement which are commenced within any 2-year period following the applicability date for the appropriate subpart. (See the “Applicability and designation of affected facility” section of the appropriate subpart.) For purposes of this paragraph, “commenced” means that an owner or operator has undertaken a continuous program of component replacement or that an owner or operator has entered into a contractual obligation to undertake and complete, within a reasonable time, a continuous program of component replacement.

[49 FR 22608, May 30, 1984]

§ 60.489 List of chemicals produced by affected facilities.

The following chemicals are produced, as intermediates or final products, by process units covered under this subpart. The applicability date for process units producing one or more of these chemicals is January 5, 1981.

CAS No. ^a	Chemical
105–57–7	Acetal.
75–07–0	Acetaldehyde.
107–89–1	Acetaldol.
60–35–5	Acetamide.

103-84-4	Acetanilide.
64-19-7	Acetic acid.
108-24-7	Acetic anhydride.
67-64-1	Acetone.
75-86-5	Acetone cyanohydrin.
75-05-8	Acetonitrile.
98-86-2	Acetophenone.
75-36-5	Acetyl chloride.
74-86-2	Acetylene.
107-02-8	Acrolein.
79-06-1	Acrylamide.
79-10-7	Acrylic acid.
107-13-1	Acrylonitrile.
124-04-9	Adipic acid.
111-69-3	Adiponitrile.
(^b)	Alkyl naphthalenes.
107-18-6	Allyl alcohol.
107-05-1	Allyl chloride.
1321-11-5	Aminobenzoic acid.
111-41-1	Aminoethylethanolamine.
123-30-8	p-Aminophenol.
628-63-7, 123-92-2	Amyl acetates.
71-41-0 ^c	Amyl alcohols.
110-58-7	Amyl amine.
543-59-9	Amyl chloride.
110-66-7 ^c	Amyl mercaptans.
1322-06-1	Amyl phenol.
62-53-3	Aniline.
142-04-1	Aniline hydrochloride.
29191-52-4	Anisidine.
100-66-3	Anisole.
118-92-3	Anthranilic acid.
84-65-1	Anthraquinone.
100-52-7	Benzaldehyde.
55-21-0	Benzamide.
71-43-2	Benzene.
98-48-6	Benzenedisulfonic acid.
98-11-3	Benzenesulfonic acid.
134-81-6	Benzil.
76-93-7	Benzilic acid.

65-85-0	Benzoic acid.
119-53-9	Benzoin.
100-47-0	Benzonitrile.
119-61-9	Benzophenone.
98-07-7	Benzotrichloride.
98-88-4	Benzoyl chloride.
100-51-6	Benzyl alcohol.
100-46-9	Benzylamine.
120-51-4	Benzyl benzoate.
100-44-7	Benzyl chloride.
98-87-3	Benzyl dichloride.
92-52-4	Biphenyl.
80-05-7	Bisphenol A.
10-86-1	Bromobenzene.
27497-51-4	Bromonaphthalene.
106-99-0	Butadiene.
106-98-9	1-butene.
123-86-4	n-butyl acetate.
141-32-2	n-butyl acrylate.
71-36-3	n-butyl alcohol.
78-92-2	s-butyl alcohol.
75-65-0	t-butyl alcohol.
109-73-9	n-butylamine.
13952-84-6	s-butylamine.
75-64-9	t-butylamine.
98-73-7	p-tert-butyl benzoic acid.
107-88-0	1,3-butylene glycol.
123-72-8	n-butyraldehyde.
107-92-6	Butyric acid.
106-31-0	Butyric anhydride.
109-74-0	Butyronitrile.
105-60-2	Caprolactam.
75-1-50	Carbon disulfide.
558-13-4	Carbon tetrabromide.
56-23-5	Carbon tetrachloride.
9004-35-7	Cellulose acetate.
79-11-8	Chloroacetic acid.
108-42-9	m-chloroaniline.
95-51-2	o-chloroaniline.
106-47-8	p-chloroaniline.

35913-09-8	Chlorobenzaldehyde.
108-90-7	Chlorobenzene.
118-91-2, 535-80-8, 74-11-3 ^c	Chlorobenzoic acid.
2136-81-4, 2136-89-2, 5216-25-1 ^c	Chlorobenzotrichloride.
1321-03-5	Chlorobenzoyl chloride.
25497-29-4	Chlorodifluoromethane.
75-45-6	Chlorodifluoroethane.
67-66-3	Chloroform.
25586-43-0	Chloronaphthalene.
88-73-3	o-chloronitrobenzene.
100-00-5	p-chloronitrobenzene.
25167-80-0	Chlorophenols.
126-99-8	Chloroprene.
7790-94-5	Chlorosulfonic acid.
108-41-8	m-chlorotoluene.
95-49-8	o-chlorotoluene.
106-43-4	p-chlorotoluene.
75-72-9	Chlorotrifluoromethane.
108-39-4	m-cresol.
95-48-7	o-cresol.
106-44-5	p-cresol.
1319-77-3	Mixed cresols.
1319-77-3	Cresylic acid.
4170-30-0	Crotonaldehyde.
3724-65-0	Crotonic acid.
98-82-8	Cumene.
80-15-9	Cumene hydroperoxide.
372-09-8	Cyanoacetic acid.
506-77-4	Cyanogen chloride.
108-80-5	Cyanuric acid.
108-77-0	Cyanuric chloride.
110-82-7	Cyclohexane.
108-93-0	Cyclohexanol.
108-94-1	Cyclohexanone.
110-83-8	Cyclohexene.
108-91-8	Cyclohexylamine.
111-78-4	Cyclooctadiene.
112-30-1	Decanol.
123-42-2	Diacetone alcohol.
27576-04-1	Diaminobenzoic acid.

95-76-1, 95-82-9, 554-00-7, 608-27-5, 608-31-1, 626-43-7, 27134-27-6, 57311-92-9 ^c	Dichloroaniline.
541-73-1	m-dichlorobenzene.
95-50-1	o-dichlorobenzene.
106-46-7	p-dichlorobenzene.
75-71-8	Dichlorodifluoromethane.
111-44-4	Dichloroethyl ether.
107-06-2	1,2-dichloroethane (EDC).
96-23-1	Dichlorohydrin.
26952-23-8	Dichloropropene.
101-83-7	Dicyclohexylamine.
109-89-7	Diethylamine.
111-46-6	Diethylene glycol.
112-36-7	Diethylene glycol diethyl ether.
111-96-6	Diethylene glycol dimethyl ether.
112-34-5	Diethylene glycol monobutyl ether.
124-17-4	Diethylene glycol monobutyl ether acetate.
111-90-0	Diethylene glycol monoethyl ether.
112-15-2	Diethylene glycol monoethyl ether acetate.
111-77-3	Diethylene glycol monomethyl ether.
64-67-5	Diethyl sulfate.
75-37-6	Difluoroethane.
25167-70-8	Diisobutylene.
26761-40-0	Diisodecyl phthalate.
27554-26-3	Diisooctyl phthalate.
674-82-8	Diketene.
124-40-3	Dimethylamine.
121-69-7	N,N-dimethylaniline.
115-10-6	N,N-dimethyl ether.
68-12-2	N,N-dimethylformamide.
57-14-7	Dimethylhydrazine.
77-78-1	Dimethyl sulfate.
75-18-3	Dimethyl sulfide.
67-68-5	Dimethyl sulfoxide.
120-61-6	Dimethyl terephthalate.
99-34-3	3,5-dinitrobenzoic acid.
51-28-5	Dinitrophenol.

25321-14-6	Dinitrotoluene.
123-91-1	Dioxane.
646-06-0	Dioxilane.
122-39-4	Diphenylamine.
101-84-8	Diphenyl oxide.
102-08-9	Diphenyl thiourea.
25265-71-8	Dipropylene glycol.
25378-22-7	Dodecene.
28675-17-4	Dodecylaniline.
27193-86-8	Dodecylphenol.
106-89-8	Epichlorohydrin.
64-17-5	Ethanol.
141-43-5 ^c	Ethanolamines.
141-78-6	Ethyl acetate.
141-97-9	Ethyl acetoacetate.
140-88-5	Ethyl acrylate.
75-04-7	Ethylamine.
100-41-4	Ethylbenzene.
74-96-4	Ethyl bromide.
9004-57-3	Ethylcellulose.
75-00-3	Ethyl chloride.
105-39-5	Ethyl chloroacetate.
105-56-6	Ethylcyanoacetate.
74-85-1	Ethylene.
96-49-1	Ethylene carbonate.
107-07-3	Ethylene chlorohydrin.
107-15-3	Ethylenediamine.
106-93-4	Ethylene dibromide.
107-21-1	Ethylene glycol.
111-55-7	Ethylene glycol diacetate.
110-71-4	Ethylene glycol dimethyl ether.
111-76-2	Ethylene glycol monobutyl ether.
112-07-2	Ethylene glycol monobutyl ether acetate.
110-80-5	Ethylene glycol monoethyl ether.
111-15-9	Ethylene glycol monethyl ether acetate.
109-86-4	Ethylene glycol monomethyl ether.
110-49-6	Ethylene glycol monomethyl ether acetate.
122-99-6	Ethylene glycol monophenyl ether.

2807-30-9	Ethylene glycol monopropyl ether.
75-21-8	Ethylene oxide.
60-29-7	Ethyl ether
104-76-7	2-ethylhexanol.
122-51-0	Ethyl orthoformate.
95-92-1	Ethyl oxalate.
41892-71-1	Ethyl sodium oxalacetate.
50-00-0	Formaldehyde.
75-12-7	Formamide.
64-18-6	Formic acid.
110-17-8	Fumaric acid.
98-01-1	Furfural.
56-81-5	Glycerol.
26545-73-7	Glycerol dichlorohydrin.
25791-96-2	Glycerol triether.
56-40-6	Glycine.
107-22-2	Glyoxal.
118-74-1	Hexachlorobenzene.
67-72-1	Hexachloroethane.
36653-82-4	Hexadecyl alcohol.
124-09-4	Hexamethylenediamine.
629-11-8	Hexamethylene glycol.
100-97-0	Hexamethylenetetramine.
74-90-8	Hydrogen cyanide.
123-31-9	Hydroquinone.
99-96-7	p-hydroxybenzoic acid.
26760-64-5	Isoamylene.
78-83-1	Isobutanol.
110-19-0	Isobutyl acetate.
115-11-7	Isobutylene.
78-84-2	Isobutyraldehyde.
79-31-2	Isobutyric acid.
25339-17-7	Isodecanol.
26952-21-6	Isooctyl alcohol.
78-78-4	Isopentane.
78-59-1	Isophorone.
121-91-5	Isophthalic acid.
78-79-5	Isoprene.
67-63-0	Isopropanol.
108-21-4	Isopropyl acetate.

75-31-0	Isopropylamine.
75-29-6	Isopropyl chloride.
25168-06-3	Isopropylphenol.
463-51-4	Ketene.
(^b)	Linear alkyl sulfonate.
123-01-3	Linear alkylbenzene (linear dodecylbenzene).
110-16-7	Maleic acid.
108-31-6	Maleic anhydride.
6915-15-7	Malic acid.
141-79-7	Mesityl oxide.
121-47-1	Metanilic acid.
79-41-4	Methacrylic acid.
563-47-3	Methallyl chloride.
67-56-1	Methanol.
79-20-9	Methyl acetate.
105-45-3	Methyl acetoacetate.
74-89-5	Methylamine.
100-61-8	n-methylaniline.
74-83-9	Methyl bromide.
37365-71-2	Methyl butynol.
74-87-3	Methyl chloride.
108-87-2	Methylcyclohexane.
1331-22-2	Methylcyclohexanone.
75-09-2	Methylene chloride.
101-77-9	Methylene dianiline.
101-68-8	Methylene diphenyl diisocyanate.
78-93-3	Methyl ethyl ketone.
107-31-3	Methyl formate.
108-11-2	Methyl isobutyl carbinol.
108-10-1	Methyl isobutyl ketone.
80-62-6	Methyl methacrylate.
77-75-8	Methylpentynol.
98-83-9	α-methylstyrene.
110-91-8	Morpholine.
85-47-2	α-naphthalene sulfonic acid.
120-18-3	β-naphthalene sulfonic acid.
90-15-3	α-naphthol.
135-19-3	β-naphthol.
75-98-9	Neopentanoic acid.

88-74-4	o-nitroaniline.
100-01-6	p-nitroaniline.
91-23-6	o-nitroanisole.
100-17-4	p-nitroanisole.
98-95-3	Nitrobenzene.
27178-83-2 ^c	Nitrobenzoic acid (o,m, and p).
79-24-3	Nitroethane.
75-52-5	Nitromethane.
88-75-5	2-Nitrophenol.
25322-01-4	Nitropropane.
1321-12-6	Nitrotoluene.
27215-95-8	Nonene.
25154-52-3	Nonylphenol.
27193-28-8	Octylphenol.
123-63-7	Paraldehyde.
115-77-5	Pentaerythritol.
109-66-0	n-pentane.
109-67-1	1-pentene
127-18-4	Perchloroethylene.
594-42-3	Perchloromethyl mercaptan.
94-70-2	o-phenetidine.
156-43-4	p-phenetidine.
108-95-2	Phenol.
98-67-9, 585-38-6, 609-46-1, 1333-39-7 ^c	Phenolsulfonic acids.
91-40-7	Phenyl anthranilic acid.
(^b)	Phenylenediamine.
75-44-5	Phosgene.
85-44-9	Phthalic anhydride.
85-41-6	Phthalimide.
108-99-6	b-picoline.
110-85-0	Piperazine.
9003-29-6, 25036-29-7 ^c	Polybutenes.
25322-68-3	Polyethylene glycol.
25322-69-4	Polypropylene glycol.
123-38-6	Propionaldehyde.
79-09-4	Propionic acid.
71-23-8	n-propyl alcohol.
107-10-8	Propylamine.
540-54-5	Propyl chloride.

115-07-1	Propylene.
127-00-4	Propylene chlorohydrin.
78-87-5	Propylene dichloride.
57-55-6	Propylene glycol.
75-56-9	Propylene oxide.
110-86-1	Pyridine.
106-51-4	Quinone.
108-46-3	Resorcinol.
27138-57-4	Resorcylic acid.
69-72-7	Salicylic acid.
127-09-3	Sodium acetate.
532-32-1	Sodium benzoate.
9004-32-4	Sodium carboxymethyl cellulose.
3926-62-3	Sodium chloroacetate.
141-53-7	Sodium formate.
139-02-6	Sodium phenate.
110-44-1	Sorbic acid.
100-42-5	Styrene.
110-15-6	Succinic acid.
110-61-2	Succinonitrile.
121-57-3	Sulfanilic acid.
126-33-0	Sulfolane.
1401-55-4	Tannic acid.
100-21-0	Terephthalic acid.
79-34-5 ^c	Tetrachloroethanes.
117-08-8	Tetrachlorophthalic anhydride.
78-00-2	Tetraethyl lead.
119-64-2	Tetrahydronaphthalene.
85-43-8	Tetrahydrophthalic anhydride.
75-74-1	Tetramethyl lead.
110-60-1	Tetramethylenediamine.
110-18-9	Tetramethylethylenediamine.
108-88-3	Toluene.
95-80-7	Toluene-2,4-diamine.
584-84-9	Toluene-2,4-diisocyanate.
26471-62-5	Toluene diisocyanates (mixture).
1333-07-9	Toluenesulfonamide.
104-15-4 ^c	Toluenesulfonic acids.
98-59-9	Toluenesulfonyl chloride.
26915-12-8	Toluidines.

87-61-6, 108-70-3, 120-82-1 ^c	Trichlorobenzenes.
71-55-6	1,1,1-trichloroethane.
79-00-5	1,1,2-trichloroethane.
79-01-6	Trichloroethylene.
75-69-4	Trichlorofluoromethane.
96-18-4	1,2,3-trichloropropane.
76-13-1	1,1,2-trichloro-1,2,2-trifluoroethane.
121-44-8	Triethylamine.
112-27-6	Triethylene glycol.
112-49-2	Triethylene glycol dimethyl ether.
7756-94-7	Triisobutylene.
75-50-3	Trimethylamine.
57-13-6	Urea.
108-05-4	Vinyl acetate.
75-01-4	Vinyl chloride.
75-35-4	Vinylidene chloride.
25013-15-4	Vinyl toluene.
1330-20-7	Xylenes (mixed).
95-47-6	o-xylene.
106-42-3	p-xylene.
1300-71-6	Xylenol.
1300-73-8	Xylidine.

^aCAS numbers refer to the Chemical Abstracts Registry numbers assigned to specific chemicals, isomers, or mixtures of chemicals. Some isomers or mixtures that are covered by the standards do not have CAS numbers assigned to them. The standards apply to all of the chemicals listed, whether CAS numbers have been assigned or not.

^bNo CAS number(s) have been assigned to this chemical, its isomers, or mixtures containing these chemicals.

^cCAS numbers for some of the isomers are listed; the standards apply to all of the isomers and mixtures, even if CAS numbers have not been assigned.

[48 FR 48335, Oct. 18, 1983, as amended at 65 FR 61763, Oct. 17, 2000]

[Browse Previous](#) | [Browse Next](#)

For questions or comments regarding e-CFR editorial content, features, or design, email ecfr@nara.gov.

For questions concerning e-CFR programming and delivery issues, email webteam@gpo.gov.

[Section 508 / Accessibility](#)

[Home Page](#) > [Executive Branch](#) > [Code of Federal Regulations](#) > [Electronic Code of Federal Regulations](#)

Electronic Code of Federal Regulations

e-CFR

TM

e-CFR Data is current as of August 1, 2007

Title 40: Protection of Environment

PART 61—NATIONAL EMISSION STANDARDS FOR HAZARDOUS AIR POLLUTANTS

[Browse Previous](#) | [Browse Next](#)

Subpart J—National Emission Standard for Equipment Leaks (Fugitive Emission Sources) of Benzene

Source: 49 FR 23513, June 6, 1984, unless otherwise noted.

§ 61.110 Applicability and designation of sources.

(a) The provisions of this subpart apply to each of the following sources that are intended to operate in benzene service: pumps, compressors, pressure relief devices, sampling connection systems, open-ended valves or lines, valves, connectors, surge control vessels, bottoms receivers, and control devices or systems required by this subpart.

(b) The provisions of this subpart do not apply to sources located in coke by-product plants.

(c)(1) If an owner or operator applies for one of the exemptions in this paragraph, then the owner or operator shall maintain records as required in §61.246(i).

(2) Any equipment in benzene service that is located at a plant site designed to produce or use less than 1,000 megagrams (1,102 tons) of benzene per year is exempt from the requirements of §61.112.

(3) Any process unit (defined in §61.241) that has no equipment in benzene service is exempt from the requirements of §61.112.

(d) While the provisions of this subpart are effective, a source to which this subpart applies that is also subject to the provisions of 40 CFR part 60 only will be required to comply with the provisions of this subpart.

[49 FR 23513, June 6, 1984, as amended at 65 FR 62156, Oct. 17, 2000; 65 FR 78280, Dec. 14, 2000]

§ 61.111 Definitions.

As used in this subpart, all terms not defined herein shall have the meaning given them in the Act, in subpart A of part 61, or in subpart V of part 61, and the following terms shall have the specific meanings given them:

In benzene service means that a piece of equipment either contains or contacts a fluid (Liquid or gas) that is at least 10 percent benzene by weight as determined according to the provisions of §61.245(d). The provisions of §61.245(d) also specify how to determine that a piece of equipment is not in benzene service.

Semiannual means a 6-month period; the first semiannual period concludes on the last day of the last month during the 180 days following initial startup for new sources; and the first semiannual period concludes on the last day of the last full month during the 180 days after June 6, 1984 for existing sources.

§ 61.112 Standards.

(a) Each owner or operator subject to the provisions of this subpart shall comply with the requirements of subpart V of this part.

(b) An owner or operator may elect to comply with the requirements of §§61.243–1 and 61.243–2.

(c) An owner or operator may apply to the Administrator for a determination of an alternative means of emission limitation that achieves a reduction in emissions of benzene at least equivalent to the reduction in emissions of benzene achieved by the controls required in this subpart. In doing so, the owner or operator shall comply with requirements of §61.244.

[Browse Previous](#) | [Browse Next](#)

For questions or comments regarding e-CFR editorial content, features, or design, email ecfr@nara.gov.

For questions concerning e-CFR programming and delivery issues, email webteam@gpo.gov.

[Section 508 / Accessibility](#)

[Home Page](#) > [Executive Branch](#) > [Code of Federal Regulations](#) > [Electronic Code of Federal Regulations](#)

Electronic Code of Federal Regulations

e-CFR™

e-CFR Data is current as of August 1, 2007

Title 40: Protection of Environment

PART 61—NATIONAL EMISSION STANDARDS FOR HAZARDOUS AIR POLLUTANTS

[Browse Previous](#) | [Browse Next](#)

Subpart M—National Emission Standard for Asbestos

Authority: 42 U.S.C. 7401, 7412, 7414, 7416, 7601.

Source: 49 FR 13661, Apr. 5, 1984, unless otherwise noted.

§ 61.140 Applicability.

The provisions of this subpart are applicable to those sources specified in §§61.142 through 61.151, 61.154, and 61.155.

[55 FR 48414, Nov. 20, 1990]

§ 61.141 Definitions.

All terms that are used in this subpart and are not defined below are given the same meaning as in the Act and in subpart A of this part.

Active waste disposal site means any disposal site other than an inactive site.

Adequately wet means sufficiently mix or penetrate with liquid to prevent the release of particulates. If visible emissions are observed coming from asbestos-containing material, then that material has not been adequately wetted. However, the absence of visible emissions is not sufficient evidence of being adequately wet.

Asbestos means the asbestiform varieties of serpentinite (chrysotile), riebeckite (crocidolite), cummingtonite-grunerite, anthophyllite, and actinolite-tremolite.

Asbestos-containing waste materials means mill tailings or any waste that contains commercial asbestos and is generated by a source subject to the provisions of this subpart. This term includes filters from control devices, friable asbestos waste material, and bags or other similar packaging contaminated with commercial asbestos. As applied to demolition and renovation operations, this term also includes regulated asbestos-containing material waste and materials contaminated with asbestos including disposable equipment and clothing.

Asbestos mill means any facility engaged in converting, or in any intermediate step in converting, asbestos ore into commercial asbestos. Outside storage of asbestos material is not considered a part of the asbestos mill.

Asbestos tailings means any solid waste that contains asbestos and is a product of asbestos mining or milling operations.

Asbestos waste from control devices means any waste material that contains asbestos and is collected by a pollution control device.

Category I nonfriable asbestos-containing material (ACM) means asbestos-containing packings, gaskets, resilient floor covering, and asphalt roofing products containing more than 1 percent asbestos as determined using the method specified in appendix E, subpart E, 40 CFR part 763, section 1, Polarized Light Microscopy.

Category II nonfriable ACM means any material, excluding Category I nonfriable ACM, containing more than 1 percent asbestos as determined using the methods specified in appendix E, subpart E, 40 CFR part 763, section 1, Polarized Light Microscopy that, when dry, cannot be crumbled, pulverized, or reduced to powder by hand pressure.

Commercial asbestos means any material containing asbestos that is extracted from ore and has value because of its asbestos content.

Cutting means to penetrate with a sharp-edged instrument and includes sawing, but does not include shearing, slicing, or punching.

Demolition means the wrecking or taking out of any load-supporting structural member of a facility together with any related handling operations or the intentional burning of any facility.

Emergency renovation operation means a renovation operation that was not planned but results from a sudden, unexpected event that, if not immediately attended to, presents a safety or public health hazard, is necessary to protect equipment from damage, or is necessary to avoid imposing an unreasonable financial burden. This term includes operations necessitated by nonroutine failures of equipment.

Fabricating means any processing (e.g., cutting, sawing, drilling) of a manufactured product that contains commercial asbestos, with the exception of processing at temporary sites (field fabricating) for the construction or restoration of facilities. In the case of friction products, fabricating includes bonding, debonding, grinding, sawing, drilling, or other similar operations performed as part of fabricating.

Facility means any institutional, commercial, public, industrial, or residential structure, installation, or building (including any structure, installation, or building containing condominiums or individual dwelling units operated as a residential cooperative, but excluding residential buildings having four or fewer dwelling units); any ship; and any active or inactive waste disposal site. For purposes of this definition, any building, structure, or installation that contains a loft used as a dwelling is not considered a residential structure, installation, or building. Any structure, installation or building that was previously subject to this subpart is not excluded, regardless of its current use or function.

Facility component means any part of a facility including equipment.

Friable asbestos material means any material containing more than 1 percent asbestos as determined using the method specified in appendix E, subpart E, 40 CFR part 763, section 1, Polarized Light Microscopy, that, when dry, can be crumbled, pulverized, or reduced to powder by hand pressure. If the asbestos content is less than 10 percent as determined by a method other than point counting by polarized light microscopy (PLM), verify the asbestos content by point counting using PLM.

Fugitive source means any source of emissions not controlled by an air pollution control device.

Glove bag means a sealed compartment with attached inner gloves used for the handling of asbestos-containing materials. Properly installed and used, glove bags provide a small work area enclosure typically used for small-scale asbestos stripping operations. Information on glove-bag installation, equipment and supplies, and work practices is contained in the Occupational Safety and Health Administration's (OSHA's) final rule on occupational exposure to asbestos (appendix G to 29 CFR 1926.58).

Grinding means to reduce to powder or small fragments and includes mechanical chipping or drilling.

In poor condition means the binding of the material is losing its integrity as indicated by peeling, cracking, or crumbling of the material.

Inactive waste disposal site means any disposal site or portion of it where additional asbestos-containing waste material has not been deposited within the past year.

Installation means any building or structure or any group of buildings or structures at a single demolition or renovation site that are under the control of the same owner or operator (or owner or operator under common control).

Leak-tight means that solids or liquids cannot escape or spill out. It also means dust-tight.

Malfunction means any sudden and unavoidable failure of air pollution control equipment or process equipment or of a process to operate in a normal or usual manner so that emissions of asbestos are increased. Failures of equipment shall not be considered malfunctions if they are caused in any way by poor maintenance, careless operation, or any other preventable upset conditions, equipment breakdown, or process failure.

Manufacturing means the combining of commercial asbestos—or, in the case of woven friction products, the combining of textiles containing commercial asbestos—with any other material(s), including commercial asbestos, and the processing of this combination into a product. Chlorine production is considered a part of manufacturing.

Natural barrier means a natural object that effectively precludes or deters access. Natural barriers include physical obstacles such as cliffs, lakes or other large bodies of water, deep and wide ravines, and mountains. Remoteness by itself is not a natural barrier.

Nonfriable asbestos-containing material means any material containing more than 1 percent asbestos as determined using the method specified in appendix E, subpart E, 40 CFR part 763, section 1, Polarized Light Microscopy, that, when dry, cannot be crumbled, pulverized, or reduced to powder by hand pressure.

Nonscheduled renovation operation means a renovation operation necessitated by the routine failure of equipment, which is expected to occur within a given period based on past operating experience, but for which an exact date cannot be predicted.

Outside air means the air outside buildings and structures, including, but not limited to, the air under a bridge or in an open air ferry dock.

Owner or operator of a demolition or renovation activity means any person who owns, leases, operates, controls, or supervises the facility being demolished or renovated or any person who owns, leases, operates, controls, or supervises the demolition or renovation operation, or both.

Particulate asbestos material means finely divided particles of asbestos or material containing asbestos.

Planned renovation operations means a renovation operation, or a number of such operations, in which some RACM will be removed or stripped within a given period of time and that can be predicted. Individual nonscheduled operations are included if a number of such operations can be predicted to occur during a given period of time based on operating experience.

Regulated asbestos-containing material (RACM) means (a) Friable asbestos material, (b) Category I nonfriable ACM that has become friable, (c) Category I nonfriable ACM that will be or has been subjected to sanding, grinding, cutting, or abrading, or (d) Category II nonfriable ACM that has a high probability of becoming or has become crumbled, pulverized, or reduced to powder by the forces expected to act on the material in the course of demolition or renovation operations regulated by this subpart.

Remove means to take out RACM or facility components that contain or are covered with RACM from any facility.

Renovation means altering a facility or one or more facility components in any way, including the stripping or removal of RACM from a facility component. Operations in which load-supporting structural members are wrecked or taken out are demolitions.

Resilient floor covering means asbestos-containing floor tile, including asphalt and vinyl floor tile, and sheet vinyl floor covering containing more than 1 percent asbestos as determined using polarized light microscopy according to the method specified in appendix E, subpart E, 40 CFR part 763, section 1, Polarized Light Microscopy.

Roadways means surfaces on which vehicles travel. This term includes public and private highways, roads, streets, parking areas, and driveways.

Strip means to take off RACM from any part of a facility or facility components.

Structural member means any load-supporting member of a facility, such as beams and load supporting walls; or any nonload-supporting member, such as ceilings and nonload-supporting walls.

Visible emissions means any emissions, which are visually detectable without the aid of instruments, coming from RACM or asbestos-containing waste material, or from any asbestos milling, manufacturing, or fabricating operation. This does not include condensed, uncombined water vapor.

Waste generator means any owner or operator of a source covered by this subpart whose act or process produces asbestos-containing waste material.

Waste shipment record means the shipping document, required to be originated and signed by the waste generator, used to track and substantiate the disposition of asbestos-containing waste material.

Working day means Monday through Friday and includes holidays that fall on any of the days Monday through Friday.

[49 FR 13661, Apr. 5, 1984; 49 FR 25453, June 21, 1984, as amended by 55 FR 48414, Nov. 20, 1990; 56 FR 1669, Jan. 16, 1991; 60 FR 31920, June 19, 1995]

§ 61.142 Standard for asbestosmills.

(a) Each owner or operator of an asbestos mill shall either discharge no visible emissions to the outside air from that asbestos mill, including fugitive sources, or use the methods specified by §61.152 to clean emissions containing particulate asbestos material before they escape to, or are vented to, the outside air.

(b) Each owner or operator of an asbestos mill shall meet the following requirements:

(1) Monitor each potential source of asbestos emissions from any part of the mill facility, including air cleaning devices, process equipment, and buildings that house equipment for material processing and handling, at least once each day, during daylight hours, for visible emissions to the outside air during periods of operation. The monitoring shall be by visual observation of at least 15 seconds duration per source of emissions.

(2) Inspect each air cleaning device at least once each week for proper operation and for changes that signal the potential for malfunction, including, to the maximum extent possible without dismantling other than opening the device, the presence of tears, holes, and abrasions in filter bags and for dust deposits on the clean side of bags. For air cleaning devices that cannot be inspected on a weekly basis according to this paragraph, submit to the Administrator, and revise as necessary, a written maintenance plan to include, at a minimum, the following:

(i) Maintenance schedule.

(ii) Recordkeeping plan.

(3) Maintain records of the results of visible emissions monitoring and air cleaning device inspections using a format similar to that shown in Figures 1 and 2 and include the following:

- (i) Date and time of each inspection.
- (ii) Presence or absence of visible emissions.
- (iii) Condition of fabric filters, including presence of any tears, holes, and abrasions.
- (iv) Presence of dust deposits on clean side of fabric filters.
- (v) Brief description of corrective actions taken, including date and time.
- (vi) Daily hours of operation for each air cleaning device.

(4) Furnish upon request, and make available at the affected facility during normal business hours for inspection by the Administrator, all records required under this section.

(5) Retain a copy of all monitoring and inspection records for at least 2 years.

(6) Submit semiannually a copy of visible emission monitoring records to the Administrator if visible emissions occurred during the report period. Semiannual reports shall be postmarked by the 30th day following the end of the six-month period.

Date of inspection (m/d/yr)	Time of inspection (a.m./p.m.)	Air cleaning device or fugitive source designation or number	Visible emissions observed (yes/no), corrective action taken	Daily operating hours	Inspector's initials

Figure 1. Record of Visible Emission Monitoring

[View or download PDF](#)

1. Air cleaning device designation or number	_____	_____	_____	_____
2. Date of inspection	_____	_____	_____	_____
3. Time of inspection	_____	_____	_____	_____
4. Is air cleaning device operating properly (yes/no)	_____	_____	_____	_____
5. Tears, holes, or abrasions in fabric filter (yes/no)	_____	_____	_____	_____
6. Dust on clean side of fabric filters (yes/no)	_____	_____	_____	_____
7. Other signs of malfunctions or potential malfunctions (yes/no)	_____	_____	_____	_____
8. Describe other malfunctions or signs of potential malfunctions.	_____			

9. Describe corrective action(s) taken.	_____			

10. Date and time corrective action taken	_____	_____	_____	_____
11. Inspected by	_____			
	(Print/Type Name)	(Title)	(Signature)	(Date)
	_____	_____	_____	_____
	(Print/Type Name)	(Title)	(Signature)	(Date)
	_____	_____	_____	_____

Figure 2. Air Cleaning Device Inspection Checklist

[View or download PDF](#)

[55 FR 48416, Nov. 20, 1990, as amended at 64 FR 7467, Feb. 12, 1999]

§ 61.143 Standard for roadways.

No person may construct or maintain a roadway with asbestos tailings or asbestos-containing waste material on that roadway, unless, for asbestos tailings.

(a) It is a temporary roadway on an area of asbestos ore deposits (asbestos mine); or

(b) It is a temporary roadway at an active asbestos mill site and is encapsulated with a resinous or bituminous binder. The encapsulated road surface must be maintained at a minimum frequency of once per year to prevent dust emissions; or

(c) It is encapsulated in asphalt concrete meeting the specifications contained in section 401 of Standard Specifications for Construction of Roads and Bridges on Federal Highway Projects, FP-85, 1985, or their equivalent.

[55 FR 48419, Nov. 20, 1990; 56 FR 1669, Jan. 16, 1991]

§ 61.144 Standard for manufacturing.

(a) *Applicability.* This section applies to the following manufacturing operations using commercial asbestos.

(1) The manufacture of cloth, cord, wicks, tubing, tape, twine, rope, thread, yarn, roving, lap, or other textile materials.

- (2) The manufacture of cement products.
- (3) The manufacture of fireproofing and insulating materials.
- (4) The manufacture of friction products.
- (5) The manufacture of paper, millboard, and felt.
- (6) The manufacture of floor tile.
- (7) The manufacture of paints, coatings, caulks, adhesives, and sealants.
- (8) The manufacture of plastics and rubber materials.
- (9) The manufacture of chlorine utilizing asbestos diaphragm technology.
- (10) The manufacture of shotgun shell wads.
- (11) The manufacture of asphalt concrete.

(b) *Standard.* Each owner or operator of any of the manufacturing operations to which this section applies shall either:

- (1) Discharge no visible emissions to the outside air from these operations or from any building or structure in which they are conducted or from any other fugitive sources; or
- (2) Use the methods specified by §61.152 to clean emissions from these operations containing particulate asbestos material before they escape to, or are vented to, the outside air.
- (3) Monitor each potential source of asbestos emissions from any part of the manufacturing facility, including air cleaning devices, process equipment, and buildings housing material processing and handling equipment, at least once each day during daylight hours for visible emissions to the outside air during periods of operation. The monitoring shall be by visual observation of at least 15 seconds duration per source of emissions.
- (4) Inspect each air cleaning device at least once each week for proper operation and for changes that signal the potential for malfunctions, including, to the maximum extent possible without dismantling other than opening the device, the presence of tears, holes, and abrasions in filter bags and for dust deposits on the clean side of bags. For air cleaning devices that cannot be inspected on a weekly basis according to this paragraph, submit to the Administrator, and revise as necessary, a written maintenance plan to include, at a minimum, the following:
 - (i) Maintenance schedule.
 - (ii) Recordkeeping plan.
- (5) Maintain records of the results of visible emission monitoring and air cleaning device inspections using a format similar to that shown in Figures 1 and 2 and include the following.
 - (i) Date and time of each inspection.
 - (ii) Presence or absence of visible emissions.
 - (iii) Condition of fabric filters, including presence of any tears, holes and abrasions.
 - (iv) Presence of dust deposits on clean side of fabric filters.

- (v) Brief description of corrective actions taken, including date and time.
- (vi) Daily hours of operation for each air cleaning device.
- (6) Furnish upon request, and make available at the affected facility during normal business hours for inspection by the Administrator, all records required under this section.
- (7) Retain a copy of all monitoring and inspection records for at least 2 years.
- (8) Submit semiannually a copy of the visible emission monitoring records to the Administrator if visible emission occurred during the report period. Semiannual reports shall be postmarked by the 30th day following the end of the six-month period.

[49 FR 13661, Apr. 5, 1984, as amended at 55 FR 48419, Nov. 20, 1990; 56 FR 1669, Jan. 16, 1991; 64 FR 7467, Feb. 12, 1999]

§ 61.145 Standard for demolition and renovation.

(a) *Applicability.* To determine which requirements of paragraphs (a), (b), and (c) of this section apply to the owner or operator of a demolition or renovation activity and prior to the commencement of the demolition or renovation, thoroughly inspect the affected facility or part of the facility where the demolition or renovation operation will occur for the presence of asbestos, including Category I and Category II nonfriable ACM. The requirements of paragraphs (b) and (c) of this section apply to each owner or operator of a demolition or renovation activity, including the removal of RACM as follows:

- (1) In a facility being demolished, all the requirements of paragraphs (b) and (c) of this section apply, except as provided in paragraph (a)(3) of this section, if the combined amount of RACM is
 - (i) At least 80 linear meters (260 linear feet) on pipes or at least 15 square meters (160 square feet) on other facility components, or
 - (ii) At least 1 cubic meter (35 cubic feet) off facility components where the length or area could not be measured previously.
- (2) In a facility being demolished, only the notification requirements of paragraphs (b)(1), (2), (3)(i) and (iv), and (4)(i) through (vii) and (4)(ix) and (xvi) of this section apply, if the combined amount of RACM is
 - (i) Less than 80 linear meters (260 linear feet) on pipes and less than 15 square meters (160 square feet) on other facility components, and
 - (ii) Less than one cubic meter (35 cubic feet) off facility components where the length or area could not be measured previously or there is no asbestos.
- (3) If the facility is being demolished under an order of a State or local government agency, issued because the facility is structurally unsound and in danger of imminent collapse, only the requirements of paragraphs (b)(1), (b)(2), (b)(3)(iii), (b)(4) (except (b)(4)(viii)), (b)(5), and (c)(4) through (c)(9) of this section apply.
- (4) In a facility being renovated, including any individual nonscheduled renovation operation, all the requirements of paragraphs (b) and (c) of this section apply if the combined amount of RACM to be stripped, removed, dislodged, cut, drilled, or similarly disturbed is
 - (i) At least 80 linear meters (260 linear feet) on pipes or at least 15 square meters (160 square feet) on other facility components, or
 - (ii) At least 1 cubic meter (35 cubic feet) off facility components where the length or area could not be measured previously.
 - (iii) To determine whether paragraph (a)(4) of this section applies to planned renovation operations

involving individual nonscheduled operations, predict the combined additive amount of RACM to be removed or stripped during a calendar year of January 1 through December 31.

(iv) To determine whether paragraph (a)(4) of this section applies to emergency renovation operations, estimate the combined amount of RACM to be removed or stripped as a result of the sudden, unexpected event that necessitated the renovation.

(5) Owners or operators of demolition and renovation operations are exempt from the requirements of §§61.05(a), 61.07, and 61.09.

(b) *Notification requirements.* Each owner or operator of a demolition or renovation activity to which this section applies shall:

(1) Provide the Administrator with written notice of intention to demolish or renovate. Delivery of the notice by U.S. Postal Service, commercial delivery service, or hand delivery is acceptable.

(2) Update notice, as necessary, including when the amount of asbestos affected changes by at least 20 percent.

(3) Postmark or deliver the notice as follows:

(i) At least 10 working days before asbestos stripping or removal work or any other activity begins (such as site preparation that would break up, dislodge or similarly disturb asbestos material), if the operation is described in paragraphs (a) (1) and (4) (except (a)(4)(iii) and (a)(4)(iv)) of this section. If the operation is as described in paragraph (a)(2) of this section, notification is required 10 working days before demolition begins.

(ii) At least 10 working days before the end of the calendar year preceding the year for which notice is being given for renovations described in paragraph (a)(4)(iii) of this section.

(iii) As early as possible before, but not later than, the following working day if the operation is a demolition ordered according to paragraph (a)(3) of this section or, if the operation is a renovation described in paragraph (a)(4)(iv) of this section.

(iv) For asbestos stripping or removal work in a demolition or renovation operation, described in paragraphs (a) (1) and (4) (except (a)(4)(iii) and (a)(4)(iv)) of this section, and for a demolition described in paragraph (a)(2) of this section, that will begin on a date other than the one contained in the original notice, notice of the new start date must be provided to the Administrator as follows:

(A) When the asbestos stripping or removal operation or demolition operation covered by this paragraph will begin after the date contained in the notice,

(1) Notify the Administrator of the new start date by telephone as soon as possible before the original start date, and

(2) Provide the Administrator with a written notice of the new start date as soon as possible before, and no later than, the original start date. Delivery of the updated notice by the U.S. Postal Service, commercial delivery service, or hand delivery is acceptable.

(B) When the asbestos stripping or removal operation or demolition operation covered by this paragraph will begin on a date earlier than the original start date,

(1) Provide the Administrator with a written notice of the new start date at least 10 working days before asbestos stripping or removal work begins.

(2) For demolitions covered by paragraph (a)(2) of this section, provide the Administrator written notice of a new start date at least 10 working days before commencement of demolition. Delivery of updated notice by U.S. Postal Service, commercial delivery service, or hand delivery is acceptable.

(C) In no event shall an operation covered by this paragraph begin on a date other than the date contained in the written notice of the new start date.

(4) Include the following in the notice:

(i) An indication of whether the notice is the original or a revised notification.

(ii) Name, address, and telephone number of both the facility owner and operator and the asbestos removal contractor owner or operator.

(iii) Type of operation: demolition or renovation.

(iv) Description of the facility or affected part of the facility including the size (square meters [square feet] and number of floors), age, and present and prior use of the facility.

(v) Procedure, including analytical methods, employed to detect the presence of RACM and Category I and Category II nonfriable ACM.

(vi) Estimate of the approximate amount of RACM to be removed from the facility in terms of length of pipe in linear meters (linear feet), surface area in square meters (square feet) on other facility components, or volume in cubic meters (cubic feet) if off the facility components. Also, estimate the approximate amount of Category I and Category II nonfriable ACM in the affected part of the facility that will not be removed before demolition.

(vii) Location and street address (including building number or name and floor or room number, if appropriate), city, county, and state, of the facility being demolished or renovated.

(viii) Scheduled starting and completion dates of asbestos removal work (or any other activity, such as site preparation that would break up, dislodge, or similarly disturb asbestos material) in a demolition or renovation; planned renovation operations involving individual nonscheduled operations shall only include the beginning and ending dates of the report period as described in paragraph (a)(4)(iii) of this section.

(ix) Scheduled starting and completion dates of demolition or renovation.

(x) Description of planned demolition or renovation work to be performed and method(s) to be employed, including demolition or renovation techniques to be used and description of affected facility components.

(xi) Description of work practices and engineering controls to be used to comply with the requirements of this subpart, including asbestos removal and waste-handling emission control procedures.

(xii) Name and location of the waste disposal site where the asbestos-containing waste material will be deposited.

(xiii) A certification that at least one person trained as required by paragraph (c)(8) of this section will supervise the stripping and removal described by this notification. This requirement shall become effective 1 year after promulgation of this regulation.

(xiv) For facilities described in paragraph (a)(3) of this section, the name, title, and authority of the State or local government representative who has ordered the demolition, the date that the order was issued, and the date on which the demolition was ordered to begin. A copy of the order shall be attached to the notification.

(xv) For emergency renovations described in paragraph (a)(4)(iv) of this section, the date and hour that the emergency occurred, a description of the sudden, unexpected event, and an explanation of how the event caused an unsafe condition, or would cause equipment damage or an unreasonable financial burden.

(xvi) Description of procedures to be followed in the event that unexpected RACM is found or Category II

nonfriable ACM becomes crumbled, pulverized, or reduced to powder.

(xvii) Name, address, and telephone number of the waste transporter.

(5) The information required in paragraph (b)(4) of this section must be reported using a form similar to that shown in Figure 3.

(c) *Procedures for asbestos emission control.* Each owner or operator of a demolition or renovation activity to whom this paragraph applies, according to paragraph (a) of this section, shall comply with the following procedures:

(1) Remove all RACM from a facility being demolished or renovated before any activity begins that would break up, dislodge, or similarly disturb the material or preclude access to the material for subsequent removal. RACM need not be removed before demolition if:

(i) It is Category I nonfriable ACM that is not in poor condition and is not friable.

(ii) It is on a facility component that is encased in concrete or other similarly hard material and is adequately wet whenever exposed during demolition; or

(iii) It was not accessible for testing and was, therefore, not discovered until after demolition began and, as a result of the demolition, the material cannot be safely removed. If not removed for safety reasons, the exposed RACM and any asbestos-contaminated debris must be treated as asbestos-containing waste material and adequately wet at all times until disposed of.

(iv) They are Category II nonfriable ACM and the probability is low that the materials will become crumbled, pulverized, or reduced to powder during demolition.

(2) When a facility component that contains, is covered with, or is coated with RACM is being taken out of the facility as a unit or in sections:

(i) Adequately wet all RACM exposed during cutting or disjoining operations; and

(ii) Carefully lower each unit or section to the floor and to ground level, not dropping, throwing, sliding, or otherwise damaging or disturbing the RACM.

(3) When RACM is stripped from a facility component while it remains in place in the facility, adequately wet the RACM during the stripping operation.

(i) In renovation operations, wetting is not required if:

(A) The owner or operator has obtained prior written approval from the Administrator based on a written application that wetting to comply with this paragraph would unavoidably damage equipment or present a safety hazard; and

(B) The owner or operator uses of the following emission control methods:

(1) A local exhaust ventilation and collection system designed and operated to capture the particulate asbestos material produced by the stripping and removal of the asbestos materials. The system must exhibit no visible emissions to the outside air or be designed and operated in accordance with the requirements in §61.152.

(2) A glove-bag system designed and operated to contain the particulate asbestos material produced by the stripping of the asbestos materials.

(3) Leak-tight wrapping to contain all RACM prior to dismantlement.

(ii) In renovation operations where wetting would result in equipment damage or a safety hazard, and the

methods allowed in paragraph (c)(3)(i) of this section cannot be used, another method may be used after obtaining written approval from the Administrator based upon a determination that it is equivalent to wetting in controlling emissions or to the methods allowed in paragraph (c)(3)(i) of this section.

(iii) A copy of the Administrator's written approval shall be kept at the worksite and made available for inspection.

(4) After a facility component covered with, coated with, or containing RACM has been taken out of the facility as a unit or in sections pursuant to paragraph (c)(2) of this section, it shall be stripped or contained in leak-tight wrapping, except as described in paragraph (c)(5) of this section. If stripped, either:

(i) Adequately wet the RACM during stripping; or

(ii) Use a local exhaust ventilation and collection system designed and operated to capture the particulate asbestos material produced by the stripping. The system must exhibit no visible emissions to the outside air or be designed and operated in accordance with the requirements in §61.152.

(5) For large facility components such as reactor vessels, large tanks, and steam generators, but not beams (which must be handled in accordance with paragraphs (c)(2), (3), and (4) of this section), the RACM is not required to be stripped if the following requirements are met:

(i) The component is removed, transported, stored, disposed of, or reused without disturbing or damaging the RACM.

(ii) The component is encased in a leak-tight wrapping.

(iii) The leak-tight wrapping is labeled according to §61.149(d)(1)(i), (ii), and (iii) during all loading and unloading operations and during storage.

(6) For all RACM, including material that has been removed or stripped:

(i) Adequately wet the material and ensure that it remains wet until collected and contained or treated in preparation for disposal in accordance with §61.150; and

(ii) Carefully lower the material to the ground and floor, not dropping, throwing, sliding, or otherwise damaging or disturbing the material.

(iii) Transport the material to the ground via leak-tight chutes or containers if it has been removed or stripped more than 50 feet above ground level and was not removed as units or in sections.

(iv) RACM contained in leak-tight wrapping that has been removed in accordance with paragraphs (c)(4) and (c)(3)(i)(B)(3) of this section need not be wetted.

(7) When the temperature at the point of wetting is below 0 °C (32 °F):

(i) The owner or operator need not comply with paragraph (c)(2)(i) and the wetting provisions of paragraph (c)(3) of this section.

(ii) The owner or operator shall remove facility components containing, coated with, or covered with RACM as units or in sections to the maximum extent possible.

(iii) During periods when wetting operations are suspended due to freezing temperatures, the owner or operator must record the temperature in the area containing the facility components at the beginning, middle, and end of each workday and keep daily temperature records available for inspection by the Administrator during normal business hours at the demolition or renovation site. The owner or operator shall retain the temperature records for at least 2 years.

(8) Effective 1 year after promulgation of this regulation, no RACM shall be stripped, removed, or

otherwise handled or disturbed at a facility regulated by this section unless at least one on-site representative, such as a foreman or management-level person or other authorized representative, trained in the provisions of this regulation and the means of complying with them, is present. Every 2 years, the trained on-site individual shall receive refresher training in the provisions of this regulation. The required training shall include as a minimum: applicability; notifications; material identification; control procedures for removals including, at least, wetting, local exhaust ventilation, negative pressure enclosures, glove-bag procedures, and High Efficiency Particulate Air (HEPA) filters; waste disposal work practices; reporting and recordkeeping; and asbestos hazards and worker protection. Evidence that the required training has been completed shall be posted and made available for inspection by the Administrator at the demolition or renovation site.

(9) For facilities described in paragraph (a)(3) of this section, adequately wet the portion of the facility that contains RACM during the wrecking operation.

(10) If a facility is demolished by intentional burning, all RACM including Category I and Category II nonfriable ACM must be removed in accordance with the NESHAP before burning.

NOTIFICATION OF DEMOLITION AND RENOVATION

Operator Project #	Postmark	Date Received	Notification #		
I. TYPE OF NOTIFICATION (Original, Duplicate, Corrected)					
II. FACILITY INFORMATION (Facility name, parent company, and other operators)					
OWNER NAME:					
ADDRESS:					
CITY:	STATE:	ZIP:			
COUNTRY:	TEL:				
REMOVAL CONTRACTOR:					
ADDRESS:					
CITY:	STATE:	ZIP:			
COUNTRY:	TEL:				
OTHER OPERATOR:					
ADDRESS:					
CITY:	STATE:	ZIP:			
COUNTRY:	TEL:				
III. TYPE OF OPERATION (Demolition, Controlled Demolition, Renovation, or Other Operation)					
IV. IS ASBESTOS PRESENT? (Yes/No)					
V. FACILITY DESCRIPTION (Include building name, number and floor or room number)					
Bldg Name:					
Address:					
CITY:	STATE:	COUNTRY:			
Site Location:					
Latitude (N/S):	E or W (E/W):	N or S (N/S):			
Present Year:					
VI. PROCEDURE, INCLUDING ANALYTICAL METHOD, IF APPROPRIATE, USED TO DETECT THE PRESENCE OF ASBESTOS MATERIALS					
VII. APPROXIMATE QUANTITY OF ASBESTOS, INCLUDING:					
1. Regulated area or area removed	RACM TO BE REMOVED	Material NOT To Be Removed		Increase that is Reasonable Below	
2. Category I RACM area removed		Cat I	Cat II	CMF*	CM N)
3. Category II RACM area removed				CMF*	CM N)
Other				CMF*	CM N)
Surface Area				CMF*	CM N)
Other RACM or Facility Component				CMF*	CM N)
VIII. SCHEDULED DATE ASBESTOS REMOVAL (MM/DD/YY) STARTS				Completes	
IX. SCHEDULED DATE DEMO/RENOVATION (MM/DD/YY) BEGINS				Completes	

Continued on page TWO

Figure 3. Notification of Demolition and Renovation

[View or download PDF](#)

NOTIFICATION OF DEMOLITION AND RENOVATION (continued)

X. DESCRIPTION OF PLANNED DEMOLITION OR RENOVATION WORK, AND METHODS TO BE USED:		
XI. DESCRIPTION OF WORK PRACTICES AND ENGINEERING CONTROLS TO BE USED TO PREVENT EMISSIONS OF ASBESTOS AT THE DEMOLITION AND RENOVATION SITE:		
XII. WASTE TRANSPORTER #1		
Name:		
Address:		
City:	State:	Zip:
Contact Person:	Telephone:	
WASTE TRANSPORTER #2		
Name:		
Address:		
City:	State:	Zip:
Contact Person:	Telephone:	
XIII. WASTE DISPOSAL SITE		
Name:		
Location:		
City:	State:	Zip:
Telephone:		
XIV. IF DEMOLITION ORDERED BY A GOVERNMENT AGENCY, PLEASE IDENTIFY THE AGENCY BELOW:		
Name:	Title:	
Address:		
Date of Order (MM/DD/YY):	Date Ordered to Begin (MM/DD/YY):	
XV. FOR EMERGENCY DEMOLITIONS		
Date and Time of Emergency (MM/DD/YY):		
Description of the Damage, Emergency Event:		
Explanation of how the event caused unsafe conditions or would cause equipment damage or an unreasonable financial burden:		
XVI. DESCRIPTION OF PROCEDURES TO BE FOLLOWED IN THE EVENT THAT UNEXPECTED ASBESTOS IS FOUND OR SURPRISELY REMOVED ASBESTOS MATERIAL BECOMES CRUMBLING, FUMING, OR REDUCED TO POWDER.		
XVII. I CERTIFY THAT AN INDIVIDUAL TRAINED IN THE PROVISIONS OF THIS REGULATION (40 CFR PART 61, SUBPART H) WILL BE ON-SITE DURING THE DEMOLITION OR RENOVATION AND EVIDENCE THAT THE REQUIRED TRAINING HAS BEEN ACCOMPLISHED BY THIS PERSON WILL BE AVAILABLE FOR INSPECTION DURING NORMAL BUSINESS HOURS. (Required 1 year after promulgation)		
Signature of Owner/Operator:		Date:
XVIII. I CERTIFY THAT THE ABOVE INFORMATION IS CORRECT.		
Signature of Owner/Operator:		Date:

Figure 3. Notification of Demolition and Renovation

[View or download PDF](#)

[55 FR 48419, Nov. 20, 1990; 56 FR 1669, Jan. 16, 1991]

§ 61.146 Standard for spraying.

The owner or operator of an operation in which asbestos-containing materials are spray applied shall comply with the following requirements:

(a) For spray-on application on buildings, structures, pipes, and conduits, do not use material containing more than 1 percent asbestos as determined using the method specified in appendix E, subpart E, 40 CFR part 763, section 1, Polarized Light Microscopy, except as provided in paragraph (c) of this section.

(b) For spray-on application of materials that contain more than 1 percent asbestos as determined using the method specified in appendix E, subpart E, 40 CFR part 763, section 1, Polarized Light Microscopy, on equipment and machinery, except as provided in paragraph (c) of this section:

(1) Notify the Administrator at least 20 days before beginning the spraying operation. Include the following information in the notice:

(i) Name and address of owner or operator.

(ii) Location of spraying operation.

(iii) Procedures to be followed to meet the requirements of this paragraph.

(2) Discharge no visible emissions to the outside air from spray-on application of the asbestos-containing material or use the methods specified by §61.152 to clean emissions containing particulate

asbestos material before they escape to, or are vented to, the outside air.

(c) The requirements of paragraphs (a) and (b) of this section do not apply to the spray-on application of materials where the asbestos fibers in the materials are encapsulated with a bituminous or resinous binder during spraying and the materials are not friable after drying.

(d) Owners or operators of sources subject to this paragraph are exempt from the requirements of §§61.05(a), 61.07 and 61.09.

[49 FR 13661, Apr. 5, 1984. Redesignated and amended at 55 FR 48424, Nov. 20, 1990; 60 FR 31920, June 19, 1995]

§ 61.147 Standard for fabricating.

(a) *Applicability.* This section applies to the following fabricating operations using commercial asbestos:

(1) The fabrication of cement building products.

(2) The fabrication of friction products, except those operations that primarily install asbestos friction materials on motor vehicles.

(3) The fabrication of cement or silicate board for ventilation hoods; ovens; electrical panels; laboratory furniture, bulkheads, partitions, and ceilings for marine construction; and flow control devices for the molten metal industry.

(b) *Standard.* Each owner or operator of any of the fabricating operations to which this section applies shall either:

(1) Discharge no visible emissions to the outside air from any of the operations or from any building or structure in which they are conducted or from any other fugitive sources; or

(2) Use the methods specified by §61.152 to clean emissions containing particulate asbestos material before they escape to, or are vented to, the outside air.

(3) Monitor each potential source of asbestos emissions from any part of the fabricating facility, including air cleaning devices, process equipment, and buildings that house equipment for material processing and handling, at least once each day, during daylight hours, for visible emissions to the outside air during periods of operation. The monitoring shall be by visual observation of at least 15 seconds duration per source of emissions.

(4) Inspect each air cleaning device at least once each week for proper operation and for changes that signal the potential for malfunctions, including, to the maximum extent possible without dismantling other than opening the device, the presence of tears, holes, and abrasions in filter bags and for dust deposits on the clean side of bags. For air cleaning devices that cannot be inspected on a weekly basis according to this paragraph, submit to the Administrator, and revise as necessary, a written maintenance plan to include, at a minimum, the following:

(i) Maintenance schedule.

(ii) Recordkeeping plan.

(5) Maintain records of the results of visible emission monitoring and air cleaning device inspections using a format similar to that shown in Figures 1 and 2 and include the following:

(i) Date and time of each inspection.

(ii) Presence or absence of visible emissions.

- (iii) Condition of fabric filters, including presence of any tears, holes, and abrasions.
 - (iv) Presence of dust deposits on clean side of fabric filters.
 - (v) Brief description of corrective actions taken, including date and time.
 - (vi) Daily hours of operation for each air cleaning device.
- (6) Furnish upon request and make available at the affected facility during normal business hours for inspection by the Administrator, all records required under this section.
- (7) Retain a copy of all monitoring and inspection records for at least 2 years.
- (8) Submit semiannually a copy of the visible emission monitoring records to the Administrator if visible emission occurred during the report period. Semiannual reports shall be postmarked by the 30th day following the end of the six-month period.

[49 FR 13661, Apr. 5, 1984. Redesignated and amended at 55 FR 48424, Nov. 20, 1991; 64 FR 7467, Feb. 12, 1999]

§ 61.148 Standard for insulating materials.

No owner or operator of a facility may install or reinstall on a facility component any insulating materials that contain commercial asbestos if the materials are either molded and friable or wet-applied and friable after drying. The provisions of this section do not apply to spray-applied insulating materials regulated under §61.146.

[55 FR 48424, Nov. 20, 1990]

§ 61.149 Standard for waste disposal for asbestos mills.

Each owner or operator of any source covered under the provisions of §61.142 shall:

- (a) Deposit all asbestos-containing waste material at a waste disposal site operated in accordance with the provisions of §61.154; and
- (b) Discharge no visible emissions to the outside air from the transfer of control device asbestos waste to the tailings conveyor, or use the methods specified by §61.152 to clean emissions containing particulate asbestos material before they escape to, or are vented to, the outside air. Dispose of the asbestos waste from control devices in accordance with §61.150(a) or paragraph (c) of this section; and
- (c) Discharge no visible emissions to the outside air during the collection, processing, packaging, or on-site transporting of any asbestos-containing waste material, or use one of the disposal methods specified in paragraphs (c) (1) or (2) of this section, as follows:
 - (1) Use a wetting agent as follows:
 - (i) Adequately mix all asbestos-containing waste material with a wetting agent recommended by the manufacturer of the agent to effectively wet dust and tailings, before depositing the material at a waste disposal site. Use the agent as recommended for the particular dust by the manufacturer of the agent.
 - (ii) Discharge no visible emissions to the outside air from the wetting operation or use the methods specified by §61.152 to clean emissions containing particulate asbestos material before they escape to, or are vented to, the outside air.
 - (iii) Wetting may be suspended when the ambient temperature at the waste disposal site is less than -9.5°C (15°F), as determined by an appropriate measurement method with an accuracy of $\pm 1^{\circ}\text{C}$ ($\pm 2^{\circ}\text{F}$). During periods when wetting operations are suspended, the temperature must be recorded at least at

hourly intervals, and records must be retained for at least 2 years in a form suitable for inspection.

(2) Use an alternative emission control and waste treatment method that has received prior written approval by the Administrator. To obtain approval for an alternative method, a written application must be submitted to the Administrator demonstrating that the following criteria are met:

(i) The alternative method will control asbestos emissions equivalent to currently required methods.

(ii) The suitability of the alternative method for the intended application.

(iii) The alternative method will not violate other regulations.

(iv) The alternative method will not result in increased water pollution, land pollution, or occupational hazards.

(d) When waste is transported by vehicle to a disposal site:

(1) Mark vehicles used to transport asbestos-containing waste material during the loading and unloading of the waste so that the signs are visible. The markings must:

(i) Be displayed in such a manner and location that a person can easily read the legend.

(ii) Conform to the requirements for 51 cm × 36 cm (20 in × 14 in) upright format signs specified in 29 CFR 1910.145(d)(4) and this paragraph; and

(iii) Display the following legend in the lower panel with letter sizes and styles of a visibility at least equal to those specified in this paragraph.

Legend

DANGER

ASBESTOS DUST HAZARD

CANCER AND LUNG DISEASE HAZARD

Authorized Personnel Only

Notation

2.5 cm (1 inch) Sans Serif, Gothic or Block

2.5 cm (1 inch) Sans Serif, Gothic or Block

1.9 cm (3/4inch) Sans Serif, Gothic or Block

14 Point Gothic

Spacing between any two lines must be a least equal to the height of the upper of the two lines.

(2) For off-site disposal, provide a copy of the waste shipment record, described in paragraph (e)(1) of this section, to the disposal site owner or operator at the same time as the asbestos-containing waste material is delivered to the disposal site.

(e) For all asbestos-containing waste material transported off the facility site:

(1) Maintain asbestos waste shipment records, using a form similar to that shown in Figure 4, and include the following information:

- (i) The name, address, and telephone number of the waste generator.
- (ii) The name and address of the local, State, or EPA Regional agency responsible for administering the asbestos NESHAP program.
- (iii) The quantity of the asbestos-containing waste material in cubic meters (cubic yards).
- (iv) The name and telephone number of the disposal site operator.
- (v) The name and physical site location of the disposal site.
- (vi) The date transported.
- (vii) The name, address, and telephone number of the transporter(s).
- (viii) A certification that the contents of this consignment are fully and accurately described by proper shipping name and are classified, packed, marked, and labeled, and are in all respects in proper condition for transport by highway according to applicable international and government regulations.

(2) For waste shipments where a copy of the waste shipment record, signed by the owner or operator of the designated disposal site, is not received by the waste generator within 35 days of the date the waste was accepted by the initial transporter, contact the transporter and/or the owner or operator of the designated disposal site to determine the status of the waste shipment.

(3) Report in writing to the local, State, or EPA Regional office responsible for administering the asbestos NESHAP program for the waste generator if a copy of the waste shipment record, signed by the owner or operator of the designated waste disposal site, is not received by the waste generator within 45 days of the date the waste was accepted by the initial transporter. Include in the report the following information:

- (i) A copy of the waste shipment record for which a confirmation of delivery was not received, and
- (ii) A cover letter signed by the waste generator explaining the efforts taken to locate the asbestos waste shipment and the results of those efforts.

(4) Retain a copy of all waste shipment records, including a copy of the waste shipment record signed by the owner or operator of the designated waste disposal site, for at least 2 years.

(f) Furnish upon request, and make available for inspection by the Administrator, all records required under this section.

Generator	1. Work site name and mailing address		Owner's name	Owner's telephone no.
	2. Operator's name and address			Operator's telephone no.
	3. Waste disposal site (WDS) name, mailing address, and physical site location			WDS phone no.
	4. Name, and address of responsible agency			
	5. Description of materials		6. Containers No. Type	7. Total quantity m ³ (yd ³)
	8. Special handling instructions and additional information			
	9. OPERATOR'S CERTIFICATION: I hereby declare that the contents of this consignment are fully and accurately described above by proper shipping name and are classified, packed, marked, and labeled, and are in all respects in proper condition for transport by highway according to applicable international and government regulations.			
	Printed/typed name & title		Signature	Month Day Year
	10. Transporter 1 (Acknowledgment of receipt of materials)			
Transporter	Printed/typed name & title		Signature	Month Day Year
	Address and telephone no.			
	11. Transporter 2 (Acknowledgment of receipt of materials)			
	Printed/typed name & title		Signature	Month Day Year
Address and telephone no.				
Disposal Site	12. Discrepancy indication space			
	13. Waste disposal site owner or operator: Certification of receipt of asbestos materials covered by this manifest except as noted in item 12.			
	Printed/typed name & title		Signature	Month Day Year

(Continued)

Figure 4. Waste Shipment Record

[View or download PDF](#)

INSTRUCTIONS

Waste Generator Section (Items 1-9)

1. Enter the name of the facility at which asbestos waste is generated and the address where the facility is located. In the appropriate spaces, also enter the name of the owner of the facility and the owner's phone number.
2. If a demolition or renovation, enter the name and address of the company and authorized agent responsible for performing the asbestos removal. In the appropriate spaces, also enter the phone number of the operator.
3. Enter the name, address, and physical site location of the waste disposal site (WDS) that will be receiving the asbestos materials. In the appropriate spaces, also enter the phone number of the WDS. Enter "on-site" if the waste will be disposed of on the generator's property.
4. Provide the name and address of the local, State, or EPA Regional office responsible for administering the asbestos HESHAP program.
5. Indicate the types of asbestos waste materials generated. If from a demolition or renovation, indicate the amount of asbestos that is
 - Friable asbestos material
 - Nonfriable asbestos material
6. Enter the number of containers used to transport the asbestos materials listed in item 5. Also enter one of the following container codes used in transporting each type of asbestos material (specify any other type of container used if not listed below):
 - DM - Metal drums, barrels
 - DP - Plastic drums, barrels
 - BA - 6 mil plastic bags or wrapping
7. Enter the quantities of each type of asbestos material removed in units of cubic meters (cubic yards).
8. Use this space to indicate special transportation, treatment, storage or disposal or Bill of Lading information. If an alternate waste disposal site is designated, note it here. Emergency response telephone numbers or similar information may be included here.
9. The authorized agent of the waste generator must read and then sign and date this certification. The date is the date of receipt by transporter.

NOTE: The waste generator must retain a copy of this form.

(continued)

Figure 4. Waste Shipment Record

[View or download PDF](#)

Transporter Section (Items 10 & 11)

10. & 11. Enter name, address, and telephone number of each transporter used, if applicable. Print or type the full name and title of person accepting responsibility and acknowledging receipt of materials as listed on this waste shipment record for transport. Enter date of receipt and signature.

NOTE: The transporter must retain a copy of this form.

Disposal Site Section (Items 12 & 13)

12. The authorized representative of the WDS must note in this space any discrepancy between waste described on this manifest and waste actually received as well as any improperly enclosed or contained waste. Any rejected materials should be listed and destination of those materials provided. A site that converts asbestos-containing waste material to nonasbestos material is considered a WDS.
13. The signature (by hand) of the authorized WDS agent indicates acceptance and agreement with statements on this manifest except as noted in item 12. The date is the date of signature and receipt of shipment.

NOTE: The WDS must retain a completed copy of this form. The WDS must also send a completed copy to the operator listed in item 2.

Figure 4. Waste Shipment Record

[View or download PDF](#)

§ 61.150 Standard for waste disposal for manufacturing, fabricating, demolition, renovation, and spraying operations.

Each owner or operator of any source covered under the provisions of §§61.144, 61.145, 61.146, and 61.147 shall comply with the following provisions:

(a) Discharge no visible emissions to the outside air during the collection, processing (including incineration), packaging, or transporting of any asbestos-containing waste material generated by the source, or use one of the emission control and waste treatment methods specified in paragraphs (a) (1) through (4) of this section.

(1) Adequately wet asbestos-containing waste material as follows:

(i) Mix control device asbestos waste to form a slurry; adequately wet other asbestos-containing waste material; and

(ii) Discharge no visible emissions to the outside air from collection, mixing, wetting, and handling operations, or use the methods specified by §61.152 to clean emissions containing particulate asbestos material before they escape to, or are vented to, the outside air; and

(iii) After wetting, seal all asbestos-containing waste material in leak-tight containers while wet; or, for materials that will not fit into containers without additional breaking, put materials into leak-tight wrapping; and

(iv) Label the containers or wrapped materials specified in paragraph (a)(1)(iii) of this section using warning labels specified by Occupational Safety and Health Standards of the Department of Labor, Occupational Safety and Health Administration (OSHA) under 29 CFR 1910.1001(j)(4) or 1926.1101(k) (8). The labels shall be printed in letters of sufficient size and contrast so as to be readily visible and legible.

(v) For asbestos-containing waste material to be transported off the facility site, label containers or wrapped materials with the name of the waste generator and the location at which the waste was generated.

(2) Process asbestos-containing waste material into nonfriable forms as follows:

(i) Form all asbestos-containing waste material into nonfriable pellets or other shapes;

(ii) Discharge no visible emissions to the outside air from collection and processing operations, including incineration, or use the method specified by §61.152 to clean emissions containing particulate asbestos material before they escape to, or are vented to, the outside air.

(3) For facilities demolished where the RACM is not removed prior to demolition according to §§61.145 (c)(1) (i), (ii), (iii), and (iv) or for facilities demolished according to §61.145(c)(9), adequately wet asbestos-containing waste material at all times after demolition and keep wet during handling and loading for transport to a disposal site. Asbestos-containing waste materials covered by this paragraph do not have to be sealed in leak-tight containers or wrapping but may be transported and disposed of in bulk.

(4) Use an alternative emission control and waste treatment method that has received prior approval by the Administrator according to the procedure described in §61.149(c)(2).

(5) As applied to demolition and renovation, the requirements of paragraph (a) of this section do not apply to Category I nonfriable ACM waste and Category II nonfriable ACM waste that did not become crumbled, pulverized, or reduced to powder.

(b) All asbestos-containing waste material shall be deposited as soon as is practical by the waste generator at:

(1) A waste disposal site operated in accordance with the provisions of §61.154, or

(2) An EPA-approved site that converts RACM and asbestos-containing waste material into nonasbestos (asbestos-free) material according to the provisions of §61.155.

(3) The requirements of paragraph (b) of this section do not apply to Category I nonfriable ACM that is not RACM.

(c) Mark vehicles used to transport asbestos-containing waste material during the loading and unloading of waste so that the signs are visible. The markings must conform to the requirements of §§61.149(d)(1) (i), (ii), and (iii).

(d) For all asbestos-containing waste material transported off the facility site:

(1) Maintain waste shipment records, using a form similar to that shown in Figure 4, and include the following information:

(i) The name, address, and telephone number of the waste generator.

(ii) The name and address of the local, State, or EPA Regional office responsible for administering the asbestos NESHAP program.

(iii) The approximate quantity in cubic meters (cubic yards).

(iv) The name and telephone number of the disposal site operator.

(v) The name and physical site location of the disposal site.

(vi) The date transported.

(vii) The name, address, and telephone number of the transporter(s).

(viii) A certification that the contents of this consignment are fully and accurately described by proper shipping name and are classified, packed, marked, and labeled, and are in all respects in proper condition for transport by highway according to applicable international and government regulations.

(2) Provide a copy of the waste shipment record, described in paragraph (d)(1) of this section, to the disposal site owners or operators at the same time as the asbestos-containing waste material is delivered to the disposal site.

(3) For waste shipments where a copy of the waste shipment record, signed by the owner or operator of the designated disposal site, is not received by the waste generator within 35 days of the date the waste was accepted by the initial transporter, contact the transporter and/or the owner or operator of the designated disposal site to determine the status of the waste shipment.

(4) Report in writing to the local, State, or EPA Regional office responsible for administering the asbestos NESHAP program for the waste generator if a copy of the waste shipment record, signed by the owner or operator of the designated waste disposal site, is not received by the waste generator within 45 days of the date the waste was accepted by the initial transporter. Include in the report the following information:

(i) A copy of the waste shipment record for which a confirmation of delivery was not received, and

(ii) A cover letter signed by the waste generator explaining the efforts taken to locate the asbestos waste shipment and the results of those efforts.

(5) Retain a copy of all waste shipment records, including a copy of the waste shipment record signed by the owner or operator of the designated waste disposal site, for at least 2 years.

(e) Furnish upon request, and make available for inspection by the Administrator, all records required under this section.

[55 FR 48429, Nov. 20, 1990; 56 FR 1669, Jan. 16, 1991, as amended at 68 FR 54793, Sept. 18, 2003]

§ 61.151 Standard for inactive waste disposal sites for asbestos mills and manufacturing and fabricating operations.

Each owner or operator of any inactive waste disposal site that was operated by sources covered under §61.142, 61.144, or 61.147 and received deposits of asbestos-containing waste material generated by the sources, shall:

(a) Comply with one of the following:

(1) Either discharge no visible emissions to the outside air from an inactive waste disposal site subject to this paragraph; or

(2) Cover the asbestos-containing waste material with at least 15 centimeters (6 inches) of compacted nonasbestos-containing material, and grow and maintain a cover of vegetation on the area adequate to prevent exposure of the asbestos-containing waste material. In desert areas where vegetation would be difficult to maintain, at least 8 additional centimeters (3 inches) of well-graded, nonasbestos crushed rock may be placed on top of the final cover instead of vegetation and maintained to prevent emissions; or

(3) Cover the asbestos-containing waste material with at least 60 centimeters (2 feet) of compacted nonasbestos-containing material, and maintain it to prevent exposure of the asbestos-containing waste; or

(4) For inactive waste disposal sites for asbestos tailings, a resinous or petroleum-based dust suppression agent that effectively binds dust to control surface air emissions may be used instead of the methods in paragraphs (a) (1), (2), and (3) of this section. Use the agent in the manner and frequency recommended for the particular asbestos tailings by the manufacturer of the dust suppression agent to achieve and maintain dust control. Obtain prior written approval of the Administrator to use other equally effective dust suppression agents. For purposes of this paragraph, any used, spent, or other waste oil is not considered a dust suppression agent.

(b) Unless a natural barrier adequately deters access by the general public, install and maintain warning signs and fencing as follows, or comply with paragraph (a)(2) or (a)(3) of this section.

(1) Display warning signs at all entrances and at intervals of 100 m (328 ft) or less along the property line of the site or along the perimeter of the sections of the site where asbestos-containing waste material was deposited. The warning signs must:

(i) Be posted in such a manner and location that a person can easily read the legend; and

(ii) Conform to the requirements for 51 cm×36 cm (20&inch;×14&inch;) upright format signs specified in 29 CFR 1910.145(d)(4) and this paragraph; and

(iii) Display the following legend in the lower panel with letter sizes and styles of a visibility at least equal to those specified in this paragraph.

Legend	Notation
Asbestos Waste Disposal Site	2.5 cm (1 inch) Sans Serif, Gothic or Block
Do Not Create Dust	1.9 cm (3/4 inch) Sans Serif, Gothic or Block
Breathing Asbestos is Hazardous to Your Health	14 Point Gothic.

Spacing between any two lines must be at least equal to the height of the upper of the two lines.

(2) Fence the perimeter of the site in a manner adequate to deter access by the general public.

(3) When requesting a determination on whether a natural barrier adequately deters public access, supply information enabling the Administrator to determine whether a fence or a natural barrier

adequately deters access by the general public.

(c) The owner or operator may use an alternative control method that has received prior approval of the Administrator rather than comply with the requirements of paragraph (a) or (b) of this section.

(d) Notify the Administrator in writing at least 45 days prior to excavating or otherwise disturbing any asbestos-containing waste material that has been deposited at a waste disposal site under this section, and follow the procedures specified in the notification. If the excavation will begin on a date other than the one contained in the original notice, notice of the new start date must be provided to the Administrator at least 10 working days before excavation begins and in no event shall excavation begin earlier than the date specified in the original notification. Include the following information in the notice:

(1) Scheduled starting and completion dates.

(2) Reason for disturbing the waste.

(3) Procedures to be used to control emissions during the excavation, storage, transport, and ultimate disposal of the excavated asbestos-containing waste material. If deemed necessary, the Administrator may require changes in the emission control procedures to be used.

(4) Location of any temporary storage site and the final disposal site.

(e) Within 60 days of a site becoming inactive and after the effective date of this subpart, record, in accordance with State law, a notation on the deed to the facility property and on any other instrument that would normally be examined during a title search; this notation will in perpetuity notify any potential purchaser of the property that:

(1) The land has been used for the disposal of asbestos-containing waste material;

(2) The survey plot and record of the location and quantity of asbestos-containing waste disposed of within the disposal site required in §61.154(f) have been filed with the Administrator; and

(3) The site is subject to 40 CFR part 61, subpart M.

[49 FR 13661, Apr. 5, 1984, as amended at 53 FR 36972, Sept. 23, 1988. Redesignated and amended at 55 FR 48429, Nov. 20, 1990]

§ 61.152 Air-cleaning.

(a) The owner or operator who uses air cleaning, as specified in §§61.142(a), 61.144(b)(2), 61.145(c)(3)(i)(B)(1), 61.145(c)(4)(ii), 61.145(c)(11)(i), 61.146(b)(2), 61.147(b)(2), 61.149(b), 61.149(c)(1)(ii), 61.150(a)(1)(ii), 61.150(a)(2)(ii), and 61.155(e) shall:

(1) Use fabric filter collection devices, except as noted in paragraph (b) of this section, doing all of the following:

(i) Ensuring that the airflow permeability, as determined by ASTM Method D737-75, does not exceed $9 \text{ m}^3/\text{min}/\text{m}^2$ ($30 \text{ ft}^3/\text{min}/\text{ft}^2$) for woven fabrics or $11^3/\text{min}/\text{m}^2$ ($35 \text{ ft}^3/\text{min}/\text{ft}^2$) for felted fabrics, except that $12 \text{ m}^3/\text{min}/\text{m}^2$ ($40 \text{ ft}^3/\text{min}/\text{ft}^2$) for woven and $14 \text{ m}^3/\text{min}/\text{m}^2$ ($45 \text{ ft}^3/\text{min}/\text{ft}^2$) for felted fabrics is allowed for filtering air from asbestos ore dryers; and

(ii) Ensuring that felted fabric weighs at least 475 grams per square meter (14 ounces per square yard) and is at least 1.6 millimeters (one-sixteenth inch) thick throughout; and

(iii) Avoiding the use of synthetic fabrics that contain fill yarn other than that which is spun.

(2) Properly install, use, operate, and maintain all air-cleaning equipment authorized by this section. Bypass devices may be used only during upset or emergency conditions and then only for so long as it

takes to shut down the operation generating the particulate asbestos material.

(3) For fabric filter collection devices installed after January 10, 1989, provide for easy inspection for faulty bags.

(b) There are the following exceptions to paragraph (a)(1):

(1) After January 10, 1989, if the use of fabric creates a fire or explosion hazard, or the Administrator determines that a fabric filter is not feasible, the Administrator may authorize as a substitute the use of wet collectors designed to operate with a unit contacting energy of at least 9.95 kilopascals (40 inches water gage pressure).

(2) Use a HEPA filter that is certified to be at least 99.97 percent efficient for 0.3 micron particles.

(3) The Administrator may authorize the use of filtering equipment other than described in paragraphs (a)(1) and (b)(1) and (2) of this section if the owner or operator demonstrates to the Administrator's satisfaction that it is equivalent to the described equipment in filtering particulate asbestos material.

[49 FR 13661, Apr. 5, 1984; 49 FR 25453, June 21, 1984, as amended at 51 FR 8199, Mar. 10, 1986. Redesignated and amended at 55 FR 48430, Nov. 20, 1990]

§ 61.153 Reporting.

(a) Any new source to which this subpart applies (with the exception of sources subject to §§61.143, 61.145, 61.146, and 61.148), which has an initial startup date preceding the effective date of this revision, shall provide the following information to the Administrator postmarked or delivered within 90 days of the effective date. In the case of a new source that does not have an initial startup date preceding the effective date, the information shall be provided, postmarked or delivered, within 90 days of the initial startup date. Any owner or operator of an existing source shall provide the following information to the Administrator within 90 days of the effective date of this subpart unless the owner or operator of the existing source has previously provided this information to the Administrator. Any changes in the information provided by any existing source shall be provided to the Administrator, postmarked or delivered, within 30 days after the change.

(1) A description of the emission control equipment used for each process; and

(i) If the fabric device uses a woven fabric, the airflow permeability in $\text{m}^3/\text{min}/\text{m}^2$ and; if the fabric is synthetic, whether the fill yarn is spun or not spun; and

(ii) If the fabric filter device uses a felted fabric, the density in g/m^2 , the minimum thickness in inches, and the airflow permeability in $\text{m}^3/\text{min}/\text{m}^2$.

(2) If a fabric filter device is used to control emissions,

(i) The airflow permeability in $\text{m}^3/\text{min}/\text{m}^2$ ($\text{ft}^3/\text{min}/\text{ft}^2$) if the fabric filter device uses a woven fabric, and, if the fabric is synthetic, whether the fill yarn is spun or not spun; and

(ii) If the fabric filter device uses a felted fabric, the density in g/m^2 (oz/yd^2), the minimum thickness in millimeters (inches), and the airflow permeability in $\text{m}^3/\text{min}/\text{m}^2$ ($\text{ft}^3/\text{min}/\text{ft}^2$).

(3) If a HEPA filter is used to control emissions, the certified efficiency.

(4) For sources subject to §§61.149 and 61.150:

(i) A brief description of each process that generates asbestos-containing waste material; and

(ii) The average volume of asbestos-containing waste material disposed of, measured in m^3/day

(yd³ /day); and

(iii) The emission control methods used in all stages of waste disposal; and

(iv) The type of disposal site or incineration site used for ultimate disposal, the name of the site operator, and the name and location of the disposal site.

(5) For sources subject to §§61.151 and 61.154:

(i) A brief description of the site; and

(ii) The method or methods used to comply with the standard, or alternative procedures to be used.

(b) The information required by paragraph (a) of this section must accompany the information required by §61.10. Active waste disposal sites subject to §61.154 shall also comply with this provision. Roadways, demolition and renovation, spraying, and insulating materials are exempted from the requirements of §61.10(a). The information described in this section must be reported using the format of appendix A of this part as a guide.

(Sec. 114. Clean Air Act as amended (42 U.S.C. 7414))

[49 FR 13661, Apr. 5, 1984. Redesignated and amended at 55 FR 48430, Nov. 20, 1990; 56 FR 1669, Jan. 16, 1991]

§ 61.154 Standard for active waste disposal sites.

Each owner or operator of an active waste disposal site that receives asbestos-containing waste material from a source covered under §61.149, 61.150, or 61.155 shall meet the requirements of this section:

(a) Either there must be no visible emissions to the outside air from any active waste disposal site where asbestos-containing waste material has been deposited, or the requirements of paragraph (c) or (d) of this section must be met.

(b) Unless a natural barrier adequately deters access by the general public, either warning signs and fencing must be installed and maintained as follows, or the requirements of paragraph (c)(1) of this section must be met.

(1) Warning signs must be displayed at all entrances and at intervals of 100 m (330 ft) or less along the property line of the site or along the perimeter of the sections of the site where asbestos-containing waste material is deposited. The warning signs must:

(i) Be posted in such a manner and location that a person can easily read the legend; and

(ii) Conform to the requirements of 51 cm × 36 cm (20&inch;×14&inch;) upright format signs specified in 29 CFR 1910.145(d)(4) and this paragraph; and

(iii) Display the following legend in the lower panel with letter sizes and styles of a visibility at least equal to those specified in this paragraph.

Legend	Notation
Asbestos Waste Disposal Site	2.5 cm (1 inch) Sans Serif, Gothic or Block.
Do Not Create Dust	1.9 cm (3/4 inch) Sans Serif, Gothic or Block.
Breathing Asbestos is Hazardous to	14 Point Gothic.

disposal site. Describe the discrepancy and attempts to reconcile it, and submit a copy of the waste shipment record along with the report.

(4) Retain a copy of all records and reports required by this paragraph for at least 2 years.

(f) Maintain, until closure, records of the location, depth and area, and quantity in cubic meters (cubic yards) of asbestos-containing waste material within the disposal site on a map or diagram of the disposal area.

(g) Upon closure, comply with all the provisions of §61.151.

(h) Submit to the Administrator, upon closure of the facility, a copy of records of asbestos waste disposal locations and quantities.

(i) Furnish upon request, and make available during normal business hours for inspection by the Administrator, all records required under this section.

(j) Notify the Administrator in writing at least 45 days prior to excavating or otherwise disturbing any asbestos-containing waste material that has been deposited at a waste disposal site and is covered. If the excavation will begin on a date other than the one contained in the original notice, notice of the new start date must be provided to the Administrator at least 10 working days before excavation begins and in no event shall excavation begin earlier than the date specified in the original notification. Include the following information in the notice:

(1) Scheduled starting and completion dates.

(2) Reason for disturbing the waste.

(3) Procedures to be used to control emissions during the excavation, storage, transport, and ultimate disposal of the excavated asbestos-containing waste material. If deemed necessary, the Administrator may require changes in the emission control procedures to be used.

(4) Location of any temporary storage site and the final disposal site.

(Secs. 112 and 301(a) of the Clean Air Act as amended (42 U.S.C. 7412, 7601(a))

[49 FR 13661, Apr. 5, 1990. Redesignated and amended at 55 FR 48431, Nov. 20, 1990; 56 FR 1669, Jan. 16, 1991]

§ 61.155 Standard for operations that convert asbestos-containing waste material into nonasbestos (asbestos-free) material.

Each owner or operator of an operation that converts RACM and asbestos-containing waste material into nonasbestos (asbestos-free) material shall:

(a) Obtain the prior written approval of the Administrator to construct the facility. To obtain approval, the owner or operator shall provide the Administrator with the following information:

(1) Application to construct pursuant to §61.07.

(2) In addition to the information requirements of §61.07(b)(3), a

(i) Description of waste feed handling and temporary storage.

(ii) Description of process operating conditions.

(iii) Description of the handling and temporary storage of the end product.

(iv) Description of the protocol to be followed when analyzing output materials by transmission electron microscopy.

(3) Performance test protocol, including provisions for obtaining information required under paragraph (b) of this section.

(4) The Administrator may require that a demonstration of the process be performed prior to approval of the application to construct.

(b) Conduct a start-up performance test. Test results shall include:

(1) A detailed description of the types and quantities of nonasbestos material, RACM, and asbestos-containing waste material processed, e.g., asbestos cement products, friable asbestos insulation, plaster, wood, plastic, wire, etc. Test feed is to include the full range of materials that will be encountered in actual operation of the process.

(2) Results of analyses, using polarized light microscopy, that document the asbestos content of the wastes processed.

(3) Results of analyses, using transmission electron microscopy, that document that the output materials are free of asbestos. Samples for analysis are to be collected as 8-hour composite samples (one 200-gram (7-ounce) sample per hour), beginning with the initial introduction of RACM or asbestos-containing waste material and continuing until the end of the performance test.

(4) A description of operating parameters, such as temperature and residence time, defining the full range over which the process is expected to operate to produce nonasbestos (asbestos-free) materials. Specify the limits for each operating parameter within which the process will produce nonasbestos (asbestos-free) materials.

(5) The length of the test.

(c) During the initial 90 days of operation,

(1) Continuously monitor and log the operating parameters identified during start-up performance tests that are intended to ensure the production of nonasbestos (asbestos-free) output material.

(2) Monitor input materials to ensure that they are consistent with the test feed materials described during start-up performance tests in paragraph (b)(1) of this section.

(3) Collect and analyze samples, taken as 10-day composite samples (one 200-gram (7-ounce) sample collected every 8 hours of operation) of all output material for the presence of asbestos. Composite samples may be for fewer than 10 days. Transmission electron microscopy (TEM) shall be used to analyze the output material for the presence of asbestos. During the initial 90-day period, all output materials must be stored on-site until analysis shows the material to be asbestos-free or disposed of as asbestos-containing waste material according to §61.150.

(d) After the initial 90 days of operation,

(1) Continuously monitor and record the operating parameters identified during start-up performance testing and any subsequent performance testing. Any output produced during a period of deviation from the range of operating conditions established to ensure the production of nonasbestos (asbestos-free) output materials shall be:

(i) Disposed of as asbestos-containing waste material according to §61.150, or

(ii) Recycled as waste feed during process operation within the established range of operating conditions, or

(iii) Stored temporarily on-site in a leak-tight container until analyzed for asbestos content. Any product

material that is not asbestos-free shall be either disposed of as asbestos-containing waste material or recycled as waste feed to the process.

(2) Collect and analyze monthly composite samples (one 200-gram (7-ounce) sample collected every 8 hours of operation) of the output material. Transmission electron microscopy shall be used to analyze the output material for the presence of asbestos.

(e) Discharge no visible emissions to the outside air from any part of the operation, or use the methods specified by §61.152 to clean emissions containing particulate asbestos material before they escape to, or are vented to, the outside air.

(f) Maintain records on-site and include the following information:

(1) Results of start-up performance testing and all subsequent performance testing, including operating parameters, feed characteristic, and analyses of output materials.

(2) Results of the composite analyses required during the initial 90 days of operation under §61.155(c).

(3) Results of the monthly composite analyses required under §61.155(d).

(4) Results of continuous monitoring and logs of process operating parameters required under §61.155(c) and (d).

(5) The information on waste shipments received as required in §61.154(e).

(6) For output materials where no analyses were performed to determine the presence of asbestos, record the name and location of the purchaser or disposal site to which the output materials were sold or deposited, and the date of sale or disposal.

(7) Retain records required by paragraph (f) of this section for at least 2 years.

(g) Submit the following reports to the Administrator:

(1) A report for each analysis of product composite samples performed during the initial 90 days of operation.

(2) A quarterly report, including the following information concerning activities during each consecutive 3-month period:

(i) Results of analyses of monthly product composite samples.

(ii) A description of any deviation from the operating parameters established during performance testing, the duration of the deviation, and steps taken to correct the deviation.

(iii) Disposition of any product produced during a period of deviation, including whether it was recycled, disposed of as asbestos-containing waste material, or stored temporarily on-site until analyzed for asbestos content.

(iv) The information on waste disposal activities as required in §61.154(f).

(h) Nonasbestos (asbestos-free) output material is not subject to any of the provisions of this subpart. Output materials in which asbestos is detected, or output materials produced when the operating parameters deviated from those established during the start-up performance testing, unless shown by TEM analysis to be asbestos-free, shall be considered to be asbestos-containing waste and shall be handled and disposed of according to §§61.150 and 61.154 or reprocessed while all of the established operating parameters are being met.

[55 FR 48431, Nov. 20, 1990]

§ 61.156 Cross-reference to other asbestos regulations.

In addition to this subpart, the regulations referenced in Table 1 also apply to asbestos and may be applicable to those sources specified in §§61.142 through 61.151, 61.154, and 61.155 of this subpart. These cross-references are presented for the reader's information and to promote compliance with the cited regulations.

Table 1—Cross-Reference to Other Asbestos Regulations

Agency	CFR citation	Comment
EPA	40 CFR part 763, subpart E	Requires schools to inspect for asbestos and implement response actions and submit asbestos management plans to States. Specifies use of accredited inspectors, air sampling methods, and waste disposal procedures.
	40 CFR part 427	Effluent standards for asbestos manufacturing source categories.
	40 CFR part 763, subpart G	Protects public employees performing asbestos abatement work in States not covered by OSHA asbestos standard.
OSHA	29 CFR 1910.1001	Worker protection measures-engineering controls, worker training, labeling, respiratory protection, bagging of waste, permissible exposure level.
	29 CFR 1926.1101	Worker protection measures for all construction work involving asbestos, including demolition and renovation-work practices, worker training, bagging of waste, permissible exposure level.
MSHA	30 CFR part 56, subpart D	Specifies exposure limits, engineering controls, and respiratory protection measures for workers in surface mines.
	30 CFR part 57, subpart D	Specifies exposure limits, engineering controls, and respiratory protection measures for workers in underground mines.
DOT	49 CFR parts 171 and 172	Regulates the transportation of asbestos-containing waste material. Requires waste containment and shipping papers.

[55 FR 48432, Nov. 20, 1990, as amended at 60 FR 31920, June 19, 1995; 68 FR 54793, Sept. 18, 2003; 69 FR 43324, July 20, 2004]

§ 61.157 Delegation of authority.

(a) In delegating implementation and enforcement authority to a State under section 112(d) of the Act, the authorities contained in paragraph (b) of this section shall be retained by the Administrator and not transferred to a State.

(b) Authorities that will not be delegated to States:

(1) Section 61.149(c)(2)

(2) Section 61.150(a)(4)

(3) Section 61.151(c)

(4) Section 61.152(b)(3)

(5) Section 61.154(d)

(6) Section 61.155(a).

[55 FR 48433, Nov. 20, 1990]

Appendix A to Subpart M of Part 61—Interpretive Rule Governing Roof Removal Operations

I. Applicability of the Asbestos NESHAP

1.1. Asbestos-containing material (ACM) is material containing more than one percent asbestos as determined using the methods specified in appendix E, subpart E, 40 CFR part 763, section 1, Polarized Light Microscopy. The NESHAP classifies ACM as either “friable” or “nonfriable”. Friable ACM is ACM that, when dry, can be crumbled, pulverized or reduced to powder by hand pressure. Nonfriable ACM is ACM that, when dry, cannot be crumbled, pulverized or reduced to powder by hand pressure.

1.2. Nonfriable ACM is further classified as either Category I ACM or Category II ACM. Category I ACM and Category II ACM are distinguished from each other by their potential to release fibers when damaged. Category I ACM includes asbestos-containing gaskets, packings, resilient floor coverings, resilient floor covering mastic, and asphalt roofing products containing more than one percent asbestos. Asphalt roofing products which may contain asbestos include built-up roofing; asphalt-containing single ply membrane systems; asphalt shingles; asphalt-containing underlayment felts; asphalt-containing roof coatings and mastics; and asphalt-containing base flashings. ACM roofing products that use other bituminous or resinous binders (such as coal tars or pitches) are also considered to be Category I ACM. Category II ACM includes all other nonfriable ACM, for example, asbestos-cement (A/C) shingles, A/C tiles, and transite boards or panels containing more than one percent asbestos. Generally speaking, Category II ACM is more likely to become friable when damaged than is Category I ACM. The applicability of the NESHAP to Category I and II ACM depends on: (1) the condition of the material at the time of demolition or renovation, (2) the nature of the operation to which the material will be subjected, (3) the amount of ACM involved.

1.3. Asbestos-containing material regulated under the NESHAP is referred to as “regulated asbestos-containing material” (RACM). RACM is defined in §61.141 of the NESHAP and includes: (1) friable asbestos-containing material; (2) Category I nonfriable ACM that has become friable; (3) Category I nonfriable ACM that has been or will be sanded, ground, cut, or abraded; or (4) Category II nonfriable ACM that has already been or is likely to become crumbled, pulverized, or reduced to powder. If the coverage threshold for RACM is met or exceeded in a renovation or demolition operation, then all friable ACM in the operation, and in certain situations, nonfriable ACM in the operation, are subject to the NESHAP.

A. Threshold Amounts of Asbestos-Containing Roofing Material

1.A.1. The NESHAP does not cover roofing projects on single family homes or on residential buildings containing four or fewer dwelling units. 40 CFR 61.141. For other roofing renovation projects, if the total asbestos-containing roof area undergoing renovation is less than 160 ft², the NESHAP does not apply, regardless of the removal method to be used, the type of material (Category I or II), or its condition (friable versus nonfriable). 40 CFR 61.145(a)(4). However, EPA would recommend the use of methods that damage asbestos-containing roofing material as little as possible. EPA has determined that where a rotating blade (RB) roof cutter or equipment that similarly damages the roofing material is used to remove Category I nonfriable asbestos-containing roofing material, the removal of 5580 ft² of that material will create 160 ft² of RACM. For the purposes of this interpretive rule, “RB roof cutter” means an engine-powered roof cutting machine with one or more rotating cutting blades the edges of which are blunt. (Equipment with blades having sharp or tapered edges, and/or which does not use a rotating blade, is used for “slicing” rather than “cutting” the roofing material; such equipment is not included in the

term "RB roof cutter".) Therefore, it is EPA's interpretation that when an RB roof cutter or equipment that similarly damages the roofing material is used to remove Category I nonfriable asbestos-containing roofing material, any project that is 5580 ft² or greater is subject to the NESHAP; conversely, it is EPA's interpretation that when an RB roof cutter or equipment that similarly damages the roofing material is used to remove Category I nonfriable asbestos-containing roofing material in a roof removal project that is less than 5580 ft², the project is not subject to the NESHAP, except that notification is always required for demolitions. EPA further construes the NESHAP to mean that if slicing or other methods that do not sand, grind, cut or abrade will be used on Category I nonfriable ACM, the NESHAP does not apply, regardless of the area of roof to be removed.

1.A.2. For asbestos cement (A/C) shingles (or other Category II roofing material), if the area of the roofing material to be removed is at least 160 ft² and the removal methods will crumble, pulverize, reduce to powder, or contaminate with RACM (from other ACM that has been crumbled, pulverized or reduced to powder) 160 ft² or more of such roofing material, the removal is subject to the NESHAP. Conversely, if the area of the A/C shingles (or other Category II roofing materials) to be removed is less than 160 ft², the removal is not subject to the NESHAP regardless of the removal method used, except that notification is always required for demolitions. 40 CFR 61.145(a). However, EPA would recommend the use of methods that damage asbestos-containing roofing material as little as possible. If A/C shingles (or other Category II roofing materials) are removed without 160 ft² or more of such roofing material being crumbled, pulverized, reduced to powder, or contaminated with RACM (from other ACM that has been crumbled, pulverized or reduced to powder), the operation is not subject to the NESHAP, even where the total area of the roofing material to be removed exceeds 160 ft²; provided, however, that if the renovation includes other operations involving RACM, the roof removal operation is covered if the total area of RACM from all renovation activities exceeds 160 ft². See the definition of regulated asbestos-containing material (RACM), 40 CFR 61.141.

1.A.3. Only roofing material that meets the definition of ACM can qualify as RACM subject to the NESHAP. Therefore, to determine if a removal operation that meets or exceeds the coverage threshold is subject to the NESHAP, any suspect roofing material (i.e. roofing material that may be ACM) should be tested for asbestos. If any such roofing material contains more than one percent asbestos and if the removal operation is covered by the NESHAP, then EPA must be notified and the work practices in §61.145(c) must be followed. In EPA's view, if a removal operation involves at least the threshold level of suspect material, a roofing contractor may choose not to test for asbestos if the contractor follows the notification and work practice requirements of the NESHAP.

B. A/C Shingle Removal (Category II ACM Removal)

1.B.1. A/C shingles, which are Category II nonfriable ACM, become regulated ACM if the material has a high probability of becoming or has become crumbled, pulverized or reduced to powder by the forces expected to act on the material in the course of demolition or renovation operations. 40 CFR 61.141. However, merely breaking an A/C shingle (or any other category II ACM) that is not friable may not necessarily cause the material to become RACM. A/C shingles are typically nailed to buildings on which they are attached. EPA believes that the extent of breakage that will normally result from carefully removing A/C shingles and lowering the shingles to the ground will not result in crumbling, pulverizing or reducing the shingles to powder. Conversely, the extent of breakage that will normally occur if the A/C shingles are dropped from a building or scraped off of a building with heavy machinery would cause the shingles to become RACM. EPA therefore construes the NESHAP to mean that the removal of A/C shingles that are not friable, using methods that do not crumble, pulverize, or reduce the A/C shingles to powder (such as pry bars, spud bars and shovels to carefully pry the material), is not subject to the NESHAP provided that the A/C shingles are properly handled during and after removal, as discussed in this paragraph and the asbestos NESHAP. This interpretation also applies to other Category II nonfriable asbestos-containing roofing materials.

C. Cutting vs. Slicing and Manual Methods for Removal of Category I ACM

1.C.1. Because of damage to the roofing material, and the potential for fiber release, roof removal operations using rotating blade (RB) roof cutters or other equipment that sand, grind, cut or abrade the roof material are subject to the NESHAP. As EPA interprets the NESHAP, the use of certain manual methods (using equipment such as axes, hatchets, or knives, spud bars, pry bars, and shovels, but not saws) or methods that slice, shear, or punch (using equipment such as a power slicer or power plow) does not constitute "cutting, sanding, grinding or abrading." This is because these methods do not destroy the structural matrix or integrity of the material such that the material is crumbled, pulverized or

reduced to powder. Hence, it is EPA's interpretation that when such methods are used, assuming the roof material is not friable, the removal operation is not subject to the regulation.

1.C.2. Power removers or power tear-off machines are typically used to pry the roofing material up from the deck after the roof membrane has been cut. It is EPA's interpretation that when these machines are used to pry roofing material up, their use is not regulated by the NESHAP.

1.C.3. As noted previously, the NESHAP only applies to the removal of asbestos-containing roofing materials. Thus, the NESHAP does not apply to the use of RB cutters to remove non-asbestos built up roofing (BUR). On roofs containing some asbestos-containing and some non-asbestos-containing materials, coverage under the NESHAP depends on the methods used to remove each type of material in addition to other coverage thresholds specified above. For example, it is not uncommon for existing roofs to be made of non-asbestos BUR and base flashings that do contain asbestos. In that situation, EPA construes the NESHAP to be inapplicable to the removal of the non-asbestos BUR using an RB cutter so long as the RB cutter is not used to cut 5580 ft² or more of the asbestos-containing base flashing or other asbestos-containing material into sections. In addition, the use of methods that slice, shear, punch or pry could then be used to remove the asbestos flashings and not trigger coverage under the NESHAP.

II. Notification

2.1. Notification for a demolition is always required under the NESHAP. However, EPA believes that few roof removal jobs constitute "demolitions" as defined in the NESHAP (§61.141). In particular, it is EPA's view that the removal of roofing systems (i.e., the roof membrane, insulation, surfacing, coatings, flashings, mastic, shingles, and felt underlayment), when such removal is not a part of a demolition project, constitutes a "renovation" under the NESHAP. If the operation is a renovation, and Category I roofing material is being removed using either manual methods or slicing, notification is not required by the NESHAP. If Category II material is not friable and will be removed without crumbling, pulverizing, or reducing it to powder, no notification is required. Also, if the renovation involves less than the threshold area for applicability as discussed above, then no notification is required. However, if a roof removal meets the applicability and threshold requirements under the NESHAP, then EPA (or the delegated agency) must be notified in advance of the removal in accordance with the requirements of §61.145(b), as follows:

- Notification must be given in writing at least 10 working days in advance and must include the information in §61.145(b)(4), except for emergency renovations as discussed below.
- The notice must be updated as necessary, including, for example, when the amount of asbestos-containing roofing material reported changes by 20 percent or more.
- EPA must be notified if the start date of the roof removal changes. If the start date of a roof removal project is changed to an earlier date, EPA must be provided with a written notice of the new start date at least 10 working days in advance. If the start date changes to a later date, EPA must be notified by telephone as soon as possible before the original start date and a written notice must be sent as soon as possible.
- For emergency renovations (as defined in §61.141), where work must begin immediately to avoid safety or public health hazards, equipment damage, or unreasonable financial burden, the notification must be postmarked or delivered to EPA as soon as possible, but no later than the following work day.

III. Emission Control Practices

A. Requirements To Adequately Wet and Discharge No Visible Emission

3.A.1. The principal controls contained in the NESHAP for removal operations include requirements that the affected material be adequately wetted, and that asbestos waste be handled, collected, and disposed of properly. The requirements for disposal of waste materials are discussed separately in section IV below. The emission control requirements discussed in this section III apply only to roof removal operations that are covered by the NESHAP as set forth in Section I above.

3.A.2. For any operation subject to the NESHAP, the regulation (§§61.145(c)(2)(i), (3), (6)(i)) requires

that RACM be adequately wet (as defined in §61.141) during the operation that damages or disturbs the asbestos material until collected for disposal.

3.A.3. When using an RB roof cutter (or any other method that sands, grinds, cuts or abrades the roofing material) to remove Category I asbestos-containing roofing material, the emission control requirements of §61.145(c) apply as discussed in Section I above. EPA will consider a roof removal project to be in compliance with the "adequately wet" and "discharge no visible emission" requirements of the NESHAP if the RB roof cutter is equipped and operated with the following: (1) a blade guard that completely encloses the blade and extends down close to the roof surface; and (2) a device for spraying a fine mist of water inside the blade guard, and which device is in operation during the cutting of the roof.

B. Exemptions From Wetting Requirements

3.B.1. The NESHAP provides that, in certain instances, wetting may not be required during the cutting of Category I asbestos roofing material with an RB roof cutter. If EPA determines in accordance with §61.145(c)(3)(i), that wetting will unavoidably damage the building, equipment inside the building, or will present a safety hazard while stripping the ACM from a facility component that remains in place, the roof removal operation will be exempted from the requirement to wet during cutting. EPA must have sufficient written information on which to base such a decision. Before proceeding with a dry removal, the contractor must have received EPA's written approval. Such exemptions will be made on a case-by-case basis.

3.B.2. It is EPA's view that, in most instances, exemptions from the wetting requirements are not necessary. Where EPA grants an exemption from wetting because of the potential for damage to the building, damage to equipment within the building or a safety hazard, the NESHAP specifies alternative control methods (§61.145(c)(3)(i)(B)). Alternative control methods include (a) the use of local exhaust ventilation systems that capture the dust, and do not produce visible emissions, or (b) methods that are designed and operated in accordance with the requirements of §61.152, or (c) other methods that have received the written approval of EPA. EPA will consider an alternative emission control method in compliance with the NESHAP if the method has received written approval from EPA and the method is being implemented consistent with the approved procedures (§61.145(c)(3)(ii) or §61.152(b)(3)).

3.B.3. An exemption from wetting is also allowed when the air or roof surface temperature at the point of wetting is below freezing, as specified in §61.145(c)(7). If freezing temperatures are indicated as the reason for not wetting, records must be kept of the temperature at the beginning, middle and end of the day on which wetting is not performed and the records of temperature must be retained for at least 2 years. 42 CFR §61.145(c)(7)(iii). It is EPA's interpretation that in such cases, no written application to, or written approval by the Administrator is needed for using emission control methods listed in §61.145(c)(3)(i)(B), or alternative emission control methods that have been previously approved by the Administrator. However, such written application or approval is required for alternative emission control methods that have not been previously approved. Any dust and debris collected from cutting must still be kept wet and placed in containers. All of the other requirements for notification and waste disposal would continue to apply as described elsewhere in this notice and the Asbestos NESHAP.

C. Waste Collection and Handling

3.C.1. It is EPA's interpretation that waste resulting from slicing and other methods that do not cut, grind, sand or abrade Category I nonfriable asbestos-containing roofing material is not subject to the NESHAP and can be disposed of as nonasbestos waste. EPA further construes the NESHAP to provide that if Category II roofing material (such as A/C shingles) is removed and disposed of without crumbling, pulverizing, or reducing it to powder, the waste from the removal is not subject to the NESHAP waste disposal requirements. EPA also interprets the NESHAP to be inapplicable to waste resulting from roof removal operations that do not meet or exceed the coverage thresholds described in section I above. Of course, other State, local, or Federal regulations may apply.

3.C.2. It is EPA's interpretation that when an RB roof cutter, or other method that similarly damages the roofing material, is used to cut Category I asbestos containing roofing material, the damaged material from the cut (the sawdust or debris) is considered asbestos containing waste subject to §61.150 of the NESHAP, provided the coverage thresholds discussed above in section 1 are met or exceeded. This sawdust or debris must be disposed of at a disposal site operated in accordance with the NESHAP. It is also EPA's interpretation of the NESHAP that if the remainder of the roof is free of the sawdust and debris generated by the cutting, or if such sawdust or debris is collected as discussed below in paragraphs 3.C.3, 3.C.4, 3.C.5 and 3.C.6, the remainder of the roof can be disposed of as nonasbestos

waste because it is considered to be Category I nonfriable material (as long as the remainder of the roof is in fact nonasbestos material or if it is Category I asbestos material and the removal methods do not further sand, grind, cut or abrade the roof material). EPA further believes that if the roof is not cleaned of such sawdust or debris, *i.e.*, it is contaminated, then it must be treated as asbestos-containing waste material and be handled in accordance with §61.150.

3.C.3. In order to be in compliance with the NESHAP while using an RB roof cutter (or device that similarly damages the roofing material) to cut Category I asbestos containing roofing material, the dust and debris resulting from the cutting of the roof should be collected as soon as possible after the cutting operation, and kept wet until collected and placed in leak-tight containers. EPA believes that where the blade guard completely encloses the blade and extends down close to the roof surface and is equipped with a device for spraying a fine mist of water inside the blade guard, and the spraying device is in operation during the cutting, most of the dust and debris from cutting will be confined along the cut. The most efficient methods to collect the dust and debris from cutting are to immediately collect or vacuum up the damaged material where it lies along the cut using a filtered vacuum cleaner or debris collector that meets the requirements of 40 CFR 61.152 to clean up as much of the debris as possible, or to gently sweep up the bulk of the debris, and then use a filtered vacuum cleaner that meets the requirements of 40 CFR 61.152 to clean up as much of the remainder of the debris as possible. On smooth surfaced roofs (nonaggregate roofs), sweeping up the debris and then wet wiping the surface may be done in place of using a filtered vacuum cleaner. It is EPA's view that if these decontamination procedures are followed, the remaining roofing material does not have to be collected and disposed of as asbestos waste. Additionally, it is EPA's view that where such decontamination procedures are followed, if the remaining portions of the roof are non-asbestos or Category I nonfriable asbestos material, and if the remaining portions are removed using removal methods that slice, shear, punch or pry, as discussed in section 1.C above, then the remaining portions do not have to be collected and disposed of as asbestos waste and the NESHAP's no visible emissions and adequately wet requirements are not applicable to the removal of the remaining portions. In EPA's interpretation, the failure of a filtered vacuum cleaner or debris collector to collect larger chunks or pieces of damaged roofing material created by the RB roof cutter does not require the remaining roofing material to be handled and disposed of as asbestos waste, provided that such visible chunks or pieces of roofing material are collected (e.g. by gentle sweeping) and disposed of as asbestos waste. Other methods of decontamination may not be adequate, and should be approved by the local delegated agency.

3.C.4. In EPA's interpretation, if the debris from the cutting is not collected immediately, it will be necessary to lightly mist the dust or debris, until it is collected, as discussed above, and placed in containers. The dust or debris should be lightly misted frequently enough to prevent the material from drying, and to prevent airborne emissions, prior to collection as described above. It is EPA's interpretation of the NESHAP that if these procedures are followed, the remaining roofing material does not have to be collected and disposed of as asbestos waste, as long as the remaining roof material is in fact nonasbestos material or if it is Category I asbestos material and the removal methods do not further sand, grind, cut or abrade the roof material.

3.C.5. It is EPA's interpretation that, provided the roofing material is not friable prior to the cutting operation, and provided the roofing material has not been made friable by the cutting operation, the appearance of rough, jagged or damaged edges on the remaining roofing material, due to the use of an RB roof cutter, does not require that such remaining roofing material be handled and disposed of as asbestos waste. In addition, it is also EPA's interpretation that if the sawdust or debris generated by the use of an RB roof cutter has been collected as discussed in paragraphs 3.C.3, 3.C.4 and 3.C.6, the presence of dust along the edge of the remaining roof material does not render such material "friable" for purposes of this interpretive rule or the NESHAP, provided the roofing material is not friable prior to the cutting operation, and provided that the remaining roofing material near the cutline has not been made friable by the cutting operation. Where roofing material near the cutline has been made friable by the use of the RB cutter (*i.e.* where such remaining roofing material near the cutline can be crumbled, pulverized or reduced to powder using hand pressure), it is EPA's interpretation that the use of an encapsulant will ensure that such friable material need not be treated or disposed of as asbestos containing waste material. The encapsulant may be applied to the friable material after the roofing material has been collected into stacks for subsequent disposal as nonasbestos waste. It is EPA's view that if the encapsulation procedure set forth in this paragraph is followed in operations where roofing material near the cutline has been rendered friable by the use of an RB roof cutter, and if the decontamination procedures set forth in paragraph 3.C.3 have been followed, the NESHAP's no visible emissions and adequately wet requirements would be met for the removal, handling and disposal of the remaining roofing material.

3.C.6. As one way to comply with the NESHAP, the dust and debris from cutting can be placed in leak-tight containers, such as plastic bags, and the containers labeled using warning labels required by

OSHA (29 CFR 1926.58). In addition, the containers must have labels that identify the waste generator (such as the name of the roofing contractor, abatement contractor, and/or building owner or operator) and the location of the site at which the waste was generated.

IV. Waste Disposal

A. Disposal Requirements

4.A.1. Section 61.150(b) requires that, as soon as is practical, all collected dust and debris from cutting as well as any contaminated roofing squares, must be taken to a landfill that is operated in accordance with §61.154 or to an EPA-approved site that converts asbestos waste to nonasbestos material in accordance with §61.155. During the loading and unloading of affected waste, asbestos warning signs must be affixed to the vehicles.

B. Waste Shipment Record

4.B.1. For each load of asbestos waste that is regulated under the NESHAP, a waste shipment record (WSR) must be maintained in accordance with §61.150(d). Information that must be maintained for each waste load includes the following:

- Name, address, and telephone number of the waste generator
- Name and address of the local, State, or EPA regional office responsible for administering the asbestos NESHAP program
- Quantity of waste in cubic meters (or cubic yards)
- Name and telephone number of the disposal site operator
- Name and physical site location of the disposal site
- Date transported
- Name, address, and telephone number of the transporter(s)
- Certification that the contents meet all government regulations for transport by highways.

4.B.2. The waste generator is responsible for ensuring that a copy of the WSR is delivered to the disposal site along with the waste shipment. If a copy of the WSR signed by the disposal site operator is not returned to the waste generator within 35 days, the waste generator must contact the transporter and/or the disposal site to determine the status of the waste shipment. 40 CFR 61.150(d)(3). If the signed WSR is not received within 45 days, the waste generator must report, in writing, to the responsible NESHAP program agency and send along a copy of the WSR. 40 CFR 61.150(d)(4). Copies of WSRs, including those signed by the disposal site operator, must be retained for at least 2 years. 40 CFR 61.150(d)(5).

V. Training

5.1. For those roof removals that are subject to the NESHAP, at least one on-site supervisor trained in the provisions of the NESHAP must be present during the removal of the asbestos roofing material. 40 CFR 61.145(c)(8). In EPA's view, this person can be a job foreman, a hired consultant, or someone who can represent the building owner or contractor responsible for the removal. In addition to the initial training requirement, a refresher training course is required every 2 years. The NESHAP training requirements became effective on November 20, 1991.

5.2. Asbestos training courses developed specifically to address compliance with the NESHAP in roofing work, as well as courses developed for other purposes can satisfy this requirement of the NESHAP, as long as the course covers the areas specified in the regulation. EPA believes that Asbestos Hazard Emergency Response Act (AHERA) training courses will, for example, satisfy the NESHAP training

requirements. However, nothing in this interpretive rule or in the NESHAP shall be deemed to require that roofing contractors or roofing workers performing operations covered by the NESHAP must be trained or accredited under AHERA, as amended by the Asbestos School Hazard Abatement Reauthorization Act (ASHARA). Likewise, state or local authorities may independently impose additional training, licensing, or accreditation requirements on roofing contractors performing operations covered by the NESHAP, but such additional training, licensing or accreditation is not called for by this interpretive rule or the federal NESHAP.

5.3. For removal of Category I asbestos containing roofing material where RB roof cutters or equipment that similarly damages the asbestos-containing roofing material are used, the NESHAP training requirements (§61.145(c)(8)) apply as discussed in Section I above. It is EPA's intention that removal of Category I asbestos-containing roofing material using hatchets, axes, knives, and/or the use of spud bars, pry bars and shovels to lift the roofing material, or similar removal methods that slice, punch, or shear the roof membrane are not subject to the training requirements, since these methods do not cause the roof removal to be subject to the NESHAP. Likewise, it is EPA's intention that roof removal operations involving Category II nonfriable ACM are not subject to the training requirements where such operations are not subject to the NESHAP as discussed in section I above.

[59 FR 31158, June 17, 1994, as amended at 60 FR 31920, June 19, 1995]

[Browse Previous](#) | [Browse Next](#)

For questions or comments regarding e-CFR editorial content, features, or design, email ecfr@nara.gov.

For questions concerning e-CFR programming and delivery issues, email webteam@gpo.gov.

[Section 508 / Accessibility](#)

[Home Page](#) > [Executive Branch](#) > [Code of Federal Regulations](#) > [Electronic Code of Federal Regulations](#)

Electronic Code of Federal Regulations

e-CFR
TM

e-CFR Data is current as of August 1, 2007

Title 40: Protection of Environment

PART 61—NATIONAL EMISSION STANDARDS FOR HAZARDOUS AIR POLLUTANTS

[Browse Previous](#) | [Browse Next](#)

Subpart V—National Emission Standard for Equipment Leaks (Fugitive Emission Sources)

Source: 49 FR 23513, June 6, 1984, unless otherwise noted.

§ 61.240 Applicability and designation of sources.

(a) The provisions of this subpart apply to each of the following sources that are intended to operate in volatile hazardous air pollutant (VHAP) service: pumps, compressors, pressure relief devices, sampling connection systems, open-ended valves or lines, valves, connectors, surge control vessels, bottoms receivers, and control devices or systems required by this subpart.

(b) The provisions of this subpart apply to the sources listed in paragraph (a) after the date of promulgation of a specific subpart in part 61.

(c) While the provisions of this subpart are effective, a source to which this subpart applies that is also subject to the provisions of 40 CFR part 60 only will be required to comply with the provisions of this subpart.

(d) *Alternative means of compliance* —(1) *Option to comply with part 65.* Owners or operators may choose to comply with 40 CFR part 65 to satisfy the requirements of §§61.242–1 through 61.247 for equipment that is subject to this subpart and that is part of the same process unit. When choosing to comply with 40 CFR part 65, the requirements of §§61.245(d) and 61.246(i) and (j) still apply. Other provisions applying to owners or operators who choose to comply with 40 CFR part 65 are provided in 40 CFR 65.1.

(2) *Part 65, subpart C or F.* For owners or operators choosing to comply with 40 CFR part 65, each surge control vessel and bottoms receiver subject to this subpart that meets the conditions specified in table 1 or table 2 of this subpart shall meet the requirements for storage vessels in 40 CFR part 65, subpart C; all other equipment subject to this subpart shall meet the requirements in 40 CFR part 65, subpart F.

(3) *Part 61, subpart A.* Owners or operators who choose to comply with 40 CFR part 65, subpart C or F, must also comply with §§61.01, 61.02, 61.05 through 61.08, 61.10(b) through (d), 61.11, and 61.15 for that equipment. All sections and paragraphs of subpart A of this part that are not mentioned in this paragraph (d)(3) do not apply to owners or operators of equipment subject to this subpart complying with 40 CFR part 65, subpart C or F, except that provisions required to be met prior to implementing 40 CFR part 65 still apply. Owners and operators who choose to comply with 40 CFR part 65, subpart C or F, must comply with 40 CFR part 65, subpart A.

(4) *Rules referencing this subpart.* Owners or operators referenced to this subpart from subpart F or J of

this part may choose to comply with 40 CFR part 65 for all equipment listed in paragraph (a) of this section.

[49 FR 23513, June 6, 1984, as amended at 65 FR 78280, Dec. 14, 2000]

§ 61.241 Definitions.

As used in this subpart, all terms not defined herein shall have the meaning given them in the Act, in subpart A of part 61, or in specific subparts of part 61; and the following terms shall have specific meaning given them:

Bottoms receiver means a tank that collects distillation bottoms before the stream is sent for storage or for further downstream processing.

Closed-vent system means a system that is not open to atmosphere and that is composed of hard-piping, ductwork, connections, and, if necessary, flow-inducing devices that transport gas or vapor from a piece or pieces of equipment to a control device or back to a process.

Connector means flanged, screwed, welded, or other joined fittings used to connect two pipe lines or a pipe line and a piece of equipment. For the purpose of reporting and recordkeeping, connector means flanged fittings that are not covered by insulation or other materials that prevent location of the fittings.

Control device means an enclosed combustion device, vapor recovery system, or flare.

Double block and bleed system means two block valves connected in series with a bleed valve or line that can vent the line between the two block valves.

Duct work means a conveyance system such as those commonly used for heating and ventilation systems. It is often made of sheet metal and often has sections connected by screws or crimping. Hard-piping is not ductwork.

Equipment means each pump, compressor, pressure relief device, sampling connection system, open-ended valve or line, valve, connector, surge control vessel, bottoms receiver in VHAP service, and any control devices or systems required by this subpart.

First attempt at repair means to take rapid action for the purpose of stopping or reducing leakage of organic material to atmosphere using best practices.

In gas/vapor service means that a piece of equipment contains process fluid that is in the gaseous state at operating conditions.

Fuel gas means gases that are combusted to derive useful work or heat.

Fuel gas system means the offsite and onsite piping and flow and pressure control system that gathers gaseous stream(s) generated by onsite operations, may blend them with other sources of gas, and transports the gaseous stream for use as fuel gas in combustion devices or in-process combustion equipment, such as furnaces and gas turbines, either singly or in combination.

Hard-piping means pipe or tubing that is manufactured and properly installed using good engineering judgement and standards such as ASME B31.3, Process Piping (available from the American Society of Mechanical Engineers, PO Box 2900, Fairfield, NJ 07007–2900).

In liquid service means that a piece of equipment is not in gas/vapor service.

In-situ sampling systems means nonextractive samplers or in-line samplers.

In vacuum service means that equipment is operating at an internal pressure which is at least 5 kilopascals (kPa) (0.7 psia) below ambient pressure.

In VHAP service means that a piece of equipment either contains or contacts a fluid (liquid or gas) that is at least 10 percent by weight a volatile hazardous air pollutant (VHAP) as determined according to the provisions of §61.245(d). The provisions of §61.245(d) also specify how to determine that a piece of equipment is not in VHAP service.

In VOC service means, for the purposes of this subpart, that (a) the piece of equipment contains or contacts a process fluid that is at least 10 percent VOC by weight (see 40 CFR 60.2 for the definition of volatile organic compound or VOC and 40 CFR 60.485(d) to determine whether a piece of equipment is not in VOC service) and (b) the piece of equipment is not in heavy liquid service as defined in 40 CFR 60.481.

Maximum true vapor pressure means the equilibrium partial pressure exerted by the total VHAP in the stored or transferred liquid at the temperature equal to the highest calendar-month average of the liquid storage or transfer temperature for liquids stored or transferred above or below the ambient temperature or at the local maximum monthly average temperature as reported by the National Weather Service for liquids stored or transferred at the ambient temperature, as determined:

- (1) In accordance with methods described in American Petroleum Institute Publication 2517, Evaporative Loss From External Floating-Roof Tanks (incorporated by reference as specified in §61.18); or
- (2) As obtained from standard reference texts; or
- (3) As determined by the American Society for Testing and Materials Method D2879–83, Standard Test Method for Vapor Pressure-Temperature Relationship and Initial Decomposition Temperature of Liquids by Isoteniscope (incorporated by reference as specified in §61.18); or
- (4) Any other method approved by the Administrator.

Open-ended valve or line means any valve, except pressure relief valves, having one side of the valve seat in contact with process fluid and one side open to atmosphere, either directly or through open piping.

Pressure release means the emission of materials resulting from the system pressure being greater than the set pressure of the pressure relief device.

Process unit means equipment assembled to produce a VHAP or its derivatives as intermediates or final products, or equipment assembled to use a VHAP in the production of a product. A process unit can operate independently if supplied with sufficient feed or raw materials and sufficient product storage facilities.

Process unit shutdown means a work practice or operational procedure that stops production from a process unit or part of a process unit. An unscheduled work practice or operational procedure that stops production from a process unit or part of a process unit for less than 24 hours is not a process unit shutdown. The use of spare equipment and technically feasible bypassing of equipment without stopping production are not process unit shutdowns.

Repaired means that equipment is adjusted, or otherwise altered, to eliminate a leak.

Sampling connection system means an assembly of equipment within a process unit used during periods of representative operation to take samples of the process fluid. Equipment used to take non-routine grab samples is not considered a sampling connection system.

Semiannual means a 6-month period; the first semiannual period concludes on the last day of the last month during the 180 days following initial startup for new sources; and the first semiannual period concludes on the last day of the last full month during the 180 days after the effective date of a specific subpart that references this subpart for existing sources.

Sensor means a device that measures a physical quantity or the change in a physical quantity, such as temperature, pressure, flow rate, pH, or liquid level.

Stuffing box pressure means the fluid (liquid or gas) pressure inside the casing or housing of a piece of equipment, on the process side of the inboard seal.

Surge control vessel means feed drums, recycle drums, and intermediate vessels. Surge control vessels are used within a process unit when in-process storage, mixing, or management of flow rates of volumes is needed on a recurring or ongoing basis to assist in production of a product.

Volatile hazardous air pollutant or *VHAP* means a substance regulated under this part for which a standard for equipment leaks of the substance has been proposed and promulgated. Benzene is a VHAP. Vinyl chloride is a VHAP.

[49 FR 23513, June 6, 1984; 49 FR 38946, Oct. 2, 1984, as amended at 51 FR 34915, Sept. 30, 1986; 54 FR 38076, Sept. 14, 1989; 65 FR 62158, Oct. 17, 2000; 65 FR 78280, Dec. 14, 2000]

§ 61.242-1 Standards: General.

(a) Each owner or operator subject to the provisions of this subpart shall demonstrate compliance with the requirements of §§61.242-1 to 61.242-11 for each new and existing source as required in 40 CFR 61.05, except as provided in §§61.243 and 61.244.

(b) Compliance with this subpart will be determined by review of records, review of performance test results, and inspection using the methods and procedures specified in §61.245.

(c)(1) An owner or operator may request a determination of alternative means of emission limitation to the requirements of §§61.242-2, 61.242-3, 61.242-5, 61.242-6, 61.242-7, 61.242-8, 61.242-9 and 61.242-11 as provided in §61.244.

(2) If the Administrator makes a determination that a means of emission limitation is at least a permissible alternative to the requirements of §61.242-2, 61.242-3, 61.242-5, 61.242-6, 61.242-7, 61.242-8, 61.242-9 or 61.242-11, an owner or operator shall comply with the requirements of that determination.

(d) Each piece of equipment to which this subpart applies shall be marked in such a manner that it can be distinguished readily from other pieces of equipment.

(e) Equipment that is in vacuum service is excluded from the requirements of §61.242-2, to §61.242-11 if it is identified as required in §61.246(e)(5).

[49 FR 23513, June 6, 1984; 49 FR 38946, Oct. 2, 1984]

§ 61.242-2 Standards: Pumps.

(a)(1) Each pump shall be monitored monthly to detect leaks by the methods specified in §61.245(b), except as provided in §61.242-1(c) and paragraphs (d), (e), (f) and (g) of this section.

(2) Each pump shall be checked by visual inspection each calendar week for indications of liquids dripping from the pump seal.

(b)(1) If an instrument reading of 10,000 ppm or greater is measured, a leak is detected.

(2) If there are indications of liquids dripping from the pump seal, a leak is detected.

(c)(1) When a leak is detected, it shall be repaired as soon as practicable, but not later than 15 calendar days after it is detected, except as provided in §61.242-10.

(2) A first attempt at repair shall be made no later than 5 calendar days after each leak is detected.

(d) Each pump equipped with a dual mechanical seal system that includes a barrier fluid system is

exempt from the requirements of paragraphs (a) and (b) of this section, provided the following requirements are met:

(1) Each dual mechanical seal system is:

(i) Operated with the barrier fluid at a pressure that is at all times greater than the pump stuffing box pressure; or

(ii) Equipped with a barrier fluid degassing reservoir that is routed to a process or fuel gas system or connected by a closed-vent system to a control device that complies with the requirements of §61.242-11; or

(iii) Equipped with a system that purges the barrier fluid into a process stream with zero VHAP emissions to atmosphere.

(2) The barrier fluid is not in VHAP service and, if the pump is covered by standards under 40 CFR part 60, is not in VOC service.

(3) Each barrier fluid system is equipped with a sensor that will detect failure of the seal system, the barrier fluid system, or both.

(4) Each pump is checked by visual inspection each calendar week for indications of liquids dripping from the pump seal.

(i) If there are indications of liquid dripping from the pump seal at the time of the weekly inspection, the pump shall be monitored as specified in §61.245 to determine the presence of VOC and VHAP in the barrier fluid.

(ii) If the monitor reading (taking into account any background readings) indicates the presence of VHAP, a leak is detected. For the purpose of this paragraph, the monitor may be calibrated with VHAP, or may employ a gas chromatography column to limit the response of the monitor to VHAP, at the option of the owner or operator.

(iii) If an instrument reading of 10,000 ppm or greater (total VOC) is measured, a leak is detected.

(5) Each sensor as described in paragraph (d)(3) of this section is checked daily or is equipped with an audible alarm.

(6)(i) The owner or operator determines, based on design considerations and operating experience, criteria applicable to the presence and frequency of drips and to the sensor that indicates failure of the seal system, the barrier fluid system, or both.

(ii) If indications of liquids dripping from the pump seal exceed the criteria established in paragraph (d)(6)(i) of this section, or if, based on the criteria established in paragraph (d)(6)(i) of this section, the sensor indicates failure of the seal system, the barrier fluid system, or both, a leak is detected.

(iii) When a leak is detected, it shall be repaired as soon as practicable, but no later than 15 calendar days after it is detected, except as provided in §61.242-10.

(iv) A first attempt at repair shall be made no later than five calendar days after each leak is detected.

(e) Any pump that is designated, as described in §61.246(e)(2), for no detectable emissions, as indicated by an instrument reading of less than 500 ppm above background, is exempt from the requirements of paragraphs (a), (c), and (d) if the pump:

(1) Has no externally actuated shaft penetrating the pump housing,

(2) Is demonstrated to be operating with no detectable emissions, as indicated by an instrument reading of less than 500 ppm above background, as measured by the method specified in §61.245(c), and

(3) Is tested for compliance with paragraph (e)(2) initially upon designation, annually, and at other times requested by the Administrator.

(f) If any pump is equipped with a closed-vent system capable of capturing and transporting any leakage from the seal or seals to a process or fuel gas system or to a control device that complies with the requirements of §61.242–11, it is exempt from the requirements of paragraphs (a) through (e) of this section.

(g) Any pump that is designated, as described in §61.246(f)(1), as an unsafe-to-monitor pump is exempt from the monitoring and inspection requirements of paragraphs (a) and (d)(4) through (6) of this section if:

(1) The owner or operator of the pump demonstrates that the pump is unsafe-to-monitor because monitoring personnel would be exposed to an immediate danger as a consequence of complying with paragraph (a) of this section; and

(2) The owner or operator of the pump has a written plan that requires monitoring of the pump as frequently as practicable during safe-to-monitor times but not more frequently than the periodic monitoring schedule otherwise applicable, and repair of the equipment according to the procedures in paragraph (c) of this section if a leak is detected.

(h) Any pump that is located within the boundary of an unmanned plant site is exempt from the weekly visual inspection requirement of paragraphs (a)(2) and (d)(4) of this section, and the daily requirements of paragraph (d)(5) of this section, provided that each pump is visually inspected as often as practicable and at least monthly.

[49 FR 23513, June 6, 1984, as amended at 49 FR 38946, Oct. 2, 1984; 55 FR 28349, July 10, 1990; 65 FR 78281, Dec. 14, 2000]

§ 61.242-3 Standards: Compressors.

(a) Each compressor shall be equipped with a seal system that includes a barrier fluid system and that prevents leakage of process fluid to atmosphere, except as provided in §61.242–1(c) and paragraphs (h) and (i) of this section.

(b) Each compressor seal system as required in paragraph (a) shall be:

(1) Operated with the barrier fluid at a pressure that is greater than the compressor stuffing box pressure; or

(2) Equipped with a barrier fluid system degassing reservoir that is routed to a process or fuel gas system or connected by a closed-vent system to a control device that complies with the requirements of §61.242–11; or

(3) Equipped with a system that purges the barrier fluid into a process stream with zero VHAP emissions to atmosphere.

(c) The barrier fluid shall not be in VHAP service and, if the compressor is covered by standards under 40 CFR part 60, shall not be in VOC service.

(d) Each barrier fluid system as described in paragraphs (a)–(c) of this section shall be equipped with a sensor that will detect failure of the seal system, barrier fluid system, or both.

(e)(1) Each sensor as required in paragraph (d) of this section shall be checked daily or shall be equipped with an audible alarm unless the compressor is located within the boundary of an unmanned plant site.

(2) The owner or operator shall determine, based on design considerations and operating experience, a criterion that indicates failure of the seal system, the barrier fluid system, or both.

(f) If the sensor indicates failure of the seal system, the barrier fluid system, or both based on the criterion determined under paragraph (e)(2) of this section, a leak is detected.

(g)(1) When a leak is detected, it shall be repaired as soon as practicable, but not later than 15 calendar days after it is detected, except as provided in §61.242-10.

(2) A first attempt at repair shall be made no later than 5 calendar days after each leak is detected.

(h) A compressor is exempt from the requirements of paragraphs (a) and (b) of this section if it is equipped with a closed-vent system to capture and transport leakage from the compressor drive shaft back to a process or fuel gas system or to a control device that complies with the requirements of §61.242-11, except as provided in paragraph (i) of this section.

(i) Any Compressor that is designated, as described in §61.246(e)(2), for no detectable emission as indicated by an instrument reading of less than 500 ppm above background is exempt from the requirements of paragraphs (a)-(h) if the compressor:

(1) Is demonstrated to be operating with no detectable emissions, as indicated by an instrument reading of less than 500 ppm above background, as measured by the method specified in §61.245(c); and

(2) Is tested for compliance with paragraph (i)(1) initially upon designation, annually, and at other times requested by the Administrator.

[49 FR 23513, June 6, 1984; 49 FR 38946, Oct. 2, 1984, as amended at 65 FR 78281, Dec. 14, 2000]

§ 61.242-4 Standards: Pressure relief devices in gas/vapor service.

(a) Except during pressure releases, each pressure relief device in gas/vapor service shall be operated with no detectable emissions, as indicated by an instrument reading of less than 500 ppm above background, as measured by the method specified in §61.245(c).

(b)(1) After each pressure release, the pressure relief device shall be returned to a condition of no detectable emissions, as indicated by an instrument reading of less than 500 ppm above background, as soon as practicable, but no later than 5 calendar days after each pressure release, except as provided in §61.242-10.

(2) No later than 5 calendar days after the pressure release, the pressure relief device shall be monitored to confirm the condition of no detectable emissions, as indicated by an instrument reading of less than 500 ppm above background, as measured by the method specified in §61.245(c).

(c) Any pressure relief device that is routed to a process or fuel gas system or equipped with a closed-vent system capable of capturing and transporting leakage from the pressure relief device to a control device as described in §61.242-11 is exempt from the requirements of paragraphs (a) and (b) of this section.

(d)(1) Any pressure relief device that is equipped with a rupture disk upstream of the pressure relief device is exempt from the requirements of paragraphs (a) and (b) of this section, provided the owner or operator complies with the requirements in paragraph (d)(2) of this section.

(2) After each pressure release, a new rupture disk shall be installed upstream of the pressure relief device as soon as practicable, but no later than 5 calendar days after each pressure release, except as provided in §61.242-10.

[49 FR 23513, June 6, 1984; 49 FR 38946, Oct. 2, 1984, as amended at 65 FR 78281, Dec. 14, 2000]

§ 61.242-5 Standards: Sampling connecting systems.

(a) Each sampling connection system shall be equipped with a closed-purge, closed-loop, or closed vent system, except as provided in §61.242-1(c). Gases displaced during filling of the sample container are

not required to be collected or captured.

(b) Each closed-purge, closed-loop, or closed vent system as required in paragraph (a) of this section shall comply with the requirements specified in paragraphs (b)(1) through (4) of this section:

(1) Return the purged process fluid directly to the process line; or

(2) Collect and recycle the purged process fluid; or

(3) Be designed and operated to capture and transport all the purged process fluid to a control device that complies with the requirements of §61.242-11; or

(4) Collect, store, and transport the purged process fluid to any of the following systems or facilities:

(i) A waste management unit as defined in 40 CFR 63.111 if the waste management unit is subject to and operated in compliance with the provisions of 40 CFR part 63, subpart G, applicable to Group 1 wastewater streams; or

(ii) A treatment, storage, or disposal facility subject to regulation under 40 CFR part 262, 264, 265, or 266; or

(iii) A facility permitted, licensed, or registered by a State to manage municipal or industrial solid waste, if the process fluids are not hazardous waste as defined in 40 CFR part 261.

(c) In-situ sampling systems and sampling systems without purges are exempt from the requirements of paragraphs (a) and (b) of this section.

[65 FR 78281, Dec. 14, 2000]

§ 61.242-6 Standards: Open-ended valves or lines.

(a)(1) Each open-ended valve or line shall be equipped with a cap, blind flange, plug, or a second valve, except as provided in §61.242-1(c).

(2) The cap, blind flange, plug, or second valve shall seal the open end at all times except during operations requiring process fluid flow through the open-ended valve or line.

(b) Each open-ended valve or line equipped with a second valve shall be operated in a manner such that the valve on the process fluid end is closed before the second valve is closed.

(c) When a double block and bleed system is being used, the bleed valve or line may remain open during operations that require venting the line between the block valves but shall comply with paragraph (a) at all other times.

(d) Open-ended valves or lines in an emergency shutdown system which are designed to open automatically in the event of a process upset are exempt from the requirements of paragraphs (a), (b) and (c) of this section.

(e) Open-ended valves or lines containing materials which would autocatalytically polymerize or would present an explosion, serious overpressure, or other safety hazard if capped or equipped with a double block and bleed system as specified in paragraphs (a) through (c) of this section are exempt from the requirements of paragraphs (a) through (c) of this section.

[49 FR 23513, June 6, 1984, as amended at 65 FR 78282, Dec. 14, 2000]

§ 61.242-7 Standards: Valves.

(a) Each valve shall be monitored monthly to detect leaks by the method specified in §61.245(b) and

shall comply with paragraphs (b)–(e), except as provided in paragraphs (f), (g), and (h) of this section, §61.243–1 or §61.243–2, and §61.242–1(c).

(b) If an instrument reading of 10,000 ppm or greater is measured, a leak is detected.

(c)(1) Any valve for which a leak is not detected for 2 successive months may be monitored the first month of every quarter, beginning with the next quarter, until a leak is detected.

(2) If a leak is detected, the valve shall be monitored monthly until a leak is not detected for 2 successive months.

(d)(1) When a leak is detected, it shall be repaired as soon as practicable, but no later than 15 calendar days after the leak is detected, except as provided in §61.242–10.

(2) A first attempt at repair shall be made no later than 5 calendar days after each leak is detected.

(e) First attempts at repair include, but are not limited to, the following best practices where practicable:

(1) Tightening of bonnet bolts;

(2) Replacement of bonnet bolts;

(3) Tightening of packing gland nuts; and

(4) Injection of lubricant into lubricated packing.

(f) Any valve that is designated, as described in §61.246(e)(2), for no detectable emissions, as indicated by an instrument reading of less than 500 ppm above background, is exempt from the requirements of paragraph (a) if the valve:

(1) Has no external actuating mechanism in contact with the process fluid;

(2) Is operated with emissions less than 500 ppm above background, as measured by the method specified in §61.245(c); and

(3) Is tested for compliance with paragraph (f)(2) initially upon designation, annually, and at other times requested by the Administrator.

(g) Any valve that is designated, as described in §61.246(f)(1), as an unsafe-to-monitor valve is exempt from the requirements of paragraph (a) if:

(1) The owner or operator of the valve demonstrates that the valve is unsafe to monitor because monitoring personnel would be exposed to an immediate danger as a consequence of complying with paragraph (a); and

(2) The owner or operator of the valve has a written plan that requires monitoring of the valve as frequent as practicable during safe-to-monitor times.

(h) Any valve that is designated, as described in §61.246(f)(2), as a difficult-to-monitor valve is exempt from the requirements of paragraph (a) if:

(1) The owner or operator of the valve demonstrates that the valve cannot be monitored without elevating the monitoring personnel more than 2 meters above a support surface;

(2) The process unit within which the valve is located is an existing process unit; and

(3) The owner or operator of the valve follows a written plan that requires monitoring of the valve at least once per calendar year.

§ 61.242-8 Standards: Pressure relief services in liquid service and connectors.

(a) If evidence of a potential leak is found by visual, audible, olfactory, or any other detection method at pressure relief devices in liquid service and connectors, the owner or operator shall follow either one of the following procedures, except as provided in §61.242-1(c):

(1) The owner or operator shall monitor the equipment within 5 days by the method specified in §61.245 (b) and shall comply with the requirements of paragraphs (b) through (d) of this section.

(2) The owner or operator shall eliminate the visual, audible, olfactory, or other indication of a potential leak.

(b) If an instrument reading of 10,000 ppm or greater is measured, a leak is detected.

(c)(1) When a leak is detected, it shall be repaired as soon as practicable, but not later than 15 calendar days after it is detected, except as provided in §61.242-10.

(2) The first attempt at repair shall be made no later than 5 calendar days after each leak is detected.

(d) First attempts at repair include, but are not limited to, the best practices described under §61.242-7 (e).

[49 FR 23513, June 6, 1984; 49 FR 38946, Oct. 2, 1984, as amended at 65 FR 78282, Dec. 14, 2000]

§ 61.242-9 Standards: Surge control vessels and bottoms receivers.

Each surge control vessel or bottoms receiver that is not routed back to the process and that meets the conditions specified in table 1 or table 2 of this subpart shall be equipped with a closed-vent system capable of capturing and transporting any leakage from the vessel back to the process or to a control device as described in §61.242-11, except as provided in §61.242-1(c); or comply with the requirements of 40 CFR 63.119(b) or (c).

[65 FR 78282, Dec. 14, 2000]

§ 61.242-10 Standards: Delay of repair.

(a) Delay of repair of equipment for which leaks have been detected will be allowed if repair within 15 days is technically infeasible without a process unit shutdown. Repair of this equipment shall occur before the end of the next process unit shutdown.

(b) Delay of repair of equipment for which leaks have been detected will be allowed for equipment that is isolated from the process and that does not remain in VHAP service.

(c) Delay of repair for valves will be allowed if:

(1) The owner or operator demonstrates that emissions of purged material resulting from immediate repair are greater than the fugitive emissions likely to result from delay of repair, and

(2) When repair procedures are effected, the purged material is collected and destroyed or recovered in a control device complying with §61.242-11.

(d) Delay of repair for pumps will be allowed if:

(1) Repair requires the use of a dual mechanical seal system that includes a barrier fluid system, and

(2) Repair is completed as soon as practicable, but not later than 6 months after the leak was detected.

(i) If a vapor collection system or closed vent system is operated under a vacuum, it is exempt from the inspection requirements of paragraphs (f)(1)(i) and (2) of this section.

(j) Any parts of the closed vent system that are designated, as described in paragraph (l)(1) of this section, as unsafe-to-inspect are exempt from the inspection requirements of paragraphs (f)(1)(i) and (2) of this section if they comply with the following requirements:

(1) The owner or operator determines that the equipment is unsafe-to-inspect because inspecting personnel would be exposed to an imminent or potential danger as a consequence of complying with paragraph (f)(1)(i) or (2) of this section; and

(2) The owner or operator has a written plan that requires inspection of the equipment as frequently as practicable during safe-to-inspect times.

(k) Any parts of the closed vent system that are designated, as described in paragraph (l)(2) of this section, as difficult-to-inspect are exempt from the inspection requirements of paragraphs (f)(1)(i) and (2) of this section if they comply with the following requirements:

(1) The owner or operator determines that the equipment cannot be inspected without elevating the inspecting personnel more than 2 meters above a support surface; and

(2) The owner or operator has a written plan that requires inspection of the equipment at least once every 5 years. A closed vent system is exempt from inspection if it is operated under a vacuum.

(l) The owner or operator shall record the following information:

(1) Identification of all parts of the closed vent system that are designated as unsafe-to-inspect, an explanation of why the equipment is unsafe-to-inspect, and the plan for inspecting the equipment.

(2) Identification of all parts of the closed vent system that are designated as difficult-to-inspect, an explanation of why the equipment is difficult-to-inspect, and the plan for inspecting the equipment.

(3) For each inspection during which a leak is detected, a record of the information specified in §61.246 (c).

(4) For each inspection conducted in accordance with §61.245(b) during which no leaks are detected, a record that the inspection was performed, the date of the inspection, and a statement that no leaks were detected.

(5) For each visual inspection conducted in accordance with paragraph (f)(1)(ii) of this section during which no leaks are detected, a record that the inspection was performed, the date of the inspection, and a statement that no leaks were detected.

(m) Closed vent systems and control devices used to comply with provisions of this subpart shall be operated at all times when emissions may be vented to them.

[49 FR 23513, June 6, 1984; 49 FR 38946, Oct. 2, 1984, as amended at 51 FR 2702, Jan. 21, 1986; 65 FR 62158, Oct. 17, 2000; 65 FR 78282, Dec. 14, 2000]

§ 61.243-1 Alternative standards for valves in VHAP service—allowable percentage of valves leaking.

(a) An owner or operator may elect to have all valves within a process unit to comply with an allowable percentage of valves leaking of equal to or less than 2.0 percent.

(b) The following requirements shall be met if an owner or operator decides to comply with an allowable percentage of valves leaking:

(1) An owner or operator must notify the Administrator that the owner or operator has elected to have all

valves within a process unit to comply with the allowable percentage of valves leaking before implementing this alternative standard, as specified in §61.247(d).

(2) A performance test as specified in paragraph (c) of this section shall be conducted initially upon designation, annually, and at other times requested by the Administrator.

(3) If a valve leak is detected, it shall be repaired in accordance with §61.242–7(d) and (e).

(c) Performance tests shall be conducted in the following manner:

(1) All valves in VHAP service within the process unit shall be monitored within 1 week by the methods specified in §61.245(b).

(2) If an instrument reading of 10,000 ppm or greater is measured, a leak is detected.

(3) The leak percentage shall be determined by dividing the number of valves in VHAP service for which leaks are detected by the number of valves in VHAP service within the process unit.

(d) Owner or operators who elect to have all valves comply with this alternative standard shall not have a process unit with a leak percentage greater than 2.0 percent.

(e) If an owner or operator decides no longer to comply with §61.243–1, the owner or operator must notify the Administrator in writing that the work practice standard described in §61.242–7(a)–(e) will be followed.

§ 61.243-2 Alternative standards for valves in VHAP service—skip period leak detection and repair.

(a)(1) An owner or operator may elect for all valves within a process unit to comply with one of the alternative work practices specified in paragraphs (b)(2) and (3) of this section.

(2) An owner or operator must notify the Administrator before implementing one of the alternative work practices, as specified in §61.247(d).

(b)(1) An owner or operator shall comply initially with the requirements for valves, as described in §61.242–7.

(2) After 2 consecutive quarterly leak detection periods with the percentage of valves leaking equal to or less than 2.0, an owner or operator may begin to skip one of the quarterly leak detection periods for the valves in VHAP service.

(3) After five consecutive quarterly leak detection periods with the percentage of valves leaking equal to or less than 2.0, an owner or operator may begin to skip three of the quarterly leak detection periods for the valves in VHAP service.

(4) If the percentage of valves leaking is greater than 2.0, the owner or operator shall comply with the requirements as described in §61.242–7 but may again elect to use this section.

[49 FR 23513, June 6, 1984, as amended at 65 FR 62158, Oct. 17, 2000]

§ 61.244 Alternative means of emission limitation.

(a) Permission to use an alternative means of emission limitation under section 112(e)(3) of the Clean Air Act shall be governed by the following procedures:

(b) Where the standard is an equipment, design, or operational requirement:

(1) Each owner or operator applying for permission shall be responsible for collecting and verifying test

data for an alternative means of emission limitation to test data for the equipment, design, and operational requirements.

(2) The Administrator may condition the permission on requirements that may be necessary to assure operation and maintenance to achieve the same emission reduction as the equipment, design, and operational requirements.

(c) Where the standard is a work practice:

(1) Each owner or operator applying for permission shall be responsible for collecting and verifying test data for an alternative means of emission limitation.

(2) For each source for which permission is requested, the emission reduction achieved by the required work practices shall be demonstrated for a minimum period of 12 months.

(3) For each source for which permission is requested, the emission reduction achieved by the alternative means of emission limitation shall be demonstrated.

(4) Each owner or operator applying for permission shall commit in writing each source to work practices that provide for emission reductions equal to or greater than the emission reductions achieved by the required work practices.

(5) The Administrator will compare the demonstrated emission reduction for the alternative means of emission limitation to the demonstrated emission reduction for the required work practices and will consider the commitment in paragraph (c)(4).

(6) The Administrator may condition the permission on requirements that may be necessary to assure operation and maintenance to achieve the same emission reduction as the required work practices of this subpart.

(d) An owner or operator may offer a unique approach to demonstrate the alternative means of emission limitation.

(e)(1) Manufacturers of equipment used to control equipment leaks of a VHAP may apply to the Administrator for permission for an alternative means of emission limitation that achieves a reduction in emissions of the VHAP achieved by the equipment, design, and operational requirements of this subpart.

(2) The Administrator will grant permission according to the provisions of paragraphs (b), (c), and (d).

[49 FR 23513, June 6, 1984, as amended at 65 FR 62158, Oct. 17, 2000]

§ 61.245 Test methods and procedures.

(a) Each owner or operator subject to the provisions of this subpart shall comply with the test methods and procedures requirements provided in this section.

(b) Monitoring, as required in §§61.242, 61.243, 61.244, and 61.135, shall comply with the following requirements:

(1) Monitoring shall comply with Method 21 of appendix A of 40 CFR part 60.

(2) The detection instrument shall meet the performance criteria of Method 21.

(3) The instrument shall be calibrated before use on each day of its use by the procedures specified in Method 21.

(4) Calibration gases shall be:

(i) Zero air (less than 10 ppm of hydrocarbon in air); and

(ii) A mixture of methane or n-hexane and air at a concentration of approximately, but less than, 10,000 ppm methane or n-hexane.

(5) The instrument probe shall be traversed around all potential leak interfaces as close to the interface as possible as described in Method 21.

(c) When equipment is tested for compliance with or monitored for no detectable emissions, the owner or operator shall comply with the following requirements:

(1) The requirements of paragraphs (b) (1) through (4) shall apply.

(2) The background level shall be determined, as set forth in Method 21.

(3) The instrument probe shall be traversed around all potential leak interfaces as close to the interface as possible as described in Method 21.

(4) The arithmetic difference between the maximum concentration indicated by the instrument and the background level is compared with 500 ppm for determining compliance.

(d)(1) Each piece of equipment within a process unit that can conceivably contain equipment in VHAP service is presumed to be in VHAP service unless an owner or operator demonstrates that the piece of equipment is not in VHAP service. For a piece of equipment to be considered not in VHAP service, it must be determined that the percent VHAP content can be reasonably expected never to exceed 10 percent by weight. For purposes of determining the percent VHAP content of the process fluid that is contained in or contacts equipment, procedures that conform to the methods described in ASTM Method D-2267 (incorporated by the reference as specified in §61.18) shall be used.

(2)(i) An owner or operator may use engineering judgment rather than the procedures in paragraph (d) (1) of this section to demonstrate that the percent VHAP content does not exceed 10 percent by weight, provided that the engineering judgment demonstrates that the VHAP content clearly does not exceed 10 percent by weight. When an owner or operator and the Administrator do not agree on whether a piece of equipment is not in VHAP service, however, the procedures in paragraph (d)(1) of this section shall be used to resolve the disagreement.

(ii) If an owner or operator determines that a piece of equipment is in VHAP service, the determination can be revised only after following the procedures in paragraph (d)(1) of this section.

(3) Samples used in determining the percent VHAP content shall be representative of the process fluid that is contained in or contacts the equipment or the gas being combusted in the flare.

(e)(1) Method 22 of appendix A of 40 CFR part 60 shall be used to determine compliance of flares with the visible emission provisions of this subpart.

(2) The presence of a flare pilot flame shall be monitored using a thermocouple or any other equivalent device to detect the presence of a flame.

(3) The net heating value of the gas being combusted in a flare shall be calculated using the following equation:

$$H_T = K \left(\sum_{i=1}^n C_i H_i \right)$$

Where:

H_T = Net heating value of the sample, MJ/scm (BTU/scf); where the net enthalpy per mole of

offgas is based on combustion at 25 °C and 760 mm Hg (77 °F and 14.7 psi), but the standard temperature for determining the volume corresponding to one mole is 20 °C (68 °F).

K = conversion constant, 1.740×10^7 (g-mole) (MJ)/(ppm-scm-kcal) (metric units); or 4.674×10^8 ((g-mole) (Btu)/(ppm-scf-kcal)) (English units)

C_i = Concentration of sample component "i" in ppm, as measured by Method 18 of appendix A to 40 CFR part 60 and ASTM D2504–67, 77, or 88 (Reapproved 1993) (incorporated by reference as specified in §61.18).

H_i = net heat of combustion of sample component "i" at 25 °C and 760 mm Hg (77 °F and 14.7 psi), kcal/g-mole. The heats of combustion may be determined using ASTM D2382–76 or 88 or D4809–95 (incorporated by reference as specified in §61.18) if published values are not available or cannot be calculated.

(4) The actual exit velocity of a flare shall be determined by dividing the volumetric flowrate (in units of standard temperature and pressure), as determined by Method 2, 2A, 2C, or 2D, as appropriate, by the unobstructed (free) cross section area of the flare tip.

(5) The maximum permitted velocity, V_{max} , for air-assisted flares shall be determined by the following equation:

$$V_{max} = K_1 + K_2 H_T$$

Where:

V_{max} = Maximum permitted velocity, m/sec (ft/sec).

H_T = Net heating value of the gas being combusted, as determined in paragraph (e)(3) of this section, MJ/scm (Btu/scf).

K_1 = 8.706 m/sec (metric units)

= 28.56 ft/sec (English units)

K_2 = 0.7084 m⁴/(MJ-sec) (metric units)

= 0.087 ft⁴/(Btu-sec) (English units)

[49 FR 23513, June 6, 1984, as amended at 49 FR 38946, Oct. 2, 1984; 49 FR 43647, Oct. 31, 1984; 53 FR 36972, Sept. 23, 1988; 54 FR 38077, Sept. 14, 1989; 65 FR 62158, Oct. 17, 2000]

§ 61.246 Recordkeeping requirements.

(a)(1) Each owner or operator subject to the provisions of this subpart shall comply with the recordkeeping requirements of this section.

(2) An owner or operator of more than one process unit subject to the provisions of this subpart may comply with the recordkeeping requirements for these process units in one recordkeeping system if the system identifies each record by each process unit.

(b) When each leak is detected as specified in §§61.242–2, 61.242–3, 61.242–7, 61.242–8, and 61.135, the following requirements apply:

- (1) A weatherproof and readily visible identification, marked with the equipment identification number, shall be attached to the leaking equipment.
 - (2) The identification on a valve may be removed after it has been monitored for 2 successive months as specified in §61.242-7(c) and no leak has been detected during those 2 months.
 - (3) The identification on equipment, except on a valve, may be removed after it has been repaired.
- (c) When each leak is detected as specified in §§61.242-2, 61.242-3, 61.242-7, 61.242-8, and 61.135, the following information shall be recorded in a log and shall be kept for 2 years in a readily accessible location:
- (1) The instrument and operator identification numbers and the equipment identification number.
 - (2) The date the leak was detected and the dates of each attempt to repair the leak.
 - (3) Repair methods applied in each attempt to repair the leak.
 - (4) "Above 10,000" if the maximum instrument reading measured by the methods specified in §61.245(a) after each repair attempt is equal to or greater than 10,000 ppm.
 - (5) "Repair delayed" and the reason for the delay if a leak is not repaired within 15 calendar days after discovery of the leak.
 - (6) The signature of the owner or operator (or designate) whose decision it was that repair could not be effected without a process shutdown.
 - (7) The expected date of successful repair of the leak if a leak is not repaired within 15 calendar days.
 - (8) Dates of process unit shutdowns that occur while the equipment is unrepaired.
 - (9) The date of successful repair of the leak.
- (d) The following information pertaining to the design requirements for closed-vent systems and control devices described in §61.242-11 shall be recorded and kept in a readily accessible location:
- (1) Detailed schematics, design specifications, and piping and instrumentation diagrams.
 - (2) The dates and descriptions of any changes in the design specifications.
 - (3) A description of the parameter or parameters monitored, as required in §61.242-11(e), to ensure that control devices are operated and maintained in conformance with their design and an explanation of why that parameter (or parameters) was selected for the monitoring.
 - (4) Periods when the closed-vent systems and control devices required in §§61.242-2, 61.242-3, 61.242-4, 61.242-5 and 61.242-9 are not operated as designed, including periods when a flare pilot light does not have a flame.
 - (5) Dates of startups and shutdowns of the closed-vent systems and control devices required in §§61.242-2, 61.242-3, 61.242-4, 61.242-5 and 61.242-9.
- (e) The following information pertaining to all equipment to which a standard applies shall be recorded in a log that is kept in a readily accessible location:
- (1) A list of identification numbers for equipment (except welded fittings) subject to the requirements of this subpart.
 - (2)(i) A list of identification numbers for equipment that the owner or operator elects to designate for no

detectable emissions as indicated by an instrument reading of less than 500 ppm above background.

(ii) The designation of this equipment for no detectable emissions shall be signed by the owner or operator.

(3) A list of equipment identification numbers for pressure relief devices required to comply with §61.242-4(a).

(4)(i) The dates of each compliance test required in §§61.242-2(e), 61.242-3(i), 61.242-4, 61.242-7(f), and 61.135(g).

(ii) The background level measured during each compliance test.

(iii) The maximum instrument reading measured at the equipment during each compliance test.

(5) A list of identification numbers for equipment in vacuum service.

(f) The following information pertaining to all valves subject to the requirements of §61.242-7(g) and (h) and to all pumps subject to the requirements of §61.242-2(g) shall be recorded in a log that is kept in a readily accessible location:

(1) A list of identification numbers for valves and pumps that are designated as unsafe to monitor, an explanation for each valve or pump stating why the valve or pump is unsafe to monitor, and the plan for monitoring each valve or pump.

(2) A list of identification numbers for valves that are designated as difficult to monitor, an explanation for each valve stating why the valve is difficult to monitor, and the planned schedule for monitoring each valve.

(g) The following information shall be recorded for valves complying with §61.243-2:

(1) A schedule of monitoring.

(2) The percent of valves found leaking during each monitoring period.

(h) The following information shall be recorded in a log that is kept in a readily accessible location:

(1) Design criterion required in §§61.242-2(d)(5), 61.242-3(e)(2), and 61.135(e)(4) and an explanation of the design criterion; and

(2) Any changes to this criterion and the reasons for the changes.

(i) The following information shall be recorded in a log that is kept in a readily accessible location for use in determining exemptions as provided in the applicability section of this subpart and other specific subparts:

(1) An analysis demonstrating the design capacity of the process unit, and

(2) An analysis demonstrating that equipment is not in VHAP service.

(j) Information and data used to demonstrate that a piece of equipment is not in VHAP service shall be recorded in a log that is kept in a readily accessible location.

[49 FR 23513, June 6, 1984, as amended at 49 FR 38946, Oct. 2, 1984; 54 FR 38077, Sept. 14, 1989; 65 FR 78283, Dec. 14, 2000]

§ 61.247 Reporting requirements.

(a)(1) An owner or operator of any piece of equipment to which this subpart applies shall submit a statement in writing notifying the Administrator that the requirements of §§61.242, 61.245, 61.246, and 61.247 are being implemented.

(2) In the case of an existing source or a new source which has an initial startup date preceding the effective date, the statement is to be submitted within 90 days of the effective date, unless a waiver of compliance is granted under §61.11, along with the information required under §61.10. If a waiver of compliance is granted, the statement is to be submitted on a date scheduled by the Administrator.

(3) In the case of new sources which did not have an initial startup date preceding December 14, 2000, the statement required under paragraph (a)(1) of this section shall be submitted with the application for approval of construction, as described in §61.07.

(4) For owners and operators complying with 40 CFR part 65, subpart C or F, the statement required under paragraph (a)(1) of this section shall notify the Administrator that the requirements of 40 CFR part 65, subpart C or F, are being implemented.

(5) The statement is to contain the following information for each source:

(i) Equipment identification number and process unit identification.

(ii) Type of equipment (for example, a pump or pipeline valve).

(iii) Percent by weight VHAP in the fluid at the equipment.

(iv) Process fluid state at the equipment (gas/vapor or liquid).

(v) Method of compliance with the standard (for example, "monthly leak detection and repair" or "equipped with dual mechanical seals").

(b) A report shall be submitted to the Administrator semiannually starting 6 months after the initial report required in paragraph (a) of this section, that includes the following information:

(1) Process unit identification.

(2) For each month during the semiannual reporting period,

(i) Number of valves for which leaks were detected as described in §61.242-7(b) of §61.243-2.

(ii) Number of valves for which leaks were not repaired as required in §61.242-7(d).

(iii) Number of pumps for which leaks were detected as described in §61.242-2 (b) and (d)(6).

(iv) Number of pumps for which leaks were not repaired as required in §61.242-2 (c) and (d)(6).

(v) Number of compressors for which leaks were detected as described in §61.242-3(f).

(vi) Number of compressors for which leaks were not repaired as required in §61.242-3(g).

(vii) The facts that explain any delay of repairs and, where appropriate, why a process unit shutdown was technically infeasible.

(3) Dates of process unit shutdowns which occurred within the semiannual reporting period.

(4) Revisions to items reported according to paragraph (a) if changes have occurred since the initial report or subsequent revisions to the initial report.

Note: Compliance with the requirements of §61.10(c) is not required for revisions documented under this paragraph.

(5) The results of all performance tests and monitoring to determine compliance with no detectable emissions and with §§61.243–1 and 61.243–2 conducted within the semiannual reporting period.

(c) In the first report submitted as required in paragraph (a) of this section, the report shall include a reporting schedule stating the months that semiannual reports shall be submitted. Subsequent reports shall be submitted according to that schedule, unless a revised schedule has been submitted in a previous semiannual report.

(d) An owner or operator electing to comply with the provisions of §§61.243–1 and 61.243–2 shall notify the Administrator of the alternative standard selected 90 days before implementing either of the provisions.

(e) An application for approval of construction or modification, §§61.05(a) and 61.07, will not be required if—

(1) The new source complies with the standard, §61.242;

(2) The new source is not part of the construction of a process unit; and

(3) In the next semiannual report required by paragraph (b) of this section, the information in paragraph (a)(5) of this section is reported.

(f) For owners or operators choosing to comply with 40 CFR part 65, subpart C or F, an application for approval of construction or modification, as required under §§61.05 and 61.07 will not be required if:

(1) The new source complies with 40 CFR 65.106 through 65.115 and with 40 CFR part 65, subpart C, for surge control vessels and bottoms receivers;

(2) The new source is not part of the construction of a process unit; and

(3) In the next semiannual report required by 40 CFR 65.120(b) and 65.48(b), the information in paragraph (a)(5) of this section is reported.

[49 FR 23513, June 6, 1984, as amended at 49 FR 38947, Oct. 2, 1984; 54 FR 38077, Sept. 14, 1989; 65 FR 78283, Dec. 14, 2000]

Table 1 to Subpart V of Part 61—Surge Control Vessels and Bottoms Receivers at Existing Sources

Vessel capacity (cubic meters)	Vapor pressure ¹ (kilopascals)
75 ≤ capacity < 151	≥ 13.1
151 ≤ capacity	≥ 5.2

¹Maximum true vapor pressure as defined in §61.241.

[65 FR 78283, Dec. 14, 2000]

Table 2 to Subpart V of Part 61—Surge Control Vessels and Bottoms Receivers at New Sources

Vessel capacity (cubic meters)	Vapor pressure¹ (kilopascals)
$38 \leq \text{capacity} < 151$	≥ 13.1
$151 \leq \text{capacity}$	≥ 0.7

¹Maximum true vapor pressure as defined in §61.241.

[65 FR 78283, Dec. 14, 2000]

[Browse Previous](#) | [Browse Next](#)

For questions or comments regarding e-CFR editorial content, features, or design, email ecfr@nara.gov.

For questions concerning e-CFR programming and delivery issues, email webteam@gpo.gov.

[Section 508 / Accessibility](#)

[Home Page](#) > [Executive Branch](#) > [Code of Federal Regulations](#) > [Electronic Code of Federal Regulations](#)

Electronic Code of Federal Regulations

e-CFR

TM

e-CFR Data is current as of August 1, 2007

Title 40: Protection of Environment

PART 61—NATIONAL EMISSION STANDARDS FOR HAZARDOUS AIR POLLUTANTS

[Browse Previous](#) | [Browse Next](#)

Subpart Y—National Emission Standard for Benzene Emissions From Benzene Storage Vessels

Source: 54 FR 38077, Sept. 14, 1989, unless otherwise noted.

§ 61.270 Applicability and designation of sources.

(a) The source to which this subpart applies is each storage vessel that is storing benzene having a specific gravity within the range of specific gravities specified in ASTM D836–84 for Industrial Grade Benzene, ASTM D835–85 for Refined Benzene-485, ASTM D2359–85a or 93 for Refined Benzene-535, and ASTM D4734–87 or 96 for Refined Benzene-545. These specifications are incorporated by reference as specified in §61.18. See §61.18 for acceptable versions of these methods.

(b) Except for paragraph (b) in §61.276, storage vessels with a design storage capacity less than 38 cubic meters (10,000 gallons) are exempt from the provisions of this subpart.

(c) This subpart does not apply to storage vessels used for storing benzene at coke by-product facilities.

(d) This subpart does not apply to vessels permanently attached to motor vehicles such as trucks, rail cars, barges, or ships.

(e) This subpart does not apply to pressure vessels designed to operate in excess of 204.9 kPa (29.72 psia) and without emissions to the atmosphere.

(f) A designated source subject to the provisions of this subpart that is also subject to applicable provisions of 40 CFR part 60 subparts K, Ka, and Kb shall be required to comply only with the subpart that contains the most stringent requirements for that source.

(g) *Alternative means of compliance* —(1) *Option to comply with part 65.* Owners or operators may choose to comply with 40 CFR part 65, subpart C, to satisfy the requirements of §§61.271 through 61.277, except for §§61.271(d)(2) and 61.274(a) for storage vessels that are subject to this subpart. Other provisions applying to owners or operators who choose to comply with 40 CFR part 65 are provided in 40 CFR 65.1.

(2) *Part 61, subpart A.* Owners or operators who choose to comply with 40 CFR part 65, subpart C, must also comply with §§61.01, 61.02, 61.05 through 61.08, 61.10(b) through (d), 61.11, and 61.15 for those storage vessels. All sections and paragraphs of subpart A of this part that are not mentioned in this paragraph (g)(2) do not apply for storage vessels complying with 40 CFR part 65, subpart C, except that provisions required to be met prior to implementing 40 CFR part 65 still apply. Owners and operators who choose to comply with 40 CFR part 65, subpart C, must comply with 40 CFR part 65, subpart A.

[54 FR 38077, Sept. 14, 1989, as amended at 65 FR 62159, Oct. 17, 2000; 65 FR 78283, Dec. 14, 2000]

§ 61.271 Emission standard.

The owner or operator of each storage vessel with a design storage capacity greater than or equal to 38 cubic meters (10,000 gallons) to which this subpart applies shall comply with the requirements in paragraph (d) of this section and with the requirements either in paragraph (a), (b), or (c) of this section, or equivalent as provided in §61.273.

(a) The storage vessel shall be equipped with a fixed roof and an internal floating roof.

(1) An internal floating roof means a cover that rests on the liquid surface (but not necessarily in complete contact with it) inside a storage vessel that has a permanently affixed roof. The internal floating roof shall be floating on the liquid surface at all times, except during initial fill and during those intervals when the storage vessel is completely emptied or subsequently emptied and refilled. When the roof is resting on the leg supports, the process of filling, emptying, or refilling shall be continuous and shall be accomplished as rapidly as possible.

(2) Each internal floating roof shall be equipped with one of the closure devices listed in paragraphs (a) (2) (i), (ii), or (iii) of this section between the wall of the storage vessel and the edge of the internal floating roof. This requirement does not apply to each existing storage vessel for which construction of an internal floating roof equipped with a continuous seal commenced on or before July 28, 1988. A continuous seal means a seal that forms a continuous closure that completely covers the space between the wall of the storage vessel and the edge of the internal floating roof.

(i) A foam- or liquid-filled seal mounted in contact with the liquid (liquid-mounted seal). A liquid-mounted seal means a foam- or liquid-filled seal mounted in contact with the liquid between the wall of the storage vessel and the floating roof continuously around the circumference of the vessel.

(ii) Two seals mounted one above the other so that each forms a continuous closure that completely covers the space between the wall of the storage vessel and the edge of the internal floating roof. The lower seal may be vapor-mounted, but both must be continuous.

(iii) A metallic shoe seal. A metallic shoe seal (also referred to as a mechanical shoe seal) is, but is not limited to, a metal sheet held vertically against the wall of the storage vessel by springs or weighted levers and is connected by braces to the floating roof. A flexible coated fabric (envelope) spans the annular space between the metal sheet and the floating roof.

(3) Automatic bleeder vents are to be closed at all times when the roof is floating, except when the roof is being floated off or is being landed on the roof leg supports.

(4) Each opening in a noncontact internal floating roof except for automatic bleeder vents (vacuum breaker vents) and the rim space vents is to provide a projection below the liquid surface.

(5) Each internal floating roof shall meet the specifications listed below. If an existing storage vessel had an internal floating roof with a continuous seal as of July 28, 1988, the requirements listed below do not have to be met until the first time after September 14, 1989, the vessel is emptied and degassed or September 14, 1999, whichever occurs first,

(i) Each opening in the internal floating roof except for leg sleeves, automatic bleeder vents, rim space vents, column wells, ladder wells, sample wells, and stub drains is to be equipped with a cover or lid. The cover or lid shall be equipped with a gasket. Covers on each access hatch and automatic gauge float well shall be bolted.

(ii) Each penetration of the internal floating roof for the purposes of sampling shall be a sample well. Each sample well shall have a slit fabric cover that covers at least 90 percent of the opening.

(iii) Each automatic bleeder vent shall be gasketed.

(iv) Rim space vents shall be equipped with a gasket.

(v) Each penetration of the internal floating roof that allows for passage of a ladder shall have a gasketed sliding cover.

(vi) Each penetration of the internal floating roof that allows for passage of a column supporting the fixed roof shall have a flexible fabric sleeve seal or a gasketed sliding cover.

(6) Each cover or lid on any opening in the internal floating roof shall be closed (i.e., no visible gaps), except when a device is in actual use. Covers on each access hatch and each automatic gauge float well which are equipped with bolts shall be bolted when they are not in use. Rim space vents are to be set to open only when the internal floating roof is not floating or at the manufacturer's recommended setting.

(b) The storage vessel shall have an external floating roof.

(1) An external floating roof means a pontoon-type or double-deck-type cover that rests on the liquid surface in a vessel with no fixed roof.

(2) Each external floating roof shall be equipped with a closure device between the wall of the storage vessel and the roof edge. Except as provided in paragraph (b)(5) of this section, the closure device is to consist of two seals, one above the other. The lower seal is referred to as the primary seal and the upper seal is referred to as the secondary seal.

(i) The primary seal shall be either a metallic shoe seal or a liquid-mounted seal. A liquid-mounted seal means a foam- or liquid-filled seal mounted in contact with the liquid between the wall of the storage vessel and the floating roof continuously around the circumference of the vessel. A metallic shoe seal (which can also be referred to as a mechanical shoe seal) is, but is not limited to, a metal sheet held vertically against the wall of the storage vessel by springs or weighted levers and is connected by braces to the floating roof. A flexible coated fabric (envelope) spans the annular space between the metal sheet and the floating roof. Except as provided in §61.272(b)(4), the primary seal shall completely cover the annular space between the edge of the floating roof and the vessel wall.

(ii) The secondary seal shall completely cover the annular space between the external floating roof and the wall of the storage vessel in a continuous fashion except as allowed in §61.272(b)(4).

(3) Except for automatic bleeder vents and rim space vents, each opening in the noncontact external floating roof shall provide a projection below the liquid surface. Except for automatic bleeder vents, rim space vents, roof drains, and leg sleeves, each opening in the roof is to be equipped with a gasketed cover, seal or lid which is to be maintained in a closed position at all times (i.e., no visible gap) except when the device is in actual use. Automatic bleeder vents are to be closed at all times when the roof is floating, except when the roof is being floated off or is being landed on the roof leg supports. Rim vents are to be set to open when the roof is being floated off the roof leg supports or at the manufacturer's recommended setting. Automatic bleeder vents and rim space vents are to be gasketed. Each emergency roof drain is to be provided with a slotted membrane fabric cover that covers at least 90 percent of the area of the opening.

(4) The roof shall be floating on the liquid at all times (i.e., off the roof leg supports) except during initial fill until the roof is lifted off leg supports and when the vessel is completely emptied and subsequently refilled. The process of emptying and refilling when the roof is resting on the leg supports shall be continuous and shall be accomplished as rapidly as possible.

(5) The requirement for a secondary seal does not apply to each existing storage vessel that was equipped with a liquid-mounted primary seal as of July 28, 1988, until after the first time after September 14, 1989, when the vessel is emptied and degassed or 10 years from September 14, 1989, whichever occurs first.

(c) The storage vessel shall be equipped with a closed vent system and a control device.

(1) The closed vent system shall be designed to collect all benzene vapors and gases discharged from the storage vessel and operated with no detectable emissions, as indicated by an instrument reading of less than 500 ppm above background and visual inspections, as determined in §61.242-11 (subpart V).

(2) The control device shall be designed and operated to reduce inlet benzene emissions by 95 percent or greater. If a flare is used as the control device, it shall meet the specifications described in the general control device requirements of 40 CFR 60.18.

(3) The specifications and requirements listed in paragraphs (c)(1) and (c)(2) of this section for closed vent systems and control devices do not apply during periods of routine maintenance. During periods of routine maintenance, the benzene level in the storage vessel(s) serviced by the control device subject to the provisions of §61.271(c) may be lowered but not raised. Periods of routine maintenance shall not exceed 72 hours as outlined in the maintenance plan required by §61.272(c)(1)(iii).

(4) The specifications and requirements listed in paragraphs (c)(1) and (c)(2) of this section for closed vents and control devices do not apply during a control system malfunction. A control system malfunction means any sudden and unavoidable failure of air pollution control equipment. A failure caused entirely or in part by design deficiencies, poor maintenance, careless operation, or other preventable upset condition or equipment breakdown is not considered a malfunction.

(d) The owner or operator of each affected storage vessel shall meet the requirements of paragraph (a), (b), or (c) of this section or §61.270(g) as follows:

(1) The owner or operator of each existing benzene storage vessel shall meet the requirements of paragraph (a), (b), or (c) of this section no later than 90 days after September 14, 1989, with the exceptions noted in paragraphs (a)(5) and (b)(5), unless a waiver of compliance has been approved by the Administrator in accordance with §61.11.

(2) The owner or operator of each benzene storage vessel upon which construction commenced after September 14, 1989 shall meet the requirements of paragraph (a), (b), or (c) of this section or §61.270(g) prior to filling (*i.e.*, roof is lifted off leg supports) the storage vessel with benzene.

(3) The owner or operator of each benzene storage vessel upon which construction commenced on or after July 28, 1988, and before September 14, 1989, shall meet the requirements of paragraph (a), (b), or (c) of this section on September 14, 1989.

[54 FR 38077, Sept. 14, 1989; 54 FR 50887, Dec. 11, 1989, as amended at 65 FR 78284, Dec. 14, 2000]

§ 61.272 Compliance provisions.

(a) For each vessel complying with §61.271(a) (fixed roof and internal floating roof) each owner or operator shall:

(1) After installing the control equipment required to comply with §61.271(a), visually inspect the internal floating roof, the primary seal, and the secondary seal (if one is in service), prior to filling the storage vessel with benzene. If there are holes, tears or other openings in the primary seal, the secondary seal, or the seal fabric, or defects in the internal floating roof, the owner or operator shall repair the items before filling the storage vessel.

(2) Visually inspect the internal floating roof and the primary seal or the secondary seal (if one is in service) through manholes and roof hatches on the fixed roof at least once every 12 months after initial fill, or at least once every 12 months after September 14, 1989, except as provided in paragraph (a)(4)(i) of this section. If the internal floating roof is not resting on the surface of the benzene liquid inside the storage vessel, or there is liquid on the roof, or the seal is detached, or there are holes or tears in the seal fabric, the owner or operator shall repair the items or empty and remove the storage vessel from service within 45 days. If a failure that is detected during inspections required in this paragraph cannot be repaired within 45 days and if the vessel cannot be emptied within 45 days, an extension of up to 30 additional days may be requested from the Administrator in the inspection report required in §61.275(a). Such a request for an extension must document that alternate storage capacity is unavailable and specify a schedule of actions the company will take that will ensure that the control equipment will be repaired or the vessel will be emptied as soon as possible.

(3) Visually inspect the internal floating roof, the primary seal, the secondary seal (if one is in service), gaskets, slotted membranes and sleeve seals (if any) each time the storage vessel is emptied and

degassed. In no event shall inspections conducted in accordance with this provision occur at intervals greater than 10 years in the case of vessels conducting the annual visual inspections as specified in paragraph (a)(2) of this section and at intervals greater than 5 years in the case of vessels specified in paragraph (a)(4)(i) of this section.

(i) For all the inspections required by paragraphs (a)(1) and (a)(3) of this section, the owner or operator shall notify the Administrator in writing at least 30 days prior to the refilling of each storage vessel to afford the Administrator the opportunity to have an observer present. If the inspection required by paragraph (a)(3) of this section is not planned and the owner or operator could not have known about the inspection 30 days in advance of refilling the vessel, the owner or operator shall notify the Administrator at least 7 days prior to the refilling of the storage vessel. Notification shall be made by telephone immediately followed by written documentation demonstrating why the inspection was unplanned. Alternatively, the notification including the written documentation may be made in writing and sent by express mail so that it is received by the Administrator at least 7 days prior to refilling.

(ii) If the internal floating roof has defects, the primary seal has holes, tears, or other openings in the seal or the seal fabric, or the secondary seal has holes, tears, or other openings in the seal or the seal fabric, or the gaskets no longer close off the liquid surfaces from the atmosphere, or the slotted membrane has more than 10 percent open area, the owner or operator shall repair the items as necessary so that none of the conditions specified in this paragraph exist before refilling the storage vessel with benzene.

(4) For vessels equipped with a double-seal system as specified in §61.271(a)(2)(ii):

(i) Visually inspect the vessel as specified in paragraph (a)(3) of this section at least every 5 years; or

(ii) Visually inspect the vessel annually as specified in paragraph (a)(2) of this section, and at least every 10 years as specified in paragraph (a)(3) of this section.

(b) For each vessel complying with §61.271(b) (external floating roof) the owner or operator shall:

(1) Determine the gap areas and maximum gap widths between the primary seal and the wall of the storage vessel, and the secondary seal and the wall of the storage vessel according to the following frequency.

(i) For an external floating roof vessel equipped with primary and secondary seals, measurements of gaps between the vessel wall and the primary seal (seal gaps) shall be performed during the hydrostatic testing of the vessel or within 90 days of the initial fill with benzene or within 90 days of September 14, 1989, whichever occurs last, and at least once every 5 years thereafter, except as provided in paragraph (b)(1)(ii) of this section.

(ii) For an external floating roof vessel equipped with a liquid-mounted primary seal and without a secondary seal as provided for in §61.271(b)(5), measurement of gaps between the vessel wall and the primary seal (seal gaps) shall be performed within 90 days of September 14, 1989, and at least once per year thereafter. When a secondary seal is installed over the primary seal, measurement of primary seal gaps shall be performed within 90 days of installation and at least once every 5 years thereafter.

(iii) For an external floating roof vessel equipped with primary and secondary seals, measurements of gaps between the vessel wall and the secondary seal shall be performed within 90 days of the initial fill with benzene, within 90 days of installation of the secondary seal, or within 90 days after September 14, 1989, whichever occurs last, and at least once per year thereafter.

(iv) If any source ceases to store benzene for a period of 1 year or more, subsequent introduction of benzene into the vessel shall be considered an initial fill for the purposes of paragraphs (b)(1)(i), (b)(1)(ii), and (b)(1)(iii) of this section.

(2) Determine gap widths and areas in the primary and secondary seals individually by the following procedures:

(i) Measure seal gaps, if any, at one or more floating roof levels when the roof is floating off the roof leg supports.

(ii) Measure seal gaps around the entire circumference of the vessel in each place where a 0.32 centimeter (cm) (1/8 in) diameter uniform probe passes freely (without forcing or binding against the seal) between the seal and the wall of the storage vessel and measure the circumferential distance of each such location.

(iii) The total surface area of each gap described in paragraph (b)(2)(ii) of this section shall be determined by using probes of various widths to measure accurately the actual distance from the vessel wall to the seal and multiplying each such width by its respective circumferential distance.

(3) Add the gap surface area of each gap location for the primary seal and the secondary seal individually. Divide the sum for each seal by the nominal diameter of the vessel and compare each ratio to the respective standards in §61.272(b)(4) and §61.272(b)(5).

(4) Repair conditions that do not meet requirements listed in paragraph (b)(4) (i) and (ii) within 45 days of identification in any inspection or empty and remove the storage vessel from service within 45 days.

(i) The accumulated area of gaps between the vessel wall and the metallic shoe seal or the liquid-mounted primary seal shall not exceed 212 cm² per meter of vessel diameter (10.0 in² per foot of vessel diameter) and the width of any portion of any gap shall not exceed 3.81 cm (1 1/2 in).

(A) One end of the metallic shoe is to extend into the stored liquid and the other end is to extend a minimum vertical distance of 61 cm (24 in) above the stored liquid surface.

(B) There are to be no holes, tears, or other openings in the shoe, seal fabric, or seal envelope.

(ii) The secondary seal is to meet the following requirements:

(A) The secondary seal is to be installed above the primary seal so that it completely covers the space between the roof edge and the vessel wall except as provided in paragraph (b)(4)(ii)(B) of this section.

(B) The accumulated area of gaps between the vessel wall and the secondary seal shall not exceed 21.2 cm² per meter of vessel diameter (1.0 in² per foot of vessel diameter) or the width of any portion of any gap shall not exceed 1.27 cm (1/2 in). These seal gap requirements may be exceeded during the measurement of primary seal gaps as required by paragraph (b)(1)(i) or (b)(1)(ii) of this section.

(C) There are to be no holes, tears, or other openings in the seal or seal fabric.

(iii) If a failure that is detected during inspections required in this paragraph cannot be repaired within 45 days and if the vessel cannot be emptied within 45 days, an extension of up to 30 additional days may be requested from the Administrator in the inspection report required in §61.275(d). Such extension request must include a demonstration of unavailability of alternate storage capacity and a specification of a schedule that will assure that the control equipment will be repaired or the vessel will be emptied as soon as possible.

(5) The owner or operator shall notify the Administrator 30 days in advance of any gap measurements required by paragraph (b)(1) of this section to afford the Administrator the opportunity to have an observer present.

(6) Visually inspect the external floating roof, the primary seal, secondary seal, and fittings each time the vessel is emptied and degassed.

(i) If the external floating roof has defects, the primary seal has holes, tears, or other openings in the seal or the seal fabric, or the secondary seal has holes, tears, or other openings in the seal or the seal fabric, the owner or operator shall repair the items as necessary so that none of the conditions specified in this paragraph exist before filling or refilling the storage vessel with benzene.

(ii) For all the inspections required by paragraph (b)(6) of this section, the owner or operator shall notify the Administrator in writing at least 30 days prior to filling or refilling of each storage vessel to afford the Administrator the opportunity to inspect the storage vessel prior to refilling. If the inspection required by paragraph (b)(6) of this section is not planned and the owner or operator could not have known about

the inspection 30 days in advance of refilling the vessel, the owner or operator shall notify the Administrator at least 7 days prior to refilling of the storage vessel. Notification shall be made by telephone immediately followed by written documentation demonstrating why the inspection was unplanned. Alternatively, this notification including the written documentation may be made in writing and sent by express mail so that it is received by the Administrator at least 7 days prior to the refilling.

(c) The owner or operator of each source that is equipped with a closed vent system and control device as required in §60.271(c), other than a flare, shall meet the following requirements.

(1) Within 90 days after initial fill or after September 14, 1989, whichever comes last, submit for approval by the Administrator, an operating plan containing the information listed below.

(i) Documentation demonstrating that the control device being used achieves the required control efficiency during reasonably expected maximum loading conditions. This documentation is to include a description of the gas stream which enters the control device, including flow and benzene content under varying liquid level conditions (dynamic and static) and manufacturer's design specifications for the control device. If the control device or the closed vent capture system receives vapors, gases or liquids, other than fuels, from sources that are not designated sources under this subpart, the efficiency demonstration is to include consideration of all vapors, gases and liquids received by the closed vent capture system and control device. If an enclosed combustion device with a minimum residence time of 0.75 seconds and a minimum temperature of 816 °C (1,500 °F) is used to meet the 95 percent requirement, documentation that those conditions exist is sufficient to meet the requirements of this paragraph.

(ii) A description of the parameter or parameters to be monitored to ensure that the control device is operated and maintained in conformance with its design and an explanation of the criteria used for selection of that parameter (or parameters).

(iii) A maintenance plan for the system including the type of maintenance necessary, planned frequency of maintenance, and lengths of maintenance periods for those operations that would require the closed vent system or the control device to be out of compliance with §61.271(c). The maintenance plan shall require that the system be out of compliance with §61.271(c) for no more than 72 hours per year.

(2) Operate, monitor the parameters, and maintain the closed vent system and control device in accordance with the operating plan submitted to the Administrator in accordance with paragraph (c)(1) of this section, unless the plan was modified by the Administrator during the approval process. In this case, the modified plan applies.

(d) The owner or operator of each source that is equipped with a closed vent system and a flare to meet the requirements in §61.271(c) shall meet the requirements as specified in the general control device requirements in 40 CFR 60.18 (e) and (f).

[54 FR 38077, Sept. 14, 1989, as amended at 65 FR 62159, Oct. 17, 2000]

§ 61.273 Alternative means of emission limitation.

(a) Upon written application from any person, the Administrator may approve the use of alternative means of emission limitation which have been demonstrated to his satisfaction to achieve a reduction in benzene emissions at least equivalent to the reduction in emissions achieved by any requirement in §61.271 (a), (b), or (c) of this subpart.

(b) Determination of equivalence to the reduction in emissions achieved by the requirements of §61.271 (a), (b), or (c) will be evaluated using the following information to be included in the written application to the Administrator:

(1) Actual emissions tests that use full-size or scale-model storage vessels that accurately collect and measure all benzene emissions from a given control device, and that accurately simulate wind and account for other emission variables such as temperature and barometric pressure.

(2) An engineering evaluation that the Administrator determines is an accurate method of determining equivalence.

(c) The Administrator may condition approval of equivalency on requirements that may be necessary to ensure operation and maintenance to achieve the same emission reduction as the requirements of §61.271 (a), (b), or (c).

(d) If, in the Administrator's judgment, an application for equivalence may be approvable, the Administrator will publish a notice of preliminary determination in the Federal Register and provide the opportunity for public hearing. After notice and opportunity for public hearing, the Administrator will determine the equivalence of the alternative means of emission limitation and will publish the final determination in the Federal Register.

§ 61.274 Initial report.

(a) The owner or operator of each storage vessel to which this subpart applies and which has a design capacity greater than or equal to 38 cubic meters (10,000 gallons) shall submit an initial report describing the controls which will be applied to meet the equipment requirements of §61.271 or §61.270 (g). For an existing storage vessel or a new storage vessel for which construction and operation commenced prior to September 14, 1989, this report shall be submitted within 90 days of September 14, 1989 and can be combined with the report required by §61.10. For a new storage vessel for which construction or operation commenced on or after September 14, 1989, the report shall be combined with the report required by §61.07 or 40 CFR 65.5(b). In the case where the owner or operator seeks to comply with §61.271(c), with a control device other than a flare, this information may consist of the information required by §61.272(c)(1).

(b) The owner or operator of each storage vessel seeking to comply with §61.271(c) with a flare, shall submit a report containing the measurements required by 40 CFR 60.18(f) (1), (2), (3), (4), (5), and (6). For the owner or operator of an existing storage vessel not seeking to obtain a waiver or a new storage vessel for which construction and operation commenced prior to September 14, 1989, this report shall be combined with the report required by paragraph (a) of this section. For the owner or operator of an existing storage vessel seeking to obtain a waiver, the reporting date will be established in the response to the waiver request. For the owner or operator of a new storage vessel for which construction or operation commenced after September 14, 1989, the report shall be submitted within 90 days of the date the vessel is initially filled (or partially filled) with benzene.

[54 FR 38077, Sept. 14, 1989, as amended at 65 FR 78284, Dec. 14, 2000]

§ 61.275 Periodic report.

(a) The owner or operator of each storage vessel to which this subpart applies after installing control equipment in accordance with §61.271(a) (fixed roof and internal floating roof) shall submit a report describing the results of each inspection conducted in accordance with §61.272(a). For vessels for which annual inspections are required under §61.272(a)(2), the first report is to be submitted no more than 12 months after the initial report submitted in accordance with §61.274, and each report is to be submitted within 60 days of each annual inspection.

(1) Each report shall include the date of the inspection of each storage vessel and identify each storage vessel in which:

(i) The internal floating roof is not resting on the surface of the benzene liquid inside the storage vessel, or there is liquid on the roof, or the seal is detached from the internal floating roof, or there are holes, tears or other openings in the seal or seal fabric; or

(ii) There are visible gaps between the seal and the wall of the storage vessel.

(2) Where an annual report identifies any condition in paragraph (a)(1) of this section the annual report shall describe the nature of the defect, the date the storage vessel was emptied, and the nature of and date the repair was made, except as provided in paragraph (a)(3) of this section.

(3) If an extension is requested in an annual periodic report in accordance with §61.272(a)(2), a supplemental periodic report shall be submitted within 15 days of repair. The supplemental periodic report shall identify the vessel and describe the date the storage vessel was emptied and the nature of and date the repair was made.

(b) The owner or operator of each storage vessel to which this subpart applies after installing control equipment in accordance with §61.271(a) (fixed roof and internal floating roof) shall submit a report describing the results of each inspection conducted in accordance with §61.272(a) (3) or (4).

(1) The report is to be submitted within 60 days of conducting each inspection required by §61.272(a) (3) or (4).

(2) Each report shall identify each storage vessel in which the owner or operator finds that the internal floating roof has defects, the primary seal has holes, tears, or other openings in the seal or the seal fabric, or the secondary seal (if one has been installed) has holes, tears, or other openings in the seal or the seal fabric, or the gaskets no longer close off the liquid surfaces from the atmosphere, or the slotted membrane has more than 10 percent open area. The report shall also describe the nature of the defect, the date the storage vessel was emptied, and the nature of and date the repair was made.

(c) Any owner or operator of an existing storage vessel which had an internal floating roof with a continuous seal as of July 28, 1988, and which seeks to comply with the requirements of §61.271(a)(5) during the first time after September 14, 1989, when the vessel is emptied and degassed but no later than 10 years from September 14, 1989, shall notify the Administrator 30 days prior to the completion of the installation of such controls and the date of refilling of the vessel so the Administrator has an opportunity to have an observer present to inspect the storage vessel before it is refilled. This report can be combined with the one required by §61.275(b).

(d) The owner or operator of each storage vessel to which this subpart applies after installing control equipment in accordance with §61.271(b) (external floating roof) shall submit a report describing the results of each seal gap measurement made in accordance with §61.272(b). The first report is to be submitted no more than 12 months after the initial report submitted in accordance with §61.274(a), and each annual periodic report is to be submitted within 60 days of each annual inspection.

(1) Each report shall include the date of the measurement, the raw data obtained in the measurement, and the calculations described in §61.272(b) (2) and (3), and shall identify each storage vessel which does not meet the gap specifications of §61.272(b). Where an annual report identifies any vessel not meeting the seal gap specifications of §61.272(b) the report shall describe the date the storage vessel was emptied, the measures used to correct the condition and the date the storage vessel was brought into compliance.

(2) If an extension is requested in an annual periodic report in accordance with §61.272(b)(4)(iii), a supplemental periodic report shall be submitted within 15 days of repair. The supplemental periodic report shall identify the vessel and describe the date the vessel was emptied and the nature of and date the repair was made.

(e) Excess emission report.

(1) The owner or operator of each source seeking to comply with §61.271(c) (vessels equipped with closed vent systems with control devices) shall submit a quarterly report informing the Administrator of each occurrence that results in excess emissions. Excess emissions are emissions that occur at any time when compliance with the specifications and requirements of §61.271(c) are not achieved, as evidenced by the parameters being measured in accordance with §61.272(c)(1)(ii) if a control device other than a flare is used, or by the measurements required in §61.272(d) and the general control device requirements in 40 CFR 60.18(f) (1) and (2) if a flare is used.

(2) The owner or operator shall submit the following information as a minimum in the report required by (e)(1) of this section:

(i) Identify the stack and other emission points where the excess emissions occurred;

(ii) A statement of whether or not the owner or operator believes a control system malfunction has occurred.

(3) If the owner or operator states that a control system malfunction has occurred, the following information as a minimum is also to be included in the report required under paragraph (e)(1) of this section:

(i) Time and duration of the control system malfunction as determined by continuous monitoring data (if any), or the inspections or monitoring done in accordance with the operating plan required by §61.272 (c).

(ii) Cause of excess emissions.

§ 61.276 Recordkeeping.

(a) Each owner or operator with a storage vessel subject to this subpart shall keep copies of all the reports and records required by this subpart for at least 2 years, except as specified in paragraphs (b) and (c)(1) of this section.

(b) Each owner or operator with a storage vessel, including any vessel which has a design storage capacity less than 38 cubic meters (10,000 gallons), shall keep readily accessible records showing the dimensions of the storage vessel and an analysis showing the capacity of the storage vessel. This record shall be kept as long as the storage vessel is in operation. Each storage vessel with a design capacity of less than 38 cubic meters (10,000 gallons) is subject to no provisions of this subpart other than those required by this paragraph.

(c) The following information pertaining to closed vent system and control devices shall be kept in a readily accessible location.

(1) A copy of the operating plan. This record shall be kept as long as the closed vent system and control device is in use.

(2) A record of the measured values of the parameters monitored in accordance with §61.272(c)(1)(ii) and §61.272(c)(2).

(3) A record of the maintenance performed in accordance with §61.272(c)(1)(iii) of the operating plan, including the following:

(i) The duration of each time the closed vent system and control device does not meet the specifications of §61.271(c) due to maintenance, including the following:

(A) The first time of day and date the requirements of 61.271(c) were not met at the beginning of maintenance.

(B) The first time of day and date the requirements of §61.271(c) were met at the conclusion of maintenance.

(C) A continuous record of the liquid level in each storage vessel that the closed vent system and control device receive vapors from during the interval between the times specified by (c)(3)(i)(A) and (c)(3)(i)(B). Pumping records (simultaneous input and output) may be substituted for records of the liquid level.

§ 61.277 Delegation of authority.

(a) In delegating implementation and enforcement authority to a State under section 112(d) of the Act, the authorities contained in paragraph (b) of this section shall be retained by the Administrator and not transferred to a State.

(b) Authorities which will not be delegated to States: §61.273.

[Browse Previous](#) | [Browse Next](#)

For questions or comments regarding e-CFR editorial content, features, or design, email ecfr@nara.gov.

For questions concerning e-CFR programming and delivery issues, email webteam@gpo.gov.

Section 508 / Accessibility

*

[Home Page](#) > [Executive Branch](#) > [Code of Federal Regulations](#) > [Electronic Code of Federal Regulations](#)

Electronic Code of Federal Regulations

e-CFR
TM

e-CFR Data is current as of August 1, 2007

Title 40: Protection of Environment

PART 61—NATIONAL EMISSION STANDARDS FOR HAZARDOUS AIR POLLUTANTS

[Browse Previous](#)

Subpart FF—National Emission Standard for Benzene Waste Operations

Source: 55 FR 8346, Mar. 7, 1990, unless otherwise noted.

§ 61.340 Applicability.

(a) The provisions of this subpart apply to owners and operators of chemical manufacturing plants, coke by-product recovery plants, and petroleum refineries.

(b) The provisions of this subpart apply to owners and operators of hazardous waste treatment, storage, and disposal facilities that treat, store, or dispose of hazardous waste generated by any facility listed in paragraph (a) of this section. The waste streams at hazardous waste treatment, storage, and disposal facilities subject to the provisions of this subpart are the benzene-containing hazardous waste from any facility listed in paragraph (a) of this section. A hazardous waste treatment, storage, and disposal facility is a facility that must obtain a hazardous waste management permit under subtitle C of the Solid Waste Disposal Act.

(c) At each facility identified in paragraph (a) or (b) of this section, the following waste is exempt from the requirements of this subpart:

(1) Waste in the form of gases or vapors that is emitted from process fluids:

(2) Waste that is contained in a segregated stormwater sewer system.

(d) At each facility identified in paragraph (a) or (b) of this section, any gaseous stream from a waste management unit, treatment process, or wastewater treatment system routed to a fuel gas system, as defined in §61.341, is exempt from this subpart. No testing, monitoring, recordkeeping, or reporting is required under this subpart for any gaseous stream from a waste management unit, treatment process, or wastewater treatment unit routed to a fuel gas system.

[55 FR 8346, Mar. 7, 1990, as amended at 55 FR 37231, Sept. 10, 1990; 58 FR 3095, Jan. 7, 1993; 67 FR 68531, Nov. 12, 2002]

§ 61.341 Definitions.

Benzene concentration means the fraction by weight of benzene in a waste as determined in accordance with the procedures specified in §61.355 of this subpart.

Car-seal means a seal that is placed on a device that is used to change the position of a valve (e.g., from opened to closed) in such a way that the position of the valve cannot be changed without breaking

the seal.

Chemical manufacturing plant means any facility engaged in the production of chemicals by chemical, thermal, physical, or biological processes for use as a product, co-product, by-product, or intermediate including but not limited to industrial organic chemicals, organic pesticide products, pharmaceutical preparations, paint and allied products, fertilizers, and agricultural chemicals. Examples of chemical manufacturing plants include facilities at which process units are operated to produce one or more of the following chemicals: benzenesulfonic acid, benzene, chlorobenzene, cumene, cyclohexane, ethylene, ethylbenzene, hydroquinone, linear alkylbenzene, nitrobenzene, resorcinol, sulfolane, or styrene.

Closed-vent system means a system that is not open to the atmosphere and is composed of piping, ductwork, connections, and, if necessary, flow inducing devices that transport gas or vapor from an emission source to a control device.

Coke by-product recovery plant means any facility designed and operated for the separation and recovery of coal tar derivatives (by-products) evolved from coal during the coking process of a coke oven battery.

Container means any portable waste management unit in which a material is stored, transported, treated, or otherwise handled. Examples of containers are drums, barrels, tank trucks, barges, dumpsters, tank cars, dump trucks, and ships.

Control device means an enclosed combustion device, vapor recovery system, or flare.

Cover means a device or system which is placed on or over a waste placed in a waste management unit so that the entire waste surface area is enclosed and sealed to minimize air emissions. A cover may have openings necessary for operation, inspection, and maintenance of the waste management unit such as access hatches, sampling ports, and gauge wells provided that each opening is closed and sealed when not in use. Example of covers include a fixed roof installed on a tank, a lid installed on a container, and an air-supported enclosure installed over a waste management unit.

External floating roof means a pontoon-type or double-deck type cover with certain rim sealing mechanisms that rests on the liquid surface in a waste management unit with no fixed roof.

Facility means all process units and product tanks that generate waste within a stationary source, and all waste management units that are used for waste treatment, storage, or disposal within a stationary source.

Fixed roof means a cover that is mounted on a waste management unit in a stationary manner and that does not move with fluctuations in liquid level.

Floating roof means a cover with certain rim sealing mechanisms consisting of a double deck, pontoon single deck, internal floating cover or covered floating roof, which rests upon and is supported by the liquid being contained, and is equipped with a closure seal or seals to close the space between the roof edge and unit wall.

Flow indicator means a device which indicates whether gas flow is present in a line or vent system.

Fuel gas system means the offsite and onsite piping and control system that gathers gaseous streams generated by facility operations, may blend them with sources of gas, if available, and transports the blended gaseous fuel at suitable pressures for use as fuel in heaters, furnaces, boilers, incinerators, gas turbines, and other combustion devices located within or outside the facility. The fuel is piped directly to each individual combustion device, and the system typically operates at pressures over atmospheric.

Individual drain system means the system used to convey waste from a process unit, product storage tank, or waste management unit to a waste management unit. The term includes all process drains and common junction boxes, together with their associated sewer lines and other junction boxes, down to the receiving waste management unit.

Internal floating roof means a cover that rests or floats on the liquid surface inside a waste management unit that has a fixed roof.

Liquid-mounted seal means a foam or liquid-filled primary seal mounted in contact with the liquid between the waste management unit wall and the floating roof continuously around the circumference.

Loading means the introduction of waste into a waste management unit but not necessarily to complete capacity (also referred to as filling).

Maximum organic vapor pressure means the equilibrium partial pressure exerted by the waste at the temperature equal to the highest calendar-month average of the waste storage temperature for waste stored above or below the ambient temperature or at the local maximum monthly average temperature as reported by the National Weather Service for waste stored at the ambient temperature, as determined:

- (1) In accordance with §60.17(c); or
- (2) As obtained from standard reference texts; or
- (3) In accordance with §60.17(a)(37); or
- (4) Any other method approved by the Administrator.

No detectable emissions means less than 500 parts per million by volume (ppmv) above background levels, as measured by a detection instrument reading in accordance with the procedures specified in §61.355(h) of this subpart.

Oil-water separator means a waste management unit, generally a tank or surface impoundment, used to separate oil from water. An oil-water separator consists of not only the separation unit but also the forebay and other separator basins, skimmers, weirs, grit chambers, sludge hoppers, and bar screens that are located directly after the individual drain system and prior to additional treatment units such as an air flotation unit, clarifier, or biological treatment unit. Examples of an oil-water separator include an API separator, parallel-plate interceptor, and corrugated-plate interceptor with the associated ancillary equipment.

Petroleum refinery means any facility engaged in producing gasoline, kerosene, distillate fuel oils, residual fuel oils, lubricants, or other products through the distillation of petroleum, or through the redistillation, cracking, or reforming of unfinished petroleum derivatives.

Petroleum means the crude oil removed from the earth and the oils derived from tar sands, shale, and coal.

Point of waste generation means the location where the waste stream exits the process unit component or storage tank prior to handling or treatment in an operation that is not an integral part of the production process, or in the case of waste management units that generate new wastes after treatment, the location where the waste stream exits the waste management unit component.

Process unit means equipment assembled and connected by pipes or ducts to produce intermediate or final products. A process unit can be operated independently if supplied with sufficient fuel or raw materials and sufficient product storage facilities.

Process unit turnaround means the shutting down of the operations of a process unit, the purging of the contents of the process unit, the maintenance or repair work, followed by restarting of the process.

Process unit turnaround waste means a waste that is generated as a result of a process unit turnaround.

Process wastewater means water which comes in contact with benzene during manufacturing or processing operations conducted within a process unit. Process wastewater is not organic wastes, process fluids, product tank drawdown, cooling tower blowdown, steam trap condensate, or landfill leachate.

Process wastewater stream means a waste stream that contains only process wastewater.

Product tank means a stationary unit that is designed to contain an accumulation of materials that are fed to or produced by a process unit, and is constructed primarily of non-earthen materials (e.g., wood, concrete, steel, plastic) which provide structural support.

Product tank drawdown means any material or mixture of materials discharged from a product tank for the purpose of removing water or other contaminants from the product tank.

Safety device means a closure device such as a pressure relief valve, frangible disc, fusible plug, or any other type of device which functions exclusively to prevent physical damage or permanent deformation to a unit or its air emission control equipment by venting gases or vapors directly to the atmosphere during unsafe conditions resulting from an unplanned, accidental, or emergency event. For the purpose of this subpart, a safety device is not used for routine venting of gases or vapors from the vapor headspace underneath a cover such as during filling of the unit or to adjust the pressure in this vapor headspace in response to normal daily diurnal ambient temperature fluctuations. A safety device is designed to remain in a closed position during normal operations and open only when the internal pressure, or another relevant parameter, exceeds the device threshold setting applicable to the air emission control equipment as determined by the owner or operator based on manufacturer recommendations, applicable regulations, fire protection and prevention codes, standard engineering codes and practices, or other requirements for the safe handling of flammable, ignitable, explosive, reactive, or hazardous materials.

Segregated stormwater sewer system means a drain and collection system designed and operated for the sole purpose of collecting rainfall runoff at a facility, and which is segregated from all other individual drain systems.

Sewer line means a lateral, trunk line, branch line, or other enclosed conduit used to convey waste to a downstream waste management unit.

Slop oil means the floating oil and solids that accumulate on the surface of an oil-water separator.

Sour water stream means a stream that:

- (1) Contains ammonia or sulfur compounds (usually hydrogen sulfide) at concentrations of 10 ppm by weight or more;
- (2) Is generated from separation of water from a feed stock, intermediate, or product that contained ammonia or sulfur compounds; and
- (3) Requires treatment to remove the ammonia or sulfur compounds.

Sour water stripper means a unit that:

- (1) Is designed and operated to remove ammonia or sulfur compounds (usually hydrogen sulfide) from sour water streams;
- (2) Has the sour water streams transferred to the stripper through hard piping or other enclosed system; and
- (3) Is operated in such a manner that the offgases are sent to a sulfur recovery unit, processing unit, incinerator, flare, or other combustion device.

Surface impoundment means a waste management unit which is a natural topographic depression, man-made excavation, or diked area formed primarily of earthen materials (although it may be lined with man-made materials), which is designed to hold an accumulation of liquid wastes or waste containing free liquids, and which is not an injection well. Examples of surface impoundments are holding, storage, settling, and aeration pits, ponds, and lagoons.

Tank means a stationary waste management unit that is designed to contain an accumulation of waste and is constructed primarily of nonearthen materials (e.g., wood, concrete, steel, plastic) which provide structural support.

Treatment process means a stream stripping unit, thin-film evaporation unit, waste incinerator, or any other process used to comply with §61.348 of this subpart.

Vapor-mounted seal means a foam-filled primary seal mounted continuously around the perimeter of a waste management unit so there is an annular vapor space underneath the seal. The annular vapor space is bounded by the bottom of the primary seal, the unit wall, the liquid surface, and the floating roof.

Waste means any material resulting from industrial, commercial, mining or agricultural operations, or from community activities that is discarded or is being accumulated, stored, or physically, chemically, thermally, or biologically treated prior to being discarded, recycled, or discharged.

Waste management unit means a piece of equipment, structure, or transport mechanism used in handling, storage, treatment, or disposal of waste. Examples of a waste management unit include a tank, surface impoundment, container, oil-water separator, individual drain system, steam stripping unit, thin-film evaporation unit, waste incinerator, and landfill.

Waste stream means the waste generated by a particular process unit, product tank, or waste management unit. The characteristics of the waste stream (e.g., flow rate, benzene concentration, water content) are determined at the point of waste generation. Examples of a waste stream include process wastewater, product tank drawdown, sludge and slop oil removed from waste management units, and landfill leachate.

Wastewater treatment system means any component, piece of equipment, or installation that receives, manages, or treats process wastewater, product tank drawdown, or landfill leachate prior to direct or indirect discharge in accordance with the National Pollutant Discharge Elimination System permit regulations under 40 CFR part 122. These systems typically include individual drain systems, oil-water separators, air flotation units, equalization tanks, and biological treatment units.

Water seal controls means a seal pot, p-leg trap, or other type of trap filled with water (e.g., flooded sewers that maintain water levels adequate to prevent air flow through the system) that creates a water barrier between the sewer line and the atmosphere. The water level of the seal must be maintained in the vertical leg of a drain in order to be considered a water seal.

[55 FR 8346, Mar. 7, 1990; 55 FR 12444, Apr. 3, 1990, as amended at 58 FR 3095, Jan. 7, 1993; 67 FR 68531, Nov. 12, 2002]

§ 61.342 Standards: General.

(a) An owner or operator of a facility at which the total annual benzene quantity from facility waste is less than 10 megagrams per year (Mg/yr) (11 ton/yr) shall be exempt from the requirements of paragraphs (b) and (c) of this section. The total annual benzene quantity from facility waste is the sum of the annual benzene quantity for each waste stream at the facility that has a flow-weighted annual average water content greater than 10 percent or that is mixed with water, or other wastes, at any time and the mixture has an annual average water content greater than 10 percent. The benzene quantity in a waste stream is to be counted only once without multiple counting if other waste streams are mixed with or generated from the original waste stream. Other specific requirements for calculating the total annual benzene waste quantity are as follows:

(1) Wastes that are exempted from control under §§61.342(c)(2) and 61.342(c)(3) are included in the calculation of the total annual benzene quantity if they have an annual average water content greater than 10 percent, or if they are mixed with water or other wastes at any time and the mixture has an annual average water content greater than 10 percent.

(2) The benzene in a material subject to this subpart that is sold is included in the calculation of the total annual benzene quantity if the material has an annual average water content greater than 10 percent.

(3) Benzene in wastes generated by remediation activities conducted at the facility, such as the excavation of contaminated soil, pumping and treatment of groundwater, and the recovery of product from soil or groundwater, are not included in the calculation of total annual benzene quantity for that facility. If the facility's total annual benzene quantity is 10 Mg/yr (11 ton/yr) or more, wastes generated by

remediation activities are subject to the requirements of paragraphs (c) through (h) of this section. If the facility is managing remediation waste generated offsite, the benzene in this waste shall be included in the calculation of total annual benzene quantity in facility waste, if the waste streams have an annual average water content greater than 10 percent, or if they are mixed with water or other wastes at any time and the mixture has an annual average water content greater than 10 percent.

(4) The total annual benzene quantity is determined based upon the quantity of benzene in the waste before any waste treatment occurs to remove the benzene except as specified in §61.355(c)(1)(i) (A) through (C).

(b) Each owner or operator of a facility at which the total annual benzene quantity from facility waste is equal to or greater than 10 Mg/yr (11 ton/yr) as determined in paragraph (a) of this section shall be in compliance with the requirements of paragraphs (c) through (h) of this section no later than 90 days following the effective date, unless a waiver of compliance has been obtained under §61.11, or by the initial startup for a new source with an initial startup after the effective date.

(1) The owner or operator of an existing source unable to comply with the rule within the required time may request a waiver of compliance under §61.10.

(2) As part of the waiver application, the owner or operator shall submit to the Administrator a plan under §61.10(b)(3) that is an enforceable commitment to obtain environmental benefits to mitigate the benzene emissions that result from extending the compliance date. The plan shall include the following information:

(i) A description of the method of compliance, including the control approach, schedule for installing controls, and quantity of the benzene emissions that result from extending the compliance date;

(ii) If the control approach involves a compliance strategy designed to obtain integrated compliance with multiple regulatory requirements, a description of the other regulations involved and their effective dates; and

(iii) A description of the actions to be taken at the facility to obtain mitigating environmental benefits, including how the benefits will be obtained, the schedule for these actions, and an estimate of the quantifiable benefits that directly result from these actions.

(c) Each owner or operator of a facility at which the total annual benzene quantity from facility waste is equal to or greater than 10 Mg/yr (11 ton/yr) as determined in paragraph (a) of this section shall manage and treat the facility waste as follows:

(1) For each waste stream that contains benzene, including (but not limited to) organic waste streams that contain less than 10 percent water and aqueous waste streams, even if the wastes are not discharged to an individual drain system, the owner or operator shall:

(i) Remove or destroy the benzene contained in the waste using a treatment process or wastewater treatment system that complies with the standards specified in §61.348 of this subpart.

(ii) Comply with the standards specified in §§61.343 through 61.347 of this subpart for each waste management unit that receives or manages the waste stream prior to and during treatment of the waste stream in accordance with paragraph (c)(1)(i) of this section.

(iii) Each waste management unit used to manage or treat waste streams that will be recycled to a process shall comply with the standards specified in §§61.343 through 61.347. Once the waste stream is recycled to a process, including to a tank used for the storage of production process feed, product, or product intermediates, unless this tank is used primarily for the storage of wastes, the material is no longer subject to paragraph (c) of this section.

(2) A waste stream is exempt from paragraph (c)(1) of this section provided that the owner or operator demonstrates initially and, thereafter, at least once per year that the flow-weighted annual average benzene concentration for the waste stream is less than 10 ppmw as determined by the procedures specified in §61.355(c)(2) or §61.355(c)(3).

(3) A waste stream is exempt from paragraph (c)(1) of this section provided that the owner or operator demonstrates initially and, thereafter, at least once per year that the conditions specified in either paragraph (c)(3)(i) or (c)(3)(ii) of this section are met.

(i) The waste stream is process wastewater that has a flow rate less than 0.02 liters per minute (0.005 gallons per minute) or an annual wastewater quantity of less than 10 Mg/yr (11 ton/yr); or

(ii) All of the following conditions are met:

(A) The owner or operator does not choose to exempt process wastewater under paragraph (c)(3)(i) of this section,

(B) The total annual benzene quantity in all waste streams chosen for exemption in paragraph (c)(3)(ii) of this section does not exceed 2.0 Mg/yr (2.2 ton/yr) as determined in the procedures in §61.355(j), and

(C) The total annual benzene quantity in a waste stream chosen for exemption, including process unit turnaround waste, is determined for the year in which the waste is generated.

(d) As an alternative to the requirements specified in paragraphs (c) and (e) of this section, an owner or operator of a facility at which the total annual benzene quantity from facility waste is equal to or greater than 10 Mg/yr (11 ton/yr) as determined in paragraph (a) of this section may elect to manage and treat the facility waste as follows:

(1) The owner or operator shall manage and treat facility waste other than process wastewater in accordance with the requirements of paragraph (c)(1) of this section.

(2) The owner or operator shall manage and treat process wastewater in accordance with the following requirements:

(i) Process wastewater shall be treated to achieve a total annual benzene quantity from facility process wastewater less than 1 Mg/yr (1.1 ton/yr). Total annual benzene from facility process wastewater shall be determined by adding together the annual benzene quantity at the point of waste generation for each untreated process wastewater stream plus the annual benzene quantity exiting the treatment process for each process wastewater stream treated in accordance with the requirements of paragraph (c)(1)(i) of this section.

(ii) Each treated process wastewater stream identified in paragraph (d)(2)(i) of this section shall be managed and treated in accordance with paragraph (c)(1) of this section.

(iii) Each untreated process wastewater stream identified in paragraph (d)(2)(i) of this section is exempt from the requirements of paragraph (c)(1) of this section.

(e) As an alternative to the requirements specified in paragraphs (c) and (d) of this section, an owner or operator of a facility at which the total annual benzene quantity from facility waste is equal to or greater than 10 Mg/yr (11 ton/yr) as determined in paragraph (a) of this section may elect to manage and treat the facility waste as follows:

(1) The owner or operator shall manage and treat facility waste with a flow-weighted annual average water content of less than 10 percent in accordance with the requirements of paragraph (c)(1) of this section; and

(2) The owner or operator shall manage and treat facility waste (including remediation and process unit turnaround waste) with a flow-weighted annual average water content of 10 percent or greater, on a volume basis as total water, and each waste stream that is mixed with water or wastes at any time such that the resulting mixture has an annual water content greater than 10 percent, in accordance with the following:

(i) The benzene quantity for the wastes described in paragraph (e)(2) of this section must be equal to or less than 6.0 Mg/yr (6.6 ton/yr), as determined in §61.355(k). Wastes as described in paragraph (e)(2) of this section that are transferred offsite shall be included in the determination of benzene quantity as

provided in §61.355(k). The provisions of paragraph (f) of this section shall not apply to any owner or operator who elects to comply with the provisions of paragraph (e) of this section.

(ii) The determination of benzene quantity for each waste stream defined in paragraph (e)(2) of this section shall be made in accordance with §61.355(k).

(f) Rather than treating the waste onsite, an owner or operator may elect to comply with paragraph (c)(1)(i) of this section by transferring the waste offsite to another facility where the waste is treated in accordance with the requirements of paragraph (c)(1)(i) of this section. The owner or operator transferring the waste shall:

(1) Comply with the standards specified in §§61.343 through 61.347 of this subpart for each waste management unit that receives or manages the waste prior to shipment of the waste offsite.

(2) Include with each offsite waste shipment a notice stating that the waste contains benzene which is required to be managed and treated in accordance with the provisions of this subpart.

(g) Compliance with this subpart will be determined by review of facility records and results from tests and inspections using methods and procedures specified in §61.355 of this subpart.

(h) Permission to use an alternative means of compliance to meet the requirements of §§61.342 through 61.352 of this subpart may be granted by the Administrator as provided in §61.353 of this subpart.

[55 FR 8346, Mar. 7, 1990, as amended at 58 FR 3095, Jan. 7, 1993; 65 FR 62159, 62160, Oct. 17, 2000]

§ 61.343 Standards: Tanks.

(a) Except as provided in paragraph (b) of this section and in §61.351, the owner or operator must meet the standards in paragraph (a)(1) or (2) of this section for each tank in which the waste stream is placed in accordance with §61.342 (c)(1)(ii). The standards in this section apply to the treatment and storage of the waste stream in a tank, including dewatering.

(1) The owner or operator shall install, operate, and maintain a fixed-roof and closed-vent system that routes all organic vapors vented from the tank to a control device.

(i) The fixed-roof shall meet the following requirements:

(A) The cover and all openings (e.g., access hatches, sampling ports, and gauge wells) shall be designed to operate with no detectable emissions as indicated by an instrument reading of less than 500 ppmv above background, as determined initially and thereafter at least once per year by the methods specified in §61.355(h) of this subpart.

(B) Each opening shall be maintained in a closed, sealed position (e.g., covered by a lid that is gasketed and latched) at all times that waste is in the tank except when it is necessary to use the opening for waste sampling or removal, or for equipment inspection, maintenance, or repair.

(C) If the cover and closed-vent system operate such that the tank is maintained at a pressure less than atmospheric pressure, then paragraph (a)(1)(i)(B) of this section does not apply to any opening that meets all of the following conditions:

(1) The purpose of the opening is to provide dilution air to reduce the explosion hazard;

(2) The opening is designed to operate with no detectable emissions as indicated by an instrument reading of less than 500 ppmv above background, as determined initially and thereafter at least once per year by the methods specified in §61.355(h); and

(3) The pressure is monitored continuously to ensure that the pressure in the tank remains below atmospheric pressure.

(ii) The closed-vent system and control device shall be designed and operated in accordance with the requirements of §61.349 of this subpart.

(2) The owner or operator must install, operate, and maintain an enclosure and closed-vent system that routes all organic vapors vented from the tank, located inside the enclosure, to a control device in accordance with the requirements specified in paragraph (e) of this section.

(b) For a tank that meets all the conditions specified in paragraph (b)(1) of this section, the owner or operator may elect to comply with paragraph (b)(2) of this section as an alternative to the requirements specified in paragraph (a)(1) of this section.

(1) The waste managed in the tank complying with paragraph (b)(2) of this section shall meet all of the following conditions:

(i) Each waste stream managed in the tank must have a flow-weighted annual average water content less than or equal to 10 percent water, on a volume basis as total water.

(ii) The waste managed in the tank either:

(A) Has a maximum organic vapor pressure less than 5.2 kilopascals (kPa) (0.75 pounds per square inch (psi));

(B) Has a maximum organic vapor pressure less than 27.6 kPa (4.0 psi) and is managed in a tank having design capacity less than 151 m³ (40,000 gal); or

(C) Has a maximum organic vapor pressure less than 76.6 kPa (11.1 psi) and is managed in a tank having a design capacity less than 75 m³ (20,000 gal).

(2) The owner or operator shall install, operate, and maintain a fixed roof as specified in paragraph (a)(1)(i).

(3) For each tank complying with paragraph (b) of this section, one or more devices which vent directly to the atmosphere may be used on the tank provided each device remains in a closed, sealed position during normal operations except when the device needs to open to prevent physical damage or permanent deformation of the tank or cover resulting from filling or emptying the tank, diurnal temperature changes, atmospheric pressure changes or malfunction of the unit in accordance with good engineering and safety practices for handling flammable, explosive, or other hazardous materials.

(c) Each fixed-roof, seal, access door, and all other openings shall be checked by visual inspection initially and quarterly thereafter to ensure that no cracks or gaps occur and that access doors and other openings are closed and gasketed properly.

(d) Except as provided in §61.350 of this subpart, when a broken seal or gasket or other problem is identified, or when detectable emissions are measured, first efforts at repair shall be made as soon as practicable, but not later than 45 calendar days after identification.

(e) Each owner or operator who controls air pollutant emissions by using an enclosure vented through a closed-vent system to a control device must meet the requirements specified in paragraphs (e)(1) through (4) of this section.

(1) The tank must be located inside a total enclosure. The enclosure must be designed and operated in accordance with the criteria for a permanent total enclosure as specified in "Procedure T—Criteria for and Verification of a Permanent or Temporary Total Enclosure" in 40 CFR 52.741, appendix B. The enclosure may have permanent or temporary openings to allow worker access; passage of material into or out of the enclosure by conveyor, vehicles, or other mechanical means; entry of permanent mechanical or electrical equipment; or direct airflow into the enclosure. The owner or operator must perform the verification procedure for the enclosure as specified in section 5.0 of Procedure T initially when the enclosure is first installed and, thereafter, annually. A facility that has conducted an initial compliance demonstration and that performs annual compliance demonstrations in accordance with the requirements for Tank Level 2 control requirements 40 CFR 264.1084(i) or 40 CFR 265(i) is not required

to make repeat demonstrations of initial and continuous compliance for the purposes of this subpart.

(2) The enclosure must be vented through a closed-vent system to a control device that is designed and operated in accordance with the standards for control devices specified in §61.349.

(3) Safety devices, as defined in this subpart, may be installed and operated as necessary on any enclosure, closed-vent system, or control device used to comply with the requirements of paragraphs (e) (1) and (2) of this section.

(4) The closed-vent system must be designed and operated in accordance with the requirements of §61.349.

[55 FR 8346, Mar. 7, 1990, as amended at 55 FR 18331, May 2, 1990; 58 FR 3096, Jan. 7, 1993; 67 FR 68532, Nov. 12, 2002; 68 FR 6082, Feb. 6, 2003; 68 FR 67935, Dec. 4, 2003]

§ 61.344 Standards: Surface impoundments.

(a) The owner or operator shall meet the following standards for each surface impoundment in which waste is placed in accordance with §61.342(c)(1)(ii) of this subpart:

(1) The owner or operator shall install, operate, and maintain on each surface impoundment a cover (e.g., air-supported structure or rigid cover) and closed-vent system that routes all organic vapors vented from the surface impoundment to a control device.

(i) The cover shall meet the following requirements:

(A) The cover and all openings (e.g., access hatches, sampling ports, and gauge wells) shall be designed to operate with no detectable emissions as indicated by an instrument reading of less than 500 ppmv above background, initially and thereafter at least once per year by the methods specified in §61.355(h) of this subpart.

(B) Each opening shall be maintained in a closed, sealed position (e.g., covered by a lid that is gasketed and latched) at all times that waste is in the surface impoundment except when it is necessary to use the opening for waste sampling or removal, or for equipment inspection, maintenance, or repair.

(C) If the cover and closed-vent system operate such that the enclosure of the surface impoundment is maintained at a pressure less than atmospheric pressure, then paragraph (a)(1)(i)(B) of this section does not apply to any opening that meets all of the following conditions:

(1) The purpose of the opening is to provide dilution air to reduce the explosion hazard;

(2) The opening is designed to operate with no detectable emissions as indicated by an instrument reading of less than 500 ppmv above background, as determined initially and thereafter at least once per year by the methods specified in §61.355(h) of this subpart; and

(3) The pressure is monitored continuously to ensure that the pressure in the enclosure of the surface impoundment remains below atmospheric pressure.

(D) The cover shall be used at all times that waste is placed in the surface impoundment except during removal of treatment residuals in accordance with 40 CFR 268.4 or closure of the surface impoundment in accordance with 40 CFR 264.228. (Note: the treatment residuals generated by these activities may be subject to the requirements of this part.)

(ii) The closed-vent system and control device shall be designed and operated in accordance with §61.349 of this subpart.

(b) Each cover seal, access hatch, and all other openings shall be checked by visual inspection initially and quarterly thereafter to ensure that no cracks or gaps occur and that access hatches and other openings are closed and gasketed properly.

(c) Except as provided in §61.350 of this subpart, when a broken seal or gasket or other problem is identified, or when detectable emissions are measured, first efforts at repair shall be made as soon as practicable, but not later than 15 calendar days after identification.

[55 FR 8346, Mar. 7, 1990, as amended at 58 FR 3097, Jan. 7, 1993]

§ 61.345 Standards: Containers.

(a) The owner or operator shall meet the following standards for each container in which waste is placed in accordance with §61.342(c)(1)(ii) of this subpart:

(1) The owner or operator shall install, operate, and maintain a cover on each container used to handle, transfer, or store waste in accordance with the following requirements:

(i) The cover and all openings (e.g., bungs, hatches, and sampling ports) shall be designed to operate with no detectable emissions as indicated by an instrument reading of less than 500 ppmv above background, initially and thereafter at least once per year by the methods specified in §61.355(h) of this subpart.

(ii) Except as provided in paragraph (a)(4) of this section, each opening shall be maintained in a closed, sealed position (e.g., covered by a lid that is gasketed and latched) at all times that waste is in the container except when it is necessary to use the opening for waste loading, removal, inspection, or sampling.

(2) When a waste is transferred into a container by pumping, the owner or operator shall perform the transfer using a submerged fill pipe. The submerged fill pipe outlet shall extend to within two fill pipe diameters of the bottom of the container while the container is being loaded. During loading of the waste, the cover shall remain in place and all openings shall be maintained in a closed, sealed position except for those openings required for the submerged fill pipe, those openings required for venting of the container to prevent physical damage or permanent deformation of the container or cover, and any openings complying with paragraph (a)(4) of this section.

(3) Treatment of a waste in a container, including aeration, thermal or other treatment, must be performed by the owner or operator in a manner such that while the waste is being treated the container meets the standards specified in paragraphs (a)(3)(i) through (iii) of this section, except for covers and closed-vent systems that meet the requirements in paragraph (a)(4) of this section.

(i) The owner or operator must either:

(A) Vent the container inside a total enclosure which is exhausted through a closed-vent system to a control device in accordance with the requirements of paragraphs (a)(3)(ii)(A) and (B) of this section; or

(B) Vent the covered or closed container directly through a closed-vent system to a control device in accordance with the requirements of paragraphs (a)(3)(ii)(B) and (C) of this section.

(ii) The owner or operator must meet the following requirements, as applicable to the type of air emission control equipment selected by the owner or operator:

(A) The total enclosure must be designed and operated in accordance with the criteria for a permanent total enclosure as specified in section 5 of the "Procedure T—Criteria for and Verification of a Permanent or Temporary Total Enclosure" in 40 CFR 52.741, appendix B. The enclosure may have permanent or temporary openings to allow worker access; passage of containers through the enclosure by conveyor or other mechanical means; entry of permanent mechanical or electrical equipment; or direct airflow into the enclosure. The owner or operator must perform the verification procedure for the enclosure as specified in section 5.0 of "Procedure T—Criteria for and Verification of a Permanent or Temporary Total Enclosure" initially when the enclosure is first installed and, thereafter, annually. A facility that has conducted an initial compliance demonstration and that performs annual compliance demonstrations in accordance with the Container Level 3 control requirements in 40 CFR 264.1086(e)(2)(i) or 40 CFR 265.1086(e)(2)(i) is not required to make repeat demonstrations of initial and continuous compliance for the purposes of this subpart.

(B) The closed-vent system and control device must be designed and operated in accordance with the requirements of §61.349.

(C) For a container cover, the cover and all openings (e.g., doors, hatches) must be designed to operate with no detectable emissions as indicated by an instrument reading of less than 500 ppmv above background, initially and thereafter at least once per year by the methods specified in §61.355(h).

(iii) Safety devices, as defined in this subpart, may be installed and operated as necessary on any container, enclosure, closed-vent system, or control device used to comply with the requirements of paragraph (a)(3)(i) of this section.

(4) If the cover and closed-vent system operate such that the container is maintained at a pressure less than atmospheric pressure, the owner or operator may operate the system with an opening that is not sealed and kept closed at all times if the following conditions are met:

(i) The purpose of the opening is to provide dilution air to reduce the explosion hazard;

(ii) The opening is designed to operate with no detectable emissions as indicated by an instrument reading of less than 500 ppmv above background, as determined initially and thereafter at least once per year by methods specified in §61.355(h); and

(iii) The pressure is monitored continuously to ensure that the pressure in the container remains below atmospheric pressure.

(b) Each cover and all openings shall be visually inspected initially and quarterly thereafter to ensure that they are closed and gasketed properly.

(c) Except as provided in §61.350 of this subpart, when a broken seal or gasket or other problem is identified, first efforts at repair shall be made as soon as practicable, but not later than 15 calendar days after identification.

[55 FR 8346, Mar. 7, 1990, as amended at 58 FR 3097, Jan. 7, 1993; 67 FR 68532, Nov. 12, 2002; 68 FR 67936, Dec. 4, 2003]

§ 61.346 Standards: Individual drain systems.

(a) Except as provided in paragraph (b) of this section, the owner or operator shall meet the following standards for each individual drain system in which waste is placed in accordance with §61.342(c)(1)(ii) of this subpart:

(1) The owner or operator shall install, operate, and maintain on each drain system opening a cover and closed-vent system that routes all organic vapors vented from the drain system to a control device.

(i) The cover shall meet the following requirements:

(A) The cover and all openings (e.g., access hatches, sampling ports) shall be designed to operate with no detectable emissions as indicated by an instrument reading of less than 500 ppmv above background, initially and thereafter at least once per year by the methods specified in §61.355(h) of this subpart.

(B) Each opening shall be maintained in a closed, sealed position (e.g., covered by a lid that is gasketed and latched) at all times that waste is in the drain system except when it is necessary to use the opening for waste sampling or removal, or for equipment inspection, maintenance, or repair.

(C) If the cover and closed-vent system operate such that the individual drain system is maintained at a pressure less than atmospheric pressure, then paragraph (a)(1)(i)(B) of this section does not apply to any opening that meets all of the following conditions:

(1) The purpose of the opening is to provide dilution air to reduce the explosion hazard;

(2) The opening is designed to operate with no detectable emissions as indicated by an instrument reading of less than 500 ppmv above background, as determined initially and thereafter at least once per year by the methods specified in §61.355(h); and

(3) The pressure is monitored continuously to ensure that the pressure in the individual drain system remains below atmospheric pressure.

(ii) The closed-vent system and control device shall be designed and operated in accordance with §61.349 of this subpart.

(2) Each cover seal, access hatch, and all other openings shall be checked by visual inspection initially and quarterly thereafter to ensure that no cracks or gaps occur and that access hatches and other openings are closed and gasketed properly.

(3) Except as provided in §61.350 of this subpart, when a broken seal or gasket or other problem is identified, or when detectable emissions are measured, first efforts at repair shall be made as soon as practicable, but not later than 15 calendar days after identification.

(b) As an alternative to complying with paragraph (a) of this section, an owner or operator may elect to comply with the following requirements:

(1) Each drain shall be equipped with water seal controls or a tightly sealed cap or plug.

(2) Each junction box shall be equipped with a cover and may have a vent pipe. The vent pipe shall be at least 90 cm (3 ft) in length and shall not exceed 10.2 cm (4 in) in diameter.

(i) Junction box covers shall have a tight seal around the edge and shall be kept in place at all times, except during inspection and maintenance.

(ii) One of the following methods shall be used to control emissions from the junction box vent pipe to the atmosphere:

(A) Equip the junction box with a system to prevent the flow of organic vapors from the junction box vent pipe to the atmosphere during normal operation. An example of such a system includes use of water seal controls on the junction box. A flow indicator shall be installed, operated, and maintained on each junction box vent pipe to ensure that organic vapors are not vented from the junction box to the atmosphere during normal operation.

(B) Connect the junction box vent pipe to a closed-vent system and control device in accordance with §61.349 of this subpart.

(3) Each sewer line shall not be open to the atmosphere and shall be covered or enclosed in a manner so as to have no visual gaps or cracks in joints, seals, or other emission interfaces.

(4) Equipment installed in accordance with paragraphs (b)(1), (b)(2), or (b)(3) of this section shall be inspected as follows:

(i) Each drain using water seal controls shall be checked by visual or physical inspection initially and thereafter quarterly for indications of low water levels or other conditions that would reduce the effectiveness of water seal controls.

(ii) Each drain using a tightly sealed cap or plug shall be visually inspected initially and thereafter quarterly to ensure caps or plugs are in place and properly installed.

(iii) Each junction box shall be visually inspected initially and thereafter quarterly to ensure that the cover is in place and to ensure that the cover has a tight seal around the edge.

(iv) The unburied portion of each sewer line shall be visually inspected initially and thereafter quarterly for indication of cracks, gaps, or other problems that could result in benzene emissions.

(5) Except as provided in §61.350 of this subpart, when a broken seal, gap, crack or other problem is identified, first efforts at repair shall be made as soon as practicable, but not later than 15 calendar days after identification.

[55 FR 8346, Mar. 7, 1990, as amended at 55 FR 37231, Sept. 10, 1990; 58 FR 3097, Jan. 7, 1993]

§ 61.347 Standards: Oil-water separators.

(a) Except as provided in §61.352 of this subpart, the owner or operator shall meet the following standards for each oil-water separator in which waste is placed in accordance with §61.342(c)(1)(ii) of this subpart:

(1) The owner or operator shall install, operate, and maintain a fixed-roof and closed-vent system that routes all organic vapors vented from the oil-water separator to a control device.

(i) The fixed-roof shall meet the following requirements:

(A) The cover and all openings (e.g., access hatches, sampling ports, and gauge wells) shall be designed to operate with no detectable emissions as indicated by an instrument reading of less than 500 ppmv above background, as determined initially and thereafter at least once per year by the methods specified in §61.355(h) of this subpart.

(B) Each opening shall be maintained in a closed, sealed position (e.g., covered by a lid that is gasketed and latched) at all times that waste is in the oil-water separator except when it is necessary to use the opening for waste sampling or removal, or for equipment inspection, maintenance, or repair.

(C) If the cover and closed-vent system operate such that the oil-water separator is maintained at a pressure less than atmospheric pressure, then paragraph (a)(1)(i)(B) of this section does not apply to any opening that meets all of the following conditions:

(1) The purpose of the opening is to provide dilution air to reduce the explosion hazard;

(2) The opening is designed to operate with no detectable emissions as indicated by an instrument reading of less than 500 ppmv above background, as determined initially and thereafter at least once per year by the methods specified in §61.355(h); and

(3) The pressure is monitored continuously to ensure that the pressure in the oil-water separator remains below atmospheric pressure.

(ii) The closed-vent system and control device shall be designed and operated in accordance with the requirements of §61.349 of this subpart.

(b) Each cover seal, access hatch, and all other openings shall be checked by visual inspection initially and quarterly thereafter to ensure that no cracks or gaps occur between the cover and oil-water separator wall and that access hatches and other openings are closed and gasketed properly.

(c) Except as provided in §61.350 of this subpart, when a broken seal or gasket or other problem is identified, or when detectable emissions are measured, first efforts at repair shall be made as soon as practicable, but not later than 15 calendar days after identification.

[55 FR 8346, Mar. 7, 1990, as amended at 58 FR 3098, Jan. 7, 1993]

§ 61.348 Standards: Treatment processes.

(a) Except as provided in paragraph (a)(5) of this section, the owner or operator shall treat the waste stream in accordance with the following requirements:

(1) The owner or operator shall design, install, operate, and maintain a treatment process that either:

- (i) Removes benzene from the waste stream to a level less than 10 parts per million by weight (ppmw) on a flow-weighted annual average basis,
- (ii) Removes benzene from the waste stream by 99 percent or more on a mass basis, or
- (iii) Destroys benzene in the waste stream by incinerating the waste in a combustion unit that achieves a destruction efficiency of 99 percent or greater for benzene.
- (2) Each treatment process complying with paragraphs (a)(1)(i) or (a)(1)(ii) of this section shall be designed and operated in accordance with the appropriate waste management unit standards specified in §§61.343 through 61.347 of this subpart. For example, if a treatment process is a tank, then the owner or operator shall comply with §61.343 of this subpart.
- (3) For the purpose of complying with the requirements specified in paragraph (a)(1)(i) of this section, the intentional or unintentional reduction in the benzene concentration of a waste stream by dilution of the waste stream with other wastes or materials is not allowed.
- (4) An owner or operator may aggregate or mix together individual waste streams to create a combined waste stream for the purpose of facilitating treatment of waste to comply with the requirements of paragraph (a)(1) of this section except as provided in paragraph (a)(5) of this section.
- (5) If an owner or operator aggregates or mixes any combination of process wastewater, product tank drawdown, or landfill leachate subject to §61.342(c)(1) of this subpart together with other waste streams to create a combined waste stream for the purpose of facilitating management or treatment of waste in a wastewater treatment system, then the wastewater treatment system shall be operated in accordance with paragraph (b) of this section. These provisions apply to above-ground wastewater treatment systems as well as those that are at or below ground level.
- (b) Except for facilities complying with §61.342(e), the owner or operator that aggregates or mixes individual waste streams as defined in paragraph (a)(5) of this section for management and treatment in a wastewater treatment system shall comply with the following requirements:
- (1) The owner or operator shall design and operate each waste management unit that comprises the wastewater treatment system in accordance with the appropriate standards specified in §§61.343 through 61.347 of this subpart.
- (2) The provisions of paragraph (b)(1) of this section do not apply to any waste management unit that the owner or operator demonstrates to meet the following conditions initially and, thereafter, at least once per year:
- (i) The benzene content of each waste stream entering the waste management unit is less than 10 ppmw on a flow-weighted annual average basis as determined by the procedures specified in §61.355 (c) of this subpart; and
- (ii) The total annual benzene quantity contained in all waste streams managed or treated in exempt waste management units comprising the facility wastewater treatment systems is less than 1 Mg/yr (1.1 ton/yr). For this determination, total annual benzene quantity shall be calculated as follows:
- (A) The total annual benzene quantity shall be calculated as the sum of the individual benzene quantities determined at each location where a waste stream first enters an exempt waste management unit. The benzene quantity discharged from an exempt waste management unit shall not be included in this calculation.
- (B) The annual benzene quantity in a waste stream managed or treated in an enhanced biodegradation unit shall not be included in the calculation of the total annual benzene quantity, if the enhanced biodegradation unit is the first exempt unit in which the waste is managed or treated. A unit shall be considered enhanced biodegradation if it is a suspended-growth process that generates biomass, uses recycled biomass, and periodically removes biomass from the process. An enhanced biodegradation unit typically operates at a food-to-microorganism ratio in the range of 0.05 to 1.0 kg of biological oxygen demand per kg of biomass per day, a mixed liquor suspended solids ratio in the range of 1 to 8 grams per liter (0.008 to 0.7 pounds per liter), and a residence time in the range of 3 to 36 hours.

(c) The owner and operator shall demonstrate that each treatment process or wastewater treatment system unit, except as provided in paragraph (d) of this section, achieves the appropriate conditions specified in paragraphs (a) or (b) of this section in accordance with the following requirements:

(1) Engineering calculations in accordance with requirements specified in §61.356(e) of this subpart; or

(2) Performance tests conducted using the test methods and procedures that meet the requirements specified in §61.355 of this subpart.

(d) A treatment process or waste stream is in compliance with the requirements of this subpart and exempt from the requirements of paragraph (c) of this section provided that the owner or operator documents that the treatment process or waste stream is in compliance with other regulatory requirements as follows:

(1) The treatment process is a hazardous waste incinerator for which the owner or operator has been issued a final permit under 40 CFR part 270 and complies with the requirements of 40 CFR part 264, subpart O;

(2) The treatment process is an industrial furnace or boiler burning hazardous waste for energy recovery for which the owner or operator has been issued a final permit under 40 CFR part 270 and complies with the requirements of 40 CFR part 266, subpart D;

(3) The waste stream is treated by a means or to a level that meets benzene-specific treatment standards in accordance with the Land Disposal Restrictions under 40 CFR part 268, and the treatment process is designed and operated with a closed-vent system and control device meeting the requirements of §61.349 of this subpart;

(4) The waste stream is treated by a means or to a level that meets benzene-specific effluent limitations or performance standards in accordance with the Effluent Guidelines and Standards under 40 CFR parts 401–464, and the treatment process is designed and operated with a closed-vent system and control device meeting the requirements of §61.349 of this subpart; or

(5) The waste stream is discharged to an underground injection well for which the owner or operator has been issued a final permit under 40 CFR part 270 and complies with the requirements of 40 CFR part 122.

(e) Except as specified in paragraph (e)(3) of this section, if the treatment process or wastewater treatment system unit has any openings (e.g., access doors, hatches, etc.), all such openings shall be sealed (e.g., gasketed, latched, etc.) and kept closed at all times when waste is being treated, except during inspection and maintenance.

(1) Each seal, access door, and all other openings shall be checked by visual inspections initially and quarterly thereafter to ensure that no cracks or gaps occur and that openings are closed and gasketed properly.

(2) Except as provided in §61.350 of this subpart, when a broken seal or gasket or other problem is identified, first efforts at repair shall be made as soon as practicable, but not later than 15 calendar days after identification.

(3) If the cover and closed-vent system operate such that the treatment process and wastewater treatment system unit are maintained at a pressure less than atmospheric pressure, the owner or operator may operate the system with an opening that is not sealed and kept closed at all times if the following conditions are met:

(i) The purpose of the opening is to provide dilution air to reduce the explosion hazard;

(ii) The opening is designed to operate with no detectable emissions as indicated by an instrument reading of less than 500 ppmv above background, as determined initially and thereafter at least once per year by the methods specified in §61.355(h); and

(iii) The pressure is monitored continuously to ensure that the pressure in the treatment process and wastewater treatment system unit remain below atmospheric pressure.

(f) Except for treatment processes complying with paragraph (d) of this section, the Administrator may request at any time an owner or operator demonstrate that a treatment process or wastewater treatment system unit meets the applicable requirements specified in paragraphs (a) or (b) of this section by conducting a performance test using the test methods and procedures as required in §61.355 of this subpart.

(g) The owner or operator of a treatment process or wastewater treatment system unit that is used to comply with the provisions of this section shall monitor the unit in accordance with the applicable requirements in §61.354 of this subpart.

[55 FR 8346, Mar. 7, 1990, as amended at 55 FR 37231, Sept. 10, 1990; 58 FR 3098, Jan. 7, 1993; 65 FR 62160, Oct. 17, 2000]

§ 61.349 Standards: Closed-vent systems and control devices.

(a) For each closed-vent system and control device used to comply with standards in accordance with §§61.343 through 61.348 of this subpart, the owner or operator shall properly design, install, operate, and maintain the closed-vent system and control device in accordance with the following requirements:

(1) The closed-vent system shall:

(i) Be designed to operate with no detectable emissions as indicated by an instrument reading of less than 500 ppmv above background, as determined initially and thereafter at least once per year by the methods specified in §61.355(h) of this subpart.

(ii) Vent systems that contain any bypass line that could divert the vent stream away from a control device used to comply with the provisions of this subpart shall install, maintain, and operate according to the manufacturer's specifications a flow indicator that provides a record of vent stream flow away from the control device at least once every 15 minutes, except as provided in paragraph (a)(1)(ii)(B) of this section.

(A) The flow indicator shall be installed at the entrance to any bypass line that could divert the vent stream away from the control device to the atmosphere.

(B) Where the bypass line valve is secured in the closed position with a car-seal or a lock-and-key type configuration, a flow indicator is not required.

(iii) All gauging and sampling devices shall be gas-tight except when gauging or sampling is taking place.

(iv) For each closed-vent system complying with paragraph (a) of this section, one or more devices which vent directly to the atmosphere may be used on the closed-vent system provided each device remains in a closed, sealed position during normal operations except when the device needs to open to prevent physical damage or permanent deformation of the closed-vent system resulting from malfunction of the unit in accordance with good engineering and safety practices for handling flammable, explosive, or other hazardous materials.

(2) The control device shall be designed and operated in accordance with the following conditions:

(i) An enclosed combustion device (e.g., a vapor incinerator, boiler, or process heater) shall meet one of the following conditions:

(A) Reduce the organic emissions vented to it by 95 weight percent or greater;

(B) Achieve a total organic compound concentration of 20 ppmv (as the sum of the concentrations for individual compounds using Method 18) on a dry basis corrected to 3 percent oxygen; or

(C) Provide a minimum residence time of 0.5 seconds at a minimum temperature of 760 °C (1,400 °F). If a boiler or process heater issued as the control device, then the vent stream shall be introduced into the flame zone of the boiler or process heater.

(ii) A vapor recovery system (e.g., a carbon adsorption system or a condenser) shall recover or control the organic emissions vented to it with an efficiency of 95 weight percent or greater, or shall recover or control the benzene emissions vented to it with an efficiency of 98 weight percent or greater.

(iii) A flare shall comply with the requirements of 40 CFR 60.18.

(iv) A control device other than those described in paragraphs (a)(2) (i) through (iii) of this section may be used provided that the following conditions are met:

(A) The device shall recover or control the organic emissions vented to it with an efficiency of 95 weight percent or greater, or shall recover or control the benzene emissions vented to it with an efficiency of 98 weight percent or greater.

(B) The owner or operator shall develop test data and design information that documents the control device will achieve an emission control efficiency of either 95 percent or greater for organic compounds or 98 percent or greater for benzene.

(C) The owner or operator shall identify:

(1) The critical operating parameters that affect the emission control performance of the device;

(2) The range of values of these operating parameters that ensure the emission control efficiency specified in paragraph (a)(2)(iv)(A) of this section is maintained during operation of the device; and

(3) How these operating parameters will be monitored to ensure the proper operation and maintenance of the device.

(D) The owner or operator shall submit the information and data specified in paragraphs (a)(2)(iv) (B) and (C) of this section to the Administrator prior to operation of the alternative control device.

(E) The Administrator will determine, based on the information submitted under paragraph (a)(2)(iv)(D) of this section, if the control device subject to paragraph (a)(2)(iv) of this section meets the requirements of §61.349. The control device subject to paragraph (a)(2)(iv) of this section may be operated prior to receiving approval from the Administrator. However, if the Administrator determines that the control device does not meet the requirements of §61.349, the facility may be subject to enforcement action beginning from the time the control device began operation.

(b) Each closed-vent system and control device used to comply with this subpart shall be operated at all times when waste is placed in the waste management unit vented to the control device except when maintenance or repair of the waste management unit cannot be completed without a shutdown of the control device.

(c) An owner and operator shall demonstrate that each control device, except for a flare, achieves the appropriate conditions specified in paragraph (a)(2) of this section by using one of the following methods:

(1) Engineering calculations in accordance with requirements specified in §61.356(f) of this subpart; or

(2) Performance tests conducted using the test methods and procedures that meet the requirements specified in §61.355 of this subpart.

(d) An owner or operator shall demonstrate compliance of each flare in accordance with paragraph (a) (2)(iii) of this section.

(e) The Administrator may request at any time an owner or operator demonstrate that a control device

meets the applicable conditions specified in paragraph (a)(2) of this section by conducting a performance test using the test methods and procedures as required in §61.355, and for control devices subject to paragraph (a)(2)(iv) of this section, the Administrator may specify alternative test methods and procedures, as appropriate.

(f) Each closed-vent system and control device shall be visually inspected initially and quarterly thereafter. The visual inspection shall include inspection of ductwork and piping and connections to covers and control devices for evidence of visible defects such as holes in ductwork or piping and loose connections.

(g) Except as provided in §61.350 of this subpart, if visible defects are observed during an inspection, or if other problems are identified, or if detectable emissions are measured, a first effort to repair the closed-vent system and control device shall be made as soon as practicable but no later than 5 calendar days after detection. Repair shall be completed no later than 15 calendar days after the emissions are detected or the visible defect is observed.

(h) The owner or operator of a control device that is used to comply with the provisions of this section shall monitor the control device in accordance with §61.354(c) of this subpart.

[55 FR 8346, Mar. 7, 1990; 55 FR 12444, Apr. 3, 1990, as amended at 55 FR 37231, Sept. 10, 1990; 58 FR 3098, Jan. 7, 1993; 65 FR 62160, Oct. 17, 2000]

§ 61.350 Standards: Delay of repair.

(a) Delay of repair of facilities or units that are subject to the provisions of this subpart will be allowed if the repair is technically impossible without a complete or partial facility or unit shutdown.

(b) Repair of such equipment shall occur before the end of the next facility or unit shutdown.

§ 61.351 Alternative standards for tanks.

(a) As an alternative to the standards for tanks specified in §61.343 of this subpart, an owner or operator may elect to comply with one of the following:

(1) A fixed roof and internal floating roof meeting the requirements in 40 CFR 60.112b(a)(1);

(2) An external floating roof meeting the requirements of 40 CFR 60.112b (a)(2); or

(3) An alternative means of emission limitation as described in 40 CFR 60.114b.

(b) If an owner or operator elects to comply with the provisions of this section, then the owner or operator is exempt from the provisions of §61.343 of this subpart applicable to the same facilities.

[55 FR 8346, Mar. 7, 1990, as amended at 55 FR 37231, Sept. 10, 1990]

§ 61.352 Alternative standards for oil-water separators.

(a) As an alternative to the standards for oil-water separators specified in §61.347 of this subpart, an owner or operator may elect to comply with one of the following:

(1) A floating roof meeting the requirements in 40 CFR 60.693–2(a); or

(2) An alternative means of emission limitation as described in 40 CFR 60.694.

(b) For portions of the oil-water separator where it is infeasible to construct and operate a floating roof, such as over the weir mechanism, a fixed roof vented to a vapor control device that meets the requirements in §§61.347 and 61.349 of this subpart shall be installed and operated.

(c) Except as provided in paragraph (b) of this section, if an owner or operator elects to comply with the provisions of this section, then the owner or operator is exempt from the provisions in §61.347 of this subpart applicable to the same facilities.

§ 61.353 Alternative means of emission limitation.

(a) If, in the Administrator's judgment, an alternative means of emission limitation will achieve a reduction in benzene emissions at least equivalent to the reduction in benzene emissions from the source achieved by the applicable design, equipment, work practice, or operational requirements in §§61.342 through 61.349, the Administrator will publish in the Federal Register a notice permitting the use of the alternative means for purposes of compliance with that requirement. The notice may condition the permission on requirements related to the operation and maintenance of the alternative means.

(b) Any notice under paragraph (a) of this section shall be published only after public notice and an opportunity for a hearing.

(c) Any person seeking permission under this section shall collect, verify, and submit to the Administrator information showing that the alternative means achieves equivalent emission reductions.

[55 FR 8346, Mar. 7, 1990, as amended at 58 FR 3099, Jan. 7, 1993]

§ 61.354 Monitoring of operations.

(a) Except for a treatment process or waste stream complying with §61.348(d), the owner or operator shall monitor each treatment process or wastewater treatment system unit to ensure the unit is properly operated and maintained by one of the following monitoring procedures:

(1) Measure the benzene concentration of the waste stream exiting the treatment process complying with §61.348(a)(1)(i) at least once per month by collecting and analyzing one or more samples using the procedures specified in §61.355(c)(3).

(2) Install, calibrate, operate, and maintain according to manufacturer's specifications equipment to continuously monitor and record a process parameter (or parameters) for the treatment process or wastewater treatment system unit that indicates proper system operation. The owner or operator shall inspect at least once each operating day the data recorded by the monitoring equipment (e.g., temperature monitor or flow indicator) to ensure that the unit is operating properly.

(b) If an owner or operator complies with the requirements of §61.348(b), then the owner or operator shall monitor each wastewater treatment system to ensure the unit is properly operated and maintained by the appropriate monitoring procedure as follows:

(1) For the first exempt waste management unit in each waste treatment train, other than an enhanced biodegradation unit, measure the flow rate, using the procedures of §61.355(b), and the benzene concentration of each waste stream entering the unit at least once per month by collecting and analyzing one or more samples using the procedures specified in §61.355(c)(3).

(2) For each enhanced biodegradation unit that is the first exempt waste management unit in a treatment train, measure the benzene concentration of each waste stream entering the unit at least once per month by collecting and analyzing one or more samples using the procedures specified in §61.355(c)(3).

(c) An owner or operator subject to the requirements in §61.349 of this subpart shall install, calibrate, maintain, and operate according to the manufacturer's specifications a device to continuously monitor the control device operation as specified in the following paragraphs, unless alternative monitoring procedures or requirements are approved for that facility by the Administrator. The owner or operator shall inspect at least once each operating day the data recorded by the monitoring equipment (e.g., temperature monitor or flow indicator) to ensure that the control device is operating properly.

(1) For a thermal vapor incinerator, a temperature monitoring device equipped with a continuous recorder. The device shall have an accuracy of ± 1 percent of the temperature being monitored in $^{\circ}\text{C}$ or ± 0.5 $^{\circ}\text{C}$, whichever is greater. The temperature sensor shall be installed at a representative location in

the combustion chamber.

(2) For a catalytic vapor incinerator, a temperature monitoring device equipped with a continuous recorder. The device shall be capable of monitoring temperature at two locations, and have an accuracy of ± 1 percent of the temperature being monitored in $^{\circ}\text{C}$ or ± 0.5 $^{\circ}\text{C}$, whichever is greater. One temperature sensor shall be installed in the vent stream at the nearest feasible point to the catalyst bed inlet and a second temperature sensor shall be installed in the vent stream at the nearest feasible point to the catalyst bed outlet.

(3) For a flare, a monitoring device in accordance with 40 CFR 60.18(f)(2) equipped with a continuous recorder.

(4) For a boiler or process heater having a design heat input capacity less than 44 MW (150×10^6 BTU/hr), a temperature monitoring device equipped with a continuous recorder. The device shall have an accuracy of ± 1 percent of the temperature being monitored in $^{\circ}\text{C}$ or ± 0.5 $^{\circ}\text{C}$, whichever is greater. The temperature sensor shall be installed at a representative location in the combustion chamber.

(5) For a boiler or process heater having a design heat input capacity greater than or equal to 44 MW (150×10^6 BTU/hr), a monitoring device equipped with a continuous recorder to measure a parameter(s) that indicates good combustion operating practices are being used.

(6) For a condenser, either:

(i) A monitoring device equipped with a continuous recorder to measure either the concentration level of the organic compounds or the concentration level of benzene in the exhaust vent stream from the condenser; or

(ii) A temperature monitoring device equipped with a continuous recorder. The device shall be capable of monitoring temperature at two locations, and have an accuracy of ± 1 percent of the temperature being monitored in $^{\circ}\text{C}$ or ± 0.5 $^{\circ}\text{C}$, whichever is greater. One temperature sensor shall be installed at a location in the exhaust stream from the condenser, and a second temperature sensor shall be installed at a location in the coolant fluid exiting the condenser.

(7) For a carbon adsorption system that regenerates the carbon bed directly in the control device such as a fixed-bed carbon adsorber, either:

(i) A monitoring device equipped with a continuous recorder to measure either the concentration level of the organic compounds or the benzene concentration level in the exhaust vent stream from the carbon bed; or

(ii) A monitoring device equipped with a continuous recorder to measure a parameter that indicates the carbon bed is regenerated on a regular, predetermined time cycle.

(8) For a vapor recovery system other than a condenser or carbon adsorption system, a monitoring device equipped with a continuous recorder to measure either the concentration level of the organic compounds or the benzene concentration level in the exhaust vent stream from the control device.

(9) For a control device subject to the requirements of §61.349(a)(2)(iv), devices to monitor the parameters as specified in §61.349(a)(2)(iv)(C).

(d) For a carbon adsorption system that does not regenerate the carbon bed directly on site in the control device (e.g., a carbon canister), either the concentration level of the organic compounds or the concentration level of benzene in the exhaust vent stream from the carbon adsorption system shall be monitored on a regular schedule, and the existing carbon shall be replaced with fresh carbon immediately when carbon breakthrough is indicated. The device shall be monitored on a daily basis or at intervals no greater than 20 percent of the design carbon replacement interval, whichever is greater. As an alternative to conducting this monitoring, an owner or operator may replace the carbon in the carbon adsorption system with fresh carbon at a regular predetermined time interval that is less than the carbon replacement interval that is determined by the maximum design flow rate and either the organic concentration or the benzene concentration in the gas stream vented to the carbon adsorption system.

(e) An alternative operation or process parameter may be monitored if it can be demonstrated that another parameter will ensure that the control device is operated in conformance with these standards and the control device's design specifications.

(f) Owners or operators using a closed-vent system that contains any bypass line that could divert a vent stream from a control device used to comply with the provisions of this subpart shall do the following:

(1) Visually inspect the bypass line valve at least once every month, checking the position of the valve and the condition of the car-seal or closure mechanism required under §61.349(a)(1)(ii) to ensure that the valve is maintained in the closed position and the vent stream is not diverted through the bypass line.

(2) Visually inspect the readings from each flow monitoring device required by §61.349(a)(1)(ii) at least once each operating day to check that vapors are being routed to the control device as required.

(g) Each owner or operator who uses a system for emission control that is maintained at a pressure less than atmospheric pressure with openings to provide dilution air shall install, calibrate, maintain, and operate according to the manufacturer's specifications a device equipped with a continuous recorder to monitor the pressure in the unit to ensure that it is less than atmospheric pressure.

[55 FR 8346, Mar. 7, 1990, as amended at 58 FR 3099, Jan. 7, 1993; 65 FR 62160, Oct. 17, 2000]

§ 61.355 Test methods, procedures, and compliance provisions.

(a) An owner or operator shall determine the total annual benzene quantity from facility waste by the following procedure:

(1) For each waste stream subject to this subpart having a flow-weighted annual average water content greater than 10 percent water, on a volume basis as total water, or is mixed with water or other wastes at any time and the resulting mixture has an annual average water content greater than 10 percent as specified in §61.342(a), the owner or operator shall:

(i) Determine the annual waste quantity for each waste stream using the procedures specified in paragraph (b) of this section.

(ii) Determine the flow-weighted annual average benzene concentration for each waste stream using the procedures specified in paragraph (c) of this section.

(iii) Calculate the annual benzene quantity for each waste stream by multiplying the annual waste quantity of the waste stream times the flow-weighted annual average benzene concentration.

(2) Total annual benzene quantity from facility waste is calculated by adding together the annual benzene quantity for each waste stream generated during the year and the annual benzene quantity for each process unit turnaround waste annualized according to paragraph (b)(4) of this section.

(3) If the total annual benzene quantity from facility waste is equal to or greater than 10 Mg/yr (11 ton/yr), then the owner or operator shall comply with the requirements of §61.342 (c), (d), or (e).

(4) If the total annual benzene quantity from facility waste is less than 10 Mg/yr (11 ton/yr) but is equal to or greater than 1 Mg/yr (1.1 ton/yr), then the owner or operator shall:

(i) Comply with the recordkeeping requirements of §61.356 and reporting requirements of §61.357 of this subpart; and

(ii) Repeat the determination of total annual benzene quantity from facility waste at least once per year and whenever there is a change in the process generating the waste that could cause the total annual benzene quantity from facility waste to increase to 10 Mg/yr (11 ton/yr) or more.

(5) If the total annual benzene quantity from facility waste is less than 1 Mg/yr (1.1 ton/yr), then the

owner or operator shall:

(i) Comply with the recordkeeping requirements of §61.356 and reporting requirements of §61.357 of this subpart; and

(ii) Repeat the determination of total annual benzene quantity from facility waste whenever there is a change in the process generating the waste that could cause the total annual benzene quantity from facility waste to increase to 1 Mg/yr (1.1 ton/yr) or more.

(6) The benzene quantity in a waste stream that is generated less than one time per year, except as provided for process unit turnaround waste in paragraph (b)(4) of this section, shall be included in the determination of total annual benzene quantity from facility waste for the year in which the waste is generated unless the waste stream is otherwise excluded from the determination of total annual benzene quantity from facility waste in accordance with paragraphs (a) through (c) of this section. The benzene quantity in this waste stream shall not be annualized or averaged over the time interval between the activities that resulted in generation of the waste, for purposes of determining the total annual benzene quantity from facility waste.

(b) For purposes of the calculation required by paragraph (a) of this section, an owner or operator shall determine the annual waste quantity at the point of waste generation, unless otherwise provided in paragraphs (b) (1), (2), (3), and (4) of this section, by one of the methods given in paragraphs (b) (5) through (7) of this section.

(1) The determination of annual waste quantity for sour water streams that are processed in sour water strippers shall be made at the point that the water exits the sour water stripper.

(2) The determination of annual waste quantity for wastes at coke by-product plants subject to and complying with the control requirements of §61.132, 61.133, 61.134, or 61.139 of subpart L of this part shall be made at the location that the waste stream exits the process unit component or waste management unit controlled by that subpart or at the exit of the ammonia still, provided that the following conditions are met:

(i) The transfer of wastes between units complying with the control requirements of subpart L of this part, process units, and the ammonia still is made through hard piping or other enclosed system.

(ii) The ammonia still meets the definition of a sour water stripper in §61.341.

(3) The determination of annual waste quantity for wastes that are received at hazardous waste treatment, storage, or disposal facilities from offsite shall be made at the point where the waste enters the hazardous waste treatment, storage, or disposal facility.

(4) The determination of annual waste quantity for each process unit turnaround waste generated only at 2 year or greater intervals, may be made by dividing the total quantity of waste generated during the most recent process unit turnaround by the time period (in the nearest tenth of a year) between the turnaround resulting in generation of the waste and the most recent preceding process turnaround for the unit. The resulting annual waste quantity shall be included in the calculation of the annual benzene quantity as provided in paragraph (a)(1)(iii) of this section for the year in which the turnaround occurs and for each subsequent year until the unit undergoes the next process turnaround. For estimates of total annual benzene quantity as specified in the 90-day report, required under §61.357(a)(1), the owner or operator shall estimate the waste quantity generated during the most recent turnaround, and the time period between turnarounds in accordance with good engineering practices. If the owner or operator chooses not to annualize process unit turnaround waste, as specified in this paragraph, then the process unit turnaround waste quantity shall be included in the calculation of the annual benzene quantity for the year in which the turnaround occurs.

(5) Select the highest annual quantity of waste managed from historical records representing the most recent 5 years of operation or, if the facility has been in service for less than 5 years but at least 1 year, from historical records representing the total operating life of the facility;

(6) Use the maximum design capacity of the waste management unit; or

(7) Use measurements that are representative of maximum waste generation rates.

(c) For the purposes of the calculation required by §§61.355(a) of this subpart, an owner or operator shall determine the flow-weighted annual average benzene concentration in a manner that meets the requirements given in paragraph (c)(1) of this section using either of the methods given in paragraphs (c)(2) and (c)(3) of this section.

(1) The determination of flow-weighted annual average benzene concentration shall meet all of the following criteria:

(i) The determination shall be made at the point of waste generation except for the specific cases given in paragraphs (c)(1)(i)(A) through (D) of this section.

(A) The determination for sour water streams that are processed in sour water strippers shall be made at the point that the water exits the sour water stripper.

(B) The determination for wastes at coke by-product plants subject to and complying with the control requirements of §61.132, 61.133, 61.134, or 61.139 of subpart L of this part shall be made at the location that the waste stream exits the process unit component or waste management unit controlled by that subpart or at the exit of the ammonia still, provided that the following conditions are met:

(1) The transfer of wastes between units complying with the control requirements of subpart L of this part, process units, and the ammonia still is made through hard piping or other enclosed system.

(2) The ammonia still meets the definition of a sour water stripper in §61.341.

(C) The determination for wastes that are received from offsite shall be made at the point where the waste enters the hazardous waste treatment, storage, or disposal facility.

(D) The determination of flow-weighted annual average benzene concentration for process unit turnaround waste shall be made using either of the methods given in paragraph (c)(2) or (c)(3) of this section. The resulting flow-weighted annual average benzene concentration shall be included in the calculation of annual benzene quantity as provided in paragraph (a)(1)(iii) of this section for the year in which the turnaround occurs and for each subsequent year until the unit undergoes the next process unit turnaround.

(ii) Volatilization of the benzene by exposure to air shall not be used in the determination to reduce the benzene concentration.

(iii) Mixing or diluting the waste stream with other wastes or other materials shall not be used in the determination—to reduce the benzene concentration.

(iv) The determination shall be made prior to any treatment of the waste that removes benzene, except as specified in paragraphs (c)(1)(i)(A) through (D) of this section.

(v) For wastes with multiple phases, the determination shall provide the weighted-average benzene concentration based on the benzene concentration in each phase of the waste and the relative proportion of the phases.

(2) *Knowledge of the waste.* The owner or operator shall provide sufficient information to document the flow-weighted annual average benzene concentration of each waste stream. Examples of information that could constitute knowledge include material balances, records of chemicals purchases, or previous test results provided the results are still relevant to the current waste stream conditions. If test data are used, then the owner or operator shall provide documentation describing the testing protocol and the means by which sampling variability and analytical variability were accounted for in the determination of the flow-weighted annual average benzene concentration for the waste stream. When an owner or operator and the Administrator do not agree on determinations of the flow-weighted annual average benzene concentration based on knowledge of the waste, the procedures under paragraph (c)(3) of this section shall be used to resolve the disagreement.

(3) Measurements of the benzene concentration in the waste stream in accordance with the following procedures:

(i) Collect a minimum of three representative samples from each waste stream. Where feasible, samples shall be taken from an enclosed pipe prior to the waste being exposed to the atmosphere.

(ii) For waste in enclosed pipes, the following procedures shall be used:

(A) Samples shall be collected prior to the waste being exposed to the atmosphere in order to minimize the loss of benzene prior to sampling.

(B) A static mixer shall be installed in the process line or in a by-pass line unless the owner or operator demonstrates that installation of a static mixer in the line is not necessary to accurately determine the benzene concentration of the waste stream.

(C) The sampling tap shall be located within two pipe diameters of the static mixer outlet.

(D) Prior to the initiation of sampling, sample lines and cooling coil shall be purged with at least four volumes of waste.

(E) After purging, the sample flow shall be directed to a sample container and the tip of the sampling tube shall be kept below the surface of the waste during sampling to minimize contact with the atmosphere.

(F) Samples shall be collected at a flow rate such that the cooling coil is able to maintain a waste temperature less than 10 °C (50 °F).

(G) After filling, the sample container shall be capped immediately (within 5 seconds) to leave a minimum headspace in the container.

(H) The sample containers shall immediately be cooled and maintained at a temperature below 10 °C (50 °F) for transfer to the laboratory.

(iii) When sampling from an enclosed pipe is not feasible, a minimum of three representative samples shall be collected in a manner to minimize exposure of the sample to the atmosphere and loss of benzene prior to sampling.

(iv) Each waste sample shall be analyzed using one of the following test methods for determining the benzene concentration in a waste stream:

(A) Method 8020, Aromatic Volatile Organics, in "Test Methods for Evaluating Solid Waste, Physical/Chemical Methods," EPA Publication No. SW-846 (incorporation by reference as specified in §61.18 of this part);

(B) Method 8021, Volatile Organic Compounds in Water by Purge and Trap Capillary Column Gas Chromatography with Photoionization and Electrolytic Conductivity Detectors in Series in "Test Methods for Evaluating Solid Waste, Physical/Chemical Methods," EPA Publication No. SW-846 (incorporation by reference as specified in §61.18 of this part);

(C) Method 8240, Gas Chromatography/Mass Spectrometry for Volatile Organics in "Test Methods for Evaluating Solid Waste, Physical/Chemical Methods," EPA Publication No. SW-846 (incorporation by reference as specified in §61.18 of this part);

(D) Method 8260, Gas Chromatography/Mass Spectrometry for Volatile Organics: Capillary Column Technique in "Test Methods for Evaluating Solid Waste, Physical/Chemical Methods," EPA Publication No. SW-846 (incorporation by reference as specified in §61.18 of this part);

(E) Method 602, Purgeable Aromatics, as described in 40 CFR part 136, appendix A, Test Procedures for Analysis of Organic Pollutants, for wastewaters for which this is an approved EPA methods; or

(F) Method 624, Purgeables, as described in 40 CFR part 136, appendix A, Test Procedures for Analysis of Organic Pollutants, for wastewaters for which this is an approved EPA method.

(v) The flow-weighted annual average benzene concentration shall be calculated by averaging the results of the sample analyses as follows:

$$\bar{C} = \frac{1}{Q} \times \sum_{i=1}^n (Q_i)(C_i)$$

Where:

C=Flow-weighted annual average benzene concentration for waste stream, ppmw.

Q_i=Total annual waste quantity for waste stream, kg/yr (lb/yr).

n=Number of waste samples (at least 3).

Q_i=Annual waste quantity for waste stream represented by C_i, kg/yr (lb/yr).

C_i=Measured concentration of benzene in waste sample i, ppmw.

(d) An owner or operator using performance tests to demonstrate compliance of a treatment process with §61.348 (a)(1)(i) shall measure the flow-weighted annual average benzene concentration of the waste stream exiting the treatment process by collecting and analyzing a minimum of three representative samples of the waste stream using the procedures in paragraph (c)(3) of this section. The test shall be conducted under conditions that exist when the treatment process is operating at the highest inlet waste stream flow rate and benzene content expected to occur. Operations during periods of startup, shutdown, and malfunction shall not constitute representative conditions for the purpose of a test. The owner or operator shall record all process information as is necessary to document the operating conditions during the test.

(e) An owner or operator using performance tests to demonstrate compliance of a treatment process with §61.348(a)(1)(ii) of this subpart shall determine the percent reduction of benzene in the waste stream on a mass basis by the following procedure:

(1) The test shall be conducted under conditions that exist when the treatment process is operating at the highest inlet waste stream flow rate and benzene content expected to occur. Operations during periods of startup, shutdown, and malfunction shall not constitute representative conditions for the purpose of a test. The owner or operator shall record all process information as is necessary to document the operating conditions during the test.

(2) All testing equipment shall be prepared and installed as specified in the appropriate test methods.

(3) The mass flow rate of benzene entering the treatment process (E_b) shall be determined by computing the product of the flow rate of the waste stream entering the treatment process, as determined by the inlet flow meter, and the benzene concentration of the waste stream, as determined using the sampling and analytical procedures specified in paragraph (c)(2) or (c)(3) of this section. Three grab samples of the waste shall be taken at equally spaced time intervals over a 1-hour period. Each 1-hour period constitutes a run, and the performance test shall consist of a minimum of 3 runs conducted over a 3-hour period. The mass flow rate of benzene entering the treatment process is calculated as follows:

$$E_b = \frac{K}{n \times 10^6} \left[\sum_{i=1}^n V_i C_i \right]$$

Where:

E_b = Mass flow rate of benzene entering the treatment process, kg/hr (lb/hr).

K = Density of the waste stream, kg/m³ (lb/ft³).

V_i = Average volume flow rate of waste entering the treatment process during each run i , m³ /hr (ft³ /hr).

C_i = Average concentration of benzene in the waste stream entering the treatment process during each run i , ppmw.

n = Number of runs.

10^6 = Conversion factor for ppmw.

(4) The mass flow rate of benzene exiting the treatment process (E_a) shall be determined by computing the product of the flow rate of the waste stream exiting the treatment process, as determined by the outlet flow meter or the inlet flow meter, and the benzene concentration of the waste stream, as determined using the sampling and analytical procedures specified in paragraph (c)(2) or (c)(3) of this section. Three grab samples of the waste shall be taken at equally spaced time intervals over a 1-hour period. Each 1-hour period constitutes a run, and the performance test shall consist of a minimum of 3 runs conducted over the same 3-hour period at which the mass flow rate of benzene entering the treatment process is determined. The mass flow rate of benzene exiting the treatment process is calculated as follows:

$$E_a = \frac{K}{n \times 10^6} \left[\sum_{i=1}^n V_i C_i \right]$$

Where:

E_a = Mass flow rate of benzene exiting the treatment process, kg/hr (lb/hr).

K = Density of the waste stream, kg/m³ (lb/ft³).

V_i = Average volume flow rate of waste exiting the treatment process during each run i , m³ /hr (ft³ /hr).

C_i = Average concentration of benzene in the waste stream exiting the treatment process during each run i , ppmw.

n = Number of runs.

10^6 = Conversion factor for ppmw.

(f) An owner or operator using performance tests to demonstrate compliance of a treatment process with §61.348(a)(1)(iii) of this subpart shall determine the benzene destruction efficiency for the combustion unit by the following procedure:

(1) The test shall be conducted under conditions that exist when the combustion unit is operating at the highest inlet waste stream flow rate and benzene content expected to occur. Operations during periods of startup, shutdown, and malfunction shall not constitute representative conditions for the purpose of a test. The owner or operator shall record all process information necessary to document the operating

conditions during the test.

(2) All testing equipment shall be prepared and installed as specified in the appropriate test methods.

(3) The mass flow rate of benzene entering the combustion unit shall be determined by computing the product of the flow rate of the waste stream entering the combustion unit, as determined by the inlet flow meter, and the benzene concentration of the waste stream, as determined using the sampling procedures in paragraph (c)(2) or (c)(3) of this section. Three grab samples of the waste shall be taken at equally spaced time intervals over a 1-hour period. Each 1-hour period constitutes a run, and the performance test shall consist of a minimum of 3 runs conducted over a 3-hour period. The mass flow rate of benzene into the combustion unit is calculated as follows:

$$E_b = \frac{K}{n \times 10^6} \left[\sum_{i=1}^n V_i C_i \right]$$

Where:

E_b = Mass flow rate of benzene entering the combustion unit, kg/hr (lb/hr).

K = Density of the waste stream, kg/m³ (lb/ft³).

V_i = Average volume flow rate of waste entering the combustion unit during each run i , m³/hr (ft³/hr).

C_i = Average concentration of benzene in the waste stream entering the combustion unit during each run i , ppmw.

n = Number of runs.

10^6 = Conversion factor for ppmw.

(4) The mass flow rate of benzene exiting the combustion unit exhaust stack shall be determined as follows:

(i) The time period for the test shall not be less than 3 hours during which at least 3 stack gas samples are collected and be the same time period at which the mass flow rate of benzene entering the treatment process is determined. Each sample shall be collected over a 1-hour period (e.g., in a tedlar bag) to represent a time-integrated composite sample and each 1-hour period shall correspond to the periods when the waste feed is sampled.

(ii) A run shall consist of a 1-hour period during the test. For each run:

(A) The reading from each measurement shall be recorded;

(B) The volume exhausted shall be determined using Method 2, 2A, 2C, or 2D from appendix A of 40 CFR part 60, as appropriate.

(C) The average benzene concentration in the exhaust downstream of the combustion unit shall be determined using Method 18 from appendix A of 40 CFR part 60.

(iii) The mass of benzene emitted during each run shall be calculated as follows:

$$M_i = D_b V C (10^{-6})$$

Where:

M_i = Mass of benzene emitted during run i, kg (lb).

V = Volume of air-vapor mixture exhausted at standard conditions, m^3 (ft^3).

C = Concentration of benzene measured in the exhaust, ppmv.

D_b = Density of benzene, 3.24 kg/m^3 (0.202 lb/ft^3).

10^6 = Conversion factor for ppmv.

(iv) The benzene mass emission rate in the exhaust shall be calculated as follows:

$$E_a = \left(\sum_{i=1}^n M_i \right) / T$$

Where:

E_a = Mass flow rate of benzene emitted from the combustion unit, kg/hr (lb/hr).

M_i = Mass of benzene emitted from the combustion unit during run i, kg (lb).

T = Total time of all runs, hr.

n = Number of runs.

(5) The benzene destruction efficiency for the combustion unit shall be calculated as follows:

$$R = \frac{E_b - E_a}{E_b} \times 100$$

Where:

R = Benzene destruction efficiency for the combustion unit, percent.

E_b = Mass flow rate of benzene entering the combustion unit, kg/hr (lb/hr).

E_a = Mass flow rate of benzene emitted from the combustion unit, kg/hr (lb/hr).

(g) An owner or operator using performance tests to demonstrate compliance of a wastewater treatment system unit with §61.348(b) shall measure the flow-weighted annual average benzene concentration of the wastewater stream where the waste stream enters an exempt waste management unit by collecting and analyzing a minimum of three representative samples of the waste stream using the procedures in paragraph (c)(3) of this section. The test shall be conducted under conditions that exist when the wastewater treatment system is operating at the highest inlet wastewater stream flow rate and benzene content expected to occur. Operations during periods of startup, shutdown, and malfunction shall not constitute representative conditions for the purpose of a test. The owner or operator shall record all process information as is necessary to document the operating conditions during the test.

(h) An owner or operator shall test equipment for compliance with no detectable emissions as required in

§§61.343 through 61.347, and §61.349 of this subpart in accordance with the following requirements:

- (1) Monitoring shall comply with Method 21 from appendix A of 40 CFR part 60.
- (2) The detection instrument shall meet the performance criteria of Method 21.
- (3) The instrument shall be calibrated before use on each day of its use by the procedures specified in Method 21.
- (4) Calibration gases shall be:
 - (i) Zero air (less than 10 ppm of hydrocarbon in air); and
 - (ii) A mixture of methane or n-hexane and air at a concentration of approximately, but less than, 10,000 ppm methane or n-hexane.
- (5) The background level shall be determined as set forth in Method 21.
- (6) The instrument probe shall be traversed around all potential leak interfaces as close as possible to the interface as described in Method 21.
- (7) The arithmetic difference between the maximum concentration indicated by the instrument and the background level is compared to 500 ppm for determining compliance.
 - (i) An owner or operator using a performance test to demonstrate compliance of a control device with either the organic reduction efficiency requirement or the benzene reduction efficiency requirement specified under §61.349(a)(2) shall use the following procedures:
 - (1) The test shall be conducted under conditions that exist when the waste management unit vented to the control device is operating at the highest load or capacity level expected to occur. Operations during periods of startup, shutdown, and malfunction shall not constitute representative conditions for the purpose of a test. The owner or operator shall record all process information necessary to document the operating conditions during the test.
 - (2) Sampling sites shall be selected using Method 1 or 1A from appendix A of 40 CFR part 60, as appropriate.
 - (3) The mass flow rate of either the organics or benzene entering and exiting the control device shall be determined as follows:
 - (i) The time period for the test shall not be less than 3 hours during which at least 3 stack gas samples are collected. Samples of the vent stream entering and exiting the control device shall be collected during the same time period. Each sample shall be collected over a 1-hour period (e.g., in a tedlar bag) to represent a time-integrated composite sample.
 - (ii) A run shall consist of a 1-hour period during the test. For each run:
 - (A) The reading from each measurement shall be recorded;
 - (B) The volume exhausted shall be determined using Method 2, 2A, 2C, or 2D from appendix A of 40 CFR part 60, as appropriate;
 - (C) The organic concentration or the benzene concentration, as appropriate, in the vent stream entering and exiting the control shall be determined using Method 18 from appendix A of 40 CFR part 60.
 - (iii) The mass of organics or benzene entering and exiting the control device during each run shall be calculated as follows:

$$M_{aj} = \frac{K_1 V_{aj}}{10^6} \left(\sum_{i=1}^n C_{ai} MW_i \right)$$

$$M_{bj} = \frac{K_1 V_{bj}}{10^6} \left(\sum_{i=1}^n C_{bi} MW_i \right)$$

M_{aj} = Mass of organics or benzene in the vent stream entering the control device during run j, kg (lb).

M_{bj} = Mass of organics or benzene in the vent stream exiting the control device during run j, kg (lb).

V_{aj} = Volume of vent stream entering the control device during run j, at standard conditions, m³ (ft³).

V_{bj} = Volume of vent stream exiting the control device during run j, at standard conditions, m³ (ft³).

C_{ai} = Organic concentration of compound i or the benzene concentration measured in the vent stream entering the control device as determined by Method 18, ppm by volume on a dry basis.

C_{bi} = Organic concentration of compound i or the benzene concentration measured in the vent stream exiting the control device as determined by Method 18, ppm by volume on a dry basis.

MW_i = Molecular weight of organic compound i in the vent stream, or the molecular weight of benzene, kg/kg-mol (lb/lb-mole).

n = Number of organic compounds in the vent stream; if benzene reduction efficiency is being demonstrated, then n=1.

K_1 = Conversion factor for molar volume at standard conditions (293 K and 760 mm Hg (527 R and 14.7 psia))

= 0.0416 kg-mol/m³ (0.00118 lb-mol/ft³)

10⁻⁶ = Conversion factor for ppmv.

(iv) The mass flow rate of organics or benzene entering and exiting the control device shall be calculated as follows:

$$E_a - \left(\sum_{j=1}^n M_{aj} \right) / T$$

$$E_b - \left(\sum_{j=1}^n M_{bj} \right) / T$$

Where:

E_a = Mass flow rate of organics or benzene entering the control device, kg/hr (lb/hr).

E_b = Mass flow rate of organics or benzene exiting the control device, kg/hr (lb/hr).

M_{aj} = Mass of organics or benzene in the vent stream entering the control device during run j, kg (lb).

M_{bj} = Mass of organics or benzene in the vent stream exiting the control device during run j, kg (lb).

T = Total time of all runs, hr.

n = Number of runs.

(4) The organic reduction efficiency or the benzene reduction efficiency for the control device shall be calculated as follows:

$$R = \frac{E_a - E_b}{E_a} \times 100$$

Where:

R = Total organic reduction of efficiency or benzene reduction efficiency for the control device, percent.

E_b = Mass flow rate of organics or benzene entering the control device, kg/hr (lb/hr).

E_a = Mass flow rate of organic or benzene emitted from the control device, kg/hr (lb/hr).

(j) An owner or operator shall determine the benzene quantity for the purposes of the calculation required by §61.342 (c)(3)(ii)(B) according to the provisions of paragraph (a) of this section, except that the procedures in paragraph (a) of this section shall also apply to wastes with a water content of 10 percent or less.

(k) An owner or operator shall determine the benzene quantity for the purposes of the calculation required by §61.342(e)(2) by the following procedure:

(1) For each waste stream that is not controlled for air emissions in accordance with §61.343. 61.344, 61.345, 61.346, 61.347, or 61.348(a), as applicable to the waste management unit that manages the waste, the benzene quantity shall be determined as specified in paragraph (a) of this section, except that paragraph (b)(4) of this section shall not apply, i.e., the waste quantity for process unit turnaround waste is not annualized but shall be included in the determination of benzene quantity for the year in which the waste is generated for the purposes of the calculation required by §61.342(e)(2).

(2) For each waste stream that is controlled for air emissions in accordance with §61.343. 61.344, 61.345, 61.346, 61.347, or 61.348(a), as applicable to the waste management unit that manages the waste, the determination of annual waste quantity and flow-weighted annual average benzene concentration shall be made at the first applicable location as described in paragraphs (k)(2)(i), (k)(2)(ii), and (k)(2)(iii) of this section and prior to any reduction of benzene concentration through volatilization of the benzene, using the methods given in (k)(2)(iv) and (k)(2)(v) of this section.

(i) Where the waste stream enters the first waste management unit not complying with §§61.343, 61.344, 61.345, 61.346, 61.347, and 61.348(a) that are applicable to the waste management unit,

(ii) For each waste stream that is managed or treated only in compliance with §§61.343 through 61.348 (a) up to the point of final direct discharge from the facility, the determination of benzene quantity shall be prior to any reduction of benzene concentration through volatilization of the benzene, or

(iii) For wastes managed in units controlled for air emissions in accordance with §§61.343, 61.344, 61.345, 61.346, 61.347, and 61.348(a), and then transferred offsite, facilities shall use the first applicable offsite location as described in paragraphs (k)(2)(i) and (k)(2)(ii) of this section if they have documentation from the offsite facility of the benzene quantity at this location. Facilities without this documentation for offsite wastes shall use the benzene quantity determined at the point where the transferred waste leaves the facility.

(iv) Annual waste quantity shall be determined using the procedures in paragraphs (b)(5), (6), or (7) of this section, and

(v) The flow-weighted annual average benzene concentration shall be determined using the procedures in paragraphs (c)(2) or (3) of this section.

(3) The benzene quantity in a waste stream that is generated less than one time per year, including process unit turnaround waste, shall be included in the determination of benzene quantity as determined in paragraph (k)(6) of this section for the year in which the waste is generated. The benzene quantity in this waste stream shall not be annualized or averaged over the time interval between the activities that resulted in generation of the waste for purposes of determining benzene quantity as determined in paragraph (k)(6) of this section.

(4) The benzene in waste entering an enhanced biodegradation unit, as defined in §61.348(b)(2)(ii)(B), shall not be included in the determination of benzene quantity, determined in paragraph (k)(6) of this section, if the following conditions are met:

(i) The benzene concentration for each waste stream entering the enhanced biodegradation unit is less than 10 ppmw on a flow-weighted annual average basis, and

(ii) All prior waste management units managing the waste comply with §§61.343, 61.344, 61.345, 61.346, 61.347 and 61.348(a).

(5) The benzene quantity for each waste stream in paragraph (k)(2) of this section shall be determined by multiplying the annual waste quantity of each waste stream times its flow-weighted annual average benzene concentration.

(6) The total benzene quantity for the purposes of the calculation required by §61.342(e)(2) shall be determined by adding together the benzene quantities determined in paragraphs (k)(1) and (k)(5) of this section for each applicable waste stream.

(7) If the benzene quantity determined in paragraph (6) of this section exceeds 6.0 Mg/yr (6.6 ton/yr) only because of multiple counting of the benzene quantity for a waste stream, the owner or operator may use the following procedures for the purposes of the calculation required by §61.342(e)(2):

(i) Determine which waste management units are involved in the multiple counting of benzene;

(ii) Determine the quantity of benzene that is emitted, recovered, or removed from the affected units identified in paragraph (k)(7)(i) of this section, or destroyed in the units if applicable, using either direct measurements or the best available estimation techniques developed or approved by the Administrator.

(iii) Adjust the benzene quantity to eliminate the multiple counting of benzene based on the results from paragraph (k)(7)(ii) of this section and determine the total benzene quantity for the purposes of the calculation required by §61.342(e)(2).

(iv) Submit in the annual report required under §61.357(a) a description of the methods used and the resulting calculations for the alternative procedure under paragraph (k)(7) of this section, the benzene quantity determination from paragraph (k)(6) of this section, and the adjusted benzene quantity determination from paragraph (k)(7)(iii) of this section.

[55 FR 8346, Mar. 7, 1990; 55 FR 12444, Apr. 3, 1990, as amended at 55 FR 37231, Sept. 10, 1990; 58 FR 3099, Jan. 7, 1993; 65 FR 62160, Oct. 17, 2000]

§ 61.356 Recordkeeping requirements.

(a) Each owner or operator of a facility subject to the provisions of this subpart shall comply with the recordkeeping requirements of this section. Each record shall be maintained in a readily accessible location at the facility site for a period not less than two years from the date the information is recorded unless otherwise specified.

(b) Each owner or operator shall maintain records that identify each waste stream at the facility subject to this subpart, and indicate whether or not the waste stream is controlled for benzene emissions in accordance with this subpart. In addition the owner or operator shall maintain the following records:

(1) For each waste stream not controlled for benzene emissions in accordance with this subpart, the records shall include all test results, measurements, calculations, and other documentation used to determine the following information for the waste stream: waste stream identification, water content, whether or not the waste stream is a process wastewater stream, annual waste quantity, range of benzene concentrations, annual average flow-weighted benzene concentration, and annual benzene quantity.

(2) For each waste stream exempt from §61.342(c)(1) in accordance with §61.342(c)(3), the records shall include:

(i) All measurements, calculations, and other documentation used to determine that the continuous flow of process wastewater is less than 0.02 liters (0.005 gallons) per minute or the annual waste quantity of process wastewater is less than 10 Mg/yr (11 ton/yr) in accordance with §61.342(c)(3)(i), or

(ii) All measurements, calculations, and other documentation used to determine that the sum of the total annual benzene quantity in all exempt waste streams does not exceed 2.0 Mg/yr (2.2 ton/yr) in accordance with §61.342(c)(3)(ii).

(3) For each facility where process wastewater streams are controlled for benzene emissions in accordance with §61.342(d) of this subpart, the records shall include for each treated process wastewater stream all measurements, calculations, and other documentation used to determine the annual benzene quantity in the process wastewater stream exiting the treatment process.

(4) For each facility where waste streams are controlled for benzene emissions in accordance with §61.342(e), the records shall include for each waste stream all measurements, including the locations of the measurements, calculations, and other documentation used to determine that the total benzene quantity does not exceed 6.0 Mg/yr (6.6 ton/yr).

(5) For each facility where the annual waste quantity for process unit turnaround waste is determined in accordance with §61.355(b)(5), the records shall include all test results, measurements, calculations, and other documentation used to determine the following information: identification of each process unit at the facility that undergoes turnarounds, the date of the most recent turnaround for each process unit, identification of each process unit turnaround waste, the water content of each process unit turnaround waste, the annual waste quantity determined in accordance with §61.355(b)(5), the range of benzene concentrations in the waste, the annual average flow-weighted benzene concentration of the waste, and the annual benzene quantity calculated in accordance with §61.355(a)(1)(iii) of this section.

(6) For each facility where wastewater streams are controlled for benzene emissions in accordance with §61.348(b)(2), the records shall include all measurements, calculations, and other documentation used to determine the annual benzene content of the waste streams and the total annual benzene quantity contained in all waste streams managed or treated in exempt waste management units.

(c) An owner or operator transferring waste off-site to another facility for treatment in accordance with §61.342(f) shall maintain documentation for each offsite waste shipment that includes the following information: Date waste is shipped offsite, quantity of waste shipped offsite, name and address of the facility receiving the waste, and a copy of the notice sent with the waste shipment.

(d) An owner or operator using control equipment in accordance with §§61.343 through 61.347 shall maintain engineering design documentation for all control equipment that is installed on the waste management unit. The documentation shall be retained for the life of the control equipment. If a control device is used, then the owner or operator shall maintain the control device records required by paragraph (f) of this section.

(e) An owner or operator using a treatment process or wastewater treatment system unit in accordance with §61.348 of this subpart shall maintain the following records. The documentation shall be retained for the life of the unit.

(1) A statement signed and dated by the owner or operator certifying that the unit is designed to operate at the documented performance level when the waste stream entering the unit is at the highest waste stream flow rate and benzene content expected to occur.

(2) If engineering calculations are used to determine treatment process or wastewater treatment system unit performance, then the owner or operator shall maintain the complete design analysis for the unit. The design analysis shall include for example the following information: Design specifications, drawings, schematics, piping and instrumentation diagrams, and other documentation necessary to demonstrate the unit performance.

(3) If performance tests are used to determine treatment process or wastewater treatment system unit performance, then the owner or operator shall maintain all test information necessary to demonstrate the unit performance.

(i) A description of the unit including the following information: type of treatment process; manufacturer name and model number; and for each waste stream entering and exiting the unit, the waste stream type (e.g., process wastewater, sludge, slurry, etc.), and the design flow rate and benzene content.

(ii) Documentation describing the test protocol and the means by which sampling variability and analytical variability were accounted for in the determination of the unit performance. The description of the test protocol shall include the following information: sampling locations, sampling method, sampling frequency, and analytical procedures used for sample analysis.

(iii) Records of unit operating conditions during each test run including all key process parameters.

(iv) All test results.

(4) If a control device is used, then the owner or operator shall maintain the control device records required by paragraph (f) of this section.

(f) An owner or operator using a closed-vent system and control device in accordance with §61.349 of this subpart shall maintain the following records. The documentation shall be retained for the life of the control device.

(1) A statement signed and dated by the owner or operator certifying that the closed-vent system and control device is designed to operate at the documented performance level when the waste management unit vented to the control device is or would be operating at the highest load or capacity expected to occur.

(2) If engineering calculations are used to determine control device performance in accordance with §61.349(c), then a design analysis for the control device that includes for example:

(i) Specifications, drawings, schematics, and piping and instrumentation diagrams prepared by the owner or operator, or the control device manufacturer or vendor that describe the control device design based on acceptable engineering texts. The design analysis shall address the following vent stream characteristics and control device operating parameters:

(A) For a thermal vapor incinerator, the design analysis shall consider the vent stream composition, constituent concentrations, and flow rate. The design analysis shall also establish the design minimum and average temperature in the combustion zone and the combustion zone residence time.

(B) For a catalytic vapor incinerator, the design analysis shall consider the vent stream composition, constituent concentrations, and flow rate. The design analysis shall also establish the design minimum and average temperatures across the catalyst bed inlet and outlet.

(C) For a boiler or process heater, the design analysis shall consider the vent stream composition, constituent concentrations, and flow rate. The design analysis shall also establish the design minimum and average flame zone temperatures, combustion zone residence time, and description of method and location where the vent stream is introduced into the flame zone.

(D) For a flare, the design analysis shall consider the vent stream composition, constituent concentrations, and flow rate. The design analysis shall also consider the requirements specified in 40 CFR 60.18.

(E) For a condenser, the design analysis shall consider the vent stream composition, constituent concentration, flow rate, relative humidity, and temperature. The design analysis shall also establish the design outlet organic compound concentration level or the design outlet benzene concentration level, design average temperature of the condenser exhaust vent stream, and the design average temperatures of the coolant fluid at the condenser inlet and outlet.

(F) For a carbon adsorption system that regenerates the carbon bed directly on-site in the control device such as a fixed-bed adsorber, the design analysis shall consider the vent stream composition, constituent concentration, flow rate, relative humidity, and temperature. The design analysis shall also establish the design exhaust vent stream organic compound concentration level or the design exhaust vent stream benzene concentration level, number and capacity of carbon beds, type and working capacity of activated carbon used for carbon beds, design total steam flow over the period of each complete carbon bed regeneration cycle, duration of the carbon bed steaming and cooling/drying cycles, design carbon bed temperature after regeneration, design carbon bed regeneration time, and design service life of carbon.

(G) For a carbon adsorption system that does not regenerate the carbon bed directly on-site in the control device, such as a carbon canister, the design analysis shall consider the vent stream composition, constituent concentration, flow rate, relative humidity, and temperature. The design analysis shall also establish the design exhaust vent stream organic compound concentration level or the design exhaust vent stream benzene concentration level, capacity of carbon bed, type and working capacity of activated carbon used for carbon bed, and design carbon replacement interval based on the total carbon working capacity of the control device and source operating schedule.

(H) For a control device subject to the requirements of §61.349(a)(2)(iv), the design analysis shall consider the vent stream composition, constituent concentration, and flow rate. The design analysis shall also include all of the information submitted under §61.349 (a)(2)(iv).

(ii) [Reserved]

(3) If performance tests are used to determine control device performance in accordance with §61.349 (c) of this subpart:

(i) A description of how it is determined that the test is conducted when the waste management unit or treatment process is operating at the highest load or capacity level. This description shall include the estimated or design flow rate and organic content of each vent stream and definition of the acceptable operating ranges of key process and control parameters during the test program.

(ii) A description of the control device including the type of control device, control device manufacturer's name and model number, control device dimensions, capacity, and construction materials.

(iii) A detailed description of sampling and monitoring procedures, including sampling and monitoring locations in the system, the equipment to be used, sampling and monitoring frequency, and planned analytical procedures for sample analysis.

(iv) All test results.

(g) An owner or operator shall maintain a record for each visual inspection required by §§61.343 through

61.347 of this subpart that identifies a problem (such as a broken seal, gap or other problem) which could result in benzene emissions. The record shall include the date of the inspection, waste management unit and control equipment location where the problem is identified, a description of the problem, a description of the corrective action taken, and the date the corrective action was completed.

(h) An owner or operator shall maintain a record for each test of no detectable emissions required by §§61.343 through 61.347 and §61.349 of this subpart. The record shall include the following information: date the test is performed, background level measured during test, and maximum concentration indicated by the instrument reading measured for each potential leak interface. If detectable emissions are measured at a leak interface, then the record shall also include the waste management unit, control equipment, and leak interface location where detectable emissions were measured, a description of the problem, a description of the corrective action taken, and the date the corrective action was completed.

(i) For each treatment process and wastewater treatment system unit operated to comply with §61.348, the owner or operator shall maintain documentation that includes the following information regarding the unit operation:

(1) Dates of startup and shutdown of the unit.

(2) If measurements of waste stream benzene concentration are performed in accordance with §61.354 (a)(1) of this subpart, the owner or operator shall maintain records that include date each test is performed and all test results.

(3) If a process parameter is continuously monitored in accordance with §61.354(a)(2) of this subpart, the owner or operator shall maintain records that include a description of the operating parameter (or parameters) to be monitored to ensure that the unit will be operated in conformance with these standards and the unit's design specifications, and an explanation of the criteria used for selection of that parameter (or parameters). This documentation shall be kept for the life of the unit.

(4) If measurements of waste stream benzene concentration are performed in accordance with §61.354 (b), the owner or operator shall maintain records that include the date each test is performed and all test results.

(5) Periods when the unit is not operated as designed.

(j) For each control device, the owner or operator shall maintain documentation that includes the following information regarding the control device operation:

(1) Dates of startup and shutdown of the closed-vent system and control device.

(2) A description of the operating parameter (or parameters) to be monitored to ensure that the control device will be operated in conformance with these standards and the control device's design specifications and an explanation of the criteria used for selection of that parameter (or parameters). This documentation shall be kept for the life of the control device.

(3) Periods when the closed-vent system and control device are not operated as designed including all periods and the duration when:

(i) Any valve car-seal or closure mechanism required under §61.349(a)(1)(ii) is broken or the by-pass line valve position has changed.

(ii) The flow monitoring devices required under §61.349(a)(1)(ii) indicate that vapors are not routed to the control device as required.

(4) If a thermal vapor incinerator is used, then the owner or operator shall maintain continuous records of the temperature of the gas stream in the combustion zone of the incinerator and records of all 3-hour periods of operation during which the average temperature of the gas stream in the combustion zone is more than 28 °C (50 °F) below the design combustion zone temperature.

(5) If a catalytic vapor incinerator is used, then the owner or operator shall maintain continuous records

of the temperature of the gas stream both upstream and downstream of the catalyst bed of the incinerator, records of all 3-hour periods of operation during which the average temperature measured before the catalyst bed is more than 28 °C (50 °F) below the design gas stream temperature, and records of all 3-hour periods of operation during which the average temperature difference across the catalyst bed is less than 80 percent of the design temperature difference.

(6) If a boiler or process heater is used, then the owner or operator shall maintain records of each occurrence when there is a change in the location at which the vent stream is introduced into the flame zone as required by §61.349(a)(2)(i)(C). For a boiler or process heater having a design heat input capacity less than 44 MW (150 × 106 BTU/hr), the owner or operator shall maintain continuous records of the temperature of the gas stream in the combustion zone of the boiler or process heater and records of all 3-hour periods of operation during which the average temperature of the gas stream in the combustion zone is more than 28 °C (50 °F) below the design combustion zone temperature. For a boiler or process heater having a design heat input capacity greater than or equal to 44 MW (150 × 106 BTU/hr), the owner or operator shall maintain continuous records of the parameter(s) monitored in accordance with the requirements of §61.354(c)(5).

(7) If a flare is used, then the owner or operator shall maintain continuous records of the flare pilot flame monitoring and records of all periods during which the pilot flame is absent.

(8) If a condenser is used, then the owner or operator shall maintain records from the monitoring device of the parameters selected to be monitored in accordance with §61.354(c)(6). If concentration of organics or concentration of benzene in the control device outlet gas stream is monitored, then the owner or operator shall record all 3-hour periods of operation during which the concentration of organics or the concentration of benzene in the exhaust stream is more than 20 percent greater than the design value. If the temperature of the condenser exhaust stream and coolant fluid is monitored, then the owner or operator shall record all 3-hour periods of operation during which the temperature of the condenser exhaust vent stream is more than 6 °C (11 °F) above the design average exhaust vent stream temperature, or the temperature of the coolant fluid exiting the condenser is more than 6 °C (11 °F) above the design average coolant fluid temperature at the condenser outlet.

(9) If a carbon adsorber is used, then the owner or operator shall maintain records from the monitoring device of the concentration of organics or the concentration of benzene in the control device outlet gas stream. If the concentration of organics or the concentration of benzene in the control device outlet gas stream is monitored, then the owner or operator shall record all 3-hour periods of operation during which the concentration of organics or the concentration of benzene in the exhaust stream is more than 20 percent greater than the design value. If the carbon bed regeneration interval is monitored, then the owner or operator shall record each occurrence when the vent stream continues to flow through the control device beyond the predetermined carbon bed regeneration time.

(10) If a carbon adsorber that is not regenerated directly on site in the control device is used, then the owner or operator shall maintain records of dates and times when the control device is monitored, when breakthrough is measured, and shall record the date and time when the existing carbon in the control device is replaced with fresh carbon.

(11) If an alternative operational or process parameter is monitored for a control device, as allowed in §61.354(e) of this subpart, then the owner or operator shall maintain records of the continuously monitored parameter, including periods when the device is not operated as designed.

(12) If a control device subject to the requirements of §61.349(a)(2)(iv) is used, then the owner or operator shall maintain records of the parameters that are monitored and each occurrence when the parameters monitored are outside the range of values specified in §61.349(a)(2)(iv)(C), or other records as specified by the Administrator.

(k) An owner or operator who elects to install and operate the control equipment in §61.351 of this subpart shall comply with the recordkeeping requirements in 40 CFR 60.115b.

(l) An owner or operator who elects to install and operate the control equipment in §61.352 of this subpart shall maintain records of the following:

(1) The date, location, and corrective action for each visual inspection required by 40 CFR 60.693–2(a)(5), during which a broken seal, gap, or other problem is identified that could result in benzene

(4) The information required in paragraphs (a) (1), (2), and (3) of this section should represent the waste stream characteristics based on current configuration and operating conditions. An owner or operator only needs to list in the report those waste streams that contact materials containing benzene. The report does not need to include a description of the controls to be installed to comply with the standard or other information required in §61.10(a).

(b) If the total annual benzene quantity from facility waste is less than 1 Mg/yr (1.1 ton/yr), then the owner or operator shall submit to the Administrator a report that updates the information listed in paragraphs (a)(1) through (a)(3) of this section whenever there is a change in the process generating the waste stream that could cause the total annual benzene quantity from facility waste to increase to 1 Mg/yr (1.1 ton/yr) or more.

(c) If the total annual benzene quantity from facility waste is less than 10 Mg/yr (11 ton/yr) but is equal to or greater than 1 Mg/yr (1.1 ton/yr), then the owner or operator shall submit to the Administrator a report that updates the information listed in paragraphs (a)(1) through (a)(3) of this section. The report shall be submitted annually and whenever there is a change in the process generating the waste stream that could cause the total annual benzene quantity from facility waste to increase to 10 Mg/yr (11 ton/yr) or more. If the information in the annual report required by paragraphs (a)(1) through (a)(3) of this section is not changed in the following year, the owner or operator may submit a statement to that effect.

(d) If the total annual benzene quantity from facility waste is equal to or greater than 10 Mg/yr (11 ton/yr), then the owner or operator shall submit to the Administrator the following reports:

(1) Within 90 days after January 7, 1993, unless a waiver of compliance under §61.11 of this part is granted, or by the date of initial startup for a new source with an initial startup after the effective date, a certification that the equipment necessary to comply with these standards has been installed and that the required initial inspections or tests have been carried out in accordance with this subpart. If a waiver of compliance is granted under §61.11, the certification of equipment necessary to comply with these standards shall be submitted by the date the waiver of compliance expires.

(2) Beginning on the date that the equipment necessary to comply with these standards has been certified in accordance with paragraph (d)(1) of this section, the owner or operator shall submit annually to the Administrator a report that updates the information listed in paragraphs (a)(1) through (a)(3) of this section. If the information in the annual report required by paragraphs (a)(1) through (a)(3) of this section is not changed in the following year, the owner or operator may submit a statement to that effect.

(3) If an owner or operator elects to comply with the requirements of §61.342(c)(3)(ii), then the report required by paragraph (d)(2) of this section shall include a table identifying each waste stream chosen for exemption and the total annual benzene quantity in these exempted streams.

(4) If an owner or operator elects to comply with the alternative requirements of §61.342(d) of this subpart, then he shall include in the report required by paragraph (d)(2) of this section a table presenting the following information for each process wastewater stream:

(i) Whether or not the process wastewater stream is being controlled for benzene emissions in accordance with the requirements of this subpart;

(ii) For each process wastewater stream identified as not being controlled for benzene emissions in accordance with the requirements of this subpart, the table shall report the following information for the process wastewater stream as determined at the point of waste generation: annual waste quantity, range of benzene concentrations, annual average flow-weighted benzene concentration, and annual benzene quantity;

(iii) For each process wastewater stream identified as being controlled for benzene emissions in accordance with the requirements of this subpart, the table shall report the following information for the process wastewater stream as determined at the exit to the treatment process: Annual waste quantity, range of benzene concentrations, annual average flow-weighted benzene concentration, and annual benzene quantity.

(5) If an owner or operator elects to comply with the alternative requirements of §61.342(e), then the report required by paragraph (d)(2) of this section shall include a table presenting the following information for each waste stream:

(i) For each waste stream identified as not being controlled for benzene emissions in accordance with the requirements of this subpart; the table shall report the following information for the waste stream as determined at the point of waste generation: annual waste quantity, range of benzene concentrations, annual average flow-weighted benzene concentration, and annual benzene quantity;

(ii) For each waste stream identified as being controlled for benzene emissions in accordance with the requirements of this subpart; the table shall report the following information for the waste stream as determined at the applicable location described in §61.355(k)(2): Annual waste quantity, range of benzene concentrations, annual average flow-weighted benzene concentration, and annual benzene quantity.

(6) Beginning 3 months after the date that the equipment necessary to comply with these standards has been certified in accordance with paragraph (d)(1) of this section, the owner or operator shall submit quarterly to the Administrator a certification that all of the required inspections have been carried out in accordance with the requirements of this subpart.

(7) Beginning 3 months after the date that the equipment necessary to comply with these standards has been certified in accordance with paragraph (d)(1) of this section, the owner or operator shall submit a report quarterly to the Administrator that includes:

(i) If a treatment process or wastewater treatment system unit is monitored in accordance with §61.354 (a)(1) of this subpart, then each period of operation during which the concentration of benzene in the monitored waste stream exiting the unit is equal to or greater than 10 ppmw.

(ii) If a treatment process or wastewater treatment system unit is monitored in accordance with §61.354 (a)(2) of this subpart, then each 3-hour period of operation during which the average value of the monitored parameter is outside the range of acceptable values or during which the unit is not operating as designed.

(iii) If a treatment process or wastewater treatment system unit is monitored in accordance with §61.354 (b), then each period of operation during which the flow-weighted annual average concentration of benzene in the monitored waste stream entering the unit is equal to or greater than 10 ppmw and/or the total annual benzene quantity is equal to or greater than 1.0 mg/yr.

(iv) For a control device monitored in accordance with §61.354(c) of this subpart, each period of operation monitored during which any of the following conditions occur, as applicable to the control device:

(A) Each 3-hour period of operation during which the average temperature of the gas stream in the combustion zone of a thermal vapor incinerator, as measured by the temperature monitoring device, is more than 28 °C (50 °F) below the design combustion zone temperature.

(B) Each 3-hour period of operation during which the average temperature of the gas stream immediately before the catalyst bed of a catalytic vapor incinerator, as measured by the temperature monitoring device, is more than 28 °C (50 °F) below the design gas stream temperature, and any 3-hour period during which the average temperature difference across the catalyst bed (i.e., the difference between the temperatures of the gas stream immediately before and after the catalyst bed), as measured by the temperature monitoring device, is less than 80 percent of the design temperature difference.

(C) Each 3-hour period of operation during which the average temperature of the gas stream in the combustion zone of a boiler or process heater having a design heat input capacity less than 44 MW (150 × 10⁶ BTU/hr), as measured by the temperature monitoring device, is more than 28 °C (50 °F) below the design combustion zone temperature.

(D) Each 3-hour period of operation during which the average concentration of organics or the average concentration of benzene in the exhaust gases from a carbon adsorber, condenser, or other vapor recovery system is more than 20 percent greater than the design concentration level of organics or benzene in the exhaust gas.

(E) Each 3-hour period of operation during which the temperature of the condenser exhaust vent stream

is more than 6 °C (11 °F) above the design average exhaust vent stream temperature, or the temperature of the coolant fluid exiting the condenser is more than 6 °C (11 °F) above the design average coolant fluid temperature at the condenser outlet.

(F) Each period in which the pilot flame of a flare is absent.

(G) Each occurrence when there is a change in the location at which the vent stream is introduced into the flame zone of a boiler or process heater as required by §61.349(a)(2)(i)(C) of this subpart.

(H) Each occurrence when the carbon in a carbon adsorber system that is regenerated directly on site in the control device is not regenerated at the predetermined carbon bed regeneration time.

(I) Each occurrence when the carbon in a carbon adsorber system that is not regenerated directly on site in the control device is not replaced at the predetermined interval specified in §61.354(c) of this subpart.

(J) Each 3-hour period of operation during which the parameters monitored are outside the range of values specified in §61.349(a)(2)(iv)(C), or any other periods specified by the Administrator for a control device subject to the requirements of §61.349(a)(2)(iv).

(v) For a cover and closed-vent system monitored in accordance with §61.354(g), the owner or operator shall submit a report quarterly to the Administrator that identifies any period in which the pressure in the waste management unit is equal to or greater than atmospheric pressure.

(8) Beginning one year after the date that the equipment necessary to comply with these standards has been certified in accordance with paragraph (d)(1) of this section, the owner or operator shall submit annually to the Administrator a report that summarizes all inspections required by §§61.342 through 61.354 during which detectable emissions are measured or a problem (such as a broken seal, gap or other problem) that could result in benzene emissions is identified, including information about the repairs or corrective action taken.

(e) An owner or operator electing to comply with the provisions of §§61.351 or 61.352 of this subpart shall notify the Administrator of the alternative standard selected in the report required under §61.07 or §61.10 of this part.

(f) An owner or operator who elects to install and operate the control equipment in §61.351 of this subpart shall comply with the reporting requirements in 40 CFR 60.115b.

(g) An owner or operator who elects to install and operate the control equipment in §61.352 of this subpart shall submit initial and quarterly reports that identify all seal gap measurements, as required in 40 CFR 60.693–2(a), that are outside the prescribed limits.

[55 FR 8346, Mar. 7 1990; 55 FR 12444, Apr. 3, 1990, as amended at 55 FR 37231, Sept. 10, 1990; 58 FR 3105, Jan. 7, 1993; 65 FR 62161, Oct. 17, 2000]

§ 61.358 Delegation of authority.

(a) In delegating implementation and enforcement authority to a State under section 112(d) of the Clean Air Act, the authorities contained in paragraph (b) of this section shall be retained by the Administrator and not transferred to a State.

(b) Alternative means of emission limitation under §61.353 of this subpart will not be delegated to States.

§ 61.359 [Reserved]

Appendix A to Part 61

APPENDIX A

National Emission Standards for Hazardous Air Pollutants
Compliance Status Information

1. SOURCE REPORT

INSTRUCTIONS: Owners or operators of sources of hazardous pollutants subject to the National Emission Standards for Hazardous Air Pollutants are required to submit the information contained in Section 1 to the appropriate U.S. Environmental Protection Agency Regional Office prior to 30 days after the effective date of any standards or amendments which require the submission of such information.

A list of regional offices is provided in 161.04.

A. SOURCE INFORMATION

1. Identification/Location - Indicate the name and address of each source.

1	2	3	4	5	6	7	8	9	10	11	12	13	14	15	16	17	18	19																				
Region	State	County	Source Number	O O O		O O		1																														
20	22	23	26	Source Name														46																				
APCR #		City Code		27															46																			
47 Street Address (Location of Plant)																			46	80																		
Dup 1-18																			19	20	City Name														34	State	35	39
40 State Regis. Number																			54	55	58	NEOS X Ref.																
59 SIC																			62	FF	8	77	79	80														
Dup 1-18																			5	64	65																	
19																			25	30	31	49	80															

2. Contact - Indicate the name and telephone number of the owner or operator or other responsible official whom EPA may contact concerning this report.

[View or download PDF](#)

Dup 1-18	4	1																43		
	19	20	21	Name														43		
44	46	47	Number	34															80	
Area Code																			47	80

3. Source Description - Briefly state the nature of the source (e.g., "Chlor-alkali Plant" or "Machine Shop").

Dup 1-18	4	2																50														
	19	20	21	Description														50														
51																			79	80	Continued											

4. Alternative Mailing Address - Indicate an alternative mailing address if correspondence is to be directed to a location different than that specified above.

Dup 1-18	4	3																45	80					
	19	20	21	Number	Street or Box Number													45	80					
Dup 1-18	4	4																44	80					
	19	20	21	City													35	State	37	38	41	Zip	44	80

5. Compliance Status - The emissions from this source can cannot meet the emission limitations contained in the National Emission Standards on or prior to 90 days after the effective date of any standards or amendments which require the submission of such information.

Signature of Owner, Operator or Other Responsible Official

NOTES: If the emissions from the source will exceed those limits set by the National Emission Standards for Hazardous Air Pollutants, the source will be in violation and subject to Federal enforcement actions unless granted a waiver of compliance by the Administrator of the U.S. Environmental Protection Agency. The information needed for such waivers is listed in Section II of this form.

B. PROCESS INFORMATION. Part B should be completed separately for each point of emission for each hazardous pollutant. [Sources subject to 61.22(f) may omit number 4. below.]

Dup 1-13	14	16	17	18	19	20	21	22	23	24	25	26	27	28	29	30	31	
													SCC	27	NEOS X Ref		30	31
															LS	SIP		

[View or download PDF](#)

1. **Pollutant Emitted** - Indicate the type of hazardous pollutant emitted by the process. Indicate "AS" for asbestos, "BT" for beryllium, or "ME" for mercury.

32 33
Pollutant 34 Regulation 48 49
EC

2. **Process Description** - Provide a brief description of each process (e.g., "hydrogen and box" in a mercury chlor-alkali plant, "grinding machine" in a beryllium machine shop). Use additional sheets if necessary.

50 Process Description 74 80

Dup 1-18 6 1 19 20 21 50
61 79 80
Dup 1-18 6 2 19 20 21 50
61 79 80

3. **Amount of Pollutant** - Indicate the average weight of the hazardous material named in Item 1 which enters the process in pounds per month (based on the previous twelve months of operation).

Dup 1-18 6 3 19 20 21 27 29 lbs./mo. 36 80

4. **Control Devices**
a. Indicate the type of pollution control devices, if any, used to reduce the emissions from the process (e.g., venturi scrubber, baghouse, wet cyclone) and the estimated percent of the pollutant which the device removes from the process gas stream.

Dup 1-18 6 4 19 20 21 PRIMARY CONTROL DEVICE: 43

45 Primary Device Name 54 66 70 Percent Removal Efficiency 72 79

80

[View or download PDF](#)

Dup 1-18 6 5 19 20 21 SECONDARY CONTROL DEVICES: 45

47 Secondary Device Name 54 66 70 Percent Removal Efficiency 72 79 80

- b. **Asbestos Emission Control Devices Only**
1. If a baghouse is specified in Item 4a, give the following information:
 - The air flow permeability in cubic feet per minute per square foot of fabric area.
Air flow permeability = _____ cfm/ft²
 - The pressure drop in inches water gauge across the filter at which the baghouse is operated.
Operating pressure drop = _____ inches w.g.
 - If the baghouse material contains synthetic fill yarn, check whether this material is / / spun / / or NOT spun.
 - If the baghouse utilizes a felted fabric, give the minimum thickness in inches and the density in ounces per square yard.
Thickness = _____ inches Density = _____ oz/yd²
 11. If a wet collection device is specified in Item 4a, give the designed unit contacting energy in inches water gauge.
 - Unit contacting energy = _____ inches w.g.

c. **DISPOSAL OF ASBESTOS-CONTAINING WASTES.** Part C should be completed separately for each asbestos-containing waste generation operation arising from sources subject to 161.22(a), (c), (e), and (h).

Dup 1-18 14 16 17 18 19 20 SCC 27 28 29 30 31
MEDS X Ref CS SSP
A B
32 33
Pollutant 34 Regulation 48 49
EC

[View or download PDF](#)

1. Waste Generation - Provide a brief description of each process that generates asbestos-containing waste (e.g. disposal of control device wastes).

50 _____ 79 80
 Process Description

2. Asbestos Concentration - Indicate the average percentage asbestos content of these materials.

Dup 1-18 6 1 _____ 43 45 _____ 48
 19 20 21 ASBESTOS CONCENTRATION: _____

50 80

3. Amount of Wastes - Indicate the average weight of asbestos-containing wastes disposed of, measured in kg/day.

Dup 1-18 6 2 _____ 34 80
 19 20 21 _____ 27 29 kg/day

4. Control Methods - Indicate the emission control methods used in all stages of waste disposal, from collection, processing, and packaging to transporting and deposition.

Dup 1-18 6 3 _____ 43
 19 20 21 Primary Control Method

45 _____ 79 80

Dup 1-18 6 4 _____ 50
 19 20 21 _____

51 _____ 79 80

5. Waste Disposal - Indicate the type of disposal site (sanitary landfill, open, covered) or incineration site (municipal, private) where the waste is disposed of and who operates the site (company, private, municipal). State the name and location of the site (closest city or town, county, state).

Dup 1-18 6 5 _____ 33 35 _____ 50
 19 20 21 TYPE OF SITE: _____

51 _____ 79 80

[View or download PDF](#)

Dup 1-18 6 6 _____ 29 31 _____ 50
 19 20 21 OPERATOR: _____

51 _____ 79 80

Dup 1-18 6 7 _____ 29
 19 20 21 LOCATION: _____

51 _____ 70

71 _____ 79 80

- D. WASTE DISPOSAL SITES. Part D should be completed separately for each asbestos waste disposal site subject to section 61.22(f).

Dup 1-13 0 0 _____ 27 28 29 30 31
 14 16 17 18 19 20 SEC NEPS X Ref CS 51P

A B
 32 33 34 Regulation 48 50
 Pollutant EC

50 _____ 86 88

1. Description - Provide a brief description of the site, including its size and configuration, and the distance to the closest city or town, closest residence, and closest primary road.

Dup 1-18 6 1 _____ 37 39 _____ 50
 19 20 21 SITE DESCRIPTION

51 _____ 79 80

Dup 1-18 6 2 _____ 34 36 _____ 40 42 43
 19 20 21 DISTANCE: _____ TOWN: _____ K M

45 _____ 54 56 _____ 60 62 63 65 _____ 69 71 _____ 75
 RESIDENCE: _____ K M ROAD: _____

77 78 80

[View or download PDF](#)

- 2. **Inactivation** - After the site is inactivated, indicate the method or methods used to comply with the standard and send a list of the actions that will be undertaken to maintain the inactivated site.

Dup 1-18 6 8
 19 20 21 COMPLIANCE METHOD/INACTIVE SITE: 52
 54 79 80

[View or download PDF](#)

II. Waiver Requests

A. Waiver of Compliance. Owners or operators of sources unable to operate in compliance with the National Emission Standards for Hazardous Air Pollutants prior to 90 days after the effective date of any standards or amendments which require the submission of such information may request a waiver of compliance from the Administrator of the U.S. Environmental Protection Agency for the time period necessary to install appropriate control devices or make modifications to achieve compliance. The Administrator may grant a waiver of compliance with the standard for a period not exceeding two years from the effective date of the hazardous pollutant standards, if he finds that such period is necessary for the installation of controls and that steps will be taken during the period of the waiver to assure that the health of persons will be protected from imminent endangerment.

The report information provided in Section I must accompany this application. Applications should be sent to the appropriate EPA regional office.

- 1. **Processes Involved** —Indicate the process or processes emitting hazardous pollutants to which emission controls are to be applied.

2. Controls

- a. Describe the proposed type of control device to be added or modification to be made to the process to reduce the emission of hazardous pollutants to an acceptable level. (Use additional sheets if necessary.)
- b. Describe the measures that will be taken during the waiver period to assure that the health of persons will be protected from imminent endangerment. (Use additional sheets if necessary.)

- 3. **Increments of Progress** —Specify the dates by which the following increments of progress will be met.

Date by which contracts for emission control systems or process modifications will be awarded; or date by which orders will be issued for the purchase of the component parts to accomplish emission control or process modification.

Dup 1-16 0 1 7
 17 19 53 54 55 _____ 60 61 MO/DY/YR 66 80
 Date of initiation of on-site construction or installation of emission control equipment or process change.

Dup 1-16 0 2 7
 17 19 53 54 55 _____ 60 61 MO/DY/YR 66 80
 Date by which on-site construction or installation of emission control equipment or process modification is to be completed.

Dup 1-16 0 3 7
 17 19 53 54 55 _____ 60 61 MO/DY/YR 66 80
 Date by which final compliance is to be achieved.

Dup 1-16 0 4 7
 17 19 53 54 55 _____ 60 61 MO/DY/YR 66 80

[View or download PDF](#)

B. Waiver of Emission Tests. A waiver of emission testing may be granted to owners or operators of sources subject to emission testing if, in the judgment of the Administrator of the Environmental Protection Agency the emissions from the source comply with the appropriate standard or if the owners or operators of the source have requested a waiver of compliance or have been granted a waiver of

compliance.

This application should accompany the report information provided in Section I.

1. *Reason*—State the reasons for requesting a waiver of emission testing. If the reason stated is that the emissions from the source are within the prescribed limits, documentation of this condition must be attached.

Date _____
Signature of the owner or operator

(Sec. 114, of the Clean Air Act as amended (42 U.S.C. 7414))

[40 FR 48303, Oct. 14, 1975, as amended at 43 FR 8800, Mar. 3, 1978; 50 FR 46295, Sept. 9, 1985]

Appendix B to Part 61—Test Methods

Method 101—Determination of particulate and gaseous mercury emissions from chlor-alkali plants (air streams)

Method 101A—Determination of particulate and gaseous mercury emissions from sewage sludge incinerators

Method 102—Determination of particulate and gaseous mercury emissions from chlor-alkali plants (hydrogen streams)

Method 103—Beryllium screening method

Method 104—Determination of beryllium emissions from stationary sources

Method 105—Determination of mercury in wastewater treatment plant sewage sludges

Method 106—Determination of vinyl chloride emissions from stationary sources

Method 107—Determination of vinyl chloride content of in-process wastewater samples, and vinyl chloride content of polyvinyl chloride resin slurry, wet cake, and latex samples

Method 107A—Determination of vinyl chloride content of solvents, resin-solvent solution, polyvinyl chloride resin, resin slurry, wet resin, and latex samples

Method 108—Determination of particulate and gaseous arsenic emissions

Method 108A—Determination of arsenic content in ore samples from nonferrous smelters

Method 108B—Determination of arsenic content in ore samples from nonferrous smelters

Method 108C—Determination of arsenic content in ore samples from nonferrous smelters (molybdenum blue photometric procedure)

Method 111—Determination of Polonium—210 emissions from stationary sources

Method 101—Determination of Particulate and Gaseous Mercury Emissions From Chlor-Alkali Plants (Air Streams)

Note: This method does not include all of the specifications (e.g., equipment and supplies) and procedures (e.g., sampling and analytical) essential to its performance. Some material is

incorporated by reference from methods in appendix A to 40 CFR part 60. Therefore, to obtain reliable results, persons using this method should have a thorough knowledge of at least the following additional test methods: Method 1, Method 2, Method 3, and Method 5.

1.0 Scope and Application

1.1 Analytes.

Analyte	CAS No.	Sensitivity
Mercury (Hg)	7439-97-6	Dependent upon recorder and spectrophotometer.

1.2 Applicability. This method is applicable for the determination of Hg emissions, including both particulate and gaseous Hg, from chlor-alkali plants and other sources (as specified in the regulations) where the carrier-gas stream in the duct or stack is principally air.

1.3 Data Quality Objectives. Adherence to the requirements of this method will enhance the quality of the data obtained from air pollutant sampling methods.

2.0 Summary of Method

Particulate and gaseous Hg emissions are withdrawn isokinetically from the source and collected in acidic iodine monochloride (ICI) solution. The Hg collected (in the mercuric form) is reduced to elemental Hg, which is then aerated from the solution into an optical cell and measured by atomic absorption spectrophotometry.

3.0 Definitions[Reserved]

4.0 Interferences

4.1 Sample Collection. Sulfur dioxide (SO₂) reduces ICI and causes premature depletion of the ICI solution.

4.2 Sample Analysis.

4.2.1 ICI concentrations greater than 10⁻⁴ molar inhibit the reduction of the Hg (II) ion in the aeration cell.

4.2.2 Condensation of water vapor on the optical cell windows causes a positive interference.

5.0 Safety

5.1 Disclaimer. This method may involve hazardous materials, operations, and equipment. This test method does not purport to address all of the safety problems associated with its use. It is the responsibility of the user of this test method to establish appropriate safety and health practices and determine the applicability of regulatory limitations prior to performing this test method.

5.2 Corrosive Reagents. The following reagents are hazardous. Personal protective equipment and safe procedures are useful in preventing chemical splashes. If contact occurs, immediately flush with copious amounts of water for at least 15 minutes. Remove clothing under shower and decontaminate. Treat residual chemical burn as thermal burn.

5.2.1 Hydrochloric Acid (HCl). Highly toxic and corrosive. Causes severe damage to tissues. Vapors are highly irritating to eyes, skin, nose, and lungs, causing severe damage. May cause bronchitis, pneumonia, or edema of lungs. Exposure to concentrations of 0.13 to 0.2 percent can be lethal to humans in a few minutes. Provide ventilation to limit exposure. Reacts with metals, producing hydrogen gas.

5.2.2 Nitric Acid (HNO₃). Highly corrosive to eyes, skin, nose, and lungs. Vapors cause bronchitis, pneumonia, or edema of lungs. Reaction to inhalation may be delayed as long as 30 hours and still be fatal. Provide ventilation to limit exposure. Strong oxidizer. Hazardous reaction may occur with organic materials such as solvents.

5.2.3 Sulfuric Acid (H₂SO₄). Rapidly destructive to body tissue. Will cause third degree burns. Eye damage may result in blindness. Inhalation may be fatal from spasm of the larynx, usually within 30 minutes. 3 mg/m³ will cause lung damage. 1 mg/m³ for 8 hours will cause lung damage or, in higher concentrations, death. Provide ventilation to limit inhalation. Reacts violently with metals and organics.

6.0 Equipment and Supplies.

6.1 Sample Collection. A schematic of the sampling train used in performing this method is shown in Figure 101-1; it is similar to the Method 5 sampling train. The following items are required for sample collection:

6.1.1 Probe Nozzle, Pitot Tube, Differential Pressure Gauge, Metering System, Barometer, and Gas Density Determination Equipment. Same as Method 5, Sections 6.1.1.1, 6.1.1.3, 6.1.1.4, 6.1.1.9, 6.1.2, and 6.1.3, respectively.

6.1.2 Probe Liner. Borosilicate or quartz glass tubing. A heating system capable of maintaining a gas temperature of 120 ±14 °C (248 ±25 °F) at the probe exit during sampling may be used to prevent water condensation.

Note: Do not use metal probe liners.

6.1.3 Impingers. Four Greenburg-Smith impingers connected in series with leak-free ground glass fittings or any similar leak-free noncontaminating fittings. For the first, third, and fourth impingers, impingers that are modified by replacing the tip with a 13-mm ID (0.5-in.) glass tube extending to 13 mm (0.5 in.) from the bottom of the flask may be used.

6.1.4 Acid Trap. Mine Safety Appliances air line filter, Catalog number 81857, with acid absorbing cartridge and suitable connections, or equivalent.

6.2 Sample Recovery. The following items are needed for sample recovery:

6.2.1 Glass Sample Bottles. Leakless, with Teflon-lined caps, 1000- and 100-ml.

6.2.2 Graduated Cylinder. 250-ml.

6.2.3 Funnel and Rubber Policeman. To aid in transfer of silica gel to container; not necessary if silica gel is weighed in the field.

6.2.4 Funnel. Glass, to aid in sample recovery.

6.3 Sample Preparation and Analysis. The following items are needed for sample preparation and analysis:

6.3.1 Atomic Absorption Spectrophotometer. Perkin-Elmer 303, or equivalent, containing a hollow-cathode mercury lamp and the optical cell described in Section 6.3.2.

6.3.2 Optical Cell. Cylindrical shape with quartz end windows and having the dimensions shown in Figure 101-2. Wind the cell with approximately 2 meters (6 ft) of 24-gauge Nichrome wire, or equivalent, and wrap with fiberglass insulation tape, or equivalent; do not let the wires touch each other.

6.3.3 Aeration Cell. Constructed according to the specifications in Figure 101-3. Do not use a glass frit as a substitute for the blown glass bubbler tip shown in Figure 101-3.

6.3.4 Recorder. Matched to output of the spectrophotometer described in Section 6.3.1.

6.3.5 Variable Transformer. To vary the voltage on the optical cell from 0 to 40 volts.

6.3.6 Hood. For venting optical cell exhaust.

6.3.7 Flow Metering Valve.

6.3.8 Rate Meter. Rotameter, or equivalent, capable of measuring to within 2 percent a gas flow of 1.5 liters/min (0.053 cfm).

6.3.9 Aeration Gas Cylinder. Nitrogen or dry, Hg-free air, equipped with a single-stage regulator.

6.3.10 Tubing. For making connections. Use glass tubing (ungreased ball and socket connections are recommended) for all tubing connections between the solution cell and the optical cell; do not use Tygon tubing, other types of flexible tubing, or metal tubing as substitutes. Teflon, steel, or copper tubing may be used between the nitrogen tank and flow metering valve (Section 6.3.7), and Tygon, gum, or rubber tubing between the flow metering valve and the aeration cell.

6.3.11 Flow Rate Calibration Equipment. Bubble flow meter or wet-test meter for measuring a gas flow rate of 1.5 ± 0.1 liters/min (0.053 ± 0.0035 cfm).

6.3.12 Volumetric Flasks. Class A with penny head standard taper stoppers; 100-, 250-, 500-, and 1000-ml.

6.3.13 Volumetric Pipets. Class A; 1-, 2-, 3-, 4-, and 5-ml.

6.3.14 Graduated Cylinder. 50-ml.

6.3.15 Magnetic Stirrer. General-purpose laboratory type.

6.3.16 Magnetic Stirring Bar. Teflon-coated.

6.3.17 Balance. Capable of weighing to ± 0.5 g.

6.3.18 Alternative Analytical Apparatus. Alternative systems are allowable as long as they meet the following criteria:

6.3.18.1 A linear calibration curve is generated and two consecutive samples of the same aliquot size and concentration agree within 3 percent of their average.

6.3.18.2 A minimum of 95 percent of the spike is recovered when an aliquot of a source sample is spiked with a known concentration of Hg (II) compound.

6.3.18.3 The reducing agent should be added after the aeration cell is closed.

6.3.18.4 The aeration bottle bubbler should not contain a frit.

6.3.18.5 Any Tygon tubing used should be as short as possible and conditioned prior to use until blanks and standards yield linear and reproducible results.

6.3.18.6 If manual stirring is done before aeration, it should be done with the aeration cell closed.

6.3.18.7 A drying tube should not be used unless it is conditioned as the Tygon tubing above.

7.0 Reagents and Standards

Unless otherwise indicated, all reagents must conform to the specifications established by the Committee on Analytical Reagents of the American Chemical Society; where such specifications are not available, use the best available grade.

7.1 Sample Collection. The following reagents are required for sample collection:

7.1.1 Water. Deionized distilled, to conform to ASTM D 1193-77 or 91 (incorporated by reference—see §61.18), Type 1. If high concentrations of organic matter are not expected to be present, the analyst may eliminate the KMnO_4 test for oxidizable organic matter. Use this water in all dilutions and solution preparations.

7.1.2 Nitric Acid, 50 Percent (v/v). Mix equal volumes of concentrated HNO_3 and water, being careful to add the acid to the water slowly.

7.1.3 Silica Gel. Indicating type, 6- to 16-mesh. If previously used, dry at 175 °C (350 °F) for 2 hours. The tester may use new silica gel as received.

7.1.4 Potassium Iodide (KI) Solution, 25 Percent. Dissolve 250 g of KI in water, and dilute to 1 liter.

7.1.5 Iodine Monochloride Stock Solution, 1.0 M. To 800 ml of 25 percent KI solution, add 800 ml of concentrated HCl. Cool to room temperature. With vigorous stirring, slowly add 135 g of potassium iodate (KIO_3), and stir until all free iodine has dissolved. A clear orange-red solution occurs when all the KIO_3 has been added. Cool to room temperature, and dilute to 1800 ml with water. Keep the solution in amber glass bottles to prevent degradation.

7.1.6 Absorbing Solution, 0.1 M ICl. Dilute 100 ml of the 1.0 M ICl stock solution to 1 liter with water. Keep the solution in amber glass bottles and in darkness to prevent degradation. This reagent is stable for at least two months.

7.2 Sample Preparation and Analysis. The following reagents and standards are required for sample preparation and analysis:

7.2.1 Reagents.

7.2.1.1 Tin (II) Solution. Prepare fresh daily, and keep sealed when not being used. Completely dissolve 20 g of tin (II) chloride (or 25 g of tin (II) sulfate) crystals (Baker Analyzed reagent grade or any other brand that will give a clear solution) in 25 ml of concentrated HCl. Dilute to 250 ml with water. Do not substitute HNO_3 , H_2SO_4 , or other strong acids for the HCl.

7.2.1.2 Sulfuric Acid, 5 Percent (v/v). Dilute 25 ml of concentrated H_2SO_4 to 500 ml with water.

7.2.2 Standards

7.2.2.1 Hg Stock Solution, 1 mg Hg/ml. Prepare and store all Hg standard solutions in borosilicate glass containers. Completely dissolve 0.1354 g of Hg (II) chloride in 75 ml of water in a 100-ml glass volumetric flask. Add 10 ml of concentrated HNO_3 , and adjust the volume to exactly 100 ml with water. Mix thoroughly. This solution is stable for at least one month.

7.2.2.2 Intermediate Hg Standard Solution, 10 µg Hg/ml. Prepare fresh weekly. Pipet 5.0 ml of the Hg stock solution (Section 7.2.2.1) into a 500-ml glass volumetric flask, and add 20 ml of the 5 percent H_2SO_4 solution. Dilute to exactly 500 ml with water. Thoroughly mix the solution.

7.2.2.3 Working Hg Standard Solution, 200 ng Hg/ml. Prepare fresh daily. Pipet 5.0 ml of the intermediate Hg standard solution (Section 7.2.2.2) into a 250-ml volumetric glass flask. Add 10 ml of the 5 percent H_2SO_4 and 2 ml of the 0.1 M ICl absorbing solution taken as a blank (Section 8.7.4.3), and dilute to 250 ml with water. Mix thoroughly.

8.0 Sample Collection, Preservation, Transport, and Storage

Because of the complexity of this method, testers should be trained and experienced with the test procedures to ensure reliable results. Since the amount of Hg that is collected generally is small, the method must be carefully applied to prevent contamination or loss of sample.

8.1 Pretest Preparation. Follow the general procedure outlined in Method 5, Section 8.1, except omit Sections 8.1.2 and 8.1.3.

8.2 Preliminary Determinations. Follow the general procedure outlined in Method 5, Section 8.2, with the exception of the following:

8.2.1 Select a nozzle size based on the range of velocity heads to assure that it is not necessary to change the nozzle size in order to maintain isokinetic sampling rates below 28 liters/min (1.0 cfm).

8.2.2 Perform test runs such that samples are obtained over a period or periods that accurately determine the maximum emissions that occur in a 24-hour period. In the case of cyclic operations, run sufficient tests for the accurate determination of the emissions that occur over the duration of the cycle. A minimum sample time of 2 hours is recommended. In some instances, high Hg or high SO₂ concentrations make it impossible to sample for the desired minimum time. This is indicated by reddening (liberation of free iodine) in the first impinger. In these cases, the sample run may be divided into two or more subruns to ensure that the absorbing solution is not depleted.

8.3 Preparation of Sampling Train.

8.3.1 Clean all glassware (probe, impingers, and connectors) by rinsing with 50 percent HNO₃, tap water, 0.1 M ICI, tap water, and finally deionized distilled water. Place 100 ml of 0.1 M ICI in each of the first three impingers. Take care to prevent the absorbing solution from contacting any greased surfaces. Place approximately 200 g of preweighed silica gel in the fourth impinger. More silica gel may be used, but care should be taken to ensure that it is not entrained and carried out from the impinger during sampling. Place the silica gel container in a clean place for later use in the sample recovery. Alternatively, determine and record the weight of the silica gel plus impinger to the nearest 0.5 g.

8.3.2 Install the selected nozzle using a Viton A O-ring when stack temperatures are less than 260 °C (500 °F). Use a fiberglass string gasket if temperatures are higher. See APTD-0576 (Reference 3 in Method 5) for details. Other connecting systems using either 316 stainless steel or Teflon ferrules may be used. Mark the probe with heat-resistant tape or by some other method to denote the proper distance into the stack or duct for each sampling point.

8.3.3 Assemble the train as shown in Figure 101-1, using (if necessary) a very light coat of silicone grease on all ground glass joints. Grease only the outer portion (see APTD-0576) to avoid the possibility of contamination by the silicone grease.

Note: An empty impinger may be inserted between the third impinger and the silica gel to remove excess moisture from the sample stream.

8.3.4 After the sampling train has been assembled, turn on and set the probe heating system, if applicable, at the desired operating temperature. Allow time for the temperatures to stabilize. Place crushed ice around the impingers.

8.4 Leak-Check Procedures. Follow the leak-check procedures outlined in Method 5, Section 8.4.

8.5 Sampling Train Operation. Follow the general procedure outlined in Method 5, Section 8.5. For each run, record the data required on a data sheet such as the one shown in Figure 101-4.

8.6 Calculation of Percent Isokinetic. Same as Method 5, Section 8.6.

8.7 Sample Recovery. Begin proper cleanup procedure as soon as the probe is removed from the stack at the end of the sampling period.

8.7.1 Allow the probe to cool. When it can be safely handled, wipe off any external particulate matter near the tip of the probe nozzle, and place a cap over it. Do not cap off the probe tip tightly while the sampling train is cooling. Capping would create a vacuum and draw liquid out from the impingers.

8.7.2 Before moving the sampling train to the cleanup site, remove the probe from the train, wipe off the silicone grease, and cap the open outlet of the probe. Be careful not to lose any condensate that might be present. Wipe off the silicone grease from the impinger. Use either ground-glass stoppers, plastic caps, or serum caps to close these openings.

8.7.3 Transfer the probe and impinger assembly to a cleanup area that is clean, protected from the wind, and free of Hg contamination. The ambient air in laboratories located in the immediate vicinity of Hg-using facilities is not normally free of Hg contamination.

8.7.4 Inspect the train before and during disassembly, and note any abnormal conditions. Treat the samples as follows.

8.7.4.1 Container No. 1 (Impingers and Probe).

8.7.4.1.1 Using a graduated cylinder, measure the liquid in the first three impingers to within 1 ml. Record the volume of liquid present (e.g., see Figure 5–6 of Method 5). This information is needed to calculate the moisture content of the effluent gas. (Use only glass storage bottles and graduated cylinders that have been precleaned as in Section 8.3.1) Place the contents of the first three impingers into a 1000-ml glass sample bottle.

8.7.4.1.2 Taking care that dust on the outside of the probe or other exterior surfaces does not get into the sample, quantitatively recover the Hg (and any condensate) from the probe nozzle, probe fitting, and probe liner as follows: Rinse these components with two 50-ml portions of 0.1 M ICl. Next, rinse the probe nozzle, fitting and liner, and each piece of connecting glassware between the probe liner and the back half of the third impinger with a maximum of 400 ml of water. Add all washings to the 1000-ml glass sample bottle containing the liquid from the first three impingers.

8.7.4.1.3 After all washings have been collected in the sample container, tighten the lid on the container to prevent leakage during shipment to the laboratory. Mark the height of the liquid to determine later whether leakage occurred during transport. Label the container to identify clearly its contents.

8.7.4.2 Container No. 2 (Silica Gel). Same as Method 5, Section 8.7.6.3.

8.7.4.3 Container No. 3 (Absorbing Solution Blank). Place 50 ml of the 0.1 M ICl absorbing solution in a 100-ml sample bottle. Seal the container. Use this blank to prepare the working Hg standard solution (Section 7.2.2.3).

9.0 Quality Control

9.1 Miscellaneous Quality Control Measures.

Section	Quality control measure	Effect
8.4 10.2	Sampling equipment leak-checks and calibration	Ensure accuracy and precision of sampling measurements.
10.5, 10.6	Spectrophotometer calibration	Ensure linearity of spectrophotometer response to standards.
11.3.3	Check for matrix effects	Eliminate matrix effects.

9.2 Volume Metering System Checks. Same as Method 5, Section 9.2.

10.0 Calibration and Standardizations

Note: Maintain a laboratory log of all calibrations.

10.1 Before use, clean all glassware, both new and used, as follows: brush with soap and tap water, liberally rinse with tap water, soak for 1 hour in 50 percent HNO_3 , and then rinse with deionized distilled water.

10.2 Sampling Equipment. Calibrate the sampling equipment according to the procedures outlined in the following sections of Method 5: Section 10.1 (Probe Nozzle), Section 10.2 (Pitot Tube Assembly), Section 10.3 (Metering System), Section 10.5 (Temperature Sensors), Section 10.6 (Barometer).

10.3 Aeration System Flow Rate Meter. Assemble the aeration system as shown in Figure 101-5. Set the outlet pressure on the aeration gas cylinder regulator to a minimum pressure of 500 mm Hg (10 psi), and use the flow metering valve and a bubble flowmeter or wet-test meter to obtain a flow rate of 1.5 ± 0.1 liters/min (0.053 ± 0.0035 cfm) through the aeration cell. After the calibration of the aeration system flow rate meter is complete, remove the bubble flowmeter from the system.

10.4 Optical Cell Heating System. Using a 50-ml graduated cylinder, add 50 ml of water to the bottle section of the aeration cell, and attach the bottle section to the bubbler section of the cell. Attach the aeration cell to the optical cell and while aerating at 1.5 ± 0.1 liters/min (0.053 ± 0.0035 cfm), determine the minimum variable transformer setting necessary to prevent condensation of moisture in the optical cell and in the connecting tubing. (This setting should not exceed 20 volts.)

10.5 Spectrophotometer and Recorder.

10.5.1 The Hg response may be measured by either peak height or peak area.

Note: The temperature of the solution affects the rate at which elemental Hg is released from a solution and, consequently, it affects the shape of the absorption curve (area) and the point of maximum absorbance (peak height). Therefore, to obtain reproducible results, bring all solutions to room temperature before use.

10.5.2 Set the spectrophotometer wavelength at 253.7 nm, and make certain the optical cell is at the minimum temperature that will prevent water condensation. Then set the recorder scale as follows: Using a 50-ml graduated cylinder, add 50 ml of water to the aeration cell bottle. Add three drops of Antifoam B to the bottle, and then pipet 5.0 ml of the working Hg standard solution into the aeration cell.

Note: Always add the Hg-containing solution to the aeration cell after the 50 ml of water.

10.5.3 Place a Teflon-coated stirring bar in the bottle. Before attaching the bottle section to the bubbler section of the aeration cell, make certain that (1) the aeration cell exit arm stopcock (Figure 101-3) is closed (so that Hg will not prematurely enter the optical cell when the reducing agent is being added) and (2) there is no flow through the bubbler. If conditions (1) and (2) are met, attach the bottle section to the bubbler section of the aeration cell. Pipet 5 ml of tin (II) reducing solution into the aeration cell through the side arm, and immediately stopper the side arm. Stir the solution for 15 seconds, turn on the recorder, open the aeration cell exit arm stopcock, and immediately initiate aeration with continued stirring. Determine the maximum absorbance of the standard, and set this value to read 90 percent of the recorder full scale.

10.6 Calibration Curve.

10.6.1 After setting the recorder scale, repeat the procedure in Section 10.5 using 0.0-, 1.0-, 2.0-, 3.0-, 4.0-, and 5.0-ml aliquots of the working standard solution (final amount of Hg in the aeration cell is 0, 200, 400, 600, 800, and 1000 ng, respectively). Repeat this procedure on each aliquot size until two consecutive peaks agree within 3 percent of their average value.

Note: To prevent Hg carryover from one sample to another, do not close the aeration cell from the optical cell until the recorder pen has returned to the baseline.)

10.6.2 It should not be necessary to disconnect the aeration gas inlet line from the aeration cell when

11.4 Container No. 2 (Silica Gel). Weigh the spent silica gel (or silica gel plus impinger) to the nearest 0.5 g using a balance. (This step may be conducted in the field.)

12.0 Data Analysis and Calculations

Carry out calculations, retaining at least one extra decimal significant figure beyond that of the acquired data. Round off figures only after the final calculation. Other forms of the equations may be used as long as they give equivalent results.

12.1 Average Dry Gas Meter Temperature and Average Orifice Pressure Drop, Dry Gas Volume, Volume of Water Vapor Condensed, Moisture Content, and Isokinetic Variation. Same as Method 5, Sections 12.2 through 12.5 and 12.11, respectively.

12.2 Stack Gas Velocity. Using the data from this test and Equation 2–9 of Method 2, calculate the average stack gas velocity v_s .

12.3 Total Mercury.

12.3.1 For each source sample, correct the average maximum absorbance of the two consecutive samples whose peak heights agree within 3 percent of their average for the contribution of the solution blank (see Section 10.6.3). Use the calibration curve and these corrected averages to determine the final total weight of Hg in ng in the aeration cell for each source sample.

12.3.2 Correct for any dilutions made to bring the sample into the working range of the spectrophotometer. Then calculate the Hg in the original solution, m_{Hg} , as follows:

$$m_{\text{Hg}} = \left[C_{\text{Hg(AC)}} (DF) (V_f) (10^{-3}) \right] / S \quad \text{Eq. 101-1}$$

Where:

CHg(AC)= Total ng of Hg in aliquot analyzed (reagent blank subtracted).

DF = Dilution factor for the Hg-containing solution (before adding to the aeration cell; e.g., DF = 250/2 if the source samples were diluted as described in Section 11.2.2).

V_f = Solution volume of original sample, 1000 ml for samples diluted as described in Section 11.2.1.

10^{-3} = Conversion factor, $\mu\text{g}/\text{ng}$.

S = Aliquot volume added to aeration cell, ml.

12.4 Mercury Emission Rate. Calculate the daily Hg emission rate, R, using Equation 101–2. For continuous operations, the operating time is equal to 86,400 seconds per day. For cyclic operations, use only the time per day each stack is in operation. The total Hg emission rate from a source will be the summation of results from all stacks.

$$R = \frac{K m_{\text{Hg}} V_s A_s (86,400 \times 10^{-6})}{\left[V_{m(\text{std})} + V_{w(\text{std})} \right] (T_s / P_s)} \quad \text{Eq. 101-2}$$

Where:

K_1 = 0.3858 °K/mm Hg for metric units.

$K_1 = 17.64$ °R/in. Hg for English units.

$K_3 = 10^{-6}$ g/μg for metric units.

$= 2.2046 \times 10^{-9}$ lb/μg for English units.

P_s = Absolute stack gas pressure, mm Hg (in. Hg).

t = Daily operating time, sec/day.

T_s = Absolute average stack gas temperature, °K (°R).

$V_m(\text{std})$ = Dry gas sample volume at standard conditions, scm (scf).

$V_w(\text{std})$ = Volume of water vapor at standard conditions, scm (scf).

12.5 Determination of Compliance. Each performance test consists of three repetitions of the applicable test method. For the purpose of determining compliance with an applicable national emission standard, use the average of the results of all repetitions.

13.0 Method Performance

The following estimates are based on collaborative tests, wherein 13 laboratories performed duplicate analyses on two Hg-containing samples from a chlor-alkali plant and on one laboratory-prepared sample of known Hg concentration. The sample concentrations ranged from 2 to 65 μg Hg/ml.

13.1 Precision. The estimated intra-laboratory and inter-laboratory standard deviations are 1.6 and 1.8 μg Hg/ml, respectively.

13.2 Accuracy. The participating laboratories that analyzed a 64.3 μg Hg/ml (in 0.1 M ICI) standard obtained a mean of 63.7 μg Hg/ml.

13.3 Analytical Range. After initial dilution, the range of this method is 0.5 to 120 μg Hg/ml. The upper limit can be extended by further dilution of the sample.

14.0 Pollution Prevention.[Reserved]

15.0 Waste Management.[Reserved]

16.0 References

Same as Method 5, Section 17.0, References 1–3, 5, and 6, with the addition of the following:

1. Determining Dust Concentration in a Gas Stream. ASME Performance Test Code No. 27. New York, NY. 1957.
2. DeVorkin, Howard, *et al.* Air Pollution Source Testing Manual. Air Pollution Control District. Los Angeles, CA. November 1963.
3. Hatch, W.R., and W.I. Ott. Determination of Sub-Microgram Quantities of Mercury by Atomic Absorption Spectrophotometry. *Anal. Chem.* 40:2085–87. 1968.
4. Mark, L.S. Mechanical Engineers' Handbook. McGraw-Hill Book Co., Inc. New York, NY. 1951.
5. Western Precipitation Division of Joy Manufacturing Co. Methods for Determination of Velocity, Volume, Dust and Mist Content of Gases. Bulletin WP–50. Los Angeles, CA. 1968.

6. Perry, J.H. Chemical Engineers' Handbook. McGraw-Hill Book Co., Inc. New York, NY. 1960.
 7. Shigehara, R.T., W.F. Todd, and W.S. Smith. Significance of Errors in Stack Sampling Measurements. *Stack Sampling News*. 1 (3):6–18. September 1973.
 8. Smith, W.S., R.T. Shigehara, and W.F. Todd. A Method of Interpreting Stack Sampling Data. *Stack Sampling News*. 1 (2):8–17. August 1973.
 9. Standard Method for Sampling Stacks for Particulate Matter. In: 1971 Annual Book of ASTM Standards, Part 23. ASTM Designation D 2928–71. Philadelphia, PA 1971.
 10. Vennard, J.K. Elementary Fluid Mechanics. John Wiley and Sons, Inc. New York. 1947.
 11. Mitchell, W.J. and M.R. Midgett. Improved Procedure for Determining Mercury Emissions from Mercury Cell Chlor-Alkali Plants. *J. APCA*. 26 :674–677. July 1976.
 12. Shigehara, R.T. Adjustments in the EPA Nomograph for Different Pitot Tube Coefficients and Dry Molecular Weights. *Stack Sampling News*. 2 :4–11. October 1974.
 13. Vollaro, R.F. Recommended Procedure for Sample Traverses in Ducts Smaller than 12 Inches in Diameter. U.S. Environmental Protection Agency, Emission Measurement Branch. Research Triangle Park, NC. November 1976.
 14. Klein, R. and C. Hach. Standard Additions: Uses and Limitation in Spectrophotometric Measurements. *Amer. Lab.* 9 :21. 1977.
 15. Perkin Elmer Corporation. Analytical Methods for Atomic Absorption Spectrophotometry. Norwalk, Connecticut. September 1976.
- 17.0 *Tables, Diagrams, Flowcharts, and Validation Data*

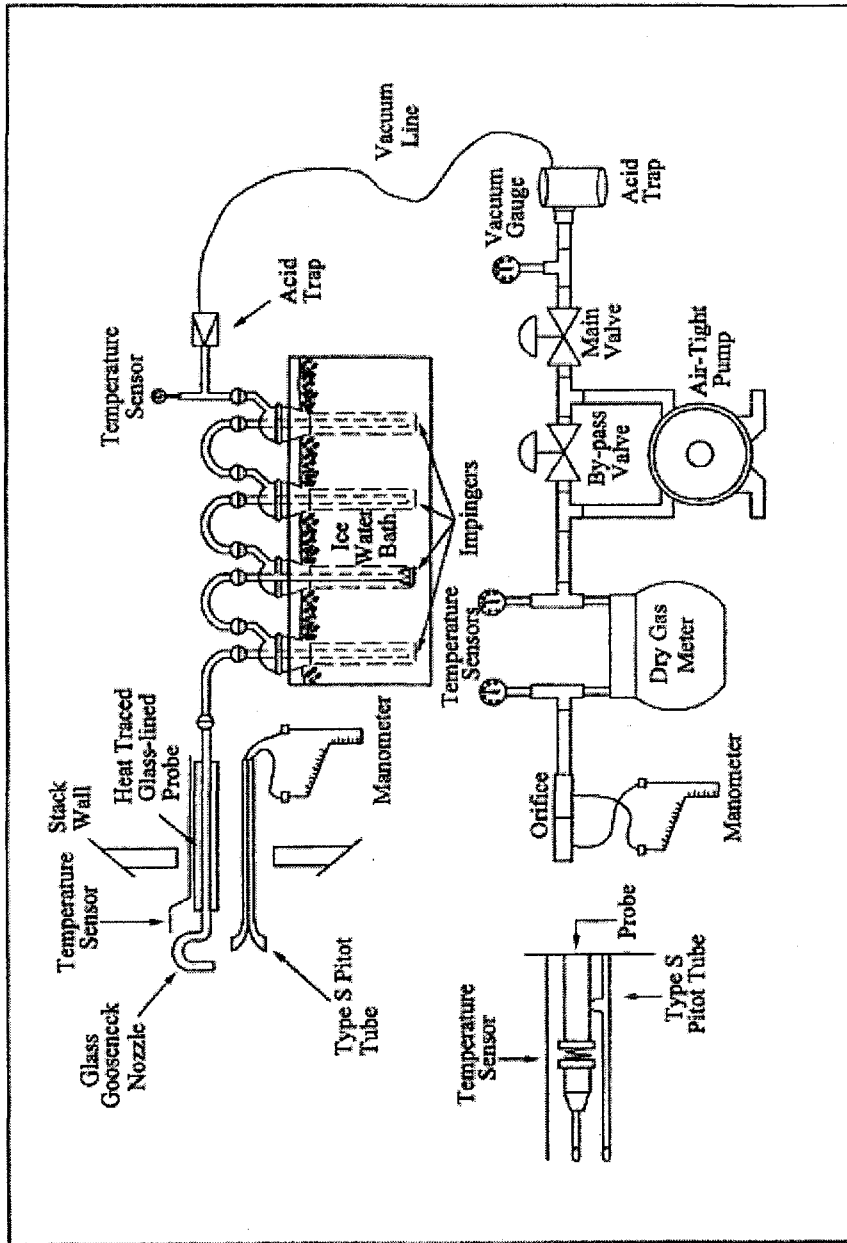

Figure 101-1. Mercury Sampling Train.

[View or download PDF](#)

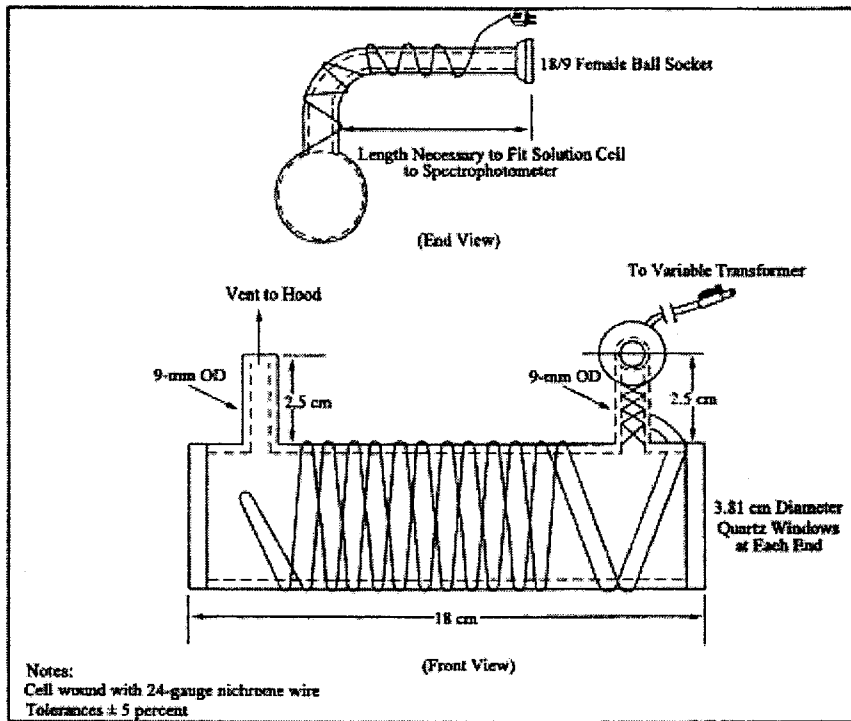

Figure 101-2. Optical Cell.

[View or download PDF](#)

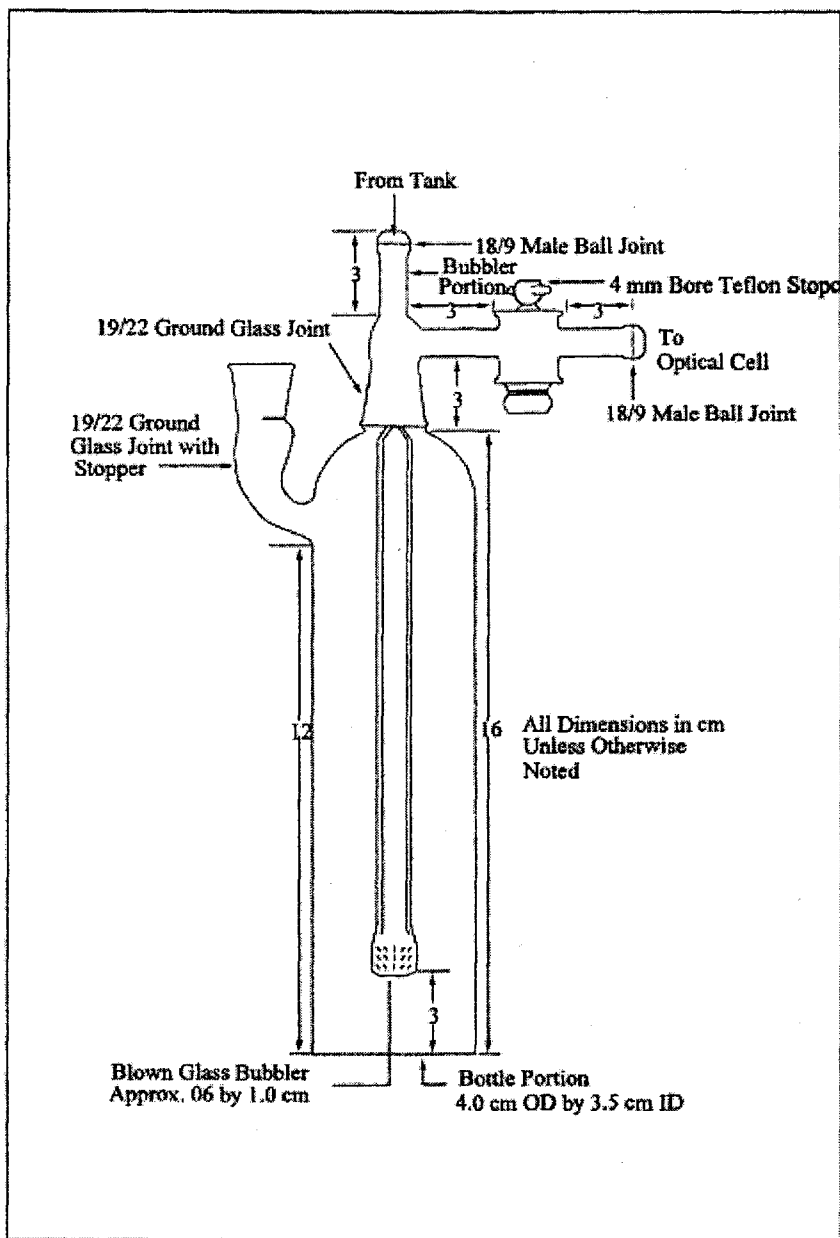

Figure 101-3. Aeration Cell.

[View or download PDF](#)

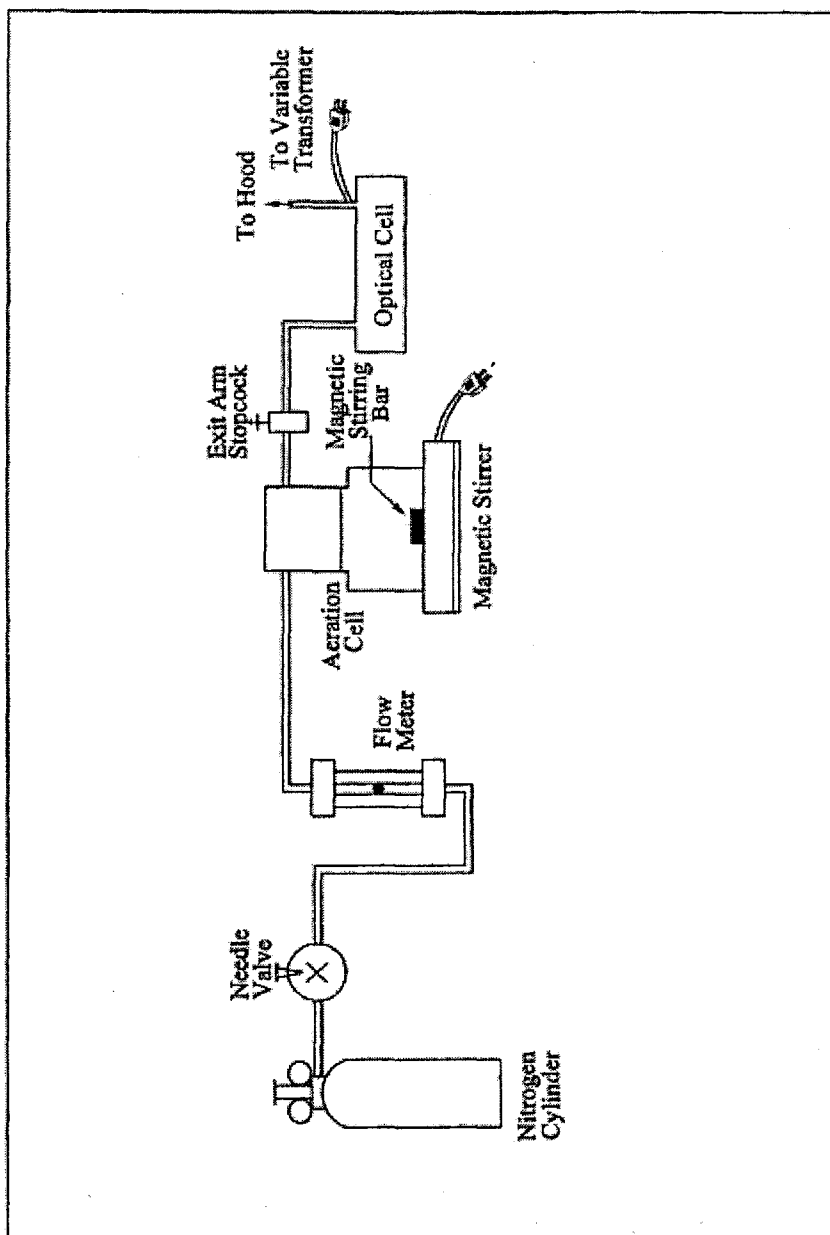

Figure 101-5. Schematic of Aeration System.

[View or download PDF](#)

Method 101A—Determination of Particulate and Gaseous Mercury Emissions From Sewage Sludge Incinerators

Note: This method does not include all of the specifications (e.g., equipment and supplies) and procedures (e.g., sampling and analytical) essential to its performance. Some material is incorporated by reference from methods in appendix A to 40 CFR part 60 and in this part. Therefore, to obtain reliable results, persons using this method should also have a thorough knowledge of at least the following additional test methods: Methods 1, Method 2, Method 3, and Method 5 of part 60 (appendix A), and Method 101 part 61 (appendix B).

1.0 Scope and Application

1.1 Analytes.

Analyte	CAS No.	Sensitivity
Mercury (Hg)	7439-97-6	Dependent upon spectrophotometer and recorder.

1.2 Applicability. This method is applicable for the determination of Hg emissions from sewage sludge incinerators and other sources as specified in an applicable subpart of the regulations.

1.3 Data Quality Objectives. Adherence to the requirements of this method will enhance the quality of the data obtained from air pollutant sampling methods.

2.0 Summary of Method

2.1 Particulate and gaseous Hg emissions are withdrawn isokinetically from the source and are collected in acidic potassium permanganate (KMnO₄) solution. The Hg collected (in the mercuric form) is reduced to elemental Hg, which is then aerated from the solution into an optical cell and measured by atomic absorption spectrophotometry.

3.0 Definitions.[Reserved]

4.0 Interferences

4.1 Sample Collection. Excessive oxidizable organic matter in the stack gas prematurely depletes the KMnO₄ solution and thereby prevents further collection of Hg.

4.2 Analysis. Condensation of water vapor on the optical cell windows causes a positive interference.

5.0 Safety

5.1 Disclaimer. This method may involve hazardous materials, operations, and equipment. This test method may not address all of the safety problems associated with its use. It is the responsibility of the user of this test method to establish appropriate safety and health practices and determine the applicability of regulatory limitations prior to performing this test method.

5.2 Corrosive Reagents. The following reagents are hazardous. Personal protective equipment and safe procedures are useful in preventing chemical splashes. If contact occurs, immediately flush with copious amounts of water for at least 15 minutes. Remove clothing under shower and decontaminate. Treat residual chemical burns as thermal burns.

5.2.1 Hydrochloric Acid (HCl). Highly toxic. Vapors are highly irritating to eyes, skin, nose, and lungs, causing severe damage. May cause bronchitis, pneumonia, or edema of lungs. Exposure to concentrations of 0.13 to 0.2 percent can be lethal to humans in a few minutes. Provide ventilation to limit exposure. Reacts with metals, producing hydrogen gas.

5.2.2 Nitric Acid (HNO₃). Highly corrosive to eyes, skin, nose, and lungs. Vapors cause bronchitis, pneumonia, or edema of lungs. Reaction to inhalation may be delayed as long as 30 hours and still be fatal. Provide ventilation to limit exposure. Strong oxidizer. Hazardous reaction may occur with organic materials such as solvents.

5.2.3 Sulfuric acid (H₂SO₄). Rapidly destructive to body tissue. Will cause third degree burns. Eye damage may result in blindness. Inhalation may be fatal from spasm of the larynx, usually within 30 minutes. May cause lung tissue damage with edema. 3 mg/m³ will cause lung damage in uninitiated. 1 mg/m³ for 8 hours will cause lung damage or, in higher concentrations, death. Provide ventilation to limit inhalation. Reacts violently with metals and organics.

5.3 Chlorine Evolution. Hydrochloric acid reacts with KMnO₄ to liberate chlorine gas. Although this is a minimal concern when small quantities of HCl (5-10 ml) are used in the impinger rinse, a potential safety hazard may still exist. At sources that emit higher concentrations of oxidizable materials (e.g., power

plants), more HCl may be required to remove the larger amounts of brown deposit formed in the impingers. In such cases, the potential safety hazards due to sample container pressurization are greater, because of the larger volume of HCl rinse added to the recovered sample. These hazards are eliminated by storing and analyzing the HCl impinger wash separately from the permanganate impinger sample.

6.0 *Equipment and Supplies*

6.1 Sample Collection and Sample Recovery. Same as Method 101, Sections 6.1 and 6.2, respectively, with the following exceptions:

6.1.1 Probe Liner. Same as in Method 101, Section 6.1.2, except that if a filter is used ahead of the impingers, the probe heating system must be used to minimize the condensation of gaseous Hg.

6.1.2 Filter Holder (Optional). Borosilicate glass with a rigid stainless-steel wire-screen filter support (do not use glass frit supports) and a silicone rubber or Teflon gasket, designed to provide a positive seal against leakage from outside or around the filter. The filter holder must be equipped with a filter heating system capable of maintaining a temperature around the filter holder of 120 ± 14 °C (248 ± 25 °F) during sampling to minimize both water and gaseous Hg condensation. A filter may also be used in cases where the stream contains large quantities of particulate matter.

6.2 Sample Analysis. Same as Method 101, Section 6.3, with the following additions and exceptions:

6.2.1 Volumetric Pipets. Class A; 1-, 2-, 3-, 4-, 5-, 10-, and 20-ml.

6.2.2 Graduated Cylinder. 25-ml.

6.2.3 Steam Bath.

6.2.4 Atomic Absorption Spectrophotometer or Equivalent. Any atomic absorption unit with an open sample presentation area in which to mount the optical cell is suitable. Instrument settings recommended by the particular manufacturer should be followed. Instruments designed specifically for the measurement of mercury using the cold-vapor technique are commercially available and may be substituted for the atomic absorption spectrophotometer.

6.2.5 Optical Cell. Alternatively, a heat lamp mounted above the cell or a moisture trap installed upstream of the cell may be used.

6.2.6 Aeration Cell. Alternatively, aeration cells available with commercial cold vapor instrumentation may be used.

6.2.7 Aeration Gas Cylinder. Nitrogen, argon, or dry, Hg-free air, equipped with a single-stage regulator. Alternatively, aeration may be provided by a peristaltic metering pump. If a commercial cold vapor instrument is used, follow the manufacturer's recommendations.

7.0 *Reagents and Standards*

Unless otherwise indicated, it is intended that all reagents conform to the specifications established by the Committee on Analytical Reagents of the American Chemical Society, where such specifications are available; otherwise, use the best available grade.

7.1 Sample Collection and Recovery. The following reagents are required for sample collection and recovery:

7.1.1 Water. Deionized distilled, to conform to ASTM D 1193-77 or 91 Type 1. If high concentrations of organic matter are not expected to be present, the analyst may eliminate the KMnO_4 test for oxidizable organic matter. Use this water in all dilutions and solution preparations.

7.1.2 Nitric Acid, 50 Percent (V/V). Mix equal volumes of concentrated HNO_3 and water, being careful to

add the acid to the water slowly.

7.1.3 Silica Gel. Indicating type, 6 to 16 mesh. If previously used, dry at 175 °C (350 °F) for 2 hours. New silica gel may be used as received.

7.1.4 Filter (Optional). Glass fiber filter, without organic binder, exhibiting at least 99.95 percent efficiency on 0.3- μ m dioctyl phthalate smoke particles. The filter in cases where the gas stream contains large quantities of particulate matter, but blank filters should be analyzed for Hg content.

7.1.5 Sulfuric Acid, 10 Percent (V/V). Carefully add and mix 100 ml of concentrated H₂SO₄ to 900 ml of water.

7.1.6 Absorbing Solution, 4 Percent KMnO₄(W/V). Prepare fresh daily. Dissolve 40 g of KMnO₄ in sufficient 10 percent H₂SO₄ to make 1 liter. Prepare and store in glass bottles to prevent degradation.

7.1.7 Hydrochloric Acid, 8 N. Carefully add and mix 67 ml of concentrated HCl to 33 ml of water.

7.2 Sample Analysis. The following reagents and standards are required for sample analysis:

7.2.1 Water. Same as in Section 7.1.1.

7.2.2 Tin (II) Solution. Prepare fresh daily, and keep sealed when not being used. Completely dissolve 20 g of tin (II) chloride (or 25 g of tin (II) sulfate) crystals (Baker Analyzed reagent grade or any other brand that will give a clear solution) in 25 ml of concentrated HCl. Dilute to 250 ml with water. Do not substitute HNO₃H₂SO₄, or other strong acids for the HCl.

7.2.3 Sodium Chloride-Hydroxylamine Solution. Dissolve 12 g of sodium chloride and 12 g of hydroxylamine sulfate (or 12 g of hydroxylamine hydrochloride) in water and dilute to 100 ml.

7.2.4 Hydrochloric Acid, 8 N. Same as Section 7.1.7.

7.2.5 Nitric Acid, 15 Percent (V/V). Carefully add 15 ml HNO₃ to 85 ml of water.

7.2.6 Antifoam B Silicon Emulsion. J.T. Baker Company (or equivalent).

7.2.7 Mercury Stock Solution, 1 mg Hg/ml. Prepare and store all Hg standard solutions in borosilicate glass containers. Completely dissolve 0.1354 g of Hg (II) chloride in 75 ml of water. Add 10 ml of concentrated HNO₃, and adjust the volume to exactly 100 ml with water. Mix thoroughly. This solution is stable for at least one month.

7.2.8 Intermediate Hg Standard Solution, 10 μ g/ml. Prepare fresh weekly. Pipet 5.0 ml of the Hg stock solution (Section 7.2.7) into a 500 ml volumetric flask, and add 20 ml of 15 percent HNO₃ solution. Adjust the volume to exactly 500 ml with water. Thoroughly mix the solution.

7.2.9 Working Hg Standard Solution, 200 ng Hg/ml. Prepare fresh daily. Pipet 5.0 ml from the "Intermediate Hg Standard Solution" (Section 7.2.8) into a 250-ml volumetric flask. Add 5 ml of 4 percent KMnO₄ absorbing solution and 5 ml of 15 percent HNO₃. Adjust the volume to exactly 250 ml with water. Mix thoroughly.

7.2.10 Potassium Permanganate, 5 Percent (W/V). Dissolve 5 g of KMnO₄ in water and dilute to 100 ml.

7.2.11 Filter. Whatman No. 40, or equivalent.

8.0 Sample Collection, Preservation, Transport, and Storage

Same as Method 101, Section 8.0, with the exception of the following:

8.1 Preliminary Determinations. Same as Method 101, Section 8.2, except that the liberation of free iodine in the first impinger due to high Hg or sulfur dioxide concentrations is not applicable. In this method, high oxidizable organic content may make it impossible to sample for the desired minimum time. This problem is indicated by the complete bleaching of the purple color of the KMnO_4 solution. In cases where an excess of water condensation is encountered, collect two runs to make one sample, or add an extra impinger in front of the first impinger (also containing acidified KMnO_4 solution).

8.2 Preparation of Sampling Train. Same as Method 101, Section 8.3, with the exception of the following:

8.2.1 In this method, clean all the glass components by rinsing with 50 percent HNO_3 , tap water, 8 N HCl, tap water, and finally with deionized distilled water. Then place 50 ml of absorbing solution in the first impinger and 100 ml in each of the second and third impingers.

8.2.2 If a filter is used, use a pair of tweezers to place the filter in the filter holder. Be sure to center the filter, and place the gasket in the proper position to prevent the sample gas stream from bypassing the filter. Check the filter for tears after assembly is completed. Be sure also to set the filter heating system at the desired operating temperature after the sampling train has been assembled.

8.3 Sampling Train Operation. In addition to the procedure outlined in Method 101, Section 8.5, maintain a temperature around the filter (if applicable) of 120 ± 14 °C (248 ± 25 °F).

8.4 Sample Recovery. Same as Method 101, Section 8.7, with the exception of the following:

8.4.1 Transfer the probe, impinger assembly, and (if applicable) filter assembly to the cleanup area.

8.4.2 Treat the sample as follows:

8.4.2.1 Container No. 1 (Impinger, Probe, and Filter Holder) and, if applicable, Container No. 1A (HCl rinse).

8.4.2.1.1 Using a graduated cylinder, measure the liquid in the first three impingers to within 1 ml. Record the volume of liquid present (e.g., see Figure 5–6 of Method 5). This information is needed to calculate the moisture content of the effluent gas. (Use only graduated cylinder and glass storage bottles that have been precleaned as in Section 8.2.1.) Place the contents of the first three impingers (four if an extra impinger was added as described in Section 8.1) into a 1000-ml glass sample bottle labeled Container No. 1.

Note: If a filter is used, remove the filter from its holder as outlined under Section 8.4.3.

8.4.2.1.2 Taking care that dust on the outside of the probe or other exterior surfaces does not get into the sample, quantitatively recover the Hg (and any condensate) from the probe nozzle, probe fitting, probe liner, front half of the filter holder (if applicable), and impingers as follows: Rinse these components with a total of 400 ml (350 ml if an extra impinger was added as described in Section 8.1) of fresh absorbing solution, carefully assuring removal of all loose particulate matter from the impingers; add all washings to the 1000 ml glass sample bottle. To remove any residual brown deposits on the glassware following the permanganate rinse, rinse with approximately 100 ml of water, carefully assuring removal of all loose particulate matter from the impingers. Add this rinse to Container No. 1.

8.4.2.1.3 If no visible deposits remain after this water rinse, do not rinse with 8 N HCl. If deposits do remain on the glassware after the water rinse, wash impinger walls and stems with 25 ml of 8 N HCl, and place the wash in a separate container labeled Container No. 1A as follows: Place 200 ml of water in a sample container labeled Container No. 1A. Wash the impinger walls and stem with the HCl by turning the impinger on its side and rotating it so that the HCl contacts all inside surfaces. Pour the HCl wash carefully with stirring into Container No. 1A.

8.4.2.1.4 After all washings have been collected in the appropriate sample container(s), tighten the lid(s) on the container(s) to prevent leakage during shipment to the laboratory. Mark the height of the fluid level to allow subsequent determination of whether leakage has occurred during transport. Label each container to identify its contents clearly.

8.4.3 Container No. 2 (Silica Gel). Same as Method 5, Section 8.7.6.3.

8.4.4 Container No. 3 (Filter). If a filter was used, carefully remove it from the filter holder, place it in a 100-ml glass sample bottle, and add 20 to 40 ml of absorbing solution. If it is necessary to fold the filter, be sure that the particulate cake is inside the fold. Carefully transfer to the 100-ml sample bottle any particulate matter and filter fibers that adhere to the filter holder gasket by using a dry Nylon bristle brush and a sharp-edged blade. Seal the container. Label the container to identify its contents clearly. Mark the height of the fluid level to allow subsequent determination of whether leakage has occurred during transport.

8.4.5 Container No. 4 (Filter Blank). If a filter was used, treat an unused filter from the same filter lot as that used for sampling according to the procedures outlined in Section 8.4.4.

8.4.6 Container No. 5 (Absorbing Solution Blank). Place 650 ml of 4 percent KMnO_4 absorbing solution in a 1000-ml sample bottle. Seal the container.

8.4.7 Container No. 6 (HCl Rinse Blank). Place 200 ml of water in a 1000-ml sample bottle, and add 25 ml of 8 N HCl carefully with stirring. Seal the container. Only one blank sample per 3 runs is required.

9.0 Quality Control

9.1 Miscellaneous Quality Control Measures.

Section	Quality control measure	Effect
8.0, 10.0	Sampling equipment leak-checks and calibration	Ensure accuracy and precision of sampling measurements.
10.2	Spectrophotometer calibration	Ensure linearity of spectrophotometer response to standards.
11.3.3	Check for matrix effects	Eliminate matrix effects.

9.2 Volume Metering System Checks. Same as Method 5, Section 9.2.

10.0 Calibration and Standardization

Same as Method 101, Section 10.0, with the following exceptions:

10.1 Optical Cell Heating System Calibration. Same as in Method 101, Section 10.4, except use a 25 ml graduated cylinder to add 25 ml of water to the bottle section of the aeration cell.

10.2 Spectrophotometer and Recorder Calibration.

10.2.1 The Hg response may be measured by either peak height or peak area.

Note: The temperature of the solution affects the rate at which elemental Hg is released from a solution and, consequently, it affects the shape of the absorption curve (area) and the point of maximum absorbance (peak height). To obtain reproducible results, all solutions must be brought to room temperature before use.

10.2.2 Set the spectrophotometer wave length at 253.7 nm, and make certain the optical cell is at the minimum temperature that will prevent water condensation. Then set the recorder scale as follows: Using a 25-ml graduated cylinder, add 25 ml of water to the aeration cell bottle. Add three drops of Antifoam B to the bottle, and then pipet 5.0 ml of the working Hg standard solution into the aeration cell.

Note: Always add the Hg-containing solution to the aeration cell after the 25 ml of water.

10.2.3 Place a Teflon-coated stirring bar in the bottle. Add 5 ml of absorbing solution to the aeration bottle, and mix well. Before attaching the bottle section to the bubbler section of the aeration cell, make certain that (1) the aeration cell exit arm stopcock (Figure 101-3 of Method 101) is closed (so that Hg will not prematurely enter the optical cell when the reducing agent is being added) and (2) there is no flow through the bubbler. If conditions (1) and (2) are met, attach the bottle section to the bubbler section of the aeration cell. Add sodium chloride-hydroxylamine in 1 ml increments until the solution is colorless. Now add 5 ml of tin (II) solution to the aeration bottle through the side arm, and immediately stopper the side arm. Stir the solution for 15 seconds, turn on the recorder, open the aeration cell exit arm stopcock, and immediately initiate aeration with continued stirring. Determine the maximum absorbance of the standard, and set this value to read 90 percent of the recorder full scale.

11.0 Analytical Procedure

11.1 Sample Loss Check. Check the liquid level in each container to see if liquid was lost during transport. If a noticeable amount of leakage occurred, either void the sample or use methods subject to the approval of the Administrator to account for the losses.

11.2 Sample Preparation. Treat sample containers as follows:

11.2.1 Containers No. 3 and No. 4 (Filter and Filter Blank).

11.2.1.1 If a filter is used, place the contents, including the filter, of Containers No. 3 and No. 4 in separate 250-ml beakers, and heat the beakers on a steam bath until most of the liquid has evaporated. Do not heat to dryness. Add 20 ml of concentrated HNO₃ to the beakers, cover them with a watch glass, and heat on a hot plate at 70 °C (160 °F) for 2 hours. Remove from the hot plate.

11.2.1.2 Filter the solution from digestion of the Container No. 3 contents through Whatman No. 40 filter paper, and save the filtrate for addition to the Container No. 1 filtrate as described in Section 11.2.2. Discard the filter paper.

11.2.1.3 Filter the solution from digestion of the Container No. 4 contents through Whatman No. 40 filter paper, and save the filtrate for addition to Container No. 5 filtrate as described in Section 11.2.3 below. Discard the filter paper.

11.2.2 Container No. 1 (Impingers, Probe, and Filter Holder) and, if applicable, No. 1A (HCl rinse).

11.2.2.1 Filter the contents of Container No. 1 through Whatman No. 40 filter paper into a 1 liter volumetric flask to remove the brown manganese dioxide (MnO₂) precipitate. Save the filter for digestion of the brown MnO₂ precipitate. Add the sample filtrate from Container No. 3 to the 1-liter volumetric flask, and dilute to volume with water. If the combined filtrates are greater than 1000 ml, determine the volume to the nearest ml and make the appropriate corrections for blank subtractions. Mix thoroughly. Mark the filtrate as analysis Sample No. A.1 and analyze for Hg within 48 hr of the filtration step. Place the saved filter, which was used to remove the brown MnO₂ precipitate, into an appropriate sized container. In a laboratory hood, add 25 ml of 8 N HCl to the filter and allow to digest for a minimum of 24 hours at room temperature.

11.2.2.2 Filter the contents of Container 1A through Whatman No. 40 filter paper into a 500-ml volumetric flask. Then filter the digestate of the brown MnO₂ precipitate from Container No. 1 through Whatman No. 40 filter paper into the same 500-ml volumetric flask, and dilute to volume with water. Mark this combined 500 ml dilute solution as analysis Sample No. A.2. Discard the filters.

11.2.3 Container No. 5 (Absorbing Solution Blank) and No. 6 (HCl Rinse Blank).

11.2.3.1 Treat Container No. 5 as Container No. 1 (as described in Section 11.2.2), except substitute the filter blank filtrate from Container No. 4 for the sample filtrate from Container No. 3, and mark as Sample A.1 Blank.

11.2.3.2 Treat Container No. 6 as Container No. 1A, (as described in Section 11.2.2, except substitute the filtrate from the digested blank MnO₂ precipitate for the filtrate from the digested sample

MnO₂ precipitate, and mark as Sample No. A.2 Blank.

Note: When analyzing samples A.1 Blank and HCl A.2 Blank, always begin with 10 ml aliquots. This applies specifically to blank samples.

11.3 Analysis. Calibrate the analytical equipment and develop a calibration curve as outlined in Section 10.0.

11.3.1 Mercury Samples. Then repeat the procedure used to establish the calibration curve with appropriately sized aliquots (1 to 10 ml) of the samples (from Sections 11.2.2 and 11.2.3) until two consecutive peak heights agree within 3 percent of their average value. If the 10 ml sample is below the detectable limit, use a larger aliquot (up to 20 ml), but decrease the volume of water added to the aeration cell accordingly to prevent the solution volume from exceeding the capacity of the aeration bottle. If the peak maximum of a 1.0 ml aliquot is off scale, further dilute the original sample to bring the Hg concentration into the calibration range of the spectrophotometer. If the Hg content of the absorbing solution and filter blank is below the working range of the analytical method, use zero for the blank.

11.3.2 Run a blank and standard at least after every five samples to check the spectrophotometer calibration; recalibrate as necessary.

11.3.3 Check for Matrix Effects (optional). Same as Method 101, Section 11.3.3.

12.0 Data Analysis and Calculations

Note: Carry out calculations, retaining at least one extra decimal significant figure beyond that of the acquired data. Round off figures only after the final calculation. Other forms of the equations may be used as long as they give equivalent results.

12.1 Nomenclature.

C(filtr)Hg= Total ng of Hg in aliquot of KMnO₄ filtrate and HNO₃ digestion of filter analyzed (aliquot of analysis Sample No. A.1).

C(filtr blk)Hg= Total ng of Hg in aliquot of KMnO₄ blank and HNO₃ digestion of blank filter analyzed (aliquot of analysis Sample No. A.1 blank).

C(HCl blk)Hg= Total ng of Hg analyzed in aliquot of the 500-ml analysis Sample No. HCl A.2 blank.

C(HCl)Hg= Total ng of Hg analyzed in the aliquot from the 500-ml analysis Sample No. HCl A.2.

DF = Dilution factor for the HCl-digested Hg-containing solution, Analysis Sample No. "HCl A.2."

DF_{blk} = Dilution factor for the HCl-digested Hg containing solution, Analysis Sample No. "HCl A.2 blank." (Refer to sample No. "HCl A.2" dilution factor above.)

m(filtr)Hg= Total blank corrected µg of Hg in KMnO₄ filtrate and HNO₃ digestion of filter sample.

m(HCl)Hg= Total blank corrected µg of Hg in HCl rinse and HCl digestate of filter sample.

m_{Hg} = Total blank corrected Hg content in each sample, µg.

S = Aliquot volume of sample added to aeration cell, ml.

S_{blk} = Aliquot volume of blank added to aeration cell, ml.

$V_f(\text{blk})$ = Solution volume of blank sample, 1000 ml for samples diluted as described in Section 11.2.2.

$V_f(\text{ftr})$ = Solution volume of original sample, normally 1000 ml for samples diluted as described in Section 11.2.2.

$V_f(\text{HCl})$ = Solution volume of original sample, 500 ml for samples diluted as described in Section 11.2.1.

10^{-3} = Conversion factor, $\mu\text{g}/\text{ng}$.

12.2 Average Dry Gas Meter Temperature and Average Orifice Pressure Drop, Dry Gas Volume, Volume of Water Vapor Condensed, Moisture Content, Isokinetic Variation, and Stack Gas Velocity and Volumetric Flow Rate. Same as Method 5, Sections 12.2 through 12.5, 12.11, and 12.12, respectively.

12.3 Total Mercury.

12.3.1 For each source sample, correct the average maximum absorbance of the two consecutive samples whose peak heights agree within 3 percent of their average for the contribution of the blank. Use the calibration curve and these corrected averages to determine the final total weight of Hg in ng in the aeration cell for each source sample.

12.3.2 Correct for any dilutions made to bring the sample into the working range of the spectrophotometer.

$$m_{(\text{HCl})\text{Hg}} = \frac{[C_{(\text{HCl})\text{Hg}} \text{DF}]}{S} - \frac{[C_{(\text{HCl})\text{blk}} \text{DF}_{\text{bk}}]}{S_{\text{bk}}} V_{f(\text{HCl})} (10^{-3}) \quad \text{Eq. 101A-1}$$

Note: This dilution factor applies only to the intermediate dilution steps, since the original sample volume [$(V_i)_{\text{HCl}}$] of "HCl A.2" has been factored out in the equation along with the sample aliquot (S). In Eq. 101A-1, the sample aliquot, S, is introduced directly into the aeration cell for analysis according to the procedure outlined in Section 11.3.1. A dilution factor is required only if it is necessary to bring the sample into the analytical instrument's calibration range.

Note: The maximum allowable blank subtraction for the HCl is the lesser of the two following values: (1) the actual blank measured value (analysis Sample No. HCl A.2 blank), or (2) 5% of the Hg content in the combined HCl rinse and digested sample (analysis Sample No. HCl A.2).

$$m_{(\text{ftr})\text{Hg}} = \frac{[C_{(\text{ftr})\text{Hg}} \text{DF} V_{f(\text{ftr})}]}{S} - \frac{[C_{(\text{ftr})\text{blk}} \text{DF}_{\text{bk}} V_{f(\text{blk})}]}{S_{\text{bk}}} \quad \text{Eq. 101A-2}$$

Note: The maximum allowable blank subtraction for the HCl is the lesser of the two following values: (1) the actual blank measured value (analysis Sample No. "A.1 blank"), or (2) 5% of the Hg content in the filtrate (analysis Sample No. "A.1").

$$m_{\text{Hg}} = m_{(\text{HCl})\text{Hg}} + m_{(\text{ftr})\text{Hg}} \quad \text{Eq. 101A-3}$$

12.3 Mercury Emission Rate. Same as Method 101, Section 12.3.

12.4 Determination of Compliance. Same as Method 101, Section 12.4.

13.0 Method Performance

13.1 Precision. Based on eight paired-train tests, the intra-laboratory standard deviation was estimated to be 4.8 µg/ml in the concentration range of 50 to 130 µg/m3.

13.2 Bias. [Reserved]

13.3 Range. After initial dilution, the range of this method is 20 to 800 ng Hg/ml. The upper limit can be extended by further dilution of the sample.

14.0 Pollution Prevention[Reserved]

15.0 Waste Management[Reserved]

16.0 References

Same as Section 16.0 of Method 101, with the addition of the following:

1. Mitchell, W.J., *et al.* Test Methods to Determine the Mercury Emissions from Sludge Incineration Plants. U.S. Environmental Protection Agency. Research Triangle Park, NC. Publication No. EPA-600/4-79-058. September 1979.
2. Wilshire, Frank W., *et al.* Reliability Study of the U.S. EPA's Method 101A—Determination of Particulate and Gaseous Mercury Emissions. U.S. Environmental Protection Agency. Research Triangle Park, NC. Report No. 600/D-31/219 AREAL 367, NTIS Acc No. PB91-233361.
3. Memorandum from William J. Mitchell to Roger T. Shigehara discussing the potential safety hazard in Section 7.2 of Method 101A. February 28, 1990.

17.0 Tables, Diagrams, Flowcharts, And Validation Data[Reserved]

Method 102—Determination of Particulate and Gaseous Mercury Emissions From Chlor-Alkali Plants (Hydrogen Streams)

Note: This method does not include all of the specifications (*e.g.*, equipment and supplies) and procedures (*e.g.*, sampling and analytical) essential to its performance. Some material is incorporated by reference from other methods in this part and in appendix A to 40 CFR part 60. Therefore, to obtain reliable results, persons using this method should have a thorough knowledge of at least the following additional test methods: Method 1, Method 2, Method 3, Method 5, and Method 101.

1.0 Scope and Application

1.1 Analytes.

Analyte	CAS No.	Sensitivity
Mercury (Hg)	7439-97-6	Dependent upon recorder and spectrophotometer.

1.2 Applicability. This method is applicable for the determination of Hg emissions, including both particulate and gaseous Hg, from chlor-alkali plants and other sources (as specified in the regulations) where the carrier-gas stream in the duct or stack is principally hydrogen.

1.3 Data Quality Objectives. Adherence to the requirements of this method will enhance the quality of the data obtained from air pollutant sampling methods.

2.0 Summary of Method

2.1 Particulate and gaseous Hg emissions are withdrawn isokinetically from the source and collected in

acidic iodine monochloride (ICI) solution. The Hg collected (in the mercuric form) is reduced to elemental Hg, which is then aerated from the solution into an optical cell and measured by atomic absorption spectrophotometry.

3.0 Definitions[Reserved]

4.0 Interferences

Same as Method 101, Section 4.2.

5.0 Safety

5.1 Disclaimer. This method may involve hazardous materials, operations, and equipment. This test method may not address all of the safety problems associated with its use. It is the responsibility of the user of this test method to establish appropriate safety and health practices and determine the applicability of regulatory limitations prior to performing this test method.

5.2 Corrosive Reagents. Same as Method 101, Section 5.2.

5.3 Explosive Mixtures. The sampler must conduct the source test under conditions of utmost safety because hydrogen and air mixtures are explosive. Since the sampling train essentially is leakless, attention to safe operation can be concentrated at the inlet and outlet. If a leak does occur, however, remove the meter box cover to avoid a possible explosive mixture. The following specific precautions are recommended:

5.3.1 Operate only the vacuum pump during the test. The other electrical equipment, e.g., heaters, fans, and timers, normally are not essential to the success of a hydrogen stream test.

5.3.2 Seal the sample port to minimize leakage of hydrogen from the stack.

5.3.3 Vent sampled hydrogen at least 3 m (10 ft) away from the train. This can be accomplished by attaching a 13-mm (0.50-in.) ID Tygon tube to the exhaust from the orifice meter.

Note: A smaller ID tubing may cause the orifice meter calibration to be erroneous. Take care to ensure that the exhaust line is not bent or pinched.

6.0 Equipment and Supplies

Same as Method 101, Section 6.0, with the exception of the following:

6.1 Probe Heating System. Do not use, unless otherwise specified.

6.2 Glass Fiber Filter. Do not use, unless otherwise specified.

7.0 Reagents and Standards

Same as Method 101, Section 7.0.

8.0 Sample Collection, Preservation, Transport, and Storage

Same as Method 101, Section 8.0, with the exception of the following:

8.1 Setting of Isokinetic Rates.

8.1.1 If a nomograph is used, take special care in the calculation of the molecular weight of the stack gas and in the setting of the nomograph to maintain isokinetic conditions during sampling (Sections 8.1.1.1 through 8.1.1.3 below).

8.1.1.1 Calibrate the meter box orifice. Use the techniques described in APTD-0576 (see Reference 9 in Section 17.0 of Method 5). Calibration of the orifice meter at flow conditions that simulate the conditions at the source is suggested. Calibration should either be done with hydrogen or with some other gas having similar Reynolds Number so that there is similarity between the Reynolds Numbers during calibration and during sampling.

8.1.1.2 The nomograph described in APTD-0576 cannot be used to calculate the C factor because the nomograph is designed for use when the stack gas dry molecular weight is 29 ± 4 . Instead, the following calculation should be made to determine the proper C factor:

$$C = 0.00154 \Delta H @ C_p^2 T_m \left(P_s / P_m \right) \frac{(1 - B_{ws})^2}{(1 - B_{ws}) + 18 B_{ws}} \quad \text{Eq. 102-1}$$

Where:

B_{ws} = Fraction by volume of water vapor in the stack gas.

C_p = Pitot tube calibration coefficient, dimensionless.

M_d = Dry molecular weight of stack gas, lb/lb-mole.

P_s = Absolute pressure of stack gas, in. Hg.

P_m = Absolute pressure of gas at the meter, in. Hg.

T_m = Absolute temperature of gas at the orifice, °R.

$\Delta H @$ = Meter box calibration factor obtained in Section 8.1.1.1, in. H₂O.

0.00154 = (in. H₂O/°R).

Note: This calculation is left in English units, and is not converted to metric units because nomographs are based on English units.

8.1.1.3 Set the calculated C factor on the operating nomograph, and select the proper nozzle diameter and K factor as specified in APTD-0576. If the C factor obtained in Section 8.1.1.2 exceeds the values specified on the existing operating nomograph, expand the C scale logarithmically so that the values can be properly located.

8.1.2 If a calculator is used to set isokinetic rates, it is suggested that the isokinetic equation presented in Reference 13 in Section 17.0 of Method 101 be consulted.

8.2 Sampling in Small (<12-in. Diameter) Stacks. When the stack diameter (or equivalent diameter) is less than 12 inches, conventional pitot tube-probe assemblies should not be used. For sampling guidelines, see Reference 14 in Section 17.0 of Method 101.

9.0 Quality Control

Same as Method 101, Section 9.0.

10.0 Calibration and Standardizations

Same as Method 101, Section 10.0.

11.0 Analytical Procedure

Same as Method 101, Section 11.0.

12.0 Data Analysis and Calculations

Same as Method 101, Section 12.0.

13.0 Method Performance

Same as Method 101, Section 13.0.

13.1 Analytical Range. After initial dilution, the range of this method is 0.5 to 120 µg Hg/ml. The upper limit can be extended by further dilution of the sample.

*14.0 Pollution Prevention.[Reserved]**15.0 Waste Management.[Reserved]**16.0 References*

Same as Method 101, Section 16.0.

17.0 Tables, Diagrams, Flowcharts, and Validation Data.[Reserved]

Method 103—Beryllium Screening Method

1.0 Scope and Application

1.1 Analytes.

Analyte	CAS No.	Sensitivity
Beryllium (Be)	7440-41-7	Dependent upon analytical procedure used.

1.2 Applicability. This procedure details guidelines and requirements for methods acceptable for use in determining Be emissions in ducts or stacks at stationary sources.

1.3 Data Quality Objectives. Adherence to the requirements of this method will enhance the quality of the data obtained from air pollutant sampling methods.

2.0 Summary of Method

2.1 Particulate Be emissions are withdrawn isokinetically from three points in a duct or stack and are collected on a filter. The collected sample is analyzed for Be using an appropriate technique.

*3.0 Definitions.[Reserved]**4.0 Interferences.[Reserved]**5.0 Safety*

5.1 Disclaimer. This method may involve hazardous materials, operations, and equipment. This test method may not address all of the safety problems associated with its use. It is the responsibility of the user of this test method to establish appropriate safety and health practices and determine the applicability of regulatory limitations prior to performing this test method.

5.2 Hydrochloric Acid (HCl). Highly corrosive and toxic. Vapors are highly irritating to eyes, skin, nose, and lungs, causing severe damage. May cause bronchitis, pneumonia, or edema of lungs. Exposure to concentrations of 0.13 to 0.2 percent can be lethal to humans in a few minutes. Provide ventilation to limit exposure. Reacts with metals, producing hydrogen gas. Personal protective equipment and safe procedures are useful in preventing chemical splashes. If contact occurs, immediately flush with copious amounts of water at least 15 minutes. Remove clothing under shower and decontaminate. Treat residual chemical burn as thermal burn.

6.0 Equipment and Supplies

6.1 Sample Collection. A schematic of the required sampling train configuration is shown in Figure 103-1 in Section 17.0. The essential components of the train are as follows:

6.1.1 Nozzle. Stainless steel, or equivalent, with sharp, tapered leading edge.

6.1.2 Probe. Sheathed borosilicate or quartz glass tubing.

6.1.3 Filter. Millipore AA, or equivalent, with appropriate filter holder that provides a positive seal against leakage from outside or around the filter. It is suggested that a Whatman 41, or equivalent, be placed immediately against the back side of the Millipore filter as a guard against breakage of the Millipore. Include the backup filter in the analysis. To be equivalent, other filters shall exhibit at least 99.95 percent efficiency (0.05 percent penetration) on 0.3 micron dioctyl phthalate smoke particles, and be amenable to the Be analysis procedure. The filter efficiency tests shall be conducted in accordance with ASTM D 2986-71, 78, 95a (incorporated by reference—see §61.18). Test data from the supplier's quality control program are sufficient for this purpose.

6.1.4 Meter-Pump System. Any system that will maintain isokinetic sampling rate, determine sample volume, and is capable of a sampling rate of greater than 14 lpm (0.5 cfm).

6.2 Measurement of Stack Conditions. The following equipment is used to measure stack conditions:

6.2.1 Pitot Tube. Type S, or equivalent, with a constant coefficient (± 5 percent) over the working range.

6.2.2 Inclined Manometer, or Equivalent. To measure velocity head to ± 10 percent of the minimum value.

6.2.3 Temperature Measuring Device. To measure stack temperature to ± 1.5 percent of the minimum absolute stack temperature.

6.2.4 Pressure Measuring Device. To measure stack pressure to ± 2.5 mm Hg (0.1 in. Hg).

6.2.5 Barometer. To measure atmospheric pressure to ± 2.5 mm Hg (0.1 in. Hg).

6.2.6 Wet and Dry Bulb Thermometers, Drying Tubes, Condensers, or Equivalent. To determine stack gas moisture content to ± 1 percent.

6.3 Sample Recovery.

6.3.1 Probe Cleaning Equipment. Probe brush or cleaning rod at least as long as probe, or equivalent. Clean cotton balls, or equivalent, should be used with the rod.

6.3.2 Leakless Glass Sample Bottles. To contain sample.

6.4 Analysis. All equipment necessary to perform an atomic absorption, spectrographic, fluorometric, chromatographic, or equivalent analysis.

7.0 Reagents and Standards

7.1 Sample Recovery.

7.1.1 Water. Deionized distilled, to conform to ASTM D 1193–77, 91 (incorporated by reference—see §61.18), Type 3.

7.1.2 Acetone. Reagent grade.

7.1.3 Wash Acid, 50 Percent (V/V) Hydrochloric Acid (HCl). Mix equal volumes of concentrated HCl and water, being careful to add the acid slowly to the water.

7.2 Analysis. Reagents and standards as necessary for the selected analytical procedure.

8.0 Sample Collection, Preservation, Transport, and Storage

Guidelines for source testing are detailed in the following sections. These guidelines are generally applicable; however, most sample sites differ to some degree and temporary alterations such as stack extensions or expansions often are required to insure the best possible sample site. Further, since Be is hazardous, care should be taken to minimize exposure. Finally, since the total quantity of Be to be collected is quite small, the test must be carefully conducted to prevent contamination or loss of sample.

8.1 Selection of a Sampling Site and Number of Sample Runs. Select a suitable sample site that is as close as practicable to the point of atmospheric emission. If possible, stacks smaller than one foot in diameter should not be sampled.

8.1.1 Ideal Sampling Site. The ideal sampling site is at least eight stack or duct diameters downstream and two diameters upstream from any flow disturbance such as a bend, expansion or contraction. For rectangular cross sections, use Equation 103–1 in Section 12.2 to determine an equivalent diameter, D_e .

8.1.2 Alternate Sampling Site. Some sampling situations may render the above sampling site criteria impractical. In such cases, select an alternate site no less than two diameters downstream and one-half diameter upstream from any point of flow disturbance. Additional sample runs are recommended at any sample site not meeting the criteria of Section 8.1.1.

8.1.3 Number of Sample Runs Per Test. Three sample runs constitute a test. Conduct each run at one of three different points. Select three points that proportionately divide the diameter, or are located at 25, 50, and 75 percent of the diameter from the inside wall. For horizontal ducts, sample on a vertical line through the centroid. For rectangular ducts, sample on a line through the centroid and parallel to a side. If additional sample runs are performed per Section 8.1.2, proportionately divide the duct to accommodate the total number of runs.

8.2 Measurement of Stack Conditions. Using the equipment described in Section 6.2, measure the stack gas pressure, moisture, and temperature to determine the molecular weight of the stack gas. Sound engineering estimates may be made in lieu of direct measurements. Describe the basis for such estimates in the test report.

8.3 Preparation of Sampling Train.

8.3.1 Assemble the sampling train as shown in Figure 103–1. It is recommended that all glassware be precleaned by soaking in wash acid for two hours.

8.3.2 Leak check the sampling train at the sampling site. The leakage rate should not be in excess of 1 percent of the desired sample rate.

8.4 Sampling Train Operation.

8.4.1 For each run, measure the velocity at the selected sampling point. Determine the isokinetic sampling rate. Record the velocity head and the required sampling rate. Place the nozzle at the sampling point with the tip pointing directly into the gas stream. Immediately start the pump and adjust the flow to isokinetic conditions. At the conclusion of the test, record the sampling rate. Again measure

the velocity head at the sampling point. The required isokinetic rate at the end of the period should not have deviated more than 20 percent from that originally calculated. Describe the reason for any deviation beyond 20 percent in the test report.

8.4.2 Sample at a minimum rate of 14 liters/min (0.5 cfm). Obtain samples over such a period or periods of time as are necessary to determine the maximum emissions which would occur in a 24-hour period. In the case of cyclic operations, perform sufficient sample runs so as to allow determination or calculation of the emissions that occur over the duration of the cycle. A minimum sampling time of two hours per run is recommended.

8.5 Sample Recovery.

8.5.1 It is recommended that all glassware be precleaned as in Section 8.3. Sample recovery should also be performed in an area free of possible Be contamination. When the sampling train is moved, exercise care to prevent breakage and contamination. Set aside a portion of the acetone used in the sample recovery as a blank for analysis. The total amount of acetone used should be measured for accurate blank correction. Blanks can be eliminated if prior analysis shows negligible amounts.

8.5.2 Remove the filter (and backup filter, if used) and any loose particulate matter from filter holder, and place in a container.

8.5.3 Clean the probe with acetone and a brush or long rod and cotton balls. Wash into the container with the filter. Wash out the filter holder with acetone, and add to the same container.

9.0 Quality Control.[Reserved]

10.0 Calibration and Standardization

10.1 Sampling Train. As a procedural check, compare the sampling rate regulation with a dry gas meter, spirometer, rotameter (calibrated for prevailing atmospheric conditions), or equivalent, attached to the nozzle inlet of the complete sampling train.

10.2 Analysis. Perform the analysis standardization as suggested by the manufacturer of the instrument, or the procedures for the analytical method in use.

11.0 Analytical Procedure

Make the necessary preparation of samples and analyze for Be. Any currently acceptable method (e.g., atomic absorption, spectrographic, fluorometric, chromatographic) may be used.

12.0 Data Analysis and Calculations

12.1 Nomenclature.

$A_s(\text{avg})$ = Stack area, m^2 (ft^2).

L = Length.

R = Be emission rate, g/day.

$V_s(\text{avg})$ = Average stack gas velocity, m/sec (ft/sec).

V_{total} = Total volume of gas sampled, m^3 (ft^3).

W = Width.

W_t = Total weight of Be collected, mg.

10^{-6} = Conversion factor, g/ μ g.

86,400 = Conversion factor, sec/day.

12.2 Calculate the equivalent diameter, D_e , for a rectangular cross section as follows:

$$D_e = \frac{2 \cdot L \cdot W}{L + W} \quad \text{Eq. 103-1}$$

12.3 Calculate the Be emission rate, R , in g/day for each stack using Equation 103–2. For cyclic operations, use only the time per day each stack is in operation. The total Be emission rate from a source is the summation of results from all stacks.

$$R = \frac{W_t V_{s(\text{mg})} A_s (86,400) (10^{-6})}{V_{\text{total}}} \quad \text{Eq. 103-2}$$

12.4 Test Report. Prepare a test report that includes as a minimum: A detailed description of the sampling train used, results of the procedural check described in Section 10.1 with all data and calculations made, all pertinent data taken during the test, the basis for any estimates made, isokinetic sampling calculations, and emission results. Include a description of the test site, with a block diagram and brief description of the process, location of the sample points in the stack cross section, and stack dimensions and distances from any point of disturbance.

13.0 Method Performance.[Reserved]

14.0 Pollution Prevention.[Reserved]

15.0 Waste Management.[Reserved]

16.0 References.[Reserved]

17.0 Tables, Diagrams, Flow Charts, and Validation Data

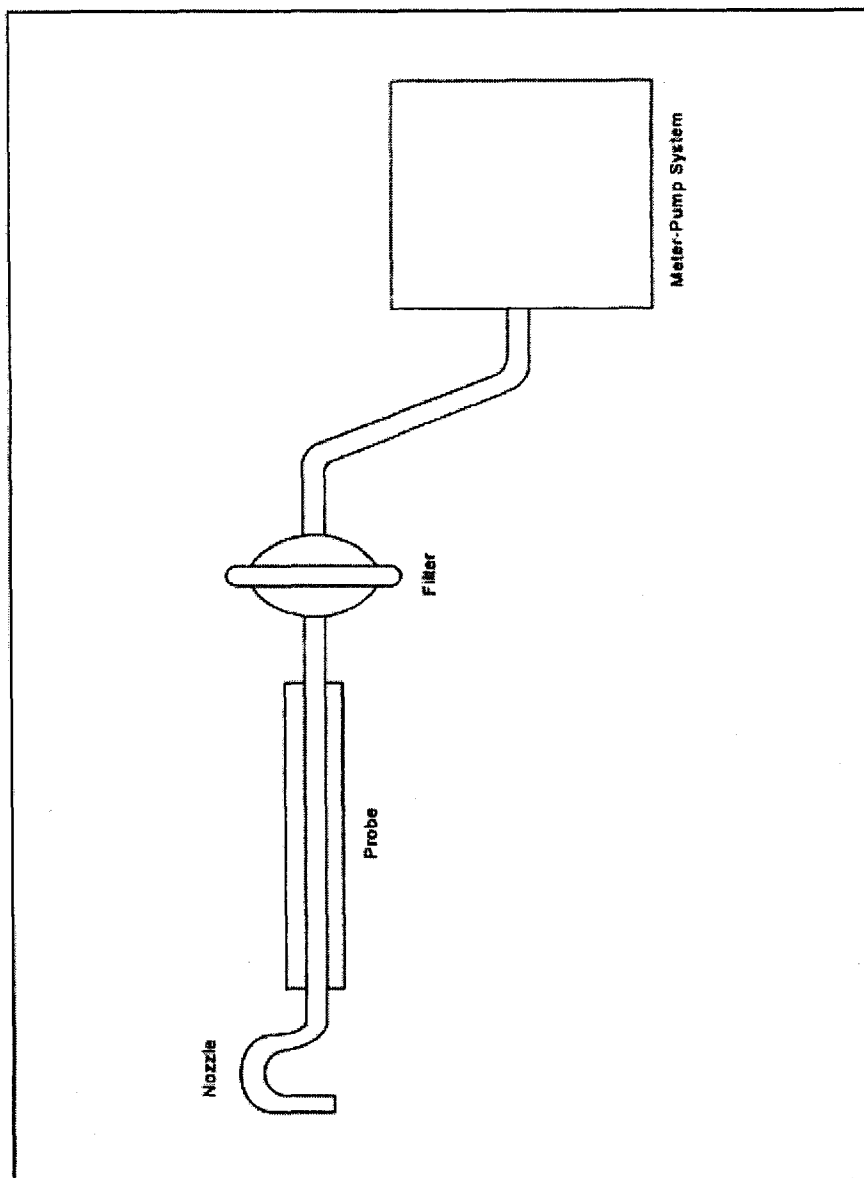

Figure 103-1. Beryllium Screening Method Sampling Train Schematic.

[View or download PDF](#)

Method 104—Determination of Beryllium Emissions From Stationary Sources

Note: This method does not include all of the specifications (e.g., equipment and supplies) and procedures (e.g., sampling and analytical) essential to its performance. Some material is incorporated by reference from methods in appendix A to 40 CFR part 60. Therefore, to obtain reliable results, persons using this method should have a thorough knowledge of at least the following additional test methods: Method 1, Method 2, Method 3, and Method 5 in appendix A, part 60.

1.0 Scope and Application

1.1 Analytes.

Analyte	CAS No.	Sensitivity
Beryllium (Be)	7440-41-7	Dependent upon recorder and spectrophotometer.

1.2 Applicability. This method is applicable for the determination of Be emissions in ducts or stacks at stationary sources. Unless otherwise specified, this method is not intended to apply to gas streams other than those emitted directly to the atmosphere without further processing.

1.3 Data Quality Objectives. Adherences to the requirements of this method will enhance the quality of the data obtained from air pollutant sampling methods.

2.0 Summary of Method

2.1 Particulate and gaseous Be emissions are withdrawn isokinetically from the source and are collected on a glass fiber filter and in water. The collected sample is digested in an acid solution and is analyzed by atomic absorption spectrophotometry.

3.0 Definitions[Reserved]

4.0 Interferences

4.1 Matrix Effects. Analysis for Be by flame atomic absorption spectrophotometry is sensitive to the chemical composition and to the physical properties (e.g., viscosity, pH) of the sample. Aluminum and silicon in particular are known to interfere when present in appreciable quantities. The analytical procedure includes (optionally) the use of the Method of Standard Additions to check for these matrix effects, and sample analysis using the Method of Standard Additions if significant matrix effects are found to be present (see Reference 2 in Section 16.0).

5.0 Safety

5.1 Disclaimer. This method may involve hazardous materials, operations, and equipment. This test method may not address all of the safety problems associated with its use. It is the responsibility of the user of this test method to establish appropriate safety and health practices and determine the applicability of regulatory limitations prior to performing this test method.

5.2 Corrosive reagents. The following reagents are hazardous. Personal protective equipment and safe procedures are useful in preventing chemical splashes. If contact occurs, immediately flush with copious amounts of water at least 15 minutes. Remove clothing under shower and decontaminate. Treat residual chemical burn as thermal burn.

5.2.1 Hydrochloric Acid (HCl). Highly toxic. Vapors are highly irritating to eyes, skin, nose, and lungs, causing severe damage. May cause bronchitis, pneumonia, or edema of lungs. Exposure to concentrations of 0.13 to 0.2 percent can be lethal to humans in a few minutes. Provide ventilation to limit exposure. Reacts with metals, producing hydrogen gas.

5.2.2 Hydrogen Peroxide (H₂O₂). Irritating to eyes, skin, nose, and lungs.

5.2.3 Nitric Acid (HNO₃). Highly corrosive to eyes, skin, nose, and lungs. Vapors cause bronchitis, pneumonia, or edema of lungs. Reaction to inhalation may be delayed as long as 30 hours and still be fatal. Provide ventilation to limit exposure. Strong oxidizer. Hazardous reaction may occur with organic materials such as solvents.

5.2.4 Sodium Hydroxide (NaOH). Causes severe damage to eyes and skin. Inhalation causes irritation to nose, throat, and lungs. Reacts exothermically with limited amounts of water.

5.3 Beryllium is hazardous, and precautions should be taken to minimize exposure.

6.0 Equipment and Supplies

6.1 Sample Collection. Same as Method 5, Section 6.1, with the exception of the following:

6.1.1 Sampling Train. Same as Method 5, Section 6.1.1, with the exception of the following:

6.1.2 Probe Liner. Borosilicate or quartz glass tubing. A heating system capable of maintaining a gas temperature of 120 ± 14 °C (248 ± 25 °F) at the probe exit during sampling to prevent water condensation may be used.

Note: Do not use metal probe liners.

6.1.3 Filter Holder. Borosilicate glass, with a glass frit filter support and a silicone rubber gasket. Other materials of construction (e.g., stainless steel, Teflon, Viton) may be used, subject to the approval of the Administrator. The holder design shall provide a positive seal against leakage from the outside or around the filter. The holder shall be attached immediately at the outlet of the probe. A heating system capable of maintaining the filter at a minimum temperature in the range of the stack temperature may be used to prevent condensation from occurring.

6.1.4 Impingers. Four Greenburg-Smith impingers connected in series with leak-free ground glass fittings or any similar leak-free noncontaminating fittings. For the first, third, and fourth impingers, use impingers that are modified by replacing the tip with a 13 mm-ID (0.5 in.) glass tube extending to 13 mm (0.5 in.) from the bottom of the flask may be used.

6.2 Sample Recovery. The following items are needed for sample recovery:

6.2.1 Probe Cleaning Rod. At least as long as probe.

6.2.2 Glass Sample Bottles. Leakless, with Teflon-lined caps, 1000 ml.

6.2.3 Petri Dishes. For filter samples, glass or polyethylene, unless otherwise specified by the Administrator.

6.2.4 Graduated Cylinder. 250 ml.

6.2.5 Funnel and Rubber Policeman. To aid in transfer of silica gel to container; not necessary if silica gel is weighed in the field.

6.2.6 Funnel. Glass, to aid in sample recovery.

6.2.7 Plastic Jar. Approximately 300 ml.

6.3 Analysis. The following items are needed for sample analysis:

6.3.1 Atomic Absorption Spectrophotometer. Perkin-Elmer 303, or equivalent, with nitrous oxide/acetylene burner.

6.3.2 Hot Plate.

6.3.3 Perchloric Acid Fume Hood.

7.0 Reagents and Standards

Note: Unless otherwise indicated, it is intended that all reagents conform to the specifications established by the Committee on Analytical Reagents of the American Chemical Society, where such specifications are available; otherwise, use the best available grade.

7.1 Sample Collection. Same as Method 5, Section 7.1, including deionized distilled water conforming to ASTM D 1193-77 or 91 (incorporated by reference—see §61.18), Type 3. The Millipore AA filter is recommended.

7.2 Sample Recovery. Same as Method 5 in appendix A, part 60, Section 7.2, with the addition of the following:

7.2.1 Wash Acid, 50 Percent (V/V) Hydrochloric Acid (HCl). Mix equal volumes of concentrated HCl and water, being careful to add the acid slowly to the water.

7.3 Sample Preparation and Analysis. The following reagents and standards and standards are needed for sample preparation and analysis:

7.3.1 Water. Same as in Section 7.1.

7.3.2. Perchloric Acid (HClO₄). Concentrated (70 percent V/V).

7.3.3 Nitric Acid (HNO₃). Concentrated.

7.3.4 Beryllium Powder. Minimum purity 98 percent.

7.3.5 Sulfuric Acid (H₂SO₄) Solution, 12 N. Dilute 33 ml of concentrated H₂SO₄ to 1 liter with water.

7.3.6 Hydrochloric Acid Solution, 25 Percent HCl (V/V).

7.3.7 Stock Beryllium Standard Solution, 10 µg Be/ml. Dissolve 10.0 mg of Be in 80 ml of 12 N H₂SO₄ in a 1000-ml volumetric flask. Dilute to volume with water. This solution is stable for at least one month. Equivalent strength Be stock solutions may be prepared from Be salts such as BeCl₂ and Be(NO₃)₂ (98 percent minimum purity).

7.3.8 Working Beryllium Standard Solution, 1 µg Be/ml. Dilute a 10 ml aliquot of the stock beryllium standard solution to 100 ml with 25 percent HCl solution to give a concentration of 1 mg/ml. Prepare this dilute stock solution fresh daily.

8.0 Sample Collection, Preservation, Transport, and Storage

The amount of Be that is collected is generally small, therefore, it is necessary to exercise particular care to prevent contamination or loss of sample.

8.1 Pretest Preparation. Same as Method 5, Section 8.1, except omit Section 8.1.3.

8.2 Preliminary Determinations. Same as Method 5, Section 8.2, with the exception of the following:

8.2.1 Select a nozzle size based on the range of velocity heads to assure that it is not necessary to change the nozzle size in order to maintain isokinetic sampling rates below 28 liters/min (1.0 cfm).

8.2.2 Obtain samples over a period or periods of time that accurately determine the maximum emissions that occur in a 24-hour period. In the case of cyclic operations, perform sufficient sample runs for the accurate determination of the emissions that occur over the duration of the cycle. A minimum sample time of 2 hours per run is recommended.

8.3 Preparation of Sampling Train. Same as Method 5, Section 8.3, with the exception of the following:

8.3.1 Prior to assembly, clean all glassware (probe, impingers, and connectors) by first soaking in wash acid for 2 hours, followed by rinsing with water.

8.3.2 Save a portion of the water for a blank analysis.

8.3.3 Procedures relating to the use of metal probe liners are not applicable.

8.3.4 Probe and filter heating systems are needed only if water condensation is a problem. If this is the case, adjust the heaters to provide a temperature at or above the stack temperature. However, membrane filters such as the Millipore AA are limited to about 107 °C (225 °F). If the stack gas is in excess of about 93 °C (200 °F), consideration should be given to an alternate procedure such as moving the filter holder downstream of the first impinger to insure that the filter does not exceed its temperature limit. After the sampling train has been assembled, turn on and set the probe heating system, if applicable, at the desired operating temperature. Allow time for the temperatures to stabilize. Place crushed ice around the impingers.

Note: An empty impinger may be inserted between the third impinger and the silica gel to remove excess moisture from the sample stream.

8.4 Leak Check Procedures, Sampling Train Operation, and Calculation of Percent Isokinetic. Same as Method 5, Sections 8.4, 8.5, and 8.6, respectively.

8.5 Sample Recovery. Same as Method 5, Section 8.7, except treat the sample as follows: Transfer the probe and impinger assembly to a cleanup area that is clean, protected from the wind, and free of Be contamination. Inspect the train before and during this assembly, and note any abnormal conditions. Treat the sample as follows: Disconnect the probe from the impinger train.

8.5.1 Container No. 1. Same as Method 5, Section 8.7.6.1.

8.5.2 Container No. 2. Place the contents (measured to 1 ml) of the first three impingers into a glass sample bottle. Use the procedures outlined in Section 8.7.6.2 of Method 5, where applicable, to rinse the probe nozzle, probe fitting, probe liner, filter holder, and all glassware between the filter holder and the back half of the third impinger with water. Repeat this procedure with acetone. Place both water and acetone rinse solutions in the sample bottle with the contents of the impingers.

8.5.3 Container No. 3. Same as Method 5, Section 8.7.6.3.

8.6 Blanks.

8.6.1 Water Blank. Save a portion of the water as a blank. Take 200 ml directly from the wash bottle being used and place it in a plastic sample container labeled "H₂O blank."

8.6.2 Filter. Save two filters from each lot of filters used in sampling. Place these filters in a container labeled "filter blank."

8.7 Post-test Glassware Rinsing. If an additional test is desired, the glassware can be carefully double rinsed with water and reassembled. However, if the glassware is out of use more than 2 days, repeat the initial acid wash procedure.

9.0 Quality Control

9.1 Miscellaneous Quality Control Measures.

Section	Quality control measure	Effect
8.4, 10.1	Sampling equipment leak checks and calibration	Ensure accuracy and precision of sampling measurements.
10.2	Spectrophotometer calibration	Ensure linearity of spectrophotometer response to standards.
11.5	Check for matrix effects	Eliminate matrix effects.
11.6	Audit sample analysis	Evaluate analyst's technique and standards preparation.

9.2 Volume Metering System Checks. Same as Method 5, Section 9.2.

10.0 Calibration and Standardization

Note: Maintain a laboratory log of all calibrations.

10.1 Sampling Equipment. Same as Method 5, Section 10.0.

10.2 Preparation of Standard Solutions. Pipet 1, 3, 5, 8, and 10 ml of the 1.0 µg Be/ml working standard solution into separate 100 ml volumetric flasks, and dilute to the mark with water. The total amounts of Be in these standards are 1, 3, 5, 8, and 10 µg, respectively.

10.3 Spectrophotometer and Recorder. The Be response may be measured by either peak height or peak area. Analyze an aliquot of the 10-µg standard at 234.8 nm using a nitrous oxide/acetylene flame. Determine the maximum absorbance of the standard, and set this value to read 90 percent of the recorder full scale.

10.4 Calibration Curve.

10.4.1 After setting the recorder scale, analyze an appropriately sized aliquot of each standard and the BLANK (see Section 11) until two consecutive peaks agree within 3 percent of their average value.

10.4.3 Subtract the average peak height (or peak area) of the blank—which must be less than 2 percent of recorder full scale—from the averaged peak heights of the standards. If the blank absorbance is greater than 2 percent of full-scale, the probable cause is Be contamination of a reagent or carry-over of Be from a previous sample. Prepare the calibration curve by plotting the corrected peak height of each standard solution versus the corresponding total Be weight in the standard (in µg).

10.5 Spectrophotometer Calibration Quality Control. Calculate the least squares slope of the calibration curve. The line must pass through the origin or through a point no further from the origin than ±2 percent of the recorder full scale. Multiply the corrected peak height by the reciprocal of the least squares slope to determine the distance each calibration point lies from the theoretical calibration line. The difference between the calculated concentration values and the actual concentrations (i.e., 1, 3, 5, 8, and 10 µg Be) must be less than 7 percent for all standards.

11.0 Analytical Procedure

11.1 Sample Loss Check. Prior to analysis, check the liquid level in Container No. 2. Note on the analytical data sheet whether leakage occurred during transport. If a noticeable amount of leakage occurred, either void the sample or take steps, subject to the approval of the Administrator, to adjust the final results.

11.2 Glassware Cleaning. Before use, clean all glassware according to the procedure of Section 8.3.1.

11.3 Sample Preparation. The digestion of Be samples is accomplished in part in concentrated HClO₄.

Note: The sample must be heated to light brown fumes after the initial HNO₃ addition; otherwise, dangerous perchlorates may result from the subsequent HClO₄ digestion. HClO₄ should be used only under a hood.

11.3.1 Container No. 1. Transfer the filter and any loose particulate matter from Container No. 1 to a 150-ml beaker. Add 35 ml concentrated HNO₃. To oxidize all organic matter, heat on a hotplate until light brown fumes are evident. Cool to room temperature, and add 5 ml 12 N H₂SO₄ and 5 ml concentrated HClO₄.

11.3.2 Container No. 2. Place a portion of the water and acetone sample into a 150 ml beaker, and put on a hotplate. Add portions of the remainder as evaporation proceeds and evaporate to dryness. Cool

the residue, and add 35 ml concentrated HNO_3 . To oxidize all organic matter, heat on a hotplate until light brown fumes are evident. Cool to room temperature, and add 5 ml 12 N H_2SO_4 and 5 ml concentrated HClO_4 . Then proceed with step 11.3.4.

11.3.3 Final Sample Preparation. Add the sample from Section 11.3.2 to the 150-ml beaker from Section 11.3.1. Replace on a hotplate, and evaporate to dryness in a HClO_4 hood. Cool the residue to room temperature, add 10.0 ml of 25 percent V/V HCl, and mix to dissolve the residue.

11.3.4 Filter and Water Blanks. Cut each filter into strips, and treat each filter individually as directed in Section 11.3.1. Treat the 200-ml water blank as directed in Section 11.3.2. Combine and treat these blanks as directed in Section 11.3.3.

11.4 Spectrophotometer Preparation. Turn on the power; set the wavelength, slit width, and lamp current; and adjust the background corrector as instructed by the manufacturer's manual for the particular atomic absorption spectrophotometer. Adjust the burner and flame characteristics as necessary.

11.5 Analysis. Calibrate the analytical equipment and develop a calibration curve as outlined in Sections 10.4 and 10.5.

11.5.1 Beryllium Samples. Repeat the procedure used to establish the calibration curve with an appropriately sized aliquot of each sample (from Section 11.3.3) until two consecutive peak heights agree within 3 percent of their average value. The peak height of each sample must be greater than 10 percent of the recorder full scale. If the peak height of the sample is off scale on the recorder, further dilute the original source sample to bring the Be concentration into the calibration range of the spectrophotometer.

11.5.2 Run a blank and standard at least after every five samples to check the spectrophotometer calibration. The peak height of the blank must pass through a point no further from the origin than ± 2 percent of the recorder full scale. The difference between the measured concentration of the standard (the product of the corrected peak height and the reciprocal of the least squares slope) and the actual concentration of the standard must be less than 7 percent, or recalibration of the analyzer is required.

11.5.3 Check for Matrix Effects (optional). Use the Method of Standard Additions (see Reference 2 in Section 16.0) to check at least one sample from each source for matrix effects on the Be results. If the results of the Method of Standard Additions procedure used on the single source sample do not agree to within 5 percent of the value obtained by the routine atomic absorption analysis, then reanalyze all samples from the source using the Method of Standard Additions procedure.

11.6 Container No. 2 (Silica Gel). Weigh the spent silica gel (or silica gel plus impinger) to the nearest 0.5 g using a balance. (This step may be conducted in the field.)

12.0 Data Analysis and Calculations

Carry out calculations, retaining at least one extra decimal significant figure beyond that of the acquired data. Round off figures only after the final calculation. Other forms of the equations may be used as long as they give equivalent results.

12.1 Nomenclature.

$K_1 = 0.3858 \text{ } ^\circ\text{K/mm Hg}$ for metric units.

= 17.64 $^\circ\text{R/in. Hg}$ for English units.

$K_3 = 10^{-6} \text{ g}/\mu\text{g}$ for metric units.

= 2.2046 $\times 10^{-9} \text{ lb}/\mu\text{g}$ for English units.

m_{Be} = Total weight of beryllium in the source sample.

P_s = Absolute stack gas pressure, mm Hg (in. Hg).

t = Daily operating time, sec/day.

T_s = Absolute average stack gas temperature, °K (°R).

$V_m(\text{std})$ = Dry gas sample volume at standard conditions, scm (scf).

$V_w(\text{std})$ = Volume of water vapor at standard conditions, scm (scf).

12.2 Average Dry Gas Meter Temperature and Average Orifice Pressure Drop, Dry Gas Volume, Volume of Water Vapor Condensed, Moisture Content, Isokinetic Variation, and Stack Gas Velocity and Volumetric Flow Rate. Same as Method 5, Sections 12.2 through 12.5, 12.11, and 12.12, respectively.

12.3 Total Beryllium. For each source sample, correct the average maximum absorbance of the two consecutive samples whose peak heights agree within 3 percent of their average for the contribution of the solution blank (see Sections 11.3.4 and 11.5.2). Correcting for any dilutions if necessary, use the calibration curve and these corrected averages to determine the total weight of Be in each source sample.

12.4 Beryllium Emission Rate. Calculate the daily Hg emission rate, R , using Equation 104–1. For continuous operations, the operating time is equal to 86,400 seconds per day. For cyclic operations, use only the time per day each stack is in operation. The total Hg emission rate from a source will be the summation of results from all stacks.

$$R = \frac{K_1 K_3 t m_{Be} P_s V_s A_s}{T_s (V_{m(\text{std})} + V_{w(\text{std})})} \quad \text{Eq. 104-1}$$

12.5 Determination of Compliance. Each performance test consists of three sample runs. For the purpose of determining compliance with an applicable national emission standard, use the average of the results of all sample runs.

13.0 *Method Performance.*[Reserved]

14.0 *Pollution Prevention.*[Reserved]

15.0 *Waste Management.*[Reserved]

16.0 *References*

Same as References 1, 2, and 4–11 of Section 16.0 of Method 101 with the addition of the following:

1. Amos, M.D., and J.B. Willis. Use of High-Temperature Pre-Mixed Flames in Atomic Absorption Spectroscopy. *Spectrochim. Acta.* 22:1325. 1966.

2. Fleet, B., K.V. Liberty, and T. S. West. A Study of Some Matrix Effects in the Determination of Beryllium by Atomic Absorption Spectroscopy in the Nitrous Oxide-Acetylene Flame. *Talanta* 17:203. 1970.

17.0 *Tables, Diagrams, Flowcharts, And Validation Data*[Reserved]

Method 105—Determination of Mercury in Wastewater Treatment Plant Sewage Sludges

Note: This method does not include all of the specifications (e.g., equipment and supplies) and procedures (e.g., sampling and analytical) essential to its performance. Some material is incorporated by reference from other methods in this part. Therefore, to obtain reliable results, persons using this method should also have a thorough knowledge of at least the following additional test methods: Method 101 and Method 101A.

1.0 Scope and Application

1.1 Analytes.

Analyte	CAS No.	Sensitivity
Mercury (Hg)	7439-97-6	Dependent upon spectrophotometer and recorder.

1.2 Applicability. This method is applicable for the determination of total organic and inorganic Hg content in sewage sludges.

1.3 Data Quality Objectives. Adherence to the requirements of this method will enhance the quality of the data obtained from air pollutant sampling methods.

2.0 Summary of Method

2.1 Time-composite sludge samples are withdrawn from the conveyor belt subsequent to dewatering and before incineration or drying. A weighed portion of the sludge is digested in aqua regia and is oxidized by potassium permanganate (KMnO₄). Mercury in the digested sample is then measured by the conventional spectrophotometric cold-vapor technique.

3.0 Definitions[Reserved]

4.0 Interferences[Reserved]

5.0 Safety

5.1 Disclaimer. This method may involve hazardous materials, operations, and equipment. This test method may not address all of the safety problems associated with its use. It is the responsibility of the user of this test method to establish appropriate safety and health practices and determine the applicability of regulatory limitations prior to performing this test method.

5.2 Corrosive Reagents. The following reagents are hazardous. Personal protective equipment and safe procedures are useful in preventing chemical splashes. If contact occurs, immediately flush with copious amounts of water at least 15 minutes. Remove clothing under shower and decontaminate. Treat residual chemical burn as thermal burn.

5.2.1 Hydrochloric Acid (HCl). Highly toxic. Vapors are highly irritating to eyes, skin, nose, and lungs, causing severe damage. May cause bronchitis, pneumonia, or edema of lungs. Exposure to concentrations of 0.13 to 0.2 percent can be lethal to humans in a few minutes. Provide ventilation to limit exposure. Reacts with metals, producing hydrogen gas.

5.2.2 Nitric Acid (HNO₃). Highly corrosive to eyes, skin, nose, and lungs. Vapors cause bronchitis, pneumonia, or edema of lungs. Reaction to inhalation may be delayed as long as 30 hours and still be fatal. Provide ventilation to limit exposure. Strong oxidizer. Hazardous reaction may occur with organic materials such as solvents.

6.0 Equipment and Supplies

6.1 Sample Collection and Mixing. The following items are required for collection and mixing of the sludge samples:

- 6.1.1 Container. Plastic, 50-liter.
- 6.1.2 Scoop. To remove 950-ml (1 quart.) sludge sample.
- 6.1.3 Mixer. Mortar mixer, wheelbarrow-type, 57-liter (or equivalent) with electricity-driven motor.
- 6.1.4 Blender. Waring-type, 2-liter.
- 6.1.5 Scoop. To remove 100-ml and 20-ml samples of blended sludge.
- 6.1.6 Erlenmeyer Flasks. Four, 125-ml.
- 6.1.7 Beakers. Glass beakers in the following sizes: 50 ml (1), 200 ml (1), 400 ml (2).

6.2 Sample Preparation and Analysis. Same as Method 101, Section 6.3, with the addition of the following:

- 6.2.1 Hot Plate.
- 6.2.2 Desiccator.
- 6.2.3 Filter Paper. S and S No. 588 (or equivalent).
- 6.2.4 Beakers. Glass beakers, 200 ml and 400 ml (2 each).

7.0 Reagents and Standards

Note: Unless otherwise indicated, it is intended that all reagents conform to the specifications established by the Committee on Analytical Reagents of the American Chemical Society, where such specifications are available; otherwise, use the best available grade.

- 7.1 Sample Analysis. Same as Method 101A, Section 7.2, with the following additions and exceptions:
 - 7.1.1 Hydrochloric Acid. The concentrated HCl specified in Method 101A, Section 7.2.4, is not required.
 - 7.1.2 Aqua Regia. Prepare immediately before use. Carefully add one volume of concentrated HNO₃ to three volumes of concentrated HCl.

8.0 Sample Collection, Preservation, Storage, and Transport

- 8.1 Sludge Sampling. Withdraw equal volume increments of sludge [for a total of at least 15 liters (16 quarts)] at intervals of 30 min over an 8-hr period, and combine in a rigid plastic container.
- 8.2 Sludge Mixing. Transfer the entire 15-liter sample to a mortar mixer. Mix the sample for a minimum of 30 min at 30 rpm. Take six 100-ml portions of sludge, and combine in a 2-liter blender. Blend sludge for 5 min; add water as necessary to give a fluid consistency. Immediately after stopping the blender, withdraw four 20-ml portions of blended sludge, and place them in separate, tared 125-ml Erlenmeyer flasks. Reweigh each flask to determine the exact amount of sludge added.
- 8.3 Sample Holding Time. Samples shall be analyzed within the time specified in the applicable subpart of the regulations.

9.0 Quality Control

	Quality control	
--	------------------------	--

Section	measure	Effect
10.0	Spectrophotometer calibration	Ensure linearity of spectrophotometer response to standards.
11.0	Check for matrix effects	Eliminate matrix effects.

10.0 Calibration and Standardization

Same as Method 101A, Section 10.2.

11.0 Analytical Procedures

11.1 Solids Content of Blended Sludge. Dry one of the 20-ml blended samples from Section 8.2 in an oven at 105 °C (221 °F) to constant weight. Cool in a desiccator, weigh and record the dry weight of the sample.

11.2 Aqua Regia Digestion of Blended Samples.

11.2.1 To each of the three remaining 20-ml samples from Section 8.2 add 25 ml of aqua regia, and digest the on a hot plate at low heat (do not boil) for 30 min, or until samples are a pale yellow-brown color and are void of the dark brown color characteristic of organic matter. Remove from hotplate and allow to cool.

11.2.2 Filter each digested sample separately through an S and S No. 588 filter or equivalent, and rinse the filter contents with 50 ml of water. Transfer the filtrate and filter washing to a 100-ml volumetric flask, and carefully dilute to volume with water.

11.3 Solids Content of the Sludge Before Blending. Remove two 100-ml portions of mixed sludge from the mortar mixer and place in separate, tared 400-ml beakers. Reweigh each beaker to determine the exact amount of sludge added. Dry in oven at 105 °C (221 °F) and cool in a desiccator to constant weight.

11.4 Analysis for Mercury. Analyze the three aqua regia-digested samples using the procedures outlined in Method 101A, Section 11.0.

12.0 Data Analysis and Calculations

12.1 Nomenclature.

C_m = Concentration of Hg in the digested sample, µg/g.

F_{sb} = Weight fraction of solids in the blended sludge.

F_{sm} = Weight fraction of solids in the collected sludge after mixing.

M = Hg content of the sewage sludge (on a dry basis), µg/g.

m = Mass of Hg in the aliquot of digested sample analyzed, µg.

n = number of digested samples (specified in Section 11.2 as three).

V_a = Volume of digested sample analyzed, ml.

V_s = Volume of digested sample, ml.

W_b = Weight of empty sample beaker, g.

W_{bs} = Weight of sample beaker and sample, g.

W_{bd} = Weight of sample beaker and sample after drying, g.

W_f = Weight of empty sample flask, g.

W_{fd} = Weight of sample flask and sample after drying, g.

W_{fs} = Weight of sample flask and sample, g.

12.2 Mercury Content of Digested Sample (Wet Basis).

12.2.1 For each sample analyzed for Hg content, calculate the arithmetic mean maximum absorbance of the two consecutive samples whose peak heights agree ± 3 percent of their average. Correct this average value for the contribution of the blank. Use the calibration curve and these corrected averages to determine the final Hg concentration in the solution cell for each sludge sample.

12.2.2 Calculate the average Hg concentration of the digested samples by correcting for any dilutions made to bring the sample into the working range of the spectrophotometer and for the weight of the sludge portion digested, using Equation 105-1.

$$\bar{C}_m = \sum_{i=1}^n \left[\frac{mV_s}{V_a (W_{fs} - W_f)} \right]_i \quad \text{Eq. 105-1}$$

12.3 Solids Content of Blended Sludge. Determine the solids content of the blended sludge using Equation 105-2.

$$F_{sb} = 1 - \frac{W_{fs} - W_{fd}}{W_{fs} - W_f} \quad \text{Eq. 105-2}$$

12.4 Solids Content of Bulk Sample (before blending but, after mixing in mortar mixer). Determine the solids content of each 100 ml aliquot (Section 11.3), and average the results.

$$F_{sm} = 1 - \frac{W_{ds} - W_{da}}{W_{ds} - W_d} \quad \text{Eq. 105-3}$$

12.5 Mercury Content of Bulk Sample (Dry Basis). Average the results from the three samples from each 8-hr composite sample, and calculate the Hg concentration of the composite sample on a dry basis.

$$M = \frac{\bar{C}_m}{F_{sb}} \quad \text{Eq. 105-4}$$

13.0 Method Performance

13.1 Range. The range of this method is 0.2 to 5 micrograms per gram; it may be extended by increasing or decreasing sample size.

*14.0 Pollution Prevention.[Reserved]**15.0 Waste Management.[Reserved]**16.0 References*

1. Bishop, J.N. Mercury in Sediments. Ontario Water Resources Commission. Toronto, Ontario, Canada. 1971.
2. Salma, M. Private Communication. EPA California/Nevada Basin Office. Alameda, California.
3. Hatch, W.R. and W.L. Ott. Determination of Sub-Microgram Quantities of Mercury by Atomic Absorption Spectrophotometry. Analytical Chemistry. 40:2085. 1968.
4. Bradenberger, H., and H. Bader. The Determination of Nanogram Levels of Mercury in Solution by a Flameless Atomic Absorption Technique. Atomic Absorption Newsletter. 6:101. 1967.
5. Analytical Quality Control Laboratory (AQCL). Mercury in Sediment (Cold Vapor Technique) (Provisional Method). U.S. Environmental Protection Agency. Cincinnati, Ohio. April 1972.
6. Kopp, J.F., M.C. Longbottom, and L.B. Lobring. "Cold Vapor" Method for Determining Mercury. Journal AWWA. 64(1):20-25. 1972.
7. Manual of Methods for Chemical Analysis of Water and Wastes. U.S. Environmental Protection Agency. Cincinnati, Ohio. Publication No. EPA-624/2-74-003. December 1974. pp. 118-138.
8. Mitchell, W.J., M.R. Midgett, J. Suggs, R.J. Velton, and D. Albrink. Sampling and Homogenizing Sewage for Analysis. Environmental Monitoring and Support Laboratory, Office of Research and Development, U.S. Environmental Protection Agency. Research Triangle Park, N.C. March 1979. p. 7.

17.0 Tables, Diagrams, Flowcharts, and Validation Data.[Reserved]

Method 106—Determination of Vinyl Chloride Emissions From Stationary Sources

*1.0 Scope and Application**1.1 Analytes.*

Analyte	CAS No.	Sensitivity
Vinyl Chloride (CH ₂ :CHCl)	75-01-4	Dependent upon analytical equipment.

1.2 Applicability. This method is applicable for the determination of vinyl chloride emissions from ethylene dichloride, vinyl chloride, and polyvinyl chloride manufacturing processes. This method does not measure vinyl chloride contained in particulate matter.

1.3 Data Quality Objectives. Adherence to the requirements of this method will enhance the quality of the data obtained from air pollutant sampling methods.

2.0 Summary of Method

2.1 An integrated bag sample of stack gas containing vinyl chloride is subjected to GC analysis using a flame ionization detector (FID).

*3.0 Definitions.[Reserved]**4.0 Interferences*

4.1 Resolution interferences of vinyl chloride may be encountered on some sources. Therefore, the chromatograph operator should select the column and operating parameters best suited to the particular analysis requirements. The selection made is subject to approval of the Administrator. Approval is automatic, provided that confirming data are produced through an adequate supplemental analytical technique, and that the data are available for review by the Administrator. An example of this would be analysis with a different column or GC/mass spectroscopy.

5.0 Safety

5.1 Disclaimer. This method may involve hazardous materials, operations, and equipment. This test method may not address all of the safety problems associated with its use. It is the responsibility of the user of this test method to establish appropriate safety and health practices and determine the applicability of regulatory limitations prior to performing this test method.

5.2 Toxic Analyte. Care must be exercised to prevent exposure of sampling personnel to vinyl chloride, which is a carcinogen.

6.0 Equipment and Supplies

6.1 Sample Collection (see Figure 106-1). The sampling train consists of the following components:

6.1.1 Probe. Stainless steel, borosilicate glass, Teflon tubing (as stack temperature permits), or equivalent, equipped with a glass wool plug to remove particulate matter.

6.1.2 Sample Lines. Teflon, 6.4-mm outside diameter, of sufficient length to connect probe to bag. Use a new unused piece for each series of bag samples that constitutes an emission test, and discard upon completion of the test.

6.1.3 Quick Connects. Stainless steel, male (2) and female (2), with ball checks (one pair without), located as shown in Figure 106-1.

6.1.4 Tedlar Bags. 50- to 100-liter capacity, to contain sample. Aluminized Mylar bags may be used if the samples are analyzed within 24 hours of collection.

6.1.5 Bag Containers. Rigid leak-proof containers for sample bags, with covering to protect contents from sunlight.

6.1.6 Needle Valve. To adjust sample flow rates.

6.1.7 Pump. Leak-free, with minimum of 2-liter/min capacity.

6.1.8 Charcoal Tube. To prevent admission of vinyl chloride and other organics to the atmosphere in the vicinity of samplers.

6.1.9 Flowmeter. For observing sampling flow rate; capable of measuring a flow range from 0.10 to 1.00 liter/min.

6.1.10 Connecting Tubing. Teflon, 6.4-mm outside diameter, to assemble sampling train (Figure 106-1).

6.1.11 Tubing Fittings and Connectors. Teflon or stainless steel, to assemble sampling training.

6.2 Sample Recovery. Teflon tubing, 6.4-mm outside diameter, to connect bag to GC sample loop. Use a new unused piece for each series of bag samples that constitutes an emission test, and discard upon conclusion of analysis of those bags.

6.3 Analysis. The following equipment is required:

6.3.1 Gas Chromatograph. With FID potentiometric strip chart recorder and 1.0 to 5.0-ml heated

sampling loop in automatic sample valve. The chromatographic system shall be capable of producing a response to 0.1-ppmv vinyl chloride that is at least as great as the average noise level. (Response is measured from the average value of the base line to the maximum of the wave form, while standard operating conditions are in use.)

6.3.2 Chromatographic Columns. Columns as listed below. Other columns may be used provided that the precision and accuracy of the analysis of vinyl chloride standards are not impaired and that information is available for review confirming that there is adequate resolution of vinyl chloride peak. (Adequate resolution is defined as an area overlap of not more than 10 percent of the vinyl chloride peak by an interferent peak. Calculation of area overlap is explained in Procedure 1 of appendix C to this part: "Determination of Adequate Chromatographic Peak Resolution.")

6.3.2.1 Column A. Stainless steel, 2.0 m by 3.2 mm, containing 80/100-mesh Chromasorb 102.

6.3.2.2 Column B. Stainless steel, 2.0 m by 3.2 mm, containing 20 percent GE SF-96 on 60/100-mesh Chromasorb P AW; or stainless steel, 1.0 m by 3.2 mm containing 80/100-mesh Porapak T. Column B is required as a secondary column if acetaldehyde is present. If used, column B is placed after column A. The combined columns should be operated at 120 °C (250 °F).

6.3.3 Rate Meters (2). Rotameter , or equivalent, 100-ml/min capacity, with flow control valves.

6.3.4 Gas Regulators. For required gas cylinders.

6.3.5 Temperature Sensor. Accurate to ± 1 °C (± 2 °F), to measure temperature of heated sample loop at time of sample injection.

6.3.6 Barometer. Accurate to ± 5 mm Hg, to measure atmospheric pressure around GC during sample analysis.

6.3.7 Pump. Leak-free, with minimum of 100-ml/min capacity.

6.3.8 Recorder. Strip chart type, optionally equipped with either disc or electronic integrator.

6.3.9 Planimeter. Optional, in place of disc or electronic integrator on recorder, to measure chromatograph peak areas.

6.4 Calibration and Standardization.

6.4.1 Tubing. Teflon, 6.4-mm outside diameter, separate pieces marked for each calibration concentration.

Note: The following items are required only if the optional standard gas preparation procedures (Section 10.1) are followed.

6.4.2 Tedlar Bags. Sixteen-inch-square size, with valve; separate bag marked for each calibration concentration.

6.4.3 Syringes. 0.5-ml and 50- μ l, gas tight, individually calibrated to dispense gaseous vinyl chloride.

6.4.4 Dry Gas Meter with Temperature and Pressure Gauges. Singer Model DTM-115 with 802 index, or equivalent, to meter nitrogen in preparation of standard gas mixtures, calibrated at the flow rate used to prepare standards.

7.0 Reagents and Standards

7.1 Analysis. The following reagents are required for analysis.

7.1.1 Helium or Nitrogen. Purity 99.9995 percent or greater, for chromatographic carrier gas.

8.0 Sample Collection, Preservation, Storage, and Transport

Note: Performance of this method should not be attempted by persons unfamiliar with the operation of a gas chromatograph (GC) nor by those who are unfamiliar with source sampling, because knowledge beyond the scope of this presentation is required.

8.1 Bag Leak-Check. The following leak-check procedure is recommended, but not required, prior to sample collection. The post-test leak-check procedure is mandatory. Connect a water manometer and pressurize the bag to 5 to 10 cm H₂O (2 to 4 in. H₂O). Allow to stand for 10 min. Any displacement in the water manometer indicates a leak. Also, check the rigid container for leaks in this manner.

Note: An alternative leak-check method is to pressurize the bag to 5 to 10 cm H₂O and allow it to stand overnight. A deflated bag indicates a leak. For each sample bag in its rigid container, place a rotameter in line between the bag and the pump inlet. Evacuate the bag. Failure of the rotameter to register zero flow when the bag appears to be empty indicates a leak.

8.2 Sample Collection. Assemble the sample train as shown in Figure 106–1. Join the quick connects as illustrated, and determine that all connection between the bag and the probe are tight. Place the end of the probe at the centroid of the stack and start the pump with the needle valve adjusted to yield a flow that will fill over 50 percent of bag volume in the specific sample period. After allowing sufficient time to purge the line several times, change the vacuum line from the container to the bag and evacuate the bag until the rotameter indicates no flow. Then reposition the sample and vacuum lines and begin the actual sampling, keeping the rate proportional to the stack velocity. At all times, direct the gas exiting the rotameter away from sampling personnel. At the end of the sample period, shut off the pump, disconnect the sample line from the bag, and disconnect the vacuum line from the bag container. Protect the bag container from sunlight.

8.3 Sample Storage. Keep the sample bags out of direct sunlight. When at all possible, analysis is to be performed within 24 hours, but in no case in excess of 72 hours of sample collection. Aluminized Mylar bag samples must be analyzed within 24 hours.

8.4 Post-test Bag Leak-Check. Subsequent to recovery and analysis of the sample, leak-check the sample bag according to the procedure outlined in Section 8.1.

9.0 Quality Control

9.1 Miscellaneous Quality Control

Section	Quality control measure	Effect
10.3	Chromatograph calibration	Ensure precision and accuracy of chromatograph.
11.1	Audit sample analysis	Evaluate analytical technique and standards preparation.

9.2 Immediately after the preparation of the calibration curve and prior to the sample analyses, perform the analysis audit described in appendix C, Procedure 2: "Procedure for Field Auditing GC Analysis."

10.0 Calibration and Standardization

Note: Maintain a laboratory log of all calibrations.

10.1 Preparation of Vinyl Chloride Standard Gas Mixtures. (Optional Procedure-delete if cylinder standards are used.) Evacuate a 16-inch square Tedlar bag that has passed a leak-check (described in Section 8.1) and meter in 5.0 liters of nitrogen. While the bag is filling, use the 0.5-ml syringe to inject

250 μ l of 99.9+ percent vinyl chloride gas through the wall of the bag. Upon withdrawing the syringe, immediately cover the resulting hole with a piece of adhesive tape. The bag now contains a vinyl chloride concentration of 50 ppmv. In a like manner use the 50 μ l syringe to prepare gas mixtures having 10- and 5-ppmv vinyl chloride concentrations. Place each bag on a smooth surface and alternately depress opposite sides of the bag 50 times to further mix the gases. These gas mixture standards may be used for 10 days from the date of preparation, after which time new gas mixtures must be prepared. (Caution: Contamination may be a problem when a bag is reused if the new gas mixture standard is a lower concentration than the previous gas mixture standard.)

10.2 Determination of Vinyl Chloride Retention Time. (This section can be performed simultaneously with Section 10.3.) Establish chromatograph conditions identical with those in Section 11.3. Determine proper attenuator position. Flush the sampling loop with helium or nitrogen and activate the sample valve. Record the injection time, sample loop temperature, column temperature, carrier gas flow rate, chart speed, and attenuator setting. Record peaks and detector responses that occur in the absence of vinyl chloride. Maintain conditions with the equipment plumbing arranged identically to Section 11.2, and flush the sample loop for 30 seconds at the rate of 100 ml/min with one of the vinyl chloride calibration mixtures. Then activate the sample valve. Record the injection time. Select the peak that corresponds to vinyl chloride. Measure the distance on the chart from the injection time to the time at which the peak maximum occurs. This quantity divided by the chart speed is defined as the retention time. Since other organics may be present in the sample, positive identification of the vinyl chloride peak must be made.

10.3 Preparation of Chromatograph Calibration Curve. Make a GC measurement of each gas mixture standard (described in Section 7.2.3 or 10.1) using conditions identical to those listed in Sections 11.2 and 11.3. Flush the sampling loop for 30 seconds at the rate of 100 ml/min with one of the standard mixtures, and activate the sample valve. Record the concentration of vinyl chloride injected (C_c), attenuator setting, chart speed, peak area, sample loop temperature, column temperature, carrier gas flow rate, and retention time. Record the barometric pressure. Calculate A_c , the peak area multiplied by the attenuator setting. Repeat until two consecutive injection areas are within 5 percent, then plot the average of those two values versus C_c . When the other standard gas mixtures have been similarly analyzed and plotted, draw a straight line through the points derived by the least squares method. Perform calibration daily, or before and after the analysis of each emission test set of bag samples, whichever is more frequent. For each group of sample analyses, use the average of the two calibration curves which bracket that group to determine the respective sample concentrations. If the two calibration curves differ by more than 5 percent from their mean value, then report the final results by both calibration curves.

11.0 Analytical Procedure

11.1 Audit Sample Analysis. Immediately after the preparation of the calibration curve and prior to the sample analyses, perform the analysis audit described in Procedure 2 of appendix C to this part: "Procedure for Field Auditing GC Analysis."

11.2 Sample Recovery. With a new piece of Teflon tubing identified for that bag, connect a bag inlet valve to the gas chromatograph sample valve. Switch the valve to receive gas from the bag through the sample loop. Arrange the equipment so the sample gas passes from the sample valve to 100-ml/min rotameter with flow control valve followed by a charcoal tube and a 1-in. H_2O pressure gauge. Maintain the sample flow either by a vacuum pump or container pressurization if the collection bag remains in the rigid container. After sample loop purging is ceased, allow the pressure gauge to return to zero before activating the gas sampling valve.

11.3 Analysis.

11.3.1 Set the column temperature to 100 °C (210 °F) and the detector temperature to 150 °C (300 °F). When optimum hydrogen and oxygen (or air) flow rates have been determined, verify and maintain these flow rates during all chromatography operations. Using helium or nitrogen as the carrier gas; establish a flow rate in the range consistent with the manufacturer's requirements for satisfactory detector operation. A flow rate of approximately 40 ml/min should produce adequate separations. Observe the base line periodically and determine that the noise level has stabilized and that base line drift has ceased. Purge the sample loop for 30 seconds at the rate of 100 ml/min, shut off flow, allow the sample loop pressure to reach atmospheric pressure as indicated by the H_2O manometer, then activate the sample valve. Record the injection time (the position of the pen on the chart at the time of sample injection), sample number, sample loop temperature, column temperature, carrier gas flow rate, chart

speed, and attenuator setting. Record the barometric pressure. From the chart, note the peak having the retention time corresponding to vinyl chloride as determined in Section 10.2. Measure the vinyl chloride peak area, A_m , by use of a disc integrator, electronic integrator, or a planimeter. Measure and record the peak heights, H_m . Record A_m and retention time. Repeat the injection at least two times or until two consecutive values for the total area of the vinyl chloride peak agree within 5 percent of their average. Use the average value for these two total areas to compute the bag concentration.

11.3.2 Compare the ratio of H_m to A_m for the vinyl chloride sample with the same ratio for the standard peak that is closest in height. If these ratios differ by more than 10 percent, the vinyl chloride peak may not be pure (possibly acetaldehyde is present) and the secondary column should be employed (see Section 6.3.2.2).

11.4 Determination of Bag Water Vapor Content. Measure the ambient temperature and barometric pressure near the bag. From a water saturation vapor pressure table, determine and record the water vapor content of the bag, B_{wb} , as a decimal figure. (Assume the relative humidity to be 100 percent unless a lesser value is known.)

12.0 Calculations and Data Analysis

12.1 Nomenclature.

A_m = Measured peak area.

A_f = Attenuation factor.

B_{wb} = Water vapor content of the bag sample, as analyzed, volume fraction.

C_b = Concentration of vinyl chloride in the bag, ppmv.

C_c = Concentration of vinyl chloride in the standard sample, ppmv.

P_i = Laboratory pressure at time of analysis, mm Hg.

P_r = Reference pressure, the laboratory pressure recorded during calibration, mm Hg.

T_i = Absolute sample loop temperature at the time of analysis, °K (°R).

T_r = Reference temperature, the sample loop temperature recorded during calibration, °K (°R).

12.2 Sample Peak Area. Determine the sample peak area, A_c , as follows:

$$A_c = A_m A_f \quad \text{Eq. 106-1}$$

12.3 Vinyl Chloride Concentration. From the calibration curves prepared in Section 10.3, determine the average concentration value of vinyl chloride, C_c , that corresponds to A_c , the sample peak area.

Calculate the concentration of vinyl chloride in the bag, C_b , as follows:

$$C_b = \frac{C_c P_r T_i}{P_i T_r (1 - B_{wb})} \quad \text{Eq. 106-2}$$

13.0 Method Performance

13.1 Analytical Range. This method is designed for the 0.1 to 50 parts per million by volume (ppmv) range. However, common gas chromatograph (GC) instruments are capable of detecting 0.02 ppmv vinyl chloride. With proper calibration, the upper limit may be extended as needed.

14.0 *Pollution Prevention, [Reserved]*

15.0 *Waste Management, [Reserved]*

16.0 *References*

1. Brown D.W., E.W. Loy, and M.H. Stephenson. Vinyl Chloride Monitoring Near the B. F. Goodrich Chemical Company in Louisville, KY. Region IV, U.S. Environmental Protection Agency, Surveillance and Analysis Division, Athens, GA. June 24, 1974.
2. G.D. Clayton and Associates. Evaluation of a Collection and Analytical Procedure for Vinyl Chloride in Air. U.S. Environmental Protection Agency, Research Triangle Park, N.C. EPA Contract No. 68-02-1408, Task Order No. 2, EPA Report No. 75-VCL-1. December 13, 1974.
3. Midwest Research Institute. Standardization of Stationary Source Emission Method for Vinyl Chloride. U.S. Environmental Protection Agency, Research Triangle Park, N.C. Publication No. EPA-600/4-77-026. May 1977.
4. Scheil, G. and M.C. Sharp. Collaborative Testing of EPA Method 106 (Vinyl Chloride) that Will Provide for a Standardized Stationary Source Emission Measurement Method. U.S. Environmental Protection Agency, Research Triangle Park, N.C. Publication No. EPA 600/4-78-058. October 1978.

17.0 *Tables, Diagrams Flowcharts, and Validation Data.*

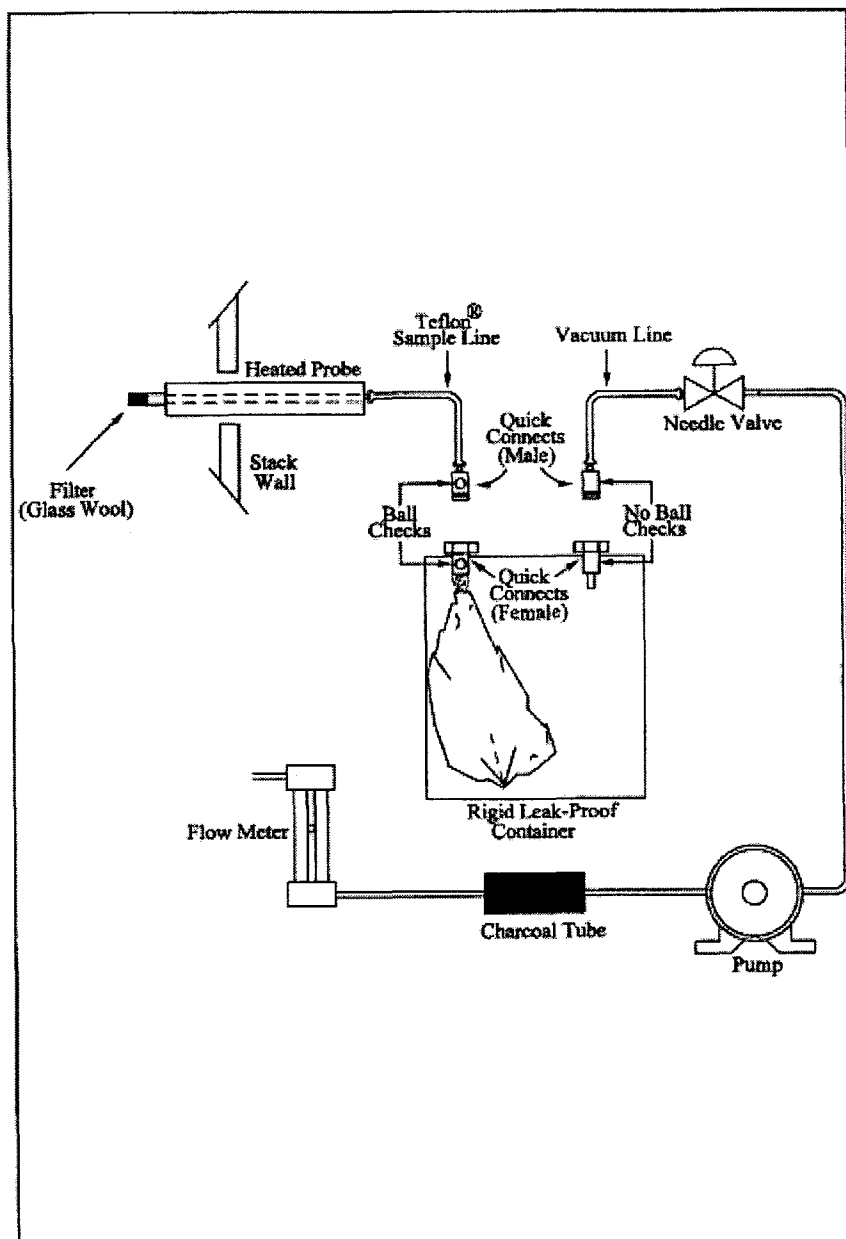

Figure 106-1. Integrated-bag sampling train.

[View or download PDF](#)

Method 107—Determination of Vinyl Chloride Content of In-Process Wastewater Samples, and Vinyl Chloride Content of Polyvinyl Chloride Resin Slurry, Wet Cake, and Latex Samples

Note: Performance of this method should not be attempted by persons unfamiliar with the operation of a gas chromatograph (GC) nor by those who are unfamiliar with source sampling, because knowledge beyond the scope of this presentation is required. This method does not include all of the specifications (e.g., equipment and supplies) and procedures (e.g., sampling and analytical) essential to its performance. Some material is incorporated by reference from other methods in this part. Therefore, to obtain reliable results, persons using this method should have a thorough knowledge of at least the following additional test methods: Method 106.

1.0 Scope and Application

1.1 Analytes.

Analyte	CAS No.	Sensitivity
Vinyl Chloride (CH ₂ :CHCl)	75-01-4	Dependent upon analytical equipment.

1.2 Applicability. This method is applicable for the determination of the vinyl chloride monomer (VCM) content of in-process wastewater samples, and the residual vinyl chloride monomer (RCVM) content of polyvinyl chloride (PVC) resins, wet, cake, slurry, and latex samples. It cannot be used for polymer in fused forms, such as sheet or cubes. This method is not acceptable where methods from section 304(h) of the Clean Water Act, 33 U.S.C. 1251 *et seq.* (the Federal Water Pollution Control Amendments of 1972 as amended by the Clean Water Act of 1977) are required.

1.3 Data Quality Objectives. Adherence to the requirements of this method will enhance the quality of the data obtained from air pollutant sampling methods.

2.0 Summary of Method

2.1 The basis for this method relates to the vapor equilibrium that is established at a constant known temperature in a closed system between RVCM, PVC resin, water, and air. The RVCM in a PVC resin will equilibrate rapidly in a closed vessel, provided that the temperature of the PVC resin is maintained above the glass transition temperature of that specific resin.

2.2 A sample of PVC or in-process wastewater is collected in a vial or bottle and is conditioned. The headspace in the vial or bottle is then analyzed for vinyl chloride using gas chromatography with a flame ionization detector.

3.0 Definitions[Reserved]

4.0 Interferences

4.1 The chromatograph columns and the corresponding operating parameters herein described normally provide an adequate resolution of vinyl chloride; however, resolution interferences may be encountered on some sources. Therefore, the chromatograph operator shall select the column and operating parameters best suited to his particular analysis requirements, subject to the approval of the Administrator. Approval is automatic provided that confirming data are produced through an adequate supplemental analytical technique, such as analysis with a different column or GC/mass spectroscopy, and that these data are made available for review by the Administrator.

5.0 Safety

5.1 Disclaimer. This method may involve hazardous materials, operations, and equipment. This test method may not address all of the safety problems associated with its use. It is the responsibility of the user of this test method to establish appropriate safety and health practices and determine the applicability of regulatory limitations prior to performing this test method.

5.2 Toxic Analyte. Care must be exercised to prevent exposure of sampling personnel to vinyl chloride, which is a carcinogen. Do not release vinyl chloride to the laboratory atmosphere during preparation of standards. Venting or purging with VCM/air mixtures must be held to a minimum. When they are required, the vapor must be routed to outside air. Vinyl chloride, even at low ppm levels, must never be vented inside the laboratory. After vials have been analyzed, the gas must be vented prior to removal of the vial from the instrument turntable. Vials must be vented through a hypodermic needle connected to an activated charcoal tube to prevent release of vinyl chloride into the laboratory atmosphere. The charcoal must be replaced prior to vinyl chloride breakthrough.

6.0 Equipment and Supplies

6.1 Sample Collection. The following equipment is required:

6.1.1 Glass bottles. 60-ml (2-oz) capacity, with wax-lined screw-on tops, for PVC samples.

6.1.2 Glass Vials. Headspace vials, with Teflon-faced butyl rubber sealing discs, for water samples.

6.1.3 Adhesive Tape. To prevent loosening of bottle tops.

6.2 Sample Recovery. The following equipment is required:

6.2.1 Glass Vials. Headspace vials, with butyl rubber septa and aluminum caps. Silicone rubber is not acceptable.

6.2.2 Analytical Balance. Capable of determining sample weight within an accuracy of ± 1 percent.

6.2.3 Vial Sealer. To seal headspace vials.

6.2.4 Syringe. 100-ml capacity.

6.3 Analysis. The following equipment is required:

6.3.1 Headspace Sampler and Chromatograph. Capable of sampling and analyzing a constant amount of headspace gas from a sealed vial, while maintaining that vial at a temperature of $90\text{ }^{\circ}\text{C} \pm 0.5\text{ }^{\circ}\text{C}$ ($194\text{ }^{\circ}\text{F} \pm 0.9\text{ }^{\circ}\text{F}$). The chromatograph shall be equipped with a flame ionization detector (FID). Perkin-Elmer Corporation Models F-40, F-42, F-45, HS-6, and HS-100, and Hewlett-Packard Corporation Model 19395A have been found satisfactory. Chromatograph backflush capability may be required.

6.3.2 Chromatographic Columns. Stainless steel 1 m by 3.2 mm and 2 m by 3.2 mm, both containing 50/80-mesh Porapak Q. Other columns may be used provided that the precision and accuracy of the analysis of vinyl chloride standards are not impaired and information confirming that there is adequate resolution of the vinyl chloride peak are available for review. (Adequate resolution is defined as an area overlap of not more than 10 percent of the vinyl chloride peak by an interferant peak. Calculation of area overlap is explained in Procedure 1 of appendix C to this part: "Determination of Adequate Chromatographic Peak Resolution.") Two 1.83 m columns, each containing 1 percent Carbowax 1500 on Carbopak B, have been found satisfactory for samples containing acetaldehyde.

6.3.3 Temperature Sensor. Range 0 to $100\text{ }^{\circ}\text{C}$ (32 to $212\text{ }^{\circ}\text{F}$) accurate to $0.1\text{ }^{\circ}\text{C}$.

6.3.4 Integrator-Recorder. To record chromatograms.

6.3.5 Barometer. Accurate to 1 mm Hg.

6.3.6 Regulators. For required gas cylinders.

6.3.7 Headspace Vial Pre-Pressurizer. Nitrogen pressurized hypodermic needle inside protective shield.

7.0 Reagents and Standards

7.1 Analysis. Same as Method 106, Section 7.1, with the addition of the following:

7.1.1 Water. Interference-free.

7.2 Calibration. The following items are required for calibration:

7.2.1 Cylinder Standards (4). Gas mixture standards (50-, 500-, 2000- and 4000-ppm vinyl chloride in nitrogen cylinders). Cylinder standards may be used directly to prepare a chromatograph calibration curve as described in Section 10.3, if the following conditions are met: (a) The manufacturer certifies the gas composition with an accuracy of ± 3 percent or better (see Section 7.2.1.1). (b) The manufacturer recommends a maximum shelf life over which the gas concentration does not change by greater than ± 5 percent from the certified value. (c) The manufacturer affixes the date of gas cylinder preparation,

certified vinyl chloride concentration, and recommended maximum shelf life to the cylinder before shipment to the buyer.

7.2.1.1 Cylinder Standards Certification. The manufacturer shall certify the concentration of vinyl chloride in nitrogen in each cylinder by (a) directly analyzing each cylinder and (b) calibrating the analytical procedure on the day of cylinder analysis. To calibrate the analytical procedure, the manufacturer shall use, as a minimum, a 3-point calibration curve. It is recommended that the manufacturer maintain (1) a high-concentration calibration standard (between 4000 and 8000 ppm) to prepare the calibration curve by an appropriate dilution technique and (2) a low-concentration calibration standard (between 50 and 500 ppm) to verify the dilution technique used. If the difference between the apparent concentration read from the calibration curve and the true concentration assigned to the low-concentration calibration standard exceeds 5 percent of the true concentration, the manufacturer shall determine the source of error and correct it, then repeat the 3-point calibration.

7.2.1.2 Verification of Manufacturer's Calibration Standards. Before using, the manufacturer shall verify each calibration standard by (a) comparing it to gas mixtures prepared (with 99 mole percent vinyl chloride) in accordance with the procedure described in Section 10.1 of Method 106 or by (b) calibrating it against vinyl chloride cylinder Standard Reference Materials (SRMs) prepared by the National Institute of Standards and Technology, if such SRMs are available. The agreement between the initially determined concentration value and the verification concentration value must be within 5 percent. The manufacturer must reverify all calibration standards on a time interval consistent with the shelf life of the cylinder standards sold.

8.0 Sample Collection, Preservation, Storage, and Transport

8.1 Sample Collection.

8.1.1 PVC Sampling. Allow the resin or slurry to flow from a tap on the tank or silo until the tap line has been well purged. Extend and fill a 60-ml sample bottle under the tap, and immediately tighten a cap on the bottle. Wrap adhesive tape around the cap and bottle to prevent the cap from loosening. Place an identifying label on each bottle, and record the date, time, and sample location both on the bottles and in a log book.

8.1.2 Water Sampling. At the sampling location fill the vials bubble-free to overflowing so that a convex meniscus forms at the top. The excess water is displaced as the sealing disc is carefully placed, with the Teflon side down, on the opening of the vial. Place the aluminum seal over the disc and the neck of the vial, and crimp into place. Affix an identifying label on the bottle, and record the date, time, and sample location both on the vials and in a log book.

8.2 Sample Storage. All samples must be analyzed within 24 hours of collection, and must be refrigerated during this period.

9.0 Quality Control

Section	Quality control measure	Effect
10.3	Chromatograph calibration	Ensure precision and accuracy of chromatograph.

10.0 Calibration and Standardization

Note: Maintain a laboratory log of all calibrations.

10.1 Preparation of Standards. Calibration standards are prepared as follows: Place 100 µl or about two equal drops of distilled water in the sample vial, then fill the vial with the VCM/nitrogen standard, rapidly seat the septum, and seal with the aluminum cap. Use a 1/8-in. stainless steel line from the cylinder to the vial. Do not use rubber or Tygon tubing. The sample line from the cylinder must be purged (into a properly vented hood) for several minutes prior to filling the vials. After purging, reduce the flow rate to between 500 and 1000 cc/min. Place end of tubing into vial (near bottom). Position a septum on top of

the vial, pressing it against the 1/8-in. filling tube to minimize the size of the vent opening. This is necessary to minimize mixing air with the standard in the vial. Each vial is to be purged with standard for 90 seconds, during which time the filling tube is gradually slid to the top of the vial. After the 90 seconds, the tube is removed with the septum, simultaneously sealing the vial. Practice will be necessary to develop good technique. Rubber gloves should be worn during the above operations. The sealed vial must then be pressurized for 60 seconds using the vial prepressurizer. Test the vial for leakage by placing a drop of water on the septum at the needle hole. Prepressurization of standards is not required unless samples have been prepressurized.

10.2 Analyzer Calibration. Calibration is to be performed each 8-hour period the chromatograph is used. Alternatively, calibration with duplicate 50-, 500-, 2,000-, and 4,000-ppm standards (hereafter described as a four-point calibration) may be performed on a monthly basis, provided that a calibration confirmation test consisting of duplicate analyses of an appropriate standard is performed once per plant shift, or once per chromatograph carousel operation (if the chromatograph operation is less frequent than once per shift). The criterion for acceptance of each calibration confirmation test is that both analyses of 500-ppm standards [2,000-ppm standards if dispersion resin (excluding latex resin) samples are being analyzed] must be within 5 percent of the most recent four-point calibration curve. If this criterion is not met, then a complete four-point calibration must be performed before sample analyses can proceed.

10.3 Preparation of Chromatograph Calibration Curve. Prepare two vials each of 50-, 500-, 2,000-, and 4,000-ppm standards. Run the calibration samples in exactly the same manner as regular samples. Plot A_s , the integrator area counts for each standard sample, versus C_c , the concentration of vinyl chloride in each standard sample. Draw a straight line through the points derived by the least squares method.

11.0 Analytical Procedure

11.1 Preparation of Equipment. Install the chromatographic column and condition overnight at 160 °C (320 °F). In the first operation, Porapak columns must be purged for 1 hour at 230 °C (450 °F).

Do not connect the exit end of the column to the detector while conditioning. Hydrogen and air to the detector must be turned off while the column is disconnected.

11.2 Flow Rate Adjustments. Adjust flow rates as follows:

11.2.1. Nitrogen Carrier Gas. Set regulator on cylinder to read 50 psig. Set regulator on chromatograph to produce a flow rate of 30.0 cc/min. Accurately measure the flow rate at the exit end of the column using the soap film flowmeter and a stopwatch, with the oven and column at the analysis temperature. After the instrument program advances to the "B" (backflush) mode, adjust the nitrogen pressure regulator to exactly balance the nitrogen flow rate at the detector as was obtained in the "A" mode.

11.2.2. Vial Prepressurizer Nitrogen.

11.2.2.1 After the nitrogen carrier is set, solve the following equation and adjust the pressure on the vial prepressurizer accordingly.

$$P = \frac{T_1}{T_2} \left[P_1 - \frac{P_{w1} - P_{w2}}{7.50} \right] - 10kPa \quad \text{Eq. 107-1}$$

Where:

T_1 = Ambient temperature, °K (°R).

T_2 = Conditioning bath temperature, °K (°R).

P_1 = Gas chromatograph absolute dosing pressure (analysis mode), k Pa.

P_{w1} = Water vapor pressure 525.8 mm Hg @ 90 °C.

P_{w2} = Water vapor pressure 19.8 mm Hg @ 22 °C.

7.50 = mm Hg per k Pa.

10 kPa = Factor to adjust the prepressurized pressure to slightly less than the dosing pressure.

11.2.2.2 Because of gauge errors, the apparatus may over-pressurize the vial. If the vial pressure is at or higher than the dosing pressure, an audible double injection will occur. If the vial pressure is too low, errors will occur on resin samples because of inadequate time for head-space gas equilibrium. This condition can be avoided by running several standard gas samples at various pressures around the calculated pressure, and then selecting the highest pressure that does not produce a double injection. All samples and standards must be pressurized for 60 seconds using the vial prepressurizer. The vial is then placed into the 90 °C conditioning bath and tested for leakage by placing a drop of water on the septum at the needle hole. A clean, burr-free needle is mandatory.

11.2.3. Burner Air Supply. Set regulator on cylinder to read 50 psig. Set regulator on chromatograph to supply air to burner at a rate between 250 and 300 cc/min. Check with bubble flowmeter.

11.2.4. Hydrogen Supply. Set regulator on cylinder to read 30 psig. Set regulator on chromatograph to supply approximately 35 ± 5 cc/min. Optimize hydrogen flow to yield the most sensitive detector response without extinguishing the flame. Check flow with bubble meter and record this flow.

11.3 Temperature Adjustments. Set temperatures as follows:

11.3.1. Oven (chromatograph column), 140 °C (280 °F).

11.3.2. Dosing Line, 150 °C (300 °F).

11.3.3. Injection Block, 170 °C (340 °F).

11.3.4. Sample Chamber, Water Temperature, 90 °C ± 1.0 °C (194 °F ± 1.8 °F).

11.4 Ignition of Flame Ionization Detector. Ignite the detector according to the manufacturer's instructions.

11.5 Amplifier Balance. Balance the amplifier according to the manufacturer's instructions.

11.6 Programming the Chromatograph. Program the chromatograph as follows:

11.6.1. I—Dosing or Injection Time. The normal setting is 2 seconds.

11.6.2. A—Analysis Time. The normal setting is approximately 70 percent of the VCM retention time. When this timer terminates, the programmer initiates backflushing of the first column.

11.6.3. B—Backflushing Time. The normal setting is double the analysis time.

11.6.4. W—Stabilization Time. The normal setting is 0.5 min to 1.0 min.

11.6.5. X—Number of Analyses Per Sample. The normal setting is one.

11.7. Sample Treatment. All samples must be recovered and analyzed within 24 hours after collection.

11.7.1 Resin Samples. The weight of the resin used must be between 0.1 and 4.5 grams. An exact weight must be obtained (within ± 1 percent) for each sample. In the case of suspension resins, a volumetric cup can be prepared for holding the required amount of sample. When the cup is used, open

the sample bottle, and add the cup volume of resin to the tared sample vial (tared, including septum and aluminum cap). Obtain the exact sample weight, add 100 ml or about two equal drops of water, and immediately seal the vial. Report this value on the data sheet; it is required for calculation of RVCM. In the case of dispersion resins, the cup cannot be used. Weigh the sample in an aluminum dish, transfer the sample to the tared vial, and accurately weigh it in the vial. After prepressurization of the samples, condition them for a minimum of 1 hour in the 90 °C (190 °F) bath. Do not exceed 5 hours.

Prepressurization is not required if the sample weight, as analyzed, does not exceed 0.2 gram. It is also not required if solution of the prepressurization equation yields an absolute prepressurization value that is within 30 percent of the atmospheric pressure.

Note: Some aluminum vial caps have a center section that must be removed prior to placing into sample tray. If the cap is not removed, the injection needle will be damaged.

11.7.2 Suspension Resin Slurry and Wet Cake Samples. Decant the water from a wet cake sample, and turn the sample bottle upside down onto a paper towel. Wait for the water to drain, place approximately 0.2 to 4.0 grams of the wet cake sample in a tared vial (tared, including septum and aluminum cap) and seal immediately. Then determine the sample weight (1 percent). All samples weighing over 0.2 gram, must be prepressurized prior to conditioning for 1 hour at 90 °C (190 °F), except as noted in Section 11.7.1. A sample of wet cake is used to determine total solids (TS). This is required for calculating the RVCM.

11.7.3 Dispersion Resin Slurry and Geon Latex Samples. The materials should not be filtered. Sample must be thoroughly mixed. Using a tared vial (tared, including septum and aluminum cap) add approximately eight drops (0.25 to 0.35 g) of slurry or latex using a medicine dropper. This should be done immediately after mixing. Seal the vial as soon as possible. Determine sample weight (1 percent). Condition the vial for 1 hour at 90 °C (190 °F) in the analyzer bath. Determine the TS on the slurry sample (Section 11.10).

11.7.4 In-process Wastewater Samples. Using a tared vial (tared, including septum and aluminum cap) quickly add approximately 1 cc of water using a medicine dropper. Seal the vial as soon as possible. Determine sample weight (1 percent). Condition the vial for 1 hour at 90 °C (190 °F) in the analyzer bath.

11.8 Preparation of Sample Turntable.

11.8.1 Before placing any sample into turntable, be certain that the center section of the aluminum cap has been removed. The numbered sample vials should be placed in the corresponding numbered positions in the turntable. Insert samples in the following order:

11.8.1.1 Positions 1 and 2. Old 2000-ppm standards for conditioning. These are necessary only after the analyzer has not been used for 24 hours or longer.

11.8.1.2 Position 3. 50-ppm standard, freshly prepared.

11.8.1.3 Position 4. 500-ppm standard, freshly prepared.

11.8.1.4 Position 5. 2000-ppm standard, freshly prepared.

11.8.1.5 Position 6. 4000-ppm standard, freshly prepared.

11.8.1.6 Position 7. Sample No. 7 (This is the first sample of the day, but is given as 7 to be consistent with the turntable and the integrator printout.)

11.8.2 After all samples have been positioned, insert the second set of 50-, 500-, 2000-, and 4000-ppm standards. Samples, including standards, must be conditioned in the bath of 90 °C (190 °F) for a minimum of one hour and a maximum of five hours.

11.9 Start Chromatograph Program. When all samples, including standards, have been conditioned at 90 °C (190 °F) for at least one hour, start the analysis program according to the manufacturer's instructions. These instructions must be carefully followed when starting and stopping a program to

prevent damage to the dosing assembly.

11.10 Determination of Total Solids. For wet cake, slurry, resin solution, and PVC latex samples, determine TS for each sample by accurately weighing approximately 3 to 4 grams of sample in an aluminum pan before and after placing in a draft oven (105 to 110 °C (221 to 230 °F)). Samples must be dried to constant weight. After first weighing, return the pan to the oven for a short period of time, and then reweigh to verify complete dryness. The TS are then calculated as the final sample weight divided by initial sample weight.

12.0 Calculations and Data Analysis

12.1 Nomenclature.

A_s = Chromatogram area counts of vinyl chloride for the sample, area counts.

A_s = Chromatogram area counts of vinyl chloride for the sample.

C_c = Concentration of vinyl chloride in the standard sample, ppm.

K_p = Henry's Law Constant for VCM in PVC 90 °C, 6.52×10^{-6} g/g/mm Hg.

K_w = Henry's Law Constant for VCM in water 90 °C, 7×10^{-7} g/g/mm Hg.

M_v = Molecular weight of VCM, 62.5 g/mole.

m = Sample weight, g.

P_a = Ambient atmospheric pressure, mm Hg.

R = Gas constant, (62360³ ml) (mm Hg)/(mole)(°K).

R_f = Response factor in area counts per ppm VCM.

R_s = Response factor, area counts/ppm.

T_1 = Ambient laboratory temperature, °K.

TS = Total solids expressed as a decimal fraction.

T_2 = Equilibrium temperature, °K.

V_g = Volume of vapor phase, ml.

$$= V_v - \frac{m(TS)}{1.36} - \frac{m(1-TS)}{0.9653}$$

V_v = Vial volume, ³ ml.

1.36 = Density of PVC at 90 °C, g/³ ml.

0.9653 = Density of water at 90 °C, g/³ ml.

12.2 Response Factor. If the calibration curve described in Section 10.3 passes through zero, an average response factor, R_f , may be used to facilitate computation of vinyl chloride sample concentrations.

12.2.1 To compute R_f , first compute a response factor, R_s , for each sample as follows:

$$R_s = \frac{A_s}{C_s} \quad \text{Eq. 107-2}$$

12.2.2 Sum the individual response factors, and calculate R_f . If the calibration curve does not pass through zero, use the calibration curve to determine each sample concentration.

12.3 Residual Vinyl Chloride Monomer Concentration, (C_{rvc}) or Vinyl Chloride Monomer Concentration. Calculate C_{rvc} in ppm or mg/kg as follows:

$$C_{rvc} = \frac{A_s P_a}{R_f T_1} \left[\frac{M_v V_E}{Rm} + K_p (TS) T_2 K_w (1 - TS) T_2 \right] \quad \text{Eq. 107-3}$$

Note: Results calculated using these equations represent concentration based on the total sample. To obtain results based on dry PVC content, divide by TS.

13.0 Method Performance

13.1 Range and Sensitivity. The lower limit of detection of vinyl chloride will vary according to the sampling and chromatographic system. The system should be capable of producing a measurement for a 50-ppm vinyl chloride standard that is at least 10 times the standard deviation of the system background noise level.

13.2 An interlaboratory comparison between seven laboratories of three resin samples, each split into three parts, yielded a standard deviation of 2.63 percent for a sample with a mean of 2.09 ppm, 4.16 percent for a sample with a mean of 1.66 ppm, and 5.29 percent for a sample with a mean of 62.66 ppm.

14.0 Pollution Prevention[Reserved]

15.0 Waste Management[Reserved]

16.0 References

1. B.F. Goodrich, Residual Vinyl Chloride Monomer Content of Polyvinyl Chloride Resins, Latex, Wet Cake, Slurry and Water Samples. B.F. Goodrich Chemical Group Standard Test Procedure No. 1005-E. B.F. Goodrich Technical Center, Avon Lake, Ohio. October 8, 1979.
2. Berens, A.R. The Diffusion of Vinyl Chloride in Polyvinyl Chloride. ACS-Division of Polymer Chemistry, Polymer Preprints 15 (2):197. 1974.
3. Berens, A.R. The Diffusion of Vinyl Chloride in Polyvinyl Chloride. ACS-Division of Polymer Chemistry, Polymer Preprints 15 (2):203. 1974.
4. Berens, A.R., et. al. Analysis for Vinyl Chloride in PVC Powders by Head-Space Gas Chromatography. Journal of Applied Polymer Science. 19:3169–3172. 1975.
5. Mansfield, R.A. The Evaluation of Henry's Law Constant (K_p) and Water Enhancement in the Perkin-Elmer Multifract F-40 Gas Chromatograph. B.F. Goodrich. Avon Lake, Ohio. February 10, 1978.

17.0 Tables, Diagrams, Flowcharts, and Validation Data[Reserved]

Method 107A—Determination of Vinyl Chloride Content of Solvents, Resin-Solvent Solution, Polyvinyl Chloride Resin, Resin Slurry, Wet Resin, and Latex Samples

Introduction

Performance of this method should not be attempted by persons unfamiliar with the operation of a gas chromatograph (GC) or by those who are unfamiliar with source sampling because knowledge beyond the scope of this presentation is required. Care must be exercised to prevent exposure of sampling personnel to vinyl chloride, a carcinogen.

1. Applicability and Principle

1.1 Applicability. This is an alternative method and applies to the measurement of the vinyl chloride content of solvents, resin solvent solutions, polyvinyl chloride (PVC) resin, wet cake slurries, latex, and fabricated resin samples. This method is not acceptable where methods from Section 304(h) of the Clean Water Act, 33 U.S.C. 1251 et seq., (the Federal Water Pollution Control Act Amendments of 1972 as amended by the Clean Water Act of 1977) are required.

1.2 Principle. The basis for this method lies in the direct injection of a liquid sample into a chromatograph and the subsequent evaporation of all volatile material into the carrier gas stream of the chromatograph, thus permitting analysis of all volatile material including vinyl chloride.

2. Range and Sensitivity

The lower limit of detection of vinyl chloride in dry PVC resin is 0.2 ppm. For resin solutions, latexes, and wet resin, this limit rises inversely as the nonvolatile (resin) content decreases.

With proper calibration, the upper limit may be extended as needed.

3. Interferences

The chromatograph columns and the corresponding operating parameters herein described normally provide an adequate resolution of vinyl chloride. In cases where resolution interferences are encountered, the chromatograph operator shall select the column and operating parameters best suited to his particular analysis problem, subject to the approval of the Administrator. Approval is automatic, provided that the tester produces confirming data through an adequate supplemental analytical technique, such as analysis with a different column or GC/mass spectroscopy, and has the data available for review by the Administrator.

4. Precision and Reproducibility

A standard sample of latex containing 181.8 ppm vinyl chloride analyzed 10 times by the alternative method showed a standard deviation of 7.5 percent and a mean error of 0.21 percent.

A sample of vinyl chloride copolymer resin solution was analyzed 10 times by the alternative method and showed a standard deviation of 6.6 percent at a level of 35 ppm.

5. Safety

Do not release vinyl chloride to the laboratory atmosphere during preparation of standards. Venting or purging with vinyl chloride monomer (VCM) air mixtures must be held to minimum. When purging is required, the vapor must be routed to outside air. Vinyl chloride, even at low-ppm levels, must never be vented inside the laboratory.

6. Apparatus

6.1 Sampling. The following equipment is required:

6.1.1 Glass Bottles. 16-oz wide mouth wide polyethylene-lined, screw-on tops.

6.1.2 Adhesive Tape. To prevent loosening of bottle tops.

6.2 Sample Recovery. The following equipment is required:

6.2.1 Glass Vials. 20-ml capacity with polycone screw caps.

6.2.2 Analytical Balance. Capable of weighing to ± 0.01 gram.

6.2.3 Syringe. 50-microliter size, with removable needle.

6.2.4 Fritted Glass Sparger. Fine porosity.

6.2.5 Aluminum Weighing Dishes.

6.2.6 Sample Roller or Shaker. To help dissolve sample.

6.3 Analysis. The following equipment is required:

6.3.1 Gas Chromatograph. Hewlett Packard Model 5720A or equivalent.

6.3.2 Chromatograph Column. Stainless steel, 6.1 m by 3.2 mm, packed with 20 percent Tergitol E-35 on Chromosorb W AW 60/80 mesh. The analyst may use other columns provided that the precision and accuracy of the analysis of vinyl chloride standards are not impaired and that he has available for review information confirming that there is adequate resolution of the vinyl chloride peak. (Adequate resolution is defined as an area overlap of not more than 10 percent of the vinyl chloride peak by an interfering peak. Calculation of area overlap is explained in Appendix C, Procedure 1: "Determination of Adequate Chromatographic Peak Resolution.")

6.3.3 Valco Instrument Six-Port Rotary Valve. For column back flush.

6.3.4 Septa. For chromatograph injection port.

6.3.5 Injection Port Liners. For chromatograph used.

6.3.6 Regulators. For required gas cylinders.

6.3.7 Soap Film Flowmeter. Hewlett Packard No. 0101-0113 or equivalent.

6.4 Calibration. The following equipment is required:

6.4.1 Analytical Balance. Capable of weighing to ± 0.0001 g.

6.4.2 Erlenmeyer Flask With Glass Stopper. 125 ml.

6.4.3 Pipets. 0.1, 0.5, 1, 5, 10, and 50 ml.

6.4.4 Volumetric Flasks. 10 and 100 ml.

7. Reagents

Use only reagents that are of chromatograph grade.

7.1 Analysis. The following items are required:

7.1.1 Hydrogen Gas. Zero grade.

7.1.2 Nitrogen Gas. Zero grade.

7.1.3 Air. Zero grade.

7.1.4 Tetrahydrofuran (THF). Reagent grade.

Analyze the THF by injecting 10 microliters into the prepared gas chromatograph. Compare the THF chromatogram with that shown in Figure 107A-1. If the chromatogram is comparable to A, the THF should be sparged with pure nitrogen for approximately 2 hours using the fritted glass sparger to attempt to remove the interfering peak. Reanalyze the sparged THF to determine whether the THF is acceptable for use. If the scan is comparable to B, the THF should be acceptable for use in the analysis.

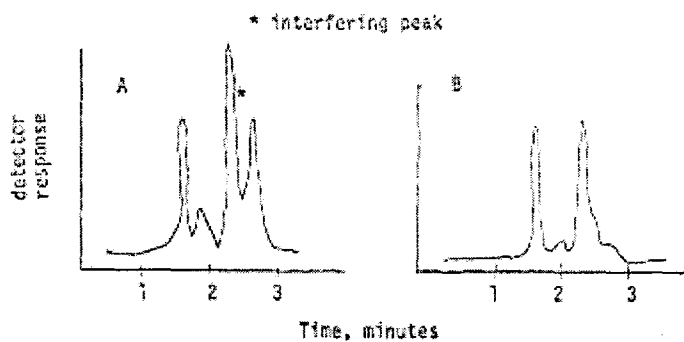

Figure 107A-1

7.1.5 N, N-Dimethylacetamide (DMAC). Spectrographic grade. For use in place of THF.

7.2 Calibration. The following item is required:

7.2.1 Vinyl Chloride 99.9 Percent. Ideal Gas Products lecture bottle, or equivalent. For preparation of standard solutions.

8. Procedure

8.1 Sampling. Allow the liquid or dried resin to flow from a tap on the tank, silo, or pipeline until the tap has been purged. Fill a wide-mouth pint bottle, and immediately tightly cap the bottle. Place an identifying label on each bottle and record the date, time, sample location, and material.

8.2 Sample Treatment. Sample must be run within 24 hours.

8.2.1 Resin Samples. Weigh 9.00 ± 0.01 g of THF or DMAC in a tared 20-ml vial. Add 1.00 ± 0.01 g of resin to the tared vial containing the THF or DMAC. Close the vial tightly with the screw cap, and shake or otherwise agitate the vial until complete solution of the resin is obtained. Shaking may require several minutes to several hours, depending on the nature of the resin.

8.2.2 Suspension Resin Slurry and Wet Resin Sample. Slurry must be filtered using a small Buchner funnel with vacuum to yield a wet resin sample. The filtering process must be continued only as long as a steady stream of water is exiting from the funnel. Excessive filtration time could result in some loss of VCM. The wet resin sample is weighed into a tared 20-ml vial with THF or DMAC as described earlier for resin samples (8.2.1) and treated the same as the resin sample. A sample of the wet resin is used to determine total solids as required for calculating the residual VCM (Section 8.3.4).

8.2.3 Latex and Resin Solvent Solutions. Samples must be thoroughly mixed. Weigh 1.00 ± 0.01 g of the latex or resin-solvent solution into a 20-ml vial containing 9.00 ± 0.01 g of THF or DMAC as for the resin samples (8.2.1). Cap and shake until complete solution is obtained. Determine the total solids of the latex or resin solution sample (Section 8.3.4).

8.2.4 Solvents and Non-viscous Liquid Samples. No preparation of these samples is required. The neat samples are injected directly into the GC.

8.3 Analysis.

8.3.1 Preparation of GC. Install the chromatographic column, and condition overnight at 70 °C. Do not connect the exit end of the column to the detector while conditioning.

8.3.1.1 Flow Rate Adjustments. Adjust the flow rate as follows:

a. Nitrogen Carrier Gas. Set regulator on cylinder to read 60 psig. Set column flow controller on the chromatograph using the soap film flowmeter to yield a flow rate of 40 cc/min.

b. Burner Air Supply. Set regulator on the cylinder at 40 psig. Set regulator on the chromatograph to supply air to the burner to yield a flow rate of 250 to 300 cc/min using the flowmeter.

c. Hydrogen. Set regulator on cylinder to read 60 psig. Set regulator on the chromatograph to supply 30 to 40 cc/min using the flowmeter. Optimize hydrogen flow to yield the most sensitive detector response without extinguishing the flame. Check flow with flowmeter and record this flow.

d. Nitrogen Back Flush Gas. Set regulator on the chromatograph using the soap film flowmeter to yield a flow rate of 40 cc/min.

8.3.1.2 Temperature Adjustments. Set temperature as follows:

a. Oven (chromatographic column) at 70 °C.

b. Injection Port at 100 °C.

c. Detector at 300 °C.

8.3.1.3 Ignition of Flame Ionization Detector. Ignite the detector according to the manufacturer's instructions. Allow system to stabilize approximately 1 hour.

8.3.1.4 Recorder. Set pen at zero and start chart drive.

8.3.1.5 Attenuation. Set attenuation to yield desired peak height depending on sample VCM content.

8.3.2 Chromatographic Analyses.

a. Sample Injection. Remove needle from 50-microliter syringe. Open sample vial and draw 50-microliters of THF or DMAC sample recovery solution into the syringe. Recap sample vial. Attach needle to the syringe and while holding the syringe vertically (needle uppermost), eject 40 microliters into an absorbent tissue. Wipe needle with tissue. Now inject 10 microliters into chromatograph system. Repeat the injection until two consecutive values for the height of the vinyl chloride peak do not vary more than 5 percent. Use the average value for these two peak heights to compute the sample concentration.

b. Back Flush. After 4 minutes has elapsed after sample injection, actuate the back flush valve to purge the first 4 feet of the chromatographic column of solvent and other high boilers.

c. Sample Data. Record on the chromatograph strip chart the data from the sample label.

d. Elution Time. Vinyl chloride elutes at 2.8 minutes. Acetaldehyde elutes at 3.7 minutes. Analysis is considered complete when chart pen becomes stable. After 5 minutes, reset back flush valve and inject next sample.

8.3.3 Chromatograph Servicing.

- a. Septum. Replace after five sample injections.
- b. Sample Port Liner. Replace the sample port liner with a clean spare after five sample injections.
- c. Chromatograph Shutdown. If the chromatograph has been shut down overnight, rerun one or more samples from the preceding day to test stability and precision prior to starting on the current day's work.

8.3.4 Determination of Total Solids (TS). For wet resin, resin solution, and PVC latex samples, determine the TS for each sample by accurately weighing approximately 3 to 5 grams of sample into a tared aluminum pan. The initial procedure is as follows:

- a. Where water is the major volatile component: Tare the weighing dish, and add 3 to 5 grams of sample to the dish. Weigh to the nearest milligram.
- b. Where volatile solvent is the major volatile component: Transfer a portion of the sample to a 20-ml screw cap vial and cap immediately. Weigh the vial to the nearest milligram. Uncap the vial and transfer a 3- to 5-gram portion of the sample to a tared aluminum weighing dish. Recap the vial and reweigh to the nearest milligram. The vial weight loss is the sample weight.

To continue, place the weighing pan in a 130 °C oven for 1 hour. Remove the dish and allow to cool to room temperature in a desiccator. Weigh the pan to the nearest 0.1 mg. Total solids is the weight of material in the aluminum pan after heating divided by the net weight of sample added to the pan originally times 100.

9. Calibration of the Chromatograph

9.1 Preparation of Standards. Prepare a 1 percent by weight (approximate) solution of vinyl chloride in THF or DMAC by bubbling vinyl chloride gas from a cylinder into a tared 125-ml glass-stoppered flask containing THF or DMAC. The weight of vinyl chloride to be added should be calculated prior to this operation, i.e., 1 percent of the weight of THF or DMAC contained in the tared flask. This must be carried out in a laboratory hood. Adjust the vinyl chloride flow from the cylinder so that the vinyl chloride dissolves essentially completely in the THF or DMAC and is not blown to the atmosphere. Take particular care not to volatilize any of the solution. Stopper the flask and swirl the solution to effect complete mixing. Weigh the stoppered flask to nearest 0.1 mg to determine the exact amount of vinyl chloride added.

Pipet 10 ml of the approximately 1 percent solution into a 100-ml glass-stoppered volumetric flask, and add THF or DMAC to fill to the mark. Cap the flask and invert 10 to 20 times. This solution contains approximately 1,000 ppm by weight of vinyl chloride (note the exact concentration).

Pipet 50-, 10-, 5-, 1-, 0.5-, and 0.1-ml aliquots of the approximately 1,000 ppm solution into 10 ml glass stoppered volumetric flasks. Dilute to the mark with THF or DMAC, cap the flasks and invert each 10 to 20 times. These solutions contain approximately 500, 100, 50, 10, 5, and 1 ppm vinyl chloride. Note the exact concentration of each one. These standards are to be kept under refrigeration in stoppered bottles, and must be renewed every 3 months.

9.2 Preparation of Chromatograph Calibration Curve.

Obtain the GC for each of the six final solutions prepared in Section 9.1 by using the procedure in Section 8.3.2. Prepare a chart plotting peak height obtained from the chromatogram of each solution versus the known concentration. Draw a straight line through the points derived by the least squares method.

10. Calculations

10.1 Response Factor. From the calibration curve described in Section 9.2, select the value of C_c that corresponds to H_c for each sample. Compute the response factor, R_f , for each sample as follows:

$$R_f = \frac{C_c}{H_c} \quad \text{Eq. 107A-1}$$

where:

R_f =Chromatograph response factor, ppm/mm.

C_c =Concentration of vinyl chloride in the standard sample, ppm.

H_c =Peak height of the standard sample, mm.

10.2 Residual vinyl chloride monomer concentration (C_{rvc}) or vinyl chloride monomer concentration in resin:

$$C_{rvc} = 10H_s R_f \quad \text{Eq. 107A-2}$$

Where:

C_{rvc} =Concentration of residual vinyl chloride monomer, ppm.

H_s =Peak height of sample, mm.

R_f =Chromatograph response factor.

10.3 Samples containing volatile material, i.e., resin solutions, wet resin, and latexes:

$$C_{rvc} = \frac{H_s R_f (1,000)}{TS} \quad \text{Eq. 107A-3}$$

where:

TS=Total solids in the sample, weight fraction.

10.4 Samples of solvents and in process wastewater:

$$C_{rvc} = \frac{H_s R_f}{0.888} \quad \text{Eq. 107A-4}$$

Where:

0.888=Specific gravity of THF.

11. Bibliography

1. Communication from R. N. Wheeler, Jr.; Union Carbide Corporation. Part 61 National Emissions Standards for Hazardous Air Pollutants appendix B, Method 107—Alternate Method, September 19, 1977.

Method 108—Determination of Particulate and Gaseous Arsenic Emissions

Note: This method does not include all of the specifications (e.g., equipment and supplies) and procedures (e.g., sampling and analytical) essential to its performance. Some material is incorporated by reference from other methods in appendix A to 40 CFR part 60. Therefore, to obtain reliable results, persons using this method should have a thorough knowledge of at least the following additional test methods: Method 1, Method 2, Method 3, Method 5, and Method 12.

1.0 Scope and Application.

1.1 Analytes.

Analyte	CAS No.	Sensitivity
Arsenic compounds as arsenic (As)	7440-38-2	Lower limit 10 µg/ml or less.

1.2 Applicability. This method is applicable for the determination of inorganic As emissions from stationary sources as specified in an applicable subpart of the regulations.

1.3 Data Quality Objectives. Adherence to the requirements of this method will enhance the quality of the data obtained from air pollutant sampling methods.

2.0 Summary of Method

Particulate and gaseous As emissions are withdrawn isokinetically from the source and are collected on a glass mat filter and in water. The collected arsenic is then analyzed by means of atomic absorption spectrophotometry (AAS).

3.0 Definitions.[Reserved]

4.0 Interferences

Analysis for As by flame AAS is sensitive to the chemical composition and to the physical properties (e.g., viscosity, pH) of the sample. The analytical procedure includes a check for matrix effects (Section 11.5).

5.0 Safety

5.1 This method may involve hazardous materials, operations, and equipment. This test method may not address all of the safety problems associated with its use. It is the responsibility of the user to establish appropriate safety and health practices and determine the applicability of regulatory limitations prior to performing this test method.

5.2 Corrosive reagents. The following reagents are hazardous. Personal protective equipment and safe procedures that prevent chemical splashes are recommended. If contact occurs, immediately flush with copious amounts of water for at least 15 minutes. Remove clothing under shower and decontaminate. Treat residual chemical burns as thermal burns.

5.2.1 Hydrochloric Acid (HCl). Highly corrosive liquid with toxic vapors. Vapors are highly irritating to eyes, skin, nose, and lungs, causing severe damage. May cause bronchitis, pneumonia, or edema of lungs. Exposure to concentrations of 0.13 to 0.2 percent can be lethal to humans in a few minutes. Provide ventilation to limit exposure. Reacts with metals, producing hydrogen gas.

5.2.2 Hydrogen Peroxide (H₂O₂). Very harmful to eyes. 30% H₂O₂ can burn skin, nose, and lungs.

5.2.3 Nitric Acid (HNO₃). Highly corrosive to eyes, skin, nose, and lungs. Vapors are highly toxic and can cause bronchitis, pneumonia, or edema of lungs. Reaction to inhalation may be delayed as long as 30 hours and still be fatal. Provide ventilation to limit exposure. Strong oxidizer. Hazardous reaction may occur with organic materials such as solvents.

5.2.4 Sodium Hydroxide (NaOH). Causes severe damage to eyes and skin. Inhalation causes irritation to nose, throat, and lungs. Reacts exothermically with small amounts of water.

6.0 Equipment and Supplies

6.1 Sample Collection. A schematic of the sampling train used in performing this method is shown in Figure 108-1; it is similar to the Method 5 sampling train of 40 CFR part 60, appendix A. The following items are required for sample collection:

6.1.1 Probe Nozzle, Probe Liner, Pitot Tube, Differential Pressure Gauge, Filter Holder, Filter Heating System, Temperature Sensor, Metering System, Barometer, and Gas Density Determination Equipment. Same as Method 5, Sections 6.1.1.1 to 6.1.1.7, 6.1.1.9, 6.1.2, and 6.1.3, respectively.

6.1.2 Impingers. Four impingers connected in series with leak-free ground-glass fittings or any similar leak-free noncontaminating fittings. For the first, third, and fourth impingers, use the Greenburg-Smith design, modified by replacing the tip with a 1.3-cm ID (0.5-in.) glass tube extending to about 1.3 cm (0.5 in.) from the bottom of the flask. For the second impinger, use the Greenburg-Smith design with the standard tip. Modifications (e.g., flexible connections between the impingers, materials other than glass, or flexible vacuum lines to connect the filter holder to the condenser) are subject to the approval of the Administrator.

6.1.3 Temperature Sensor. Place a temperature sensor, capable of measuring temperature to within 1 ° C (2 ° F), at the outlet of the fourth impinger for monitoring purposes.

6.2 Sample Recovery. The following items are required for sample recovery:

6.2.1 Probe-Liner and Probe-Nozzle Brushes, Petri Dishes, Graduated Cylinder and/or Balance, Plastic Storage Containers, and Funnel and Rubber Policeman. Same as Method 5, Sections 6.2.1 and 6.2.4 to 6.2.8, respectively.

6.2.2 Wash Bottles. Polyethylene (2).

6.2.3 Sample Storage Containers. Chemically resistant, polyethylene or polypropylene for glassware washes, 500- or 1000-ml.

6.3 Analysis. The following items are required for analysis:

6.3.1 Spectrophotometer. Equipped with an electrodeless discharge lamp and a background corrector to measure absorbance at 193.7 nanometers (nm). For measuring samples having less than 10 µg As/ml, use a vapor generator accessory or a graphite furnace.

6.3.2 Recorder. To match the output of the spectrophotometer.

6.3.3 Beakers. 150 ml.

6.3.4 Volumetric Flasks. Glass 50-, 100-, 200-, 500-, and 1000-ml; and polypropylene, 50-ml.

6.3.5 Balance. To measure within 0.5 g.

6.3.6 Volumetric Pipets. 1-, 2-, 3-, 5-, 8-, and 10-ml.

6.3.7 Oven.

6.3.8 Hot Plate.

7.0 Reagents and Standards

Unless otherwise indicated, it is intended that all reagents conform to the specifications established by

the Committee on Analytical Reagents of the American Chemical Society, where such specifications are available; otherwise, use the best available grade.

7.1 The following reagents are required for sample collection:

7.1.1 Filters. Same as Method 5, Section 7.1.1, except that the filters need not be unreactive to SO_2 .

7.1.2 Silica Gel, Crushed Ice, and Stopcock Grease. Same as Method 5, Sections 7.1.2, 7.1.4, and 7.1.5, respectively.

7.1.3 Water. Deionized distilled to meet ASTM D 1193-77 or 91 (incorporated by reference-see §61.18), Type 3. When high concentrations of organic matter are not expected to be present, the KMnO_4 test for oxidizable organic matter may be omitted.

7.2 Sample Recovery.

7.2.1 0.1 N NaOH. Dissolve 4.00 g of NaOH in about 500 ml of water in a 1-liter volumetric flask. Then, dilute to exactly 1.0 liter with water.

7.3 Analysis. The following reagents and standards are required for analysis:

7.3.1 Water. Same as Section 7.1.3.

7.3.2 Sodium Hydroxide, 0.1 N. Same as in Section 7.2.1.

7.3.3 Sodium Borohydride (NaBH_4), 5 Percent Weight by Volume (W/V). Dissolve 50.0 g of NaBH_4 in about 500 ml of 0.1 N NaOH in a 1-liter volumetric flask. Then, dilute to exactly 1.0 liter with 0.1 N NaOH.

7.3.4 Hydrochloric Acid, Concentrated.

7.3.5 Potassium Iodide (KI), 30 Percent (W/V). Dissolve 300 g of KI in 500 ml of water in a 1 liter volumetric flask. Then, dilute to exactly 1.0 liter with water.

7.3.6 Nitric Acid, Concentrated.

7.3.7 Nitric Acid, 0.8 N. Dilute 52 ml of concentrated HNO_3 to exactly 1.0 liter with water.

7.3.8 Nitric Acid, 50 Percent by Volume (V/V). Add 50 ml concentrated HNO_3 to 50 ml water.

7.3.9 Stock Arsenic Standard, 1 mg As/ml. Dissolve 1.3203 g of primary standard grade As_2O_3 in 20 ml of 0.1 N NaOH in a 150 ml beaker. Slowly add 30 ml of concentrated HNO_3 . Heat the resulting solution and evaporate just to dryness. Transfer the residue quantitatively to a 1-liter volumetric flask, and dilute to 1.0 liter with water.

7.3.10 Arsenic Working Solution, 1.0 μg As/ml. Pipet exactly 1.0 ml of stock arsenic standard into an acid-cleaned, appropriately labeled 1-liter volumetric flask containing about 500 ml of water and 5 ml of concentrated HNO_3 . Dilute to exactly 1.0 liter with water.

7.3.11 Air. Suitable quality for AAS analysis.

7.3.12 Acetylene. Suitable quality for AAS analysis.

7.3.13 Nickel Nitrate, 5 Percent Ni (W/V). Dissolve 24.780 g of nickel nitrate hexahydrate [$\text{Ni}(\text{NO}_3)_2 \cdot 6\text{H}_2\text{O}$] in water in a 100-ml volumetric flask, and dilute to 100 ml with water.

7.3.14 Nickel Nitrate, 1 Percent Ni (W/V). Pipet 20 ml of 5 percent nickel nitrate solution into a 100-ml volumetric flask, and dilute to exactly 100 ml with water.

7.3.15 Hydrogen Peroxide, 3 Percent by Volume. Pipet 50 ml of 30 percent H₂O₂ into a 500-ml volumetric flask, and dilute to exactly 500 ml with water.

7.3.16 Quality Assurance Audit Samples. When making compliance determinations, and upon availability, audit samples may be obtained from the appropriate EPA regional Office or from the responsible enforcement authority.

Note: The responsible enforcement authority should be notified at least 30 days prior to the test date to allow sufficient time for sample delivery.

8.0 Sample Collection, Preservation, Transport, and Storage

8.1 Pretest Preparation. Follow the general procedure given in Method 5, Section 8.1, except the filter need not be weighed, and the 200 ml of 0.1N NaOH and Container 4 should be tared to within 0.5 g.

8.2 Preliminary Determinations. Follow the general procedure given in Method 5, Section 8.2, except select the nozzle size to maintain isokinetic sampling rates below 28 liters/min (1.0 cfm).

8.3 Preparation of Sampling Train. Follow the general procedure given in Method 5, Section 8.3.

8.4 Leak-Check Procedures. Same as Method 5, Section 8.4.

8.5 Sampling Train Operation. Follow the general procedure given in Method 5, Section 8.5, except maintain isokinetic sampling flow rates below 28 liters/min (1.0 cfm). For each run, record the data required on a data sheet similar to the one shown in Figure 108-2.

8.6 Calculation of Percent Isokinetic. Same as Method 5, Section 8.6.

8.7 Sample Recovery. Same as Method 5, Section 8.7, except that 0.1 N NaOH is used as the cleanup solvent instead of acetone and that the impinger water is treated as follows:

8.7.1 Container Number 4 (Impinger Water). Clean each of the first three impingers and connecting glassware in the following manner:

8.7.1.1 Wipe the impinger ball joints free of silicone grease, and cap the joints.

8.7.1.2 Rotate and agitate each of the first two impingers, using the impinger contents as a rinse solution.

8.7.1.3 Transfer the liquid from the first three impingers to Container Number 4. Remove the outlet ball-joint cap, and drain the contents through this opening. Do not separate the impinger parts (inner and outer tubes) while transferring their contents to the container.

8.7.1.4 Weigh the contents of Container No. 4 to within 0.5 g. Record in the log the weight of liquid along with a notation of any color or film observed in the impinger catch. The weight of liquid is needed along with the silica gel data to calculate the stack gas moisture content.

Note: Measure and record the total amount of 0.1 N NaOH used for rinsing under Sections 8.7.1.5 and 8.7.1.6.

8.7.1.5 Pour approximately 30 ml of 0.1 NaOH into each of the first two impingers, and agitate the impingers. Drain the 0.1 N NaOH through the outlet arm of each impinger into Container Number 4. Repeat this operation a second time; inspect the impingers for any abnormal conditions.

8.7.1.6 Wipe the ball joints of the glassware connecting the impingers and the back half of the filter

holder free of silicone grease, and rinse each piece of glassware twice with 0.1 N NaOH; transfer this rinse into Container Number 4. (DO NOT RINSE or brush the glass-fritted filter support.) Mark the height of the fluid level to determine whether leakage occurs during transport. Label the container to identify clearly its contents.

8.8 Blanks.

8.8.1 Sodium Hydroxide. Save a portion of the 0.1 N NaOH used for cleanup as a blank. Take 200 ml of this solution directly from the wash bottle being used and place it in a plastic sample container labeled "NaOH blank."

8.8.2 Water. Save a sample of the water, and place it in a container labeled "H₂O blank."

8.8.3 Filter. Save two filters from each lot of filters used in sampling. Place these filters in a container labeled "filter blank."

9.0 Quality Control

9.1 Miscellaneous Quality Control Measures.

Section	Quality control measure	Effect
8.4, 10.1	Sampling equipment leak-checks and calibration	Ensures accuracy and precision of sampling measurements.
10.4	Spectrophotometer calibration	Ensures linearity of spectrophotometer response to standards.
11.5	Check for matrix effects	Eliminates matrix effects.
11.6	Audit sample analysis	Evaluates analyst's technique and standards preparation.

9.2 Volume Metering System Checks. Same as Method 5, Section 9.2.

10.0 Calibration and Standardization

Note: Maintain a laboratory log of all calibrations.

10.1 Sampling Equipment. Same as Method 5, Section 10.0.

10.2 Preparation of Standard Solutions.

10.2.1 For the high level procedure, pipet 1, 3, 5, 8, and 10 ml of the 1.0 mg As/ml stock solution into separate 100 ml volumetric flasks, each containing 5 ml of concentrated HNO₃. Dilute to the mark with water.

10.2.2 For the low level vapor generator procedure, pipet 1, 2, 3, and 5 ml of 1.0 µg As/ml standard solution into separate reaction tubes. Dilute to the mark with water.

10.2.3 For the low level graphite furnace procedure, pipet 1, 5, 10 and 15 ml of 1.0 µg As/ml standard solution into separate flasks along with 2 ml of the 5 percent nickel nitrate solution and 10 ml of the 3 percent H₂O₂ solution. Dilute to the mark with water.

10.3 Calibration Curve. Analyze a 0.8 N HNO₃ blank and each standard solution according to the procedures outlined in section 11.4.1. Repeat this procedure on each standard solution until two

consecutive peaks agree within 3 percent of their average value. Subtract the average peak height (or peak area) of the blank—which must be less than 2 percent of recorder full scale—from the averaged peak height of each standard solution. If the blank absorbance is greater than 2 percent of full-scale, the probable cause is As contamination of a reagent or carry-over of As from a previous sample. Prepare the calibration curve by plotting the corrected peak height of each standard solution versus the corresponding final total As weight in the solution.

10.4 Spectrophotometer Calibration Quality Control. Calculate the least squares slope of the calibration curve. The line must pass through the origin or through a point no further from the origin than ± 2 percent of the recorder full scale. Multiply the corrected peak height by the reciprocal of the least squares slope to determine the distance each calibration point lies from the theoretical calibration line. The difference between the calculated concentration values and the actual concentrations (e.g., 1, 3, 5, 8, and 10 mg As for the high-level procedure) must be less than 7 percent for all standards.

Note: For instruments equipped with direct concentration readout devices, preparation of a standard curve will not be necessary. In all cases, follow calibration and operational procedures in the manufacturers' instruction manual.

11.0 Analytical Procedure

11.1 Sample Loss Check. Prior to analysis, check the liquid level in Containers Number 2 and Number 4. Note on the analytical data sheet whether leakage occurred during transport. If a noticeable amount of leakage occurred, either void the sample or take steps, subject to the approval of the Administrator, to adjust the final results.

11.2 Sample Preparation.

11.2.1 Container Number 1 (Filter). Place the filter and loose particulate matter in a 150 ml beaker. Also, add the filtered solid material from Container Number 2 (see Section 11.2.2). Add 50 ml of 0.1 N NaOH. Then stir and warm on a hot plate at low heat (do not boil) for about 15 minutes. Add 10 ml of concentrated HNO₃, bring to a boil, then simmer for about 15 minutes. Filter the solution through a glass fiber filter. Wash with hot water, and catch the filtrate in a clean 150 ml beaker. Boil the filtrate, and evaporate to dryness. Cool, add 5 ml of 50 percent HNO₃, and then warm and stir. Allow to cool. Transfer to a 50-ml volumetric flask, dilute to volume with water, and mix well.

11.2.2 Container Number 2 (Probe Wash).

11.2.2.1 Filter (using a glass fiber filter) the contents of Container Number 2 into a 200 ml volumetric flask. Combine the filtered (solid) material with the contents of Container Number 1 (Filter).

11.2.2.2 Dilute the filtrate to exactly 200 ml with water. Then pipet 50 ml into a 150 ml beaker. Add 10 ml of concentrated HNO₃, bring to a boil, and evaporate to dryness. Allow to cool, add 5 ml of 50 percent HNO₃, and then warm and stir. Allow the solution to cool, transfer to a 50-ml volumetric flask, dilute to volume with water, and mix well.

11.2.3 Container Number 4 (Impinger Solution). Transfer the contents of Container Number 4 to a 500 ml volumetric flask, and dilute to exactly 500-ml with water. Pipet 50 ml of the solution into a 150-ml beaker. Add 10 ml of concentrated HNO₃, bring to a boil, and evaporate to dryness. Allow to cool, add 5 ml of 50 percent HNO₃, and then warm and stir. Allow the solution to cool, transfer to a 50-ml volumetric flask, dilute to volume with water, and mix well.

11.2.4 Filter Blank. Cut each filter into strips, and treat each filter individually as directed in Section 11.2.1, beginning with the sentence, "Add 50 ml of 0.1 N NaOH."

11.2.5 Sodium Hydroxide and Water Blanks. Treat separately 50 ml of 0.1 N NaOH and 50 ml water, as directed under Section 11.2.3, beginning with the sentence, "Pipet 50 ml of the solution into a 150-ml beaker."

11.3 Spectrophotometer Preparation. Turn on the power; set the wavelength, slit width, and lamp

current. Adjust the background corrector as instructed by the manufacturer's manual for the particular atomic absorption spectrophotometer. Adjust the burner and flame characteristics as necessary.

11.4 Analysis. Calibrate the analytical equipment and develop a calibration curve as outlined in Sections 10.2 through 10.4.

11.4.1 Arsenic Samples. Analyze an appropriately sized aliquot of each diluted sample (from Sections 11.2.1 through 11.2.3) until two consecutive peak heights agree within 3 percent of their average value. If applicable, follow the procedures outlined in Section 11.4.1.1. If the sample concentration falls outside the range of the calibration curve, make an appropriate dilution with 0.8 N HNO₃ so that the final concentration falls within the range of the curve. Using the calibration curve, determine the arsenic concentration in each sample fraction.

Note: Because instruments vary between manufacturers, no detailed operating instructions will be given here. Instead, the instrument manufacturer's detailed operating instructions should be followed.

11.4.1.1 Arsenic Determination at Low Concentration. The lower limit of flame AAS is 10 µg As/ml. If the arsenic concentration of any sample is at a lower level, use the graphite furnace or vapor generator which is available as an accessory component. Flame, graphite furnace, or vapor generators may be used for samples whose concentrations are between 10 and 30 µg/ml. Follow the manufacturer's instructions in the use of such equipment.

11.4.1.1.1 Vapor Generator Procedure. Place a sample containing between 0 and 5 µg of arsenic in the reaction tube, and dilute to 15 ml with water. Since there is some trial and error involved in this procedure, it may be necessary to screen the samples by conventional atomic absorption until an approximate concentration is determined. After determining the approximate concentration, adjust the volume of the sample accordingly. Pipet 15 ml of concentrated HCl into each tube. Add 1 ml of 30 percent KI solution. Place the reaction tube into a 50 °C (120 °F) water bath for 5 minutes. Cool to room temperature. Connect the reaction tube to the vapor generator assembly. When the instrument response has returned to baseline, inject 5.0 ml of 5 percent NaBH₄, and integrate the resulting spectrophotometer signal over a 30-second time period.

11.4.1.1.2 Graphite Furnace Procedure. Dilute the digested sample so that a 5 ml aliquot contains less than 1.5 µg of arsenic. Pipet 5 ml of this digested solution into a 10-ml volumetric flask. Add 1 ml of the 1 percent nickel nitrate solution, 0.5 ml of 50 percent HNO₃, and 1 ml of the 3 percent hydrogen peroxide and dilute to 10 ml with water. The sample is now ready for analysis.

11.4.1.2 Run a blank (0.8 N HNO₃) and standard at least after every five samples to check the spectrophotometer calibration. The peak height of the blank must pass through a point no further from the origin than ±2 percent of the recorder full scale. The difference between the measured concentration of the standard (the product of the corrected average peak height and the reciprocal of the least squares slope) and the actual concentration of the standard must be less than 7 percent, or recalibration of the analyzer is required.

11.4.1.3 Determine the arsenic concentration in the filter blank (i.e., the average of the two blank values from each lot).

11.4.2 Container Number 3 (Silica Gel). This step may be conducted in the field. Weigh the spent silica gel (or silica gel plus impinger) to the nearest 0.5 g; record this weight.

11.5 Check for matrix effects on the arsenic results. Same as Method 12, Section 11.5.

11.6 Audit Sample Analysis.

11.6.1 When the method is used to analyze samples to demonstrate compliance with a source emission regulation, a set of EPA audit samples must be analyzed, subject to availability.

11.6.2 Concurrently analyze the audit samples and the compliance samples in the same manner to

evaluate the technique of the analyst and the standards preparation.

Note: It is recommended that known quality control samples be analyzed prior to the compliance and audit sample analyses to optimize the system accuracy and precision. These quality control samples may be obtained by contacting the appropriate EPA regional Office or the responsible enforcement authority.

11.6.3 The same analyst, analytical reagents, and analytical system shall be used for the compliance samples and the EPA audit samples. If this condition is met, duplicate auditing of subsequent compliance analyses for the same enforcement agency within a 30-day period is waived. An audit sample set may not be used to validate different sets of compliance samples under the jurisdiction of separate enforcement agencies, unless prior arrangements have been made with both enforcement agencies.

11.7 Audit Sample Results.

11.7.1 Calculate the audit sample concentrations in g/m^3 and submit results using the instructions provided with the audit samples.

11.7.2 Report the results of the audit samples and the compliance determination samples along with their identification numbers, and the analyst's name to the responsible enforcement authority. Include this information with reports of any subsequent compliance analyses for the same enforcement authority during the 30-day period.

11.7.3 The concentrations of the audit samples obtained by the analyst shall agree within 10 percent of the actual concentrations. If the 10 percent specification is not met, reanalyze the compliance and audit samples, and include initial and reanalysis values in the test report.

11.7.4 Failure to meet the 10 percent specification may require retests until the audit problems are resolved. However, if the audit results do not affect the compliance or noncompliance status of the affected facility, the Administrator may waive the reanalysis requirement, further audits, or retests and accept the results of the compliance test. While steps are being taken to resolve audit analysis problems, the Administrator may also choose to use the data to determine the compliance or noncompliance status of the affected facility.

12.0 Data Analysis and Calculations

12.1 Nomenclature.

B_{ws} = Water in the gas stream, proportion by volume.

C_a = Concentration of arsenic as read from the standard curve, $\mu\text{g}/\text{ml}$.

C_c = Actual audit concentration, g/m^3 .

C_d = Determined audit concentration, g/m^3 .

C_s = Arsenic concentration in stack gas, dry basis, converted to standard conditions, g/dsm^3 (gr/dscf).

E_a = Arsenic mass emission rate, g/hr (lb/hr).

F_d = Dilution factor (equals 1 if the sample has not been diluted).

I = Percent of isokinetic sampling.

m_{bi} = Total mass of all four impingers and contents before sampling, g.

m_{fi} = Total mass of all four impingers and contents after sampling, g.

m_n = Total mass of arsenic collected in a specific part of the sampling train, μg .

m_t = Total mass of arsenic collected in the sampling train, μg .

T_m = Absolute average dry gas meter temperature (see Figure 108–2), °K (°R).

V_m = Volume of gas sample as measured by the dry gas meter, dry basis, m^3 (ft^3).

$V_m(\text{std})$ = Volume of gas sample as measured by the dry gas meter, corrected to standard conditions, m^3 (ft^3).

V_n = Volume of solution in which the arsenic is contained, ml.

$V_w(\text{std})$ = Volume of water vapor collected in the sampling train, corrected to standard conditions, m^3 (ft^3).

ΔH = Average pressure differential across the orifice meter (see Figure 108–2), mm H_2O (in. H_2O).

12.2 Average Dry Gas Meter Temperatures (T_m) and Average Orifice Pressure Drop (ΔH). See data sheet (Figure 108–2).

12.3 Dry Gas Volume. Using data from this test, calculate $V_m(\text{std})$ according to the procedures outlined in Method 5, Section 12.3.

12.4 Volume of Water Vapor.

$$V_{w(\text{std})} = K_2 (m_{f1} - m_{i1}) \quad \text{Eq. 108-1}$$

Where:

$K_2 = 0.001334 \text{ m}^3/\text{g}$ for metric units.

$= 0.047012 \text{ ft}^3/\text{g}$ for English units.

12.5 Moisture Content.

$$B_{ws} = \frac{V_{w(\text{std})}}{V_{m(\text{std})} + V_{w(\text{std})}} \quad \text{Eq. 108-2}$$

12.6 Amount of Arsenic Collected.

12.6.1 Calculate the amount of arsenic collected in each part of the sampling train, as follows:

$$m_n = C_a F_d V_n \quad \text{Eq. 108-3}$$

12.6.2 Calculate the total amount of arsenic collected in the sampling train as follows:

$$m_t = m_{\text{filters}} + m_{\text{probe}} + m_{\text{impingers}} - m_{\text{filter blank}} - m_{\text{NaOH blank}} - m_{\text{water blank}} \quad \text{Eq. 108-4}$$

12.7 Calculate the arsenic concentration in the stack gas (dry basis, adjusted to standard conditions) as follows:

$$C_s = K_3 \left(m_t / V_{m(\text{std})} \right) \quad \text{Eq. 108-5}$$

Where:

$$K_3 = 10^{-6} \text{g}/\mu\text{g for metric units}$$

$$= 1.54 \times 10^{-5} \text{gr}/\mu\text{g for English units}$$

12.8 Stack Gas Velocity and Volumetric Flow Rate. Calculate the average stack gas velocity and volumetric flow rate using data obtained in this method and the equations in Sections 12.2 and 12.3 of Method 2.

12.9 Pollutant Mass Rate. Calculate the arsenic mass emission rate as follows:

$$E_a = C_s Q_{sd} \quad \text{Eq. 108-6}$$

12.10 Isokinetic Variation. Same as Method 5, Section 12.11.

13.0 Method Performance

13.1 Sensitivity. The lower limit of flame AAS 10 $\mu\text{g As/ml}$. The analytical procedure includes provisions for the use of a graphite furnace or vapor generator for samples with a lower arsenic concentration.

14.0 Pollution Prevention. [Reserved]

15.0 Waste Management. [Reserved]

16.0 References.

Same as References 1 through 9 of Method 5, Section 17.0, with the addition of the following:

1. Perkin Elmer Corporation. Analytical Methods for Atomic Absorption Spectrophotometry. 303–0152. Norwalk, Connecticut. September 1976. pp. 5–6.

2. Standard Specification for Reagent Water. In: Annual Book of American Society for Testing and Materials Standards. Part 31: Water, Atmospheric Analysis. American Society for Testing and Materials. Philadelphia, PA. 1974. pp. 40–42.

3. Stack Sampling Safety Manual (Draft). U.S. Environmental Protection Agency, Office of Air Quality Planning and Standard, Research Triangle Park, NC. September 1978.

17.0 Tables, Diagrams, Flowcharts, and Validation Data

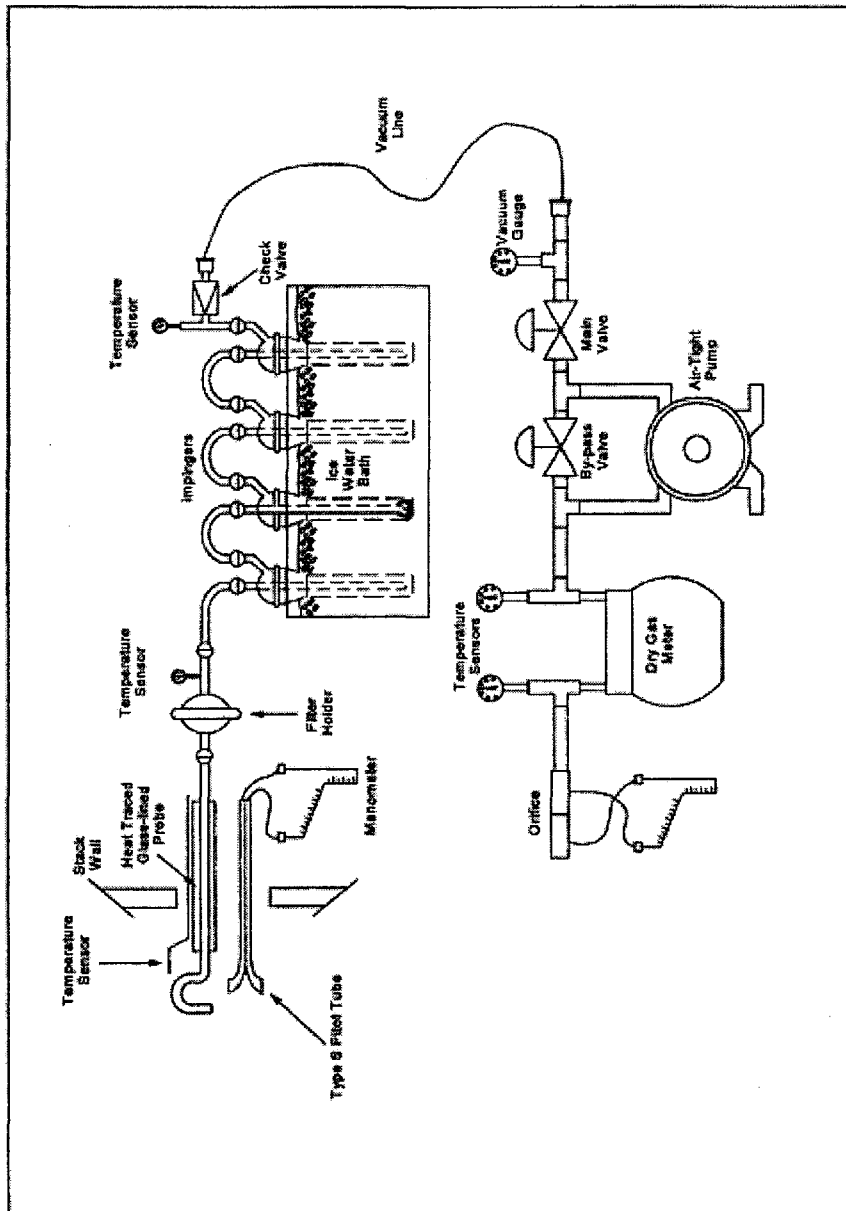

Figure 108-1. Arsenic Sampling Train

[View or download PDF](#)

Analyte	CAS No.	Sensitivity
Arsenic compounds as arsenic (As)	7440-38-2	Lower limit 10 µg/ml or less.

1.2 Applicability. This method applies to the determination of inorganic As content of process ore and reverberatory matte samples from nonferrous smelters and other sources as specified in an applicable subpart of the regulations.

1.3 Data Quality Objectives. Adherence to the requirements of this method will enhance the quality of the data obtained from air pollutant sampling methods.

2.0 Summary of Method

Arsenic bound in ore samples is liberated by acid digestion and analyzed by flame atomic absorption spectrophotometry (AAS).

3.0 Definitions[Reserved]

4.0 Interferences

Analysis for As by flame AAS is sensitive to the chemical composition and to the physical properties (e.g., viscosity, pH) of the sample. The analytical procedure includes a check for matrix effects (section 11.5).

5.0 Safety

5.1 Disclaimer. This method may involve hazardous materials, operations, and equipment. This test method may not address all of the safety problems associated with its use. It is the responsibility of the user to establish appropriate safety and health practices and determine the applicability of regulatory limitations prior to performing this test method.

5.2 Corrosive Reagents. The following reagents are hazardous. Personal protective equipment and safe procedures that prevent chemical splashes are recommended. If contact occurs, immediately flush with copious amounts of water for at least 15 minutes. Remove clothing under shower and decontaminate. Treat residual chemical burns as thermal burns.

5.2.1 Hydrochloric Acid (HCl). Highly corrosive liquid with toxic vapors. Vapors are highly irritating to eyes, skin, nose, and lungs, causing severe damage. May cause bronchitis, pneumonia, or edema of lungs. Exposure to concentrations of 0.13 to 0.2 percent can be lethal to humans in a few minutes. Provide ventilation to limit exposure. Reacts with metals, producing hydrogen gas.

5.2.2 Hydrofluoric Acid (HF). Highly corrosive to eyes, skin, nose, throat, and lungs. Reaction to exposure may be delayed by 24 hours or more. Provide ventilation to limit exposure.

5.2.3 Hydrogen Peroxide (H₂O₂). Very harmful to eyes. 30% H₂O₂ can burn skin, nose, and lungs.

5.2.4 Nitric Acid (HNO₃). Highly corrosive to eyes, skin, nose, and lungs. Vapors are highly toxic and can cause bronchitis, pneumonia, or edema of lungs. Reaction to inhalation may be delayed as long as 30 hours and still be fatal. Provide ventilation to limit exposure. Strong oxidizer. Hazardous reaction may occur with organic materials such as solvents.

5.2.5 Sodium Hydroxide (NaOH). Causes severe damage to eyes and skin. Inhalation causes irritation to nose, throat, and lungs. Reacts exothermically with limited amounts of water.

6.0 Equipment and Supplies

6.1 Sample Collection and Preparation. The following items are required for sample collection and preparation:

6.1.1 Parr Acid Digestion Bomb. Stainless steel with vapor-tight Teflon cup and cover.

6.1.2 Volumetric Pipets. 2- and 5-ml sizes.

6.1.3 Volumetric Flask. 50-ml polypropylene with screw caps, (one needed per standard).

6.1.4 Funnel. Polyethylene or polypropylene.

6.1.5 Oven. Capable of maintaining a temperature of approximately 105 °C (221 °F).

6.1.6 Analytical Balance. To measure to within 0.1 mg.

6.2 Analysis. The following items are required for analysis:

6.2.1 Spectrophotometer and Recorder. Equipped with an electrodeless discharge lamp and a background corrector to measure absorbance at 193.7 nm. For measuring samples having less than 10 µg As/ml, use a graphite furnace or vapor generator accessory. The recorder shall match the output of the spectrophotometer.

6.2.2 Volumetric Flasks. Class A, 50-ml (one needed per sample and blank), 500-ml, and 1-liter.

6.2.3 Volumetric Pipets. Class A, 1-, 5-, 10-, and 25-ml sizes.

7.0 Reagents and Standards.

Unless otherwise indicated, it is intended that all reagents conform to the specifications established by the Committee on Analytical Reagents of the American Chemical Society, where such specifications are available; otherwise, use the best available grade.

7.1 Sample Collection and Preparation. The following reagents are required for sample collection and preparation:

7.1.1 Water. Deionized distilled to meet ASTM D 1193–77 or 91 Type 3 (incorporated by reference—See §61.18). When high concentrations of organic matter are not expected to be present, the KMnO_4 test for oxidizable organic matter may be omitted. Use in all dilutions requiring water.

7.1.2 Nitric Acid Concentrated.

7.1.3 Nitric Acid, 0.5 N. In a 1-liter volumetric flask containing water, add 32 ml of concentrated HNO_3 and dilute to volume with water.

7.1.4 Hydrofluoric Acid, Concentrated.

7.1.5 Potassium Chloride (KCl) Solution, 10 percent weight by volume (W/V). Dissolve 10 g KCl in water, add 3 ml concentrated HNO_3 , and dilute to 100 ml.

7.1.6 Filter. Teflon filters, 3-micron porosity, 47-mm size. (Available from Millipore Co., type FS, Catalog Number FSLW04700.)

7.1.7 Sodium Borohydride (NaBH_4), 5 Percent (W/V). Dissolve 50.0 g of NaBH_4 in about 500 ml of 0.1 N NaOH in a 1-liter volumetric flask. Then, dilute to exactly 1.0 liter with 0.1 N NaOH.

7.1.8 Nickel Nitrate, 5 Percent Ni (W/V). Dissolve 24.780 g of nickel nitrate hexahydrate [$\text{Ni}(\text{NO}_3)_2 \cdot 6\text{H}_2\text{O}$] in water in a 100-ml volumetric flask, and dilute to 100 ml with water.

7.1.9 Nickel Nitrate, 1 Percent Ni (W/V). Pipet 20 ml of 5 percent nickel nitrate solution into a 100-ml

volumetric flask, and dilute to 100 ml with water.

7.2 Analysis. The following reagents and standards are required for analysis:

7.2.1 Water. Same as in Section 7.1.1.

7.2.2 Sodium Hydroxide, 0.1 N. Dissolve 2.00 g of NaOH in water in a 500-ml volumetric flask. Dilute to volume with water.

7.2.3 Nitric Acid, 0.5 N. Same as in Section 7.1.3.

7.2.4 Potassium Chloride Solution, 10 percent. Same as in Section 7.1.5.

7.2.5 Hydrochloric Acid, Concentrated.

7.2.6 Potassium Iodide (KI), 30 Percent (W/V). Dissolve 300 g of KI in about 500 ml of water in a 1-liter volumetric flask. Then, dilute to exactly 1.0 liter with water.

7.2.7 Hydrogen Peroxide, 3 Percent by Volume. Pipet 50 ml of 30 percent H₂O₂ into a 500-ml volumetric flask, and dilute to exactly 500 ml with water.

7.2.8 Stock Arsenic Standard, 1 mg As/ml. Dissolve 1.3203 g of primary grade As₂O₃ in 20 ml of 0.1 N NaOH. Slowly add 30 ml of concentrated HNO₃, and heat in an oven at 105 °C (221 °F) for 2 hours. Allow to cool, and dilute to 1 liter with deionized distilled water.

7.2.9 Nitrous Oxide. Suitable quality for AAS analysis.

7.2.10 Acetylene. Suitable quality for AAS analysis.

7.2.11 Quality Assurance Audit Samples. When making compliance determinations, and upon availability, audit samples may be obtained from the appropriate EPA regional Office or from the responsible enforcement authority.

Note: The responsible enforcement authority should be notified at least 30 days prior to the test date to allow sufficient time for sample delivery.

8.0 Sample Collection, Preservation, Transport, and Storage

8.1 Sample Collection. A sample that is representative of the ore lot to be tested must be taken prior to analysis. (A portion of the samples routinely collected for metals analysis may be used provided the sample is representative of the ore being tested.)

8.2 Sample Preparation. The sample must be ground into a finely pulverized state.

9.0 Quality Control

Section	Quality control measure	Effect
10.2	Spectrophotometer calibration	Ensure linearity of spectrophotometer response to standards.
11.5	Check for matrix effects	Eliminate matrix effects
11.6	Audit sample analysis	Evaluate analyst's technique and standards preparation.

10.0 Calibration and Standardizations

Note: Maintain a laboratory log of all calibrations.

10.1 Preparation of Standard Solutions. Pipet 1, 5, 10, and 25 ml of the stock As solution into separate 100-ml volumetric flasks. Add 10 ml KCl solution and dilute to the mark with 0.5 N HNO₃. This will give standard concentrations of 10, 50, 100, and 250 µg As/ml. For low-level arsenic samples that require the use of a graphite furnace or vapor generator, follow the procedures in Section 11.3:1. Dilute 10 ml of KCl solution to 100 ml with 0.5 N HNO₃ and use as a reagent blank.

10.2 Calibration Curve. Analyze the reagent blank and each standard solution according to the procedures outlined in Section 11.3. Repeat this procedure on each standard solution until two consecutive peaks agree within 3 percent of their average value. Subtract the average peak height (or peak area) of the blank—which must be less than 2 percent of recorder full scale—from the averaged peak heights of each standard solution. If the blank absorbance is greater than 2 percent of full-scale, the probable cause is Hg contamination of a reagent or carry-over of As from a previous sample. Prepare the calibration curve by plotting the corrected peak height of each standard solution versus the corresponding final total As weight in the solution.

10.3 Spectrophotometer Calibration Quality Control. Calculate the least squares slope of the calibration curve. The line must pass through the origin or through a point no further from the origin than ±2 percent of the recorder full scale. Multiply the corrected peak height by the reciprocal of the least squares slope to determine the distance each calibration point lies from the theoretical calibration line. The difference between the calculated concentration values and the actual concentrations must be less than 7 percent for all standards.

Note: For instruments equipped with direct concentration readout devices, preparation of a standard curve will not be necessary. In all cases, follow calibration and operational procedures in the manufacturer's instruction manual.

11.0 Analytical Procedure

11.1 Sample Preparation. Weigh 50 to 500 mg of finely pulverized sample to the nearest 0.1 mg. Transfer the sample into the Teflon cup of the digestion bomb, and add 2 ml each of concentrated HNO₃ and HF. Seal the bomb immediately to prevent the loss of any volatile arsenic compounds that may form. Heat in an oven at 105 °C (221 °F) for 2 hours. Remove the bomb from the oven and allow to cool. Using a Teflon filter, quantitatively filter the digested sample into a 50-ml polypropylene volumetric flask. Rinse the bomb three times with small portions of 0.5 N HNO₃, and filter the rinses into the flask. Add 5 ml of KCl solution to the flask, and dilute to 50 ml with 0.5 N HNO₃.

11.2 Spectrophotometer Preparation.

11.2.1 Turn on the power; set the wavelength, slit width, and lamp current. Adjust the background corrector as instructed by the manufacturer's manual for the particular atomic absorption spectrophotometer. Adjust the burner and flame characteristics as necessary.

11.2.2 Develop a spectrophotometer calibration curve as outlined in Sections 10.2 and 10.3.

11.3 Arsenic Determination. Analyze an appropriately sized aliquot of each diluted sample (from Section 11.1) until two consecutive peak heights agree within 3 percent of their average value. If applicable, follow the procedures outlined in Section 11.3.1. If the sample concentration falls outside the range of the calibration curve, make an appropriate dilution with 0.5 N HNO₃ so that the final concentration falls within the range of the curve. Using the calibration curve, determine the As concentration in each sample.

Note: Because instruments vary between manufacturers, no detailed operating instructions will be given here. Instead, the instrument manufacturer's detailed operating instructions should be followed.

11.3.1 Arsenic Determination at Low Concentration. The lower limit of flame AAS is 10 µg As/ml. If the arsenic concentration of any sample is at a lower level, use the vapor generator or graphite furnace which is available as an accessory component. Flame, graphite furnace, or vapor generators may be used for samples whose concentrations are between 10 and 30 µg/ml. Follow the manufacturer's instructions in the use of such equipment.

11.3.1.1 Vapor Generator Procedure. Place a sample containing between 0 and 5 µg of arsenic in the reaction tube, and dilute to 15 ml with water. Since there is some trial and error involved in this procedure, it may be necessary to screen the samples by conventional AAS until an approximate concentration is determined. After determining the approximate concentration, adjust the volume of the sample accordingly. Pipet 15 ml of concentrated HCl into each tube. Add 1 ml of 30 percent KI solution. Place the reaction tube into a 50 °C (120 °F) water bath for 5 minutes. Cool to room temperature. Connect the reaction tube to the vapor generator assembly. When the instrument response has returned to baseline, inject 5.0 ml of 5 percent NaBH₄ and integrate the resulting spectrophotometer signal over a 30-second time period.

11.3.1.2 Graphite Furnace Procedure. Pipet 5 ml of the digested solution into a 10-ml volumetric flask. Add 1 ml of the 1 percent nickel nitrate solution, 0.5 ml of 50 percent HNO₃, and 1 ml of the 3 percent H₂O₂, and dilute to 10 ml with water. The sample is now ready to inject in the furnace for analysis.

11.4 Run a blank and standard at least after every five samples to check the spectrophotometer calibration. The peak height of the blank must pass through a point no further from the origin than ±2 percent of the recorder full scale. The difference between the measured concentration of the standard (the product of the corrected average peak height and the reciprocal of the least squares slope) and the actual concentration of the standard must be less than 7 percent, or recalibration of the analyzer is required.

11.5 Mandatory Check for Matrix Effects on the Arsenic Results. Same as Method 12, Section 11.5.

11.6 Audit Sample Analysis.

11.6.1 When the method is used to analyze samples to demonstrate compliance with a source emission regulation, a set of EPA audit samples must be analyzed, subject to availability.

11.6.2 Concurrently analyze the audit samples and the compliance samples in the same manner to evaluate the technique of the analyst and the standards preparation.

Note: It is recommended that known quality control samples be analyzed prior to the compliance and audit sample analyses to optimize the system accuracy and precision. These quality control samples may be obtained by contacting the appropriate EPA regional Office or the responsible enforcement authority.

11.6.3 The same analyst, analytical reagents, and analytical system shall be used for the compliance samples and the EPA audit samples. If this condition is met, duplicate auditing of subsequent compliance analyses for the same enforcement agency within a 30-day period is waived. An audit sample set may not be used to validate different sets of compliance samples under the jurisdiction of separate enforcement agencies, unless prior arrangements have been made with both enforcement agencies.

11.7 Audit Sample Results.

11.7.1 Calculate the audit sample concentrations in g/m³ and submit results using the instructions provided with the audit samples.

11.7.2 Report the results of the audit samples and the compliance determination samples along with their identification numbers, and the analyst's name to the responsible enforcement authority. Include this information with reports of any subsequent compliance analyses for the same enforcement authority during the 30-day period.

11.7.3 The concentrations of the audit samples obtained by the analyst shall agree within 10 percent of the actual concentrations. If the 10 percent specification is not met, reanalyze the compliance and audit samples, and include initial and reanalysis values in the test report.

11.7.4 Failure to meet the 10 percent specification may require retests until the audit problems are resolved. However, if the audit results do not affect the compliance or noncompliance status of the affected facility, the Administrator may waive the reanalysis requirement, further audits, or retests and accept the results of the compliance test. While steps are being taken to resolve audit analysis problems, the Administrator may also choose to use the data to determine the compliance or noncompliance status of the affected facility.

12.0 Data Analysis and Calculations

12.1 Calculate the percent arsenic in the ore sample as follows:

$$\% \text{ As} = \frac{5C_a F_d}{W} \quad \text{Eq. 108A-1}$$

Where:

C_a = Concentration of As as read from the standard curve, $\mu\text{g/ml}$.

F_d = Dilution factor (equals to 1 if the sample has not been diluted).

W = Weight of ore sample analyzed, mg.

5 = (50 ml sample * 100)/(10³ $\mu\text{g/mg}$).

13.0 Method Performance

13.1 Sensitivity. The lower limit of flame AAS is 10 $\mu\text{g As/ml}$. The analytical procedure includes provisions for the use of a graphite furnace or vapor generator for samples with a lower arsenic concentration.

14.0 Pollution Prevention.[Reserved]

15.0 Waste Management.[Reserved]

16.0 References

Same as References 1 through 9 of Section 17.0 of Method 5, with the addition of the following:

1. Perkin Elmer Corporation. Analytical Methods of Atomic Absorption Spectrophotometry. 303–0152. Norwalk, Connecticut. September 1976. pp 5–6.
2. Ringwald, D. Arsenic Determination on Process Materials from ASARCO's Copper Smelter in Tacoma, Washington. Unpublished Report. Prepared for Emission Measurement Branch, Emission Standards and Engineering Division, U.S. Environmental Protection Agency, Research Triangle Park, North Carolina. August 1980. 35 pp.
3. Stack Sampling Safety Manual (Draft). U.S. Environmental Protection Agency, Office of Air Quality Planning and Standard, Research Triangle Park, NC. September 1978.

17.0 Tables, Diagrams, Flowcharts, and Validation Data.[Reserved]

Method 108B—Determination of Arsenic Content in Ore Samples From Nonferrous Smelters

Note: This method does not include all of the specifications (e.g., equipment and supplies) and procedures (e.g., sampling and analytical) essential to its performance. Some material is incorporated by reference from other methods in this appendix and in appendix A to 40 CFR part 60. Therefore, to obtain reliable results, persons using this method should have a thorough knowledge of at least the following additional test methods: Method 12 and Method 108A.

1.0 Scope and Application

1.1 Analytes.

Analyte	CAS No.	Sensitivity
Arsenic compounds as arsenic (As)	7440-38-2	Lower limit 10 µg/ml.

1.2 Applicability. This method applies to the determination of inorganic As content of process ore and reverberatory matte samples from nonferrous smelters and other sources as specified in an applicable subpart of the regulations. Samples resulting in an analytical concentration greater than 10 µg As/ml may be analyzed by this method. For lower level arsenic samples, Method 108C should be used.

1.3 Data Quality Objectives. Adherence to the requirements of this method will enhance the quality of the data obtained from air pollutant sampling methods.

2.0 Summary of Method

Arsenic bound in ore samples is liberated by acid digestion and analyzed by flame atomic absorption spectrophotometry (AAS).

3.0 Definitions[Reserved]

4.0 Interferences

Analysis for As by flame AAS is sensitive to the chemical composition and to the physical properties (e.g., viscosity, pH) of the sample. The analytical procedure includes a check for matrix effects (Section 11.4).

5.0 Safety

5.1 Disclaimer. This method may involve hazardous materials, operations, and equipment. This test method may not address all of the safety problems associated with its use. It is the responsibility of the user to establish appropriate safety and health practices and determine the applicability of regulatory limitations prior to performing this test method.

5.2 Corrosive Reagents. The following reagents are hazardous. Personal protective equipment and safe procedures that prevent chemical splashes are recommended. If contact occurs, immediately flush with copious amounts of water for at least 15 minutes. Remove clothing under shower and decontaminate. Treat residual chemical burns as thermal burns.

5.2.1 Hydrochloric acid (HCl). Highly corrosive liquid with toxic vapors. Vapors are highly irritating to eyes, skin, nose, and lungs, causing severe damage. May cause bronchitis, pneumonia, or edema of lungs. Exposure to concentrations of 0.13 to 0.2 percent can be lethal to humans in a few minutes. Provide ventilation to limit exposure. Reacts with metals, producing hydrogen gas.

5.2.2 Hydrofluoric Acid (HF). Highly corrosive to eyes, skin, nose, throat, and lungs. Reaction to exposure may be delayed by 24 hours or more. Provide ventilation to limit exposure.

5.2.3 Nitric Acid (HNO₃). Highly corrosive to eyes, skin, nose, and lungs. Vapors are highly toxic and can cause bronchitis, pneumonia, or edema of lungs. Reaction to inhalation may be delayed as long as

30 hours and still be fatal. Provide ventilation to limit exposure. Strong oxidizer. Hazardous reaction may occur with organic materials such as solvents.

5.2.4 Perchloric Acid (HClO_4). Corrosive to eyes, skin, nose, and throat. Provide ventilation to limit exposure. Very strong oxidizer. Keep separate from water and oxidizable materials to prevent vigorous evolution of heat, spontaneous combustion, or explosion. Heat solutions containing HClO_4 only in hoods specifically designed for HClO_4 .

6.0 *Equipment and Supplies*

6.1 Sample Preparation. The following items are required for sample preparation:

6.1.1 Teflon Beakers. 150-ml.

6.1.2 Graduated Pipets. 5-ml disposable.

6.1.3 Graduated Cylinder. 50-ml.

6.1.4 Volumetric Flask. 100-ml.

6.1.5 Analytical Balance. To measure within 0.1 mg.

6.1.6 Hot Plate.

6.1.7 Perchloric Acid Fume Hood.

6.2 Analysis. The following items are required for analysis:

6.2.1 Spectrophotometer. Equipped with an electrodeless discharge lamp and a background corrector to measure absorbance at 193.7 nm.

6.2.2 Beaker and Watch Glass. 400-ml.

6.2.3 Volumetric Flask. 1-liter.

6.2.4 Volumetric Pipets. 1-, 5-, 10-, and 25-ml.

7.0 *Reagents and Standards*

Unless otherwise indicated, it is intended that all reagents conform to the specifications established by the Committee on Analytical Reagents of the American Chemical Society, where such specifications are available; otherwise, use the best available grade.

7.1 Sample Preparation. The following reagents are required for sample preparation:

7.1.1 Water. Deionized distilled to meet ASTM D 1193-77 or 91 Type 3 (incorporated by reference—see §61.18).

7.1.2 Nitric Acid, Concentrated.

7.1.3 Hydrofluoric Acid, Concentrated.

7.1.4 Perchloric Acid, 70 Percent.

7.1.5 Hydrochloric Acid, Concentrated.

7.2 Analysis. The following reagents and standards are required for analysis:

7.2.1 Water. Same as in Section 7.1.1.

7.2.2 Stock Arsenic Standard, 1.0 mg As/ml. Dissolve 1.3203 g of primary grade As_2O_3 [dried at 105 °C (221 °F)] in a 400-ml beaker with 10 ml of HNO_3 and 5 ml of HCl. Cover with a watch glass, and heat gently until dissolution is complete. Add 10 ml of HNO_3 and 25 ml of HClO_4 , evaporate to strong fumes of HClO_4 , and reduce to about 20 ml volume. Cool, add 100 ml of water and 100 ml of HCl, and transfer quantitatively to a 1-liter volumetric flask. Dilute to volume with water and mix.

7.2.3 Acetylene. Suitable quality for AAS analysis.

7.2.4 Air. Suitable quality for AAS analysis.

7.2.5 Quality Assurance Audit Samples. Same as in Method 108A, Section 7.2.11.

8.0 Sample Collection, Preservation, Transport, and Storage

Same as in Method 108A, Sections 8.1 and 8.2.

9.0 Quality Control

Section	Quality control measure	Effect
10.2	Spectrophotometer calibration	Ensure linearity of spectrophotometer response to standards.
11.4	Check for matrix effects	Eliminate matrix effects.
11.5	Audit sample analysis	Evaluate analyst's technique and standards preparation.

10.0 Calibration and Standardization

Note: Maintain a laboratory log of all calibrations.

10.1 Preparation of Standard Solutions. Pipet 1, 5, 10, and 25 ml of the stock As solution into separate 100-ml volumetric flasks. Add 2 ml of HClO_4 , 10 ml of HCl, and dilute to the mark with water. This will provide standard concentrations of 10, 50, 100, and 250 μg As/ml.

10.2 Calibration Curve and Spectrophotometer Calibration Quality Control. Same as Method 108A, Sections 10.2 and 10.3

11.0 Analytical Procedure

11.1 Sample Preparation. Weigh 100 to 1000 mg of finely pulverized sample to the nearest 0.1 mg. Transfer the sample to a 150-ml Teflon beaker. Dissolve the sample by adding 15 ml of HNO_3 , 10 ml of HCl, 10 ml of HF, and 10 ml of HClO_4 in the exact order as described, and let stand for 10 minutes. In a HClO_4 fume hood, heat on a hot plate until 2–3 ml of HClO_4 remain, then cool. Add 20 ml of water and 10 ml of HCl. Cover and warm until the soluble salts are in solution. Cool, and transfer quantitatively to a 100-ml volumetric flask. Dilute to the mark with water.

11.2 Spectrophotometer Preparation. Same as in Method 108A, Section 11.2.

11.3 Arsenic Determination. If the sample concentration falls outside the range of the calibration curve,

make an appropriate dilution with 2 percent HClO_4 /10 percent HCl (prepared by diluting 2 ml concentrated HClO_4 and 10 ml concentrated HCl to 100 ml with water) so that the final concentration falls within the range of the curve. Using the calibration curve, determine the As concentration in each sample.

Note: Because instruments vary between manufacturers, no detailed operating instructions will be given here. Instead, the instrument manufacturer's detailed operating instructions should be followed.

Run a blank and standard at least after every five samples to check the spectrophotometer calibration. The peak height of the blank must pass through a point no further from the origin than ± 2 percent of the recorder full scale. The difference between the measured concentration of the standard (the product of the corrected average peak height and the reciprocal of the least squares slope) and the actual concentration of the standard must be less than 7 percent, or recalibration of the analyzer is required.

11.4 Mandatory Check for Matrix Effects on the Arsenic Results. Same as Method 12, Section 11.5.

11.5 Audit Sample Analysis. Same as in Method 108A, Section 11.6.

12.0 Data Analysis and Calculations

Same as in Method 108A, Section 12.0.

13.0 Method Performance

13.1 Sensitivity. The lower limit of flame AAS is 10 μg As/ml.

14.0 Pollution Prevention[Reserved]

15.0 Waste Management[Reserved]

16.0 References

Same as in Method 108A, Section 16.0.

17.0 Tables, Diagrams, Flowcharts, and Validation Data[Reserved]

Method 108C—Determination of Arsenic Content in Ore Samples From Nonferrous Smelters (Molybdenum Blue Photometric Procedure)

Note: This method does not include all of the specifications (e.g., equipment and supplies) and procedures (e.g., sampling and analytical) essential to its performance. Some material is incorporated by reference from other methods in this part. Therefore, to obtain reliable results, persons using this method should have a thorough knowledge of at least Method 108A.

1.0 Scope and Application

1.1 Analytes.

Analyte	CAS No.	Sensitivity
Arsenic compounds as arsenic (As)	7440-38-2	Lower limit 0.0002 percent As by weight.

1.2 Applicability. This method applies to the determination of inorganic As content of process ore and reverberatory matte samples from nonferrous smelters and other sources as specified in an applicable

subpart of the regulations.

1.3 Data Quality Objectives. Adherence to the requirements of this method will enhance the quality of the data obtained from air pollutant sampling methods.

2.0 Summary of Method

Arsenic bound in ore samples is liberated by acid digestion and analyzed by the molybdenum blue photometric procedure.

3.0 Definitions.[Reserved]

4.0 Interferences.[Reserved]

5.0 Safety

5.1 Disclaimer. This method may involve hazardous materials, operations, and equipment. This test method may not address all of the safety problems associated with its use. It is the responsibility of the user to establish appropriate safety and health practices and determine the applicability of regulatory limitations prior to performing this test method.

5.2 Corrosive Reagents. The following reagents are hazardous. Personal protective equipment and safe procedures that prevent chemical splashes are recommended. If contact occurs, immediately flush with copious amounts of water for at least 15 minutes. Remove clothing under shower and decontaminate. Treat residual chemical burns as thermal burns.

5.2.1 Hydrochloric Acid (HCl). Highly corrosive liquid with toxic vapors. Vapors are highly irritating to eyes, skin, nose, and lungs, causing severe damage. May cause bronchitis, pneumonia, or edema of lungs. Exposure to concentrations of 0.13 to 0.2 percent can be lethal to humans in a few minutes. Provide ventilation to limit exposure. Reacts with metals, producing hydrogen gas.

5.2.2 Hydrofluoric Acid (HF). Highly corrosive to eyes, skin, nose, throat, and lungs. Reaction to exposure may be delayed by 24 hours or more. Provide ventilation to limit exposure.

5.2.3 Nitric Acid (HNO₃). Highly corrosive to eyes, skin, nose, and lungs. Vapors are highly toxic and can cause bronchitis, pneumonia, or edema of lungs. Reaction to inhalation may be delayed as long as 30 hours and still be fatal. Provide ventilation to limit exposure. Strong oxidizer. Hazardous reaction may occur with organic materials such as solvents.

5.2.4 Perchloric Acid (HClO₄). Corrosive to eyes, skin, nose, and throat. Provide ventilation to limit exposure. Very strong oxidizer. Keep separate from water and oxidizable materials to prevent vigorous evolution of heat, spontaneous combustion, or explosion. Heat solutions containing HClO₄ only in hoods specifically designed for HClO₄.

5.2.5 Sulfuric acid (H₂SO₄). Rapidly destructive to body tissue. Will cause third degree burns. Eye damage may result in blindness. Inhalation may be fatal from spasm of the larynx, usually within 30 minutes. May cause lung tissue damage with edema. 3 mg/m³ will cause lung damage in uninitiated. 1 mg/m³ for 8 hours will cause lung damage or, in higher concentrations, death. Provide ventilation to limit inhalation. Reacts violently with metals and organics.

6.0 Equipment and Supplies

6.1 Sample Preparation. The following items are required for sample preparation:

6.1.1 Analytical Balance. To measure to within 0.1 mg.

6.1.2 Erlenmeyer Flask. 300-ml.

6.1.3 Hot Plate.

6.1.4 Distillation Apparatus. No. 6, in ASTM E 50–82, 86, or 90 (Reapproved 1995)(incorporated by reference—see §61.18); detailed in Figure 108C–1.

6.1.5 Graduated Cylinder. 50-ml.

6.1.6 Perchloric Acid Fume Hood.

6.2 Analysis. The following items are required for analysis:

6.2.1 Spectrophotometer. Capable of measuring at 660 nm.

6.2.2 Volumetric Flasks. 50- and 100-ml.

7.0 Reagents and Standards

Unless otherwise indicated, it is intended that all reagents conform to the specifications established by the Committee on Analytical Reagents of the American Chemical Society, where such specifications are available; otherwise, use the best available grade.

7.1 Sample Preparation. The following reagents are required for sample preparation:

7.1.1 Water. Deionized distilled to meet ASTM D 1193–77 or 91 Type 3 (incorporated by reference—see §61.18). When high concentrations of organic matter are not expected to be present, the KMnO_4 test for oxidizable organic matter may be omitted. Use in all dilutions requiring water.

7.1.2 Nitric Acid, Concentrated.

7.1.3 Hydrofluoric Acid, Concentrated.

7.1.4 Sulfuric Acid, Concentrated.

7.1.5 Perchloric Acid, 70 Percent.

7.1.6 Hydrochloric Acid, Concentrated.

7.1.7 Dilute Hydrochloric Acid. Add one part concentrated HCl to nine parts water.

7.1.8 Hydrazine Sulfate $(\text{NH}_2)_2\cdot\text{H}_2\text{SO}_4$.

7.1.9 Potassium Bromide (KBr).

7.1.10 Bromine Water, Saturated.

7.2 Analysis. The following reagents and standards are required for analysis:

7.2.1 Water. Same as in Section 7.1.1.

7.2.2 Methyl Orange Solution, 1 g/liter.

7.2.3 Ammonium Molybdate Solution, 5 g/liter. Dissolve 0.5 g $(\text{NH}_4)_2\text{Mo}_7\text{O}_{24}\cdot 4\text{H}_2\text{O}$ in water in a 100-ml volumetric flask, and dilute to the mark. This solution must be freshly prepared.

7.2.4 Standard Arsenic Solution, 10 μg As/ml. Dissolve 0.13203 g of As_2O_3 in 100 ml HCl in a 1-liter

volumetric flask. Add 200 ml of water, cool, dilute to the mark with water, and mix. Transfer 100 ml of this solution to a 1-liter volumetric flask, add 40 ml HCl, cool, dilute to the mark, and mix.

7.2.5 Hydrazine Sulfate Solution, 1 g/liter. Dissolve 0.1 g of $[(\text{NH}_2)_2\cdot\text{H}_2\text{SO}_4]$ in water, and dilute to 100 ml in a volumetric flask. This solution must be freshly prepared.

7.2.6 Potassium Bromate (KBrO_3) Solution, 0.03 Percent Weight by Volume (W/V). Dissolve 0.3 g KBrO_3 in water, and dilute to 1 liter with water.

7.2.7 Ammonium Hydroxide (NH_4OH), Concentrated.

7.2.8 Boiling Granules.

7.2.9 Hydrochloric Acid, 50 percent by volume. Dilute equal parts concentrated HCl with water.

7.2.10 Quality Assurance Audit Samples. Same as in Method 108A, Section 7.2.11.

8.0 Sample Collection, Preservation, Transport, and Storage

Same as in Method 108A, Sections 8.1 and 8.2.

9.0 Quality Control

Section	Quality control measure	Effect
10.2	Calibration curve preparation	Ensure linearity of spectrophotometric analysis of standards.
11.3	Audit sample analysis	Evaluate analyst's technique and standards preparation.

10.0 Calibration and Standardizations

Note: Maintain a laboratory log of all calibrations.

10.1 Preparation of Standard Solutions. Transfer 1.0, 2.0, 4.0, 8.0, 12.0, 16.0, and 20.0 ml of standard arsenic solution (10 $\mu\text{g}/\text{ml}$) to each of seven 50-ml volumetric flasks. Dilute to 20 ml with dilute HCl. Add one drop of methyl orange solution and neutralize to the yellow color with dropwise addition of NH_4OH . Just bring back to the red color by dropwise addition of dilute HCl, and add 10 ml in excess. Proceed with the color development as described in Section 11.2.

10.2 Calibration Curve. Plot the spectrophotometric readings of the calibration solutions against $\mu\text{g As}$ per 50 ml of solution. Use this curve to determine the As concentration of each sample.

10.3 Spectrophotometer Calibration Quality Control. Calculate the least squares slope of the calibration curve. The line must pass through the origin or through a point no further from the origin than ± 2 percent of the recorder full scale. Multiply the corrected peak height by the reciprocal of the least squares slope to determine the distance each calibration point lies from the theoretical calibration line. The difference between the calculated concentration values and the actual concentrations must be less than 7 percent for all standards.

11.0 Analytical Procedure

11.1 Sample Preparation.

11.1.1 Weigh 1.0 g of finely pulverized sample to the nearest 0.1 mg. Transfer the sample to a 300 ml Erlenmeyer flask and add 15 ml of HNO_3 , 4 ml HCl , 2 ml HF , 3 ml HClO_4 , and 15 ml H_2SO_4 , in the order listed. In a HClO_4 fume hood, heat on a hot plate to decompose the sample. Then heat while swirling over an open flame until dense white fumes evolve. Cool, add 15 ml of water, swirl to hydrate the H_2SO_4 completely, and add several boiling granules. Cool to room temperature.

11.1.2 Add 1 g of KBr , 1 g hydrazine sulfate, and 50 ml HCl . Immediately attach the distillation head with thermometer and dip the side arm into a 50-ml graduated cylinder containing 25 ml of water and 2 ml of bromine water. Keep the graduated cylinder immersed in a beaker of cold water during distillation. Distill until the temperature of the vapor in the flask reaches 107°C (225°F). When distillation is complete, remove the flask from the hot plate, and simultaneously wash down the side arm with water as it is removed from the cylinder.

11.1.3 If the expected arsenic content is in the range of 0.0020 to 0.10 percent, dilute the distillate to the 50-ml mark of the cylinder with water, stopper, and mix. Transfer a 5.0-ml aliquot to a 50-ml volumetric flask. Add 10 ml of water and a boiling granule. Place the flask on a hot plate, and heat gently until the bromine is expelled and the color of methyl orange indicator persists upon the addition of 1 to 2 drops. Cool the flask to room temperature. Neutralize just to the yellow color of the indicator with dropwise additions of NH_4OH . Bring back to the red color by dropwise addition of dilute HCl , and add 10 ml excess. Proceed with the molybdenum blue color development as described in Section 11.2.

11.1.4 If the expected arsenic content is in the range of 0.0002 to 0.0010 percent As , transfer either the entire initial distillate or the measured remaining distillate from Section 11.1.2 to a 250-ml beaker. Wash the cylinder with two successive portions of concentrated HNO_3 , adding each portion to the distillate in the beaker. Add 4 ml of concentrated HClO_4 , a boiling granule, and cover with a flat watch glass placed slightly to one side. Boil gently on a hot plate until the volume is reduced to approximately 10 ml. Add 3 ml of HNO_3 , and continue the evaporation until HClO_4 is refluxing on the beaker cover. Cool briefly, rinse the underside of the watch glass and the inside of the beaker with about 3–5 ml of water, cover, and continue the evaporation to expel all but 2 ml of the HClO_4 .

Note: If the solution appears cloudy due to a small amount of antimony distilling over, add 4 ml of 50 percent HCl and 5 ml of water, cover, and warm gently until clear. If cloudiness persists, add 5 ml of HNO_3 and 2 ml H_2SO_4 . Continue the evaporation of volatile acids to solubilize the antimony until dense white fumes of H_2SO_4 appear. Retain at least 1 ml of the H_2SO_4 .

11.1.5 To the 2 ml of HClO_4 solution or 1 ml of H_2SO_4 solution, add 15 ml of water, boil gently for 2 minutes, and then cool. Proceed with the molybdenum blue color development by neutralizing the solution directly in the beaker just to the yellow indicator color by dropwise addition of NH_4OH . Obtain the red color by dropwise addition of dilute HCl . Transfer the solution to a 50-ml volumetric flask. Rinse the beaker successively with 10 ml of dilute HCl , followed by several small portions of water. At this point the volume of solution in the flask should be no more than 40 ml. Continue with the color development as described in Section 11.2.

11.2 Analysis.

11.2.1 Add 1 ml of KBrO_3 solution to the flask and heat on a low-temperature hot plate to about 50°C (122°F) to oxidize the arsenic and methyl orange. Add 5.0 ml of ammonium molybdate solution to the warm solution and mix. Add 2.0 ml of hydrazine sulfate solution, dilute until the solution comes within the neck of the flask, and mix. Place the flask in a 400 ml beaker, 80 percent full of boiling water, for 10 minutes. Enough heat must be supplied to prevent the water bath from cooling much below the boiling point upon inserting the volumetric flask. Remove the flask, cool to room temperature, dilute to the mark, and mix.

11.2.2 Transfer a suitable portion of the reference solution to an absorption cell, and adjust the spectrophotometer to the initial setting using a light band centered at 660 nm. While maintaining this spectrophotometer adjustment, take the readings of the calibration solutions followed by the samples.

11.3 Audit Sample Analysis. Same as in Method 108A, Section 11.6.

12.0 Data Analysis and Calculations

Same as in Method 108A, Section 12.0.

13.0 Method Performance.[Reserved]

14.0 Pollution Prevention.[Reserved]

15.0 Waste Management.[Reserved]

16.0 References

1. Ringwald, D. Arsenic Determination on Process Materials from ASARCO's Copper Smelter in Tacoma, Washington. Unpublished Report. Prepared for the Emission Measurement Branch, Technical Support Division, U.S. Environmental Protection Agency, Research Triangle Park, North Carolina. August 1980. 35 pp.

17.0 Tables, Diagrams, Flowcharts, and Validation Data

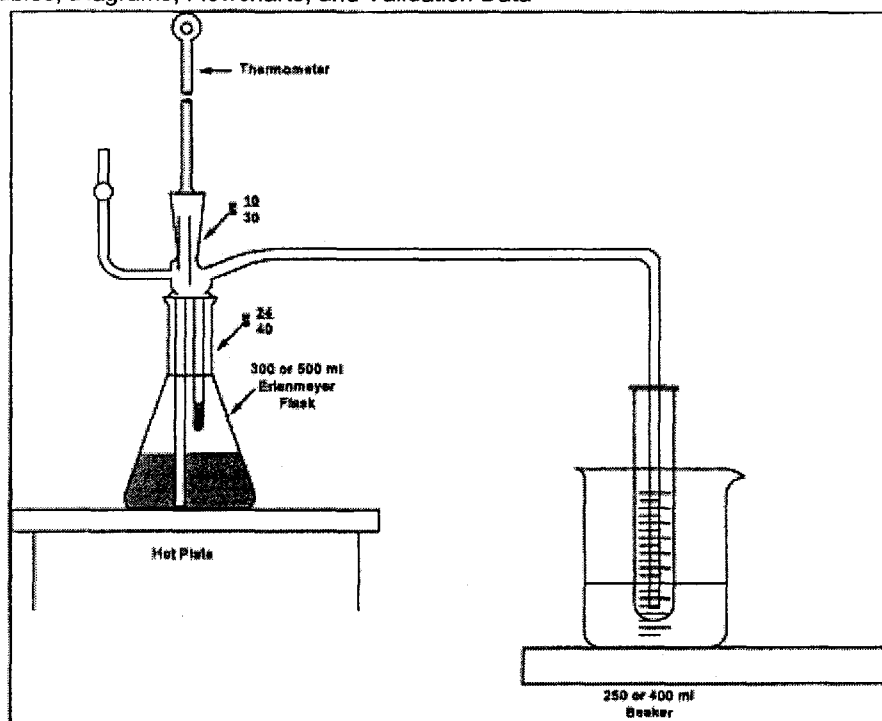

Figure 108C-1. Distillation Apparatus.

[View or download PDF](#)

Method 111—Determination of Polonium-210 Emissions From Stationary Sources

Note: This method does not include all of the specifications (e.g., equipment and supplies) and procedures (e.g., sampling and analytical) essential to its performance. Some material is incorporated by reference from methods in appendix A to 40 CFR part 60. Therefore, to obtain reliable results, persons using this method should have a thorough knowledge of at least the following additional test methods: Method 1, Method 2, Method 3, and Method 5.

1.0 Scope and Application

1.1 Analytes.

Analyte	CAS No.	Sensitivity
Polonium	7440-08-6	Not specified.

1.2 Applicability. This method is applicable for the determination of the polonium-210 content of particulate matter samples collected from stationary source exhaust stacks, and for the use of these data to calculate polonium-210 emissions from individual sources and from all affected sources at a facility.

1.3 Data Quality Objectives. Adherence to the requirements of this method will enhance the quality of the data obtained from air pollutant sampling methods.

2.0 Summary of Method

A particulate matter sample, collected according to Method 5, is analyzed for polonium-210 content: the polonium-210 in the sample is put in solution, deposited on a metal disc, and the radioactive disintegration rate measured. Polonium in acid solution spontaneously deposits on surfaces of metals that are more electropositive than polonium. This principle is routinely used in the radiochemical analysis of polonium-210. Data reduction procedures are provided, allowing the calculation of polonium-210 emissions from individual sources and from all affected sources at a facility, using data obtained from Methods 2 and 5 and from the analytical procedures herein.

3.0 Definitions[Reserved]

4.0 Interferences[Reserved]

5.0 Safety

5.1 Disclaimer. This method may involve hazardous materials, operations, and equipment. This test method may not address all of the safety problems associated with its use. It is the responsibility of the user of this test method to establish appropriate safety and health practices and determine the applicability of regulatory limitations prior to performing this test method.

5.2 Corrosive Reagents. The following reagents are hazardous. Personal protective equipment and safe procedures are useful in preventing chemical splashes. If contact occurs, immediately flush with copious amounts of water at least 15 minutes. Remove clothing under shower and decontaminate. Treat residual chemical burns as thermal burns.

5.2.1 Hydrochloric Acid (HCl). Highly corrosive liquid with toxic vapors. Vapors are highly irritating to eyes, skin, nose, and lungs, causing severe damage. May cause bronchitis, pneumonia, or edema of lungs. Exposure to concentrations of 0.13 to 0.2 percent can be lethal to humans in a few minutes. Provide ventilation to limit exposure. Reacts with metals, producing hydrogen gas.

5.2.2 Hydrofluoric Acid (HF). Highly corrosive to eyes, skin, nose, throat, and lungs. Reaction to exposure may be delayed by 24 hours or more. Provide ventilation to limit exposure.

5.2.3 Nitric Acid (HNO₃). Highly corrosive to eyes, skin, nose, and lungs. Vapors cause bronchitis, pneumonia, or edema of lungs. Reaction to inhalation may be delayed as long as 30 hours and still be fatal. Provide ventilation to limit exposure. Strong oxidizer. Hazardous reaction may occur with organic materials such as solvents.

5.2.4 Perchloric Acid (HClO₄). Corrosive to eyes, skin, nose, and throat. Provide ventilation to limit exposure. Keep separate from water and oxidizable materials to prevent vigorous evolution of heat, spontaneous combustion, or explosion. Heat solutions containing HClO₄ only in hoods specifically designed for HClO₄.

6.0 *Equipment and Supplies*

6.1 Alpha Spectrometry System. Consisting of a multichannel analyzer, biasing electronics, silicon surface barrier detector, vacuum pump and chamber.

6.2 Constant Temperature Bath at 85 °C (185 °F).

6.3 Polished Silver Discs. 3.8 cm diameter, 0.4 mm thick with a small hole near the edge.

6.4 Glass Beakers. 400 ml, 150 ml.

6.5 Hot Plate, Electric.

6.6 Fume Hood.

6.7 Teflon Beakers, 150 ml.

6.8 Magnetic Stirrer.

6.9 Stirring Bar.

6.10 Hooks. Plastic or glass, to suspend plating discs.

6.11 Internal Proportional Counter. For measuring alpha particles.

6.12 Nucleopore Filter Membranes. 25 mm diameter, 0.2 micrometer pore size or equivalent.

6.13 Planchets. Stainless steel, 32 mm diameter with 1.5 mm lip.

6.14 Transparent Plastic Tape. 2.5 cm wide with adhesive on both sides.

6.15 Epoxy Spray Enamel.

6.16 Suction Filter Apparatus. For 25 mm diameter filter.

6.17 Wash Bottles, 250 ml capacity.

6.18 Graduated Cylinder, plastic, 25 ml capacity.

6.19 Volumetric Flasks, 100 ml, 250 ml.

7.0 *Reagents and Standards*

Unless otherwise indicated, it is intended that all reagents conform to the specifications established by the Committee on Analytical Reagents of the American Chemical Society, where such specifications are available; otherwise, use the best available grade.

7.1 Ascorbic Acid.

7.2 Ammonium Hydroxide (NH₄OH), 15 M.

7.3 Water. Deionized distilled, to conform to ASTM D 1193–77 or 91 (incorporated by reference—see §61.18), Type 3. Use in all dilutions requiring water.

7.4 Ethanol (C₂H₅OH), 95 percent.

7.5 Hydrochloric Acid, 12 M.

7.6 Hydrochloric Acid, 1 M. Dilute 83 ml of the 12 M HCl to 1 liter with distilled water.

7.7 Hydrofluoric Acid, 29 M.

7.8 Hydrofluoric Acid, 3 M. Dilute 52 ml of the 29 M HF to 500 ml with distilled water. Use a plastic graduated cylinder and storage bottle.

7.9 Lanthanum Carrier, 0.1 mg La³⁺/ml. Dissolve 0.078 gram lanthanum nitrate, La(NO₃)₃·6H₂O in 250 ml of 1 M HCl.

7.10 Nitric Acid, 16 M.

7.11 Perchloric Acid, 12 M.

7.12 Polonium-209 Solution.

7.13 Silver Cleaner. Any mild abrasive commercial silver cleaner.

7.14 Degreaser.

7.15 Standard Solution. Standardized solution of an alpha-emitting actinide element, such as plutonium-239 or americium-241.

8.0 *Sample Collection, Preservation, Transport, and Storage.*[Reserved]

9.0 *Quality Control*

9.1 General Requirement.

9.1.1 All analysts using this method are required to demonstrate their ability to use the method and to define their respective accuracy and precision criteria.

9.2 Miscellaneous Quality Control Measures.

Section	Quality control measure	Effect
10.1	Standardization of alpha spectrometry system	Ensure precision of sample analyses.
10.3	Standardization of internal proportional counter	Ensure precise sizing of sample aliquot.
11.1, 11.2	Determination of procedure background and instrument background	Minimize background effects.
11.3	Audit sample analysis	Evaluate analyst's technique.

10.0 *Calibration and Standardization*

10.1 Standardization of Alpha Spectrometry System.

10.1.1 Add a quantity of the actinide standard solution to a 100 ml volumetric flask so that the final concentration when diluted to a volume of 100 ml will be approximately 1_p Ci/ml.

10.1.2 Add 10 ml of 16 M HNO_3 and dilute to 100 ml with water.

10.1.3 Add 20 ml of 1 M HCl to each of six 150 ml beakers. Add 1.0 ml of lanthanum carrier, 0.1 mg lanthanum per ml, to the acid solution in each beaker.

10.1.4 Add 1.0 ml of the 1 pCi/ml working solution (from Section 10.1.1) to each beaker. Add 5.0 ml of 3 M HF to each beaker.

10.1.5 Cover beakers and allow solutions to stand for a minimum of 30 minutes. Filter the contents of each beaker through a separate filter membrane using the suction filter apparatus. After each filtration, wash the filter membrane with 10 ml of distilled water and 5 ml of ethanol, and allow the filter membrane to air dry on the filter apparatus.

10.1.6 Carefully remove the filter membrane and mount it, filtration side up, with double-side tape on the inner surface of a planchet. Place planchet in an alpha spectrometry system and count each planchet for 1000 minutes.

10.1.7 Calculate the counting efficiency of the detector for each aliquot of the 1 pCi/ml actinide working solution using Eq. 111-1 in Section 12.2.

10.1.8 Determine the average counting efficiency of the detector, E_c , by calculating the average of the six determinations.

10.2 Preparation of Standardized Solution of Polonium-209.

10.2.1 Add a quantity of the Po-209 solution to a 100 ml volumetric flask so that the final concentration when diluted to a 100 ml volume will be approximately 1 pCi/ml.

10.2.2 Follow the procedures outlined in Sections 10.1.2 through 10.1.6, except substitute 1.0 ml of polonium-209 tracer solution (Section 10.2.1) and 3.0 ml of 15 M ammonium hydroxide for the 1 pCi/ml actinide working solution and the 3 M HF, respectively.

10.2.3 Calculate the activity of each aliquot of the polonium-209 tracer solution using Eq. 111-2 in Section 12.3.

10.2.4 Determine the average activity of the polonium-209 tracer solution, F , by averaging the results of the six determinations.

10.3 Standardization of Internal Proportional Counter

10.3.1 Add a quantity of the actinide standard solution to a 100 ml volumetric flask so that the final concentration when diluted to a 100 ml volume will be approximately 100 pCi/ml.

10.3.2 Follow the procedures outlined in Sections 10.1.2 through 10.1.6, except substitute the 100 pCi/ml actinide working solution for the 1 pCi/ml solution, place the planchet in an internal proportional counter (instead of an alpha spectrometry system), and count for 100 minutes (instead of 1000 minutes).

10.3.3 Calculate the counting efficiency of the internal proportional counter for each aliquot of the 100 pCi/ml actinide working solution using Eq. 111-3 in 12.4.

10.3.4 Determine the average counting efficiency of the internal proportional counter, E_i , by averaging the results of the six determinations.

11.0 Analytical Procedure

Note: Perform duplicate analyses of all samples, including background counts, quality assurance audit samples, and Method 5 samples. Duplicate measurements are considered acceptable when the difference between them is less than two standard deviations as

described in EPA 600/4-77-001 or subsequent revisions.

11.1 Determination of Procedure Background. Background counts used in all equations are determined by performing the specific analysis required using the analytical reagents only. All procedure background counts and sample counts for the internal proportional counter should utilize a counting time of 100 minutes; for the alpha spectrometry system, 1000 minutes. These background counts should be performed no less frequently than once per 10 sample analyses.

11.2 Determination of Instrument Background. Instrument backgrounds of the internal proportional counter and the alpha spectrometry system should be determined on a weekly basis. Instrument background should not exceed procedure background. If this occurs, it may be due to a malfunction or contamination, and should be corrected before use.

11.3 Quality Assurance Audit Samples. An externally prepared performance evaluation sample shall be analyzed no less frequently than once per 10 sample analyses, and the results reported with the test results.

11.4 Sample Preparation. Treat the Method 5 samples [*i.e.*, the glass fiber filter (Container No. 1) and the acetone rinse (Container No. 2)] as follows:

11.4.1 Container No. 1. Transfer the filter and any loose particulate matter from the sample container to a 150-ml Teflon beaker.

11.4.2 Container No. 2. Note the level of liquid in the container, and confirm on the analysis sheet whether leakage occurred during transport. If a noticeable amount of leakage has occurred, either void the sample or use methods, subject to the approval of the Administrator, to correct the final results. Transfer the contents to a 400-ml glass beaker. Add polonium-209 tracer solution to the glass beaker in an amount approximately equal to the amount of polonium-210 expected in the total particulate sample. Record the activity of the tracer solution added. Add 16 M nitric acid to the beaker to digest and loosen the residue.

11.4.3 Transfer the contents of the glass beaker to the Teflon beaker containing the glass fiber filter. Rinse the glass beaker with 16 M HNO_3 . If necessary, reduce the volume in the beaker by evaporation until all of the nitric acid HNO_3 from the glass beaker has been transferred to the Teflon beaker.

11.4.4 Add 30 ml of 29 M HF to the Teflon beaker and evaporate to near dryness on a hot plate in a properly operating hood.

Note: Do not allow the residue to go to dryness and overheat; this will result in loss of polonium.

11.4.5 Repeat step 11.4.4 until the filter is dissolved.

11.4.6 Add 100 ml of 16 M HNO_3 to the residue in the Teflon beaker and evaporate to near dryness.

Note: Do not allow the residue to go to dryness.

11.4.7 Add 50 ml of 16 M HNO_3 and 10 ml of 12 M perchloric acid to the Teflon beaker and heat until dense fumes of perchloric acid are evolved.

11.4.8 Repeat steps 11.4.4 to 11.4.7 as necessary until sample is completely dissolved.

11.4.9 Add 10 ml of 12 M HCl to the Teflon beaker and evaporate to dryness. Repeat additions and evaporations several times.

11.4.10 Transfer the sample to a 250-ml volumetric flask and dilute to volume with 3 M HCl.

11.5 Sample Screening. To avoid contamination of the alpha spectrometry system, check each sample

as follows:

11.5.1 Add 20 ml of 1 M HCl, 1 ml of the lanthanum carrier solution (0.1 mg La/ml), a 1 ml aliquot of the sample solution from Section 11.4.10, and 3 ml of 15 M ammonium hydroxide to a 250-ml beaker in the order listed. Allow this solution to stand for a minimum of 30 minutes.

11.5.2 Filter the solution through a filter membrane using the suction filter apparatus. Wash the filter membrane with 10 ml of water and 5 ml of ethanol, and allow the filter membrane to air dry on the filter apparatus.

11.5.3 Carefully remove the filter membrane and mount it, filtration side up, with double-side tape on the inner surface of a planchet. Place the planchet in an internal proportional counter, and count for 100 minutes.

11.5.4 Calculate the activity of the sample using Eq. 111-4 in Section 12.5.

11.5.5 Determine the aliquot volume of the sample solution from Section 11.4.10 to be analyzed for polonium-210, such that the aliquot contains an activity between 1 and 4 picocuries. Use Eq. 111-5 in Section 12.6.

11.6 Preparation of Silver Disc for Spontaneous Electrodeposition.

11.6.1 Clean both sides of the polished silver disc with silver cleaner and with degreaser.

11.6.2 Place disc on absorbent paper and spray one side with epoxy spray enamel. This should be carried out in a well-ventilated area, with the disc lying flat to keep paint on one side only. Allow paint to dry for 24 hours before using disc for deposition.

11.7 Sample Analysis.

11.7.1 Add the aliquot of sample solution from Section 11.4.10 to be analyzed for polonium-210, the volume of which was determined in Section 11.5.5, to a suitable 200-ml container to be placed in a constant temperature bath.

Note: Aliquot volume may require a larger container.

11.7.2 If necessary, bring the volume to 100 ml with 1 M HCl. If the aliquot volume exceeds 100 ml, use total aliquot.

11.7.3 Add 200 mg of ascorbic acid and heat solution to 85 °C (185 °F) in a constant temperature bath.

11.7.4 Suspend a silver disc in the heated solution using a glass or plastic rod with a hook inserted through the hole in the disc. The disc should be totally immersed in the solution, and the solution must be stirred constantly, at all times during the plating operation. Maintain the disc in solution for 3 hours.

11.7.5 Remove the silver disc, rinse with deionized distilled water, and allow to air dry at room temperature.

11.7.6 Place the disc, with deposition side (unpainted side) up, on a planchet and secure with double-side plastic tape. Place the planchet with disc in alpha spectrometry system and count for 1000 minutes.

12.0 Data Analysis and Calculations.

12.1 Nomenclature.

A = Picocuries of polonium-210 in the Method 5 sample (from Section 12.8).

A_A = Picocuries of actinide added.

A_L = Volume of sample aliquot used, in ml (specified in Section 11.5.1 as 1 ml).

A_S = Aliquot to be analyzed, in ml.

B_B = Procedure background counts measured in polonium-209 spectral region.

B_T = Polonium-209 tracer counts in sample.

C_T = Total counts in polonium-210 spectral region.

D = Decay correction for time "t" (in days) from sample collection to sample counting, given by:
 $D = e^{-0.005t}$

E_C = Average counting efficiency of detector (from Section 10.1.8), as counts per disintegration.

E_{C_i} = Counting efficiency of the detector for aliquot i of the actinide working solution, counts per disintegration.

E_I = Average counting efficiency of the internal proportional counter, as determined in Section 10.3.4, counts per disintegration.

E_{I_i} = Counting efficiency of the internal proportional counter for aliquot i of the 100 pCi/ml actinide working solution, counts per disintegration.

E_Y = The fraction of polonium-209 recovered on the planchet (from Section 12.7).

F = Average activity of polonium-209 in sample (from Section 10.2.4), in pCi.

F_i = activity of aliquot i of the polonium-209 tracer solution, in pCi.

L = Dilution factor (unitless). This is the volume of sample solution prepared (specified as 250 ml in Section 11.1.10) divided by the volume of the aliquot of sample solution analyzed for polonium-210 (from Section 11.7.1).

M_i = Phosphorous rock processing rate of the source being tested, during run i, Mg/hr.

M_k = Phosphate rock processed annually by source k, in Mg/yr.

n = Number of calciners at the elemental phosphorus plant.

P = Total activity of sample solution from Section 11.4.10, in pCi (see Eq. 111-4).

Q_{sd} = Volumetric flow rate of effluent stream, as determined by Method 2, in dscm/hr.

S = Annual polonium-210 emissions from the entire facility, in curies/yr.

$V_m(\text{std})$ = Volume of air sample, as determined by Method 5, in dscm.

X_k = Emission rate from source k, from Section 12.10, in curies/Mg.

10^{-12} = Curies per picocurie.

2.22 = Disintegrations per minute per picocurie.

250 = Volume of solution from Section 11.4.10, in ml.

12.2 Counting Efficiency. Calculate the counting efficiency of the detector for each aliquot of the 1 pCi/ml actinide working solution using Eq. 111-1.

$$E_C = \frac{C_S - C_B}{2.22 A_A T} \quad \text{Eq. 111-1}$$

Where:

C_B = Background counts in same peak area as C_S .

C_S = Gross counts in actinide peak.

T = Counting time in minutes, specified in Section 10.1.6 as 1000 minutes.

12.3 Polonium-209 Tracer Solution Activity. Calculate the activity of each aliquot of the polonium-209 tracer solution using Eq. 111-2.

$$F_i = \frac{C_S - C_B}{2.22 E_{Ci} T} \quad \text{Eq. 111-2}$$

Where:

C_B = Background counts in the 4.88 MeV region of spectrum the in the counting time T.

C_S = Gross counts of polonium-209 in the 4.88 MeV region of the spectrum in the counting time T.

T = Counting time, specified in Section 10.1.6 as 1000 minutes.

12.4 Control Efficiency of Internal Proportional Counter. Calculate the counting efficiency of the internal proportional counter for each aliquot of the 100 pCi/ml actinide working solution using Eq. 111-3.

$$E_{PI} = \frac{C_S - C_B}{2.22 A_A T} \quad \text{Eq. 111-3}$$

Where:

C_B = Gross counts of procedure background.

C_S = Gross counts of standard.

T = Counting time in minutes, specified in Section 10.3.2 as 100 minutes.

12.5 Calculate the activity of the sample using Eq. 111-4.

$$P = \frac{250 (C_S - C_B)}{2.22 E_I A_I T} \quad \text{Eq. 111-4}$$

Where:

C_B = Total counts of procedure background. (See Section 11.1).

C_S = Total counts of screening sample.

T = Counting time for sample and background (which must be equal), in minutes (specified in Section 11.5.3 as 100 minutes).

12.6 Aliquot Volume. Determine the aliquot volume of the sample solution from Section 11.4.10 to be analyzed for polonium-210, such that the aliquot contains an activity between 1 and 4 picocuries using Eq. 111-5.

$$A_s = \frac{250 \text{ (desired picocuries in aliquot)}}{P} \quad \text{Eq. 111-5}$$

12.7 Polonium-209 Recovery. Calculate the fraction of polonium-209 recovered on the planchet, E_Y , using Eq. 111-6.

$$E_Y = \frac{B_T - B_B}{2.22 \bar{F} E_C T} \quad \text{Eq. 111-6}$$

Where:

T = Counting time, specified in Section 11.1 as 1000 minutes.

12.8 Polonium-210 Activity. Calculate the activity of polonium-210 in the Method 5 sample (including glass fiber filter and acetone rinse) using Eq. 111-7.

$$A = \frac{(C_T - C_B) L}{2.22 E_Y E_C T D} \quad \text{Eq. 111-7}$$

Where:

C_B = Procedure background counts in polonium-210 spectral region.

T = Counting time, specified in Section 11.1 as 1000 minutes for all alpha spectrometry sample and background counts.

12.9 Emission Rate from Each Stack.

12.9.1 For each test run, i , on a stack, calculate the measured polonium-210 emission rate, R_{Si} , using Eq. 111-8.

$$R_{Si} = \frac{(10^{-12}) A Q_{sd}}{V_{m(st)} M_i} \quad \text{Eq. 111-8}$$

12.9.2 Determine the average polonium-210 emission rate from the stack, R_S , by taking the sum of the measured emission rates for all runs, and dividing by the number of runs performed.

12.9.3 Repeat steps 12.9.1 and 12.9.2 for each stack of each calciner.

12.10 Emission Rate from Each Source. Determine the total polonium-210 emission rate, X_k , from each source, k , by taking the sum of the average emission rates from all stacks to which the source exhausts.

12.11 Annual Polonium-210 Emission Rate from Entire Facility. Determine the annual elemental phosphorus plant emissions of polonium-210, S , using Eq. 111-9.

$$S = \frac{\sum_{k=1}^n (X_k M_k)}{n} \quad \text{Eq. 111-9}$$

13.0 Method Performance.[Reserved]

14.0 Pollution Prevention.[Reserved]

15.0 Waste Management.[Reserved]

16.0 References

1. Blanchard, R.L. "Rapid Determination of Lead-210 and Polonium-210 in Environmental Samples by Deposition on Nickel." Anal. Chem., 38 :189, pp. 189-192. February 1966.

17.0 Tables, Diagrams, Flowcharts, and Validation Data[Reserved]

Method 114—Test Methods for Measuring Radionuclide Emissions from Stationary Sources

1. Purpose and Background

This method provides the requirements for: (1) Stack monitoring and sample collection methods appropriate for radionuclides; (2) radiochemical methods which are used in determining the amounts of radionuclides collected by the stack sampling and; (3) quality assurance methods which are conducted in conjunction with these measurements. These methods are appropriate for emissions for stationary sources. A list of references is provided.

Many different types of facilities release radionuclides into air. These radionuclides differ in the chemical and physical forms, half-lives and type of radiation emitted. The appropriate combination of sample extraction, collection and analysis for an individual radionuclide is dependent upon many interrelated factors including the mixture of other radionuclides present. Because of this wide range of conditions, no single method for monitoring or sample collection and analysis of a radionuclide is applicable to all types of facilities. Therefore, a series of methods based on "principles of measurement" are described for monitoring and sample collection and analysis which are applicable to the measurement of radionuclides found in effluent streams at stationary sources. This approach provides the user with the flexibility to choose the most appropriate combination of monitoring and sample collection and analysis methods which are applicable to the effluent stream to be measured.

2. Stack Monitoring and Sample Collection Methods

Monitoring and sample collection methods are described based on "principles of monitoring and sample collection" which are applicable to the measurement of radionuclides from effluent streams at stationary sources. Radionuclides of most elements will be in the particulate form in these effluent streams and can be readily collected using a suitable filter media. Radionuclides of hydrogen, oxygen, carbon, nitrogen, the noble gases and in some circumstances iodine will be in the gaseous form. Radionuclides of these elements will require either the use of an in-line or off-line monitor to directly measure the radionuclides, or suitable sorbers, condensers or bubblers to collect the radionuclides.

2.1 Radionuclides as Particulates. The extracted effluent stream is passed through a filter media to remove the particulates. The filter must have a high efficiency for removal of sub-micron particles. The

guidance in ANSI/HPS N13.1–1999 (section 6.6.2 Filter media) shall be followed in using filter media to collect particulates (incorporated by reference—see §61.18 of this part).

2.2 Radionuclides as Gases.

2.2.1 The Radionuclide Tritium (H-3). Tritium in the form of water vapor is collected from the extracted effluent sample by sorption, condensation or dissolution techniques. Appropriate collectors may include silica gel, molecular sieves, and ethylene glycol or water bubblers.

Tritium in the gaseous form may be measured directly in the sample stream using Method B-1, collected as a gas sample or may be oxidized using a metal catalyst to tritiated water and collected as described above.

2.2.2 Radionuclides of Iodine. Iodine is collected from an extracted sample by sorption or dissolution techniques. Appropriate collectors may include charcoal, impregnated charcoal, metal zeolite and caustic solutions.

2.2.3 Radionuclides of Argon, Krypton and Xenon. Radionuclides of these elements are either measured directly by an in-line or off-line monitor, or are collected from the extracted sample by low temperature sorption techniques, Appropriate sorbers may include charcoal or metal zeolite.

2.2.4 Radionuclides of Oxygen, Carbon, Nitrogen and Radon. Radionuclides of these elements are measured directly using an in-line or off-line monitor. Radionuclides of carbon in the form of carbon dioxide may be collected by dissolution in caustic solutions.

2.3 Definition of Terms

In-line monitor means a continuous measurement system in which the detector is placed directly in or adjacent to the effluent stream. This may involve either gross radioactivity measurements or specific radionuclide measurements. Gross measurements shall be made in conformance with the conditions specified in Methods A-4, B-2 and G-4.

Off-line monitor means a measurement system in which the detector is used to continuously measure an extracted sample of the effluent stream. This may involve either gross radioactivity measurements or specific radionuclide measurements. Gross measurements shall be made in conformance with the conditions specified in Methods A-4, B-2 and G-4.

Sample collection means a procedure in which the radionuclides are removed from an extracted sample of the effluent using a collection media. These collection media include filters, absorbers, bubblers and condensers. The collected sample is analyzed using the methods described in Section 3.

3. Radionuclide Analysis Methods

A series of methods based on “principles of measurement” are described which are applicable to the analysis of radionuclides collected from airborne effluent streams at stationary sources. These methods are applicable only under the conditions stated and within the limitations described. Some methods specify that only a single radionuclide be present in the sample or the chemically separated sample. This condition should be interpreted to mean that no other radionuclides are present in quantities which would interfere with the measurement.

Also identified (Table 1) are methods for a selected list of radionuclides. The listed radionuclides are those which are most commonly used and which have the greatest potential for causing dose to members of the public. Use of methods based on principles of measurement other than those described in this section must be approved in advance of use by the Administrator. For radionuclides not listed in Table 1, any of the described methods may be used provided the user can demonstrate that the applicability conditions of the method have been met.

The type of method applicable to the analysis of a radionuclide is dependent upon the type of radiation emitted, i.e., alpha, beta or gamma. Therefore, the methods described below are grouped according to principles of measurements for the analysis of alpha, beta and gamma emitting radionuclides.

3.1 Methods for Alpha Emitting Radionuclides

3.1.1 Method A-1, Radiochemistry-Alpha Spectrometry.

Principle: The element of interest is separated from other elements, and from the sample matrix using radiochemical techniques. The procedure may involve precipitation, ion exchange, or solvent extraction. Carriers (elements chemically similar to the element of interest) may be used. The element is deposited on a planchet in a very thin film by electrodeposition or by coprecipitation on a very small amount of carrier, such as lanthanum fluoride. The deposited element is then counted with an alpha spectrometer. The activity of the nuclide of interest is measured by the number of alpha counts in the appropriate energy region. A correction for chemical yield and counting efficiency is made using a standardized radioactive nuclide (tracer) of the same element. If a radioactive tracer is not available for the element of interest, a predetermined chemical yield factor may be used.

Applicability: This method is applicable for determining the activity of any alpha-emitting radionuclide, regardless of what other radionuclides are present in the sample provided the chemical separation step produces a very thin sample and removes all other radionuclides which could interfere in the spectral region of interest. APHA-605(2), ASTM-D-3972(13).

3.1.2 Method A-2, Radiochemistry-Alpha Counting.

Principle: The element of interest is separated from other elements, and from the sample matrix using radiochemistry. The procedure may involve precipitation, ion exchange, or solvent extraction. Carriers (elements chemically similar to the element of interest) may be used. The element is deposited on a planchet in a thin film and counted with an alpha counter. A correction for chemical yield (if necessary) is made. The alpha count rate measures the total activity of all emitting radionuclides of the separated element.

Applicability: This method is applicable for the measurement of any alpha-emitting radionuclide, provided no other alpha emitting radionuclide is present in the separated sample. It may also be applicable for determining compliance, when other radionuclides of the separated element are present, provided that the calculated emission rate is assigned to the radionuclide which could be present in the sample that has the highest dose conversion factor. IDO-12096(18).

3.1.3 Method A-3, Direct Alpha Spectrometry.

Principle: The sample, collected on a suitable filter, is counted directly on an alpha spectrometer. The sample must be thin enough and collected on the surface of the filter so that any absorption of alpha particle energy in the sample or the filter, which would degrade the spectrum, is minimal.

Applicability: This method is applicable to simple mixtures of alpha emitting radionuclides and only when the amount of particulates collected on the filter paper are relatively small and the alpha spectra is adequately resolved. Resolutions should be 50 keV (FWHM) or better, ASTM-D-3084(16).

3.1.4 Method A-4, Direct Alpha Counting (Gross alpha determination).

Principle: The sample, collected on a suitable filter, is counted with an alpha counter. The sample must be thin enough so that self-absorption is not significant and the filter must be of such a nature that the particles are retained on the surface.

Applicability: Gross alpha determinations may be used to measure emissions of specific radionuclides only (1) when it is known that the sample contains only a single radionuclide, or the identity and isotopic ratio of the radionuclides in the sample are well-known, and (2) measurements using either Method A-1, A-2 or A-5 have shown that this method provides a reasonably accurate measurement of the emission rate. Gross alpha measurements are applicable to unidentified mixtures of radionuclides only for the purposes and under the conditions described in section 3.7. APHA-601(3), ASTM-D-1943(10).

3.1.5 Method A-5, Chemical Determination of Uranium.

Principle: Uranium may be measured chemically by either colorimetry or fluorometry. In both procedures, the sample is dissolved, the uranium is oxidized to the hexavalent form and extracted into a

suitable solvent. Impurities are removed from the solvent layer. For colorimetry, dibenzoylmethane is added, and the uranium is measured by the absorbance in a colorimeter. For fluorometry, a portion of the solution is fused with a sodium fluoride-lithium fluoride flux and the uranium is determined by the ultraviolet activated fluorescence of the fused disk in a fluorometer.

Applicability: This method is applicable to the measurements of emission rates of uranium when the isotopic ratio of the uranium radionuclides is well known. ASTM-E-318(15), ASTM-D-2907(14).

3.1.6 Method A-6, Radon-222—Continuous Gas Monitor.

Principle: Radon-222 is measured directly in a continuously extracted sample stream by passing the air stream through a calibrated scintillation cell. Prior to the scintillation cell, the air stream is treated to remove particulates and excess moisture. The alpha particles from radon-222 and its decay products strike a zinc sulfide coating on the inside of the scintillation cell producing light pulses. The light pulses are detected by a photomultiplier tube which generates electrical pulses. These pulses are processed by the system electronics and the read out is in pCi/l of radon-222.

Applicability: This method is applicable to the measurement of radon-222 in effluent streams which do not contain significant quantities of radon-220. Users of this method should calibrate the monitor in a radon calibration chamber at least twice per year. The background of the monitor should also be checked periodically by operating the instrument in a low radon environment. EPA 520/1-89-009(24).

3.1.7 Method A-7, Radon-222-Alpha Track Detectors

Principle: Radon-222 is measured directly in the effluent stream using alpha track detectors (ATD). The alpha particles emitted by radon-222 and its decay products strike a small plastic strip and produce submicron damage tracks. The plastic strip is placed in a caustic solution that accentuates the damage tracks which are counted using a microscope or automatic counting system. The number of tracks per unit area is correlated to the radon concentration in air using a conversion factor derived from data generated in a radon calibration facility.

Applicability: Prior approval from EPA is required for use of this method. This method is only applicable to effluent streams which do not contain significant quantities of radon-220, unless special detectors are used to discriminate against radon-220. This method may be used only when ATDs have been demonstrated to produce data comparable to data obtained with Method A-6. Such data should be submitted to EPA when requesting approval for the use of this method. EPA 520/1-89-009(24).

3.2 Methods for Gaseous Beta Emitting Radionuclides.

3.2.1 Method B-1, Direct Counting in Flow-Through Ionization Chambers.

Principle: An ionization chamber containing a specific volume of gas which flows at a given flow rate through the chamber is used. The sample (effluent stream sample) acts as the counting gas for the chamber. The activity of the radionuclide is determined from the current measured in the ionization chamber.

Applicability: This method is applicable for measuring the activity of a gaseous beta-emitting radionuclide in an effluent stream that is suitable as a counting gas, when no other beta-emitting nuclides are present. DOE/EP-0096(17), NCRP-58(23).

3.2.2 Method B-2, Direct Counting With In-line or Off-line Beta Detectors.

Principle: The beta detector is placed directly in the effluent stream (in-line) or an extracted sample of the effluent stream is passed through a chamber containing a beta detector (off-line). The activities of the radionuclides present in the effluent stream are determined from the beta count rate, and a knowledge of the radionuclides present and the relationship of the gross beta count rate and the specific radionuclide concentration.

Applicability: This method is applicable only to radionuclides with maximum beta particle energies greater than 0.2 MeV. This method may be used to measure emissions of specific radionuclides only when it is known that the sample contains only a single radionuclide or the identity and isotopic ratio of

the radionuclides in the effluent stream are well known. Specific radionuclide analysis of periodic grab samples may be used to identify the types and quantities of radionuclides present and to establish the relationship between specific radionuclide analyses and gross beta count rates.

This method is applicable to unidentified mixtures of gaseous radionuclides only for the purposes and under the conditions described in section 3.7.

3.3 Methods for Non-Gaseous Beta Emitting Radionuclides.

3.3.1 Method B-3, Radiochemistry-Beta Counting.

Principle: The element of interest is separated from other elements, and from the sample matrix by radiochemistry. This may involve precipitation, distillation, ion exchange, or solvent extraction. Carriers (elements chemically similar to the element of interest) may be used. The element is deposited on a planchet, and counted with a beta counter. Corrections for chemical yield, and decay (if necessary) are made. The beta count rate determines the total activity of all radionuclides of the separated element. This method may also involve the radiochemical separation and counting of a daughter element, after a suitable period of ingrowth, in which case it is specific for the parent nuclide.

Applicability: This method is applicable for measuring the activity of any beta-emitting radionuclide, with a maximum energy greater than 0.2 MeV, provided no other radionuclide is present in the separated sample. APHA-608(5).

3.3.2 Method B-4, Direct Beta Counting (Gross beta determination).

Principle: The sample, collected on a suitable filter, is counted with a beta counter. The sample must be thin enough so that self-absorption corrections can be made.

Applicability: Gross beta measurements are applicable only to radionuclides with maximum beta particle energies greater than 0.2 MeV. Gross beta measurements may be used to measure emissions of specific radionuclides only (1) when it is known that the sample contains only a single radionuclide, and (2) measurements made using Method B-3 show reasonable agreement with the gross beta measurement. Gross beta measurements are applicable to mixtures of radionuclides only for the purposes and under the conditions described in section 3.7. APHA-602(4), ASTM-D-1890(11).

3.3.3 Method B-5, Liquid Scintillation Spectrometry.

Principle: An aliquot of a collected sample or the result of some other chemical separation or processing technique is added to a liquid scintillation "cocktail" which is viewed by photomultiplier tubes in a liquid scintillation spectrometer. The spectrometer is adjusted to establish a channel or "window" for the pulse energy appropriate to the nuclide of interest. The activity of the nuclide of interest is measured by the counting rate in the appropriate energy channel. Corrections are made for chemical yield where separations are made.

Applicability: This method is applicable to any beta-emitting nuclide when no other radionuclide is present in the sample or the separated sample provided that it can be incorporated in the scintillation cocktail. This method is also applicable for samples which contain more than one radionuclide but only when the energies of the beta particles are sufficiently separated so that they can be resolved by the spectrometer. This method is most applicable to the measurement of low-energy beta emitters such as tritium and carbon-14. APHA-609(6), EML-LV-539-17(19).

3.4 Gamma Emitting Radionuclides

3.4.1 Method G-1, High Resolution Gamma Spectrometry.

Principle: The sample is counted with a high resolution gamma detector, usually either a Ge(Li) or a high purity Ge detector, connected to a multichannel analyzer or computer. The gamma emitting radionuclides in the sample are measured from the gamma count rates in the energy regions characteristic of the individual radionuclide. Corrections are made for counts contributed by other radionuclides to the spectral regions of the radionuclides of interest. Radiochemical separations may be made prior to counting but are usually not necessary.

Applicability: This method is applicable to the measurement of any gamma emitting radionuclide with gamma energies greater than 20 keV. It can be applied to complex mixtures of radionuclides. The samples counted may be in the form of particulate filters, absorbers, liquids or gases. The method may also be applied to the analysis of gaseous gamma emitting radionuclides directly in an effluent stream by passing the stream through a chamber or cell containing the detector. ASTM-3649(9), IDO-12096(18).

3.4.2 Method G-2, Low Resolution Gamma Spectrometry.

Principle: The sample is counted with a low resolution gamma detector, a thallium activated sodium iodide crystal. The detector is coupled to a photomultiplier tube and connected to a multichannel analyzer. The gamma emitting radionuclides in the sample are measured from the gamma count rates in the energy regions characteristic of the individual radionuclides. Corrections are made for counts contributed by other radionuclides to the spectral regions of the radionuclides of interest. Radiochemical separation may be used prior to counting to obtain less complex gamma spectra if needed.

Applicability: This method is applicable to the measurement of gamma emitting radionuclides with energies greater than 100 keV. It can be applied only to relatively simple mixtures of gamma emitting radionuclides. The samples counted may be in the form of particulate filters, absorbers, liquids or gas. The method can be applied to the analysis of gaseous radionuclides directly in an effluent stream by passing the gas stream through a chamber or cell containing the detector. ASTM-D-2459(12), EMSL-LV-0539-17(19).

3.4.3 Method G-3, Single Channel Gamma Spectrometry.

Principle: The sample is counted with a thallium activated sodium iodide crystal. The detector is coupled to a photomultiplier tube connected to a single channel analyzer. The activity of a gamma emitting radionuclide is determined from the gamma counts in the energy range for which the counter is set.

Applicability: This method is applicable to the measurement of a single gamma emitting radionuclide. It is not applicable to mixtures of radionuclides. The samples counted may be in the form of particulate filters, absorbers, liquids or gas. The method can be applied to the analysis of gaseous radionuclides directly in an effluent stream by passing the gas stream through a chamber or cell containing the detector.

3.4.4 Method G-4, Gross Gamma Counting.

Principle: The sample is counted with a gamma detector usually a thallium activated sodium iodine crystal. The detector is coupled to a photomultiplier tube and gamma rays above a specific threshold energy level are counted.

Applicability: Gross gamma measurements may be used to measure emissions of specific radionuclides only when it is known that the sample contains a single radionuclide or the identity and isotopic ratio of the radionuclides in the effluent stream are well known. When gross gamma measurements are used to determine emissions of specific radionuclides periodic measurements using Methods G-1 or G-2 should be made to demonstrate that the gross gamma measurements provide reliable emission data. This method may be applied to analysis of gaseous radionuclides directly in an effluent stream by placing the detector directly in or adjacent to the effluent stream or passing an extracted sample of the effluent stream through a chamber or cell containing the detector.

3.5 Counting Methods. All of the above methods with the exception of Method A-5 involve counting the radiation emitted by the radionuclide. Counting methods applicable to the measurement of alpha, beta and gamma radiations are listed below. The equipment needed and the counting principles involved are described in detail in ASTM-3648(8).

3.5.1 Alpha Counting:

- *Gas Flow Proportional Counters.* The alpha particles cause ionization in the counting gas and the resulting electrical pulses are counted. These counters may be windowless or have very thin windows.
- *Scintillation Counters.* The alpha particles transfer energy to a scintillator resulting in a production of light photons which strike a photomultiplier tube converting the light photons to electrical pulses which

listed in Table 1. The radionuclides listed are those which are most commonly used and which have the greatest potential for causing doses to members of the public. For radionuclides not listed in Table 1, methods based on any of the applicable "principles of measurement" described in section 3.1 through 3.4 may be used.

3.7 Applicability of Gross Alpha and Beta Measurements to Unidentified Mixtures of Radionuclides. Gross alpha and beta measurements may be used as a screening measurement as a part of an emission measurement program to identify the need to do specific radionuclide analyses or to confirm or verify that unexpected radionuclides are not being released in significant quantities.

Gross alpha (Method A-4) or gross beta (Methods B-2 or B-4) measurements may also be used for the purpose of comparing the measured concentrations in the effluent stream with the limiting "Concentration Levels for Environmental Compliance" in table 2 of appendix E. For unidentified mixtures, the measured concentration value shall be compared with the lowest environmental concentration limit for any radionuclide which is not known to be absent from the effluent stream.

Table 1—List of Approved Methods for Specific Radionuclides

Radionuclide	Approved methods of analysis
Am-241	A-1, A-2, A-3, A-4
Ar-41	B-1, B-2, G-1, G-2, G-3, G-4
Ba-140	G-1, G-2, G-3, G-4
Br-82	G-1, G-2, G-3, G-4
C-11	B-1, B-2, G-1, G-2, G-3, G-4
C-14	B-5
Ca-45	B-3, B-4, B-5
Ce-144	G-1, G-2, G-3, G-4
Cm-244	A-1, A-2, A-3, A-4
Co-60	G-1, G-2, G-3, G-4
Cr-51	G-1, G-2, G-3, G-4
Cs-134	G-1, G-2, G-3, G-4
Cs-137	G-1, G-2, G-3, G-4
Fe-55	B-5, G-1
Fe-59	G-1, G-2, G-3, G-4
Ga-67	G-1, G-2, G-3, G-4
H-3 (H ₂ O)	B-5
H-3 (gas)	B-1
I-123	G-1, G-2, G-3, G-4
I-125	G-1
I-131	G-1, G-2, G-3, G-4
In-113m	G-1, G-2, G-3, G-4
Ir-192	G-1, G-2, G-3, G-4
Kr-85	B-1, B-2, B-5, G-1, G-2, G-3, G-4
Kr-87	B-1, B-2, G-1, G-2, G-3, G-4
Kr-88	B-1, B-2, G-1, G-2, G-3, G-4
Mn-54	G-1, G-2, G-3, G-4

Mo-99	G-1, G-2, G-3, G-4
N-13	B-1, B-2, G-1, G-2, G-3, G-4
O-15	B-1, B-2, G-1, G-2, G-3, G-4
P-32	B-3, B-4, B-5
Pm-147	B-3, B-4, B-5
Po-210	A-1, A-2, A-3, A-4
Pu-238	A-1, A-2, A-3, A-4
Pu-239	A-1, A-2, A-3, A-4
Pu-240	A-1, A-2, A-3, A-4
Ra-226	A-1, A-2, G-1, G-2
S-35	B-5
Se-75	G-1, G-2, G-3, G-4
Sr-90	B-3, B-4, B-5
Tc-99	B-3, B-4, B-5
Te-201	G-1, G-2, G-3, G-4
Uranium (total alpha)	A-1, A-2, A-3, A-4
Uranium (Isotopic)	A-1, A-3
Uranium (Natural)	A-5
Xe-133	G-1
Yb-169	G-1, G-2, G-3, G-4
Zn-65	G-1, G-2, G-3, G-4

4. Quality Assurance Methods

Each facility required to measure their radionuclide emissions shall conduct a quality assurance program in conjunction with the radionuclide emission measurements. This program shall assure that the emission measurements are representative, and are of known precision and accuracy and shall include administrative controls to assure prompt response when emission measurements indicate unexpectedly large emissions. The program shall consist of a system of policies, organizational responsibilities, written procedures, data quality specifications, audits, corrective actions and reports. This quality assurance program shall include the following program elements:

- 4.1 The organizational structure, functional responsibilities, levels of authority and lines of communications for all activities related to the emissions measurement program shall be identified and documented.
- 4.2 Administrative controls shall be prescribed to ensure prompt response in the event that emission levels increase due to unplanned operations.
- 4.3 The sample collection and analysis procedures used in measuring the emissions shall be described including where applicable:
 - 4.3.1 Identification of sampling sites and number of sampling points, including the rationale for site selections.
 - 4.3.2 A description of sampling probes and representativeness of the samples.
 - 4.3.3 A description of any continuous monitoring system used to measure emissions, including the sensitivity of the system, calibration procedures and frequency of calibration.

4.3.4 A description of the sample collection systems for each radionuclide measured, including frequency of collection, calibration procedures and frequency of calibration.

4.3.5 A description of the laboratory analysis procedures used for each radionuclide measured, including frequency of analysis, calibration procedures and frequency of calibration.

4.3.6 A description of the sample flow rate measurement systems or procedures, including calibration procedures and frequency of calibration.

4.3.7 A description of the effluent flow rate measurement procedures, including frequency of measurements, calibration procedures and frequency of calibration.

4.4 The objectives of the quality assurance program shall be documented and shall state the required precision, accuracy and completeness of the emission measurement data including a description of the procedures used to assess these parameters. Accuracy is the degree of agreement of a measurement with a true or known value. Precision is a measure of the agreement among individual measurements of the same parameters under similar conditions. Completeness is a measure of the amount of valid data obtained compared to the amount expected under normal conditions.

4.5 A quality control program shall be established to evaluate and track the quality of the emissions measurement data against preset criteria. The program should include where applicable a system of replicates, spiked samples, split samples, blanks and control charts. The number and frequency of such quality control checks shall be identified.

4.6 A sample tracking system shall be established to provide for positive identification of samples and data through all phases of the sample collection, analysis and reporting system. Sample handling and preservation procedures shall be established to maintain the integrity of samples during collection, storage and analysis.

4.7 Regular maintenance, calibration and field checks shall be performed for each sampling system in use by satisfying the requirements found in Table 2: Maintenance, Calibration and Field Check Requirements.

Table 2—Maintenance, Calibration and Field Check Requirements

Sampling system components	Frequency of activity
Cleaning of thermal anemometer elements	As required by application.
Inspect pitot tubes for contaminant deposits	At least annually.
Inspect pitot tube systems for leaks	At least annually.
Inspect sharp-edged nozzles for damage	At least annually or after maintenance that could cause damage.
Check nozzles for alignment, presence of deposits, or other potentially degrading factors	Annually.
Check transport lines of HEPA-filtered applications to determine if cleaning is required	Annually.
Clean transport lines	Visible deposits for HEPA-filtered applications. Mean mass of deposited material exceeds 1g/m ² for other

	applications.
Inspect or test the sample transport system for leaks	At least annually.
Check mass flow meters of sampling systems with a secondary or transfer standard	At least quarterly.
Inspect rotameters of sampling systems for presence of foreign matter	At the start of each sampling period.
Check response of stack flow rate systems	At least quarterly.
Calibration of flow meters of sampling systems	At least annually.
Calibration of effluent flow measurement devices	At least annually.
Calibration of timing devices	At least annually.

4.8 Periodic internal and external audits shall be performed to monitor compliance with the quality assurance program. These audits shall be performed in accordance with written procedures and conducted by personnel who do not have responsibility for performing any of the operations being audited.

4.9 A corrective action program shall be established including criteria for when corrective action is needed, what corrective actions will be taken and who is responsible for taking the corrective action.

4.10 Periodic reports to responsible management shall be prepared on the performance of the emissions measurements program. These reports should include assessment of the quality of the data, results of audits and description of corrective actions.

4.11 The quality assurance program should be documented in a quality assurance project plan that should address each of the above requirements.

5. References

(1) American National Standards Institute "Guide to Sampling Airborne Radioactive Materials in Nuclear Facilities", ANSI-N13.1-1969, American National Standards Institute, New York, New York (1969).

(2) American Public Health Association, "Methods of Air Sampling", 2nd Edition, Method 605, "Tentative Method of Analysis for Plutonium Content of Atmospheric Particulate Matter". American Public Health Association, New York, NY (1977).

(3) Ibid, Method 601, "Tentative Method of Analysis for Gross Alpha Radioactivity Content of the Atmosphere".

(4) Ibid, Method 602, "Tentative Method of the Analysis for Gross Beta Radioactivity Content of the Atmosphere".

(5) Ibid, Method 608, "Tentative Method of Analysis for Strontium-90 Content of Atmospheric Particulate Matter".

(6) Ibid, Method 609, "Tentative Method of Analysis for Tritium Content of the Atmosphere".

(7) Ibid, Method 603, "Tentative Method of Analysis for Iodine-131 Content of the Atmosphere".

- (8) American Society for Testing and Materials, 1986 Annual Book ASTM Standards, Designation D-3648-78, "Standard Practices for the Measurement of Radioactivity". American Society for Testing and Materials, Philadelphia, PA (1986).
- (9) Ibid, Designation D-3649-85, "Standard Practice for High Resolution Gamma Spectrometry".
- (10) Ibid, Designation D-1943-81, "Standard Test Method for Alpha Particle Radioactivity of Water".
- (11) Ibid, Designation D-1890-81, "Standard Test Method for Beta Particle Radioactivity of Water".
- (12) Ibid, Designation D-2459-72, "Standard Test Method for Gamma Spectrometry of Water".
- (13) Ibid, Designation D-3972-82, "Standard Test Method for Isotopic Uranium in Water by Radiochemistry".
- (14) Ibid, Designation D-2907-83, "Standard Test Methods for Microquantities of Uranium in Water by Fluorometry".
- (15) Ibid, Designation E-318, "Standard Test Method for Uranium in Aqueous Solutions by Colorimetry".
- (16) Ibid, Designation D-3084-75, "Standard Practice for Alpha Spectrometry of Water".
- (17) Corley, J.P. and C.D. Corbit, "A Guide for Effluent Radiological Measurements at DOE Installations", DOE/EP-0096, Pacific Northwest Laboratories, Richland, Washington (1983).
- (18) Department of Energy, "RESL Analytical Chemistry Branch Procedures Manual", IDO-12096, U.S. Department of Energy, Idaho Falls, Idaho (1982).
- (19) Environmental Protection Agency, "Radiochemical Analytical Procedures for Analysis of Environmental Samples", EMSL-LV-0539-17, U.S. Environmental Protection Agency, Environmental Monitoring and Support Laboratory, Las Vegas, Nevada (1979).
- (20) Environmental Protection Agency, "Radiochemistry Procedures Manual", EPA 520/5-84-006, Eastern Environmental Radiation Facility, Montgomery, Alabama (1984).
- (21) National Council on Radiation Protection and Measurements, NCRP Report No. 50, "Environmental Radiation Measurements", National Council on Radiation Protection and Measurement, Bethesda, Maryland (1976).
- (22) Ibid, Report No. 47, "Tritium Measurement Techniques". (1976).
- (23) Ibid, Report No. 58 "A Handbook of Radioactivity Measurement Procedures" (1985).
- (24) Environmental Protection Agency, "Indoor Radon and Radon Decay Product Measurement Protocols", EPA 520/1-89-009, U.S. Environmental Protection Agency, Washington, DC (1989).

Method 115—Monitoring for Radon-222 Emissions

This appendix describes the monitoring methods which must be used in determining the radon-222 emissions from underground uranium mines, uranium mill tailings piles, phosphogypsum stacks, and other piles of waste material emitting radon.

1. *Radon-222 Emissions from Underground Uranium Mine Vents*

1.1 Sampling Frequency and Calculation of Emissions. Radon-222 emissions from underground uranium mine vents shall be determined using one of the following methods:

1.1.1 Continuous Measurement. These measurements shall be made and the emissions calculated as

follows:

(a) The radon-222 concentration shall be continuously measured at each mine vent whenever the mine ventilation system is operational.

(b) Each mine vent exhaust flow rate shall be measured at least 4 times per year.

(c) A weekly radon-222 emission rate for the mine shall be calculated and recorded weekly as follows:

$$A_w = C_1 Q_1 T_1 + C_2 Q_2 T_2 + \dots + C_i Q_i T_i$$

Where:

A_w = Total radon-222 emitted from the mine during week (Ci)

C_i = Average radon-222 concentration in mine vent i (Ci/m³)

Q_i = Volumetric flow rate from mine vent i (m³ /hr)

T_i = Hours of mine ventilation system operation during week for mine vent i (hr)

(d) The annual radon-222 emission rate is the sum of the weekly emission rates during a calendar year.

1.1.2 Periodic Measurement. This method is applicable only to mines that continuously operate their ventilation system except for extended shutdowns. Mines which start up and shut down their ventilation system frequently must use the continuous measurement method describe in Section 1.1.1 above. Emission rates determined using periodic measurements shall be measured and calculated as follows:

(a) The radon-222 shall be continuously measured at each mine vent for at least one week every three months.

(b) Each mine vent exhaust flow rate shall be measured at least once during each of the radon-222 measurement periods.

(c) A weekly radon-222 emission rate shall be calculated for each weekly period according to the method described in Section 1.1.1. In this calculation T=168 hr.

(d) The annual radon-222 emission rate from the mine should be calculated as follows:

$$A_y = \frac{52 - W_s}{n} (A_{w1} + A_{w2} + \dots + A_{wn})$$

Where:

A_y = Annual radon-222 emission rate from the mine (Ci)

A_{wi} = Weekly radon-222 emission rate during the measurement period i (Ci)

n = Number of weekly measurement periods per year

W_s = Number of weeks during the year that the mine ventilation system is shut down in excess of 7 consecutive days, i.e. the sum of the number of weeks each shut down exceeds 7 days

1.2 Test Methods and Procedures

Each underground mine required to test its emissions, unless an equivalent or alternative method has been approved by the Administrator, shall use the following test methods:

1.2.1 Test Method 1 of appendix A to part 60 shall be used to determine velocity traverses. The sampling point in the duct shall be either the centroid of the cross section or the point of average velocity.

1.2.2 Test Method 2 of appendix A to part 60 shall be used to determine velocity and volumetric flow rates.

1.2.3 Test Methods A-6 or A-7 of appendix B, Method 114 to part 61 shall be used for the analysis of radon-222. Use of Method A-7 requires prior approval of EPA based on conditions described in appendix B.

1.2.4 A quality assurance program shall be conducted in conformance with the programs described for Continuous Radon Monitors and Alpha Track Detectors in EPA 520/1-89-009. (2)

2. Radon-222 Emissions from Uranium Mill Tailings Piles

2.1 Measurement and Calculation of Radon Flux from Uranium Mill Tailings Piles.

2.1.1 Frequency of Flux Measurement. A single set of radon flux measurements may be made, or if the owner or operator chooses, more frequent measurements may be made over a one year period. These measurements may involve quarterly, monthly or weekly intervals. All radon measurements shall be made as described in paragraphs 2.1.2 through 2.1.6 except that for measurements made over a one year period, the requirement of paragraph 2.1.4(c) shall not apply. The mean radon flux from the pile shall be the arithmetic mean of the mean radon flux for each measurement period. The weather conditions, moisture content of the tailings and area of the pile covered by water existing at the time of the measurement shall be chosen so as to provide measurements representative of the long term radon flux from the pile and shall be subject to EPA review and approval.

2.1.2 Distribution of Flux Measurements. The distribution and number of radon flux measurements required on a pile will depend on clearly defined areas of the pile (called regions) that can have significantly different radon fluxes due to surface conditions. The mean radon flux shall be determined for each individual region of the pile. Regions that shall be considered for operating mill tailings piles are:

- (a) Water covered areas,
- (b) Water saturated areas (beaches),
- (c) Dry top surface areas, and
- (d) Sides, except where earthen material is used in dam construction.

For mill tailings after disposal the pile shall be considered to consist of only one region.

2.1.3 Number of Flux Measurements. Radon flux measurements shall be made within each region on the pile, except for those areas covered with water. Measurements shall be made at regularly spaced locations across the surface of the region, realizing that surface roughness will prohibit measurements in some areas of a region. The minimum number of flux measurements considered necessary to determine a representative mean radon flux value for each type of region on an operating pile is:

- (a) Water covered area—no measurements required as radon flux is assumed to be zero,
- (b) Water saturated beaches—100 radon flux measurements,
- (c) Loose and dry top surface—100 radon flux measurements,

(d) Sides—100 radon flux measurements, except where earthen material is used in dam construction.

For a mill tailings pile after disposal which consists of only one region a minimum of 100 measurements are required.

2.1.4 Restrictions to Radon Flux Measurements. The following restrictions are placed on making radon flux measurements:

(a) Measurements shall not be initiated within 24 hours of a rainfall.

(b) If a rainfall occurs during the 24 hour measurements period, the measurement is invalid if the seal around the lip of the collector has washed away or if the collector is surrounded by water.

(c) Measurements shall not be performed if the ambient temperature is below 35 °F or if the ground is frozen.

2.1.5 Areas of Pile Regions. The approximate area of each region of the pile shall be determined in units of square meters.

2.1.6 Radon Flux Measurement. Measuring radon flux involves the adsorption of radon on activated charcoal in a large-area collector. The radon collector is placed on the surface of the pile area to be measured and allowed to collect radon for a time period of 24 hours. The radon collected on the charcoal is measured by gamma-ray spectroscopy. The detailed measurement procedure provided in appendix A of EPA 520/5-85-0029(1) shall be used to measure the radon flux on uranium mill tailings, except the surface of the tailings shall not be penetrated by the lip of the radon collector as directed in the procedure, rather the collector shall be carefully positioned on a flat surface with soil or tailings used to seal the edge.

2.1.7 Calculations. The mean radon flux for each region of the pile and for the total pile shall be calculated and reported as follows:

(a) The individual radon flux calculations shall be made as provided in appendix A EPA 86 (1). The mean radon flux for each region of the pile shall be calculated by summing all individual flux measurements for the region and dividing by the total number of flux measurements for the region.

(b) The mean radon flux for the total uranium mill tailings pile shall be calculated as follows.

$$J_s = \frac{J_1 A_1 + \dots + J_2 A_2 \dots + J_i A_i}{A_t}$$

Where:

J_s = Mean flux for the total pile (pCi/m² -s)

J_i = Mean flux measured in region i (pCi/m² -s)

A_i = Area of region i (m²)

A_t = Total area of the pile (m²)

2.1.8 Reporting. The results of individual flux measurements, the approximate locations on the pile, and the mean radon flux for each region and the mean radon flux for the total stack shall be included in the emission test report. Any condition or unusual event that occurred during the measurements that could significantly affect the results should be reported.

3.0 Radon-222 Emissions from Phosphogypsum Stacks.

3.1 Measurement and Calculation of the Mean Radon Flux. Radon flux measurements shall be made on phosphogypsum stacks as described below:

3.1.1 Frequency of Measurements. A single set of radon flux measurements may be made after the phosphogypsum stack becomes inactive, or if the owner or operator chooses, more frequent measurements may be made over a one year period. These measurements may involve quarterly, monthly or weekly intervals. All radon measurements shall be made as described in paragraphs 3.1.2 through 3.1.6 except that for measurements made over a one year period, the requirement of paragraph 3.1.4(c) shall not apply. For measurements made over a one year period, the radon flux shall be the arithmetic mean of the mean radon flux for each measurement period.

3.1.2 Distribution and Number of Flux Measurements. The distribution and number of radon flux measurements required on a stack will depend on clearly defined areas of the stack (called regions) that can have significantly different radon fluxes due to surface conditions. The mean radon flux shall be determined for each individual region of the stack. Regions that shall be considered are:

- (a) Water covered areas,
- (b) Water saturated areas (beaches),
- (c) Loose and dry top surface areas,
- (d) Hard-packed roadways, and
- (e) Sides.

3.1.3 Number of Flux Measurements. Radon flux measurements shall be made within each region on the phosphogypsum stack, except for those areas covered with water. Measurements shall be made at regularly spaced locations across the surface of the region, realizing that surface roughness will prohibit measurements in some areas of a region. The minimum number of flux measurements considered necessary to determine a representative mean radon flux value for each type of region is:

- (a) Water covered area—no measurements required as radon flux is assumed to be zero,
- (b) Water saturated beaches—50 radon flux measurements,
- (c) Loose and dry top surface—100 radon flux measurements,
- (d) Hard-packed roadways—50 radon flux measurements, and
- (e) Sides—100 radon flux measurements.

A minimum of 300 measurements are required. A stack that has no water cover can be considered to consist of two regions, top and sides, and will require a minimum of only 200 measurements.

3.1.4 Restrictions to Radon Flux Measurements. The following restrictions are placed on making radon flux measurements:

- (a) Measurements shall not be initiated within 24 hours of a rainfall.
- (b) If a rainfall occurs during the 24 hour measurement period, the measurement is invalid if the seal around the lip of the collector has washed away or if the collector is surrounded by water.
- (c) Measurements shall not be performed if the ambient temperature is below 35 °F or if the ground is frozen.

3.1.5 Areas of Stack Regions. The approximate area of each region of the stack shall be determined in units of square meters.

3.1.6 Radon Flux Measurements. Measuring radon flux involves the adsorption of radon on activated charcoal in a large-area collector. The radon collector is placed on the surface of the stack area to be measured and allowed to collect radon for a time period of 24 hours. The radon collected on the charcoal is measured by gamma-ray spectroscopy. The detailed measurement procedure provided in appendix A of EPA 520/5-85-0029(1) shall be used to measure the radon flux on phosphogypsum stacks, except the surface of the phosphogypsum shall not be penetrated by the lip of the radon collector as directed in the procedure, rather the collector shall be carefully positioned on a flat surface with soil or phosphogypsum used to seal the edge.

3.1.7 Calculations. The mean radon flux for each region of the phosphogypsum stack and for the total stack shall be calculated and reported as follows:

(a) The individual radon flux calculations shall be made as provided in appendix A EPA 86 (1). The mean radon flux for each region of the stack shall be calculated by summing all individual flux measurements for the region and dividing by the total number of flux measurements for the region.

(b) The mean radon flux for the total phosphogypsum stack shall be calculated as follows.

$$J_s = \frac{J_1 A_1 + J_2 A_2 + \dots + J_i A_i}{A_t}$$

Where:

J_s = Mean flux for the total stack (pCi/m² -s)

J_i = Mean flux measured in region i (pCi/m² -s)

A_i = Area of region i (m²)

A_t = Total area of the stack

3.1.8 Reporting. The results of individual flux measurements, the approximate locations on the stack, and the mean radon flux for each region and the mean radon flux for the total stack shall be included in the emission test report. Any condition or unusual event that occurred during the measurements that could significantly affect the results should be reported.

4.0 Quality Assurance Procedures for Measuring Rn-222 Flux

A. Sampling Procedures

Records of field activities and laboratory measurements shall be maintained. The following information shall be recorded for each charcoal canister measurement:

- (a) Site
- (b) Name of pile
- (c) Sample location
- (d) Sample ID number
- (e) Date and time on

(f) Date and time off

(g) Observations of meteorological conditions and comments

Records shall include all applicable information associated with determining the sample measurement, calculations, observations, and comments.

B. Sample Custody

Custodial control of all charcoal samples exposed in the field shall be maintained in accordance with EPA chain-of-custody field procedures. A control record shall document all custody changes that occur between the field and laboratory personnel.

C. Calibration Procedures and Frequency

The radioactivity of two standard charcoal sources, each containing a carefully determined quantity of radium-226 uniformly distributed through 180g of activated charcoal, shall be measured. An efficiency factor is computed by dividing the average measured radioactivity of the two standard charcoal sources, minus the background, in cpm by the known radioactivity of the charcoal sources in dpm. The same two standard charcoal sources shall be counted at the beginning and at the end of each day's counting as a check of the radioactivity counting equipment. A background count using unexposed charcoal should also be made at the beginning and at the end of each counting day to check for inadvertent contamination of the detector or other changes affecting the background. The unexposed charcoal comprising the blank is changed with each new batch of charcoal used.

D. Internal Quality Control Checks and Frequency

The charcoal from every tenth exposed canister shall be recounted. Five percent of the samples analyzed shall be either blanks (charcoal having no radioactivity added) or samples spiked with known quantities of radium-226.

E. Data Precision, Accuracy, and Completeness

The precision, accuracy, and completeness of measurements and analyses shall be within the following limits for samples measuring greater than 1.0 pCi/m² -s.

(a) Precision: 10%

(b) Accuracy: ±10%

(c) Completeness: at least 85% of the measurements must yield useable results.

5.0 References

(1) Hartley, J.N. and Freeman, H.D., "Radon Flux Measurements on Gardinier and Royster phosphogypsum Piles Near Tampa and Mulberry, Florida," U.S. Environmental Protection Agency Report, EPA 520/5-85-029, January 1986.

(2) Environmental Protection Agency, "Indoor Radon and Radon Decay Product Measurement Protocols", EPA 520/1-89-009, U.S. Environmental Protection Agency, Washington, DC. (1989).

[38 FR 8826, Apr. 6, 1973]

Editorial Notes: 1. For Federal Register citations to appendix B see the List of CFR Sections Affected, which appears in the Finding Aids section of the printed volume and on GPO Access.

2. At 65 FR 62161, Oct. 17, 2000, appendix B to part 61 was amended by revising Methods 101, 101A, 102, 103, 104, 105, 106, 107, 107A, 108, 108A, 108B, 108C, and 111. However, because the

amendment contains no revised text for Method 107A, this part of the revision could not be incorporated.

Appendix C to Part 61—Quality Assurance Procedures

Procedure 1—Determination of Adequate Chromatographic Peak Resolution

In this method of dealing with resolution, the extent to which one chromatographic peak overlaps another is determined.

For convenience, consider the range of the elution curve of each compound as running from -2σ to $+2\sigma$. This range is used in other resolution criteria, and it contains 95.45 percent of the area of a normal curve. If two peaks are separated by a known distance, b , one can determine the fraction of the area of one curve that lies within the range of the other. The extent to which the elution curve of a contaminant compound overlaps the curve of a compound that is under analysis is found by integrating the contaminant curve over the limits $b-2\sigma_s$ to $b+2\sigma_s$, where σ_s is the standard deviation of the sample curve.

This calculation can be simplified in several ways. Overlap can be determined for curves of unit area; then actual areas can be introduced. Desired integration can be resolved into two integrals of the normal distribution function for which there are convenient calculation programs and tables. An example would be Program 15 in Texas Instruments Program Manual ST1, 1975, Texas Instruments, Inc., Dallas, Texas 75222.

$$\frac{1}{\sqrt{2\pi}\sigma_c} \int_{b-2\sigma_s}^{b+2\sigma_s} e^{-\frac{(x-t_s)^2}{2\sigma_c^2}} dx = \frac{1}{\sqrt{2\pi}} \int_{\frac{b-2\sigma_s}{\sigma_c}}^{\frac{b+2\sigma_s}{\sigma_c}} e^{-\frac{x^2}{2}} dx = \frac{1}{\sqrt{2\pi}} \int_{x_2}^{x_1} e^{-\frac{x^2}{2}} dx$$

The following calculation steps are required:*

1. $2\sigma_s = t_s / \sqrt{2} \ln 2$
2. $\sigma_c = t_c / \sqrt{2} \ln 2$
3. $x_1 = (b+2\sigma_s) / \sigma_c$
4. $x_2 = (b-2\sigma_s) / \sigma_c$
5. $Q(x_1) = \frac{1}{\sqrt{2\pi}} \int_{x_1}^{\infty} e^{-\frac{x^2}{2}} dx$
6. $Q(x_2) = \frac{1}{\sqrt{2\pi}} \int_{x_2}^{\infty} e^{-\frac{x^2}{2}} dx$
7. $I_o = Q(x_1) - Q(x_2)$
8. $A_o = I_o A_s / A_c$
9. Percentage overlap = $A_o \times 100$

where:

- A_s = Area of the sample peak of interest determined by electronic integration or by the formula $A_s = t_s h_s$
- A_c = Area of the contaminant peak, determined in the same manner as A_s
- b = Distance on the chromatographic chart that separates the maxima of the two peaks.
- h_s = Peak height of the sample compound of interest, measured from the average value of the baseline to the maximum of the curve.
- t_s = Width of sample peak of interest at 1/2 peak height.
- t_c = Width of the contaminant peak at 1/2 of peak height.
- σ_s = Standard deviation of the sample compound of interest elution curve.
- σ_c = Standard deviation of the contaminant elution curve.
- $Q(x_1)$ = Integral of the normal distribution function from x_1 to infinity.
- $Q(x_2)$ = Integral of the normal distribution function from x_2 to infinity.
- I_o = Overlap integral.
- A_o = Area overlap fraction.

*In most instances, $Q(x_2)$ is very small and may be neglected.

[View or download PDF](#)

In judging the suitability of alternate GC columns or the effects of altering chromatographic conditions, one can employ the area overlap as the resolution parameter with a specific maximum permissible value.

The use of Gaussian functions to describe chromatographic elution curves is widespread. However, some elution curves are highly asymmetric. In cases where the sample peak is followed by a contaminant that has a leading edge that rises sharply but the curve then tails off, it may be possible to define an effective width for t_c as "twice the distance from the leading edge to a perpendicular line through the maxim of the contaminant curve, measured along a perpendicular bisection of that line."

Procedure 2—Procedure for Field Auditing GC Analysis

Responsibilities of audit supervisor and analyst at the source sampling site include the following:

- A. The audit supervisor verifies that audit cylinders are stored in a safe location both before and after the audit to prevent vandalism.
- B. At the beginning and conclusion of the audit, the analyst records each cylinder number and pressure. An audit cylinder is never analyzed when the pressure drops below 200 psi.
- C. During the audit, the analyst performs a minimum of two consecutive analyses of each audit cylinder gas. The audit must be conducted to coincide with the analysis of source test samples, normally immediately after GC calibration and prior to sample analyses.
- D. At the end of audit analyses, the audit supervisor requests the calculated concentrations from the analyst and compares the results with the actual audit concentrations. If each measured concentration agrees with the respective actual concentration within ± 10 percent, he directs the analyst to begin analyzing source samples. Audit supervisor judgment and/or supervisory policy determine action when agreement is not within ± 10 percent. When a consistent bias in excess of 10 percent is found, it may be possible to proceed with the sample analysis, with a corrective factor to be applied to the results at a later time. However, every attempt should be made to locate the cause of the discrepancy, as it may be misleading. The audit supervisor records each cylinder number, cylinder pressure (at the end of the audit), and all calculated concentrations. The individual being audited must not under any circumstance be told actual audit concentrations until calculated concentrations have been submitted to the audit supervisor.

Field Audit Report

Part A— To be filled out by organization supplying audit cylinders.

- 1. Organization supplying audit sample(s) and shipping address

- 2. Audit supervisor, organization, and phone number

- 3. Shipping instructions: Name, Address, Attention

- 4. Guaranteed arrival date for cylinders _____
- 5. Planned shipping date for cylinders _____

- 6. Details on audit cylinders from last analysis

estimated using the procedures listed in reference re #2. All other emissions may be estimated by using the "Procedures" listed below, or using the method described in reference #1.

2. Procedure

To estimate emissions to the atmosphere:

(a) Determine the amount (in curies) used at facilities for the period under consideration. Radioactive materials in sealed packages that remain unopened, and have not leaked during the assessment period should not be included in the calculation.

(b) Multiply the amount used by the following factors which depend on the physical state of the radionuclide. They are:

(i) 1 for gases;

(ii) 10^{-3} for liquids or particulate solids; and

(iii) 10^{-6} for solids.

If any nuclide is heated to a temperature of 100 degrees Celsius or more, boils at a temperature of 100 degrees Celsius or less, or is intentionally dispersed into the environment, it must be considered to be a gas.

(c) If a control device is installed between the place of use and the point of release, multiply emissions from (b) by an adjustment factor. These are presented in Table 1.

Table 1—Adjustment to Emission Factors for Effluent Controls

Controls	Types of radionuclides controlled	Adjustment factor to emissions	Comments and conditions
HEPA filters	Particulates	0.01	Not applicable to gaseous radionuclides; periodic testing is prudent to ensure high removal efficiency.
Fabric filter	Particulates	0.1	Monitoring would be prudent to guard against tears in filter.
Sintered metal	Particulates	1	Insufficient data to make recommendation.
Activated carbon filters	Iodine gas	0.1	Efficiency is time dependent; monitoring is necessary to ensure effectiveness.
Douglas bags: Held one week or longer for decay	Xenon	0.5/wk	Based on xenon half-life of 5.3 days;
Douglas bags: Released within	Xenon	1	Provides no reduction of exposure to general public.

one week			
Venturi scrubbers	Particulates Gases	0.05 1	Although venturis may remove gases, variability in gaseous removal efficiency dictates adjustment factor for particulates only.
Packed bed scrubbers	Gases	0.1	Not applicable to particulates.
Electrostatic precipitators	Particulates	0.05	Not applicable for gaseous radionuclides
Xenon traps	Xenon	0.1	Efficiency is time dependent; monitoring is necessary to ensure effectiveness.
Fume hoods	All	1	Provides no reduction to general public exposures.
Vent stacks	All	1	Generally provides no reduction of exposure to general public.

References

(1) Environmental Protection Agency, "A Guide for Determining Compliance with the Clean Air Act Standards for Radionuclides Emissions from NRC-Licensed and Non-DOE Federal Facilities", EPA 520/1-89-002, January 1989.

(2) Nuclear Regulatory Commission, "Methods for Estimating Radioactive and Toxic Airborne Source Terms for Uranium Milling Operations", U.S. Nuclear Regulatory Commission Regulatory Guide 3.59, March 1987.

[54 FR 51711, Dec. 15, 1989]

Appendix E to Part 61—Compliance Procedures Methods for Determining Compliance With Subpart I

1. Purpose and Background

This Appendix provides simplified procedures to reduce the burden on Nuclear Regulatory Commission (NRC) licensees, and non-Department of Energy Federal facilities in determining compliance with 40 CFR part 61, subpart I. The procedures consist of a series of increasingly more stringent steps, depending on the facility's potential to exceed the standard.

First, a facility can be found in compliance if the quantity of radioactive material possessed during the year is less than that listed in a table of annual possession quantities. A facility will also be in compliance if the average annual radionuclide emission concentration is less than that listed in a table of air concentration levels. If the facility is not in compliance by these tables, it can establish compliance by estimating a dose using screening procedure developed by the National Council on Radiation Protection and Measurements with a radiological source term derived using EPA approved emission factors. These procedures are described in a "Guide for Determining Compliance with the Clean Air Act Standards for Radionuclide Emissions From NRC-Licensed and Non-DOE Federal Facilities."

A user-friendly computer program called COMPLY has been developed to reduce the burden on the regulated community. The Agency has also prepared a "User's Guide for the COMPLY Code" to assist the regulated community in using the code, and in handling more complex situations such as multiple

release points. The basis for these compliance procedures are provided in "Background Information Document: Procedures Approved for Demonstrating Compliance with 40 CFR Part 61, Subpart I". The compliance model is the highest level in the COMPLY computer code and provides for the most realistic assessment of dose by allowing the use of site-specific information.

2. Table of Annual Possession Quantity

(a) Table 1 may be used for determining if facilities are in compliance with the standard. The possession table can only be used if the following conditions are met:

- (i) No person lives within 10 meters of any release point; and
- (ii) No milk, meat, or vegetables are produced within 100 meters of any release point.

(b) Procedures described in Reference (1) shall be used to determine compliance or exemption from reporting by use of Table 2.

Table 1—Annual Possession Quantities for Environmental Compliance

[Annual Possession Quantities (Ci/yr)]

Radionuclide	Gaseous form*	Liquid/powder forms	Solid form*
Ac-225	9.6E-05	9.6E-02	9.6E+01
Ac-227	1.6E-07	1.6E-04	1.6E-01
Ac-228	3.4E-03	3.4E+00	3.4E+03
Ag-106	1.6E+00	1.6E+03	1.6E+06
Ag-106m	2.6E-03	2.6E+00	2.6E+03
Ag-108m	6.5E-06	6.5E-03	6.5E+00
Ag-110m	9.4E-05	9.4E-02	9.4E+01
Ag-111	6.7E-02	6.7E+01	6.7E+04
Al-26	4.0E-06	4.0E-03	4.0E+00
Am-241	2.3E-06	2.3E-03	2.3E+00
Am-242	1.8E-02	1.8E+01	1.8E+04
Am-242m	2.5E-06	2.5E-03	2.5E+00
Am-243	2.3E-06	2.3E-03	2.3E+00
Am-244	4.6E-02	4.6E+01	4.6E+04
Am-245	7.0E+00	7.0E+03	7.0E+06
Am-246	9.8E-01	9.8E+02	9.8E+05
Ar-37	1.4E+06		
Ar-41	1.4E+00		
As-72	2.9E-02	2.9E+01	2.9E+04
As-73	6.0E-02	6.0E+01	6.0E+04
As-74	4.3E-03	4.3E+00	4.3E+03
As-76	8.8E-02	8.8E+01	8.8E+04
As-77	7.9E-01	7.9E+02	7.9E+05
At-211	1.0E-02	1.0E+01	1.0E+04

Au-193	4.2E-01	4.2E+02	4.2E+05
Au-194	3.5E-02	3.5E+01	3.5E+04
Au-195	3.3E-03	3.3E+00	3.3E+03
Au-198	4.6E-02	4.6E+01	4.6E+04
Au-199	1.5E-01	1.5E+02	1.5E+05
Ba-131	1.0E-02	1.0E+01	1.0E+04
Ba-133	4.9E-05	4.9E-02	4.9E+01
Ba-133m	9.3E-02	9.3E+01	9.3E+04
Ba-135m	5.8E-01	5.8E+02	5.8E+05
Ba-139	4.7E+00	4.7E+03	4.7E+06
Ba-140	2.1E-03	2.1E+00	2.1E+03
Ba-141	1.3E+00	1.3E+03	1.3E+06
Ba-142	1.1E+00	1.1E+03	1.1E+06
Be-7	2.3E-02	2.3E+01	2.3E+04
Be-10	3.0E-03	3.0E+00	3.0E+03
Bi-206	3.1E-03	3.1E+00	3.1E+03
Bi-207	8.4E-06	8.4E-03	8.4E+00
Bi-210	4.2E-03	4.2E+00	4.2E+03
Bi-212	4.7E-02	4.7E+01	4.7E+04
Bi-213	6.0E-02	6.0E+01	6.0E+04
Bi-214	1.4E-01	1.4E+02	1.4E+05
Bk-249	7.0E-04	7.0E-01	7.0E+02
Bk-250	1.0E-01	1.0E+02	1.0E+05
Br-77	7.5E-02	7.5E+01	7.5E+04
Br-80	1.2E+01	1.2E+04	1.2E+07
Br-80m	1.5E+00	1.5E+03	1.5E+06
Br-82	1.6E-02	1.6E+01	1.6E+04
Br-83	9.9E+00	9.9E+03	9.9E+06
Br-84	5.6E-01	5.6E+02	5.6E+05
C-11	1.3E+00	1.3E+03	1.3E+06
C-14	2.9E-01	2.9E+02	2.9E+05
Ca-41	2.7E-02	2.7E+01	2.7E+04
Ca-45	5.8E-02	5.8E+01	5.8E+04
Ca-47	1.1E-02	1.1E+01	1.1E+04
Cd-109	5.0E-03	5.0E+00	5.0E+03
Cd-113	3.3E-04	3.3E-01	3.3E+02
Cd-113m	4.4E-04	4.4E-01	4.4E+02
Cd-115	5.4E-02	5.4E+01	5.4E+04
Cd-115m	1.0E-02	1.0E+01	1.0E+04
Cd-117	5.6E-02	5.6E+01	5.6E+04

Cd-117m	1.3E-01	1.3E+02	1.3E+05
Ce-139	2.6E-03	2.6E+00	2.6E+03
Ce-141	1.8E-02	1.8E+01	1.8E+04
Ce-143	1.0E-01	1.0E+02	1.0E+05
Ce-144	1.7E-03	1.7E+00	1.7E+03
Cf-248	2.0E-05	2.0E-02	2.0E+01
Cf-249	1.7E-06	1.7E-03	1.7E+00
Cf-250	4.0E-06	4.0E-03	4.0E+00
Cf-251	1.7E-06	1.7E-03	1.7E+00
Cf-252	6.4E-06	6.4E-03	6.4E+00
Cf-253	3.3E-04	3.3E-01	3.3E+02
Cf-254	3.6E-06	3.6E-03	3.6E+00
Cl-36	1.9E-04	1.9E-01	1.9E+02
Cl-38	6.5E-01	6.5E+02	6.5E+05
Cm-242	6.0E-05	6.0E-02	6.0E+01
Cm-243	3.3E-06	3.3E-03	3.3E+00
Cm-244	4.2E-06	4.2E-03	4.2E+00
Cm-245	2.3E-06	2.3E-03	2.3E+00
Cm-246	2.3E-06	2.3E-03	2.3E+00
Cm-247	2.3E-06	2.3E-03	2.3E+00
Cm-248	6.4E-07	6.4E-04	6.4E-01
Cm-249	4.6E+00	4.6E+03	4.6E+06
Cm-250	1.1E-07	1.1E-04	1.1E-01
Co-56	2.4E-04	2.4E-01	2.4E+02
Co-57	1.6E-03	1.6E+00	1.6E+03
Co-58	9.0E-04	9.0E-01	9.0E+02
Co-58m	1.7E-01	1.7E+02	1.7E+05
Co-60	1.6E-05	1.6E-02	1.6E+01
Co-60m	4.0E+00	4.0E+03	4.0E+06
Co-61	3.8E+00	3.8E+03	3.8E+06
Cr-49	9.0E-01	9.0E+02	9.0E+05
Cr-51	6.3E-02	6.3E+01	6.3E+04
Cs-129	1.5E-01	1.5E+02	1.5E+05
Cs-131	2.8E-01	2.8E+02	2.8E+05
Cs-132	1.3E-02	1.3E+01	1.3E+04
Cs-134	5.2E-05	5.2E-02	5.2E+01
Cs-134m	3.2E-01	3.2E+02	3.2E+05
Cs-135	2.4E-02	2.4E+01	2.4E+04
Cs-136	2.1E-03	2.1E+00	2.1E+03
Cs-137	2.3E-05	2.3E-02	2.3E+01

Cs-138	4.4E-01	4.4E+02	4.4E+05
Cu-61	4.0E-01	4.0E+02	4.0E+05
Cu-64	5.2E-01	5.2E+02	5.2E+05
Cu-67	1.5E-01	1.5E+02	1.5E+05
Dy-157	4.4E-01	4.4E+02	4.4E+05
Dy-165	5.6E+00	5.6E+03	5.6E+06
Dy-166	8.1E-02	8.1E+01	8.1E+04
Er-169	4.0E-01	4.0E+02	4.0E+05
Er-171	3.6E-01	3.6E+02	3.6E+05
Es-253	2.6E-04	2.6E-01	2.6E+02
Es-254	2.3E-05	2.3E-02	2.3E+01
Es-254m	1.8E-03	1.8E+00	1.8E+03
Eu-152	1.6E-05	1.6E-02	1.6E+01
Eu-152m	3.5E-01	3.5E+02	3.5E+05
Eu-154	2.0E-05	2.0E-02	2.0E+01
Eu-155	5.2E-04	5.2E-01	5.2E+02
Eu-156	3.2E-03	3.2E+00	3.2E+03
F-18	5.6E-01	5.6E+02	5.6E+05
Fe-52	4.9E-02	4.9E+01	4.9E+04
Fe-55	1.4E-01	1.4E+02	1.4E+05
Fe-59	1.3E-03	1.3E+00	1.3E+03
Fm-254	1.8E-02	1.8E+01	1.8E+04
Fm-255	4.0E-03	4.0E+00	4.0E+03
Fr-223	1.4E-01	1.4E+02	1.4E+05
Ga-66	5.6E-02	5.6E+01	5.6E+04
Ga-67	1.1E-01	1.1E+02	1.1E+05
Ga-68	7.6E-01	7.6E+02	7.6E+05
Ga-72	3.6E-02	3.6E+01	3.6E+04
Gd-152	4.4E-06	4.4E-03	4.4E+00
Gd-153	2.0E-03	2.0E+00	2.0E+03
Gd-159	6.8E-01	6.8E+02	6.8E+05
Ge-68	2.3E-04	2.3E-01	2.3E+02
Ge-71	2.6E+00	2.6E+03	2.6E+06
Ge-77	1.0E-01	1.0E+02	1.0E+05
H-3	1.5E+01	1.5E+04	1.5E+07
Hf-181	2.5E-03	2.5E+00	2.5E+03
Hg-193m	9.5E-02	9.5E+01	9.5E+04
Hg-197	2.4E-01	2.4E+02	2.4E+05
Hg-197m	2.5E-01	2.5E+02	2.5E+05
Hg-203	5.2E-03	5.2E+00	5.2E+03

Ho-166	2.8E-01	2.8E+02	2.8E+05
Ho-166m	6.0E-06	6.0E-03	6.0E+00
I-123	4.9E-01	4.9E+02	4.9E+05
I-124	9.3E-03	9.3E+00	9.3E+03
I-125	6.2E-03	6.2E+00	6.2E+03
I-126	3.7E-03	3.7E+00	3.7E+03
I-128	9.3E+00	9.3E+03	9.3E+06
I-129	2.6E-04	2.6E-01	2.6E+02
I-130	4.6E-02	4.6E+01	4.6E+04
I-131	6.7E-03	6.7E+00	6.7E+03
I-132	2.0E-01	2.0E+02	2.0E+05
I-133	6.7E-02	6.7E+01	6.7E+04
I-134	3.2E-01	3.2E+02	3.2E+05
I-135	1.2E-01	1.2E+02	1.2E+05
In-111	4.9E-02	4.9E+01	4.9E+04
In-113m	2.1E+00	2.1E+03	2.1E+06
In-114m	4.9E-03	4.9E+00	4.9E+03
In-115	2.7E-04	2.7E-01	2.7E+02
In-115m	1.4E+00	1.4E+03	1.4E+06
In-116m	3.5E-01	3.5E+02	3.5E+05
In-117	1.3E+00	1.3E+03	1.3E+06
In-117m	7.6E-02	7.6E+01	7.6E+04
Ir-190	3.5E-03	3.5E+00	3.5E+03
Ir-192	9.7E-04	9.7E-01	9.7E+02
Ir-194	2.5E-01	2.5E+02	2.5E+05
Ir-194m	1.5E-04	1.5E-01	1.5E+02
K-40	6.8E-05	6.8E-02	6.8E+01
K-42	2.9E-01	2.9E+02	2.9E+05
K-43	6.0E-02	6.0E+01	6.0E+04
K-44	4.9E-01	4.9E+02	4.9E+05
Kr-79	7.0E+00		
Kr-81	1.8E+02		
Kr-83m	2.0E+04		
Kr-85	8.4E+02		
Kr-85m	1.1E+01		
Kr-87	2.0E+00		
Kr-88	4.2E-01		
La-140	1.6E-02	1.6E+01	1.6E+04
La-141	1.1E+00	1.1E+03	1.1E+06
La-142	2.3E-01	2.3E+02	2.3E+05

Lu-177	1.4E-01	1.4E+02	1.4E+05
Lu-177m	3.5E-04	3.5E-01	3.5E+02
Mg-28	2.1E-02	2.1E+01	2.1E+04
Mn-52	3.5E-03	3.5E+00	3.5E+03
Mn-52m	5.2E-01	5.2E+02	5.2E+05
Mn-53	5.7E-02	5.7E+01	5.7E+04
Mn-54	2.5E-04	2.5E-01	2.5E+02
Mn-56	2.5E-01	2.5E+02	2.5E+05
Mo-93	1.5E-03	1.5E+00	1.5E+03
Mo-99**	5.7E-02	5.7E+01	5.7E+04
Mo-101	8.4E-01	8.4E+02	8.4E+05
Na-22	3.2E-05	3.2E-02	3.2E+01
Na-24	2.6E-02	2.6E+01	2.6E+04
Nb-90	2.5E-02	2.5E+01	2.5E+04
Nb-93m	1.2E-02	1.2E+01	1.2E+04
Nb-94	6.0E-06	6.0E-03	6.0E+00
Nb-95	2.3E-03	2.3E+00	2.3E+03
Nb-95m	2.0E-02	2.0E+01	2.0E+04
Nb-96	2.5E-02	2.5E+01	2.5E+04
Nb-97	1.0E+00	1.0E+03	1.0E+06
Nd-147	3.0E-02	3.0E+01	3.0E+04
Nd-149	1.1E+00	1.1E+03	1.1E+06
Ni-56	2.0E-03	2.0E+00	2.0E+03
Ni-57	2.1E-02	2.1E+01	2.1E+04
Ni-59	2.2E-02	2.2E+01	2.2E+04
Ni-63	1.4E-01	1.4E+02	1.4E+05
Ni-65	7.0E-01	7.0E+02	7.0E+05
Np-235	3.0E-02	3.0E+01	3.0E+04
Np-237	1.8E-06	1.8E-03	1.8E+00
Np-238	1.9E-02	1.9E+01	1.9E+04
Np-239	1.0E-01	1.0E+02	1.0E+05
Np-240	6.5E-01	6.5E+02	6.5E+05
Np-240m	4.7E+00	4.7E+03	4.7E+06
Os-185	9.2E-04	9.2E-01	9.2E+02
Os-191m	9.0E-01	9.0E+02	9.0E+05
Os-191	3.8E-02	3.8E+01	3.8E+04
Os-193	2.9E-01	2.9E+02	2.9E+05
P-32	1.7E-02	1.7E+01	1.7E+04
P-33	1.2E-01	1.2E+02	1.2E+05
Pa-230	6.3E-04	6.3E-01	6.3E+02

Pa-231	8.3E-07	8.3E-04	8.3E-01
Pa-233	9.3E-03	9.3E+00	9.3E+03
Pa-234	9.3E-02	9.3E+01	9.3E+04
Pb-203	8.3E-02	8.3E+01	8.3E+04
Pb-205	1.2E-02	1.2E+01	1.2E+04
Pb-209	1.1E+01	1.1E+04	1.1E+07
Pb-210	5.5E-05	5.5E-02	5.5E+01
Pb-211	1.2E-01	1.2E+02	1.2E+05
Pb-212	6.0E-03	6.0E+00	6.0E+03
Pb-214	1.2E-01	1.2E+02	1.2E+05
Pd-103	2.1E-01	2.1E+02	2.1E+05
Pd-107	8.2E-02	8.2E+01	8.2E+04
Pd-109	9.4E-01	9.4E+02	9.4E+05
Pm-143	7.6E-04	7.6E-01	7.6E+02
Pm-144	1.1E-04	1.1E-01	1.1E+02
Pm-145	5.2E-04	5.2E-01	5.2E+02
Pm-146	4.4E-05	4.4E-02	4.4E+01
Pm-147	2.6E-02	2.6E+01	2.6E+04
Pm-148	1.7E-02	1.7E+01	1.7E+04
Pm-148m	7.6E-04	7.6E-01	7.6E+02
Pm-149	2.8E-01	2.8E+02	2.8E+05
Pm-151	1.2E-01	1.2E+02	1.2E+05
Po-210	9.3E-05	9.3E-02	9.3E+01
Pr-142	2.8E-01	2.8E+02	2.8E+05
Pr-143	1.0E-01	1.0E+02	1.0E+05
Pr-144	1.5E+01	1.5E+04	1.5E+07
Pt-191	6.4E-02	6.4E+01	6.4E+04
Pt-193	2.1E-02	2.1E+01	2.1E+04
Pt-193m	4.8E-01	4.8E+02	4.8E+05
Pt-195m	1.4E-01	1.4E+02	1.4E+05
Pt-197	1.1E+00	1.1E+03	1.1E+06
Pt-197m	3.6E+00	3.6E+03	3.6E+06
Pu-236	7.0E-06	7.0E-03	7.0E+00
Pu-237	2.3E-02	2.3E+01	2.3E+04
Pu-238	2.7E-06	2.7E-03	2.7E+00
Pu-239	2.5E-06	2.5E-03	2.5E+00
Pu-240	2.5E-06	2.5E-03	2.5E+00
Pu-241	1.3E-04	1.3E-01	1.3E+02
Pu-242	2.5E-06	2.5E-03	2.5E+00
Pu-243	3.8E+00	3.8E+03	3.8E+06

Pu-244	2.4E-06	2.4E-03	2.4E+00
Pu-245	2.1E-01	2.1E+02	2.1E+05
Pu-246	4.8E-03	4.8E+00	4.8E+03
Ra-223	1.3E-04	1.3E-01	1.3E+02
Ra-224	3.2E-04	3.2E-01	3.2E+02
Ra-225	1.3E-04	1.3E-01	1.3E+02
Ra-226	5.5E-06	5.5E-03	5.5E+00
Ra-228	1.3E-05	1.3E-02	1.3E+01
Rb-81	4.2E-01	4.2E+02	4.2E+05
Rb-83	1.4E-03	1.4E+00	1.4E+03
Rb-84	2.0E-03	2.0E+00	2.0E+03
Rb-86	1.7E-02	1.7E+01	1.7E+04
Rb-87	1.0E-02	1.0E+01	1.0E+04
Rb-88	1.7E+00	1.7E+03	1.7E+06
Rb-89	6.4E-01	6.4E+02	6.4E+05
Re-184	1.8E-03	1.8E+00	1.8E+03
Re-184m	3.6E-04	3.6E-01	3.6E+02
Re-186	1.9E-01	1.9E+02	1.9E+05
Re-187	9.3E+00	9.3E+03	9.3E+06
Re-188	3.7E-01	3.7E+02	3.7E+05
Rh-103m	1.7E+02	1.7E+05	1.7E+08
Rh-105	3.4E-01	3.4E+02	3.4E+05
Ru-97	8.3E-02	8.3E+01	8.3E+04
Ru-103	3.1E-03	3.1E+00	3.1E+03
Ru-105	2.9E-01	2.9E+02	2.9E+05
Ru-106	5.9E-04	5.9E-01	5.9E+02
S-35	7.5E-02	7.5E+01	7.5E+04
Sb-117	2.0E+00	2.0E+03	2.0E+06
Sb-122	3.9E-02	3.9E+01	3.9E+04
Sb-124	6.0E-04	6.0E-01	6.0E+02
Sb-125	1.4E-04	1.4E-01	1.4E+02
Sb-126	1.8E-03	1.8E+00	1.8E+03
Sb-126m	7.6E-01	7.6E+02	7.6E+05
Sb-127	2.0E-02	2.0E+01	2.0E+04
Sb-129	1.8E-01	1.8E+02	1.8E+05
Sc-44	1.4E-01	1.4E+02	1.4E+05
Sc-46	4.0E-04	4.0E-01	4.0E+02
Sc-47	1.1E-01	1.1E+02	1.1E+05
Sc-48	1.1E-02	1.1E+01	1.1E+04
Sc-49	1.0E+01	1.0E+04	1.0E+07

Se-73	1.6E-01	1.6E+02	1.6E+05
Se-75	1.1E-03	1.1E+00	1.1E+03
Se-79	6.9E-03	6.9E+00	6.9E+03
Si-31	4.7E+00	4.7E+03	4.7E+06
Si-32	7.2E-04	7.2E-01	7.2E+02
Sm-147	1.4E-05	1.4E-02	1.4E+01
Sm-151	3.5E-02	3.5E+01	3.5E+04
Sm-153	2.4E-01	2.4E+02	2.4E+05
Sn-113	1.9E-03	1.9E+00	1.9E+03
Sn-117m	2.3E-02	2.3E+01	2.3E+04
Sn-119m	2.8E-02	2.8E+01	2.8E+04
Sn-123	1.8E-02	1.8E+01	1.8E+04
Sn-125	7.2E-03	7.2E+00	7.2E+03
Sn-126	4.7E-06	4.7E-03	4.7E+00
Sr-82	1.9E-03	1.9E+00	1.9E+03
Sr-85	1.9E-03	1.9E+00	1.9E+03
Sr-85m	1.5E+00	1.5E+03	1.5E+06
Sr-87m	1.2E+00	1.2E+03	1.2E+06
Sr-89	2.1E-02	2.1E+01	2.1E+04
Sr-90	5.2E-04	5.2E-01	5.2E+02
Sr-91	1.2E-01	1.2E+02	1.2E+05
Sr-92	2.5E-01	2.5E+02	2.5E+05
Ta-182	4.4E-04	4.4E-01	4.4E+02
Tb-157	2.2E-03	2.2E+00	2.2E+03
Tb-160	8.4E-04	8.4E-01	8.4E+02
Tc-95	9.0E-02	9.0E+01	9.0E+04
Tc-95m	1.4E-03	1.4E+00	1.4E+03
Tc-96	5.6E-03	5.6E+00	5.6E+03
Tc-96m	7.0E-01	7.0E+02	7.0E+05
Tc-97	1.5E-03	1.5E+00	1.5E+03
Tc-97m	7.2E-02	7.2E+01	7.2E+04
Tc-98	6.4E-06	6.4E-03	6.4E+00
Tc-99	9.0E-03	9.0E+00	9.0E+03
Tc-99m	1.4E+00	1.4E+03	1.4E+06
Tc-101	3.8E+00	3.8E+03	3.8E+06
Te-121	6.0E-03	6.0E+00	6.0E+03
Te-121m	5.3E-04	5.3E-01	5.3E+02
Te-123	1.2E-03	1.2E+00	1.2E+03
Te-123m	2.7E-03	2.7E+00	2.7E+03
Te-125m	1.5E-02	1.5E+01	1.5E+04

Te-127	2.9E+00	2.9E+03	2.9E+06
Te-127m	7.3E-03	7.3E+00	7.3E+03
Te-129	6.5E+00	6.5E+03	6.5E+06
Te-129m	6.1E-03	6.1E+00	6.1E+03
Te-131	9.4E-01	9.4E+02	9.4E+05
Te-131m	1.8E-02	1.8E+01	1.8E+04
Te-132	6.2E-03	6.2E+00	6.2E+03
Te-133	1.2E+00	1.2E+03	1.2E+06
Te-133m	2.9E-01	2.9E+02	2.9E+05
Te-134	4.4E-01	4.4E+02	4.4E+05
Th-226	3.0E-02	3.0E+01	3.0E+04
Th-227	6.4E-05	6.4E-02	6.4E+01
Th-228	2.9E-06	2.9E-03	2.9E+00
Th-229	4.9E-07	4.9E-04	4.9E-01
Th-230	3.2E-06	3.2E-03	3.2E+00
Th-231	8.4E-01	8.4E+02	8.4E+05
Th-232	6.0E-07	6.0E-04	6.0E-01
Th-234	2.0E-02	2.0E+01	2.0E+04
Ti-44	5.2E-06	5.2E-03	5.2E+00
Ti-45	4.0E-01	4.0E+02	4.0E+05
Tl-200	4.4E-02	4.4E+01	4.4E+04
Tl-201	1.8E-01	1.8E+02	1.8E+05
Tl-202	1.0E-02	1.0E+01	1.0E+04
Tl-204	2.5E-02	2.5E+01	2.5E+04
Tm-170	2.4E-02	2.4E+01	2.4E+04
Tm-171	5.9E-02	5.9E+01	5.9E+04
U-230	5.0E-05	5.0E-02	5.0E+01
U-231	1.4E-01	1.4E+02	1.4E+05
U-232	1.3E-06	1.3E-03	1.3E+00
U-233	7.6E-06	7.6E-03	7.6E+00
U-234	7.6E-06	7.6E-03	7.6E+00
U-235	7.0E-06	7.0E-03	7.0E+00
U-236	8.4E-06	8.4E-03	8.4E+00
U-237	4.7E-02	4.7E+01	4.7E+04
U-238	8.6E-06	8.6E-03	8.6E+00
U-239	8.3E+00	8.3E+03	8.3E+06
U-240	1.8E-01	1.8E+02	1.8E+05
V-48	1.4E-03	1.4E+00	1.4E+03
V-49	1.3E+00	1.3E+03	1.3E+06
W-181	1.1E-02	1.1E+01	1.1E+04

W-185	1.6E-01	1.6E+02	1.6E+05
W-187	1.1E-01	1.1E+02	1.1E+05
W-188	1.0E-02	1.0E+01	1.0E+04
Xe-122	7.6E-02	7.6E+01	7.6E+04
Xe-123	1.6E+00	1.6E+03	1.6E+06
Xe-125	6.0E-01		
Xe-127	7.0E+00		
Xe-129m	7.6E+01		
Xe-131m	2.2E+02		
Xe-133	5.2E+01		
Xe-133m	6.0E+01		
Xe-135	7.6E+00		
Xe-135m	4.2E+00		
Xe-138	9.9E-01		
Y-86	2.8E-02	2.8E+01	2.8E+04
Y-87	2.3E-02	2.3E+01	2.3E+04
Y-88	2.5E-04	2.5E-01	2.5E+02
Y-90	1.1E-01	1.1E+02	1.1E+05
Y-90m	4.3E-01	4.3E+02	4.3E+05
Y-91	1.8E-02	1.8E+01	1.8E+04
Y-91m	1.6E+00	1.6E+03	1.6E+06
Y-92	7.0E-01	7.0E+02	7.0E+05
Y-93	3.8E-01	3.8E+02	3.8E+05
Yb-169	5.5E-03	5.5E+00	5.5E+03
Yb-175	2.1E-01	2.1E+02	2.1E+05
Zn-62	8.6E-02	8.6E+01	8.6E+04
Zn-65	4.4E-04	4.4E-01	4.4E+02
Zn-69	2.7E+01	2.7E+04	2.7E+07
Zn-69m	2.0E-01	2.0E+02	2.0E+05
Zr-86	2.4E-02	2.4E+01	2.4E+04
Zr-88	2.7E-04	2.7E-01	2.7E+02
Zr-89	1.6E-02	1.6E+01	1.6E+04
Zr-93	2.8E-03	2.8E+00	2.8E+03
Zr-95	6.4E-04	6.4E-01	6.4E+02
Zr-97	4.6E-02	4.6E+01	4.6E+04

*Radionuclides boiling at 100°C or less, or exposed to a temperature of 100°C, must be considered a gas. Capsules containing radionuclides in liquid or powder form can be considered to be solids.

**Mo-99 contained in a generator to produce Technetium-99 can be assumed to be a solid.

3. Table of Concentration Levels

(a) Table 2 may be used for determining if facilities are in compliance with the standard.

1. The concentration table as applied to emission estimates can only be used if all releases are from point sources and concentrations have been measured at the stack or vent using EPA-approved methods, and the distance between each stack or vent and the nearest resident is greater than 3 times the diameter of the stack or vent. Procedures provided in Ref. (1) shall be used to determine compliance or exemption from reporting by use of Table 2.

2. The concentration table may be used to determine compliance with the standard based on environmental measurements provided these measurements are made in conformance with the requirements of §61.107(b)(5).

4. NCRP Screening Model

The procedures described in Reference (4) may be used to determine doses to members of the general public from emissions of radionuclides to the atmosphere. Both the total dose from all radionuclides emitted, and the dose caused by radioactive iodine must be considered in accordance with the procedures in Ref. (1).

5. The COMPLY Computer Code

The COMPLY computer code may be used to determine compliance with subpart I. The compliance model in the COMPLY computer code may be used to determine the dose to members of the general public from emissions of radionuclides to the atmosphere. The EPA may add radionuclides to all or any part of COMPLY to cover radionuclides that may be used by the regulated community.

Table 2—Concentration Levels for Environmental Compliance

Radionuclide	Concentration (Ci/m³)	Radionuclide	Concentration (Ci/m³)
Ac-225	9.1E-14	Bi-207	1.0E-14
Ac-227	1.6E-16	Bi-210	2.9E-13
Ac-228	3.7E-12	Bi-212	5.6E-11
Ag-106	1.9E-09	Bi-213	7.1E-11
Ag-106m	1.2E-12	Bi-214	1.4E-10
Ag-108m	7.1E-15	Bk-249	5.6E-13
Ag-110m	9.1E-14	Bk-250	9.1E-11
Ag-111	2.5E-12	Br-77	4.2E-11
Al-26	4.8E-15	Br-80	1.4E-08
Am-241	1.9E-15	Br-80m	1.8E-09
Am-242	1.5E-11	Br-82	1.2E-11
Am-242m	2.0E-15	Br-83	1.2E-08
Am-243	1.8E-15	Br-84	6.7E-10
Am-244	4.0E-11	C-11	1.5E-09
Am-245	8.3E-09	C-14	1.0E-11
Am-246	1.2E-09	Ca-41	4.2E-13
Ar-37	1.6E-03	Ca-45	1.3E-12
Ar-41	1.7E-09	Ca-47	2.4E-12
As-72	2.4E-11	Cd-109	5.9E-13
As-73	1.1E-11	Cd-113	9.1E-15

As-74	2.2E-12	Cd-113m	1.7E-14
As-76	5.0E-11	Cd-115	1.6E-11
As-77	1.6E-10	Cd-115m	8.3E-13
At-211	1.1E-11	Cd-117	6.7E-11
Au-193	3.8E-10	Cd-117m	1.6E-10
Au-194	3.2E-11	Ce-139	2.6E-12
Au-195	3.1E-12	Ce-141	6.3E-12
Au-198	2.1E-11	Ce-143	3.0E-11
Au-199	4.8E-11	Ce-144	6.2E-13
Ba-131	7.1E-12	Cf-248	1.8E-14
Ba-133	5.9E-14	Cf-249	1.4E-15
Ba-133m	5.9E-11	Cf-250	3.2E-15
Ba-135m	1.8E-10	Cf-251	1.4E-15
Ba-139	5.6E-09	Cf-252	5.6E-15
Ba-140	1.3E-12	Cf-253	3.1E-13
Ba-141	1.4E-09	Cf-254	3.0E-15
Ba-142	1.3E-09	Cl-36	2.7E-15
Be-7	2.3E-11	Cl-38	7.7E-10
Be-10	1.6E-12	Cm-242	5.3E-14
Bi-206	2.3E-12	Cm-243	2.6E-15
Cm-244	3.3E-15	Eu-156	1.9E-12
Cm-245	1.8E-15	F-18	6.7E-10
Cm-246	1.9E-15	Fe-52	5.6E-11
Cm-247	1.9E-15	Fe-55	9.1E-12
Cm-248	5.0E-16	Fe-59	6.7E-13
Cm-249	3.7E-09	Fm-254	2.0E-11
Cm-250	9.1E-17	Fm-255	4.3E-12
Co-56	1.8E-13	Fr-223	3.3E-11
Co-57	1.3E-12	Ga-66	6.2E-11
Co-58	6.7E-13	Ga-67	7.1E-11
Co-58m	1.2E-10	Ga-68	9.1E-10
Co-60	1.7E-14	Ga-72	3.8E-11
Co-60m	4.3E-09	Gd-152	5.0E-15
Co-61	4.5E-09	Gd-153	2.1E-12
Cr-49	1.1E-09	Gd-159	2.9E-10
Cr-51	3.1E-11	Ge-68	2.0E-13
Cs-129	1.4E-10	Ge-71	2.4E-10
Cs-131	3.3E-11	Ge-77	1.0E-10
Cs-132	4.8E-12	H-3	1.5E-09
Cs-134	2.7E-14	Hf-181	1.9E-12

Cs-134m	1.7E-10	Hg-193m	1.0E-10
Cs-135	4.0E-13	Hg-197	8.3E-11
Cs-136	5.3E-13	Hg-197m	1.1E-10
Cs-137	1.9E-14	Hg-203	1.0E-12
Cs-138	5.3E-10	Ho-166	7.1E-11
Cu-61	4.8E-10	Ho-166m	7.1E-15
Cu-64	5.3E-10	I-123	4.3E-10
Cu-67	5.0E-11	I-124	6.2E-13
Dy-157	5.0E-10	I-125	1.2E-13
Dy-165	6.7E-09	I-126	1.1E-13
Dy-166	1.1E-11	I-128	1.1E-08
Er-169	2.9E-11	I-129	9.1E-15
Er-171	4.0E-10	I-130	4.5E-11
Es-253	2.4E-13	I-131	2.1E-13
Es-254	2.0E-14	I-132	2.3E-10
Es-254m	1.8E-12	I-133	2.0E-11
Eu-152	2.0E-14	I-134	3.8E-10
Eu-152m	3.6E-10	I-135	1.2E-10
Eu-154	2.3E-14	In-111	3.6E-11
Eu-155	5.9E-13	In-113m	2.5E-09
In-114m	9.1E-13	Nb-95	2.2E-12
In-115	7.1E-14	Nb-95m	1.4E-11
In-115m	1.6E-09	Nb-96	2.4E-11
In-116m	4.2E-10	Nb-97	1.2E-09
In-117	1.6E-09	Nd-147	7.7E-12
In-117m	9.1E-11	Nd-149	7.1E-10
Ir-190	2.6E-12	Ni-56	1.7E-12
Ir-192	9.1E-13	Ni-57	1.8E-11
Ir-194	1.1E-10	Ni-59	1.5E-11
Ir-194m	1.7E-13	Ni-63	1.4E-11
K-40	2.7E-14	Ni-65	8.3E-10
K-42	2.6E-10	Np-235	2.5E-11
K-43	6.2E-11	Np-237	1.2E-15
K-44	5.9E-10	Np-238	1.4E-11
Kr-79	8.3E-09	Np-239	3.8E-11
Kr-81	2.1E-07	Np-240	7.7E-10
Kr-83m	2.3E-05	Np-240m	5.6E-09
Kr-85	1.0E-06	Os-185	1.0E-12
Kr-85m	1.3E-08	Os-191m	2.9E-10
Kr-87	2.4E-09	Os-191	1.1E-11

Kr-88	5.0E-10	Os-193	9.1E-11
La-140	1.2E-11	P-32	3.3E-13
La-141	7.7E-10	P-33	2.4E-12
La-142	2.7E-10	Pa-230	3.2E-13
Lu-177	2.4E-11	Pa-231	5.9E-16
Lu-177m	3.6E-13	Pa-233	4.8E-12
Mg-28	1.5E-11	Pa-234	1.1E-10
Mn-52	2.8E-12	Pb-203	6.2E-11
Mn-52m	6.2E-10	Pb-205	5.6E-12
Mn-53	1.5E-11	Pb-209	1.3E-08
Mn-54	2.8E-13	Pb-210	2.8E-15
Mn-56	2.9E-10	Pb-211	1.4E-10
Mo-93	1.1E-12	Pb-212	6.3E-12
Mo-99	1.4E-11	Pb-214	1.2E-10
Mo-101	1.0E-09	Pd-103	3.8E-11
Na-22	2.6E-14	Pd-107	3.1E-11
Na-24	2.6E-11	Pd-109	4.8E-10
Nb-90	2.6E-11	Pm-143	9.1E-13
Nb-93m	1.0E-11	Pm-144	1.3E-13
Nb-94	7.1E-15	Pm-145	6.2E-13
Pm-146	5.3E-14	Re-184m	3.7E-13
Pm-147	1.1E-11	Re-186	1.8E-11
Pm-148	5.0E-12	Re-187	2.6E-10
Pm-148m	6.7E-13	Re-188	1.7E-10
Pm-149	4.2E-11	Rh-103m	2.1E-07
Pm-151	7.1E-11	Rh-105	1.3E-10
Po-210	7.1E-15	Ru-97	6.7E-11
Pr-142	1.1E-10	Ru-103	2.6E-12
Pr-143	7.1E-12	Ru-105	2.8E-10
Pr-144	1.8E-08	Ru-106	3.4E-13
Pt-191	4.3E-11	S-35	1.3E-12
Pt-193	1.8E-11	Sb-117	2.4E-09
Pt-193m	4.8E-11	Sb-122	1.4E-11
Pt-195m	3.2E-11	Sb-124	5.3E-13
Pt-197	4.0E-10	Sb-125	1.6E-13
Pt-197m	2.6E-09	Sb-126	1.4E-12
Pu-236	5.9E-15	Sb-126m	9.1E-10
Pu-237	1.9E-11	Sb-127	7.1E-12
Pu-238	2.1E-15	Sb-129	7.7E-11
Pu-239	2.0E-15	Sc-44	1.7E-10

Pu-240	2.0E-15	Sc-46	4.2E-13
Pu-241	1.0E-13	Sc-47	3.8E-11
Pu-242	2.0E-15	Sc-48	9.1E-12
Pu-243	4.2E-09	Sc-49	1.2E-08
Pu-244	2.0E-15	Se-73	1.7E-10
Pu-245	2.1E-10	Se-75	1.7E-13
Pu-246	2.2E-12	Se-79	1.1E-13
Ra-223	4.2E-14	Si-31	5.6E-09
Ra-224	1.5E-13	Si-32	3.4E-14
Ra-225	5.0E-14	Sm-147	1.4E-14
Ra-226	3.3E-15	Sm-151	2.1E-11
Ra-228	5.9E-15	Sm-153	5.9E-11
Rb-81	5.0E-10	Sn-113	1.4E-12
Rb-83	3.4E-13	Sn-117m	5.6E-12
Rb-84	3.6E-13	Sn-119m	5.3E-12
Rb-86	5.6E-13	Sn-123	1.1E-12
Rb-87	1.6E-13	Sn-125	1.7E-12
Rb-88	2.1E-09	Sn-126	5.3E-15
Rb-89	7.1E-10	Sr-82	6.2E-13
Re-184	1.5E-12	Sr-85	1.8E-12
Sr-85m	1.6E-09	Th-232	6.2E-16
Sr-87m	1.4E-09	Th-234	2.2E-12
Sr-89	1.8E-12	Ti-44	6.2E-15
Sr-90	1.9E-14	Ti-45	4.8E-10
Sr-91	9.1E-11	Tl-200	4.5E-11
Sr-92	2.9E-10	Tl-201	1.0E-10
Ta-182	4.5E-13	Tl-202	5.0E-12
Tb-157	2.5E-12	Tl-204	1.2E-12
Tb-160	7.7E-13	Tm-170	3.3E-12
Tc-95	1.0E-10	Tm-171	2.6E-11
Tc-95m	1.4E-12	U-230	1.5E-14
Tc-96	5.6E-12	U-231	4.2E-11
Tc-96m	6.7E-10	U-232	1.3E-15
Tc-97	7.1E-13	U-233	7.1E-15
Tc-97m	7.1E-12	U-234	7.7E-15
Tc-98	6.7E-15	U-235	7.1E-15
Tc-99	1.4E-13	U-236	7.7E-15
Tc-99m	1.7E-09	U-237	1.0E-11
Tc-101	4.5E-09	U-238	8.3E-15
Te-121	1.0E-12	U-239	4.3E-09

Te-121m	1.2E-13	U-240	1.3E-10
Te-123	1.4E-13	V-48	1.0E-12
Te-123m	2.0E-13	V-49	1.6E-10
Te-125m	3.6E-13	W-181	6.7E-12
Te-127	1.0E-09	W-185	2.6E-12
Te-127m	1.5E-13	W-187	7.7E-11
Te-129	7.7E-09	W-188	5.3E-13
Te-129m	1.4E-13	Xe-122	9.1E-11
Te-131	9.1E-11	Xe-123	1.6E-09
Te-131m	1.0E-12	Xe-125	1.1E-11
Te-132	7.1E-13	Xe-127	8.3E-09
Te-133	9.1E-10	Xe-129m	9.1E-08
Te-133m	2.2E-10	Xe-131m	2.6E-07
Te-134	5.3E-10	Xe-133	6.2E-08
Th-226	3.4E-11	Xe-133m	7.1E-08
Th-227	3.8E-14	Xe-135	9.1E-09
Th-228	3.1E-15	Xe-135m	5.0E-09
Th-229	5.3E-16	Xe-138	1.2E-09
Th-230	3.4E-15	Y-86	3.0E-11
Th-231	2.9E-10	Y-87	1.7E-11
Y-88	2.7E-13	Zn-65	9.1E-14
Y-90	1.3E-11	Zn-69	3.2E-08
Y-90m	1.9E-10	Zn-69m	1.7E-10
Y-91	2.1E-12	Zr-86	2.4E-11
Y-91m	1.3E-09	Zr-88	3.1E-13
Y-92	8.3E-10	Zr-89	1.3E-11
Y-93	2.9E-10	Zr-93	2.6E-12
Yb-169	3.7E-12	Zr-95	6.7E-13
Yb-175	4.3E-11	Zr-97	3.8E-11
Zn-62	9.1E-11		

6. References

(1) Environmental Protection Agency, "A Guide for Determining Compliance with the Clean Air Act Standards for Radionuclides Emissions from NRC-Licensed and Non-DOE Federal Facilities", EPA 520/1-89-002, October 1989.

(2) Environmental Protection Agency, "User's Guide for the COMPLY Code", EPA 520/1-89-003, October 1989.

(3) Environmental Protection Agency, "Background Information Document: Procedures Approved for Demonstrating Compliance with 40 CFR Part 61, Subpart I", EPA 520/1-89-001, January 1989.

(4) National Council on Radiation Protection and Measurement, "Screening Techniques for Determining Compliance with Environmental Standards" NCRP Commentary No. 3, Revision of January 1989 with

addendum of October, 1989.

[54 FR 51711, Dec. 15, 1989]

[Browse Previous](#)

For questions or comments regarding e-CFR editorial content, features, or design, email ecfr@nara.gov.

For questions concerning e-CFR programming and delivery issues, email webteam@gpo.gov.

[Section 508 / Accessibility](#)

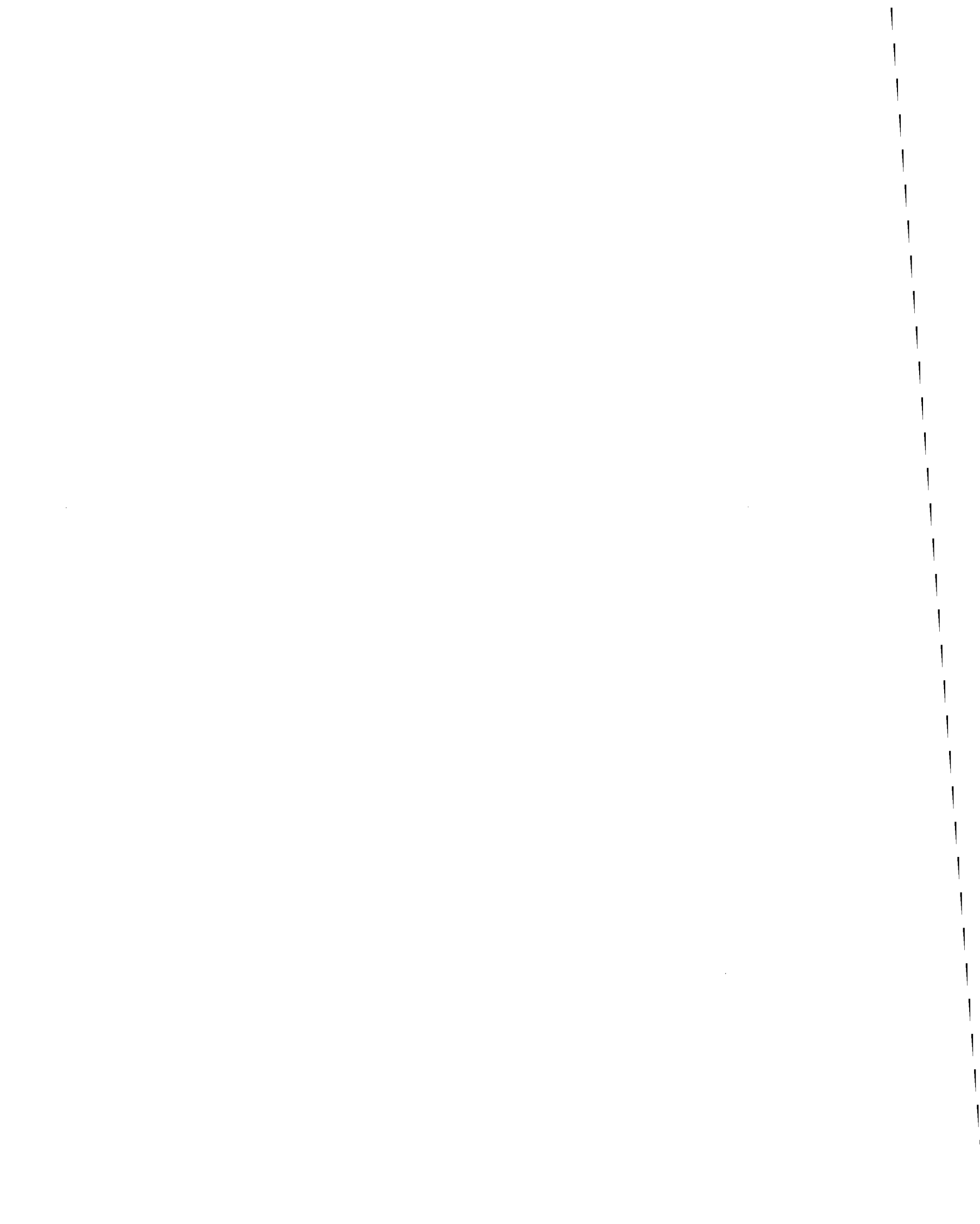

[Home Page](#) > [Executive Branch](#) > [Code of Federal Regulations](#) > [Electronic Code of Federal Regulations](#)

Electronic Code of Federal Regulations

e-CFRTM

e-CFR Data is current as of August 1, 2007

Title 40: Protection of Environment

PART 63—NATIONAL EMISSION STANDARDS FOR HAZARDOUS AIR POLLUTANTS FOR SOURCE CATEGORIES

[Browse Previous](#) | [Browse Next](#)

Subpart F—National Emission Standards for Organic Hazardous Air Pollutants From the Synthetic Organic Chemical Manufacturing Industry

Source: 59 FR 19454, Apr. 22, 1994, unless otherwise noted.

§ 63.100 Applicability and designation of source.

(a) This subpart provides applicability provisions, definitions, and other general provisions that are applicable to subparts G and H of this part.

(b) Except as provided in paragraphs (b)(4) and (c) of this section, the provisions of subparts F, G, and H of this part apply to chemical manufacturing process units that meet all the criteria specified in paragraphs (b)(1), (b)(2), and (b)(3) of this section:

(1) Manufacture as a primary product one or more of the chemicals listed in paragraphs (b)(1)(i) or (b)(1)(ii) of this section.

(i) One or more of the chemicals listed in table 1 of this subpart; or

(ii) One or more of the chemicals listed in paragraphs (b)(1)(ii)(A) or (b)(1)(ii)(B) of this section:

(A) Tetrahydrobenzaldehyde (CAS Number 100–50–5); or

(B) Crotonaldehyde (CAS Number 123–73–9).

(2) Use as a reactant or manufacture as a product, or co-product, one or more of the organic hazardous air pollutants listed in table 2 of this subpart;

(3) Are located at a plant site that is a major source as defined in section 112(a) of the Act.

(4) The owner or operator of a chemical manufacturing processing unit is exempt from all requirements of subparts F, G, and H of this part until not later than April 22, 1997 if the owner or operator certifies, in a notification to the appropriate EPA Regional Office, not later than May 14, 1996, that the plant site at which the chemical manufacturing processing unit is located emits, and will continue to emit, during any 12-month period, less than 10 tons per year of any individual hazardous air pollutants (HAP), and less than 25 tons per year of any combination of HAP.

(i) If such a determination is based on limitations and conditions that are not federally enforceable (as

defined in subpart A of this part), the owner or operator shall document the basis for the determination as specified in paragraphs (b)(4)(i)(A) through (b)(4)(i)(C) and comply with the recordkeeping requirement in 63.103(f).

(A) The owner or operator shall identify all HAP emission points at the plant site, including those emission points subject to and emission points not subject to subparts F, G, and H;

(B) The owner or operator shall calculate the amount of annual HAP emissions released from each emission point at the plant site, using acceptable measurement or estimating techniques for maximum expected operating conditions at the plant site. Examples of estimating procedures that are considered acceptable include the calculation procedures in §63.150 of subpart G, the early reduction demonstration procedures specified in §§63.74 (c)(2), (c)(3), (d)(2), (d)(3), and (g), or accepted engineering practices. If the total annual HAP emissions for the plant site are annually reported under Emergency Planning and Community Right-to-Know Act (EPCRA) section 313, then such reported annual emissions may be used to satisfy the requirements of §63.100(b)(4)(i)(B).

(C) The owner or operator shall sum the amount of annual HAP emissions from all emission points on the plant site. If the total emissions of any one HAP are less than 10 tons per year and the total emissions of any combination of HAP are less than 25 tons per year, the plant site qualifies for the exemption described in paragraph (b)(4) of this section, provided that emissions are kept below these thresholds.

(ii) If such a determination is based on limitations and conditions that are federally enforceable (as defined in subpart A of this part), the owner or operator is not subject to the provisions of paragraph (b)(4) of this section.

(c) The owner or operator of a chemical manufacturing process unit that meets the criteria specified in paragraphs (b)(1) and (b)(3) of this section but does not use as a reactant or manufacture as a product or co-product, any organic hazardous air pollutant listed in table 2 of this subpart shall comply only with the requirements of §63.103(e) of this subpart. To comply with this subpart, such chemical manufacturing process units shall not be required to comply with the provisions of subpart A of this part.

(d) The primary product of a chemical manufacturing process unit shall be determined according to the procedures specified in paragraphs (d)(1), (d)(2), (d)(3), and (d)(4) of this section.

(1) If a chemical manufacturing process unit produces more than one intended chemical product, the product with the greatest annual design capacity on a mass basis determines the primary product of the process.

(2) If a chemical manufacturing process unit has two or more products that have the same maximum annual design capacity on a mass basis and if one of those chemicals is listed in table 1 of this subpart, then the listed chemical is considered the primary product and the chemical manufacturing process unit is subject to this subpart. If more than one of the products is listed in table 1 of this subpart, then the owner or operator may designate as the primary product any of the listed chemicals and the chemical manufacturing process unit is subject to this subpart.

(3) For chemical manufacturing process units that are designed and operated as flexible operation units producing one or more chemicals listed in table 1 of this subpart, the primary product shall be determined for existing sources based on the expected utilization for the five years following April 22, 1994 and for new sources based on the expected utilization for the first five years after initial start-up.

(i) If the predominant use of the flexible operation unit, as described in paragraphs (d)(3)(i)(A) and (d)(3)(i)(B) of this section, is to produce one or more chemicals listed in table 1 of this subpart, then the flexible operation unit shall be subject to the provisions of subparts F, G, and H of this part.

(A) If the flexible operation unit produces one product for the greatest annual operating time, then that product shall represent the primary product of the flexible operation unit.

(B) If the flexible operation unit produces multiple chemicals equally based on operating time, then the product with the greatest annual production on a mass basis shall represent the primary product of the flexible operation unit.

(ii) The determination of applicability of this subpart to chemical manufacturing process units that are designed and operated as flexible operation units shall be reported as part of an operating permit application or as otherwise specified by the permitting authority.

(4) Notwithstanding the provisions of paragraph (d)(3) of this section, for chemical manufacturing process units that are designed and operated as flexible operation units producing a chemical listed in paragraph (b)(1)(ii) of this section, the primary product shall be determined for existing sources based on the expected utilization for the five years following May 12, 1998 and for new sources based on the expected utilization for the first five years after initial start-up.

(i) The predominant use of the flexible operation unit shall be determined according to paragraphs (d)(3)(i)(A) and (d)(3)(i)(B) of this section. If the predominant use is to produce one of the chemicals listed in paragraph (b)(1)(ii) of this section, then the flexible operation unit shall be subject to the provisions of this subpart and subparts G and H of this part.

(ii) The determination of applicability of this subpart to chemical manufacturing process units that are designed and operated as flexible operation units shall be reported as part of an operating permit application or as otherwise specified by the permitting authority.

(e) The source to which this subpart applies is the collection of all chemical manufacturing process units and the associated equipment at a major source that meet the criteria specified in paragraphs (b)(1) through (3) of this section. The source includes the process vents; storage vessels; transfer racks; waste management units; maintenance wastewater; heat exchange systems; equipment identified in §63.149; and pumps, compressors, agitators, pressure relief devices, sampling connection systems, open-ended valves or lines, valves, connectors, instrumentation systems, surge control vessels, and bottoms receivers that are associated with that collection of chemical manufacturing process units. The source also includes equipment required by, or utilized as a method of compliance with, subparts F, G, or H of this part which may include control devices and recovery devices.

(1) This subpart applies to maintenance wastewater and heat exchange systems within a source that is subject to this subpart.

(2) This subpart F and subpart G of this part apply to process vents, storage vessels, transfer racks, equipment identified in §63.149 of subpart G of this part, and wastewater streams and associated treatment residuals within a source that is subject to this subpart.

(3) This subpart F and subpart H of this part apply to pumps, compressors, agitators, pressure relief devices, sampling connection systems, open-ended valves or lines, valves, connectors, instrumentation systems, surge control vessels, and bottoms receivers within a source that is subject to this subpart. If specific items of equipment, comprising part of a chemical manufacturing process unit subject to this subpart, are managed by different administrative organizations (e.g., different companies, affiliates, departments, divisions, etc.), those items of equipment may be aggregated with any chemical manufacturing process unit within the source for all purposes under subpart H of this part, providing there is no delay in the applicable compliance date in §63.100(k).

(f) The source includes the emission points listed in paragraphs (f)(1) through (f)(11) of this section, but those emission points are not subject to the requirements of this subpart F and subparts G and H of this part. This subpart does not require emission points that are listed in paragraphs (f)(1) through (f)(11) of this section to comply with the provisions of subpart A of this part.

(1) Equipment that is located within a chemical manufacturing process unit that is subject to this subpart but the equipment does not contain organic hazardous air pollutants.

(2) Stormwater from segregated sewers;

(3) Water from fire-fighting and deluge systems in segregated sewers;

(4) Spills;

(5) Water from safety showers;

(6) Water from testing of deluge systems;

(7) Water from testing of firefighting systems;

(8) Vessels storing organic liquids that contain organic hazardous air pollutants only as impurities;

(9) Loading racks, loading arms, or loading hoses that only transfer liquids containing organic hazardous air pollutants as impurities;

(10) Loading racks, loading arms, or loading hoses that vapor balance during all loading operations; and

(11) Equipment that is intended to operate in organic hazardous air pollutant service, as defined in §63.161 of subpart H of this part, for less than 300 hours during the calendar year.

(g) The owner or operator shall follow the procedures specified in paragraphs (g)(1) through (g)(4) of this section to determine whether a storage vessel is part of the source to which this subpart applies.

(1) Where a storage vessel is dedicated to a chemical manufacturing process unit, the storage vessel shall be considered part of that chemical manufacturing process unit.

(i) If the chemical manufacturing process unit is subject to this subpart according to the criteria specified in paragraph (b) of this section, then the storage vessel is part of the source to which this subpart applies.

(ii) If the chemical manufacturing process unit is not subject to this subpart according to the criteria specified in paragraph (b) of this section, then the storage vessel is not part of the source to which this subpart applies.

(2) If a storage vessel is not dedicated to a single chemical manufacturing process unit, then the applicability of this subpart F and subpart G of this part shall be determined according to the provisions in paragraphs (g)(2)(i) through (g)(2)(iii) of this section.

(i) If a storage vessel is shared among chemical manufacturing process units and one of the process units has the predominant use, as determined by paragraph (g)(2)(i)(A) and (g)(2)(i)(B) of this section, then the storage vessel is part of that chemical manufacturing process unit.

(A) If the greatest input into the storage vessel is from a chemical manufacturing process unit that is located on the same plant site, then that chemical manufacturing process unit has the predominant use.

(B) If the greatest input into the storage vessel is provided from a chemical manufacturing process unit that is not located on the same plant site, then the predominant use is the chemical manufacturing process unit on the same plant site that receives the greatest amount of material from the storage vessel.

(ii) If a storage vessel is shared among chemical manufacturing process units so that there is no single predominant use, and at least one of those chemical manufacturing process units is subject to this subpart, the storage vessel shall be considered to be part of the chemical manufacturing process unit that is subject to this subpart. If more than one chemical manufacturing process unit is subject to this subpart, the owner or operator may assign the storage vessel to any of the chemical manufacturing process units subject to this subpart.

(iii) If the predominant use of a storage vessel varies from year to year, then the applicability of this subpart shall be determined according to the criteria in paragraphs (g)(2)(iii)(A) and (g)(2)(iii)(B) of this section, as applicable. This determination shall be reported as part of an operating permit application or as otherwise specified by the permitting authority.

(A) For chemical manufacturing process units that produce one or more of the chemicals listed in table 1 of this subpart and meet the criteria in paragraphs (b)(2) and (b)(3) of this section, the applicability shall be based on the utilization that occurred during the 12-month period preceding April 22, 1994.

(2) If a loading rack is shared among chemical manufacturing process units, then the applicability of this subpart F and subpart G of this part shall be determined at each loading arm or loading hose according to the provisions in paragraphs (h)(2)(i) through (h)(2)(iv) of this section.

(i) Each loading arm or loading hose that is dedicated to the transfer of liquid organic hazardous air pollutants listed in table 2 of this subpart from a chemical manufacturing process unit to which this subpart applies is part of that chemical manufacturing process unit and is part of the source to which this subpart applies unless the loading arm or loading hose meets the criteria specified in paragraphs (f)(9) or (f)(10) of this section.

(ii) If a loading arm or loading hose is shared among chemical manufacturing process units, and one of the chemical manufacturing process units provides the greatest amount of the material that is loaded by the loading arm or loading hose, then the loading arm or loading hose is part of that chemical manufacturing process unit.

(A) If the chemical manufacturing process unit is subject to this subpart according to the criteria specified in paragraph (b) of this section, then the loading arm or loading hose is part of the source to which this subpart applies unless the loading arm or loading hose meets the criteria specified in paragraphs (f)(9) or (f)(10) of this section.

(B) If the chemical manufacturing process unit is not subject to this subpart according to the criteria specified in paragraph (b) of this section, then the loading arm or loading hose is not part of the source to which this subpart applies.

(iii) If a loading arm or loading hose is shared among chemical manufacturing process units so that there is no single predominant use as described in paragraph (h)(2)(ii) of this section and at least one of those chemical manufacturing process units is subject to this subpart, then the loading arm or hose is part of the chemical manufacturing process unit that is subject to this subpart. If more than one of the chemical manufacturing process units is subject to this subpart, the owner or operator may assign the loading arm or loading hose to any of the chemical manufacturing process units subject to this subpart.

(iv) If the predominant use of a loading arm or loading hose varies from year to year, then the applicability of this subpart shall be determined according to the criteria in paragraphs (h)(2)(iv)(A) and (h)(2)(iv)(B) of this section, as applicable. This determination shall be reported as part of an operating permit application or as otherwise specified by the permitting authority.

(A) For chemical manufacturing process units that produce one or more of the chemicals listed in table 1 of this subpart and meet the criteria in paragraphs (b)(2) and (b)(3) of this section, the applicability shall be based on the utilization that occurred during the 12-month period preceding April 22, 1994.

(B) For chemical manufacturing process units that produce one or more of the chemicals listed in paragraph (b)(1)(ii) of this section and meet the criteria in paragraphs (b)(2) and (b)(3) of this section, the applicability shall be based on the utilization that occurred during the year preceding May 12, 1998.

(3) If a loading rack that was dedicated to a single chemical manufacturing process unit begins to serve another chemical manufacturing process unit, or if applicability was determined under the provisions of paragraphs (h)(2)(i) through (h)(2)(iii) of this section and there is a change so that the predominant use may reasonably have changed, the owner or operator shall reevaluate the applicability of this subpart to the loading rack, loading arm, or loading hose.

(i) Except as provided in paragraph (i)(4) of this section, the owner or operator shall follow the procedures specified in paragraphs (i)(1) through (i)(3) and (i)(5) of this section to determine whether the vent(s) from a distillation unit is part of the source to which this subpart applies.

(1) Where a distillation unit is dedicated to a chemical manufacturing process unit, the distillation column shall be considered part of that chemical manufacturing process unit.

(i) If the chemical manufacturing process unit is subject to this subpart according to the criteria specified in paragraph (b) of this section, then the distillation unit is part of the source to which this subpart applies.

(ii) If the chemical manufacturing process unit is not subject to this subpart according to the criteria specified in paragraph (b) of this section, then the distillation unit is not part of the source to which this subpart applies.

(2) If a distillation unit is not dedicated to a single chemical manufacturing process unit, then the applicability of this subpart and subpart G of this part shall be determined according to the provisions in paragraphs (i)(2)(i) through (i)(2)(iv) of this section.

(i) If the greatest input to the distillation unit is from a chemical manufacturing process unit located on the same plant site, then the distillation unit shall be assigned to that chemical manufacturing process unit.

(ii) If the greatest input to the distillation unit is provided from a chemical manufacturing process unit that is not located on the same plant site, then the distillation unit shall be assigned to the chemical manufacturing process unit located at the same plant site that receives the greatest amount of material from the distillation unit.

(iii) If a distillation unit is shared among chemical manufacturing process units so that there is no single predominant use as described in paragraphs (i)(2)(i) and (i)(2)(ii) of this section, and at least one of those chemical manufacturing process units is subject to this subpart, the distillation unit shall be assigned to the chemical manufacturing process unit that is subject to this subpart. If more than one chemical manufacturing process unit is subject to this subpart, the owner or operator may assign the distillation unit to any of the chemical manufacturing process units subject to this subpart.

(iv) If the predominant use of a distillation unit varies from year to year, then the applicability of this subpart shall be determined according to the criteria in paragraphs (i)(2)(iv)(A) and (i)(2)(iv)(B), as applicable. This determination shall be included as part of an operating permit application or as otherwise specified by the permitting authority.

(A) For chemical manufacturing process units that produce one or more of the chemicals listed in table 1 of this subpart and meet the criteria in paragraphs (b)(2) and (b)(3) of this section, the applicability shall be based on the utilization that occurred during the year preceding April 22, 1994.

(B) For chemical manufacturing process units that produce one or more of the chemicals listed in paragraph (b)(1)(ii) of this section and meet the criteria in paragraphs (b)(2) and (b)(3) of this section, the applicability shall be based on the utilization that occurred during the year preceding May 12, 1998.

(3) If the chemical manufacturing process unit to which the distillation unit is assigned is subject to this subpart, then each vent from the individual distillation unit shall be considered separately to determine whether it is a process vent (as defined in §63.101 of this subpart). Each vent that is a process vent is part of the source to which this subpart applies.

(4) If the distillation unit is part of one of the chemical manufacturing process units listed in paragraphs (i)(4)(i) through (i)(4)(iii) of this section, then each vent from the individual distillation unit shall be considered separately to determine whether it is a process vent (as defined in §63.101 of this subpart). Each vent that is a process vent is part of the source to which this subpart applies:

(i) The Aromex unit that produces benzene, toluene, and xylene;

(ii) The unit that produces hexane; or

(iii) The unit that produces cyclohexane.

(5) If a distillation unit that was dedicated to a single chemical manufacturing process unit, or that was part of a chemical manufacturing unit identified in paragraphs (i)(4)(i) through (i)(4)(iii) of this section, begins to serve another chemical manufacturing process unit, or if applicability was determined under the provisions of paragraphs (i)(2)(i) through (i)(2)(iii) of this section and there is a change so that the predominant use may reasonably have changed, the owner or operator shall reevaluate the applicability of this subpart to the distillation unit.

(j) The provisions of subparts F, G, and H of this part do not apply to the processes specified in paragraphs (j)(1) through (j)(6) of this section. Subparts F, G, and H do not require processes specified

in paragraphs (j)(1) through (j)(6) to comply with the provisions of subpart A of this part.

(1) Research and development facilities, regardless of whether the facilities are located at the same plant site as a chemical manufacturing process unit that is subject to the provisions of subparts F, G, or H of this part.

(2) Petroleum refining process units, regardless of whether the units supply feedstocks that include chemicals listed in table 1 of this subpart to chemical manufacturing process units that are subject to the provisions of subparts F, G, or H of this part.

(3) Ethylene process units, regardless of whether the units supply feedstocks that include chemicals listed in table 1 of this subpart to chemical manufacturing process units that are subject to the provisions of subpart F, G, or H of this part.

(4) Batch process vents within a chemical manufacturing process unit.

(5) Chemical manufacturing process units that are located in coke by-product recovery plants.

(6) Solvent reclamation, recovery, or recycling operations at hazardous waste TSD facilities requiring a permit under 40 CFR part 270 that are separate entities and not part of a SOCMI chemical manufacturing process unit.

(k) Except as provided in paragraphs (l), (m), and (p) of this section, sources subject to subparts F, G, or H of this part are required to achieve compliance on or before the dates specified in paragraphs (k)(1) through (k)(8) of this section.

(1)(i) New sources that commence construction or reconstruction after December 31, 1992, but before August 27, 1996 shall be in compliance with this subpart F, subparts G and H of this part upon initial start-up or by April 22, 1994, whichever is later, as provided in §63.6(b) of subpart A of this part, and further, where start-up occurs before January 17, 1997 shall also be in compliance with this subpart F and subparts G and H of this part (as amended on January 17, 1997) by January 17, 1997, except that, with respect to all new sources that commenced construction or reconstruction after December 31, 1992, and before August 27, 1996:

(A) Heat exchange systems and maintenance wastewater, that are part of a new source on which construction or reconstruction commenced after December 31, 1992, but before August 27, 1996, shall be in compliance with this subpart F no later than initial start-up or 180 days after January 17, 1997, whichever is later;

(B) Process wastewater streams and equipment subject to §63.149, that are part of a new source on which construction or reconstruction commenced after December 31, 1992, but before August 27, 1996, shall be in compliance with this subpart F and subpart G of this part no later than initial start-up or 180 days after January 17, 1997, whichever is later; and

(ii) New sources that commence construction after August 26, 1996 shall be in compliance with this subpart F, subparts G and H of this part upon initial start-up or by January 17, 1997, whichever is later.

(2) Existing sources shall be in compliance with this subpart F and subpart G of this part no later than the dates specified in paragraphs (k)(2)(i) and (k)(2)(ii) of this section, unless an extension has been granted by the Administrator as provided in §63.151(a)(6) of subpart G of this part or granted by the permitting authority as provided in §63.6(i) of subpart A of this part.

(i) Process vents, storage vessels, and transfer racks at an existing source shall be in compliance with the applicable sections of this subpart and subpart G of this part no later than April 22, 1997.

(ii) Heat exchange systems and maintenance wastewater shall be in compliance with the applicable sections of this subpart, and equipment subject to §63.149 and process wastewater streams shall be in compliance with the applicable sections of this subpart and subpart G of this part no later than April 22, 1999, except as provided in paragraphs (k)(2)(ii)(A) and (k)(2)(ii)(B) of this section.

(A) If a process wastewater stream or equipment subject to §63.149 is subject to the control requirements of subpart G of this part due to the contribution of nitrobenzene to the total annual average concentration (as determined according to the procedures in §63.144(b) of subpart G of this part), the wastewater stream shall be in compliance no later than January 18, 2000.

(B) If a process wastewater stream is used to generate credits in an emissions average in accordance with §63.150 of subpart G of this part, the process wastewater stream shall be in compliance with the applicable sections of subpart G of this part no later than April 22, 1997.

(3) Existing sources shall be in compliance with subpart H of this part no later than the dates specified in paragraphs (k)(3)(i) through (k)(3)(v) of this section, except as provided for in paragraphs (k)(4) through (k)(8) of this section, unless an extension has been granted by the Administrator as provided in §63.182(a)(6) of this part or granted by the permitting authority as provided in §63.6(i) of subpart A of this part. The group designation for each process unit is indicated in table 1 of this subpart.

(i) Group I: October 24, 1994.

(ii) Group II: January 23, 1995.

(iii) Group III: April 24, 1995.

(iv) Group IV: July 24, 1995.

(v) Group V: October 23, 1995.

(4) Existing chemical manufacturing process units in Groups I and II as identified in table 1 of this subpart shall be in compliance with the requirements of §63.164 of subpart H no later than May 10, 1995, for any compressor meeting one or more of the criteria in paragraphs (k)(4)(i) through (k)(4)(iv) of this section, if the work can be accomplished without a process unit shutdown, as defined in §63.161 in subpart H.

(i) The seal system will be replaced;

(ii) A barrier fluid system will be installed;

(iii) A new barrier fluid will be utilized which requires changes to the existing barrier fluid system; or

(iv) The compressor must be modified to permit connecting the compressor to a closed vent system.

(5) Existing chemical manufacturing process units shall be in compliance with the requirements of §63.164 in subpart H no later than 1 year after the applicable compliance date specified in paragraph (k)(3) of this section, for any compressor meeting the criteria in paragraphs (k)(5)(i) through (k)(5)(iv) of this section.

(i) The compressor meets one or more of the criteria specified in paragraphs (k)(4)(i) through (iv) of this section;

(ii) The work can be accomplished without a process unit shutdown as defined in §63.161 of subpart H;

(iii) The additional time is actually necessary due to the unavailability of parts beyond the control of the owner or operator; and

(iv) The owner or operator submits a request to the appropriate EPA Regional Office at the addresses listed in §63.13 of subpart A of this part no later than 45 days before the applicable compliance date in paragraph (k)(3) of this section, but in no event earlier than May 10, 1995. The request shall include the information specified in paragraphs (k)(5)(iv)(A) through (k)(5)(iv)(E) of this section. Unless the EPA Regional Office objects to the request within 30 days after receipt, the request shall be deemed approved.

(A) The name and address of the owner or operator and the address of the existing source if it differs from the address of the owner or operator;

(B) The name, address, and telephone number of a contact person for further information;

(C) An identification of the chemical manufacturing process unit, and of the specific equipment for which additional compliance time is required;

(D) The reason compliance can not reasonably be achieved by the applicable date specified in paragraphs (k)(3)(i) through (k)(3)(v) of this section; and

(E) The date by which the owner or operator expects to achieve compliance.

(6)(i) If compliance with the compressor provisions of §63.164 of subpart H of this part can not reasonably be achieved without a process unit shutdown, as defined in §63.161 of subpart H, the owner or operator shall achieve compliance no later than April 22, 1996, except as provided for in paragraph (k)(6)(ii) of this section. The owner or operator who elects to use this provision shall comply with the requirements of §63.103(g) of this subpart.

(ii) If compliance with the compressor provisions of §63.164 of subpart H of this part can not be achieved without replacing the compressor or recasting the distance piece, the owner or operator shall achieve compliance no later than April 22, 1997. The owner or operator who elects to use this provision shall also comply with the requirements of §63.103(g) of this subpart.

(7) Existing sources shall be in compliance with the provisions of §63.170 of subpart H no later than April 22, 1997.

(8) If an owner or operator of a chemical manufacturing process unit subject to the provisions of subparts F, G, and H of part 63 plans to implement pollution prevention measures to eliminate the use or production of HAP listed in table 2 of this subpart by October 23, 1995, the provisions of subpart H do not apply regardless of the compliance dates specified in paragraph (k)(3) of this section. The owner or operator who elects to use this provision shall comply with the requirements of §63.103(h) of this subpart.

(9) All terms in this subpart F or subpart G of this part that define a period of time for completion of required tasks (e.g., weekly, monthly, quarterly, annual), unless specified otherwise in the section or subsection that imposes the requirement, refer to the standard calendar periods.

(i) Notwithstanding time periods specified in this subpart F or subpart G of this part for completion of required tasks, such time periods may be changed by mutual agreement between the owner or operator and the Administrator, as specified in subpart A of this part (e.g., a period could begin on the compliance date or another date, rather than on the first day of the standard calendar period). For each time period that is changed by agreement, the revised period shall remain in effect until it is changed. A new request is not necessary for each recurring period.

(ii) Where the period specified for compliance is a standard calendar period, if the initial compliance date occurs after the beginning of the period, compliance shall be required according to the schedule specified in paragraphs (k)(9)(ii)(A) or (k)(9)(ii)(B) of this section, as appropriate.

(A) Compliance shall be required before the end of the standard calendar period within which the compliance deadline occurs, if there remain at least 3 days for tasks that must be performed weekly, at least 2 weeks for tasks that must be performed monthly, at least 1 month for tasks that must be performed each quarter, or at least 3 months for tasks that must be performed annually; or

(B) In all other cases, compliance shall be required before the end of the first full standard calendar period after the period within which the initial compliance deadline occurs.

(iii) In all instances where a provision of this subpart F or subpart G of this part requires completion of a task during each of multiple successive periods, an owner or operator may perform the required task at any time during the specified period, provided the task is conducted at a reasonable interval after completion of the task during the previous period.

(l)(1) If an additional chemical manufacturing process unit meeting the criteria specified in paragraph (b) of this section is added to a plant site that is a major source as defined in section 112(a) of the Act, the addition shall be subject to the requirements for a new source in subparts F, G, and H of this part if:

(i) It is an addition that meets the definition of construction in §63.2 of subpart A of this part;

(ii)(A) Such construction commenced after December 31, 1992 for chemical manufacturing process units that produce as a primary product one or more of the chemicals listed in table 1 of this subpart;

(B) Such construction commenced after August 22, 1997 for chemical manufacturing process units that produce as a primary product one or more of the chemicals listed in paragraph (b)(1)(ii) of this section; and

(iii) The addition has the potential to emit 10 tons per year or more of any HAP or 25 tons per year or more of any combination of HAP's, unless the Administrator establishes a lesser quantity.

(2) If any change is made to a chemical manufacturing process unit subject to this subpart, the change shall be subject to the requirements of a new source in subparts F, G, and H of this part if:

(i) It is a change that meets the definition of reconstruction in §63.2 of subpart A of this part; and

(ii)(A) Such reconstruction commenced after December 31, 1992 for chemical manufacturing process units that produce as a primary product one or more of the chemicals listed in table 1 of this subpart; and

(B) Such construction commenced after August 22, 1997 for chemical manufacturing process units that produce as a primary product one or more of the chemicals listed in paragraph (b)(1)(ii) of this section.

(3) If an additional chemical manufacturing process unit is added to a plant site or a change is made to a chemical manufacturing process unit and the addition or change is determined to be subject to the new source requirements according to paragraph (l)(1) or (l)(2) of this section:

(i) The new or reconstructed source shall be in compliance with the new source requirements of subparts F, G, and H of this part upon initial start-up of the new or reconstructed source or by April 22, 1994, whichever is later; and

(ii) The owner or operator of the new or reconstructed source shall comply with the reporting and recordkeeping requirements in subparts F, G, and H of this part that are applicable to new sources. The applicable reports include, but are not limited to:

(A) The application for approval of construction or reconstruction which shall be submitted by the date specified in §63.151(b)(2)(ii) of subpart G of this part, or an Initial Notification as specified in §63.151(b)(2)(iii) of subpart G of this part;

(B) Changes that meet the criteria in §63.151(j) of subpart G of this part, unless the information has been submitted in an operating permit application or amendment;

(C) The Notification of Compliance Status as required by §63.152(b) of subpart G of this part for the new or reconstructed source;

(D) Periodic Reports and Other Reports as required by §63.152(c) and (d) of subpart G of this part;

(E) Reports required by §63.182 of subpart H of this part; and

(F) Reports and notifications required by sections of subpart A of this part that are applicable to subparts F, G, and H of this part, as identified in table 3 of this subpart.

(4) If an additional chemical manufacturing process unit is added to a plant site, or if an emission point is added to an existing chemical manufacturing process unit, or if another deliberate operational process change creating an additional Group 1 emission point(s) is made to an existing chemical manufacturing

process unit, or if a surge control vessel or bottoms receiver becomes subject to §63.170 of subpart H, or if a compressor becomes subject to §63.164 of subpart H, and if the addition or change is not subject to the new source requirements as determined according to paragraph (l)(1) or (l)(2) of this section, the requirements in paragraphs (l)(4)(i) through (l)(4)(iii) of this section shall apply. Examples of process changes include, but are not limited to, changes in production capacity, feedstock type, or catalyst type, or whenever there is replacement, removal, or addition of recovery equipment. For purposes of this paragraph and paragraph (m) of this section, process changes do not include: Process upsets, unintentional temporary process changes, and changes that are within the equipment configuration and operating conditions documented in the Notification of Compliance Status required by §63.152(b) of subpart G of this part.

(i) The added emission point(s) and any emission point(s) within the added or changed chemical manufacturing process unit are subject to the requirements of subparts F, G, and H of this part for an existing source;

(ii) The added emission point(s) and any emission point(s) within the added or changed chemical manufacturing process unit shall be in compliance with subparts F, G, and H of this part by the dates specified in paragraph (l)(4)(ii) (A) or (B) of this section, as applicable.

(A) If a chemical manufacturing process unit is added to a plant site or an emission point(s) is added to an existing chemical manufacturing process unit, the added emission point(s) shall be in compliance upon initial start-up of the added chemical manufacturing process unit or emission point(s) or by 3 years after April 22, 1994, whichever is later.

(B) If a deliberate operational process change to an existing chemical manufacturing process unit causes a Group 2 emission point to become a Group 1 emission point, if a surge control vessel or bottoms receiver becomes subject to §63.170 of subpart H, or if a compressor becomes subject to §63.164 of subpart H, the owner or operator shall be in compliance upon initial start-up or by 3 years after April 22, 1994, whichever is later, unless the owner or operator demonstrates to the Administrator that achieving compliance will take longer than making the change. If this demonstration is made to the Administrator's satisfaction, the owner or operator shall follow the procedures in paragraphs (m)(1) through (m)(3) of this section to establish a compliance date.

(iii) The owner or operator of a chemical manufacturing process unit or emission point that is added to a plant site and is subject to the requirements for existing sources shall comply with the reporting and recordkeeping requirements of subparts F, G, and H of this part that are applicable to existing sources, including, but not limited to, the reports listed in paragraphs (l)(4)(iii) (A) through (E) of this section. A change to an existing chemical manufacturing process unit shall be subject to the reporting requirements for existing sources, including but not limited to, the reports listed in paragraphs (l)(4)(iii)(A) through (E) of this section if the change meets the criteria specified in §63.118(g), (h), (i), or (j) of subpart G of this part for process vents or the criteria in §63.155(i) or (j) of subpart G of this part. The applicable reports include, but are not limited to:

(A) Reports specified in §63.151(i) and (j) of subpart G of this part, unless the information has been submitted in an operating permit application or amendment;

(B) The Notification of Compliance Status as required by §63.152(b) of subpart G of this part for the emission points that were added or changed;

(C) Periodic Reports and other reports as required by §63.152 (c) and (d) of subpart G of this part;

(D) Reports required by §63.182 of subpart H of this part; and

(E) Reports and notifications required by sections of subpart A of this part that are applicable to subparts F, G, and H of this part, as identified in table 3 of this subpart.

(m) If a change that does not meet the criteria in paragraph (l)(4) of this section is made to a chemical manufacturing process unit subject to subparts F and G of this part, and the change causes a Group 2 emission point to become a Group 1 emission point (as defined in §63.111 of subpart G of this part), then the owner or operator shall comply with the requirements of subpart G of this part for the Group 1 emission point as expeditiously as practicable, but in no event later than 3 years after the emission point becomes Group 1.

(1) The owner or operator shall submit to the Administrator for approval a compliance schedule, along with a justification for the schedule.

(2) The compliance schedule shall be submitted with the report required in §63.151(i)(2) of subpart G of this part for emission points included in an emissions average or §63.151(j)(1) or subpart G of this part for emission points not in an emissions average, unless the compliance schedule has been submitted in an operating permit application or amendment.

(3) The Administrator shall approve the compliance schedule or request changes within 120 calendar days of receipt of the compliance schedule and justification.

(n) *Rules stayed for reconsideration.* Notwithstanding any other provision of this subpart, the effectiveness of subpart F is stayed from October 24, 1994, to April 24, 1995, only as applied to those sources for which the owner or operator makes a representation in writing to the Administrator that the resolution of the area source definition issues could have an effect on the compliance status of the source with respect to subpart F.

(o) *Sections stayed for reconsideration.* Notwithstanding any other provision of this subpart, the effectiveness of §§63.164 and 63.170 of subpart H is stayed from October 28, 1994, to April 24, 1995, only as applied to those sources subject to §63.100(k)(3) (i) and (ii).

(p) *Compliance dates for chemical manufacturing process units that produce crotonaldehyde or tetrahydrobenzaldehyde.* Notwithstanding the provisions of paragraph (k) of this section, chemical manufacturing process units that meet the criteria in paragraphs (b)(1)(ii), (b)(2), and (b)(3) of this section shall be in compliance with this subpart and subparts G and H of this part by the dates specified in paragraphs (p)(1) and (p)(2) of this section, as applicable.

(1) If the source consists only of chemical manufacturing process units that produce as a primary product one or more of the chemicals listed in paragraph (b)(1)(ii) of this section, new sources shall comply by the date specified in paragraph (p)(1)(i) of this section and existing sources shall comply by the dates specified in paragraphs (p)(1)(ii) and (p)(1)(iii) of this section.

(i) Upon initial start-up or May 12, 1998, whichever is later.

(ii) This subpart and subpart G of this part by May 14, 2001, unless an extension has been granted by the Administrator as provided in §63.151(a)(6) or granted by the permitting authority as provided in §63.6(i) of subpart A of this part. When April 22, 1994 is referred to in this subpart and subpart G of this part, May 12, 1998 shall be used as the applicable date for that provision. When December 31, 1992 is referred to in this subpart and subpart G of this part, August 22, 1997 shall be used as the applicable date for that provision.

(iii) Subpart H of this part by May 12, 1999, unless an extension has been granted by the Administrator as provided in §63.151(a)(6) or granted by the permitting authority as provided in §63.6(i) of subpart A of this part. When April 22, 1994 is referred to in subpart H of this part, May 12, 1998 shall be used as the applicable date for that provision. When December 31, 1992 is referred to in subpart H of this part, August 22, 1997 shall be used as the applicable date for that provision.

(2) If the source consists of a combination of chemical manufacturing process units that produce as a primary product one or more of the chemicals listed in paragraphs (b)(1)(i) and (b)(1)(ii) of this section, new chemical manufacturing process units that meet the criteria in paragraph (b)(1)(ii) of this section shall comply by the date specified in paragraph (p)(1)(i) of this section and existing chemical manufacturing process units producing crotonaldehyde and/or tetrahydrobenzaldehyde shall comply by the dates specified in paragraphs (p)(1)(ii) and (p)(1)(iii) of this section.

(q) If the owner or operator of a process vent, or of a gas stream transferred subject to §63.113(i), is unable to comply with the provisions of §§63.113 through 63.118 by the applicable compliance date specified in paragraph (k), (l), or (m) of this section for the reasons stated in paragraph (q)(1), (3), or (5) of this section, the owner or operator shall comply with the applicable provisions in §§63.113 through 63.118 as expeditiously as practicable, but in no event later than the date approved by the Administrator pursuant to paragraph (q)(2), (4), or (6) of this section, respectively. For requests under paragraph (q)(1) or (3) of this section, the date approved by the Administrator may be earlier than, and shall not be later than, the later of January 22, 2004 or 3 years after the transferee's refusal to accept the stream for

disposal. For requests submitted under paragraph (q)(5) of this section, the date approved by the Administrator may be earlier than, and shall not be later than, 3 years after the date of publication of the amendments to this subpart or to subpart G of this part which created the need for an extension of the compliance.

(1) If the owner or operator has been sending a gas stream for disposal as described in §63.113(i) prior to January 22, 2001, and the transferee does not submit a written certification as described in §63.113(i)(2) and ceases to accept the gas stream for disposal, the owner or operator shall comply with paragraph (q)(2) of this section.

(2)(i) An owner or operator directed to comply with paragraph (q)(2) of this section shall submit to the Administrator for approval a compliance schedule, along with a justification for the schedule.

(ii) The compliance schedule and justification shall be submitted no later than 90 days after the transferee ceases to accept the gas stream for disposal.

(iii) The Administrator shall approve the compliance schedule or request changes within 120 days of receipt of the compliance schedule and justification.

(3) If the owner or operator has been sending the gas stream for disposal as described in §63.113(i) to a transferee who had submitted a written certification as described in §63.113(i)(2), and the transferee revokes its written certification, the owner or operator shall comply with paragraph (q)(4) of this section. During the period between the date when the owner or operator receives notice of revocation of the transferee's written certification and the compliance date established under paragraph (q)(4) of this section, the owner or operator shall implement, to the extent reasonably available, measures to prevent or minimize excess emissions to the extent practical. For purposes of this paragraph (q)(3), the term "excess emissions" means emissions in excess of those that would have occurred if the transferee had continued managing the gas stream in compliance with the requirements in §§63.113 through 63.118. The measures to be taken shall be identified in the applicable startup, shutdown, and malfunction plan. If the measures that can be reasonably taken will change over time, so that a more effective measure which could not reasonably be taken initially would be reasonable at a later date, the Administrator may require the more effective measure by a specified date (in addition to or instead of any other measures taken sooner or later than that date) as a condition of approval of the compliance schedule.

(4)(i) An owner or operator directed to comply with this paragraph (q)(4) shall submit to the Administrator for approval the documents specified in paragraphs (q)(4)(i)(A) through (E) of this section no later than 90 days after the owner or operator receives notice of revocation of the transferee's written certification.

(A) A request for determination of a compliance date.

(B) A justification for the request for determination of a compliance date.

(C) A compliance schedule.

(D) A justification for the compliance schedule.

(E) A description of the measures that will be taken to minimize excess emissions until the new compliance date, and the date when each measure will first be implemented. The owner or operator shall describe how, and to what extent, each measure will minimize excess emissions, and shall justify any period of time when measures are not in place.

(ii) The Administrator shall approve or disapprove the request for determination of a compliance date and the compliance schedule, or request changes, within 120 days after receipt of the documents specified in paragraphs (q)(4)(i)(A) through (E) of this section. Upon approving the request for determination and compliance schedule, the Administrator shall specify a reasonable compliance date consistent with the introductory text in paragraph (q) of this section.

(5) If the owner's or operator's inability to meet otherwise applicable compliance deadlines is due to amendments of this subpart or of subpart G of this part published on or after January 22, 2001 and neither condition specified in paragraph (q)(1) or (3) of this section is applicable, the owner or operator shall comply with paragraph (q)(6) of this section.

(6)(i) An owner or operator directed to comply with this paragraph (6)(i) shall submit to the Administrator for approval, a request for determination of a compliance date, a compliance schedule, a justification for the determination of a compliance date, and a justification for the compliance schedule.

(ii) The documents required to be submitted under paragraph (q)(6)(i) of this section shall be submitted no later than 120 days after publication of the amendments of this subpart or of subpart G of this part which necessitate the request for an extension.

(iii) The Administrator shall approve or disapprove the request for a determination of a compliance date, or request changes, within 120 days after receipt of the request for determination of a compliance date, the compliance schedule, and the two justifications. If the request for determination of a compliance date is disapproved, the compliance schedule is disapproved and the owner or operator shall comply by the applicable date specified in paragraph (k),(l), or (m) of this section. If the request for the determination of a compliance date is approved, the Administrator shall specify, at the time of approval, a reasonable compliance date consistent with the introductory text in paragraph (q) of this section.

[59 FR 19454, Apr. 22, 1994, as amended at 59 FR 53360, Oct. 24, 1994; 59 FR 54132, Oct. 28, 1994; 60 FR 5321, Jan. 27, 1995; 60 FR 18023, 18028, Apr. 10, 1995; 60 FR 63626, Dec. 12, 1995; 61 FR 7718, Feb. 29, 1996; 61 FR 64574, Dec. 5, 1996; 62 FR 2729, Jan. 17, 1997; 63 FR 26081, May 12, 1998; 64 FR 20191, Apr. 26, 1999; 66 FR 6927, Jan. 22, 2001]

§ 63.101 Definitions.

(a) The following terms as used in subparts F, G, and H of this part shall have the meaning given them in subpart A of this part: Act, actual emissions, Administrator, affected source, approved permit program, commenced, compliance date, construction, continuous monitoring system, continuous parameter monitoring system, effective date, emission standard, emissions averaging, EPA, equivalent emission limitation, existing source, Federally enforceable, fixed capital cost, hazardous air pollutant, lesser quantity, major source, malfunction, new source, owner or operator, performance evaluation, performance test, permit program, permitting authority, reconstruction, relevant standard, responsible official, run, standard conditions, State, and stationary source.

(b) All other terms used in this subpart and subparts G and H of this part shall have the meaning given them in the Act and in this section. If the same term is defined in subpart A of this part and in this section, it shall have the meaning given in this section for purposes of subparts F, G, and H of this part.

Air oxidation reactor means a device or vessel in which air, or a combination of air and oxygen, is used as an oxygen source in combination with one or more organic reactants to produce one or more organic compounds. Air oxidation reactor includes the product separator and any associated vacuum pump or steam jet.

Batch operation means a noncontinuous operation in which a discrete quantity or batch of feed is charged into a unit operation within a chemical manufacturing process unit and processed at one time. Batch operation includes noncontinuous operations in which the equipment is fed intermittently or discontinuously. Addition of raw material and withdrawal of product do not occur simultaneously in a batch operation. After each batch operation, the equipment is generally emptied before a fresh batch is started.

Batch process vent means gaseous venting to the atmosphere from a batch operation.

Bottoms receiver means a tank that collects distillation bottoms before the stream is sent for storage or for further downstream processing.

By-product means a chemical that is produced coincidentally during the production of another chemical.

Chemical manufacturing process unit means the equipment assembled and connected by pipes or ducts to process raw materials and to manufacture an intended product. A chemical manufacturing process unit consists of more than one unit operation. For the purpose of this subpart, chemical manufacturing process unit includes air oxidation reactors and their associated product separators and recovery devices; reactors and their associated product separators and recovery devices; distillation units and their associated distillate receivers and recovery devices; associated unit operations; associated

recovery devices; and any feed, intermediate and product storage vessels, product transfer racks, and connected ducts and piping. A chemical manufacturing process unit includes pumps, compressors, agitators, pressure relief devices, sampling connection systems, open-ended valves or lines, valves, connectors, instrumentation systems, and control devices or systems. A chemical manufacturing process unit is identified by its primary product.

Control device means any combustion device, recovery device, or recapture device. Such equipment includes, but is not limited to, absorbers, carbon adsorbers, condensers, incinerators, flares, boilers, and process heaters. For process vents (as defined in this section), recapture devices are considered control devices but recovery devices are not considered control devices. For a steam stripper, a primary condenser is not considered a control device.

Co-product means a chemical that is produced during the production of another chemical.

Distillate receiver means overhead receivers, overhead accumulators, reflux drums, and condenser(s) including ejector-condenser(s) associated with a distillation unit.

Distillation unit means a device or vessel in which one or more feed streams are separated into two or more exit streams, each exit stream having component concentrations different from those in the feed stream(s). The separation is achieved by the redistribution of the components between the liquid and the vapor phases by vaporization and condensation as they approach equilibrium within the distillation unit. Distillation unit includes the distillate receiver, reboiler, and any associated vacuum pump or steam jet.

Emission point means an individual process vent, storage vessel, transfer rack, wastewater stream, or equipment leak.

Equipment leak means emissions of organic hazardous air pollutants from a connector, pump, compressor, agitator, pressure relief device, sampling connection system, open-ended valve or line, valve, surge control vessel, bottoms receiver, or instrumentation system in organic hazardous air pollutant service as defined in §63.161.

Ethylene process or ethylene process unit means a chemical manufacturing process unit in which ethylene and/or propylene are produced by separation from petroleum refining process streams or by subjecting hydrocarbons to high temperatures in the presence of steam. The ethylene process unit includes the separation of ethylene and/or propylene from associated streams such as a C₄ product, pyrolysis gasoline, and pyrolysis fuel oil. The ethylene process does not include the manufacture of SOCMI chemicals such as the production of butadiene from the C₄ stream and aromatics from pyrolysis gasoline.

Flexible operation unit means a chemical manufacturing process unit that manufactures different chemical products periodically by alternating raw materials or operating conditions. These units are also referred to as campaign plants or blocked operations.

Fuel gas means gases that are combusted to derive useful work or heat.

Fuel gas system means the offsite and onsite piping and flow and pressure control system that gathers gaseous stream(s) generated by onsite operations, may blend them with other sources of gas, and transports the gaseous stream for use as fuel gas in combustion devices or in in-process combustion equipment such as furnaces and gas turbines either singly or in combination.

Heat exchange system means any cooling tower system or once-through cooling water system (e.g., river or pond water). A heat exchange system can include more than one heat exchanger and can include an entire recirculating or once-through cooling system.

Impurity means a substance that is produced coincidentally with the primary product, or is present in a raw material. An impurity does not serve a useful purpose in the production or use of the primary product and is not isolated.

Initial start-up means the first time a new or reconstructed source begins production, or, for equipment added or changed as described in §63.100 (l) or (m) of this subpart, the first time the equipment is put

into operation. Initial start-up does not include operation solely for testing equipment. For purposes of subpart G of this part, initial start-up does not include subsequent start-ups (as defined in this section) of chemical manufacturing process units following malfunctions or shutdowns or following changes in product for flexible operation units or following recharging of equipment in batch operation. For purposes of subpart H of this part, initial start-up does not include subsequent start-ups (as defined in §63.161 of subpart H of this part) of process units (as defined in §63.161 of subpart H of this part) following malfunctions or process unit shutdowns.

Loading rack means a single system used to fill tank trucks and railcars at a single geographic site. Loading equipment and operations that are physically separate (i.e., do not share common piping, valves, and other equipment) are considered to be separate loading racks.

Maintenance wastewater means wastewater generated by the draining of process fluid from components in the chemical manufacturing process unit into an individual drain system prior to or during maintenance activities. Maintenance wastewater can be generated during planned and unplanned shutdowns and during periods not associated with a shutdown. Examples of activities that can generate maintenance wastewaters include descaling of heat exchanger tubing bundles, cleaning of distillation column traps, draining of low legs and high point bleeds, draining of pumps into an individual drain system, and draining of portions of the chemical manufacturing process unit for repair.

On-site or *On site* means, with respect to records required to be maintained by this subpart, that the records are stored at a location within a major source which encompasses the affected source. On-site includes, but is not limited to, storage at the chemical manufacturing process unit to which the records pertain, or storage in central files elsewhere at the major source.

Operating permit means a permit required by 40 CFR part 70 or 71.

Organic hazardous air pollutant or *organic HAP* means one of the chemicals listed in table 2 of this subpart.

Petroleum refining process, also referred to as a *petroleum refining process unit*, means a process that for the purpose of producing transportation fuels (such as gasoline and diesel fuels), heating fuels (such as fuel gas, distillate, and residual fuel oils), or lubricants separates petroleum or separates, cracks, or reforms unfinished derivatives. Examples of such units include, but are not limited to, alkylation units, catalytic hydrotreating, catalytic hydrorefining, catalytic hydrocracking, catalytic reforming, catalytic cracking, crude distillation, and thermal processes.

Plant site means all contiguous or adjoining property that is under common control, including properties that are separated only by a road or other public right-of-way. Common control includes properties that are owned, leased, or operated by the same entity, parent entity, subsidiary, or any combination thereof.

Process vent means the point of discharge to the atmosphere (or the point of entry into a control device, if any) of a gas stream if the gas stream has the characteristics specified in §63.107(b) through (h), or meets the criteria specified in §63.107(i). For purposes of §§63.113 through 63.118, all references to the characteristics of a process vent (e.g., flow rate, total HAP concentration, or TRE index value) shall mean the characteristics of the gas stream.

Process wastewater means wastewater which, during manufacturing or processing, comes into direct contact with or results from the production or use of any raw material, intermediate product, finished product, by-product, or waste product. Examples are product tank drawdown or feed tank drawdown; water formed during a chemical reaction or used as a reactant; water used to wash impurities from organic products or reactants; water used to cool or quench organic vapor streams through direct contact; and condensed steam from jet ejector systems pulling vacuum on vessels containing organics.

Product means a compound or chemical which is manufactured as the intended product of the chemical manufacturing process unit. By-products, isolated intermediates, impurities, wastes, and trace contaminants are not considered products.

Product separator means phase separators, flash drums, knock-out drums, decanters, degassers, and condenser(s) including ejector-condenser(s) associated with a reactor or an air oxidation reactor.

Reactor means a device or vessel in which one or more chemicals or reactants, other than air, are combined or decomposed in such a way that their molecular structures are altered and one or more new organic compounds are formed. Reactor includes the product separator and any associated vacuum pump or steam jet.

Recapture device means an individual unit of equipment capable of and used for the purpose of recovering chemicals, but not normally for use, reuse, or sale. For example, a recapture device may recover chemicals primarily for disposal. Recapture devices include, but are not limited to, absorbers, carbon adsorbers, and condensers.

Recovery device means an individual unit of equipment capable of and normally used for the purpose of recovering chemicals for fuel value (i.e., net positive heating value), use, reuse or for sale for fuel value, use, or reuse. Examples of equipment that may be recovery devices include absorbers, carbon adsorbers, condensers, oil-water separators or organic-water separators, or organic removal devices such as decanters, strippers, or thin-film evaporation units. For purposes of the monitoring, recordkeeping, and reporting requirements of subpart G of this part, recapture devices are considered recovery devices.

Research and development facility means laboratory and pilot plant operations whose primary purpose is to conduct research and development into new processes and products, where the operations are under the close supervision of technically trained personnel, and is not engaged in the manufacture of products for commercial sale, except in a *de minimis* manner.

Shutdown means for purposes including, but not limited to, periodic maintenance, replacement of equipment, or repair, the cessation of operation of a chemical manufacturing process unit or a reactor, air oxidation reactor, distillation unit, waste management unit, equipment required or used to comply with this subpart F, subparts G, or H of this part or the emptying and degassing of a storage vessel. Shutdown does not include the routine rinsing or washing of equipment in batch operation between batches.

Source means the collection of emission points to which this subpart applies as determined by the criteria in §63.100 of this subpart. For purposes of subparts F, G, and H of this part, the term *affected source* as used in subpart A of this part has the same meaning as the term *source* defined here.

Start-up means the setting into operation of a chemical manufacturing process unit or a reactor, air oxidation reactor, distillation unit, waste management unit, or equipment required or used to comply with this subpart F, subpart G, or H of this part or a storage vessel after emptying and degassing. Start-up includes initial start-up, operation solely for testing equipment, the recharging of equipment in batch operation, and transitional conditions due to changes in product for flexible operation units.

Start-up, shutdown, and malfunction plan means the plan required under §63.6(e)(3) of subpart A of this part. This plan details the procedures for operation and maintenance of the source during periods of start-up, shutdown, and malfunction.

Storage vessel means a tank or other vessel that is used to store organic liquids that contain one or more of the organic HAP's listed in table 2 of this subpart and that has been assigned, according to the procedures in §63.100(g) of this subpart, to a chemical manufacturing process unit that is subject to this subpart. Storage vessel does not include:

- (1) Vessels permanently attached to motor vehicles such as trucks, railcars, barges, or ships;
- (2) Pressure vessels designed to operate in excess of 204.9 kilopascals and without emissions to the atmosphere;
- (3) Vessels with capacities smaller than 38 cubic meters;
- (4) Vessels storing organic liquids that contain organic hazardous air pollutants only as impurities;
- (5) Bottoms receiver tanks;
- (6) Surge control vessels; or

(7) Wastewater storage tanks. Wastewater storage tanks are covered under the wastewater provisions.

Surge control vessel means feed drums, recycle drums, and intermediate vessels. Surge control vessels are used within a chemical manufacturing process unit when in-process storage, mixing, or management of flow rates or volumes is needed to assist in production of a product.

Transfer operation means the loading, into a tank truck or railcar, of organic liquids that contain one or more of the organic hazardous air pollutants listed in table 2 of this subpart from a transfer rack (as defined in this section). Transfer operations do not include loading at an operating pressure greater than 204.9 kilopascals.

Transfer rack means the collection of loading arms and loading hoses, at a single loading rack, that are assigned to a chemical manufacturing process unit subject to this subpart according to the procedures specified in §63.100(h) of this subpart and are used to fill tank trucks and/or railcars with organic liquids that contain one or more of the organic hazardous air pollutants listed in table 2 of this subpart. Transfer rack includes the associated pumps, meters, shutoff valves, relief valves, and other piping and valves. Transfer rack does not include:

- (1) Racks, arms, or hoses that only transfer liquids containing organic hazardous air pollutants as impurities;
- (2) Racks, arms, or hoses that vapor balance during all loading operations; or
- (3) Racks transferring organic liquids that contain organic hazardous air pollutants only as impurities.

Unit operation means one or more pieces of process equipment used to make a single change to the physical or chemical characteristics of one or more process streams. Unit operations include, but are not limited to, reactors, distillation units, extraction columns, absorbers, decanters, dryers, condensers, and filtration equipment.

Vapor balancing system means a piping system that is designed to collect organic hazardous air pollutants vapors displaced from tank trucks or railcars during loading; and to route the collected organic hazardous air pollutants vapors to the storage vessel from which the liquid being loaded originated, or to another storage vessel connected by a common header or to compress and route to a process or a fuel gas system the collected organic hazardous air pollutants vapors.

Waste management unit means the equipment, structure(s), and/or device(s) used to convey, store, treat, or dispose of wastewater streams or residuals. Examples of waste management units include: Wastewater tanks, surface impoundments, individual drain systems, and biological wastewater treatment units. Examples of equipment that may be waste management units include containers, air flotation units, oil-water separators or organic-water separators, or organic removal devices such as decanters, strippers, or thin-film evaporation units. If such equipment is used for recovery then it is part of a chemical manufacturing process unit and is not a waste management unit.

Wastewater means water that:

(1) Contains either:

(i) An annual average concentration of Table 9 compounds (as defined in §63.111 of subpart G of this part) of at least 5 parts per million by weight and has an annual average flow rate of 0.02 liter per minute or greater, or

(ii) An annual average concentration of Table 9 compounds (as defined in §63.111 of subpart G) of at least 10,000 parts per million by weight at any flow rate, and that

(2) Is discarded from a chemical manufacturing process unit that meets all of the criteria specified in §63.100 (b)(1) through (b)(3) of this subpart. Wastewater is process wastewater or maintenance wastewater.

[59 FR 19454, Apr. 22, 1994, as amended at 60 FR 18024, Apr. 10, 1995; 60 FR 63626, Dec. 12, 1995;

62 FR 2731, Jan. 17, 1997; 65 FR 26497, May 8, 2000; 66 FR 6928, Jan. 22, 2001]

§ 63.102 General standards.

(a) Owners and operators of sources subject to this subpart shall comply with the requirements of subparts G and H of this part.

(1) The provisions set forth in this subpart F and subpart G of this part shall apply at all times except during periods of start-up or shutdown (as defined in §63.101 of this subpart), malfunction, or non-operation of the chemical manufacturing process unit (or specific portion thereof) resulting in cessation of the emissions to which this subpart F and subpart G of this part apply. However, if a start-up, shutdown, malfunction or period of non-operation of one portion of a chemical manufacturing process unit does not affect the ability of a particular emission point to comply with the specific provisions to which it is subject, then that emission point shall still be required to comply with the applicable provisions of this subpart F and subpart G of this part during the start-up, shutdown, malfunction or period of non-operation. For example, if there is an overpressure in the reactor area, a storage vessel in the chemical manufacturing process unit would still be required to be controlled in accordance with §63.119 of subpart G of the part. Similarly, the degassing of a storage vessel would not affect the ability of a process vent to meet the requirements of §63.113 of subpart G of this part.

(2) The provisions set forth in subpart H of this part shall apply at all times except during periods of start-up or shutdown, as defined in §63.101(b) of this subpart, malfunction, process unit shutdown (as defined in §63.161 of subpart H of this part), or non-operation of the chemical manufacturing process unit (or specific portion thereof) in which the lines are drained and depressurized resulting in cessation of the emissions to which subpart H of this part applies.

(3) The owner or operator shall not shut down items of equipment that are required or utilized for compliance with the provisions of this subpart F, subpart G or H of this part during times when emissions (or, where applicable, wastewater streams or residuals) are being routed to such items of equipment, if the shutdown would contravene requirements of this subpart F, subpart G or H of this part applicable to such items of equipment. This paragraph does not apply if the item of equipment is malfunctioning, or if the owner or operator must shut down the equipment to avoid damage due to a contemporaneous start-up, shutdown, or malfunction of the chemical manufacturing process unit or portion thereof.

(4) During start-ups, shutdowns, and malfunctions when the requirements of this subpart F, subparts G and/or H of this part do not apply pursuant to paragraphs (a)(1) through (a)(3) of this section, the owner or operator shall implement, to the extent reasonably available, measures to prevent or minimize excess emissions to the extent practical. The general duty to minimize emissions during a period of startup, shutdown, or malfunction does not require the owner or operator to achieve emission levels that would be required by the applicable standard at other times if this is not consistent with safety and good air pollution control practices, nor does it require the owner or operator to make any further efforts to reduce emissions if levels required by the applicable standard have been achieved. Determination of whether such operation and maintenance procedures are being used will be based on information available to the Administrator which may include, but is not limited to, monitoring results, review of operation and maintenance procedures (including the startup, shutdown, and malfunction plan required in §63.6(e)(3)), review of operation and maintenance records, and inspection of the source. The measures to be taken may include, but are not limited to, air pollution control technologies, recovery technologies, work practices, pollution prevention, monitoring, and/or changes in the manner of operation of the source. Back-up control devices are not required, but may be used if available.

(b) If, in the judgment of the Administrator, an alternative means of emission limitation will achieve a reduction in organic HAP emissions at least equivalent to the reduction in organic HAP emissions from that source achieved under any design, equipment, work practice, or operational standards in subpart G or H of this part, the Administrator will publish in the Federal Register a notice permitting the use of the alternative means for purposes of compliance with that requirement.

(1) The notice may condition the permission on requirements related to the operation and maintenance of the alternative means.

(2) Any notice under paragraph (b) of this section shall be published only after public notice and an opportunity for a hearing.

(3) Any person seeking permission to use an alternative means of compliance under this section shall collect, verify, and submit to the Administrator information showing that the alternative means achieves equivalent emission reductions.

(c) Each owner or operator of a source subject to this subpart shall obtain a permit under 40 CFR part 70 or part 71 from the appropriate permitting authority by the date determined by 40 CFR part 70 or part 71, as appropriate.

(1) If the EPA has approved a State operating permit program under 40 CFR Part 70, the permit shall be obtained from the State authority. If the State operating permit program has not been approved, the source shall apply to the EPA Regional Office.

(2) [Reserved]

(d) The requirements in subparts F, G, and H of this part are Federally enforceable under section 112 of the Act on and after the dates specified in §63.100(k) of this subpart.

[59 FR 19454, Apr. 22, 1994, as amended at 60 FR 63626, Dec. 12, 1995; 61 FR 64575, Dec. 5, 1996; 62 FR 2732, Jan. 17, 1997; 71 FR 20455, Apr. 20, 2006]

§ 63.103 General compliance, reporting, and recordkeeping provisions.

(a) Table 3 of this subpart specifies the provisions of subpart A that apply and those that do not apply to owners and operators of sources subject to subparts F, G, and H of this part.

(b) Initial performance tests and initial compliance determinations shall be required only as specified in subparts G and H of this part.

(1) Performance tests and compliance determinations shall be conducted according to the schedule and procedures in §63.7(a) of subpart A of this part and the applicable sections of subparts G and H of this part.

(2) The owner or operator shall notify the Administrator of the intention to conduct a performance test at least 30 calendar days before the performance test is scheduled to allow the Administrator the opportunity to have an observer present during the test.

(3) Performance tests shall be conducted according to the provisions of §63.7(e) of subpart A of this part, except that performance tests shall be conducted at maximum representative operating conditions for the process. During the performance test, an owner or operator may operate the control or recovery device at maximum or minimum representative operating conditions for monitored control or recovery device parameters, whichever results in lower emission reduction.

(4) Data shall be reduced in accordance with the EPA-approved methods specified in the applicable subpart or, if other test methods are used, the data and methods shall be validated according to the protocol in Method 301 of appendix A of this part.

(5) Performance tests may be waived with approval of the Administrator as specified in §63.7(h)(2) of subpart A of this part. Owners or operators of sources subject to subparts F, G, and H of this part who apply for a waiver of a performance test shall submit the application by the dates specified in paragraph (b)(5)(i) of this section rather than the dates specified in §63.7(h)(3) of subpart A of this part.

(i) If a request is made for an extension of compliance under §63.151(a)(6) of subpart G or §63.6(i) of subpart A of this part, the application for a waiver of an initial performance test shall accompany the information required for the request for an extension of compliance. If no extension of compliance is requested, the application for a waiver of an initial performance test shall be submitted no later than 90 calendar days before the Notification of Compliance Status required in §63.152(b) of subpart G of this part is due to be submitted.

(ii) Any application for a waiver of a performance test shall include information justifying the owner or operator's request for a waiver, such as the technical or economic infeasibility, or the impracticality, of

the source performing the required test.

(6) The owner or operator of a flexible operation unit shall conduct all required compliance demonstrations during production of the primary product. The owner or operator is not required to conduct compliance demonstrations for operating conditions during production of a product other than the primary product. Except as otherwise provided in this subpart or in subpart G or subpart H of this part, as applicable, the owner or operator shall operate each control device, recovery device, and/or recapture device that is required or used for compliance, and associated monitoring systems, without regard for whether the product that is being produced is the primary product or a different product. Except as otherwise provided in this subpart, subpart G and/or subpart H of this part, as applicable, operation of a control device, recapture device and/or recovery device required or used for compliance such that the daily average of monitored parameter values is outside the parameter range established pursuant to §63.152(b)(2), or such that the monitoring data show operation inconsistent with the monitoring plan established pursuant to §63.120(d)(2) or §63.181(g)(1)(iv), shall constitute a violation of the required operating conditions.

(c) Each owner or operator of a source subject to subparts F, G, and H of this part shall keep copies of all applicable reports and records required by subparts F, G, and H of this part for at least 5 years; except that, if subparts G or H require records to be maintained for a time period different than 5 years, those records shall be maintained for the time specified in subpart G or H of this part. If an owner or operator submits copies of reports to the applicable EPA Regional Office, the owner or operator is not required to maintain copies of reports. If the EPA Regional Office has waived the requirement of §63.10(a)(4)(ii) for submittal of copies of reports, the owner or operator is not required to maintain copies of reports.

(1) All applicable records shall be maintained in such a manner that they can be readily accessed. The most recent 6 months of records shall be retained on site or shall be accessible from a central location by computer or other means that provides access within 2 hours after a request. The remaining four and one-half years of records may be retained offsite. Records may be maintained in hard copy or computer-readable form including, but not limited to, on paper, microfilm, computer, floppy disk, magnetic tape, or microfiche.

(2) The owner or operator subject to subparts F, G, and H of this part shall keep the records specified in this paragraph, as well as records specified in subparts G and H.

(i) Records of the occurrence and duration of each start-up, shutdown, and malfunction of operation of process equipment or of air pollution control equipment or continuous monitoring systems used to comply with this subpart F, subpart G, or H of this part during which excess emissions (as defined in §63.102(a)(4)) occur.

(ii) For each start-up, shutdown, and malfunction during which excess emissions (as defined in §63.102(a)(4)) occur, records that the procedures specified in the source's start-up, shutdown, and malfunction plan were followed, and documentation of actions taken that are not consistent with the plan. For example, if a start-up, shutdown, and malfunction plan includes procedures for routing a control device to a backup control device (e.g., the incinerator for a halogenated stream could be routed to a flare during periods when the primary control device is out of service), records must be kept of whether the plan was followed. These records may take the form of a "checklist," or other form of recordkeeping that confirms conformance with the start-up, shutdown, and malfunction plan for the event.

(iii) For continuous monitoring systems used to comply with subpart G of this part, records documenting the completion of calibration checks and maintenance of continuous monitoring systems that are specified in the manufacturer's instructions or other written procedures that provide adequate assurance that the equipment would reasonably be expected to monitor accurately.

(3) Records of start-up, shutdown and malfunction and continuous monitoring system calibration and maintenance are not required if they pertain solely to Group 2 emission points, as defined in §63.111 of subpart G of this part, that are not included in an emissions average.

(d) All reports required under subparts F, G, and H of this part shall be sent to the Administrator at the addresses listed in §63.13 of subpart A of this part, except that requests for permission to use an alternative means of compliance as provided for in §63.102(b) of this subpart and application for approval of a nominal efficiency as provided for in §63.150 (i)(1) through (i)(6) of subpart G of this part shall be submitted to the Director of the EPA Office of Air Quality Planning and Standards rather than to

the Administrator or delegated authority.

(1) Wherever subpart A of this part specifies "postmark" dates, submittals may be sent by methods other than the U.S. Mail (e.g., by fax or courier). Submittals shall be sent on or before the specified date.

(2) If acceptable to both the Administrator and the owner or operator of a source, reports may be submitted on electronic media.

(e) The owner or operator of a chemical manufacturing process unit which meets the criteria of §63.100(b)(1) and §63.100(b)(3), but not the criteria of §63.100(b)(2), shall comply with the requirements of either paragraph (e)(1) or (e)(2) of this section.

(1) Retain information, data, and analysis used to determine that the chemical manufacturing process unit does not use as a reactant or manufacture as a product or co-product any organic hazardous air pollutant. Examples of information that could document this include, but are not limited to, records of chemicals purchased for the process, analyses of process stream composition, engineering calculations, or process knowledge.

(2) When requested by the Administrator, demonstrate that the chemical manufacturing process unit does not use as a reactant or manufacture as a product or co-product any organic hazardous air pollutant.

(f) To qualify for the exemption specified in §63.100(b)(4) of this subpart, the owner or operator shall maintain the documentation of the information required pursuant to §63.100(b)(4)(i), and documentation of any update of this information requested by the EPA Regional Office, and shall provide the documentation to the EPA Regional Office upon request. The EPA Regional Office will notify the owner or operator, after reviewing such documentation, if the source does not qualify for the exemption specified in §63.100(b)(4) of this section. In such cases, compliance with subpart H shall be required no later than 90 days after expiration of the applicable compliance date in §63.100(k)(3), but in no event earlier than 90 days after the date of such notification by the EPA Regional Office. Compliance with this subpart F and subpart G of this part shall be no later than April 22, 1997, or as otherwise specified in §63.100(k)(2)(ii) of this subpart, unless an extension has been granted by the EPA Regional Office or permitting authority as provided in §63.6(i) of subpart A of this part.

(g) An owner or operator who elects to use the compliance extension provisions of §63.100(k)(6)(i) or (ii) shall submit a compliance extension request to the appropriate EPA Regional Office no later than 45 days before the applicable compliance date in §63.100(k)(3), but in no event is submittal required earlier than May 10, 1995. The request shall contain the information specified in §63.100(k)(5)(iv) and the reason compliance can not reasonably be achieved without a process unit shutdown, as defined in 40 CFR 63.161 or without replacement of the compressor or recasting of the distance piece.

(h) An owner or operator who elects to use the compliance extension provisions of §63.100(k)(8) shall submit to the appropriate EPA Regional Office a brief description of the process change, identify the HAP eliminated, and the expected date of cessation of use or production of HAP. The description shall be submitted no later than May 10, 1995, or with the Notice of Compliance Status as required in §63.182(c) of subpart H, whichever is later.

[59 FR 19454, Apr. 22, 1994, as amended at 59 FR 48176, Sept. 20, 1994; 60 FR 18024, Apr. 10, 1995; 62 FR 2733, Jan. 17, 1997; 63 FR 26082, May 12, 1998]

§ 63.104 Heat exchange system requirements.

(a) Unless one or more of the conditions specified in paragraphs (a)(1) through (a)(6) of this section are met, owners and operators of sources subject to this subpart shall monitor each heat exchange system used to cool process equipment in a chemical manufacturing process unit meeting the conditions of §63.100(b)(1) through (b)(3) of this subpart, except for chemical manufacturing process units meeting the condition specified in §63.100(c) of this subpart, according to the provisions in either paragraph (b) or (c) of this section. Whenever a leak is detected, the owner or operator shall comply with the requirements in paragraph (d) of this section.

(1) The heat exchange system is operated with the minimum pressure on the cooling water side at least

35 kilopascals greater than the maximum pressure on the process side.

(2) There is an intervening cooling fluid, containing less than 5 percent by weight of total hazardous air pollutants listed in table 4 of this subpart, between the process and the cooling water. This intervening fluid serves to isolate the cooling water from the process fluid and the intervening fluid is not sent through a cooling tower or discharged. For purposes of this section, discharge does not include emptying for maintenance purposes.

(3) The once-through heat exchange system is subject to a National Pollution Discharge Elimination System (NPDES) permit with an allowable discharge limit of 1 part per million or less above influent concentration or 10 percent or less above influent concentration, whichever is greater.

(4) The once-through heat exchange system is subject to an NPDES permit that:

(i) Requires monitoring of a parameter(s) or condition(s) to detect a leak of process fluids into cooling water;

(ii) Specifies or includes the normal range of the parameter or condition;

(iii) Requires monitoring for the parameters selected as leak indicators no less frequently than monthly for the first six months and quarterly thereafter; and

(iv) Requires the owner or operator to report and correct leaks to the cooling water when the parameter or condition exceeds the normal range.

(5) The recirculating heat exchange system is used to cool process fluids that contain less than 5 percent by weight of total hazardous air pollutants listed in table 4 of this subpart.

(6) The once-through heat exchange system is used to cool process fluids that contain less than 5 percent by weight of total hazardous air pollutants listed in table 9 of subpart G of this part.

(b) The owner or operator who elects to comply with the requirements of paragraph (a) of this section by monitoring the cooling water for the presence of one or more organic hazardous air pollutants or other representative substances whose presence in cooling water indicates a leak shall comply with the requirements specified in paragraphs (b)(1) through (b)(6) of this section. The cooling water shall be monitored for total hazardous air pollutants, total volatile organic compounds, total organic carbon, one or more speciated HAP compounds, or other representative substances that would indicate the presence of a leak in the heat exchange system.

(1) The cooling water shall be monitored monthly for the first 6 months and quarterly thereafter to detect leaks.

(2)(i) For recirculating heat exchange systems (cooling tower systems), the monitoring of speciated hazardous air pollutants or total hazardous air pollutants refers to the hazardous air pollutants listed in table 4 of this subpart.

(ii) For once-through heat exchange systems, the monitoring of speciated hazardous air pollutants or total hazardous air pollutants refers to the hazardous air pollutants listed in table 9 of subpart G of this part.

(3) The concentration of the monitored substance(s) in the cooling water shall be determined using any EPA-approved method listed in part 136 of this chapter as long as the method is sensitive to concentrations as low as 10 parts per million and the same method is used for both entrance and exit samples. Alternative methods may be used upon approval by the Administrator.

(4) The samples shall be collected either at the entrance and exit of each heat exchange system or at locations where the cooling water enters and exits each heat exchanger or any combination of heat exchangers.

(i) For samples taken at the entrance and exit of recirculating heat exchange systems, the entrance is

the point at which the cooling water leaves the cooling tower prior to being returned to the process equipment and the exit is the point at which the cooling water is introduced to the cooling tower after being used to cool the process fluid.

(ii) For samples taken at the entrance and exit of once-through heat exchange systems, the entrance is the point at which the cooling water enters and the exit is the point at which the cooling water exits the plant site or chemical manufacturing process units.

(iii) For samples taken at the entrance and exit of each heat exchanger or any combination of heat exchangers in chemical manufacturing process units, the entrance is the point at which the cooling water enters the individual heat exchanger or group of heat exchangers and the exit is the point at which the cooling water exits the heat exchanger or group of heat exchangers.

(5) A minimum of three sets of samples shall be taken at each entrance and exit as defined in paragraph (b)(4) of this section. The average entrance and exit concentrations shall then be calculated. The concentration shall be corrected for the addition of any makeup water or for any evaporative losses, as applicable.

(6) A leak is detected if the exit mean concentration is found to be greater than the entrance mean using a one-sided statistical procedure at the 0.05 level of significance and the amount by which it is greater is at least 1 part per million or 10 percent of the entrance mean, whichever is greater.

(c) The owner or operator who elects to comply with the requirement of paragraph (a) of this section by monitoring using a surrogate indicator of heat exchange system leaks shall comply with the requirements specified in paragraphs (c)(1) through (c)(3) of this section. Surrogate indicators that could be used to develop an acceptable monitoring program are ion specific electrode monitoring, pH, conductivity or other representative indicators.

(1) The owner or operator shall prepare and implement a monitoring plan that documents the procedures that will be used to detect leaks of process fluids into cooling water. The plan shall require monitoring of one or more surrogate indicators or monitoring of one or more process parameters or other conditions that indicate a leak. Monitoring that is already being conducted for other purposes may be used to satisfy the requirements of this section. The plan shall include the information specified in paragraphs (c)(1)(i) and (c)(1)(ii) of this section.

(i) A description of the parameter or condition to be monitored and an explanation of how the selected parameter or condition will reliably indicate the presence of a leak.

(ii) The parameter level(s) or conditions(s) that shall constitute a leak. This shall be documented by data or calculations showing that the selected levels or conditions will reliably identify leaks. The monitoring must be sufficiently sensitive to determine the range of parameter levels or conditions when the system is not leaking. When the selected parameter level or condition is outside that range, a leak is indicated.

(iii) The monitoring frequency which shall be no less frequent than monthly for the first 6 months and quarterly thereafter to detect leaks.

(iv) The records that will be maintained to document compliance with the requirements of this section.

(2) If a substantial leak is identified by methods other than those described in the monitoring plan and the method(s) specified in the plan could not detect the leak, the owner or operator shall revise the plan and document the basis for the changes. The owner or operator shall complete the revisions to the plan no later than 180 days after discovery of the leak.

(3) The owner or operator shall maintain, at all times, the monitoring plan that is currently in use. The current plan shall be maintained on-site, or shall be accessible from a central location by computer or other means that provides access within 2 hours after a request. If the monitoring plan is superseded, the owner or operator shall retain the most recent superseded plan at least until 5 years from the date of its creation. The superseded plan shall be retained on-site (or accessible from a central location by computer or other means that provides access within two hours after a request) for at least 6 months after its creation.

(d) If a leak is detected according to the criteria of paragraph (b) or (c) of this section, the owner or operator shall comply with the requirements in paragraphs (d)(1) and (d)(2) of this section, except as provided in paragraph (e) of this section.

(1) The leak shall be repaired as soon as practical but not later than 45 calendar days after the owner or operator receives results of monitoring tests indicating a leak. The leak shall be repaired unless the owner or operator demonstrates that the results are due to a condition other than a leak.

(2) Once the leak has been repaired, the owner or operator shall confirm that the heat exchange system has been repaired within 7 calendar days of the repair or startup, whichever is later.

(e) Delay of repair of heat exchange systems for which leaks have been detected is allowed if the equipment is isolated from the process. Delay of repair is also allowed if repair is technically infeasible without a shutdown and any one of the conditions in paragraph (e)(1) or (e)(2) of this section is met. All time periods in paragraphs (e)(1) and (e)(2) of this section shall be determined from the date when the owner or operator determines that delay of repair is necessary.

(1) If a shutdown is expected within the next 2 months, a special shutdown before that planned shutdown is not required.

(2) If a shutdown is not expected within the next 2 months, the owner or operator may delay repair as provided in paragraph (e)(2)(i) or (e)(2)(ii) of this section. Documentation of a decision to delay repair shall state the reasons repair was delayed and shall specify a schedule for completing the repair as soon as practical.

(i) If a shutdown for repair would cause greater emissions than the potential emissions from delaying repair, the owner or operator may delay repair until the next shutdown of the process equipment associated with the leaking heat exchanger. The owner or operator shall document the basis for the determination that a shutdown for repair would cause greater emissions than the emissions likely to result from delaying repair as specified in paragraphs (e)(2)(i)(A) and (e)(2)(i)(B) of this section.

(A) The owner or operator shall calculate the potential emissions from the leaking heat exchanger by multiplying the concentration of total hazardous air pollutants listed in table 4 of this subpart in the cooling water from the leaking heat exchanger by the flowrate of the cooling water from the leaking heat exchanger by the expected duration of the delay. The owner or operator may calculate potential emissions using total organic carbon concentration instead of total hazardous air pollutants listed in table 4 of this subpart.

(B) The owner or operator shall determine emissions from purging and depressurizing the equipment that will result from the unscheduled shutdown for the repair.

(ii) If repair is delayed for reasons other than those specified in paragraph (e)(2)(i) of this section, the owner or operator may delay repair up to a maximum of 120 calendar days. The owner shall demonstrate that the necessary parts or personnel were not available.

(f)(1) *Required records.* The owner or operator shall retain the records identified in paragraphs (f)(1)(i) through (f)(1)(iv) of this section as specified in §63.103(c)(1).

(i) Monitoring data required by this section indicating a leak and the date when the leak was detected, and if demonstrated not to be a leak, the basis for that determination;

(ii) Records of any leaks detected by procedures subject to paragraph (c)(2) of this section and the date the leak was discovered;

(iii) The dates of efforts to repair leaks; and

(iv) The method or procedure used to confirm repair of a leak and the date repair was confirmed.

(2) *Reports.* If an owner or operator invokes the delay of repair provisions for a heat exchange system, the following information shall be submitted in the next semi-annual periodic report required by §63.152

(c) of subpart G of this part. If the leak remains unrepaired, the information shall also be submitted in each subsequent periodic report, until repair of the leak is reported.

(i) The owner or operator shall report the presence of the leak and the date that the leak was detected.

(ii) The owner or operator shall report whether or not the leak has been repaired.

(iii) The owner or operator shall report the reason(s) for delay of repair. If delay of repair is invoked due to the reasons described in paragraph (e)(2) of this section, documentation of emissions estimates must also be submitted.

(iv) If the leak remains unrepaired, the owner or operator shall report the expected date of repair.

(v) If the leak is repaired, the owner or operator shall report the date the leak was successfully repaired.

[62 FR 2733, Jan. 17, 1997]

§ 63.105 Maintenance wastewater requirements.

(a) Each owner or operator of a source subject to this subpart shall comply with the requirements of paragraphs (b) through (e) of this section for maintenance wastewaters containing those organic HAP's listed in table 9 of subpart G of this part.

(b) The owner or operator shall prepare a description of maintenance procedures for management of wastewaters generated from the emptying and purging of equipment in the process during temporary shutdowns for inspections, maintenance, and repair (i.e., a maintenance-turnaround) and during periods which are not shutdowns (i.e., routine maintenance). The descriptions shall:

(1) Specify the process equipment or maintenance tasks that are anticipated to create wastewater during maintenance activities.

(2) Specify the procedures that will be followed to properly manage the wastewater and control organic HAP emissions to the atmosphere; and

(3) Specify the procedures to be followed when clearing materials from process equipment.

(c) The owner or operator shall modify and update the information required by paragraph (b) of this section as needed following each maintenance procedure based on the actions taken and the wastewaters generated in the preceding maintenance procedure.

(d) The owner or operator shall incorporate the procedures described in paragraphs (b) and (c) of this section as part of the startup, shutdown, and malfunction plan required under §63.6(e)(3).

(e) The owner or operator shall maintain a record of the information required by paragraphs (b) and (c) of this section as part of the start-up, shutdown, and malfunction plan required under §63.6(e)(3) of subpart A of this part.

[59 FR 19454, Apr. 22, 1994, as amended at 60 FR 63626, Dec. 12, 1995; 71 FR 20456, Apr. 20, 2006]

§ 63.106 Implementation and enforcement.

(a) This subpart can be implemented and enforced by the U.S. EPA, or a delegated authority such as the applicable State, local, or Tribal agency. If the U.S. EPA Administrator has delegated authority to a State, local, or Tribal agency, then that agency, in addition to the U.S. EPA, has the authority to implement and enforce this subpart. Contact the applicable U.S. EPA Regional Office to find out if implementation and enforcement of this subpart is delegated to a State, local, or Tribal agency.

(b) In delegating implementation and enforcement authority of this subpart to a State, local, or Tribal

agency under subpart E of this part, the authorities contained in paragraph (c) of this section are retained by the Administrator of U.S. EPA and cannot be transferred to the State, local, or Tribal agency.

(c) The authorities that cannot be delegated to State, local, or Tribal agencies are as specified in paragraphs (c)(1) through (4) of this section.

(1) Approval of alternatives to requirements in §§63.100, 63.102, and 63.104. Where these standards reference another subpart, the cited provisions will be delegated according to the delegation provisions of the referenced subpart.

(2) Approval of major alternatives to test methods under §63.7(e)(2)(ii) and (f), as defined in §63.90, and as required in this subpart.

(3) Approval of major alternatives to monitoring under §63.8(f), as defined in §63.90, and as required in this subpart.

(4) Approval of major alternatives to recordkeeping and reporting under §63.10(f), as defined in §63.90, and as required in this subpart.

[68 FR 37344, June 23, 2003]

§ 63.107 Identification of process vents subject to this subpart.

(a) The owner or operator shall use the criteria specified in this §63.107 to determine whether there are any process vents associated with an air oxidation reactor, distillation unit, or reactor that is in a source subject to this subpart. A process vent is the point of discharge to the atmosphere (or the point of entry into a control device, if any) of a gas stream if the gas stream has the characteristics specified in paragraphs (b) through (h) of this section, or meets the criteria specified in paragraph (i) of this section.

(b) Some, or all, of the gas stream originates as a continuous flow from an air oxidation reactor, distillation unit, or reactor during operation of the chemical manufacturing process unit.

(c) The discharge to the atmosphere (with or without passing through a control device) meets at least one of the conditions specified in paragraphs (c)(1) through (3) of this section.

(1) Is directly from an air oxidation reactor, distillation unit, or reactor; or

(2) Is from an air oxidation reactor, distillation unit, or reactor after passing solely (*i.e.*, without passing through any other unit operation for a process purpose) through one or more recovery devices within the chemical manufacturing process unit; or

(3) Is from a device recovering only mechanical energy from a gas stream that comes either directly from an air oxidation reactor, distillation unit, or reactor, or from an air oxidation reactor, distillation unit, or reactor after passing solely (*i.e.*, without passing through any other unit operation for a process purpose) through one or more recovery devices within the chemical manufacturing process unit.

(d) The gas stream contains greater than 0.005 weight percent total organic HAP at the point of discharge to the atmosphere (or at the point of entry into a control device, if any).

(e) The air oxidation reactor, distillation unit, or reactor is part of a chemical manufacturing process unit that meets the criteria of §63.100(b).

(f) The gas stream is in the gas phase from the point of origin at the air oxidation reactor, distillation unit, or reactor to the point of discharge to the atmosphere (or to the point of entry into a control device, if any).

(g) The gas stream is discharged to the atmosphere either on-site, off-site, or both.

(h) The gas stream is not any of the items identified in paragraphs (h)(1) through (9) of this section.

- (1) A relief valve discharge.
- (2) A leak from equipment subject to subpart H of this part.
- (3) A gas stream going to a fuel gas system as defined in §63.101.
- (4) A gas stream exiting a control device used to comply with §63.113.
- (5) A gas stream transferred to other processes (on-site or off-site) for reaction or other use in another process (*i.e.*, for chemical value as a product, isolated intermediate, byproduct, or coproduct, or for heat value).
- (6) A gas stream transferred for fuel value (*i.e.*, net positive heating value), use, reuse, or for sale for fuel value, use, or reuse.
- (7) A storage vessel vent or transfer operation vent subject to §63.119 or §63.126.
- (8) A vent from a waste management unit subject to §§63.132 through 63.137.
- (9) A gas stream exiting an analyzer.
- (i) The gas stream would meet the characteristics specified in paragraphs (b) through (g) of this section, but, for purposes of avoiding applicability, has been deliberately interrupted, temporarily liquefied, routed through any item of equipment for no process purpose, or disposed of in a flare that does not meet the criteria in §63.11(b), or an incinerator that does not reduce emissions of organic HAP by 98 percent or to a concentration of 20 parts per million by volume, whichever is less stringent.

[66 FR 6928, Jan. 22, 2001]

Table 1 to Subpart F of Part 63—Synthetic Organic Chemical Manufacturing Industry Chemicals

Chemical name^a	CAS No.^b	Group
Acenaphthene	83329	V
Acetal	105577	V
Acetaldehyde	75070	II
Acetamide	60355	II
Acetanilide	103844	II
Acetic acid	64197	II
Acetic anhydride	108247	II
Acetoacetanilide	102012	III
Acetone	67641	I
Acetone cyanohydrin	75865	V
Acetonitrile	75058	I
Acetophenone	98862	I
Acrolein	107028	IV
Acrylamide	79061	I
Acrylic acid	79107	IV
Acrylonitrile	107131	I

Adiponitrile	111693	I
Alizarin	72480	V
Alkyl anthraquinones	008	V
Allyl alcohol	107186	I
Allyl chloride	107051	IV
Allyl cyanide	109751	IV
Aminophenol sulfonic acid	0010	V
Aminophenol (p-)	123308	I
Aniline	62533	I
Aniline hydrochloride	142041	III
Anisidine (o-)	90040	II
Anthracene	120127	V
Anthraquinone	84651	III
Azobenzene	103333	I
Benzaldehyde	100527	III
Benzene	71432	I
Benzenedisulfonic acid	98486	I
Benzenesulfonic acid	98113	I
Benzil	134816	III
Benzilic acid	76937	III
Benzoic acid	65850	III
Benzoin	119539	III
Benzonitrile	100470	III
Benzophenone	119619	I
Benzotrichloride	98077	III
Benzoyl chloride	98884	III
Benzyl acetate	140114	III
Benzyl alcohol	100516	III
Benzyl benzoate	120514	III
Benzyl chloride	100447	III
Benzyl dichloride	98873	III
Biphenyl	92524	I
Bisphenol A	80057	III
Bis(Chloromethyl) Ether	542881	I
Bromobenzene	108861	I
Bromoform	75252	V
Bromonaphthalene	27497514	IV
Butadiene (1,3-)	106990	II
Butanediol (1,4-)	110634	I
Butyl acrylate (n-)	141322	V

Butylene glycol (1,3-)	107880	II
Butyrolactone	96480	I
Caprolactam	105602	II
Carbaryl	63252	V
Carbazole	86748	V
Carbon disulfide	75150	IV
Carbon tetrabromide	558134	II
Carbon tetrachloride	56235	I
Carbon tetrafluoride	75730	II
Chloral	75876	II
Chloroacetic acid	79118	II
Chloroacetophenone (2-)	532274	I
Chloroaniline (p-)	106478	II
Chlorobenzene	108907	I
2-Chloro-1,3-butadiene (Chloroprene)	126998	II
Chlorodifluoroethane	25497294	V
Chlorodifluoromethane	75456	I
Chloroform	67663	I
Chloronaphthalene	25586430	IV
Chloronitrobenzene	121733	I
(m-).		
Chloronitrobenzene	88733	I
(o-).		
Chloronitrobenzene	100005	I
(p-).		
Chlorophenol (m-)	108430	II
Chlorophenol (o-)	95578	II
Chlorophenol (p-)	106489	II
Chlorotoluene (m-)	108418	III
Chlorotoluene (o-)	95498	III
Chlorotoluene (p-)	106434	III
Chlorotrifluoromethane	75729	II
Chrysene	218019	V
Cresol and cresylic acid (m-)	108394	III
Cresol and cresylic acid (o-)	95487	III
Cresol and cresylic acid (p-)	106445	III
Cresols and cresylic acids (mixed)	1319773	III
Cumene	98828	I
Cumene hydroperoxide	80159	I
Cyanoacetic acid	372098	II

Cyclohexane	110827	I
Cyclohexanol	108930	I
Cyclohexanone	108941	I
Cyclohexylamine	108918	III
Cyclooctadienes	29965977	II
Decahydronaphthalene	91178	IV
Diacetoxy-2-Butene (1,4-)	0012	V
Diaminophenol hydrochloride	137097	V
Dibromomethane	74953	V
Dichloroaniline (mixed isomers)	27134276	I
Dichlorobenzene (p-)	106467	I
Dichlorobenzene (m-)	541731	I
Dichlorobenzene (o-)	95501	I
Dichlorobenzidine	91941	I
(3,3'-)		
Dichlorodifluoromethane	75718	I
Dichloroethane (1,2-) (Ethylenedichloride) (EDC)	107062	I
Dichloroethyl ether (bis(2-chloroethyl)ether)	111444	I
Dichloroethylene (1,2-)	540590	II
Dichlorophenol (2,4-)	120832	III
Dichloropropene (1,3-)	542756	II
Dichlorotetrafluoro-	1320372	V
ethane.		
Dichloro-1-butene (3,4-)	760236	II
Dichloro-2-butene (1,4-)	764410	V
Diethanolamine (2,2'-Iminodiethanol)	111422	I
Diethyl sulfate	64675	II
Diethylamine	109897	IV
Diethylaniline (2,6-)	579668	V
Diethylene glycol	111466	I
Diethylene glycol dibutyl ether	112732	I
Diethylene glycol diethyl ether	112367	I
Diethylene glycol dimethyl ether	111966	I
Diethylene glycol monobutyl ether acetate	124174	I
Diethylene glycol monobutyl ether	112345	I
Diethylene glycol monoethyl ether acetate	112152	I
Diethylene glycol monoethyl ether	111900	I
Diethylene glycol monohexyl ether	112594	V
Diethylene glycol monomethyl ether acetate	629389	V
Diethylene glycol monomethyl ether	111773	I

Dihydroxybenzoic acid (Resorcylic acid)	27138574	V
Dimethylbenzidine	119937	II
(3,3'-)		
Dimethyl ether	115106	IV
Dimethylformamide (N,N-)	68122	II
Dimethylhydrazine	57147	II
(1,1-)		
Dimethyl sulfate	77781	I
Dimethyl terephthalate	120616	II
Dimethylamine	124403	IV
Dimethylaminoethanol (2-)	108010	I
Dimethylaniline (N,N'')	121697	III
Dinitrobenzenes (NOS) ^c	25154545	I
Dinitrophenol (2,4-)	51285	III
Dinitrotoluene (2,4-)	121142	III
Dioxane (1,4-) (1,4-Diethyleneoxide)	1239	11I
Dioxolane (1,3-)	646060	I
Diphenyl methane	101815	I
Diphenyl oxide	101848	I
Diphenyl thiourea	102089	III
Diphenylamine	122394	III
Dipropylene glycol	110985	I
Di-o-tolyguanidine	97392	III
Dodecanedioic acid	693232	I
Dodecyl benzene (branched)	123013	V
Dodecyl phenol (branched)	121158585	V
Dodecylaniline	28675174	V
Dodecylbenzene (n-)	121013	I
Dodecylphenol	27193868	III
Epichlorohydrin (1-chloro-2,3-epoxypropane)	106898	I
Ethanolamine	141435	I
Ethyl acrylate	140885	II
Ethylbenzene	100414	I
Ethyl chloride (Chloroethane)	75003	IV
Ethyl chloroacetate	105395	II
Ethylamine	75047	V
Ethylaniline (N-)	103695	III
Ethylaniline (o-)	578541	III
Ethylcellulose	9004573	V
Ethylcyanoacetate	105566	V

Ethylene carbonate	96491	I
Ethylene dibromide (Dibromoethane)	106934	I
Ethylene glycol	107211	I
Ethylene glycol diacetate	111557	I
Ethylene glycol dibutyl ether	112481	V
Ethylene glycol diethyl ether (1,2-diethoxyethane).	629141	I
Ethylene glycol dimethyl ether	110714	I
Ethylene glycol monoacetate	542596	V
Ethylene glycol monobutyl ether acetate.	112072	I
Ethylene glycol monobutyl ether	111762	I
Ethylene glycol monoethyl ether acetate.	111159	I
Ethylene glycol monoethyl ether	110805	I
Ethylene glycol monohexyl ether	112254	V
Ethylene glycol monomethyl ether acetate	110496	I
Ethylene glycol monomethyl ether	109864	I
Ethylene glycol monoethyl ether	002	V
Ethylene glycol monophenyl ether	122996	I
Ethylene glycol monopropyl ether	2807309	I
Ethylene oxide	75218	I
Ethylenediamine	107153	II
Ethylenediamine tetraacetic acid	60004	V
Ethylenimine (Aziridine)	151564	II
Ethylhexyl acrylate (2-isomer)	103117	II
Fluoranthene	206440	V
Formaldehyde	50000	I
Formamide	75127	II
Formic acid	64186	II
Fumaric acid	110178	I
Glutaraldehyde	111308	IV
Glyceraldehyde	367475	V
Glycerol	56815	II
Glycine	56406	II
Glyoxal	107222	II
Hexachlorobenzene	118741	II
Hexachlorobutadiene	87683	II
Hexachloroethane	67721	II

Hexadiene (1,4-)	592450	II
Hexamethylene-	100970	I
tetramine.		
Hexane	110543	V
Hexanetriol (1,2,6-)	106694	IV
Hydroquinone	123319	I
Hydroxyadipaldehyde	141311	V
Isobutyl acrylate	106638	V
Isobutylene	115117	V
Isophorone	78591	IV
Isophorone nitrile	0017	V
Isophthalic acid	121915	III
Isopropylphenol	25168063	III
Linear alkylbenzene	__ d	I
Maleic anhydride	108316	I
Maleic hydrazide	123331	I
Malic acid	6915157	I
Metanilic acid	121471	I
Methacrylic acid	79414	V
Methanol	67561	IV
Methionine	63683	I
Methyl acetate	79209	IV
Methyl acrylate	96333	V
Methyl bromide (Bromomethane)	74839	IV
Methyl chloride (Chloromethane)	74873	IV
Methyl ethyl ketone (2-butanone)	78933	V
Methyl formate	107313	II
Methyl hydrazine	60344	IV
Methyl isobutyl carbinol	108112	IV
Methyl isobutyl ketone (Hexone)	108101	IV
Methyl isocyanate	624839	IV
Methyl mercaptan	74931	IV
Methyl methacrylate	80626	IV
Methyl phenyl carbinol	98851	II
Methyl tert-butyl ether	1634044	V
Methylamine	74895	IV
Methylaniline (N-)	100618	III
Methylcyclohexane	108872	III
Methylcyclohexanol	25639423	V
Methylcyclohexanone	1331222	III

Methylene chloride (Dichloromethane)	75092	I
Methylene dianiline (4,4'-isomer)	101779	I
Methylene diphenyl diisocyanate (4,4'-) (MDI)	101688	III
Methylionones (a-)	79696	V
Methylpentynol	77758	V
Methylstyrene (a-)	98839	I
Naphthalene	91203	IV
Naphthalene sulfonic acid (a-)	85472	IV
Naphthalene sulfonic acid (b-)	120183	IV
Naphthol (a-)	90153	IV
Naphthol (b-)	135193	IV
Naphtholsulfonic acid (1-)	567180	V
Naphthylamine sulfonic acid (1,4-)	84866	V
Naphthylamine sulfonic acid (2,1-)	81163	V
Naphthylamine (1-)	134327	V
Naphthylamine (2-)	91598	V
Nitroaniline (m-)	99092	II
Nitroaniline (o-)	88744	I
Nitroanisole (o-)	91236	III
Nitroanisole (p-)	100174	III
Nitrobenzene	98953	I
Nitronaphthalene (1-)	86577	IV
Nitrophenol (p-)	100027	III
Nitrophenol (o-)	88755	III
Nitropropane (2-)	79469	II
Nitrotoluene (all isomers)	1321126	III
Nitrotoluene (o-)	88722	III
Nitrotoluene (m-)	99081	III
Nitrotoluene (p-)	99990	III
Nitroxylene	25168041	V
Nonylbenzene (branched)	1081772	V
Nonylphenol	25154523	V
Octene-1	111660	I
Octylphenol	27193288	III
Paraformaldehyde	30525894	I
Paraldehyde	123637	II
Pentachlorophenol	87865	III
Pentaerythritol	115775	I
Peracetic acid	79210	II
Perchloromethyl mercaptan	594423	IV

Phenanthrene	85018	V
Phenetidine (p-)	156434	III
Phenol	108952	III
Phenolphthalein	77098	III
Phenolsulfonic acids (all isomers)	1333397	III
Phenyl anthranilic acid (all isomers)	91407	III
Phenylenediamine (p-)	106503	I
Phloroglucinol	108736	III
Phosgene	75445	IV
Phthalic acid	88993	III
Phthalic anhydride	85449	III
Phthalimide	85416	III
Phthalonitrile	91156	III
Picoline (b-)	108996	II
Piperazine	110850	I
Propiolactone (beta-)	57578	I
Propionaldehyde	123386	IV
Propionic acid	79094	I
Propylene carbonate	108327	V
Propylene dichloride (1,2-dichloropropane)	78875	IV
Propylene glycol	57556	I
Propylene glycol monomethyl ether	107982	I
Propylene oxide	75569	I
Pyrene	129000	V
Pyridine	110861	II
p-tert-Butyl toluene	98511	III
Quinone	106514	III
Resorcinol	108463	I
Salicylic acid	69727	III
Sodium methoxide	124414	IV
Sodium phenate	139026	III
Stilbene	588590	III
Styrene	100425	I
Succinic acid	110156	I
Succinonitrile	110612	I
Sulfanilic acid	121573	III
Sulfolane	126330	II
Tartaric acid	526830	I
Terephthalic acid	100210	II
Tetrabromophthalic anhydride	632791	III

Tetrachlorobenzene (1,2,4,5-)	95943	I
Tetrachloroethane (1,1,2,2-)	79345	II
Tetrachloroethylene (Perchloroethylene)	127184	I
Tetrachlorophthalic- anhydride.	117088	III
Tetraethyl lead	78002	IV
Tetraethylene glycol	112607	I
Tetraethylene- pentamine.	112572	V
Tetrahydrofuran	109999	I
Tetrahydronaphthalene	119642	IV
Tetrahydrophthalic anhydride	85438	II
Tetramethylene- diamine.	110601	II
Tetramethylethylenediamine	110189	V
Tetramethyllead	75741	V
Toluene	108883	I
Toluene 2,4 diamine	95807	II
Toluene 2,4 diisocyanate	584849	II
Toluene diisocyanates (mixture)	26471625	II
Toluene sulfonic acids	104154	III
Toluenesulfonyl chloride	98599	III
Toluidine (o-)	95534	II
Trichloroaniline- (2,4,6-).	634935	III
Trichlorobenzene (1,2,3-)	87616	V
Trichlorobenzene (1,2,4-)	120821	I
Trichloroethane (1,1,1-)	71556	II
Trichloroethane (1,1,2-) (Vinyl trichloride)	79005	II
Trichloroethylene	79016	I
Trichlorofluoromethane	75694	I
Trichlorophenol (2,4,5-).	95954	I
(1,1,2-) Trichloro (1,2,2-) trifluoroethane.	76131	I
Triethanolamine	102716	I
Triethylamine	121448	IV
Triethylene glycol	112276	I
Triethylene glycol	112492	I

dimethyl ether.		
Triethylene glycol monoethyl ether	112505	V
Triethylene glycol monomethyl ether	112356	I
Trimethylamine	75503	IV
Trimethylcyclohexanol	933482	IV
Trimethylcyclo-	2408379	IV
hexanone.		
Trimethylcyclo-	34216347	V
hexylamine.		
Trimethylolpropane	77996	I
Trimethylpentane (2,2,4-)	540841	V
Tripropylene glycol	24800440	V
Vinyl acetate	108054	II
Vinyl chloride (Chloroethylene)	75014	I
Vinyl toluene	25013154	III
Vinylcyclohexene (4-)	100403	II
Vinylidene chloride	75354	II
(1,1-dichloroethylene).		
Vinyl(N-)-pyrrolidone(2-)	88120	V
Xanthates	140896	V
Xylene sulfonic acid	25321419	III
Xylenes (NOS) ^c	1330207	I
Xylene (m-)	108383	I
Xylene (o-)	95476	I
Xylene (p-)	106423	I
Xylenols (Mixed)	1300716	V
Xylidene	1300738	III

^aIsomer means all structural arrangements for the same number of atoms of each element and does not mean salts, esters, or derivatives.

^bCAS Number = Chemical Abstract Service number.

^cNOS = not otherwise specified.

^dNo CAS number assigned.

[59 FR 19454, Apr. 22, 1994, as amended at 59 FR 48176, Sept. 20, 1994; 61 FR 31439, June 20, 1996; 63 FR 26082, May 12, 1998]

Table 2 to Subpart F of Part 63—Organic Hazardous Air Pollutants

Chemical name ^{a, b}	CAS No. ^c

Acenaphthene	83329
Acetaldehyde	75070
Acetamide	60355
Acetonitrile	75058
Acetophenone	98862
Acrolein	107028
Acrylamide	79061
Acrylic acid	79107
Acrylonitrile	107131
Alizarin	72480
Allyl chloride	107051
Aniline	62533
Anisidine (o-)	90040
Anthracene	120127
Anthraquinone	84651
Benzene	71432
Benzotrichloride	98077
Benzyl chloride	100447
Biphenyl	92524
Bis(chloromethyl)ether	542881
Bromoform	75252
Bromonaphthalene	27497514
Butadiene (1,3-)	106990
Carbon disulfide	75150
Carbon tetrachloride	56235
Chloroacetic acid	79118
Chloroacetophenone (2-)	532274
Chlorobenzene	108907
2-Chloro-,1,3-butadiene (Chloroprene)	126998
Chloroform	67663
Chloronaphthalene	25586430
Chrysene	218019
Cresols and cresylic acids (mixed)	1319773
Cresol and cresylic acid (o-)	95487
Cresol and cresylic acid (m-)	108394
Cresol and cresylic acid (p-)	106445
Cumene	98828
Dichlorobenzene (p-)	106467
Dichlorobenzidine (3,3'-)	91941
Dichloroethane (1,2-) (Ethylene dichloride) (EDC)	107062

Dichloroethylether (Bis(2-chloroethyl)ether)	111444
Dichloropropene (1,3-)	542756
Diethanolamine (2,2"-Iminodiethanol)	111422
Dimethylaniline (N,N-)	121697
Diethyl sulfate	64675
Dimethylbenzidine (3,3"-)	119937
Dimethylformamide (N,N-)	68122
Dimethylhydrazine (1,1-)	58147
Dimethylphthalate	131113
Dimethylsulfate	77781
Dinitrophenol (2,4-)	51285
Dinitrotoluene (2,4-)	121142
Dioxane (1,4-) (1,4-Diethyleneoxide)	123911
1,2-Diphenylhydrazine	122667
Epichlorohydrin (1-Chloro-2,3-epoxypropane)	106898
Ethyl acrylate	140885
Ethylbenzene	100414
Ethyl chloride (Chloroethane)	75003
Ethylene dibromide (Dibromoethane)	106934
Ethylene glycol	107211
Ethylene oxide	75218
Ethylidene dichloride (1,1-Dichloroethane)	75343
Fluoranthene	206440
Formaldehyde	50000
Glycol ethers ^d	
Hexachlorobenzene	118741
Hexachlorobutadiene	87683
Hexachloroethane	67721
Hexane	110543
Hydroquinone	123319
Isophorone	78591
Maleic anhydride	108316
Methanol	67561
Methylbromide (Bromomethane)	74839
Methylchloride (Chloromethane)	74873
Methyl hydrazine	60344
Methyl isobutyl ketone (Hexone)	108101
Methyl isocyanate	624839
Methyl methacrylate	80626
Methyl tert-butyl ether	1634044

Methylene chloride (Dichloromethane)	75092
Methylene diphenyl diisocyanate (4,4"-) (MDI)	101688
Methylenedianiline (4,4"-)	101779
Naphthalene	91203
Naphthalene sulfonic acid (α)	85472
Naphthalene sulfonic acid (β)	120183
Naphthol (α)	90153
Naphthol (β)	135193
Naphtholsulfonic acid (1-)	567180
Naphthylamine sulfonic acid (1,4-)	84866
Naphthylamine sulfonic acid (2,1-)	81163
Naphthylamine (1-)	134327
Naphthylamine (2-)	91598
Nitronaphthalene (1-)	86577
Nitrobenzene	98953
Nitrophenol (p-)	100027
Nitropropane (2-)	79469
Phenanthrene	85018
Phenol	108952
Phenylenediamine (p-)	106503
Phosgene	75445
Phthalic anhydride	85449
Propiolactone (beta-)	57578
Propionaldehyde	123386
Propylene dichloride (1,2-Dichloropropane)	78875
Propylene oxide	75569
Pyrene	129000
Quinone	106514
Styrene	100425
Tetrachloroethane (1,1,2,2-)	79345
Tetrachloroethylene (Perchloroethylene)	127184
Tetrahydronaphthalene	119642
Toluene	108883
Toluene diamine (2,4-)	95807
Toluene diisocyanate (2,4-)	584849
Toluidine (o-)	95534
Trichlorobenzene (1,2,4-)	120821
Trichloroethane (1,1,1-) (Methyl chloroform)	71556
Trichloroethane (1,1,2-) (Vinyl trichloride)	79005
Trichloroethylene	79016

Trichlorophenol (2,4,5-)	95954
Triethylamine	121448
Trimethylpentane (2,2,4-)	540841
Vinyl acetate	108054
Vinyl chloride (Chloroethylene)	75014
Vinylidene chloride (1,1-Dichloroethylene)	75354
Xylenes (NOS)	1330207
Xylene (m-)	108383
Xylene (o-)	95476
Xylene (p-)	106423

^aFor all Listings above containing the word "Compounds," the following applies: Unless otherwise specified, these listings are defined as including any unique chemical substance that contains the named chemical (i.e., antimony, arsenic) as part of that chemical's infrastructure.

^bIsomer means all structural arrangements for the same number of atoms of each element and does not mean salts, esters, or derivatives.

^cCAS No.=Chemical Abstract Service number.

^dIncludes mono- and di- ethers of ethylene glycol, diethylene glycol, and triethylene glycol R-(OCH₂CH_{2n}-OR where:

n=1, 2, or 3;

R=alkyl or aryl groups; and

R''=R, H or groups which, when removed, yield glycol ethers with the structure:

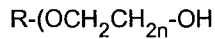

Polymers are excluded from the glycol category.

[62 FR 2735, Jan. 17, 1997, as amended at 71 FR 76614, Dec. 21, 2006]

Table 3 to Subpart F of Part 63—General Provisions Applicability to Subparts F, G, and H^a to Subpart F

Reference	Applies to subparts F, G, and H	Comment
63.1(a)(1)	Yes	Overlap clarified in §63.101, §63.111, §63.161.
63.1(a)(2)	Yes	
63.1(a)(3)	Yes	§63.110 and §63.160(b) of subparts G and H identify which standards are overridden.
63.1(a)(4)	No	Subpart F specifies applicability of each paragraph in subpart A to subparts F, G, and H.
63.1 (a)(5)—	No	

(a)(9)		
63.1(a)(10)	No	Subparts F, G, and H specify calendar or operating day.
63.1(a)(11)	No	Subpart F §63.103(d) specifies acceptable methods for submitting reports. ^a
63.1 (a) (12)—(a) (14)	Yes	
63.1(b)(1)	No	Subpart F specifies applicability.
63.1(b)(2)	Yes	
63.1(b)(3)	No	
63.1(c)(1)	No	Subpart F specifies applicability.
63.1(c)(2)	No	Area sources are not subject to subparts F, G, and H.
63.1(c)(3)	No	
63.1(c)(4)	Yes	
63.1(c)(5)	No	Subparts G and H specify applicable notification requirements.
63.1(d)	No	
63.1(e)	No	Subparts F, G, and H established before permit program.
63.2	Yes	Subpart F §63.101(a) specifies those subpart A definitions that apply to the HON. Subpart F definition of "source" is equivalent to subpart A definition of "affected source."
63.3	No	Units of measure are spelled out in subparts F, G, and H.
63.4 (a)(1)— (a)(3)	Yes	
63.4(a)(4)	No	This is a reserved paragraph in subpart A of part 63.
63.4(a)(5)	Yes	
63.4(b)	Yes	
63.4(c)	Yes	
63.5(a)(1)	Yes	Except the terms "source" and "stationary source" in §63.5(a)(1) should be interpreted as having the same meaning as "affected source."
63.5(a)(2)	Yes	
63.5(b)(1)	Yes	Except §63.100(l) defines when construction or reconstruction is subject to standards for new sources.
63.5(b)(2)	No	This is a reserved paragraph in subpart A of part 63.
63.5(b)(3)	Yes	

63.5(b)(4)	Yes	Except the cross reference to §63.9(b) is limited to §63.9(b) (4) and (5). Subpart F overrides §63.9 (b) (1) through (b)(3).
63.5(b)(5)	Yes	
63.5(b)(6)	Yes	Except §63.100(l) defines when construction or reconstruction is subject to standards for new sources.
63.5(c)	No	This is a reserved paragraph in subpart A of part 63.
63.5(d)(1)(i)	No	For subpart G, see §63.151(b) (2)(ii) and (2)(iii) for the applicability and timing of this submittal; for subpart H, see §63.182(b) (2)(ii) and (b)(2)(iii) for applicability and timing of this submittal.
63.5(d)(1)(ii)	Yes	Except §63.5(d)(1)(ii)(H) does not apply.
63.5(d)(1)(iii)	No	Subpart G requires submittal of the Notification of Compliance Status in §63.152(b); subpart H specifies requirements in §63.182(c).
63.5(d)(2)	No	
63.5(d)(3)	Yes— subpart G No— subpart H	Except §63.5(d)(3)(ii) does not apply to subpart G.
63.5(d)(4)	Yes	
63.5(e)	Yes	
63.5(f)(1)	Yes	
63.5(f)(2)	Yes	Except the cross-reference to §63.5(d)(1) is changed to §63.151(b)(2)(ii) of subpart G and to §63.182(b)(2)(ii) of subpart H. The cross-reference to §63.5(b)(2) does not apply.
63.6(a)	Yes	
63.6(b)(1)	No	Subparts F and H specify compliance dates for sources subject to subparts F, G, and H.
63.6(b)(2)	No	
63.6(b)(3)	Yes	
63.6(b)(4)	No	May apply when standards are proposed under Section 112(f) of the Clean Air Act.
63.6(b)(5)	No	Subparts G and H include notification requirements.
63.6(b)(6)	No	
63.6(b)(7)	No	
63.6(c)(1)	No	Subpart F specifies the compliance dates for subparts G and H.
63.6(c)(2)	No	
63.6(c)(3)	No	

63.6(c)(4)	No	
63.6(c)(5)	Yes	
63.6(d)	No	
63.6(e)	Yes	Except as otherwise specified for individual paragraphs. Does not apply to Group 2 emission points unless they are included in an emissions average. ^b
63.6(e)(1)(i)	No	This is addressed by §63.102(a)(4) of subpart F.
63.6(e)(1)(ii)	Yes	
63.6(e)(1)(iii)	Yes	
63.6(e)(2)	Yes	
63.6(e)(3)(i)	Yes	For subpart H, the startup, shutdown, and malfunction plan requirement of §63.6(e)(3)(i) is limited to control devices subject to the provisions of subpart H and is optional for other equipment subject to subpart H. The startup, shutdown, and malfunction plan may include written procedures that identify conditions that justify a delay of repair.
63.6(e)(3)(i)(A)	No	This is addressed by §63.102(a)(4).
63.6(e)(3)(i)(B)	Yes	
63.6(e)(3)(i)(C)	Yes	
63.6(e)(3)(ii)	Yes	
63.6(e)(3)(iii)	No	Recordkeeping and reporting are specified in §63.103(c)(2) of subpart F and §63.152(d)(1) of subpart G.
63.6(e)(3)(iv)	No	Recordkeeping and reporting are specified in §63.103(c)(2) of subpart F and §63.152(d)(1) of subpart G.
63.6(e)(3)(v)	No	Records retention requirements are specified in §63.103(c).
63.6(e)(3)(vi)	Yes	
63.6(e)(3)(vii)	Yes	
63.6(e)(3)(vii)(A)	Yes	
63.6(e)(3)(vii)(B)	Yes	Except the plan must provide for operation in compliance with §63.102(a)(4).
63.6(e)(3)(vii)(C)	Yes	
63.6(e)(3)	Yes	

(viii)		
63.6(e)(3) (ix)	Yes	
63.6(f)(1)	No	§63.102(a) of subpart F specifies when the standards apply.
63.6(f)(2)(i)	Yes	
63.6(f)(2)(ii)	Yes— subpart G No— subpart H	§63.152(c)(2) of subpart G specifies the use of monitoring data in determining compliance with subpart G.
63.6(f)(2)(iii) (A), (B), and (C)	Yes	
63.6(f)(2)(iii) (D)	No	
63.6(f)(2)(iv)	Yes	
63.6(f)(2)(v)	Yes	
63.6(f)(3)	Yes	
63.6(g)	No	Procedures specified in §63.102(b) of subpart F.
63.6(h)	No	
63.6(i)(1)	Yes	
63.6(i)(2)	Yes	
63.6(i)(3)	No	For subpart G, §63.151(a)(6) specifies procedures; for subpart H, §63.182(a)(6) specifies procedures.
63.6(i)(4)(i) (A)	Yes	
63.6(i)(4)(i) (B)	No	Dates are specified in §63.151(a)(6)(i) of subpart G and §63.182(a)(6)(i) of subpart H.
63.6(i)(4)(ii)	No	
63.6(i)(5)— (14)	Yes	
63.6(i)(15)	No	
63.6(i)(16)	Yes	
63.6(j)	Yes	
63.7(a)(1)	No	Subparts F, G, and H specify required testing and compliance demonstration procedures.
63.7(a)(2)	No	For subpart G, test results must be submitted in the Notification of Compliance Status due 150 days after compliance date, as specified in §63.152(b); for subpart H, all test results subject to reporting are reported in periodic reports.
63.7(a)(3)	Yes	
63.7(b)	No	
63.7(c)	No	

63.7(d)	Yes	
63.7(e)(1)	Yes	
63.7(e)(2)	Yes	
63.7(e)(3)	No	Subparts F, G, and H specify test methods and procedures.
63.7(e)(4)	Yes	
63.7(f)	No	Subparts F, G, and H specify applicable methods and provide alternatives.
63.7(g)	No	Performance test reporting specified in §63.152(b) of subpart G: Not applicable to subpart H because no performance test required by subpart H.
63.7(h)(1)	Yes	
63.7(h)(2)	Yes	
63.7(h)(3)	No	§63.103(b)(5) of subpart F specifies provisions for requests to waive performance tests.
63.7(h)(4)	No	
63.7(h)(5)	Yes	
63.8(a)(1)	Yes	
63.8(a)(2)	No	
63.8(a)(3)	No	
63.8(a)(4)	Yes	
63.8(b)(1)	Yes	
63.8(b)(2)	No	Subparts G and H specify locations to conduct monitoring.
63.8(b)(3)	Yes	
63.8(c)(1)(i)	Yes	
63.8(c)(1)(ii)	No	For subpart G, submit as part of periodic report required by §63.152(c); for subpart H, retain as required by §63.181(g)(2)(ii).
63.8(c)(1)(iii)	Yes	
63.8(c)(2)	Yes	
63.8(c)(3)	Yes	
63.8(c)(4)	No	Subpart G specifies monitoring frequency by kind of emission point and control technology used (e.g., §63.111, §63.120(d)(2), §63.143, and §63.152(f)); subpart H does not require use of continuous monitoring systems.
63.8(c)(5)– (c)(8)	No	
63.8(d)	No	
63.8(e)	No	
63.8(f)(1)– (f)(3)	Yes	

63.8(f)(4)(i)	No	Timeframe for submitting request specified in §63.151(f) or (g) of subpart G; not applicable to subpart H because subpart H specifies acceptable alternative methods.
63.8(f)(4)(ii)	Yes	
63.8(f)(4)(iii)	No	
63.8(f)(5)(i)	Yes	
63.8(f)(5)(ii)	No	
63.8(f)(5)(iii)	Yes	
63.8(f)(6)	No	Subparts G and H do not require continuous emission monitoring.
63.8(g)	No	Data reduction procedures specified in §63.152(f) and (g) of subpart G; not applicable to subpart H.
63.9(a)	Yes	
63.9(b)(1)	No	Specified in §63.151(b)(2) of subpart G; specified in §63.182(b) of subpart H.
63.9(b)(2)	No	Initial Notification provisions are specified in §63.151(b) of subpart G; in §63.182(b) of subpart H.
63.9(b)(3)	No	
63.9(b)(4)	Yes	Except that the notification in §63.9(b)(4)(i) shall be submitted at the time specified in §63.151(b)(2)(ii) of subpart G; in §63.182(b)(2) of subpart H.
63.9(b)(5)	Yes	Except that the notification in §63.9(b)(5) shall be submitted at the time specified in §63.151(b)(2)(ii) of subpart G; in §63.182 (b)(2) of subpart H.
63.9(c)	Yes	
63.9(d)	Yes	
63.9(e)	No	
63.9(f)	No	
63.9(g)	No	
63.9(h)	No	§63.152(b) of subpart G and §63.182 (c) of subpart H specify Notification of Compliance Status requirements.
63.9(i)	Yes	
63.9(j)	No	
63.10(a)	Yes	
63.10(b)(1)	No	§63.103(c) of subpart F specifies record retention requirements.
63.10(b)(2)	No	§63.103(c) of subpart F specifies required records.
63.10(b)(3)	No	
63.10(c)	No	
63.10(d)(1)	No	

63.10(d)(2)	No	§63.152(b) of subpart G specifies performance test reporting; not applicable to subpart H.
63.10(d)(3)	No	
63.10(d)(4)	Yes	
63.10(d)(5)	Yes	Except that reports required by §63.10(d)(5) shall be submitted at the time specified in §63.152(d) of subpart G and in §63.182(d) of subpart H.
63.10(e)	No	
63.10(f)	Yes	
63.11–63.15	Yes	

^aWherever subpart A specifies “postmark” dates, submittals may be sent by methods other than the U.S. Mail (e.g., by fax or courier). Submittals shall be sent by the specified dates, but a postmark is not necessarily required.

^bThe plan, and any records or reports of start-up, shutdown, and malfunction do not apply to Group 2 emission points unless they are included in an emissions average.

[62 FR 2737, Jan. 17, 1997, as amended at 71 FR 20456, Apr. 20, 2006]

Table 4 to Subpart F of Part 63—Organic Hazardous Air Pollutants Subject to Cooling Tower Monitoring Requirements in §63.104

Chemical name	CAS Number ^a
Acetaldehyde	75070
Acetonitrile	75058
Acetophenone	98862
Acrolein	107028
Acrylonitrile	107131
Allyl chloride	107051
Aniline	62533
Anisidine (o-)	90040
Benzene	71432
Benzyl chloride	100447
Biphenyl	92524
Bromoform	75252
Butadiene (1,3-)	106990
Carbon disulfide	75150
Carbon tetrachloride	56235
Chloroacetophenone (2-)	532274
Chlorobenzene	108907
2-Chloro-1,3-butadiene (Chloroprene)	126998
Chloroform	67663

Cresol and cresylic acid (o-)	95487
Cresol and cresylic acid (m-)	108394
Cresol and cresylic acid (p-)	106445
Cumene	98828
Dichlorobenzene (p-)	106467
Dichlorobenzidine (3,3"-)	91941
Dichloroethane (1,2-) (Ethylene dichloride) (EDC)	107062
Dichloroethyl ether (Bis(2-chloroethyl)ether)	111444
Dichloropropene (1,3-)	542756
Diethylene glycol diethyl ether	112367
Diethylene glycol dimethyl ether	111966
Diethyl sulfate	64675
Dimethylaniline (N,N-)	121697
Dimethylhydrazine (1,1-)	57147
Dimethyl phthalate	131113
Dimethyl sulfate	77781
Dinitrophenol (2,4-)	51285
Dinitrotoluene (2,4-)	121142
Dioxane (1,4-) (1,4-Diethyleneoxide)	123911
Epichlorohydrin (1-Chloro-2,3-epoxypropane)	106898
Ethyl acrylate	140885
Ethylbenzene	100414
Ethyl chloride (Chloroethane)	75003
Ethylene dibromide (Dibromoethane)	106934
Ethylene glycol dimethyl ether	110714
Ethylene glycol monobutyl ether	111762
Ethylene glycol monobutyl ether acetate	112072
Ethylene glycol monoethyl ether acetate	111159
Ethylene glycol monoethyl ether	110805
Ethylene glycol monomethyl ether	109864
Ethylene glycol monomethyl ether acetate	110496
Ethylene glycol monopropyl ether	2807309
Ethylene oxide	75218
Ethylidene dichloride (1,1-Dichloroethane)	75343
Formaldehyde	50000
Hexachlorobenzene	118741
Hexachlorobutadiene	87683
Hexachloroethane	67721
Hexane	110543
Isophorone	78591

Methanol	67561
Methyl bromide (Bromomethane)	74839
Methyl chloride (Chloromethane)	74873
Methyl hydrazine	60344
Methyl isobutyl ketone (Hexone)	108101
Methyl methacrylate	80626
Methyl tert-butyl ether	1634044
Methylene chloride (Dichloromethane)	75092
Methylenedianiline (4,4"-)	101779
Naphthalene	91203
Nitrobenzene	98953
Nitropropane (2-)	79469
Phenol	108952
Phenylenediamine (p-)	106503
Phosgene	75445
Propionaldehyde	123386
Propylene dichloride (1,2-Dichloropropane)	78875
Propylene oxide	75569
Quinone	106514
Styrene	100425
Tetrachloroethane (1,1,2,2-)	79345
Tetrachloroethylene (Perchloroethylene)	127184
Toluene	108883
Toluidine (o-)	95534
Trichlorobenzene (1,2,4-)	120821
Trichloroethane (1,1,1-) (Methyl chloroform)	71556
Trichloroethane (1,1,2-) (Vinyl trichloride)	79005
Trichloroethylene	79016
Trichlorophenol (2,4,5-)	95954
Triethylamine	121448
Trimethylpentane (2,2,4-)	540841
Vinyl acetate	108054
Vinyl chloride (chloroethylene)	75014
Vinylidene chloride (1,1-Dichloroethylene)	75354
Xylene (m-)	108383
Xylene (o-)	95476
Xylene (p-)	106423

^aCAS Number=Chemical Abstract Service number.

[62 FR 2740, Jan. 17, 1997, as amended at 71 FR 76614, Dec. 21, 2006]

[Browse Previous](#) | [Browse Next](#)

For questions or comments regarding e-CFR editorial content, features, or design, email ecfr@nara.gov.

For questions concerning e-CFR programming and delivery issues, email webteam@gpo.gov.

[Section 508 / Accessibility](#)

[Home Page](#) > [Executive Branch](#) > [Code of Federal Regulations](#) > [Electronic Code of Federal Regulations](#)

Electronic Code of Federal Regulations

e-CFR

TM

e-CFR Data is current as of August 1, 2007

Title 40: Protection of Environment

PART 63—NATIONAL EMISSION STANDARDS FOR HAZARDOUS AIR POLLUTANTS FOR SOURCE CATEGORIES

[Browse Previous](#) | [Browse Next](#)

Subpart G—National Emission Standards for Organic Hazardous Air Pollutants From the Synthetic Organic Chemical Manufacturing Industry for Process Vents, Storage Vessels, Transfer Operations, and Wastewater

Source: 59 FR 19468, Apr. 22, 1994, unless otherwise noted.

§ 63.110 Applicability.

(a) This subpart applies to all process vents, storage vessels, transfer racks, wastewater streams, and in-process equipment subject to §63.149 within a source subject to subpart F of this part.

(b) *Overlap with other regulations for storage vessels.* (1) After the compliance dates specified in §63.100 of subpart F of this part, a Group 1 or Group 2 storage vessel that is also subject to the provisions of 40 CFR part 60, subpart Kb is required to comply only with the provisions of this subpart.

(2) After the compliance dates specified in §63.100 of subpart F of this part, a Group 1 storage vessel that is also subject to the provisions of 40 CFR part 61, subpart Y is required to comply only with the provisions of this subpart.

(3) After the compliance dates specified in §63.100 of subpart F of this part, a Group 2 storage vessel that is also subject to the provisions of 40 CFR part 61, subpart Y is required to comply only with the provisions of 40 CFR part 61, subpart Y. The recordkeeping and reporting requirements of 40 CFR part 61, subpart Y will be accepted as compliance with the recordkeeping and reporting requirements of this subpart.

(c) *Overlap with other regulations for transfer racks.* (1) After the compliance dates specified in §63.100 of subpart F of this part, a Group 1 transfer rack that is also subject to the provisions of 40 CFR part 61, subpart BB is required to comply only with the provisions of this subpart.

(2) After the compliance dates specified in §63.100 of subpart F of this part, a Group 2 transfer rack that is also subject to the provisions of 40 CFR part 61, subpart BB is required to comply with the provisions of either paragraph (c)(2)(i) or (c)(2)(ii) of this subpart.

(i) If the transfer rack is subject to the control requirements specified in §61.302 of 40 CFR part 61, subpart BB, then the transfer rack is required to comply with the control requirements of §61.302 of 40 CFR part 61, subpart BB. The owner or operator may elect to comply with either the associated testing, monitoring, reporting, and recordkeeping requirements of 40 CFR part 61, subpart BB or with the testing, monitoring, recordkeeping, and reporting requirements specified in this subpart for Group 1 transfer racks. The owner or operator shall indicate this decision in either the Notification of Compliance Status specified in §63.152(b) of this subpart or in an operating permit application or amendment.

(ii) If the transfer rack is subject only to reporting and recordkeeping requirements under 40 CFR part 61, subpart BB, then the transfer rack is required to comply only with the reporting and recordkeeping requirements specified in this subpart for Group 2 transfer racks and is exempt from the reporting and recordkeeping requirements in 40 CFR part 61, subpart BB.

(d) *Overlap with other regulations for process vents.* (1) After the compliance dates specified in §63.100 of subpart F of this part, a Group 1 process vent that is also subject to the provisions of 40 CFR part 60, subpart III is required to comply only with the provisions of this subpart.

(2) After the compliance dates specified in §63.100 of subpart F of this part, the owner or operator of a Group 2 process vent that is also subject to the provisions of 40 CFR part 60, subpart III shall determine requirements according to paragraphs (d)(2)(i) and (d)(2)(ii) of this section.

(i) If the Group 2 process vent has a TRE value less than 1 as determined by the procedures in 40 CFR part 60, subpart III, the process vent is required to comply with the provisions in paragraphs (d)(2)(i)(A) through (d)(2)(i)(C) of this section.

(A) The provisions in both this subpart and in 40 CFR part 60, subpart III for applicability determination and the associated recordkeeping and reporting;

(B) The provisions in both this subpart and in 40 CFR part 60, subpart III for process changes and recalculation of the TRE index value and the associated recordkeeping and reporting; and

(C) The control requirements in §60.612 of 40 CFR part 60, subpart III. The owner or operator may elect to comply with either the associated testing, monitoring, reporting, and recordkeeping requirements of 40 CFR part 60, subpart III or with the testing, monitoring, reporting, and recordkeeping requirements specified in this subpart for Group 1 process vents. The owner or operator shall indicate this decision in either the Notification of Compliance Status specified in §63.152(b) of this subpart or in an operating permit application or amendment.

(ii) If the Group 2 process vent has a TRE value greater than or equal to 1 as determined by the procedures in 40 CFR part 60, subpart III, the process vent is required to comply only with the provisions specified in paragraphs (d)(2)(ii)(A) through (d)(2)(ii)(D) of this section.

(A) The provisions in both this subpart and in 40 CFR part 60, subpart III for applicability determination and the associated recordkeeping and reporting;

(B) The provisions in both this subpart and in 40 CFR part 60, subpart III for process changes and recalculation of the TRE index value and the associated recordkeeping and reporting;

(C) If the provisions of both this subpart and 40 CFR part 60, subpart III require continuous monitoring of recovery device operating parameters, the process vent is required to comply only with the provisions that are specified in this subpart for continuous monitoring of recovery device operating parameters and the associated testing, reporting, and recordkeeping.

(D) If only the provisions of 40 CFR part 60, subpart III require continuous monitoring of recovery device operating parameters, the process vent is required to comply only with the provisions that are specified in 40 CFR part 60, subpart III for continuous monitoring of recovery device operating parameters and the associated testing, reporting, and recordkeeping.

(3) After the compliance dates specified in 63.100 of subpart F of this part, if an owner or operator of a process vent subject to this subpart that is also subject to the provisions of 40 CFR part 60, subpart III elects to control the process vent to the levels required in §63.113 (a)(1) or (a)(2) of this subpart without calculating the TRE index value for the vent according to the procedures specified in §63.115(d) of this subpart then the owner or operator shall comply with the testing, monitoring, reporting, and recordkeeping provisions of this subpart and shall be exempt from the testing, monitoring, reporting, and recordkeeping provisions of 40 CFR part 60, subpart III.

(4) After the compliance dates specified in §63.100 of subpart F of this part, a Group 1 process vent that is also subject to the provisions of 40 CFR part 60, subpart NNN is required to comply only with the provisions of this subpart.

(5) After the compliance dates specified in §63.100 of subpart F of this part, the owner or operator of a Group 2 process vent that is also subject to the provisions of 40 CFR part 60, subpart NNN shall determine requirements according to paragraphs (d)(5)(i) and (d)(5)(ii) of this section.

(i) If the Group 2 process vent has a TRE value less than 1 as determined by the procedures in 40 CFR part 60, subpart NNN, the process vent is required to comply with the provisions in paragraphs (d)(5)(i)(A) through (d)(5)(i)(C) of this section.

(A) The provisions in both this subpart and in 40 CFR part 60, subpart NNN for applicability determination and the associated recordkeeping and reporting;

(B) The provisions in both this subpart and in 40 CFR part 60, subpart NNN for process changes and recalculation of the TRE index value and the associated recordkeeping and reporting; and

(C) The control requirements in §60.662 of 40 CFR part 60, subpart NNN. The owner or operator may elect to comply with either the associated testing, monitoring, reporting, and recordkeeping requirements of 40 CFR part 60, subpart NNN or with the testing, monitoring, reporting, and recordkeeping requirements specified in this subpart for Group 1 process vents. The owner or operator shall indicate this decision in either the Notification of Compliance Status specified in §63.152(b) of this subpart or in an operating permit application or amendment.

(ii) If the Group 2 process vent has a TRE value greater than or equal to 1 as determined by the procedures in 40 CFR part 60, subpart NNN, the process vent is required to comply only with the provisions specified in paragraphs (d)(5)(ii)(A) through (d)(5)(ii)(D) of this section.

(A) The provisions in both this subpart and in 40 CFR part 60, subpart NNN for applicability determination and the associated recordkeeping and reporting;

(B) The provisions in both this subpart and in 40 CFR part 60, subpart NNN for process changes and recalculation of the TRE index value and the associated recordkeeping and reporting;

(C) If the provisions of both this subpart and 40 CFR part 60, subpart NNN require continuous monitoring of recovery device operating parameters, the process vent is required to comply only with the provisions that are specified in this subpart for continuous monitoring of recovery device operating parameters and the associated testing, reporting, and recordkeeping.

(D) If only the provisions of 40 CFR part 60, subpart NNN require continuous monitoring of recovery device operating parameters, the process vent is required to comply only with the provisions that are specified in 40 CFR part 60, subpart NNN for continuous monitoring of recovery device operating parameters and the associated testing, reporting, and recordkeeping.

(6) After the compliance dates specified in §63.100 of subpart F of this part, if an owner or operator of a process vent subject to this subpart that is also subject to the provisions of 40 CFR part 60, subpart NNN elects to control the process vent to the levels required in §63.113(a)(1) or (a)(2) of this subpart without calculating the TRE index value for the vent according to the procedures specified in §63.115(d) of this subpart then the owner or operator shall comply with the testing, monitoring, reporting, and recordkeeping provisions of this subpart and shall be exempt from the testing, monitoring, reporting, and recordkeeping provisions of 40 CFR part 60, subpart NNN.

(7) After the compliance dates specified in §63.100 of subpart F of this part, a Group 1 process vent that is also subject to the provisions of 40 CFR part 60, subpart RRR is required to comply only with the provisions of this subpart.

(8) After the compliance dates specified in §63.100 of subpart F of this part, the owner or operator of a Group 2 process vent that is also subject to the provisions of 40 CFR part 60, subpart RRR shall determine requirements according to paragraphs (d)(8)(i) and (d)(8)(ii) of this section.

(i) If the Group 2 process vent has a TRE value less than 1 as determined by the procedures in 40 CFR part 60, subpart RRR, the process vent is required to comply with the provisions in paragraphs (d)(8)(i)(A) through (d)(8)(i)(C) of this section.

(A) The provisions in both this subpart and in 40 CFR part 60, subpart RRR for applicability determination and the associated recordkeeping and reporting;

(B) The provisions in both this subpart and in 40 CFR part 60, subpart RRR for process changes and recalculation of the TRE index value and the associated recordkeeping and reporting; and

(C) The control requirements in §60.702 of 40 CFR part 60, subpart RRR. The owner or operator may elect to comply with either the associated testing, monitoring, reporting, and recordkeeping requirements of 40 CFR part 60, subpart RRR or with the testing, monitoring, reporting, and recordkeeping requirements specified in this subpart for Group 1 process vents. The owner or operator shall indicate this decision in either the Notification of Compliance Status specified in §63.152(b) of this subpart or in an operating permit application or amendment.

(ii) If the Group 2 process vent has a TRE value greater than or equal to 1 as determined by the procedures in 40 CFR part 60, subpart RRR, the process vent is required to comply only with the provisions specified in paragraphs (d)(8)(ii)(A) through (d)(8)(ii)(D) of this section.

(A) The provisions in both this subpart and in 40 CFR part 60, subpart RRR for applicability determination and the associated recordkeeping and reporting;

(B) The provisions in both this subpart and in 40 CFR part 60, subpart RRR for process changes and recalculation of the TRE index value and the associated recordkeeping and reporting;

(C) If the provisions of both this subpart and 40 CFR part 60, subpart RRR require continuous monitoring of recovery device operating parameters, the process vent is required to comply only with the provisions that are specified in this subpart for continuous monitoring of recovery device operating parameters and the associated testing, reporting, and recordkeeping.

(D) If only the provisions of 40 CFR part 60, subpart RRR require continuous monitoring of recovery device operating parameters, the process vent is required to comply only with the provisions that are specified in 40 CFR part 60, subpart RRR for continuous monitoring of recovery device operating parameters and the associated testing, reporting, and recordkeeping.

(9) After the compliance dates specified in §63.100 of subpart F of this part, if an owner or operator of a process vent subject to this subpart that is also subject to the provisions of 40 CFR part 60, subpart RRR elects to control the process vent to the levels required in §63.113(a)(1) or (a)(2) of this subpart without calculating the TRE index value for the vent according to the procedures specified in §63.115(d) of this subpart then the owner or operator shall comply with the testing, monitoring, reporting, and recordkeeping provisions of this subpart and shall be exempt from the testing, monitoring, reporting, and recordkeeping provisions of 40 CFR part 60, subpart RRR.

(10) As an alternative to the requirements of paragraphs (d)(2), (d)(3), (d)(5), (d)(6), (d)(8), and/or (d)(9) of this section as applicable, if a chemical manufacturing process unit has equipment subject to the provisions of this subpart and equipment subject to the provisions of 40 CFR part 60, subpart III, NNN, or RRR, the owner or operator may elect to apply this subpart to all such equipment in the chemical manufacturing process unit. If the owner or operator elects this method of compliance, all total organic compounds minus methane and ethane, in such equipment shall be considered for purposes of applicability and compliance with this subpart, as if they were organic hazardous air pollutants. Compliance with the provisions of this subpart, in the manner described in this paragraph, shall be deemed to constitute compliance with 40 CFR part 60, subpart III, NNN, or RRR, as applicable.

(e) *Overlap with other regulations for wastewater.* (1) After the compliance dates specified in §63.100 of subpart F of this part, the owner or operator of a Group 1 or Group 2 wastewater stream that is also subject to the provisions of 40 CFR part 61, subpart FF is required to comply with the provisions of both this subpart and 40 CFR part 61, subpart FF. Alternatively, the owner or operator may elect to comply with the provisions of paragraphs (e)(1)(i) and (e)(1)(ii) of this section, which shall constitute compliance with the provisions of 40 CFR part 61, subpart FF.

(i) Comply with the provisions of this subpart; and

(ii) For any Group 2 wastewater stream or organic stream whose benzene emissions are subject to

control through the use of one or more treatment processes or waste management units under the provisions of 40 CFR part 61, subpart FF on or after December 31, 1992, comply with the requirements of this subpart for Group 1 wastewater streams.

(2) After the compliance dates specified in §63.100 of subpart F of this part, the owner or operator of any Group 1 or Group 2 wastewater stream that is also subject to provisions in 40 CFR parts 260 through 272 shall comply with the requirements of either paragraph (e)(2)(i) or (e)(2)(ii) of this section.

(i) For each Group 1 or Group 2 wastewater stream, the owner or operator shall comply with the more stringent control requirements (e.g., waste management units, numerical treatment standards, etc.) and the more stringent testing, monitoring, recordkeeping, and reporting requirements that overlap between the provisions of this subpart and the provisions of 40 CFR parts 260 through 272. The owner or operator shall keep a record of the information used to determine which requirements were the most stringent and shall submit this information if requested by the Administrator; or

(ii) The owner or operator shall submit, no later than four months before the applicable compliance date specified in §63.100 of subpart F of this part, a request for a case-by-case determination of requirements. The request shall include the information specified in paragraphs (e)(2)(ii)(A) and (e)(2)(ii)(B) of this section.

(A) Identification of the wastewater streams that are subject to this subpart and to provisions in 40 CFR parts 260 through 272, determination of the Group 1/Group 2 status of those streams, determination of whether or not those streams are listed or exhibit a characteristic as specified in 40 CFR part 261, and determination of whether the waste management unit is subject to permitting under 40 CFR part 270.

(B) Identification of the specific control requirements (e.g., waste management units, numerical treatment standards, etc.) and testing, monitoring, recordkeeping, and reporting requirements that overlap between the provisions of this subpart and the provisions of 40 CFR parts 260 through 272.

(f) *Overlap with the Vinyl Chloride NESHAP.* (1) After the compliance dates specified in §63.100 of subpart F of this part, the owner or operator of any Group 1 process vent that is also subject to the provisions of 40 CFR part 61, subpart F shall comply only with the provisions of this subpart.

(2) After the compliance dates specified in §63.100 of subpart F of this part, the owner or operator of any Group 2 process vent that is also subject to the provisions of 40 CFR part 61, subpart F shall comply with the provisions specified in either paragraph (f)(2)(i) or (f)(2)(ii) of this subpart.

(i) If the process vent is already controlled by a combustion device meeting the requirements of 40 CFR part 61, subpart F, then the owner or operator shall comply with either the associated testing, monitoring, reporting, and recordkeeping provisions for Group 1 process vents in this subpart or the testing, monitoring, reporting, and recordkeeping provisions of 40 CFR part 61, subpart F. The owner or operator shall indicate this decision in either the Notification of Compliance Status specified in §63.152 (b) of this subpart or in an operating permit application or amendment.

(ii) If the process vent is not already controlled by a combustion device, then the owner or operator shall comply with the provisions of both this subpart and 40 CFR part 61, subpart F.

(3) After the compliance dates specified in §63.100 of subpart F of this part, if an owner or operator of a process vent subject to this subpart that is also subject to the provisions of 40 CFR part 61, subpart F elects to control the process vent to the levels required in §63.113(a)(1) or (a)(2) of this subpart without calculating the TRE index value for the vent according to the procedures specified in §63.115(d) of this subpart then the owner or operator shall comply with the testing, monitoring, reporting, and recordkeeping provisions of this subpart and shall be exempt from the testing, monitoring, reporting, and recordkeeping provisions of 40 CFR part 61, subpart F.

(4) After the compliance dates specified in §63.100 of subpart F of this part, the owner or operator of a Group 1 or Group 2 wastewater stream that is also subject to the provisions of 40 CFR part 61, subpart F shall comply with the provisions of either paragraph (f)(4)(i) or (f)(4)(ii) of this section.

(i) The owner or operator shall comply with the provisions of both this subpart and 40 CFR part 61, subpart F or

(ii) The owner or operator may submit, no later than four months before the applicable compliance date specified in §63.100 of subpart F of this part, information demonstrating how compliance with 40 CFR Part 61, subpart F, will also ensure compliance with this subpart. The information shall include a description of the testing, monitoring, reporting, and recordkeeping that will be performed.

(g) *Rules stayed for reconsideration.* Notwithstanding any other provision of this subpart, the effectiveness of subpart G is stayed from October 24, 1994, to April 24, 1995, only as applied to those sources for which the owner or operator makes a representation in writing to the Administrator that the resolution of the area source definition issues could have an effect on the compliance status of the source with respect to subpart G.

(h) *Overlap with other regulations for monitoring, recordkeeping, or reporting with respect to combustion devices, recovery devices, or recapture devices.* After the compliance dates specified in §63.100 of subpart F of this part, if any combustion device, recovery device, or recapture device subject to this subpart is also subject to monitoring, recordkeeping, and reporting requirements in 40 CFR part 264, subpart AA or CC, or is subject to monitoring and recordkeeping requirements in 40 CFR part 265, subpart AA or CC and the owner or operator complies with the periodic reporting requirements under 40 CFR part 264, subpart AA or CC that would apply to the device if the facility had final-permitted status, the owner or operator may elect to comply either with the monitoring, recordkeeping, and reporting requirements of this subpart, or with the monitoring, recordkeeping, and reporting requirements in 40 CFR parts 264 and/or 265, as described in this paragraph, which shall constitute compliance with the monitoring, recordkeeping, and reporting requirements of this subpart. The owner or operator shall identify which option has been selected in the Notification of Compliance Status required by §63.152(b).

(i) *Alternative means of compliance —(1) Option to comply with part 65.* Owners or operators of CMPU that are subject to §63.100 may choose to comply with the provisions of 40 CFR part 65 for all Group 1 and Group 2 process vents, Group 1 storage vessels, Group 1 transfer operations, and equipment that are subject to §63.100, that are part of the CMPU. Other provisions applying to owners or operators who choose to comply with 40 CFR part 65 are provided in 40 CFR 65.1. Group 1 and Group 2 wastewater streams, Group 2 transfer operations, Group 2 storage vessels, and in-process streams are not eligible to comply with 40 CFR part 65 and must continue to comply with the requirements of this subpart and subpart F of this part.

(i) For Group 1 and Group 2 process vents, 40 CFR part 65, subpart D, satisfies the requirements of §§63.102, 63.103, 63.112 through 63.118, 63.148, 63.151, and 63.152.

(ii) For Group 1 storage vessels, 40 CFR part 65, subpart C, satisfies the requirements of §§63.102, 63.103, 63.112, 63.119 through 63.123, 63.148, 63.151, and 63.152.

(iii) For Group 1 transfer racks, 40 CFR part 65, subpart E, satisfies the requirements of §§63.102, 63.103, 63.112, 63.126 through 63.130, 63.148, 63.151, and 63.152.

(iv) For equipment, comply with §65.160(g).

(2) *Part 63, subpart A.* Owners or operators who choose to comply with 40 CFR part 65 must also comply with the applicable general provisions of this part 63 listed in table 1A of this subpart. All sections and paragraphs of subpart A of this part that are not mentioned in table 1A of this subpart do not apply to owners or operators who choose to comply with 40 CFR part 65, except that provisions required to be met prior to implementing 40 CFR part 65 still apply. Owners and operators who choose to comply with a subpart of 40 CFR part 65 must comply with 40 CFR part 65, subpart A.

[59 FR 19468, Apr. 22, 1994, as amended at 59 FR 53360, Oct. 24, 1994; 60 FR 5321, Jan. 27, 1995; 61 FR 64575, Dec. 5, 1996; 62 FR 2742, Jan. 17, 1997; 65 FR 78284, Dec. 14, 2000; 66 FR 6929, Jan. 22, 2001]

§ 63.111 Definitions.

All terms used in this subpart shall have the meaning given them in the Act, in subpart F of this part, and in this section, as follows.

Air oxidation reactor means a device or vessel in which air, or a combination of air and oxygen, is used

as an oxygen source in combination with one or more organic reactants to produce one or more organic compounds. Air oxidation reactor includes the product separator and any associated vacuum pump or steam jet.

Annual average concentration, as used in the wastewater provisions, means the flow-weighted annual average concentration, as determined according to the procedures specified in §63.144(b) of this subpart.

Annual average flow rate, as used in the wastewater provisions, means the annual average flow rate, as determined according to the procedures specified in §63.144(c).

Automated monitoring and recording system means any means of measuring values of monitored parameters and creating a hard copy or computer record of the measured values that does not require manual reading of monitoring instruments and manual transcription of data values. Automated monitoring and recording systems include, but are not limited to, computerized systems and strip charts.

Batch operation means a noncontinuous operation in which a discrete quantity or batch of feed is charged into a unit operation within a chemical manufacturing process unit and distilled or reacted at one time. Batch operation includes noncontinuous operations in which the equipment is fed intermittently or discontinuously. Addition of raw material and withdrawal of product do not occur simultaneously in a batch operation. After each batch operation, the equipment is generally emptied before a fresh batch is started.

Boiler means any enclosed combustion device that extracts useful energy in the form of steam and is not an incinerator. Boiler also means any industrial furnace as defined in 40 CFR 260.10.

By compound means by individual stream components, not carbon equivalents.

Car-seal means a seal that is placed on a device that is used to change the position of a valve (e.g., from opened to closed) in such a way that the position of the valve cannot be changed without breaking the seal.

Chemical manufacturing process unit means the equipment assembled and connected by pipes or ducts to process raw materials and to manufacture an intended product. A chemical manufacturing process unit consists of more than one unit operation. For the purpose of this subpart, chemical manufacturing process unit includes air oxidation reactors and their associated product separators and recovery devices; reactors and their associated product separators and recovery devices; distillation units and their associated distillate receivers and recovery devices; associated unit operations; associated recovery devices; and any feed, intermediate and product storage vessels, product transfer racks, and connected ducts and piping. A chemical manufacturing process unit includes pumps, compressors, agitators, pressure relief devices, sampling connection systems, open-ended valves or lines, valves, connectors, instrumentation systems, and control devices or systems. A chemical manufacturing process unit is identified by its primary product.

Closed biological treatment process means a tank or surface impoundment where biological treatment occurs and air emissions from the treatment process are routed to either a control device by means of a closed vent system or to a fuel gas system by means of hard-piping. The tank or surface impoundment has a fixed roof, as defined in §63.111 of this subpart, or a floating flexible membrane cover that meets the requirements specified in §63.134 of this subpart.

Closed-vent system means a system that is not open to the atmosphere and is composed of piping, ductwork, connections, and, if necessary, flow inducing devices that transport gas or vapor from an emission point to a control device.

Combustion device means an individual unit of equipment, such as a flare, incinerator, process heater, or boiler, used for the combustion of organic hazardous air pollutant emissions.

Container, as used in the wastewater provisions, means any portable waste management unit that has a capacity greater than or equal to 0.1 m³ in which a material is stored, transported, treated, or otherwise handled. Examples of containers are drums, barrels, tank trucks, barges, dumpsters, tank cars, dump trucks, and ships.

Continuous record means documentation, either in hard copy or computer readable form, of data values measured at least once every 15 minutes and recorded at the frequency specified in §63.152(f) or §63.152(g) of this subpart.

Continuous recorder means a data recording device that either records an instantaneous data value at least once every 15 minutes or records 15-minute or more frequent block average values.

Continuous seal means a seal that forms a continuous closure that completely covers the space between the wall of the storage vessel and the edge of the floating roof. A continuous seal may be a vapor-mounted, liquid-mounted, or metallic shoe seal. A continuous seal may be constructed of fastened segments so as to form a continuous seal.

Continuous vapor processing system means a vapor processing system that treats total organic compound vapors collected from tank trucks or railcars on a demand basis without intermediate accumulation in a vapor holder.

Control device means any combustion device, recovery device, or recapture device. Such equipment includes, but is not limited to, absorbers, carbon adsorbers, condensers, incinerators, flares, boilers, and process heaters. For process vents, recapture devices are considered control devices but recovery devices are not considered control devices, and for a steam stripper, a primary condenser is not considered a control device.

Cover, as used in the wastewater provisions, means a device or system which is placed on or over a waste management unit containing wastewater or residuals so that the entire surface area is enclosed to minimize air emissions. A cover may have openings necessary for operation, inspection, and maintenance of the waste management unit such as access hatches, sampling ports, and gauge wells provided that each opening is closed when not in use. Examples of covers include a fixed roof installed on a wastewater tank, a lid installed on a container, and an air-supported enclosure installed over a waste management unit.

Distillate receiver means overhead receivers, overhead accumulators, reflux drums, and condenser(s) including ejector-condenser(s) associated with a distillation unit.

Distillation unit means a device or vessel in which one or more feed streams are separated into two or more exit streams, each exit stream having component concentrations different from those in the feed stream(s). The separation is achieved by the redistribution of the components between the liquid and the vapor phases by vaporization and condensation as they approach equilibrium within the distillation unit. Distillation unit includes the distillate receiver, reboiler, and any associated vacuum pump or steam jet.

Duct work means a conveyance system such as those commonly used for heating and ventilation systems. It is often made of sheet metal and often has sections connected by screws or crimping. Hard-piping is not ductwork.

Enhanced biological treatment system or enhanced biological treatment process means an aerated, thoroughly mixed treatment unit(s) that contains biomass suspended in water followed by a clarifier that removes biomass from the treated water and recycles recovered biomass to the aeration unit. The mixed liquor volatile suspended solids (biomass) is greater than 1 kilogram per cubic meter throughout each aeration unit. The biomass is suspended and aerated in the water of the aeration unit(s) by either submerged air flow or mechanical agitation. A thoroughly mixed treatment unit is a unit that is designed and operated to approach or achieve uniform biomass distribution and organic compound concentration throughout the aeration unit by quickly dispersing the recycled biomass and the wastewater entering the unit.

External floating roof means a pontoon-type or double-deck-type cover that rests on the liquid surface in a storage vessel or waste management unit with no fixed roof.

Fill or filling means the introduction of organic hazardous air pollutant into a storage vessel or the introduction of a wastewater stream or residual into a waste management unit, but not necessarily to complete capacity.

First attempt at repair means to take action for the purpose of stopping or reducing leakage of organic

material to the atmosphere.

Fixed roof means a cover that is mounted on a waste management unit or storage vessel in a stationary manner and that does not move with fluctuations in liquid level.

Flame zone means the portion of the combustion chamber in a boiler or process heater occupied by the flame envelope.

Floating roof means a cover consisting of a double deck, pontoon single deck, internal floating cover or covered floating roof, which rests upon and is supported by the liquid being contained, and is equipped with a closure seal or seals to close the space between the roof edge and waste management unit or storage vessel wall.

Flow indicator means a device which indicates whether gas flow is, or whether the valve position would allow gas flow to be, present in a line.

Fuel gas means gases that are combusted to derive useful work or heat.

Fuel gas system means the offsite and onsite piping and control system that gathers gaseous stream(s) generated by onsite operations, may blend them with other sources of gas, and transports the gaseous stream for use as fuel gas in combustion devices, or in-process combustion equipment such as furnaces and gas turbines, either singly or in combination.

Group 1 process vent means a process vent for which the vent stream flow rate is greater than or equal to 0.005 standard cubic meter per minute, the total organic HAP concentration is greater than or equal to 50 parts per million by volume, and the total resource effectiveness index value, calculated according to §63.115, is less than or equal to 1.0.

Group 2 process vent means a process vent for which the vent stream flow rate is less than 0.005 standard cubic meter per minute, the total organic HAP concentration is less than 50 parts per million by volume or the total resource effectiveness index value, calculated according to §63.115, is greater than 1.0.

Group 1 storage vessel means a storage vessel that meets the criteria for design storage capacity and stored-liquid maximum true vapor pressure specified in table 5 of this subpart for storage vessels at existing sources, and in table 6 of this subpart for storage vessels at new sources.

Group 2 storage vessel means a storage vessel that does not meet the definition of a Group 1 storage vessel.

Group 1 transfer rack means a transfer rack that annually loads greater than or equal to 0.65 million liter of liquid products that contain organic hazardous air pollutants with a rack weighted average vapor pressure greater than or equal to 10.3 kilopascals.

Group 2 transfer rack means a transfer rack that does not meet the definition of Group 1 transfer rack.

Group 1 wastewater stream means a wastewater stream consisting of process wastewater as defined in §63.101 of subpart F at an existing or new source that meets the criteria for Group 1 status in §63.132(c) of this subpart for Table 9 compounds and/or a wastewater stream consisting of process wastewater at a new source that meets the criteria for Group 1 status in §63.132(d) of this subpart for Table 8 compounds.

Group 2 wastewater stream means any process wastewater stream that does not meet the definition of a Group 1 wastewater stream.

Halogenated vent stream or halogenated stream means a vent stream from a process vent or transfer operation determined to have a mass emission rate of halogen atoms contained in organic compounds of 0.45 kilograms per hour or greater determined by the procedures presented in §63.115(d)(2)(v) of this subpart.

Halogens and hydrogen halides means hydrogen chloride (HCl), chlorine (Cl₂), hydrogen bromide (HBr), bromine (Br₂), and hydrogen fluoride (HF).

Hard-piping means pipe or tubing that is manufactured and properly installed using good engineering judgment and standards such as American National Standards Institute (ANSI) B31-3.

Incinerator means an enclosed combustion device that is used for destroying organic compounds. Auxiliary fuel may be used to heat waste gas to combustion temperatures. Any energy recovery section present is not physically formed into one manufactured or assembled unit with the combustion section; rather, the energy recovery section is a separate section following the combustion section and the two are joined by ducts or connections carrying flue gas. The above energy recovery section limitation does not apply to an energy recovery section used solely to preheat the incoming vent stream or combustion air.

Individual drain system means the stationary system used to convey wastewater streams or residuals to a waste management unit or to discharge or disposal. The term includes hard-piping, all process drains and junction boxes, together with their associated sewer lines and other junction boxes, manholes, sumps, and lift stations, conveying wastewater streams or residuals. A segregated stormwater sewer system, which is a drain and collection system designed and operated for the sole purpose of collecting rainfall runoff at a facility, and which is segregated from all other individual drain systems, is excluded from this definition.

Intermittent vapor processing system means a vapor processing system that employs an intermediate vapor holder to accumulate total organic compound vapors collected from tank trucks or railcars, and treats the accumulated vapors only during automatically controlled cycles.

Internal floating roof means a cover that rests or floats on the liquid surface (but not necessarily in complete contact with it) inside a storage vessel or waste management unit that has a permanently affixed roof.

Junction box means a manhole or access point to a wastewater sewer line or a lift station.

Liquid-mounted seal means a foam- or liquid-filled seal mounted in contact with the liquid between the wall of the storage vessel or waste management unit and the floating roof. The seal is mounted continuously around the circumference of the vessel or unit.

Loading cycle means the time period from the beginning of filling a tank truck or railcar until flow to the control device ceases, as measured by the flow indicator.

Loading rack means a single system used to fill tank trucks and railcars at a single geographic site. Loading equipment and operations that are physically separate (i.e., do not share common piping, valves, and other equipment) are considered to be separate loading racks.

Maximum true vapor pressure means the equilibrium partial pressure exerted by the total organic HAP's in the stored or transferred liquid at the temperature equal to the highest calendar-month average of the liquid storage or transfer temperature for liquids stored or transferred above or below the ambient temperature or at the local maximum monthly average temperature as reported by the National Weather Service for liquids stored or transferred at the ambient temperature, as determined:

(1) In accordance with methods described in American Petroleum Institute Publication 2517, Evaporative Loss From External Floating-Roof Tanks (incorporated by reference as specified in §63.14 of subpart A of this part); or

(2) As obtained from standard reference texts; or

(3) As determined by the American Society for Testing and Materials Method D2879-83 or 96 (incorporated by reference as specified in §63.14 of subpart A of this part); or

(4) Any other method approved by the Administrator.

Metallic shoe seal or *mechanical shoe seal* means metal sheets that are held vertically against the wall of the storage vessel by springs, weighted levers, or other mechanisms and connected to the floating roof by braces or other means. A flexible coated fabric (envelope) spans the annular space between the metal sheet and the floating roof.

Non-automated monitoring and recording system means manual reading of values measured by monitoring instruments and manual transcription of those values to create a record. Non-automated systems do not include strip charts.

Oil-water separator or *organic-water separator* means a waste management unit, generally a tank used to separate oil or organics from water. An oil-water or organic-water separator consists of not only the separation unit but also the forebay and other separator basins, skimmers, weirs, grit chambers, sludge hoppers, and bar screens that are located directly after the individual drain system and prior to additional treatment units such as an air flotation unit, clarifier, or biological treatment unit. Examples of an oil-water or organic-water separator include, but are not limited to, an American Petroleum Institute separator, parallel-plate interceptor, and corrugated-plate interceptor with the associated ancillary equipment.

Open biological treatment process means a biological treatment process that is not a closed biological treatment process as defined in this section.

Operating permit means a permit required by 40 CFR part 70 or part 71.

Organic hazardous air pollutant or *organic HAP* means any of the chemicals listed in table 2 of subpart F of this part.

Organic monitoring device means a unit of equipment used to indicate the concentration level of organic compounds exiting a recovery device based on a detection principle such as infra-red, photoionization, or thermal conductivity.

Point of determination means each point where process wastewater exits the chemical manufacturing process unit.

Note to definition for point of determination: The regulation allows determination of the characteristics of a wastewater stream (1) at the point of determination or (2) downstream of the point of determination if corrections are made for changes in flow rate and annual average concentration of Table 8 or Table 9 compounds as determined in §63.144 of this subpart. Such changes include losses by air emissions; reduction of annual average concentration or changes in flow rate by mixing with other water or wastewater streams; and reduction in flow rate or annual average concentration by treating or otherwise handling the wastewater stream to remove or destroy hazardous air pollutants.

Point of transfer means:

(1) If the transfer is to an off-site location for control, the point where the conveyance crosses the property line; or

(2) If the transfer is to an on-site location not owned or operated by the owner or operator of the source, the point where the conveyance enters the operation or equipment of the transferee.

Primary fuel means the fuel that provides the principal heat input to the device. To be considered primary, the fuel must be able to sustain operation without the addition of other fuels.

Process heater means a device that transfers heat liberated by burning fuel directly to process streams or to heat transfer liquids other than water.

Process unit has the same meaning as *chemical manufacturing process unit* as defined in this section.

Process wastewater stream means a stream that contains process wastewater as defined in §63.101 of

subpart F of this part.

Product separator means phase separators, flash drums, knock-out drums, decanters, degassers, and condenser(s) including ejector-condenser(s) associated with a reactor or an air oxidation reactor.

Product tank, as used in the wastewater provisions, means a stationary unit that is designed to contain an accumulation of materials that are fed to or produced by a process unit, and is constructed primarily of non-earthen materials (e.g., wood, concrete, steel, plastic) which provide structural support. This term has the same meaning as a product storage vessel.

Product tank drawdown means any material or mixture of materials discharged from a product tank for the purpose of removing water or other contaminants from the product tank.

Rack-weighted average partial pressure means the throughput weighted average of the average maximum true vapor pressure of liquids containing organic HAP transferred at a transfer rack. The rack-weighted average partial pressure shall be calculated using the equation below:

Where:

P = Rack-weighted average partial pressure, kilopascals.

$$P = \frac{\sum P_i G_i}{\sum G_i}$$

P_i = Individual HAP maximum true vapor pressure, kilopascals, = $X_i \cdot P$, where X_i is the mole fraction of compound i in the liquid.

G_i = Yearly volume of each liquid that contains organic HAP that is transferred at the rack, liters.

i = Each liquid that contains HAP that is transferred at the rack.

Reactor means a device or vessel in which one or more chemicals or reactants, other than air, are combined or decomposed in such a way that their molecular structures are altered and one or more new organic compounds are formed. Reactor includes the product separator and any associated vacuum pump or steam jet.

Recapture device means an individual unit of equipment capable of and used for the purpose of recovering chemicals, but not normally for use, reuse, or sale. For example, a recapture device may recover chemicals primarily for disposal. Recapture devices include, but are not limited to, absorbers, carbon adsorbers, and condensers.

Recovery device means an individual unit of equipment capable of and normally used for the purpose of recovering chemicals for fuel value (i.e., net positive heating value), use, reuse or for sale for fuel value, use, or reuse. Examples of equipment that may be recovery devices include absorbers, carbon adsorbers, condensers, oil-water separators or organic-water separators, or organic removal devices such as decanters, strippers, or thin-film evaporation units. For purposes of the monitoring, recordkeeping, and reporting requirements of this subpart, recapture devices are considered recovery devices.

Relief valve means a valve used only to release an unplanned, nonroutine discharge. A relief valve discharge can result from an operator error, a malfunction such as a power failure or equipment failure, or other unexpected cause that requires immediate venting of gas from process equipment in order to avoid safety hazards or equipment damage.

Reference control technology for process vents means a combustion device or recapture device used to reduce organic hazardous air pollutant emissions by 98 percent, or to an outlet concentration of 20 parts

per million by volume.

Reference control technology for storage vessels means an internal floating roof meeting the specifications of §63.119(b) of this subpart, an external floating roof meeting the specifications of §63.119(c) of this subpart, an external floating roof converted to an internal floating roof meeting the specifications of §63.119(d) of this subpart, or a closed-vent system to a control device achieving 95-percent reduction in organic HAP emissions. For purposes of emissions averaging, these four technologies are considered equivalent.

Reference control technology for transfer racks means a combustion device, recapture device, or recovery device used to reduce organic hazardous air pollutants emissions by 98 percent, or to an outlet concentration of 20 parts per million by volume; or a vapor balancing system.

Reference control technology for wastewater means the use of:

- (1) Controls specified in §63.133 through §63.137;
- (2) A steam stripper meeting the specifications of §63.138(d) of this subpart or any of the other alternative control measures specified in §63.138(b), (c), (e), (f), (g), or (h) of this subpart; and
- (3) A control device to reduce by 95 percent (or to an outlet concentration of 20 parts per million by volume for combustion devices or for noncombustion devices controlling air emissions from waste management units other than surface impoundments or containers) the organic hazardous air pollutants emissions in the vapor streams vented from wastewater tanks, oil-water separators, containers, surface impoundments, individual drain systems, and treatment processes (including the design steam stripper) managing wastewater.

Residual means any liquid or solid material containing Table 9 compounds that is removed from a wastewater stream by a waste management unit or treatment process that does not destroy organics (nondestructive unit). Examples of residuals from nondestructive wastewater management units are: the organic layer and bottom residue removed by a decanter or organic-water separator and the overheads from a steam stripper or air stripper. Examples of materials which are not residuals are: silt; mud; leaves; bottoms from a steam stripper or air stripper; and sludges, ash, or other materials removed from wastewater being treated by destructive devices such as biological treatment units and incinerators.

Secondary fuel means a fuel fired through a burner other than the primary fuel burner that provides supplementary heat in addition to the heat provided by the primary fuel.

Sewer line means a lateral, trunk line, branch line, or other conduit including, but not limited to, grates, trenches, etc., used to convey wastewater streams or residuals to a downstream waste management unit.

Simultaneous loading means, for a shared control device, loading of organic HAP materials from more than one transfer arm at the same time such that the beginning and ending times of loading cycles coincide or overlap and there is no interruption in vapor flow to the shared control device.

Single-seal system means a floating roof having one continuous seal that completely covers the space between the wall of the storage vessel and the edge of the floating roof. This seal may be a vapor-mounted, liquid-mounted, or metallic shoe seal.

Specific gravity monitoring device means a unit of equipment used to monitor specific gravity and having a minimum accuracy of ± 0.02 specific gravity units.

Steam jet ejector means a steam nozzle which discharges a high-velocity jet across a suction chamber that is connected to the equipment to be evacuated.

Surface impoundment means a waste management unit which is a natural topographic depression, manmade excavation, or diked area formed primarily of earthen materials (although it may be lined with manmade materials), which is designed to hold an accumulation of liquid wastes or waste containing free liquids. A surface impoundment is used for the purpose of treating, storing, or disposing of wastewater or residuals, and is not an injection well. Examples of surface impoundments are

equalization, settling, and aeration pits, ponds, and lagoons.

Surge control vessel means feed drums, recycle drums, and intermediate vessels. Surge control vessels are used within a chemical manufacturing process unit when in-process storage, mixing, or management of flow rates or volumes is needed to assist in production of a product.

Table 8 compound means a compound listed in table 8 of this subpart.

Table 9 compound means a compound listed in table 9 of this subpart.

Temperature monitoring device means a unit of equipment used to monitor temperature and having a minimum accuracy of (a) ± 1 percent of the temperature being monitored expressed in degrees Celsius ($^{\circ}\text{C}$) or (b) ± 0.5 degrees ($^{\circ}\text{C}$), whichever is greater.

The 33/50 program means a voluntary pollution prevention initiative established and administered by the EPA to encourage emissions reductions of 17 chemicals emitted in large volumes by industrial facilities. The EPA Document Number 741-K-92-001 provides more information about the 33/50 program.

Total organic compounds or *TOC*, as used in the process vents provisions, means those compounds measured according to the procedures of Method 18 of 40 CFR part 60, appendix A.

Total resource effectiveness index value or *TRE index value* means a measure of the supplemental total resource requirement per unit reduction of organic HAP associated with a process vent stream, based on vent stream flow rate, emission rate of organic HAP, net heating value, and corrosion properties (whether or not the vent stream contains halogenated compounds), as quantified by the equations given under §63.115 of this subpart.

Treatment process means a specific technique that removes or destroys the organics in a wastewater or residual stream such as a steam stripping unit, thin-film evaporation unit, waste incinerator, biological treatment unit, or any other process applied to wastewater streams or residuals to comply with §63.138 of this subpart. Most treatment processes are conducted in tanks. Treatment processes are a subset of waste management units.

Vapor collection system, as used in the transfer provisions, means the equipment used to collect and transport organic HAP vapors displaced during the loading of tank trucks or railcars. This does not include the vapor collection system that is part of any tank truck or railcar vapor collection manifold system.

Vapor-mounted seal means a continuous seal that completely covers the annular space between the wall of the storage vessel or waste management unit and the edge of the floating roof and is mounted such that there is a vapor space between the stored liquid and the bottom of the seal.

Vent stream, as used in the process vent provisions, means the gas stream flowing through the process vent.

Waste management unit means the equipment, structure(s), and/or device(s) used to convey, store, treat, or dispose of wastewater streams or residuals. Examples of waste management units include: Wastewater tanks, surface impoundments, individual drain systems, and biological wastewater treatment units. Examples of equipment that may be waste management units include containers, air flotation units, oil-water separators or organic-water separators, or organic removal devices such as decanters, strippers, or thin-film evaporation units. If such equipment is used for recovery, then it is part of a chemical manufacturing process unit and is not a waste management unit.

Wastewater stream means a stream that contains only wastewater as defined in §63.101 of subpart F of this part.

Wastewater tank means a stationary waste management unit that is designed to contain an accumulation of wastewater or residuals and is constructed primarily of non-earthen materials (e.g., wood, concrete, steel, plastic) which provide structural support. Wastewater tanks used for flow equalization are included in this definition.

Water seal controls means a seal pot, p-leg trap, or other type of trap filled with water (e.g, flooded sewers that maintain water levels adequate to prevent air flow through the system) that creates a water barrier between the sewer line and the atmosphere. The water level of the seal must be maintained in the vertical leg of a drain in order to be considered a water seal.

[59 FR 19468, Apr. 22, 1994, as amended at 60 FR 18024, 18029, Apr. 10, 1995; 60 FR 63626, Dec. 12, 1995; 62 FR 2742, Jan. 17, 1997; 63 FR 67792, Dec. 9, 1998; 65 FR 62215, Oct. 17, 2000; 66 FR 6929, Jan. 22, 2001]

§ 63.112 Emission standard.

(a) The owner or operator of an existing source subject to the requirements of this subpart shall control emissions of organic HAP's to the level represented by the following equation:

$$E_A = 0.02 \sum EPV_1 + \sum EPV_2 + 0.05 \sum ES_1 + \sum ES_2 + 0.02 \sum ETR_1 + \sum ETR_2 + \sum EWW_{1C} + \sum EWW_2$$

where:

E_A = Emission rate, megagrams per year, allowed for the source.

$0.02 \sum EPV_1$ = Sum of the residual emissions, megagrams per year, from all Group 1 process vents, as defined in §63.111 of this subpart.

$\sum EPV_2$ = Sum of the emissions, megagrams per year, from all Group 2 process vents as defined in §63.111 of this subpart.

$0.05 \sum ES_1$ = Sum of the residual emissions, megagrams per year, from all Group 1 storage vessels, as defined in §63.111 of this subpart.

$\sum ES_2$ = Sum of the emissions, megagrams per year, from all Group 2 storage vessels, as defined in §63.111 of this subpart.

$0.02 \sum ETR_1$ = Sum of the residual emissions, megagrams per year, from all Group 1 transfer racks, as defined in §63.111 of this subpart.

$\sum ETR_2$ = Sum of the emissions, megagrams per year, from all Group 2 transfer racks, as defined in §63.111 of this subpart.

$\sum EWW_{1C}$ = Sum of the residual emissions from all Group 1 wastewater streams, as defined in §63.111 of this subpart. This term is calculated for each Group 1 stream according to the equation for EWW_{1C} in §63.150(g)(5)(i) of this subpart.

$\sum EWW_2$ = Sum of emissions from all Group 2 wastewater streams, as defined in §63.111 of this subpart.

The emissions level represented by this equation is dependent on the collection of emission points in the source. The level is not fixed and can change as the emissions from each emission point change or as the number of emission points in the source changes.

(b) The owner or operator of a new source subject to the requirements of this subpart shall control emissions of organic HAP's to the level represented by the equation in paragraph (a) of this section.

(c) The owner or operator of an existing source shall demonstrate compliance with the emission standard in paragraph (a) of this section by following the procedures specified in paragraph (e) of this

section for all emission points, or by following the emissions averaging compliance approach specified in paragraph (f) of this section for some emission points and the procedures specified in paragraph (e) of this section for all other emission points within the source.

(d) The owner or operator of a new source shall demonstrate compliance with the emission standard in paragraph (b) of this section only by following the procedures in paragraph (e) of this section. The owner or operator of a new source may not use the emissions averaging compliance approach.

(e) The owner or operator of an existing or new source may comply with the process vent provisions in §§63.113 through 63.118 of this subpart, the storage vessel provisions in §§63.119 through 63.123 of this subpart, the transfer operation provisions in §§63.126 through 63.130 of this subpart, the wastewater provisions in §§63.131 through 63.147 of this subpart, the leak inspection provisions in §63.148, and the provisions in §63.149 of this subpart.

(1) The owner or operator using this compliance approach shall also comply with the requirements of §63.151 and §63.152 of this subpart, as applicable.

(2) The owner or operator using this compliance approach is not required to calculate the annual emission rate specified in paragraph (a) of this section.

(3) When emissions of different kinds (e.g., emissions from process vents, transfer operations, storage vessels, process wastewater, and/or in-process equipment subject to §63.149 of this subpart) are combined, and at least one of the emission streams would be classified as Group 1 in the absence of combination with other emission streams, the owner or operator shall comply with the requirements of either paragraph (e)(3)(i) or paragraph (e)(3)(ii) of this section.

(i) Comply with the applicable requirements of this subpart for each kind of emissions in the stream (e.g., the requirements in §§63.113 through 63.118 of this subpart G for process vents, and the requirements of §§63.126 through 63.130 for transfer operations); or

(ii) Comply with the first set of requirements identified in paragraphs (e)(3)(ii)(A) through (e)(3)(ii)(E) of this section which applies to any individual emission stream that is included in the combined stream, where either that emission stream would be classified as Group 1 in the absence of combination with other emission streams, or the owner chooses to consider that emission stream to be Group 1 for purposes of this paragraph. Compliance with the first applicable set of requirements identified in paragraphs (e)(3)(ii)(A) through (e)(3)(ii)(E) of this section constitutes compliance with all other requirements in paragraphs (e)(3)(ii)(A) through (e)(3)(ii)(E) of this section applicable to other types of emissions in the combined stream.

(A) The requirements of this subpart for Group 1 process vents, including applicable monitoring, recordkeeping, and reporting;

(B) The requirements of this subpart for Group 1 transfer racks, including applicable monitoring, recordkeeping, and reporting;

(C) The requirements of §63.119(e) for control of emissions from Group 1 storage vessels, including monitoring, recordkeeping, and reporting;

(D) The requirements of §63.139 for control devices used to control emissions from waste management units, including applicable monitoring, recordkeeping, and reporting; or

(E) The requirements of §63.139 for closed vent systems for control of emissions from in-process equipment subject to §63.149, including applicable monitoring, recordkeeping, and reporting.

(f) The owner or operator of an existing source may elect to control some of the emission points within the source to different levels than specified under §§63.113 through 63.148 of this subpart by using an emissions averaging compliance approach as long as the overall emissions for the source do not exceed the emission level specified in paragraph (a) of this section. The owner or operator using emissions averaging must meet the requirements in paragraphs (f)(1) and (f)(2) of this section.

(1) Calculate emission debits and credits for those emission points involved in the emissions average as

specified in §63.150 of this subpart; and

(2) Comply with the requirements of §63.151 and §63.152 of this subpart, as applicable.

(g) A State may restrict the owner or operator of an existing source to using only the procedures in paragraph (e) of this section to comply with the emission standard in paragraph (a) of this section.

(h) Where the provisions of this subpart require a performance test, waiver of that requirement shall be addressed only as provided in §63.103(b)(5) of subpart F of this part.

[59 FR 19468, Apr. 22, 1994, as amended at 62 FR 2744, Jan. 17, 1997]

§ 63.113 Process vent provisions—reference control technology.

(a) The owner or operator of a Group 1 process vent as defined in this subpart shall comply with the requirements of paragraph (a)(1), (2), or (3) of this section. The owner or operator who transfers a gas stream that has the characteristics specified in §63.107 (b) through (h) or meets the criteria specified in §63.107(i) to an off-site location or an on-site location not owned or operated by the owner or operator of the source for disposal shall comply with the requirements of paragraph (i) of this section.

(1) Reduce emissions of organic HAP using a flare.

(i) The flare shall comply with the requirements of §63.11(b) of subpart A of this part.

(ii) Halogenated vent streams, as defined in §63.111 of this subpart, shall not be vented to a flare.

(2) Reduce emissions of total organic hazardous air pollutants by 98 weight-percent or to a concentration of 20 parts per million by volume, whichever is less stringent. For combustion devices, the emission reduction or concentration shall be calculated on a dry basis, corrected to 3-percent oxygen, and compliance can be determined by measuring either organic hazardous air pollutants or total organic carbon using the procedures in §63.116 of this subpart.

(i) Compliance with paragraph (a)(2) of this section may be achieved by using any combination of combustion, recovery, and/or recapture devices, except that a recovery device may not be used to comply with paragraph (a)(2) of this section by reducing emissions of total organic hazardous air pollutants by 98 weight-percent, except as provided in paragraph (a)(2)(ii) of this section.

(ii) An owner or operator may use a recovery device, alone or in combination with one or more combustion or recapture devices, to reduce emissions of total organic hazardous air pollutants by 98 weight-percent if all the conditions of paragraphs (a)(2)(ii)(A) through (a)(2)(ii)(D) of this section are met.

(A) The recovery device (and any combustion device or recapture device which operates in combination with the recovery device to reduce emissions of total organic hazardous air pollutants by 98 weight-percent) was installed before the date of proposal of the subpart of this part 63 that makes this subpart G applicable to process vents in the chemical manufacturing process unit.

(B) The recovery device that will be used to reduce emissions of total organic hazardous air pollutants by 98 weight-percent is the last recovery device before emission to the atmosphere.

(C) The recovery device, alone or in combination with one or more combustion or recapture devices, is capable of reducing emissions of total organic hazardous air pollutants by 98 weight-percent, but is not capable of reliably reducing emissions of total organic hazardous air pollutants to a concentration of 20 parts per million by volume.

(D) If the owner or operator disposed of the recovered material, the recovery device would comply with the requirements of this subpart for recapture devices.

(3) Achieve and maintain a TRE index value greater than 1.0 at the outlet of the final recovery device, or prior to release of the vent stream to the atmosphere if no recovery device is present. If the TRE index

value is greater than 1.0, the process vent shall comply with the provisions for a Group 2 process vent specified in either paragraph (d) or (e) of this section, whichever is applicable.

(b) If a boiler or process heater is used to comply with the percent reduction requirement or concentration limit specified in paragraph (a)(2) of this section, then the vent stream shall be introduced into the flame zone of such a device.

(c) Halogenated vent streams from Group 1 process vents that are combusted shall be controlled according to paragraph (c)(1) or (2) of this section.

(1) If a combustion device is used to comply with paragraph (a)(2) of this section for a halogenated vent stream, then the gas stream exiting the combustion device shall be conveyed to a halogen reduction device, such as a scrubber, before it is discharged to the atmosphere.

(i) Except as provided in paragraph (c)(1)(ii) of this section, the halogen reduction device shall reduce overall emissions of hydrogen halides and halogens, as defined in §63.111 of this subpart, by 99 percent or shall reduce the outlet mass of total hydrogen halides and halogens to less than 0.45 kilogram per hour, whichever is less stringent.

(ii) If a scrubber or other halogen reduction device was installed prior to December 31, 1992, the device shall reduce overall emissions of hydrogen halides and halogens, as defined in §63.111 of this subpart, by 95 percent or shall reduce the outlet mass of total hydrogen halides and halogens to less than 0.45 kilograms per hour, whichever is less stringent.

(2) A halogen reduction device, such as a scrubber or other technique, may be used to reduce the vent stream halogen atom mass emission rate to less than 0.45 kilogram per hour prior to any combustion control device, and thus make the vent stream nonhalogenated; the vent stream must comply with the requirements of paragraph (a)(1) or (a)(2) of this section.

(d) The owner or operator of a Group 2 process vent having a flow rate greater than or equal to 0.005 standard cubic meter per minute, a HAP concentration greater than or equal to 50 parts per million by volume, and a TRE index value greater than 1.0 but less than or equal to 4.0 shall maintain a TRE index value greater than 1.0 and shall comply with the monitoring of recovery device parameters in §63.114(b) or (c) of this subpart, the TRE index calculations of §63.115 of this subpart, and the applicable reporting and recordkeeping provisions of §§63.117 and 63.118 of this subpart. Such owner or operator is not subject to any other provisions of §§63.114 through 63.118 of this subpart.

(e) The owner or operator of a Group 2 process vent with a TRE index value greater than 4.0 shall maintain a TRE index value greater than 4.0, comply with the provisions for calculation of a TRE index value in §63.115 and the reporting and recordkeeping provisions in §§63.117(b) and 63.118(c) and (h), and is not subject to monitoring or any other provisions of §§63.114 through 63.118.

(f) The owner or operator of a Group 2 process vent with a flow rate less than 0.005 standard cubic meter per minute shall maintain a flow rate less than 0.005 standard cubic meter per minute; comply with the Group determination procedures in §63.115 (a), (b), and (e) of this subpart; and the reporting and recordkeeping requirements in §63.117(c) of this subpart, §63.118(d) of this subpart, and §63.118(i) of this subpart; and is not subject to monitoring or any other provisions of §§63.114 through 63.118 of this subpart.

(g) The owner or operator of a Group 2 process vent with a total organic HAP concentration less than 50 parts per million by volume shall maintain a total organic HAP concentration less than 50 parts per million by volume; comply with the Group determination procedures in §63.115(a), (c), and (e); the reporting and recordkeeping requirements in §§63.117(d) and 63.118(e) and (j); and is not subject to monitoring or any other provisions of §§63.114 through 63.118.

(h) The owner or operator of a process vent complying with paragraph (a)(1) or (a)(2) of this section is not required to perform the group determination described in §63.115 of this subpart.

(i) *Off-site control or on-site control not owned or operated by the source.* This paragraph (i) applies to gas streams that have the characteristics specified in §63.107(b) through (h) or meet the criteria specified in §63.107(i); that are transferred for disposal to an on-site control device (or other compliance

equipment) not owned or operated by the owner or operator of the source generating the gas stream, or to an off-site control device or other compliance equipment; and that have the characteristics (e.g., flow rate, total organic HAP concentration, or TRE index value) of a Group 1 process vent, determined at the point of transfer.

(1) The owner or operator transferring the gas stream shall:

(i) Comply with the provisions specified in §63.114(d) for each gas stream prior to transfer.

(ii) Notify the transferee that the gas stream contains organic hazardous air pollutants that are to be treated in accordance with the provisions of this subpart. The notice shall be submitted to the transferee initially and whenever there is a change in the required control.

(2) The owner or operator may not transfer the gas stream unless the transferee has submitted to the EPA a written certification that the transferee will manage and treat any gas stream transferred under this paragraph (i) and received from a source subject to the requirements of this subpart in accordance with the requirements of either §§63.113 through 63.118, or §63.102(b), or subpart D of this part if alternative emission limitations have been granted the transferor in accordance with those provisions. The certifying entity may revoke the written certification by sending a written statement to EPA and the owner or operator giving at least 90 days notice that the certifying entity is rescinding acceptance of responsibility for compliance with the regulatory provisions listed in this paragraph (i). Upon expiration of the notice period, the owner or operator may not transfer the gas stream to the transferee. Records retained by the transferee shall be retained in accordance with §63.103(c).

(3) By providing this written certification to EPA, the certifying entity accepts responsibility for compliance with the regulatory provisions listed in paragraph (i)(2) of this section with respect to any transfer covered by the written certification. Failure to abide by any of those provisions with respect to such transfers may result in enforcement action by EPA against the certifying entity in accordance with the enforcement provisions applicable to violations of these provisions by owners or operators of sources.

(4) Written certifications and revocation statements to EPA from the transferees of such gas streams shall be signed by a responsible official of the certifying entity, provide the name and address of the certifying entity, and be sent to the appropriate EPA Regional Office at the addresses listed in §63.13. Such written certifications are not transferable by the transferee.

[59 FR 19468, Apr. 22, 1994, as amended at 62 FR 2745, Jan. 17, 1997; 66 FR 6929, Jan. 22, 2001]

§ 63.114 Process vent provisions—monitoring requirements.

(a) Each owner or operator of a process vent that uses a combustion device to comply with the requirements in §63.113 (a)(1) or (a)(2) of this subpart, or that uses a recovery device or recapture device to comply with the requirements in §63.113(a)(2) of this subpart, shall install monitoring equipment specified in paragraph (a)(1), (a)(2), (a)(3), (a)(4), or (a)(5) of this section, depending on the type of device used. All monitoring equipment shall be installed, calibrated, maintained, and operated according to manufacturer's specifications or other written procedures that provide adequate assurance that the equipment would reasonably be expected to monitor accurately.

(1) Where an incinerator is used, a temperature monitoring device equipped with a continuous recorder is required.

(i) Where an incinerator other than a catalytic incinerator is used, a temperature monitoring device shall be installed in the firebox or in the ductwork immediately downstream of the firebox in a position before any substantial heat exchange occurs.

(ii) Where a catalytic incinerator is used, temperature monitoring devices shall be installed in the gas stream immediately before and after the catalyst bed.

(2) Where a flare is used, the following monitoring equipment is required: A device (including but not limited to a thermocouple, ultra-violet beam sensor, or infrared sensor) capable of continuously detecting the presence of a pilot flame.

(3) Where a boiler or process heater of less than 44 megawatts design heat input capacity is used, the following monitoring equipment is required: a temperature monitoring device in the firebox equipped with a continuous recorder. This requirement does not apply to gas streams that are introduced with primary fuel or are used as the primary fuel.

(4) Where a scrubber is used with an incinerator, boiler, or process heater in the case of halogenated vent streams, the following monitoring equipment is required for the scrubber.

(i) A pH monitoring device equipped with a continuous recorder shall be installed to monitor the pH of the scrubber effluent.

(ii) A flow meter equipped with a continuous recorder shall be located at the scrubber influent for liquid flow. Gas flow rate shall be determined using one of the procedures specified in paragraphs (a)(4)(ii)(A) through (C) of this section.

(A) The owner or operator may determine gas flow rate using the design blower capacity, with appropriate adjustments for pressure drop.

(B) If the scrubber is subject to rules in 40 CFR parts 264 through 266 that have required a determination of the liquid to gas (L/G) ratio prior to the applicable compliance date for this subpart specified in §63.100(k), the owner or operator may determine gas flow rate by the method that had been utilized to comply with those rules. A determination that was conducted prior to the compliance date for this subpart may be utilized to comply with this subpart if it is still representative.

(C) The owner or operator may prepare and implement a gas flow rate determination plan that documents an appropriate method which will be used to determine the gas flow rate. The plan shall require determination of gas flow rate by a method which will at least provide a value for either a representative or the highest gas flow rate anticipated in the scrubber during representative operating conditions other than startups, shutdowns, or malfunctions. The plan shall include a description of the methodology to be followed and an explanation of how the selected methodology will reliably determine the gas flow rate, and a description of the records that will be maintained to document the determination of gas flow rate. The owner or operator shall maintain the plan as specified in §63.103(c).

(5) Where a recovery device or recapture device is used to comply with the requirements of §63.113(a)(2) of this subpart, the owner or operator shall utilize the appropriate monitoring device identified in paragraph (b), (b)(1), (b)(2), or (b)(3) of this section.

(b) Each owner or operator of a process vent with a TRE index value greater than 1.0 as specified under §§63.113(a)(3) or 63.113(d) of this subpart that uses one or more recovery devices shall install either an organic monitoring device equipped with a continuous recorder or the monitoring equipment specified in paragraph (b)(1), (b)(2), or (b)(3) of this section, depending on the type of recovery device used. All monitoring equipment shall be installed, calibrated, and maintained according to the manufacturer's specifications or other written procedures that provide adequate assurance that the equipment would reasonably be expected to monitor accurately. Monitoring is not required for process vents with TRE index values greater than 4.0 as specified in §63.113(e) of this subpart.

(1) Where an absorber is the final recovery device in the recovery system, a scrubbing liquid temperature monitoring device and a specific gravity monitoring device, each equipped with a continuous recorder shall be used;

(2) Where a condenser is the final recovery device in the recovery system, a condenser exit (product side) temperature monitoring device equipped with a continuous recorder shall be used;

(3) Where a carbon adsorber is the final recovery device in the recovery system, an integrating regeneration stream flow monitoring device having an accuracy of ± 10 percent or better, capable of recording the total regeneration stream mass or volumetric flow for each regeneration cycle; and a carbon bed temperature monitoring device, capable of recording the carbon bed temperature after each regeneration and within 15 minutes of completing any cooling cycle shall be used.

(c) An owner or operator of a process vent may request approval to monitor parameters other than those listed in paragraph (a) or (b) of this section. The request shall be submitted according to the procedures

specified in §63.151(f) or §63.152(e) of this subpart. Approval shall be requested if the owner or operator:

- (1) Uses a combustion device other than an incinerator, boiler, process heater, or flare; or
 - (2) Maintains a TRE greater than 1.0 but less than or equal to 4.0 without a recovery device or with a recovery device other than the recovery devices listed in paragraphs (a) and (b) of this section; or
 - (3) Uses one of the combustion or recovery or recapture devices listed in paragraphs (a) and (b) of this section, but seeks to monitor a parameter other than those specified in paragraphs (a) and (b) of this section.
- (d) The owner or operator of a process vent shall comply with paragraph (d)(1) or (2) of this section for any bypass line between the origin of the gas stream (i.e., at an air oxidation reactor, distillation unit, or reactor as identified in §63.107(b)) and the point where the gas stream reaches the process vent, as described in §63.107, that could divert the gas stream directly to the atmosphere. Equipment such as low leg drains, high point bleeds, analyzer vents, open-ended valves or lines, and pressure relief valves needed for safety purposes are not subject to this paragraph (d).

(1) Properly install, maintain, and operate a flow indicator that takes a reading at least once every 15 minutes. Records shall be generated as specified in §63.118(a)(3). The flow indicator shall be installed at the entrance to any bypass line that could divert the gas stream to the atmosphere; or

(2) Secure the bypass line valve in the non-diverting position with a car-seal or a lock-and-key type configuration. A visual inspection of the seal or closure mechanism shall be performed at least once every month to ensure that the valve is maintained in the non-diverting position and the gas stream is not diverted through the bypass line.

(e) The owner or operator shall establish a range that indicates proper operation of the control or recovery device for each parameter monitored under paragraphs (a), (b), and (c) of this section. In order to establish the range, the information required in §63.152(b) of this subpart shall be submitted in the Notification of Compliance Status or the operating permit application or amendment. The range may be based upon a prior performance test conducted for determining compliance with a regulation promulgated by the EPA, and the owner or operator is not required to conduct a performance test under §63.116 of this subpart, if the prior performance test was conducted using the same methods specified in §63.116 and either no process changes have been made since the test, or the owner or operator can demonstrate that the results of the performance test, with or without adjustments, reliably demonstrate compliance despite process changes.

[59 FR 19468, Apr. 22, 1994, as amended at 62 FR 2745, Jan. 17, 1997; 66 FR 6930, Jan. 22, 2001]

§ 63.115 Process vent provisions—methods and procedures for process vent group determination.

(a) For purposes of determining vent stream flow rate, total organic HAP or total organic carbon concentration or TRE index value, as specified under paragraph (b), (c), or (d) of this section, the sampling site shall be after the last recovery device (if any recovery devices are present) but prior to the inlet of any control device that is present and prior to release to the atmosphere.

(1) Method 1 or 1A of 40 CFR part 60, appendix A, as appropriate, shall be used for selection of the sampling site.

(2) No traverse site selection method is needed for vents smaller than 0.10 meter in diameter.

(b) To demonstrate that a vent stream flow rate is less than 0.005 standard cubic meter per minute in accordance with the Group 2 process vent definition of this subpart, the owner or operator shall measure flow rate by the following procedures:

(1) The sampling site shall be selected as specified in paragraph (a) of this section.

(2) The gas volumetric flow rate shall be determined using Method 2, 2A, 2C, or 2D of 40 CFR part 60, appendix A, as appropriate.

(c) Each owner or operator seeking to demonstrate that a vent stream has an organic HAP concentration below 50 parts per million by volume in accordance with the Group 2 process vent definition of this subpart shall measure either total organic HAP or TOC concentration using the following procedures:

(1) The sampling site shall be selected as specified in paragraph (a) of this section.

(2) Method 18 or Method 25A of 40 CFR part 60, appendix A shall be used to measure concentration; alternatively, any other method or data that has been validated according to the protocol in Method 301 of appendix A of this part may be used.

(3) Where Method 18 of 40 CFR part 60, appendix A is used, the following procedures shall be used to calculate parts per million by volume concentration:

(i) The minimum sampling time for each run shall be 1 hour in which either an integrated sample or four grab samples shall be taken. If grab sampling is used, then the samples shall be taken at approximately equal intervals in time, such as 15 minute intervals during the run.

(ii) The concentration of either TOC (minus methane and ethane) or organic HAP shall be calculated according to paragraph (c)(3)(ii)(A) or (c)(3)(ii)(B) of this section as applicable.

(A) The TOC concentration (C_{TOC}) is the sum of the concentrations of the individual components and shall be computed for each run using the following equation:

$$C_{TOC} = \frac{\sum_{i=1}^x \left(\sum_{j=1}^n C_{ji} \right)}{X}$$

where:

C_{TOC} = Concentration of TOC (minus methane and ethane), dry basis, parts per million by volume.

C_{ji} = Concentration of sample component j of the sample i , dry basis, parts per million by volume.

n = Number of components in the sample.

x = Number of samples in the sample run.

(B) The total organic HAP concentration (C_{HAP}) shall be computed according to the equation in paragraph (c)(3)(ii)(A) of this section except that only the organic HAP species shall be summed. The list of organic HAP's is provided in table 2 of subpart F of this part.

(4) Where Method 25A of 40 CFR part 60, appendix A is used, the following procedures shall be used to calculate parts per million by volume TOC concentration:

(i) Method 25A of 40 CFR part 60, appendix A, shall be used only if a single organic HAP compound is greater than 50 percent of total organic HAP, by volume, in the vent stream.

(ii) The vent stream composition may be determined by either process knowledge, test data collected using an appropriate EPA method, or a method or data validated according to the protocol in Method

301 of appendix A of this part. Examples of information that could constitute process knowledge include calculations based on material balances, process stoichiometry, or previous test results provided the results are still relevant to the current vent stream conditions.

(iii) The organic HAP used as the calibration gas for Method 25A of 40 CFR part 60, appendix A shall be the single organic HAP compound present at greater than 50 percent of the total organic HAP by volume.

(iv) The span value for Method 25A of 40 CFR part 60, appendix A shall be 50 parts per million by volume.

(v) Use of Method 25A of 40 CFR part 60, appendix A is acceptable if the response from the high-level calibration gas is at least 20 times the standard deviation of the response from the zero calibration gas when the instrument is zeroed on the most sensitive scale.

(vi) The owner or operator shall demonstrate that the concentration of TOC including methane and ethane measured by Method 25A of 40 CFR part 60, appendix A is below 25 parts per million by volume to be considered a Group 2 vent with an organic HAP concentration below 50 parts per million by volume and to qualify for the low concentration exclusion in §63.113(g) of this subpart.

(d) To determine the TRE index value, the owner or operator shall conduct a TRE determination and calculate the TRE index value according to the procedures in paragraph (d)(1) or (d)(2) of this section and the TRE equation in paragraph (d)(3) of this section.

(1) Engineering assessment may be used to determine vent stream flow rate, net heating value, TOC emission rate, and total organic HAP emission rate for the representative operating condition expected to yield the lowest TRE index value.

(i) If the TRE value calculated using such engineering assessment and the TRE equation in paragraph (d)(3) of this section is greater than 4.0, then the owner or operator is not required to perform the measurements specified in paragraph (d)(2) of this section.

(ii) If the TRE value calculated using such engineering assessment and the TRE equation in paragraph (d)(3) of this section is less than or equal to 4.0, then the owner or operator is required to perform the measurements specified in paragraph (d)(2) of this section for group determination or consider the process vent a Group 1 vent and comply with the emission reduction specified in §63.113(a) of this subpart.

(iii) Engineering assessment includes, but is not limited to, the following:

(A) Previous test results provided the tests are representative of current operating practices at the process unit.

(B) Bench-scale or pilot-scale test data representative of the process under representative operating conditions.

(C) Maximum flow rate, TOC emission rate, organic HAP emission rate, or net heating value limit specified or implied within a permit limit applicable to the process vent.

(D) Design analysis based on accepted chemical engineering principles, measurable process parameters, or physical or chemical laws or properties. Examples of analytical methods include, but are not limited to:

(1) Use of material balances based on process stoichiometry to estimate maximum organic HAP concentrations,

(2) Estimation of maximum flow rate based on physical equipment design such as pump or blower capacities,

(3) Estimation of TOC or organic HAP concentrations based on saturation conditions,

(4) Estimation of maximum expected net heating value based on the vent stream concentration of each organic compound or, alternatively, as if all TOC in the vent stream were the compound with the highest heating value.

(E) All data, assumptions, and procedures used in the engineering assessment shall be documented.

(2) Except as provided in paragraph (d)(1) of this section, vent stream flow rate, net heating value, TOC emission rate, and total organic HAP emission rate shall be measured and calculated according to the procedures in paragraphs (d)(2)(i) through (v) of this section and used as input to the TRE index value calculation in paragraph (d)(3) of this section.

(i) The vent stream volumetric flow rate (Q_s), in standard cubic meters per minute at 20 degrees Celcius, shall be determined using Method 2, 2A, 2C, or 2D of 40 CFR part 60, appendix A, as appropriate. If the vent stream tested passes through a final steam jet ejector and is not condensed, the vent stream volumetric flow shall be corrected to 2.3 percent moisture.

(ii) The molar composition of the vent stream, which is used to calculate net heating value, shall be determined using the following methods:

(A) Method 18 of 40 CFR part 60, appendix A to measure the concentration of each organic compound.

(B) American Society for Testing and Materials D1946-77 to measure the concentration of carbon monoxide and hydrogen.

(C) Method 4 of 40 CFR part 60, appendix A, to measure the moisture content of the vent stream.

(iii) The net heating value of the vent stream shall be calculated using the following equation:

$$H_T = K_1 \left(\sum_{j=1}^n C_j H_j \right) (1 - B_{ws})$$

where:

H_T =Net heating value of the sample, megaJoule per standard cubic meter, where the net enthalpy per mole of vent stream is based on combustion at 25 °C and 760 millimeters of mercury, but the standard temperature for determining the volume corresponding to one mole is 20 °C, as in the definition of Q_s (vent stream flow rate).

K_1 =Constant, 1.740×10^{-7} (parts per million)⁻¹(gram-mole per standard cubic meter) (megaJoule per kilocalorie), where standard temperature for (gram-mole per standard cubic meter) is 20 °C.

B_{ws} =Water vapor content of the vent stream, proportion by volume; except that if the vent stream passes through a final steam jet and is not condensed, it shall be assumed that B_{ws} =0.023 in order to correct to 2.3 percent moisture.

C_j =Concentration on a dry basis of compound j in parts per million, as measured for all organic compounds by Method 18 of 40 CFR part 60, appendix A and measured for hydrogen and carbon monoxide by American Society for Testing and Materials D1946-77 as indicated in paragraph (d)(2)(ii) of this section.

H_j =Net heat of combustion of compound j, kilocalorie per gram-mole, based on combustion at 25 °C and 760 millimeters mercury. The heats of combustion of vent stream components shall be determined using American Society for Testing and Materials D2382-76 if published

values are not available or cannot be calculated.

(iv) The emission rate of TOC (minus methane and ethane) (E_{TOC}) and the emission rate of total organic HAP (E_{HAP}) in the vent stream shall both be calculated using the following equation:

$$E = K_2 \left[\sum_{j=1}^n C_j M_j \right] Q_s$$

where:

E=Emission rate of TOC (minus methane and ethane) or emission rate of total organic HAP in the sample, kilograms per hour.

K_2 =Constant, 2.494×10^{-6} (parts per million)⁻¹(gram-mole per standard cubic meter) (kilogram/gram) (minutes/hour), where standard temperature for (gram-mole per standard cubic meter) is 20°C.

C_j =Concentration on a dry basis of organic compound j in parts per million as measured by Method 18 of 40 CFR part 60, appendix A as indicated in paragraph (d)(2)(ii) of this section. If the TOC emission rate is being calculated, C_j includes all organic compounds measured minus methane and ethane; if the total organic HAP emission rate is being calculated, only organic HAP compounds listed in table 2 in subpart F of this part are included.

M_j =Molecular weight of organic compound j, gram/gram-mole.

Q_s =Vent stream flow rate, dry standard cubic meter per minute, at a temperature of 20°C.

(v) In order to determine whether a vent stream is halogenated, the mass emission rate of halogen atoms contained in organic compounds shall be calculated.

(A) The vent stream concentration of each organic compound containing halogen atoms (parts per million by volume, by compound) shall be determined based on the following procedures:

- (1) Process knowledge that no halogen or hydrogen halides are present in the process, or
- (2) Applicable engineering assessment as discussed in paragraph (d)(1)(iii) of this section, or
- (3) Concentration of organic compounds containing halogens measured by Method 18 of 40 CFR part 60, appendix A, or
- (4) Any other method or data that has been validated according to the applicable procedures in Method 301 of appendix A of this part.

(B) The following equation shall be used to calculate the mass emission rate of halogen atoms:

$$E = K_2 Q \left(\sum_{j=1}^n \sum_{i=1}^m C_j * L_{j,i} * M_{j,i} \right)$$

where:

E=mass of halogen atoms, dry basis, kilogram per hour.

K_2 =Constant, 2.494×10^{-6} (parts per million)⁻¹(kilogram-mole per standard cubic meter) (minute/hour), where standard temperature is 20°C.

C_j =Concentration of halogenated compound j in the gas stream, dry basis, parts per million by volume.

M_{ji} =Molecular weight of halogen atom i in compound j of the gas stream, kilogram per kilogram-mole.

L_{ji} =Number of atoms of halogen i in compound j of the gas stream.

Q=Flow rate of gas stream, dry standard cubic meters per minute, determined according to paragraph (d)(1) or (d)(2)(i) of this section.

j=Halogenated compound j in the gas stream.

i=Halogen atom i in compound j of the gas stream.

n=Number of halogenated compounds j in the gas stream.

m=Number of different halogens i in each compound j of the gas stream.

(3) The owner or operator shall calculate the TRE index value of the vent stream using the equations and procedures in this paragraph.

(i) The equation for calculating the TRE index for a vent stream controlled by a flare or incinerator is as follows:

$$TRE = \frac{1}{E_{HAP}} [a + b(Q_s) + c(H_T) + d(E_{TOC})]$$

where:

TRE=TRE index value.

E_{HAP} =Hourly emission rate of total organic HAP, kilograms per hour, as calculated in paragraph (d)(1) or (d)(2)(iv) of this section.

Q_s =Vent stream flow rate, standard cubic meters per minute, at a standard temperature of 20 °C, as calculated in paragraph (d)(1) or (d)(2)(i) of this section.

H_T =Vent stream net heating value, megaJoules per standard cubic meter, as calculated in paragraph (d)(1) or (d)(2)(iii) of this section.

E_{TOC} =Emission rate of TOC (minus methane and ethane), kilograms per hour, as calculated in paragraph (d)(1) or (d)(2)(iv) of this section.

a,b,c,d=Coefficients presented in table 1 of this subpart, selected in accordance with paragraphs (d)(3)(ii) and (iii) of this section.

(ii) The owner or operator of a nonhalogenated vent stream shall calculate the TRE index value based on the use of a flare, a thermal incinerator with 0 percent heat recovery, and a thermal incinerator with

70 percent heat recovery and shall select the lowest TRE index value. The owner or operator shall use the applicable coefficients in table 1 of this subpart for nonhalogenated vent streams located within existing sources and the applicable coefficients in table 2 of this subpart for nonhalogenated vent streams located within new sources.

(iii) The owner or operator of a halogenated vent stream shall calculate the TRE index value based on the use of a thermal incinerator with 0 percent heat recovery, and a scrubber. The owner or operator shall use the applicable coefficients in table 1 of this subpart for halogenated vent streams located within existing sources and the applicable coefficients in table 2 of this subpart for halogenated vent streams located within new sources.

(e) The owner or operator of a Group 2 process vent shall recalculate the TRE index value, flow, or organic hazardous air pollutants concentration for each process vent, as necessary to determine whether the vent is Group 1 or Group 2, whenever process changes are made that could reasonably be expected to change the vent to a Group 1 vent. Examples of process changes include, but are not limited to, changes in production capacity, production rate, feedstock type, or catalyst type, or whenever there is replacement, removal, or addition of recovery equipment. For purposes of this paragraph, process changes do not include: Process upsets; unintentional, temporary process changes; and changes that are within the range on which the original TRE calculation was based.

(1) The TRE index value, flow rate, or organic HAP concentration shall be recalculated based on measurements of vent stream flow rate, TOC, and organic HAP concentrations, and heating values as specified in §63.115 (a), (b), (c), and (d) of this subpart, as applicable, or on best engineering assessment of the effects of the change. Engineering assessments shall meet the specifications in paragraph (d)(1) of this section.

(2) Where the recalculated TRE index value is less than or equal to 1.0, or less than or equal to 4.0 but greater than 1.0, the recalculated flow rate is greater than or equal to 0.005 standard cubic meter per minute, or the recalculated concentration is greater than or equal to 50 parts per million by volume, the owner or operator shall submit a report as specified in §63.118 (g), (h), (i), or (j) of this subpart and shall comply with the appropriate provisions in §63.113 of this subpart by the dates specified in §63.100 of subpart F of this part.

(f) Notwithstanding any other provisions of this subpart, in any case where a process vent includes one or more gas streams that are not from a source subject to this subpart (hereafter called "non-HON streams" for purposes of this paragraph), and one or more gas streams that meet the criteria in §63.107 (b) through (h) or the criteria in §63.107(i) (hereafter called "HON streams" for purposes of this paragraph), the owner or operator may elect to comply with paragraphs (f)(1) through (3) of this section.

(1) The owner or operator may determine the characteristics (flow rate, total organic HAP concentration, and TRE index value) for each HON stream, or combination of HON streams, at a representative point as near as practical to, but before, the point at which it is combined with one or more non-HON streams.

(2) If one or more of the HON streams, or combinations of HON streams, has the characteristics (determined at the location specified in paragraph (f)(1) of this section) associated with a Group 1 process vent, the combined vent stream is a Group 1 process vent. Except as specified in paragraph (f) (3) of this section, if none of the HON streams, or combinations of HON streams, when determined at the location specified in paragraph (f)(1) of this section, has the characteristics associated with a Group 1 process vent, the combined vent stream is a Group 2 process vent regardless of the TRE index value determined at the location specified in §63.115(a). If the combined vent stream is a Group 2 process vent as determined by the previous sentence, but one or more of the HON streams, or combinations of HON streams, has a TRE index value greater than 1 but less than or equal to 4, the combined vent stream is a process vent with a TRE index value greater than 1 but less than or equal to 4. In this case, the owner or operator shall monitor the combined vent stream as required by §63.114(b).

(3) Paragraphs (f)(1) and (2) of this section are not intended to apply instead of any other subpart of this part. If another subpart of this part applies to one or more of the non-HON streams contributing to the combined vent stream, that subpart may impose emission control requirements such as, but not limited to, requiring the combined vent stream to be classified and controlled as a Group 1 process vent.

[59 FR 19468, Apr. 22, 1994, as amended at 62 FR 2746, Jan. 17, 1997; 66 FR 6931, Jan. 22, 2001]

§ 63.116 Process vent provisions—performance test methods and procedures to determine compliance.

(a) When a flare is used to comply with §63.113(a)(1), the owner or operator shall comply with paragraphs (a)(1) through (3) of this section. The owner or operator is not required to conduct a performance test to determine percent emission reduction or outlet organic HAP or TOC concentration.

(1) Conduct a visible emission test using the techniques specified in §63.11(b)(4).

(2) Determine the net heating value of the gas being combusted using the techniques specified in §63.11(b)(6).

(3) Determine the exit velocity using the techniques specified in either §63.11(b)(7)(i) (and §63.11(b)(7)(iii), where applicable) or §63.11(b)(8), as appropriate.

(b) An owner or operator is not required to conduct a performance test when any control device specified in paragraphs (b)(1) through (b)(5) of this section is used.

(1) A boiler or process heater with a design heat input capacity of 44 megawatts or greater.

(2) A boiler or process heater into which the gas stream is introduced with the primary fuel or is used as the primary fuel.

(3) A control device for which a performance test was conducted for determining compliance with a regulation promulgated by the EPA and the test was conducted using the same methods specified in this section and either no process changes have been made since the test, or the owner or operator can demonstrate that the results of the performance test, with or without adjustments, reliably demonstrate compliance despite process changes.

(4) A boiler or process heater burning hazardous waste for which the owner or operator:

(i) Has been issued a final permit under 40 CFR part 270 and complies with the requirements of 40 CFR part 266, subpart H, or

(ii) Has certified compliance with the interim status requirements of 40 CFR part 266, subpart H.

(5) A hazardous waste incinerator for which the owner or operator has been issued a final permit under 40 CFR part 270 and complies with the requirements of 40 CFR part 264, subpart O, or has certified compliance with the interim status requirements of 40 CFR part 265, subpart O.

(c) Except as provided in paragraphs (a) and (b) of this section, an owner or operator using a control device to comply with the organic HAP concentration limit or percent reduction efficiency requirements in §63.113(a)(2) of this subpart shall conduct a performance test using the procedures in paragraphs (c)(1) through (c)(4) of this section. The organic HAP concentration and percent reduction may be measured as either total organic HAP or as TOC minus methane and ethane according to the procedures specified.

(1) Method 1 or 1A of 40 CFR part 60, appendix A, as appropriate, shall be used for selection of the sampling sites.

(i) For determination of compliance with the 98 percent reduction of total organic HAP requirement of §63.113(a)(2) of this subpart, sampling sites shall be located at the inlet of the control device as specified in paragraphs (c)(1)(i)(A) and (c)(1)(i)(B) of this section, and at the outlet of the control device.

(A) The control device inlet sampling site shall be located after the final product recovery device.

(B) If a vent stream is introduced with the combustion air or as a secondary fuel into a boiler or process heater with a design capacity less than 44 megawatts, selection of the location of the inlet sampling sites shall ensure the measurement of total organic HAP or TOC (minus methane and ethane) concentrations

in all vent streams and primary and secondary fuels introduced into the boiler or process heater.

(ii) For determination of compliance with the 20 parts per million by volume total organic HAP limit in §63.113(a)(2) of this subpart, the sampling site shall be located at the outlet of the control device.

(2) The gas volumetric flow rate shall be determined using Method 2, 2A, 2C, or 2D of 40 CFR part 60, appendix A, as appropriate.

(3) To determine compliance with the 20 parts per million by volume total organic HAP limit in §63.113(a)(2) of this subpart, the owner or operator shall use Method 18 of 40 CFR part 60, appendix A to measure either TOC minus methane and ethane or total organic HAP. Alternatively, any other method or data that has been validated according to the applicable procedures in Method 301 of appendix A of this part, may be used. The following procedures shall be used to calculate parts per million by volume concentration, corrected to 3 percent oxygen:

(i) The minimum sampling time for each run shall be 1 hour in which either an integrated sample or a minimum of four grab samples shall be taken. If grab sampling is used, then the samples shall be taken at approximately equal intervals in time, such as 15 minute intervals during the run.

(ii) The concentration of either TOC (minus methane or ethane) or total organic HAP shall be calculated according to paragraph (c)(3)(ii)(A) or (c)(3)(ii)(B) of this section.

(A) The TOC concentration (C_{TOC}) is the sum of the concentrations of the individual components and shall be computed for each run using the following equation:

$$C_{TOC} = \sum_{i=1}^x \frac{\left(\sum_{j=1}^n C_{ji} \right)}{x}$$

where:

C_{TOC} = Concentration of TOC (minus methane and ethane), dry basis, parts per million by volume.

C_{ji} = Concentration of sample components j of sample i , dry basis, parts per million by volume.

n = Number of components in the sample.

x = Number of samples in the sample run.

(B) The total organic HAP concentration (C_{HAP}) shall be computed according to the equation in paragraph (c)(3)(ii)(A) of this section except that only the organic HAP species shall be summed. The list of organic HAP's is provided in table 2 of subpart F of this part.

(iii) The concentration of TOC or total organic HAP shall be corrected to 3 percent oxygen if a combustion device is the control device.

(A) The emission rate correction factor or excess air, integrated sampling and analysis procedures of Method 3B of 40 CFR part 60, appendix A shall be used to determine the oxygen concentration ($\%O_{2d}$). The samples shall be taken during the same time that the TOC (minus methane or ethane) or total organic HAP samples are taken.

(B) The concentration corrected to 3 percent oxygen (C_c) shall be computed using the following equation:

$$C_c = C_m \left(\frac{17.9}{20.9 - \%O_{2d}} \right)$$

Where:

C_c = Concentration of TOC or organic HAP corrected to 3 percent oxygen, dry basis, parts per million by volume.

C_m = Concentration of TOC (minus methane and ethane) or organic HAP, dry basis, parts per million by volume.

$\%O_{2d}$ = Concentration of oxygen, dry basis, percent by volume.

(4) To determine compliance with the 98 percent reduction requirement of §63.113(a)(2) of this subpart, the owner or operator shall use Method 18 of 40 CFR part 60, appendix A; alternatively, any other method or data that has been validated according to the applicable procedures in Method 301 of appendix A of this part may be used. The following procedures shall be used to calculate percent reduction efficiency:

(i) The minimum sampling time for each run shall be 1 hour in which either an integrated sample or a minimum of four grab samples shall be taken. If grab sampling is used, then the samples shall be taken at approximately equal intervals in time such as 15 minute intervals during the run.

(ii) The mass rate of either TOC (minus methane and ethane) or total organic HAP (E_i , E_o) shall be computed.

(A) The following equations shall be used:

$$E_i = K_2 \left(\sum_{j=1}^n C_{ij} M_{ij} \right) Q_i \quad E_o = K_2 \left(\sum_{j=1}^n C_{oj} M_{oj} \right) Q_o$$

where:

C_{ij} , C_{oj} = Concentration of sample component j of the gas stream at the inlet and outlet of the control device, respectively, dry basis, parts per million by volume.

E_i , E_o = Mass rate of TOC (minus methane and ethane) or total organic HAP at the inlet and outlet of the control device, respectively, dry basis, kilogram per hour.

M_{ij} , M_{oj} = Molecular weight of sample component j of the gas stream at the inlet and outlet of the control device, respectively, gram/gram-mole.

Q_i , Q_o = Flow rate of gas stream at the inlet and outlet of the control device, respectively, dry standard cubic meter per minute.

K_2 = Constant, $2.494 \times 10^{-6}(\text{parts per million})^{-1}(\text{gram-mole per standard cubic meter})$ (kilogram/gram) (minute/hour), where standard temperature (gram-mole per standard cubic meter) is 20 °C.

(B) Where the mass rate of TOC is being calculated, all organic compounds (minus methane and ethane) measured by Method 18 of 40 CFR part 60, appendix A are summed using the equation in

paragraph (c)(4)(ii)(A) of this section.

(C) Where the mass rate of total organic HAP is being calculated, only the organic HAP species shall be summed using the equation in paragraph (c)(4)(ii)(A) of this section. The list of organic HAP's is provided in table 2 of subpart F of this part.

(iii) The percent reduction in TOC (minus methane and ethane) or total organic HAP shall be calculated as follows:

$$R = \frac{E_i - E_o}{E_i} (100)$$

where:

R=Control efficiency of control device, percent.

E_i =Mass rate of TOC (minus methane and ethane) or total organic HAP at the inlet to the control device as calculated under paragraph (c)(4)(ii) of this section, kilograms TOC per hour or kilograms organic HAP per hour.

E_o =Mass rate of TOC (minus methane and ethane) or total organic HAP at the outlet of the control device, as calculated under paragraph (c)(4)(ii) of this section, kilograms TOC per hour or kilograms organic HAP per hour.

(iv) If the vent stream entering a boiler or process heater with a design capacity less than 44 megawatts is introduced with the combustion air or as a secondary fuel, the weight-percent reduction of total organic HAP or TOC (minus methane and ethane) across the device shall be determined by comparing the TOC (minus methane and ethane) or total organic HAP in all combusted vent streams and primary and secondary fuels with the TOC (minus methane and ethane) or total organic HAP exiting the combustion device, respectively.

(d) An owner or operator using a combustion device followed by a scrubber or other halogen reduction device to control halogenated vent streams in compliance with §63.113(c)(1) shall conduct a performance test to determine compliance with the control efficiency or emission limits for hydrogen halides and halogens.

(1) For an owner or operator determining compliance with the percent reduction of total hydrogen halides and halogens, sampling sites shall be located at the inlet and outlet of the scrubber or other halogen reduction device used to reduce halogen emissions. For an owner or operator determining compliance with the less than 0.45 kilogram per hour outlet emission limit for total hydrogen halides and halogens, the sampling site shall be located at the outlet of the scrubber or other halogen reduction device and prior to any releases to the atmosphere.

(2) Except as provided in paragraph (d)(5) of this section, Method 26 or Method 26A of 40 CFR part 60, appendix A, shall be used to determine the concentration, in milligrams per dry standard cubic meter, of total hydrogen halides and halogens that may be present in the vent stream. The mass emissions of each hydrogen halide and halogen compound shall be calculated from the measured concentrations and the gas stream flow rate.

(3) To determine compliance with the percent removal efficiency, the mass emissions for any hydrogen halides and halogens present at the inlet of the scrubber or other halogen reduction device shall be summed together. The mass emissions of the compounds present at the outlet of the scrubber or other halogen reduction device shall be summed together. Percent reduction shall be determined by comparison of the summed inlet and outlet measurements.

(4) To demonstrate compliance with the less than 0.45 kilogram per hour outlet emission limit, the test results must show that the mass emission rate of total hydrogen halides and halogens measured at the outlet of the scrubber or other halogen reduction device is below 0.45 kilogram per hour.

(5) The owner or operator may use any other method to demonstrate compliance if the method or data has been validated according to the applicable procedures of Method 301 of appendix A of this part.

(e) An owner or operator using a scrubber or other halogen reduction device to reduce the vent stream halogen atom mass emission rate to less than 0.45 kilogram per hour prior to a combustion control device in compliance with §63.113(c)(2) of this subpart shall determine the halogen atom mass emission rate prior to the combustor according to the procedures in §63.115(d)(2)(v) of this subpart.

[59 FR 19468, Apr. 22, 1994, as amended at 62 FR 2746, Jan. 17, 1997; 64 FR 20191, Apr. 26, 1999; 66 FR 6931, Jan. 22, 2001]

§ 63.117 Process vent provisions—reporting and recordkeeping requirements for group and TRE determinations and performance tests.

(a) Each owner or operator subject to the control provisions for Group 1 process vents in §63.113(a) or the provisions for Group 2 process vents with a TRE index value greater than 1.0 but less than or equal to 4.0 in §63.113(d) shall:

(1) Keep an up-to-date, readily accessible record of the data specified in paragraphs (a)(4) through (a)(8) of this section, as applicable, and

(2) Include the data in paragraphs (a)(4) through (a)(8) of this section in the Notification of Compliance Status report as specified in §63.152(b) of this subpart.

(3) If any subsequent TRE determinations or performance tests are conducted after the Notification of Compliance Status has been submitted, report the data in paragraphs (a)(4) through (a)(8) of this section in the next Periodic Report as specified in §63.152(c) of this subpart.

(4) Record and report the following when using a combustion device to achieve a 98 weight percent reduction in organic HAP or an organic HAP concentration of 20 parts per million by volume, as specified in §63.113(a)(2) of this subpart:

(i) The parameter monitoring results for incinerators, catalytic incinerators, boilers or process heaters specified in table 3 of this subpart, and averaged over the same time period of the performance testing.

(ii) For an incinerator, the percent reduction of organic HAP or TOC achieved by the incinerator determined as specified in §63.116(c) of this subpart, or the concentration of organic HAP or TOC (parts per million by volume, by compound) determined as specified in §63.116(c) of this subpart at the outlet of the incinerator on a dry basis corrected to 3 percent oxygen.

(iii) For a boiler or process heater, a description of the location at which the vent stream is introduced into the boiler or process heater.

(iv) For a boiler or process heater with a design heat input capacity of less than 44 megawatts and where the vent stream is introduced with combustion air or used as a secondary fuel and is not mixed with the primary fuel, the percent reduction of organic HAP or TOC, or the concentration of organic HAP or TOC (parts per million by volume, by compound) determined as specified in §63.116(c) at the outlet of the combustion device on a dry basis corrected to 3 percent oxygen.

(5) Record and report the following when using a flare to comply with §63.113(a)(1) of this subpart:

(i) Flare design (i.e., steam-assisted, air-assisted, or non-assisted);

(ii) All visible emission readings, heat content determinations, flow rate measurements, and exit velocity determinations made during the compliance determination required by §63.116(a) of this subpart; and

(iii) All periods during the compliance determination when the pilot flame is absent.

(6) Record and report the following when using a scrubber following a combustion device to control a

halogenated vent stream:

(i) The percent reduction or scrubber outlet mass emission rate of total hydrogen halides and halogens as specified in §63.116(d) of this subpart;

(ii) The pH of the scrubber effluent; and

(iii) The scrubber liquid to gas ratio.

(7) Record and report the following when achieving and maintaining a TRE index value greater than 1.0 but less than 4.0 as specified in §63.113(a)(3) or §63.113(d) of this subpart:

(i) The parameter monitoring results for absorbers, condensers, or carbon adsorbers, as specified in table 4 of this subpart, and averaged over the same time period of the measurements of vent stream flow rate and concentration used in the TRE determination (both measured while the vent stream is normally routed and constituted), and

(ii) The measurements and calculations performed to determine the TRE index value of the vent stream.

(8) Record and report the halogen concentration in the vent stream determined according to the procedures specified in §63.115(d)(2)(v).

(b) The owner or operator of a Group 2 process vent with a TRE index greater than 4.0 as specified in §63.113(e) of this subpart, shall maintain records and submit as part of the Notification of Compliance Status specified in §63.152 of this subpart, measurements, engineering assessments, and calculations performed to determine the TRE index value of the vent stream. Documentation of engineering assessments shall include all data, assumptions, and procedures used for the engineering assessments, as specified in §63.115(d)(1) of this subpart.

(c) Each owner or operator who elects to demonstrate that a process vent is a Group 2 process vent based on a flow rate less than 0.005 standard cubic meter per minute must submit to the Administrator the flow rate measurement using methods and procedures specified in §63.115 (a) and (b) of this subpart with the Notification of Compliance Status specified in §63.152 of this subpart.

(d) Each owner or operator who elects to demonstrate that a process vent is a Group 2 process vent based on organic HAP or TOC concentration less than 50 parts per million by volume must submit to the Administrator an organic HAP or TOC concentration measurement using the methods and procedures specified in §63.115 (a) and (c) of this subpart with the Notification of Compliance Status specified in §63.152 of this subpart.

(e) If an owner or operator uses a control or recovery device other than those listed in tables 3 and 4 of this subpart or requests approval to monitor a parameter other than those specified in tables 3 and 4 of this subpart, the owner or operator shall submit a description of planned reporting and recordkeeping procedures as required under §63.151(f) or §63.152(e) of this subpart. The Administrator will specify appropriate reporting and recordkeeping requirements as part of the review of the permit application or by other appropriate means.

(f) For each parameter monitored according to tables 3 or 4 of this subpart or paragraph (e) of this section, the owner or operator shall establish a range for the parameter that indicates proper operation of the control or recovery device. In order to establish the range, the information required in §63.152(b) of this subpart shall be submitted in the Notification of Compliance Status or the operating permit application or amendment.

[59 FR 19468, Apr. 22, 1994, as amended at 61 FR 64576, Dec. 5, 1996; 66 FR 6932, Jan. 22, 2001]

§ 63.118 Process vent provisions—periodic reporting and recordkeeping requirements.

(a) Each owner or operator using a control device to comply with §63.113 (a)(1) or (a)(2) of this subpart shall keep the following records up-to-date and readily accessible:

(1) Continuous records of the equipment operating parameters specified to be monitored under §63.114(a) of this subpart and listed in table 3 of this subpart or specified by the Administrator in accordance with §63.114(c) and §63.117(e) of this subpart. For flares, the hourly records and records of pilot flame outages specified in table 3 of this subpart shall be maintained in place of continuous records.

(2) Records of the daily average value of each continuously monitored parameter for each operating day determined according to the procedures specified in §63.152(f). For flares, records of the times and duration of all periods during which all pilot flames are absent shall be kept rather than daily averages.

(3) Hourly records of whether the flow indicator specified under §63.114(d)(1) was operating and whether a diversion was detected at any time during the hour, as well as records of the times and durations of all periods when the gas stream is diverted to the atmosphere or the monitor is not operating.

(4) Where a seal mechanism is used to comply with §63.114(d)(2) of this subpart, hourly records of flow are not required. In such cases, the owner or operator shall record that the monthly visual inspection of the seals or closure mechanism has been done, and shall record the duration of all periods when the seal mechanism is broken, the bypass line valve position has changed, or the key for a lock-and-key type lock has been checked out, and records of any car-seal that has broken.

(b) Each owner or operator using a recovery device or other means to achieve and maintain a TRE index value greater than 1.0 but less than 4.0 as specified in §63.113(a)(3) or §63.113(d) of this subpart shall keep the following records up-to-date and readily accessible:

(1) Continuous records of the equipment operating parameters specified to be monitored under §63.114(b) of this subpart and listed in table 4 of this subpart or specified by the Administrator in accordance with §63.114(c) of this subpart and §63.114(e) of this subpart and

(2) Records of the daily average value of each continuously monitored parameter for each operating day determined according to the procedures specified in §63.152(f). If carbon adsorber regeneration stream flow and carbon bed regeneration temperature are monitored, the records specified in table 4 of this subpart shall be kept instead of the daily averages.

(c) Each owner or operator subject to the provisions of this subpart and who elects to demonstrate compliance with the TRE index value greater than 4.0 under §63.113(e) of this subpart or greater than 1.0 under §63.113(a)(3) or §63.113(d) of this subpart shall keep up-to-date, readily accessible records of:

(1) Any process changes as defined in §63.115(e) of this subpart; and

(2) Any recalculation of the TRE index value pursuant to §63.115(e) of this subpart.

(d) Each owner or operator who elects to comply by maintaining a flow rate less than 0.005 standard cubic meter per minute under §63.113(f) of this subpart, shall keep up-to-date, readily accessible records of:

(1) Any process changes as defined in §63.115(e) of this subpart that increase the vent stream flow rate,

(2) Any recalculation or measurement of the flow rate pursuant to §63.115(e) of this subpart, and

(3) If the flow rate increases to 0.005 standard cubic meter per minute or greater as a result of the process change, the TRE determination performed according to the procedures of §63.115(d) of this subpart.

(e) Each owner or operator who elects to comply by maintaining an organic HAP concentration less than 50 parts per million by volume organic HAP concentration under §63.113(g) of this subpart shall keep up-to-date, readily accessible records of:

(1) Any process changes as defined in §63.115(e) that increase the organic HAP concentration of the vent stream,

- (2) Any recalculation or measurement of the concentration pursuant to §63.115(e) of this subpart, and
- (3) If the organic HAP concentration increases to 50 parts per million by volume or greater as a result of the process change, the TRE determination performed according to the procedures of §63.115(d) of this subpart.
- (f) Each owner or operator who elects to comply with the requirements of §63.113 of this subpart shall submit to the Administrator Periodic Reports of the following recorded information according to the schedule in §63.152 of this subpart.
- (1) Reports of daily average values of monitored parameters for all operating days when the daily average values recorded under paragraphs (a) and (b) of this section were outside the ranges established in the Notification of Compliance Status or operating permit.
- (2) For Group 1 points, reports of the duration of periods when monitoring data is not collected for each excursion caused by insufficient monitoring data as defined in §63.152(c)(2)(ii)(A) of this subpart.
- (3) Reports of the times and durations of all periods recorded under paragraph (a)(3) of this section when the gas stream is diverted to the atmosphere through a bypass line.
- (4) Reports of all periods recorded under paragraph (a)(4) of this section in which the seal mechanism is broken, the bypass line valve position has changed, or the key to unlock the bypass line valve was checked out.
- (5) Reports of the times and durations of all periods recorded under paragraph (a)(2) of this section in which all pilot flames of a flare were absent.
- (6) Reports of all carbon bed regeneration cycles during which the parameters recorded under paragraph (b)(2)(v) of this section were outside the ranges established in the Notification of Compliance Status or operating permit.
- (g) Whenever a process change, as defined in §63.115(e) of this subpart, is made that causes a Group 2 process vent to become a Group 1 process vent, the owner or operator shall submit a report within 180 calendar days after the process change as specified in §63.151(j) of this subpart. The report shall include:
- (1) A description of the process change;
- (2) The results of the recalculation of the flow rate, organic HAP concentration, and TRE index value required under §63.115(e) of this subpart and recorded under paragraph (c), (d), or (e) of this section; and
- (3) A statement that the owner or operator will comply with the provisions of §63.113 of this subpart for Group 1 process vents by the dates specified in subpart F of this part.
- (h) Whenever a process change, as defined in §63.115(e) of this subpart, is made that causes a Group 2 process vent with a TRE greater than 4.0 to become a Group 2 process vent with a TRE less than 4.0, the owner or operator shall submit a report within 180 calendar days after the process change. The report may be submitted as part of the next periodic report. The report shall include:
- (1) A description of the process change,
- (2) The results of the recalculation of the TRE index value required under §63.115(e) of this subpart and recorded under paragraph (c) of this section, and
- (3) A statement that the owner or operator will comply with the requirements specified in §63.113(d) of this subpart.
- (i) Whenever a process change, as defined in §63.115(e) of this subpart, is made that causes a Group 2

process vent with a flow rate less than 0.005 standard cubic meter per minute to become a Group 2 process vent with a flow rate of 0.005 standard cubic meter per minute or greater and a TRE index value less than or equal to 4.0, the owner or operator shall submit a report within 180 calendar days after the process change. The report may be submitted as part of the next periodic report. The report shall include:

- (1) A description of the process change,
- (2) The results of the recalculation of the flow rate and the TRE determination required under §63.115(e) of this subpart and recorded under paragraph (d) of this section, and
- (3) A statement that the owner or operator will comply with the requirements specified in §63.113(d) of this subpart.

(j) Whenever a process change, as defined in §63.115(e) of this subpart, is made that causes a Group 2 process vent with an organic HAP concentration less than 50 parts per million by volume to become a Group 2 process vent with an organic HAP concentration of 50 parts per million by volume or greater and a TRE index value less than or equal to 4.0, the owner or operator shall submit a report within 180 calendar days after the process change. The report may be submitted as part of the next periodic report. The report shall include:

- (1) A description of the process change,
- (2) The results of the recalculation of the organic HAP concentration and the TRE determination required under §63.115(e) of this subpart and recorded under paragraph (e) of this section, and
- (3) A statement that the owner or operator will comply with the requirements specified in §63.113(d) of this subpart.

(k) The owner or operator is not required to submit a report of a process change if one of the conditions listed in paragraph (k)(1), (k)(2), (k)(3), or (k)(4) of this section is met.

- (1) The process change does not meet the definition of a process change in §63.115(e) of this subpart, or
- (2) The vent stream flow rate is recalculated according to §63.115(e) of this subpart and the recalculated value is less than 0.005 standard cubic meter per minute, or
- (3) The organic HAP concentration of the vent stream is recalculated according to §63.115(e) of this subpart and the recalculated value is less than 50 parts per million by volume, or
- (4) The TRE index value is recalculated according to §63.115(e) of this subpart and the recalculated value is greater than 4.0.

[59 FR 19468, Apr. 22, 1994, as amended at 62 FR 2747, Jan. 17, 1997; 66 FR 6932, Jan. 22, 2001]

§ 63.119 Storage vessel provisions—reference control technology.

(a) For each storage vessel to which this subpart applies, the owner or operator shall comply with the requirements of paragraphs (a)(1), (a)(2), (a)(3), and (a)(4) of this section according to the schedule provisions of §63.100 of subpart F of this part.

(1) For each Group 1 storage vessel (as defined in table 5 of this subpart for existing sources and table 6 of the subpart for new sources) storing a liquid for which the maximum true vapor pressure of the total organic hazardous air pollutants in the liquid is less than 76.6 kilopascals, the owner or operator shall reduce hazardous air pollutants emissions to the atmosphere either by operating and maintaining a fixed roof and internal floating roof, an external floating roof, an external floating roof converted to an internal floating roof, a closed vent system and control device, routing the emissions to a process or a fuel gas system, or vapor balancing in accordance with the requirements in paragraph (b), (c), (d), (e), (f), or (g) of this section, or equivalent as provided in §63.121 of this subpart.

(2) For each Group 1 storage vessel (as defined in table 5 of this subpart for existing sources and table 6 of this subpart for new sources) storing a liquid for which the maximum true vapor pressure of the total organic hazardous air pollutants in the liquid is greater than or equal to 76.6 kilopascals, the owner or operator shall operate and maintain a closed vent system and control device meeting the requirements specified in paragraph (e) of this section, route the emissions to a process or a fuel gas system as specified in paragraph (f) of this section, vapor balance as specified in paragraph (g) of this section, or equivalent as provided in §63.121 of this subpart.

(3) For each Group 2 storage vessel that is not part of an emissions average as described in §63.150 of this subpart, the owner or operator shall comply with the recordkeeping requirement in §63.123(a) of this subpart and is not required to comply with any other provisions in §§63.119 through 63.123 of this subpart.

(4) For each Group 2 storage vessel that is part of an emissions average, the owner or operator shall comply with the emissions averaging provisions in §63.150 of this subpart.

(b) The owner or operator who elects to use a fixed roof and an internal floating roof, as defined in §63.111 of this subpart, to comply with the requirements of paragraph (a)(1) of this section shall comply with the requirements specified in paragraphs (b)(1) through (b)(6) of this section.

Note: The intent of paragraphs (b)(1) and (b)(2) of this section is to avoid having a vapor space between the floating roof and the stored liquid for extended periods. Storage vessels may be emptied for purposes such as routine storage vessel maintenance, inspections, petroleum liquid deliveries, or transfer operations. Storage vessels where liquid is left on walls, as bottom clingage, or in pools due to floor irregularity are considered completely empty.

(1) The internal floating roof shall be floating on the liquid surface at all times except when the floating roof must be supported by the leg supports during the periods specified in paragraphs (b)(1)(i) through (b)(1)(iii) of this section.

(i) During the initial fill.

(ii) After the vessel has been completely emptied and degassed.

(iii) When the vessel is completely emptied before being subsequently refilled.

(2) When the floating roof is resting on the leg supports, the process of filling, emptying, or refilling shall be continuous and shall be accomplished as soon as practical.

(3) Each internal floating roof shall be equipped with a closure device between the wall of the storage vessel and the roof edge. Except as provided in paragraph (b)(3)(iv) of this section, the closure device shall consist of one of the devices listed in paragraph (b)(3)(i), (b)(3)(ii), or (b)(3)(iii) of this section.

(i) A liquid-mounted seal as defined in §63.111 of this subpart.

(ii) A metallic shoe seal as defined in §63.111 of this subpart.

(iii) Two seals mounted one above the other so that each forms a continuous closure that completely covers the space between the wall of the storage vessel and the edge of the internal floating roof. The lower seal may be vapor-mounted, but both must be continuous seals.

(iv) If the internal floating roof is equipped with a vapor-mounted seal as of December 31, 1992, the requirement for one of the seal options specified in paragraphs (b)(3)(i), (b)(3)(ii), and (b)(3)(iii) of this section does not apply until the earlier of the dates specified in paragraphs (b)(3)(iv)(A) and (b)(3)(iv)(B) of this section.

(A) The next time the storage vessel is emptied and degassed.

(B) No later than 10 years after April 22, 1994.

(4) Automatic bleeder vents are to be closed at all times when the roof is floating, except when the roof is being floated off or is being landed on the roof leg supports.

(5) Except as provided in paragraph (b)(5)(viii) of this section, each internal floating roof shall meet the specifications listed in paragraphs (b)(5)(i) through (b)(5)(vii) of this section.

(i) Each opening in a noncontact internal floating roof except for automatic bleeder vents (vacuum breaker vents) and rim space vents is to provide a projection below the liquid surface.

(ii) Each opening in the internal floating roof except for leg sleeves, automatic bleeder vents, rim space vents, column wells, ladder wells, sample wells, and stub drains shall be equipped with a cover or lid. The cover or lid shall be equipped with a gasket.

(iii) Each penetration of the internal floating roof for the purposes of sampling shall be a sample well. Each sample well shall have a slit fabric cover that covers at least 90 percent of the opening.

(iv) Each automatic bleeder vent shall be gasketed.

(v) Each rim space vent shall be gasketed.

(vi) Each penetration of the internal floating roof that allows for passage of a ladder shall have a gasketed sliding cover.

(vii) Each penetration of the internal floating roof that allows for passage of a column supporting the fixed roof shall have a flexible fabric sleeve seal or a gasketed sliding cover.

(viii) If the internal floating roof does not meet any one of the specifications listed in paragraphs (b)(5)(i) through (b)(5)(vii) of this section as of December 31, 1992, the requirement for meeting those specifications does not apply until the earlier of the dates specified in paragraphs (b)(5)(viii)(A) and (b)(5)(viii)(B) of this section.

(A) The next time the storage vessel is emptied and degassed.

(B) No later than 10 years after April 22, 1994.

(6) Each cover or lid on any opening in the internal floating roof shall be closed (i.e., no visible gaps), except when the cover or lid must be open for access. Covers on each access hatch and each gauge float well shall be bolted or fastened so as to be air-tight when they are closed. Rim space vents are to be set to open only when the internal floating roof is not floating or when the pressure beneath the rim seal exceeds the manufacturer's recommended setting.

(c) The owner or operator who elects to use an external floating roof, as defined in §63.111 of this subpart, to comply with the requirements of paragraph (a)(1) of this section shall comply with the requirements specified in paragraphs (c)(1) through (c)(4) of this section.

(1) Each external floating roof shall be equipped with a closure device between the wall of the storage vessel and the roof edge.

(i) Except as provided in paragraph (c)(1)(iv) of this section, the closure device is to consist of two seals, one above the other. The lower seal is referred to as the primary seal and the upper seal is referred to as the secondary seal.

(ii) Except as provided in paragraph (c)(1)(v) of this section, the primary seal shall be either a metallic shoe seal or a liquid-mounted seal.

(iii) Except during the inspections required by §63.120(b) of this subpart, both the primary seal and the secondary seal shall completely cover the annular space between the external floating roof and the wall

of the storage vessel in a continuous fashion.

(iv) If the external floating roof is equipped with a liquid-mounted or metallic shoe primary seal as of December 31, 1992, the requirement for a secondary seal in paragraph (c)(1)(i) of this section does not apply until the earlier of the dates specified in paragraphs (c)(1)(iv)(A) and (c)(1)(iv)(B) of this section.

(A) The next time the storage vessel is emptied and degassed.

(B) No later than 10 years after April 22, 1994.

(v) If the external floating roof is equipped with a vapor-mounted primary seal and a secondary seal as of December 31, 1992, the requirement for a liquid-mounted or metallic shoe primary seal in paragraph (c)(1)(ii) of this section does not apply until the earlier of the dates specified in paragraphs (c)(1)(v)(A) and (c)(1)(v)(B) of this section.

(A) The next time the storage vessel is emptied and degassed.

(B) No later than 10 years after April 22, 1994.

(2) Each external floating roof shall meet the specifications listed in paragraphs (c)(2)(i) through (c)(2)(xii) of this section.

(i) Except for automatic bleeder vents (vacuum breaker vents) and rim space vents, each opening in the noncontact external floating roof shall provide a projection below the liquid surface except as provided in paragraph (c)(2)(xii) of this section.

(ii) Except for automatic bleeder vents, rim space vents, roof drains, and leg sleeves, each opening in the roof is to be equipped with a gasketed cover, seal or lid which is to be maintained in a closed position (i.e., no visible gap) at all times except when the cover or lid must be open for access. Covers on each access hatch and each gauge float well shall be bolted or fastened so as to be air-tight when they are closed.

(iii) Automatic bleeder vents are to be closed at all times when the roof is floating, except when the roof is being floated off or is being landed on the roof leg supports.

(iv) Rim space vents are to be set to open only when the roof is being floated off the roof leg supports or when the pressure beneath the rim seal exceeds the manufacturer's recommended setting.

(v) Automatic bleeder vents and rim space vents are to be gasketed.

(vi) Each roof drain that empties into the stored liquid is to be provided with a slotted membrane fabric cover that covers at least 90 percent of the area of the opening.

(vii) Each unslotted guide pole well shall have a gasketed sliding cover or a flexible fabric sleeve seal.

(viii) Each unslotted guide pole shall have on the end of the pole a gasketed cap which is closed at all times except when gauging the liquid level or taking liquid samples.

(ix) Each slotted guide pole well shall have a gasketed sliding cover or a flexible fabric sleeve seal.

(x) Each slotted guide pole shall have a gasketed float or other device which closes off the liquid surface from the atmosphere.

(xi) Each gauge hatch/sample well shall have a gasketed cover which is closed at all times except when the hatch or well must be open for access.

(xii) If each opening in a noncontact external floating roof except for automatic bleeder vents (vacuum breaker vents) and rim space vents does not provide a projection below the liquid surface as of

December 31, 1992, the requirement for providing these projections below the liquid surface does not apply until the earlier of the dates specified in paragraphs (c)(2)(xii)(A) and (c)(2)(xii)(B) of this section.

(A) The next time the storage vessel is emptied and degassed.

(B) No later than 10 years after April 22, 1994.

Note: The intent of paragraphs (c)(3) and (c)(4) of this section is to avoid having a vapor space between the floating roof and the stored liquid for extended periods. Storage vessels may be emptied for purposes such as routine storage vessel maintenance, inspections, petroleum liquid deliveries, or transfer operations. Storage vessels where liquid is left on walls, as bottom clingage, or in pools due to floor irregularity are considered completely empty.

(3) The external floating roof shall be floating on the liquid surface at all times except when the floating roof must be supported by the leg supports during the periods specified in paragraphs (c)(3)(i) through (c)(3)(iii) of this section.

(i) During the initial fill.

(ii) After the vessel has been completely emptied and degassed.

(iii) When the vessel is completely emptied before being subsequently refilled.

(4) When the floating roof is resting on the leg supports, the process of filling, emptying, or refilling shall be continuous and shall be accomplished as soon as practical.

(d) The owner or operator who elects to use an external floating roof converted to an internal floating roof (i.e., fixed roof installed above external floating roof) to comply with paragraph (a)(1) of this section shall comply with paragraphs (d)(1) and (d)(2) of this section.

(1) Comply with the requirements for internal floating roof vessels specified in paragraphs (b)(1), (2), and (3) of this section; and

(2) Comply with the requirements for deck fittings that are specified for external floating roof vessels in paragraphs (c)(2)(i) through (c)(2)(xii) of this section.

(e) The owner or operator who elects to use a closed vent system and control device, as defined in §63.111 of this subpart, to comply with the requirements of paragraph (a)(1) or (a)(2) of this section shall comply with the requirements specified in paragraphs (e)(1) through (e)(5) of this section.

(1) Except as provided in paragraph (e)(2) of this section, the control device shall be designed and operated to reduce inlet emissions of total organic HAP by 95 percent or greater. If a flare is used as the control device, it shall meet the specifications described in the general control device requirements of §63.11(b) of subpart A of this part.

(2) If the owner or operator can demonstrate that a control device installed on a storage vessel on or before December 31, 1992 is designed to reduce inlet emissions of total organic HAP by greater than or equal to 90 percent but less than 95 percent, then the control device is required to be operated to reduce inlet emissions of total organic HAP by 90 percent or greater.

(3) Periods of planned routine maintenance of the control device, during which the control device does not meet the specifications of paragraph (e)(1) or (e)(2) of this section, as applicable, shall not exceed 240 hours per year.

(4) The specifications and requirements in paragraphs (e)(1) and (e)(2) of this section for control devices do not apply during periods of planned routine maintenance.

(5) The specifications and requirements in paragraphs (e)(1) and (e)(2) of this section for control devices

do not apply during a control system malfunction.

(6) An owner or operator may use a combination of control devices to achieve the required reduction of total organic hazardous air pollutants specified in paragraph (e)(1) of this section. An owner or operator may use a combination of control devices installed on a storage vessel on or before December 31, 1992 to achieve the required reduction of total organic hazardous air pollutants specified in paragraph (e)(2) of this section.

(f) The owner or operator who elects to route emissions to a fuel gas system or to a process, as defined in §63.111 of this subpart, to comply with the requirements of paragraph (a)(1) or (a)(2) of this section shall comply with the requirements in paragraphs (f)(1) through (f)(3) of this section, as applicable.

(1) If emissions are routed to a fuel gas system, there is no requirement to conduct a performance test or design evaluation. If emissions are routed to a process, the organic hazardous air pollutants in the emissions shall predominantly meet one of, or a combination of, the ends specified in paragraphs (f)(1)(i) through (f)(1)(iv) of this section. The owner or operator shall comply with the compliance demonstration requirements in §63.120(f).

(i) Recycled and/or consumed in the same manner as a material that fulfills the same function in that process;

(ii) Transformed by chemical reaction into materials that are not organic hazardous air pollutants;

(iii) Incorporated into a product; and/or

(iv) Recovered.

(2) If the emissions are conveyed by a system other than hard-piping, any conveyance system operated under positive pressure shall be subject to the requirements of §63.148 of this subpart.

(3) The fuel gas system or process shall be operating at all times when organic hazardous air pollutants emissions are routed to it except as provided in §63.102(a)(1) of subpart F of this part and in paragraphs (f)(3)(i) through (f)(3)(iii) of this section. Whenever the owner or operator by-passes the fuel gas system or process, the owner or operator shall comply with the recordkeeping requirement in §63.123(h) of this subpart. Bypassing is permitted if the owner or operator complies with one or more of the conditions specified in paragraphs (f)(3)(i) through (f)(3)(iii) of this section.

(i) The liquid level in the storage vessel is not increased;

(ii) The emissions are routed through a closed-vent system to a control device complying with §63.119 (e) of this subpart; or

(iii) The total aggregate amount of time during which the emissions by-pass the fuel gas system or process during the calendar year without being routed to a control device, for all reasons (except start-ups/shutdowns/malfunctions or product changeovers of flexible operation units and periods when the storage vessel has been emptied and degassed), does not exceed 240 hours.

(g) The owner or operator who elects to vapor balance to comply with the requirements of paragraphs (a)(1) and (2) of this section shall comply with paragraphs (g)(1) through (7) of this section and the recordkeeping requirements of §63.123(i).

(1) The vapor balancing system must be designed and operated to route organic HAP vapors displaced from loading of the storage tank to the railcar, tank truck, or barge from which the storage tank is filled.

(2) Tank trucks and railcars must have a current certification in accordance with the U.S. Department of Transportation pressure test requirements of 49 CFR part 180 for tank trucks and 49 CFR 173.31 for railcars. Barges must have a current certification of vapor-tightness through testing in accordance with 40 CFR 63.565.

(3) Hazardous air pollutants must only be unloaded from tank trucks or railcars when vapor collection

systems are connected to the storage tank's vapor collection system.

(4) No pressure relief device on the storage tank, or on the railcar or tank truck, shall open during loading or as a result of diurnal temperature changes (breathing losses).

(5) Pressure relief devices must be set to no less than 2.5 psig at all times to prevent breathing losses. Pressure relief devices may be set at values less than 2.5 psig if the owner or operator provides rationale in the notification of compliance status report explaining why the alternative value is sufficient to prevent breathing losses at all times. The owner or operator shall comply with paragraphs (g)(5)(i) through (iii) of this section for each pressure relief valve.

(i) The pressure relief valve shall be monitored quarterly using the method described in §63.180(b).

(ii) An instrument reading of 500 ppmv or greater defines a leak.

(iii) When a leak is detected, it shall be repaired as soon as practicable, but no later than 5 days after it is detected, and the owner or operator shall comply with the recordkeeping requirements of §63.181(d) (1) through (4).

(6) Railcars, tank trucks, or barges that deliver HAP to a storage tank must be reloaded or cleaned at a facility that utilizes the control techniques specified in paragraph (g)(6)(i) or (ii) of this section.

(i) The railcar, tank truck, or barge must be connected to a closed-vent system with a control device that reduces inlet emissions of HAP by 95 percent by weight or greater.

(ii) A vapor balancing system designed and operated to collect organic HAP vapor displaced from the tank truck, railcar, or barge during reloading must be used to route the collected HAP vapor to the storage tank from which the liquid being transferred originated.

(7) The owner or operator of the facility where the railcar, tank truck, or barge is reloaded or cleaned must comply with paragraphs (g)(7)(i) through (iii) of this section.

(i) Submit to the owner or operator of the storage tank and to the Administrator a written certification that the reloading or cleaning facility will meet the requirements of this section. The certifying entity may revoke the written certification by sending a written statement to the owner or operator of the storage tank giving at least 90 days notice that the certifying entity is rescinding acceptance of responsibility for compliance with the requirements of this paragraph (g)(7).

(ii) If complying with paragraph (g)(6)(i) of this section, comply with the requirements for closed vent system and control device specified in §§63.119 through 63.123. The notification and reporting requirements in §63.122 do not apply to the owner or operator of the offsite cleaning or reloading facility.

(iii) If complying with paragraph (g)(6)(ii) of this section, keep the records specified in §63.123(i)(3).

(iv) After the compliance dates specified in §63.100(k) at an offsite reloading or cleaning facility subject to paragraph (g) of this section, compliance with the monitoring, recordkeeping, and reporting provisions of any other subpart of this part 63 constitutes compliance with the monitoring, recordkeeping, and reporting provisions of paragraph (g)(7)(ii) or paragraph (g)(7)(iii) of this section. You must identify in your Notification of Compliance Status report required by §63.152(b), the subpart to the part 63 with which the owner or operator of the reloading or cleaning facility complies.

[59 FR 19468, Apr. 22, 1994, as amended at 62 FR 2747, Jan. 17, 1997; 69 FR 76863, Dec. 23, 2004; 71 FR 76614, Dec. 21, 2006]

§ 63.120 Storage vessel provisions—procedures to determine compliance.

(a) To demonstrate compliance with §63.119(b) of this subpart (storage vessel equipped with a fixed roof and internal floating roof) or with §63.119(d) of this subpart (storage vessel equipped with an external floating roof converted to an internal floating roof), the owner or operator shall comply with the requirements in paragraphs (a)(1) through (a)(7) of this section.

(1) The owner or operator shall visually inspect the internal floating roof, the primary seal, and the secondary seal (if one is in service), according to the schedule specified in paragraphs (a)(2) and (a)(3) of this section.

(2) For vessels equipped with a single-seal system, the owner or operator shall perform the inspections specified in paragraphs (a)(2)(i) and (a)(2)(ii) of this section.

(i) Visually inspect the internal floating roof and the seal through manholes and roof hatches on the fixed roof at least once every 12 months after initial fill, or at least once every 12 months after the compliance date specified in §63.100 of subpart F of this part.

(ii) Visually inspect the internal floating roof, the seal, gaskets, slotted membranes, and sleeve seals (if any) each time the storage vessel is emptied and degassed, and at least once every 10 years after the compliance date specified in §63.100 of subpart F of this part.

(3) For vessels equipped with a double-seal system as specified in §63.119(b)(3)(iii) of this subpart, the owner or operator shall perform either the inspection required in paragraph (a)(3)(i) of this section or the inspections required in both paragraphs (a)(3)(ii) and (a)(3)(iii) of this section.

(i) The owner or operator shall visually inspect the internal floating roof, the primary seal, the secondary seal, gaskets, slotted membranes, and sleeve seals (if any) each time the storage vessel is emptied and degassed and at least once every 5 years after the compliance date specified in §63.100 of subpart F of this part; or

(ii) The owner or operator shall visually inspect the internal floating roof and the secondary seal through manholes and roof hatches on the fixed roof at least once every 12 months after initial fill, or at least once every 12 months after the compliance date specified in §63.100 of subpart F of this part, and

(iii) Visually inspect the internal floating roof, the primary seal, the secondary seal, gaskets, slotted membranes, and sleeve seals (if any) each time the vessel is emptied and degassed and at least once every 10 years after the compliance date specified in §63.100 of subpart F of this part.

(4) If during the inspections required by paragraph (a)(2)(i) or (a)(3)(ii) of this section, the internal floating roof is not resting on the surface of the liquid inside the storage vessel and is not resting on the leg supports; or there is liquid on the floating roof; or the seal is detached; or there are holes or tears in the seal fabric; or there are visible gaps between the seal and the wall of the storage vessel, the owner or operator shall repair the items or empty and remove the storage vessel from service within 45 calendar days. If a failure that is detected during inspections required by paragraph (a)(2)(i) or (a)(3)(ii) of this section cannot be repaired within 45 calendar days and if the vessel cannot be emptied within 45 calendar days, the owner or operator may utilize up to 2 extensions of up to 30 additional calendar days each. Documentation of a decision to utilize an extension shall include a description of the failure, shall document that alternate storage capacity is unavailable, and shall specify a schedule of actions that will ensure that the control equipment will be repaired or the vessel will be emptied as soon as practical.

(5) Except as provided in paragraph (a)(6) of this section, for all the inspections required by paragraphs (a)(2)(ii), (a)(3)(i), and (a)(3)(iii) of this section, the owner or operator shall notify the Administrator in writing at least 30 calendar days prior to the refilling of each storage vessel to afford the Administrator the opportunity to have an observer present.

(6) If the inspection required by paragraph (a)(2)(ii), (a)(3)(i), or (a)(3)(iii) of this section is not planned and the owner or operator could not have known about the inspection 30 calendar days in advance of refilling the vessel, the owner or operator shall notify the Administrator at least 7 calendar days prior to the refilling of the storage vessel. Notification may be made by telephone and immediately followed by written documentation demonstrating why the inspection was unplanned. Alternatively, the notification including the written documentation may be made in writing and sent so that it is received by the Administrator at least 7 calendar days prior to refilling.

(7) If during the inspections required by paragraph (a)(2)(ii), (a)(3)(i), or (a)(3)(iii) of this section, the internal floating roof has defects; or the primary seal has holes, tears, or other openings in the seal or the seal fabric; or the secondary seal has holes, tears, or other openings in the seal or the seal fabric; or the gaskets no longer close off the liquid surface from the atmosphere; or the slotted membrane has more than 10 percent open area, the owner or operator shall repair the items as necessary so that none

of the conditions specified in this paragraph exist before refilling the storage vessel with organic HAP.

(b) To demonstrate compliance with §63.119(c) of this subpart (storage vessel equipped with an external floating roof), the owner or operator shall comply with the requirements specified in paragraphs (b)(1) through (b)(10) of this section.

(1) Except as provided in paragraph (b)(7) of this section, the owner or operator shall determine the gap areas and maximum gap widths between the primary seal and the wall of the storage vessel, and the secondary seal and the wall of the storage vessel according to the frequency specified in paragraphs (b)(1)(i) through (b)(1)(iii) of this section.

(i) For an external floating roof vessel equipped with primary and secondary seals, measurements of gaps between the vessel wall and the primary seal shall be performed during the hydrostatic testing of the vessel or by the compliance date specified in §63.100 of subpart F of this part, whichever occurs last, and at least once every 5 years thereafter.

(ii) For an external floating roof vessel equipped with a liquid-mounted or metallic shoe primary seal and without a secondary seal as provided for in §63.119(c)(1)(iv) of this subpart, measurements of gaps between the vessel wall and the primary seal shall be performed by the compliance date specified in §63.100 of subpart F of this part and at least once per year thereafter, until a secondary seal is installed. When a secondary seal is installed above the primary seal, measurements of gaps between the vessel wall and both the primary and secondary seals shall be performed within 90 calendar days of installation of the secondary seal, and according to the frequency specified in paragraphs (b)(1)(i) and (b)(1)(iii) of this section thereafter.

(iii) For an external floating roof vessel equipped with primary and secondary seals, measurements of gaps between the vessel wall and the secondary seal shall be performed by the compliance date specified in §63.100 of subpart F of this part and at least once per year thereafter.

(iv) If any storage vessel ceases to store organic HAP for a period of 1 year or more, or if the maximum true vapor pressure of the total organic HAP's in the stored liquid falls below the values defining Group 1 storage vessels specified in table 5 or table 6 of this subpart for a period of 1 year or more, measurements of gaps between the vessel wall and the primary seal, and gaps between the vessel wall and the secondary seal shall be performed within 90 calendar days of the vessel being refilled with organic HAP.

(2) Except as provided in paragraph (b)(7) of this section, the owner or operator shall determine gap widths and gap areas in the primary and secondary seals (seal gaps) individually by the procedures described in paragraphs (b)(2)(i) through (b)(2)(iii) of this section.

(i) Seal gaps, if any, shall be measured at one or more floating roof levels when the roof is not resting on the roof leg supports.

(ii) Seal gaps, if any, shall be measured around the entire circumference of the vessel in each place where an 0.32 centimeter (1/8inch) diameter uniform probe passes freely (without forcing or binding against the seal) between the seal and the wall of the storage vessel. The circumferential distance of each such location shall also be measured.

(iii) The total surface area of each gap described in paragraph (b)(2)(ii) of this section shall be determined by using probes of various widths to measure accurately the actual distance from the vessel wall to the seal and multiplying each such width by its respective circumferential distance.

(3) The owner or operator shall add the gap surface area of each gap location for the primary seal and divide the sum by the nominal diameter of the vessel. The accumulated area of gaps between the vessel wall and the primary seal shall not exceed 212 square centimeters per meter of vessel diameter and the width of any portion of any gap shall not exceed 3.81 centimeters.

(4) The owner or operator shall add the gap surface area of each gap location for the secondary seal and divide the sum by the nominal diameter of the vessel. The accumulated area of gaps between the vessel wall and the secondary seal shall not exceed 21.2 square centimeters per meter of vessel diameter and the width of any portion of any gap shall not exceed 1.27 centimeters. These seal gap

requirements may be exceeded during the measurement of primary seal gaps as required by paragraph (b)(1)(i) and (b)(1)(ii) of this section.

(5) The primary seal shall meet the additional requirements specified in paragraphs (b)(5)(i) and (b)(5)(ii) of this section.

(i) Where a metallic shoe seal is in use, one end of the metallic shoe shall extend into the stored liquid and the other end shall extend a minimum vertical distance of 61 centimeters above the stored liquid surface.

(ii) There shall be no holes, tears, or other openings in the shoe, seal fabric, or seal envelope.

(6) The secondary seal shall meet the additional requirements specified in paragraphs (b)(6)(i) and (b)(6)(ii) of this section.

(i) The secondary seal shall be installed above the primary seal so that it completely covers the space between the roof edge and the vessel wall except as provided in paragraph (b)(4) of this section.

(ii) There shall be no holes, tears, or other openings in the seal or seal fabric.

(7) If the owner or operator determines that it is unsafe to perform the seal gap measurements required in paragraphs (b)(1) and (b)(2) of this section or to inspect the vessel to determine compliance with paragraphs (b)(5) and (b)(6) of this section because the floating roof appears to be structurally unsound and poses an imminent or potential danger to inspecting personnel, the owner or operator shall comply with the requirements in either paragraph (b)(7)(i) or (b)(7)(ii) of this section.

(i) The owner or operator shall measure the seal gaps or inspect the storage vessel no later than 30 calendar days after the determination that the roof is unsafe, or

(ii) The owner or operator shall empty and remove the storage vessel from service no later than 45 calendar days after determining that the roof is unsafe. If the vessel cannot be emptied within 45 calendar days, the owner or operator may utilize up to 2 extensions of up to 30 additional calendar days each. Documentation of a decision to utilize an extension shall include an explanation of why it was unsafe to perform the inspection or seal gap measurement, shall document that alternate storage capacity is unavailable, and shall specify a schedule of actions that will ensure that the vessel will be emptied as soon as practical.

(8) The owner or operator shall repair conditions that do not meet requirements listed in paragraphs (b)(3), (b)(4), (b)(5), and (b)(6) of this section (i.e., failures) no later than 45 calendar days after identification, or shall empty and remove the storage vessel from service no later than 45 calendar days after identification. If during seal gap measurements required in paragraph (b)(1) and (b)(2) of this section or during inspections necessary to determine compliance with paragraphs (b)(5) and (b)(6) of this section a failure is detected that cannot be repaired within 45 calendar days and if the vessel cannot be emptied within 45 calendar days, the owner or operator may utilize up to 2 extensions of up to 30 additional calendar days each. Documentation of a decision to utilize an extension shall include a description of the failure, shall document that alternate storage capacity is unavailable, and shall specify a schedule of actions that will ensure that the control equipment will be repaired or the vessel will be emptied as soon as practical.

(9) The owner or operator shall notify the Administrator in writing 30 calendar days in advance of any gap measurements required by paragraph (b)(1) or (b)(2) of this section to afford the Administrator the opportunity to have an observer present.

(10) The owner or operator shall visually inspect the external floating roof, the primary seal, secondary seal, and fittings each time the vessel is emptied and degassed.

(i) If the external floating roof has defects; the primary seal has holes, tears, or other openings in the seal or the seal fabric; or the secondary seal has holes, tears, or other openings in the seal or the seal fabric; or the gaskets no longer close off the liquid surface from the atmosphere; or the slotted membrane has more than 10 percent open area, the owner or operator shall repair the items as necessary so that none of the conditions specified in this paragraph exist before filling or refilling the

storage vessel with organic HAP.

(ii) Except as provided in paragraph (b)(10)(iii) of this section, for all the inspections required by paragraph (b)(10) of this section, the owner or operator shall notify the Administrator in writing at least 30 calendar days prior to filling or refilling of each storage vessel with organic HAP to afford the Administrator the opportunity to inspect the storage vessel prior to refilling.

(iii) If the inspection required by paragraph (b)(10) of this section is not planned and the owner or operator could not have known about the inspection 30 calendar days in advance of refilling the vessel with organic HAP, the owner or operator shall notify the Administrator at least 7 calendar days prior to refilling of the storage vessel. Notification may be made by telephone and immediately followed by written documentation demonstrating why the inspection was unplanned. Alternatively, this notification including the written documentation may be made in writing and sent so that it is received by the Administrator at least 7 calendar days prior to the refilling.

(c) To demonstrate compliance with §63.119(d) of this subpart (storage vessel equipped with an external floating roof converted to an internal floating roof), the owner or operator shall comply with the requirements of paragraph (a) of this section.

(d) To demonstrate compliance with §63.119(e) of this subpart (storage vessel equipped with a closed vent system and control device) using a control device other than a flare, the owner or operator shall comply with the requirements in paragraphs (d)(1) through (d)(7) of this section, except as provided in paragraph (d)(8) of this section.

(1) The owner or operator shall either prepare a design evaluation, which includes the information specified in paragraph (d)(1)(i) of this section, or submit the results of a performance test as described in paragraph (d)(1)(ii) of this section.

(i) The design evaluation shall include documentation demonstrating that the control device being used achieves the required control efficiency during reasonably expected maximum filling rate. This documentation is to include a description of the gas stream which enters the control device, including flow and organic HAP content under varying liquid level conditions, and the information specified in paragraphs (d)(1)(i)(A) through (d)(1)(i)(E) of this section, as applicable.

(A) If the control device receives vapors, gases or liquids, other than fuels, from emission points other than storage vessels subject to this subpart, the efficiency demonstration is to include consideration of all vapors, gases, and liquids, other than fuels, received by the control device.

(B) If an enclosed combustion device with a minimum residence time of 0.5 seconds and a minimum temperature of 760 °C is used to meet the emission reduction requirement specified in §63.119 (e)(1) or (e)(2), as applicable, documentation that those conditions exist is sufficient to meet the requirements of paragraph (d)(1)(i) of this section.

(C) Except as provided in paragraph (d)(1)(i)(B) of this section, for thermal incinerators, the design evaluation shall include the autoignition temperature of the organic HAP, the flow rate of the organic HAP emission stream, the combustion temperature, and the residence time at the combustion temperature.

(D) For carbon adsorbers, the design evaluation shall include the affinity of the organic HAP vapors for carbon, the amount of carbon in each bed, the number of beds, the humidity of the feed gases, the temperature of the feed gases, the flow rate of the organic HAP emission stream, the desorption schedule, the regeneration stream pressure or temperature, and the flow rate of the regeneration stream. For vacuum desorption, pressure drop shall be included.

(E) For condensers, the design evaluation shall include the final temperature of the organic HAP vapors, the type of condenser, and the design flow rate of the organic HAP emission stream.

(ii) If the control device used to comply with §63.119(e) of this subpart is also used to comply with §63.113(a)(2), §63.126(b)(1), or §63.139(c) of this subpart, the performance test required by §63.116(c), §63.128(a), or §63.139(d)(1) of this subpart is acceptable to demonstrate compliance with §63.119(e) of this subpart. The owner or operator is not required to prepare a design evaluation for the control device

as described in paragraph (d)(1)(i) of this section, if the performance test meets the criteria specified in paragraphs (d)(1)(ii)(A) and (d)(1)(ii)(B) of this section.

(A) The performance test demonstrates that the control device achieves greater than or equal to the required control efficiency specified in §63.119 (e)(1) or (e)(2) of this subpart, as applicable; and

(B) The performance test is submitted as part of the Notification of Compliance Status required by §63.151(b) of this subpart.

(2) The owner or operator shall submit, as part of the Notification of Compliance Status required by §63.151 (b) of this subpart, a monitoring plan containing the information specified in paragraph (d)(2)(i) of this section and in either (d)(2)(ii) or (d)(2)(iii) of this section.

(i) A description of the parameter or parameters to be monitored to ensure that the control device is being properly operated and maintained, an explanation of the criteria used for selection of that parameter (or parameters), and the frequency with which monitoring will be performed (e.g., when the liquid level in the storage vessel is being raised); and either

(ii) The documentation specified in paragraph (d)(1)(i) of this section, if the owner or operator elects to prepare a design evaluation; or

(iii) The information specified in paragraph (d)(2)(iii) (A) and (B) of this section if the owner or operator elects to submit the results of a performance test.

(A) Identification of the storage vessel and control device for which the performance test will be submitted, and

(B) Identification of the emission point(s) that share the control device with the storage vessel and for which the performance test will be conducted.

(3) The owner or operator shall submit, as part of the Notification of Compliance Status required by §63.152(b) of this subpart, the information specified in paragraphs (d)(3)(i) and, if applicable, (d)(3)(ii) of this section.

(i) The operating range for each monitoring parameter identified in the monitoring plan. The specified operating range shall represent the conditions for which the control device is being properly operated and maintained.

(ii) Results of the performance test described in paragraph (d)(1)(ii) of this section.

(4) The owner or operator shall demonstrate compliance with the requirements of §63.119(e)(3) of this subpart (planned routine maintenance of a control device, during which the control device does not meet the specifications of §63.119 (e)(1) or (e)(2) of this subpart, as applicable, shall not exceed 240 hours per year) by including in each Periodic Report required by §63.152(c) of this subpart the information specified in §63.122(g)(1) of this subpart.

(5) The owner or operator shall monitor the parameters specified in the Notification of Compliance Status required in §63.152(b) of this subpart or in the operating permit and shall operate and maintain the control device such that the monitored parameters remain within the ranges specified in the Notification of Compliance Status.

(6) Except as provided in paragraph (d)(7) of this section, each closed vent system shall be inspected as specified in §63.148 of this subpart. The initial and annual inspections required by §63.148(b) of this subpart shall be done during filling of the storage vessel.

(7) For any fixed roof tank and closed vent system that are operated and maintained under negative pressure, the owner or operator is not required to comply with the requirements specified in §63.148 of this subpart.

(8) A design evaluation or performance test is not required, if the owner or operator uses a combustion

device meeting the criteria in paragraph (d)(8)(i), (d)(8)(ii), (d)(8)(iii), or (d)(8)(iv) of this section.

(i) A boiler or process heater with a design heat input capacity of 44 megawatts or greater.

(ii) A boiler or process heater burning hazardous waste for which the owner or operator:

(A) Has been issued a final permit under 40 CFR part 270 and complies with the requirements of 40 CFR part 266, subpart H, or

(B) Has certified compliance with the interim status requirements of 40 CFR part 266, subpart H.

(iii) A hazardous waste incinerator for which the owner or operator has been issued a final permit under 40 CFR part 270 and complies with the requirements of 40 CFR part 264, subpart O or has certified compliance with the interim status requirements of 40 CFR part 265, subpart O.

(iv) A boiler or process heater into which the vent stream is introduced with the primary fuel.

(e) To demonstrate compliance with §63.119(e) of this subpart (storage vessel equipped with a closed vent system and control device) using a flare, the owner or operator shall comply with the requirements in paragraphs (e)(1) through (e)(6) of this section.

(1) The owner or operator shall perform the compliance determination specified in §63.11(b) of subpart A of this part.

(2) The owner or operator shall submit, as part of the Notification of Compliance Status required by §63.152(b) of this subpart, the information specified in paragraphs (e)(2)(i) through (e)(2)(iii) of this section.

(i) Flare design (i.e., steam-assisted, air-assisted, or non-assisted);

(ii) All visible emission readings, heat content determinations, flow rate measurements, and exit velocity determinations made during the compliance determination required by paragraph (e)(1) of this section; and

(iii) All periods during the compliance determination when the pilot flame is absent.

(3) The owner or operator shall demonstrate compliance with the requirements of §63.119(e)(3) of this subpart (planned routine maintenance of a flare, during which the flare does not meet the specifications of §63.119(e)(1) of this subpart, shall not exceed 240 hours per year) by including in each Periodic Report required by §63.152(c) of this subpart the information specified in §63.122(g)(1) of this subpart.

(4) The owner or operator shall continue to meet the general control device requirements specified in §63.11(b) of subpart A of this part.

(5) Except as provided in paragraph (e)(6) of this section, each closed vent system shall be inspected as specified in §63.148 of this subpart. The inspections required to be performed in accordance with §63.148(c) of this subpart shall be done during filling of the storage vessel.

(6) For any fixed roof tank and closed vent system that is operated and maintained under negative pressure, the owner or operator is not required to comply with the requirements specified in §63.148 of this subpart.

(f) To demonstrate compliance with §63.119(f) of this subpart (storage vessel routed to a process), the owner or operator shall prepare a design evaluation (or engineering assessment) that demonstrates the extent to which one or more of the ends specified in §63.119(f)(1)(i) through (f)(1)(iv) are being met. The owner or operator shall submit the design evaluation as part of the Notification of Compliance Status required by §63.152(b) of this subpart.

[59 FR 19468, Apr. 22, 1994, as amended at 61 FR 64576, Dec. 5, 1996; 62 FR 2748, Jan. 17, 1997]

§ 63.121 Storage vessel provisions—alternative means of emission limitation.

(a) Determination of equivalence to the reduction in emissions achieved by the requirements of §63.119 (b), (c), or (d) of this subpart will be evaluated according to §63.102(b) of subpart F of this part.

(b) The determination of equivalence referred to in paragraph (a) of this section will be based on the application to the Administrator which shall include the information specified in either paragraph (b)(1) or (b)(2) of this section.

(1) Actual emissions tests that use full-size or scale-model storage vessels that accurately collect and measure all organic HAP emissions from a given control technique, and that accurately simulate wind and account for other emission variables such as temperature and barometric pressure, or

(2) An engineering analysis that the Administrator determines is an accurate method of determining equivalence.

§ 63.122 Storage vessel provisions—reporting.

(a) For each Group 1 storage vessel, the owner or operator shall comply with the requirements of paragraphs (a)(1) through (a)(5) of this section.

(1) The owner or operator shall submit an Initial Notification as required by §63.151(b) of this subpart.

(2) [Reserved]

(3) The owner or operator shall submit a Notification of Compliance Status as required by §63.152(b) of this subpart and shall submit as part of the Notification of Compliance Status the information specified in paragraph (c) of this section.

(4) The owner or operator shall submit Periodic Reports as required by §63.152(c) of this subpart and shall submit as part of the Periodic Reports the information specified in paragraphs (d), (e), (f), and (g) of this section.

(5) The owner or operator shall submit, as applicable, other reports as required by §63.152(d) of this subpart, containing the information specified in paragraph (h) of this section.

(b) An owner or operator who elects to comply with §63.119(e) of this subpart by using a closed vent system and a control device other than a flare shall submit, as part of the Monitoring Plan, the information specified in §63.120(d)(2)(i) of this subpart and the information specified in either §63.120(d)(2)(ii) of this subpart or §63.120(d)(2)(iii) of this subpart.

(c) An owner or operator who elects to comply with §63.119(e) of this subpart by using a closed vent system and a control device shall submit, as part of the Notification of Compliance Status required by §63.152(b) of this subpart, the information specified in either paragraph (c)(1) or (c)(2) of this section. An owner or operator who elects to comply with §63.119(f) of this subpart by routing emissions to a process or to a fuel gas system shall submit, as part of the Notification of Compliance Status required by §63.152(b) of this subpart, the information specified in paragraph (c)(3) of this section.

(1) If a control device other than a flare is used, the owner or operator shall submit the information specified in §63.120(d)(3)(i) and, if applicable, (d)(3)(ii) of this subpart.

(2) If a flare is used, the owner or operator shall submit the information specified in §63.120(e)(2)(i), (e)(2)(ii), and (e)(2)(iii) of this subpart.

(3) If emissions are routed to a process, the owner or operator shall submit the information specified in §63.120(f). If emissions are routed to a fuel gas system, the owner or operator shall submit a statement that the emission stream is connected to the fuel gas system and whether the conveyance system is subject to the requirements of §63.148.

(d) An owner or operator who elects to comply with §63.119(b) of this subpart by using a fixed roof and an internal floating roof or with §63.119(d) of this subpart by using an external floating roof converted to an internal floating roof shall submit, as part of the Periodic Report required under §63.152(c) of this subpart, the results of each inspection conducted in accordance with §63.120(a) of this subpart in which a failure is detected in the control equipment.

(1) For vessels for which annual inspections are required under §63.120 (a)(2)(i) or (a)(3)(ii) of this subpart, the specifications and requirements listed in paragraphs (d)(1)(i) through (d)(1)(iii) of this section apply.

(i) A failure is defined as any time in which the internal floating roof is not resting on the surface of the liquid inside the storage vessel and is not resting on the leg supports; or there is liquid on the floating roof; or the seal is detached from the internal floating roof; or there are holes, tears, or other openings in the seal or seal fabric; or there are visible gaps between the seal and the wall of the storage vessel.

(ii) Except as provided in paragraph (d)(1)(iii) of this section, each Periodic Report shall include the date of the inspection, identification of each storage vessel in which a failure was detected, and a description of the failure. The Periodic Report shall also describe the nature of and date the repair was made or the date the storage vessel was emptied.

(iii) If an extension is utilized in accordance with §63.120(a)(4) of this subpart, the owner or operator shall, in the next Periodic Report, identify the vessel; include the documentation specified in §63.120(a)(4) of this subpart; and describe the date the storage vessel was emptied and the nature of and date the repair was made.

(2) For vessels for which inspections are required under §63.120 (a)(2)(ii), (a)(3)(i), or (a)(3)(iii) of this subpart, the specifications and requirements listed in paragraphs (d)(2)(i) and (d)(2)(ii) of this section apply.

(i) A failure is defined as any time in which the internal floating roof has defects; or the primary seal has holes, tears, or other openings in the seal or the seal fabric; or the secondary seal (if one has been installed) has holes, tears, or other openings in the seal or the seal fabric; or the gaskets no longer close off the liquid surface from the atmosphere; or the slotted membrane has more than 10 percent open area.

(ii) Each Periodic Report required under §63.152(c) of this subpart shall include the date of the inspection, identification of each storage vessel in which a failure was detected, and a description of the failure. The Periodic Report shall also describe the nature of and date the repair was made.

(e) An owner or operator who elects to comply with §63.119(c) of this subpart by using an external floating roof shall meet the periodic reporting requirements specified in paragraphs (e)(1), (e)(2), and (e)(3) of this section.

(1) The owner or operator shall submit, as part of the Periodic Report required under §63.152(c) of this subpart, documentation of the results of each seal gap measurement made in accordance with §63.120 (b) of this subpart in which the requirements of §63.120 (b)(3), (b)(4), (b)(5), or (b)(6) of this subpart are not met. This documentation shall include the information specified in paragraphs (e)(1)(i) through (e)(1)(iv) of this section.

(i) The date of the seal gap measurement.

(ii) The raw data obtained in the seal gap measurement and the calculations described in §63.120 (b)(3) and (b)(4) of this subpart.

(iii) A description of any condition specified in §63.120 (b)(5) or (b)(6) of this subpart that is not met.

(iv) A description of the nature of and date the repair was made, or the date the storage vessel was emptied.

(2) If an extension is utilized in accordance with §63.120(b)(7)(ii) or (b)(8) of this subpart, the owner or operator shall, in the next Periodic Report, identify the vessel; include the documentation specified in

§63.120(b)(7)(ii) or (b)(8) of this subpart, as applicable; and describe the date the vessel was emptied and the nature of and date the repair was made.

(3) The owner or operator shall submit, as part of the Periodic Report required under §63.152(c) of this subpart, documentation of any failures that are identified during visual inspections required by §63.120(b)(10) of this subpart. This documentation shall meet the specifications and requirements in paragraphs (e)(3)(i) and (e)(3)(ii) of this section.

(i) A failure is defined as any time in which the external floating roof has defects; or the primary seal has holes, or other openings in the seal or the seal fabric; or the secondary seal has holes, tears, or other openings in the seal or the seal fabric; or the gaskets no longer close off the liquid surface from the atmosphere; or the slotted membrane has more than 10 percent open area.

(ii) Each Periodic Report required under §63.152(c) of this subpart shall include the date of the inspection, identification of each storage vessel in which a failure was detected, and a description of the failure. The periodic report shall also describe the nature of and date the repair was made.

(f) An owner or operator who elects to comply with §63.119(d) of this subpart by using an external floating roof converted to an internal floating roof shall comply with the periodic reporting requirements of paragraph (d) of this section.

(g) An owner or operator who elects to comply with §63.119(e) of this subpart by installing a closed vent system and control device shall submit, as part of the next Periodic Report required by §63.152(c) of this subpart, the information specified in paragraphs (g)(1) through (g)(3) of this section.

(1) As required by §63.120(d)(4) and §63.120(e)(3) of this subpart, the Periodic Report shall include the information specified in paragraphs (g)(1)(i) and (g)(1)(ii) of this section for those planned routine maintenance operations that would require the control device not to meet the requirements of §63.119(e)(1) or (e)(2) of this subpart, as applicable.

(i) A description of the planned routine maintenance that is anticipated to be performed for the control device during the next 6 months. This description shall include the type of maintenance necessary, planned frequency of maintenance, and lengths of maintenance periods.

(ii) A description of the planned routine maintenance that was performed for the control device during the previous 6 months. This description shall include the type of maintenance performed and the total number of hours during those 6 months that the control device did not meet the requirements of §63.119(e)(1) or (e)(2) of this subpart, as applicable, due to planned routine maintenance.

(2) If a control device other than a flare is used, the Periodic Report shall describe each occurrence when the monitored parameters were outside of the parameter ranges documented in the Notification of Compliance Status in accordance with §63.120(d)(3)(i) of this subpart. The description shall include the information specified in paragraphs (g)(2)(i) and (g)(2)(ii) of this section.

(i) Identification of the control device for which the measured parameters were outside of the established ranges, and

(ii) Cause for the measured parameters to be outside of the established ranges.

(3) If a flare is used, the Periodic Report shall describe each occurrence when the flare does not meet the general control device requirements specified in §63.11(b) of subpart A of this part and shall include the information specified in paragraphs (g)(3)(i) and (g)(3)(ii) of this section.

(i) Identification of the flare which does not meet the general requirements specified in §63.11(b) of subpart A of this part, and

(ii) Reason the flare did not meet the general requirements specified in §63.11(b) of subpart A of this part.

(h) An owner or operator who elects to comply with §63.119 (b), (c), or (d) of this subpart shall submit,

as applicable, the reports specified in paragraphs (h)(1) and (h)(2) of this section.

(1) In order to afford the Administrator the opportunity to have an observer present, the owner or operator shall notify the Administrator of the refilling of a storage vessel that has been emptied and degassed.

(i) If the storage vessel is equipped with an internal floating roof as specified in §63.119(b) of this subpart, the notification shall meet the requirements of either §63.120 (a)(5) or (a)(6) of this subpart, as applicable.

(ii) If the storage vessel is equipped with an external floating roof as specified in §63.119(c) of this subpart, the notification shall meet the requirements of either §63.120 (b)(10)(ii) or (b)(10)(iii) of this subpart, as applicable.

(iii) If the storage vessel is equipped with an external floating roof converted into an internal floating roof as specified in §63.119(d) of this subpart, the notification shall meet the requirements of either §63.120 (a)(5) or (a)(6) of this subpart, as applicable.

(2) In order to afford the Administrator the opportunity to have an observer present, the owner or operator of a storage vessel equipped with an external floating roof as specified in §63.119(c) of this subpart shall notify the Administrator of any seal gap measurements. This notification shall meet the requirements of §63.120(b)(9) of this subpart.

[59 FR 19468, Apr. 22, 1996, as amended at 61 FR 64576, Dec. 5, 1996; 62 FR 2748, Jan. 17, 1997]

§ 63.123 Storage vessel provisions—recordkeeping.

(a) Each owner or operator of a Group 1 or Group 2 storage vessel shall keep readily accessible records showing the dimensions of the storage vessel and an analysis showing the capacity of the storage vessel. This record shall be kept as long as the storage vessel retains Group 1 or Group 2 status and is in operation. For each Group 2 storage vessel, the owner or operator is not required to comply with any other provisions of §§63.119 through 63.123 of this subpart other than those required by this paragraph unless such vessel is part of an emissions average as described in §63.150 of this subpart.

(b) [Reserved]

(c) An owner or operator who elects to comply with §63.119(b) of this subpart shall keep a record that each inspection required by §63.120(a) of this subpart was performed.

(d) An owner or operator who elects to comply with §63.119(c) of this subpart shall keep records describing the results of each seal gap measurement made in accordance with §63.120(b) of this subpart. The records shall include the date of the measurement, the raw data obtained in the measurement, and the calculations described in §63.120(b) (3) and (4) of this subpart.

(e) An owner or operator who elects to comply with §63.119(d) of this subpart shall keep a record that each inspection required by §63.120 (a) and (c) of this subpart was performed.

(f) An owner or operator who elects to comply with §63.119(e) of this subpart shall keep in a readily accessible location the records specified in paragraphs (f)(1) and (f)(2) of this section.

(1) A record of the measured values of the parameters monitored in accordance with §63.120(d)(5) of this subpart.

(2) A record of the planned routine maintenance performed on the control device including the duration of each time the control device does not meet the specifications of §63.119 (e)(1) or (e)(2) of this subpart, as applicable, due to the planned routine maintenance. Such a record shall include the information specified in paragraphs (f)(2)(i) and (f)(2)(ii) of this section.

(i) The first time of day and date the requirements of §63.119 (e)(1) or (e)(2) of this subpart, as applicable, were not met at the beginning of the planned routine maintenance, and

(ii) The first time of day and date the requirements of §63.119 (e)(1) or (e)(2) of this subpart, as applicable, were met at the conclusion of the planned routine maintenance.

(g) An owner or operator who elects to utilize an extension in emptying a storage vessel in accordance with §63.120 (a)(4), (b)(7)(ii), or (b)(8) of this subpart shall keep in a readily accessible location, the documentation specified in §63.120 (a)(4), (b)(7)(ii), or (b)(8), as applicable.

(h) An owner or operator who uses the by-pass provisions of §63.119(f)(3) of this subpart shall keep in a readily accessible location the records specified in paragraphs (h)(1) through (h)(3) of this section.

(1) The reason it was necessary to by-pass the process equipment or fuel gas system;

(2) The duration of the period when the process equipment or fuel gas system was by-passed;

(3) Documentation or certification of compliance with the applicable provisions of §63.119(f)(3)(i) through §63.119(f)(3)(iii).

(i) An owner or operator who elects to comply with §63.119(g) shall keep the records specified in paragraphs (i)(1) through (3) of this section.

(1) A record of the U.S. Department of Transportation certification required by §63.119(g)(2).

(2) A record of the pressure relief vent setting specified in §63.119(g)(5).

(3) If complying with §63.119(g)(6)(ii), keep the records specified in paragraphs (i)(3)(i) and (ii) of this section.

(i) A record of the equipment to be used and the procedures to be followed when reloading the railcar, tank truck, or barge and displacing vapors to the storage tank from which the liquid originates.

(ii) A record of each time the vapor balancing system is used to comply with §63.119(g)(6)(ii).

[59 FR 19468, Apr. 22, 1996, as amended at 61 FR 64576, Dec. 5, 1996; 62 FR 2748, Jan. 17, 1997; 69 FR 76863, Dec. 23, 2004]

§§ 63.124-63.125 [Reserved]

§ 63.126 Transfer operations provisions—reference control technology.

(a) For each Group 1 transfer rack the owner or operator shall equip each transfer rack with a vapor collection system and control device.

(1) Each vapor collection system shall be designed and operated to collect the organic hazardous air pollutants vapors displaced from tank trucks or railcars during loading, and to route the collected hazardous air pollutants vapors to a process, or to a fuel gas system, or to a control device as provided in paragraph (b) of this section.

(2) Each vapor collection system shall be designed and operated such that organic HAP vapors collected at one loading arm will not pass through another loading arm in the rack to the atmosphere.

(3) Whenever organic hazardous air pollutants emissions are vented to a process, fuel gas system, or control device used to comply with the provisions of this subpart, the process, fuel gas system, or control device shall be operating.

(b) For each Group 1 transfer rack the owner or operator shall comply with paragraph (b)(1), (b)(2), (b)(3), or (b)(4) of this section.

(1) Use a control device to reduce emissions of total organic hazardous air pollutants by 98 weight-

percent or to an exit concentration of 20 parts per million by volume, whichever is less stringent. For combustion devices, the emission reduction or concentration shall be calculated on a dry basis, corrected to 3-percent oxygen. If a boiler or process heater is used to comply with the percent reduction requirement, then the vent stream shall be introduced into the flame zone of such a device. Compliance may be achieved by using any combination of combustion, recovery, and/or recapture devices.

(2) Reduce emissions of organic HAP's using a flare.

(i) The flare shall comply with the requirements of §63.11(b) of subpart A of this part.

(ii) Halogenated vent streams, as defined in §63.111 of this subpart, shall not be vented to a flare.

(3) Reduce emissions of organic hazardous air pollutants using a vapor balancing system designed and operated to collect organic hazardous air pollutants vapors displaced from tank trucks or railcars during loading; and to route the collected hazardous air pollutants vapors to the storage vessel from which the liquid being loaded originated, or to another storage vessel connected to a common header, or to compress and route to a process collected hazardous air pollutants vapors.

(4) Route emissions of organic hazardous air pollutants to a fuel gas system or to a process where the organic hazardous air pollutants in the emissions shall predominantly meet one of, or a combination of, the ends specified in paragraphs (b)(4)(i) through (b)(4)(iv) of this section.

(i) Recycled and/or consumed in the same manner as a material that fulfills the same function in that process;

(ii) Transformed by chemical reaction into materials that are not organic hazardous air pollutants;

(iii) Incorporated into a product; and/or

(iv) Recovered.

(c) For each Group 2 transfer rack, the owner or operator shall maintain records as required in §63.130

(f). No other provisions for transfer racks apply to the Group 2 transfer rack.

(d) Halogenated emission streams from Group 1 transfer racks that are combusted shall be controlled according to paragraph (d)(1) or (d)(2) of this section. Determination of whether a vent stream is halogenated shall be made using procedures in (d)(3).

(1) If a combustion device is used to comply with paragraph (b)(1) of this section for a halogenated vent stream, then the vent stream exiting the combustion device shall be ducted to a halogen reduction device, including, but not limited to, a scrubber before it is discharged to the atmosphere.

(i) Except as provided in paragraph (d)(1)(ii) of this section, the halogen reduction device shall reduce overall emissions of hydrogen halides and halogens, as defined in §63.111 of this subpart, by 99 percent or shall reduce the outlet mass emission rate of total hydrogen halides and halogens to 0.45 kilograms per hour or less, whichever is less stringent.

(ii) If a scrubber or other halogen reduction device was installed prior to December 31, 1992, the halogen reduction device shall reduce overall emissions of hydrogen halides and halogens, as defined in §63.111 of this subpart, by 95 percent or shall reduce the outlet mass of total hydrogen halides and halogens to less than 0.45 kilograms per hour, whichever is less stringent.

(2) A halogen reduction device, such as a scrubber, or other technique may be used to make the vent stream non-halogenated by reducing the vent stream halogen atom mass emission rate to less than 0.45 kilograms per hour prior to any combustion control device used to comply with the requirements of paragraphs (b)(1) or (b)(2) of this section.

(3) In order to determine whether a vent stream is halogenated, the mass emission rate of halogen atoms contained in organic compounds shall be calculated.

(i) The vent stream concentration of each organic compound containing halogen atoms (parts per million by volume by compound) shall be determined based on the following procedures:

(A) Process knowledge that no halogen or hydrogen halides are present in the process, or

(B) Applicable engineering assessment as specified in §63.115(d)(1)(iii) of this subpart, or

(C) Concentration of organic compounds containing halogens measured by Method 18 of 40 CFR part 60, appendix A, or

(D) Any other method or data that has been validated according to the applicable procedures in Method 301 of appendix A of this part.

(ii) The following equation shall be used to calculate the mass emission rate of halogen atoms:

$$E = K_2 V_s \left(\sum_{j=1}^n \sum_{i=1}^m C_j * L_{ji} * M_{ji} \right)$$

where:

E=Mass of halogen atoms, dry basis, kilograms per hour.

K_2 =Constant, 2.494×10^{-6} (parts per million)⁻¹(kilogram-mole per standard cubic meter) (minute/hour), where standard temperature is 20 °C.

C_j =Concentration of halogenated compound j in the gas stream, dry basis, parts per million by volume.

M_{ji} =Molecular weight of halogen atom i in compound j of the gas stream, kilogram per kilogram-mole.

L_{ji} =Number of atoms of halogen i in compound j of the gas stream.

V_s =Flow rate of gas stream, dry standard cubic meters per minute, determined according to §63.128(a)(8) of this subpart.

j=Halogenated compound j in the gas stream.

i=Halogen atom i in compound j of the gas stream.

n=Number of halogenated compounds j in the gas stream.

m=Number of different halogens i in each compound j of the gas stream.

(e) For each Group 1 transfer rack the owner or operator shall load organic HAP's into only tank trucks and railcars which:

(1) Have a current certification in accordance with the U. S. Department of Transportation pressure test requirements of 49 CFR part 180 for tank trucks and 49 CFR 173.31 for railcars; or

(2) Have been demonstrated to be vapor-tight within the preceding 12 months, as determined by the procedures in §63.128(f) of this subpart. Vapor-tight means that the truck or railcar tank will sustain a pressure change of not more than 750 pascals within 5 minutes after it is pressurized to a minimum of

4,500 pascals.

(f) The owner or operator of a transfer rack subject to the provisions of this subpart shall load organic HAP's to only tank trucks or railcars equipped with vapor collection equipment that is compatible with the transfer rack's vapor collection system.

(g) The owner or operator of a transfer rack subject to this subpart shall load organic HAP's to only tank trucks or railcars whose collection systems are connected to the transfer rack's vapor collection systems.

(h) The owner or operator of a transfer rack subject to the provisions of this subpart shall ensure that no pressure-relief device in the transfer rack's vapor collection system or in the organic hazardous air pollutants loading equipment of each tank truck or railcar shall begin to open during loading. Pressure relief devices needed for safety purposes are not subject to this paragraph.

(i) Each valve in the vent system that would divert the vent stream to the atmosphere, either directly or indirectly, shall be secured in a non-diverting position using a carseal or a lock-and-key type configuration, or shall be equipped with a flow indicator. Equipment such as low leg drains, high point bleeds, analyzer vents, open-ended valves or lines, and pressure relief devices needed for safety purposes is not subject to this paragraph.

[59 FR 19468, Apr. 22, 1994, as amended at 62 FR 2749, Jan. 17, 1997]

§ 63.127 Transfer operations provisions—monitoring requirements.

(a) Each owner or operator of a Group 1 transfer rack equipped with a combustion device used to comply with the 98 percent total organic hazardous air pollutants reduction or 20 parts per million by volume outlet concentration requirements in §63.126(b)(1) of this subpart shall install, calibrate, maintain, and operate according to the manufacturers' specifications (or other written procedures that provide adequate assurance that the equipment would reasonably be expected to monitor accurately) the monitoring equipment specified in paragraph (a)(1), (a)(2), (a)(3), or (a)(4) of this section, as appropriate.

(1) Where an incinerator is used, a temperature monitoring device equipped with a continuous recorder is required.

(i) Where an incinerator other than a catalytic incinerator is used, a temperature monitoring device shall be installed in the firebox or in the ductwork immediately downstream of the firebox in a position before any substantial heat exchange occurs.

(ii) Where a catalytic incinerator is used, temperature monitoring devices shall be installed in the gas stream immediately before and after the catalyst bed.

(2) Where a flare is used, a device (including but not limited to a thermocouple, infrared sensor, or an ultra-violet beam sensor) capable of continuously detecting the presence of a pilot flame is required.

(3) Where a boiler or process heater with a design heat input capacity less than 44 megawatts is used, a temperature monitoring device in the firebox equipped with a continuous recorder is required. Any boiler or process heater in which all vent streams are introduced with the primary fuel or are used as the primary fuel is exempt from this requirement.

(4) Where a scrubber is used with an incinerator, boiler, or process heater in the case of halogenated vent streams, the following monitoring equipment is required for the scrubber:

(i) A pH monitoring device equipped with a continuous recorder shall be installed to monitor the pH of the scrubber effluent.

(ii) A flow meter equipped with a continuous recorder shall be located at the scrubber influent for liquid flow. Gas stream flow shall be determined using one of the procedures specified in paragraphs (a)(4)(ii)(A) through (a)(4)(ii)(C) of this section.

(A) The owner or operator may determine gas stream flow using the design blower capacity, with appropriate adjustments for pressure drop.

(B) If the scrubber is subject to regulations in 40 CFR parts 264 through 266 that have required a determination of the liquid to gas (L/G) ratio prior to the applicable compliance date for this subpart specified in §63.100(k) of subpart F of this part, the owner or operator may determine gas stream flow by the method that had been utilized to comply with those regulations. A determination that was conducted prior to the compliance date for this subpart may be utilized to comply with this subpart if it is still representative.

(C) The owner or operator may prepare and implement a gas stream flow determination plan that documents an appropriate method which will be used to determine the gas stream flow. The plan shall require determination of gas stream flow by a method which will at least provide a value for either a representative or the highest gas stream flow anticipated in the scrubber during representative operating conditions other than start-ups, shutdowns, or malfunctions. The plan shall include a description of the methodology to be followed and an explanation of how the selected methodology will reliably determine the gas stream flow, and a description of the records that will be maintained to document the determination of gas stream flow. The owner or operator shall maintain the plan as specified in §63.103 (c).

(b) Each owner or operator of a Group 1 transfer rack that uses a recovery device or recapture device to comply with the 98-percent organic hazardous air pollutants reduction or 20 parts per million by volume hazardous air pollutants concentration requirements in §63.126(b)(1) of this subpart shall install either an organic monitoring device equipped with a continuous recorder, or the monitoring equipment specified in paragraph (b)(1), (b)(2), or (b)(3) of this section, depending on the type of recovery device or recapture device used. All monitoring equipment shall be installed, calibrated, and maintained according to the manufacturer's specifications or other written procedures that provide adequate assurance that the equipment would reasonably be expected to monitor accurately.

(1) Where an absorber is used, a scrubbing liquid temperature monitoring device equipped with a continuous recorder shall be used; and a specific gravity monitoring device equipped with a continuous recorder shall be used.

(2) Where a condenser is used, a condenser exit (product side) temperature monitoring device equipped with a continuous recorder shall be used.

(3) Where a carbon adsorber is used, an integrating regeneration stream flow monitoring device having an accuracy of ± 10 percent or better, capable of recording the total regeneration stream mass flow for each regeneration cycle; and a carbon bed temperature monitoring device, capable of recording the temperature of the carbon bed after regeneration and within 15 minutes of completing any cooling cycle shall be used.

(c) An owner or operator of a Group 1 transfer rack may request approval to monitor parameters other than those listed in paragraph (a) or (b) of this section. The request shall be submitted according to the procedures specified in §63.151(f) or §63.152(e) of this subpart. Approval shall be requested if the owner or operator:

(1) Seeks to demonstrate compliance with the standards specified in §63.126(b) of this subpart with a control device other than an incinerator, boiler, process heater, flare, absorber, condenser, or carbon adsorber; or

(2) Uses one of the control devices listed in paragraphs (a) and (b) of this section, but seeks to monitor a parameter other than those specified in paragraphs (a) and (b) of this subpart.

(d) The owner or operator of a Group 1 transfer rack using a vent system that contains by-pass lines that could divert a vent stream flow away from the control device used to comply with §63.126(b) of this subpart shall comply with paragraph (d)(1) or (d)(2) of this section. Equipment such as low leg drains, high point bleeds, analyzer vents, open-ended valves or lines, and pressure relief valves needed for safety purposes are not subject to this paragraph.

(1) Properly install, maintain, and operate a flow indicator that takes a reading at least once every 15 minutes. Records shall be generated as specified in §63.130(b) of this subpart. The flow indicator shall

be installed at the entrance to any by-pass line that could divert the vent stream away from the control device to the atmosphere; or

(2) Secure the by-pass line valve in the closed position with a car-seal or a lock-and-key type configuration.

(i) A visual inspection of the seal or closure mechanism shall be performed at least once every month to ensure that the valve is maintained in the closed position and the vent stream is not diverted through the by-pass line.

(ii) If a car-seal has been broken or a valve position changed, the owner or operator shall record that the vent stream has been diverted. The car-seal or lock-and-key combination shall be returned to the secured position as soon as practicable but not later than 15 calendar days after the change in position is detected.

(e) The owner or operator shall establish a range that indicates proper operation of the control device for each parameter monitored under paragraphs (a), (b), and (c) of this section. In order to establish the range, the information required in §63.152(b)(2) of this subpart shall be submitted in the Notification of Compliance Status or the operating permit application or amendment.

[59 FR 19468, Apr. 22, 1994, as amended at 62 FR 2749, Jan. 17, 1997]

§ 63.128 Transfer operations provisions—test methods and procedures.

(a) A performance test is required for determining compliance with the reduction of total organic HAP emissions in §63.126(b) of this subpart for all control devices except as specified in paragraph (c) of this section. Performance test procedures are as follows:

(1) For control devices shared between transfer racks and process vents, the performance test procedures in §63.116(c) of this subpart shall be followed.

(2) A performance test shall consist of three runs.

(3) All testing equipment shall be prepared and installed as specified in the appropriate test methods.

(4) For control devices shared between multiple arms that load simultaneously, the minimum sampling time for each run shall be 1 hour in which either an integrated sample or a minimum of four grab samples shall be taken. If grab sampling is used, then the samples shall be taken at approximately equal intervals in time, such as 15-minute intervals during the run.

(5) For control devices that are capable of continuous vapor processing but do not meet the conditions in (a)(7)(i)(B) of this section.

(A) Sampling sites shall be located at the inlet and outlet of the control device, except as provided in paragraph (a)(7)(i)(B) of this section.

(B) If a vent stream is introduced with the combustion air or as a secondary fuel into a boiler or process heater with a design capacity less than 44 megawatts, selection of paragraph (a)(1) or (a)(4) of this section, each run shall represent at least one complete filling period, during which liquid organic HAP's are loaded, and samples shall be collected using integrated sampling or grab samples taken at least four times per hour at approximately equal intervals of time, such as 15-minute intervals.

(6) For intermittent vapor processing systems that do not meet the conditions in paragraph (a)(1) or (a)(4) of this section, each run shall represent at least one complete control device cycle, and samples shall be collected using integrated sampling or grab samples taken at least four times per hour at approximately equal intervals of time, such as 15-minute intervals.

(7) Method 1 or 1A of 40 CFR part 60, appendix A, as appropriate, shall be used for selection of sampling sites.

(i) For an owner or operator complying with the 98-percent total organic HAP reduction requirements in §63.126(b)(1) of this subpart, sampling sites shall be located as specified in paragraph (a)(7)(i)(A) or (a)(7)(i)(B) of this section.

(A) Sampling sites shall be located at the inlet and outlet of the control device, except as provided in paragraph (a)(7)(i)(B) of this section.

(B) If a vent stream is introduced with the combustion air or as a secondary fuel into a boiler or process heater with a design capacity less than 44 megawatts, selection of the location of the inlet sampling sites shall ensure the measurement of total organic HAP or TOC (minus methane and ethane) concentrations in all vent streams and primary and secondary fuels introduced into the boiler or process heater. A sampling site shall also be located at the outlet of the boiler or process heater.

(ii) For an owner or operator complying with the 20 parts per million by volume limit in §63.126(b)(1) of this subpart, the sampling site shall be located at the outlet of the control device.

(8) The volumetric flow rate, in standard cubic meters per minute at 20 °C, shall be determined using Method 2, 2A, 2C, or 2D of 40 CFR part 60, appendix A as appropriate.

(9) For the purpose of determining compliance with the 20 parts per million by volume limit in §63.126(b)(1), Method 18 or Method 25A of 40 CFR part 60, appendix A shall be used to measure either organic compound concentration or organic HAP concentration, except as provided in paragraph (a)(11) of this section.

(i) If Method 25A of 40 CFR part 60, appendix A is used, the following procedures shall be used to calculate the concentration of organic compounds (C_T):

(A) The principal organic HAP in the vent stream shall be used as the calibration gas.

(B) The span value for Method 25A of 40 CFR part 60, appendix A shall be between 1.5 and 2.5 times the concentration being measured.

(C) Use of Method 25A of 40 CFR part 60, appendix A is acceptable if the response from the high-level calibration gas is at least 20 times the standard deviation of the response from the zero calibration gas when the instrument is zeroed on the most sensitive scale.

(D) The concentration of TOC shall be corrected to 3 percent oxygen using the procedures and equation in paragraph (a)(9)(v) of this section.

(ii) If Method 18 of 40 CFR part 60, appendix A is used to measure the concentration of organic compounds, the organic compound concentration (C_T) is the sum of the individual components and shall be computed for each run using the following equation:

$$C_T = \sum_{j=1}^n C_j$$

where:

C_T =Total concentration of organic compounds (minus methane and ethane), dry basis, parts per million by volume.

C_j =Concentration of sample components j, dry basis, parts per million by volume.

n=Number of components in the sample.

(iii) If an owner or operator uses Method 18 of 40 CFR part 60, appendix A to compute total organic HAP

concentration rather than organic compounds concentration, the equation in paragraph (a)(9)(ii) of this section shall be used except that only organic HAP species shall be summed. The list of organic HAP's is provided in table 2 of subpart F of this part.

(iv) The emission rate correction factor or excess air, integrated sampling and analysis procedures of Method 3B of 40 CFR part 60, appendix A shall be used to determine the oxygen concentration. The sampling site shall be the same as that of the organic hazardous air pollutants or organic compound samples, and the samples shall be taken during the same time that the organic hazardous air pollutants or organic compound samples are taken.

(v) The organic compound concentration corrected to 3 percent oxygen (C_c) shall be calculated using the following equation:

$$C_c = C_T \left(\frac{17.9}{20.9 - \%O_{2d}} \right)$$

where:

C_c =Concentration of organic compounds corrected to 3 percent oxygen, dry basis, parts per million by volume.

C_T =Total concentration of organic compounds, dry basis, parts per million by volume.

$\%O_{2d}$ =Concentration of oxygen, dry basis, percent by volume.

(10) For the purpose of determining compliance with the 98-percent reduction requirement in §63.126(b)(1) of this subpart, Method 18 or Method 25A of 40 CFR part 60, appendix A shall be used, except as provided in paragraph (a)(11) of this section.

(i) For the purpose of determining compliance with the reduction efficiency requirement, organic compound concentration may be measured in lieu of organic HAP concentration.

(ii) If Method 25A of 40 CFR part 60, appendix A is used to measure the concentration of organic compounds (C_T), the principal organic HAP in the vent stream shall be used as the calibration gas.

(A) An emission testing interval shall consist of each 15-minute period during the performance test. For each interval, a reading from each measurement shall be recorded.

(B) The average organic compound concentration and the volume measurement shall correspond to the same emissions testing interval.

(C) The mass at the inlet and outlet of the control device during each testing interval shall be calculated as follows:

$$M_j = FKV_s C_T$$

where:

M_j =Mass of organic compounds emitted during testing interval j, kilograms.

V_s =Volume of air-vapor mixture exhausted at standard conditions, 20 °C and 760 millimeters mercury, standard cubic meters.

C_T =Total concentration of organic compounds (as measured) at the exhaust vent, parts per million by volume, dry basis.

K =Density, kilograms per standard cubic meter organic HAP. 659 kilograms per standard cubic meter organic HAP. (Note: The density term cancels out when the percent reduction is calculated. Therefore, the density used has no effect. The density of hexane is given so that it can be used to maintain the units of M_j .)

$F=10^{-6}$ =Conversion factor, (cubic meters organic HAP per cubic meters air) * (parts per million by volume)⁻¹.

(D) The organic compound mass emission rates at the inlet and outlet of the control device shall be calculated as follows:

$$E_i = \frac{\sum_{j=1}^n M_{ij}}{T} \quad E_o = \frac{\sum_{j=1}^n M_{oj}}{T}$$

where:

E_i, E_o =Mass flow rate of organic compounds at the inlet (i) and outlet (o) of the combustion or recovery device, kilograms per hour.

M_{ij}, M_{oj} =Mass of organic compounds at the inlet (i) or outlet (o) during testing interval j, kilograms.

T =Total time of all testing intervals, hours.

n =Number of testing intervals.

(iii) If Method 18 of 40 CFR part 60, appendix A is used to measure organic compounds, the mass rates of organic compounds (E_i, E_o) shall be computed using the following equations:

$$E_i = K_2 \left(\sum_{j=1}^n C_{ij} MW_{ij} \right) Q_i \quad E_o = K_2 \left(\sum_{j=1}^n C_{oj} MW_{oj} \right) Q_o$$

where:

C_{ij}, C_{oj} =Concentration of sample component j of the gas stream at the inlet and outlet of the control device, respectively, dry basis, parts per million by volume.

MW_{ij}, MW_{oj} =Molecular weight of sample component j of the gas stream at the inlet and outlet of the control device, respectively, gram/gram-mole.

Q_i, Q_o =Flow rate of gas stream at the inlet and outlet of the control device, respectively, dry standard cubic meter per minute.

K_2 =Constant, 2.494×10^{-6} (parts per million)⁻¹(gram-mole per standard cubic meter) (kilogram/gram) (minute/hour), where standard temperature for (gram-mole per standard cubic meter) is 20 °C.

(iv) Where Method 18 or 25A of 40 CFR part 60, appendix A is used to measure the percent reduction in organic compounds, the percent reduction across the control device shall be calculated as follows:

$$R = \frac{E_i - E_o}{E_i} (100)$$

where:

R=Control efficiency of control device, percent.

E_i =Mass emitted or mass flow rate of organic compounds at the inlet to the combustion or recovery device as calculated under paragraph (a)(10)(ii)(D) or (a)(10)(iii) of this section, kilogram per hour.

E_o =Mass emitted or mass flow rate of organic compounds at the outlet of the combustion or recovery device, as calculated under paragraph (a)(10)(ii)(D) or (a)(10)(iii) of this section, kilogram per hour.

(11) The owner or operator may use any methods or data other than Method 18 or Method 25A of 40 CFR part 60, appendix A, if the method or data has been validated according to Method 301 of appendix A of this part.

(b) When a flare is used to comply with §63.126(b)(2), the owner or operator shall comply with paragraphs (b)(1) through (3) of this section. The owner or operator is not required to conduct a performance test to determine percent emission reduction or outlet organic HAP or TOC concentration.

(1) Conduct a visible emission test using the techniques specified in §63.11(b)(4). The observation period shall be as specified in paragraph (b)(1)(i) or (ii) of this section instead of the 2-hour period specified in §63.11(b)(4).

(i) If the loading cycle is less than 2 hours, then the observation period for that run shall be for the entire loading cycle.

(ii) If additional loading cycles are initiated within the 2-hour period, then visible emission observations shall be conducted for the additional cycles.

(2) Determine the net heating value of the gas being combusted, using the techniques specified in §63.11(b)(6).

(3) Determine the exit velocity using the techniques specified in either §63.11(b)(7)(i) (and §63.11(b)(7)(iii), where applicable) or §63.11(b)(8), as appropriate.

(c) An owner or operator is not required to conduct a performance test when any of the conditions specified in paragraphs (c)(1) through (c)(7) of this section are met.

(1) When a boiler or process heater with a design heat input capacity of 44 megawatts or greater is used.

(2) When a boiler or process heater burning hazardous waste is used for which the owner or operator:

(i) Has been issued a final permit under 40 CFR part 270 and complies with the requirements of 40 CFR part 266, subpart H, or

(ii) Has certified compliance with the interim status requirements of 40 CFR part 266 subpart H.

(3) When emissions are routed to a fuel gas system or when a boiler or process heater is used and the

vent stream is introduced with the primary fuel.

(4) When a vapor balancing system is used.

(5) When emissions are recycled to a chemical manufacturing process unit.

(6) When a transfer rack transfers less than 11.8 million liters per year and the owner or operator complies with the requirements in paragraph (h) of this section or uses a flare to comply with §63.126(b)(2) of this subpart.

(7) When a hazardous waste incinerator is used for which the owner or operator has been issued a final permit under 40 CFR part 270 and complies with the requirements of 40 CFR part 264, subpart O, or has certified compliance with the interim status requirements 40 CFR part 265, subpart O.

(d) An owner or operator using a combustion device followed by a scrubber or other halogen reduction device to control a halogenated transfer vent stream in compliance with §63.126(d) of this subpart shall conduct a performance test to determine compliance with the control efficiency or emission limits for hydrogen halides and halogens.

(1) For an owner or operator determining compliance with the percent reduction of total hydrogen halides and halogens, sampling sites shall be located at the inlet and outlet of the scrubber or other halogen reduction device used to reduce halogen emissions. For an owner or operator complying with the 0.45 kilogram per hour outlet mass emission rate limit for total hydrogen halides and halogens, the sampling site shall be located at the outlet of the scrubber or other halogen reduction device and prior to release to the atmosphere.

(2) Except as provided in paragraph (d)(5) of this section, Method 26 or 26A of 40 CFR part 60, appendix A, shall be used to determine the concentration in milligrams per dry standard cubic meter of the hydrogen halides and halogens that may be present in the stream. The mass emission rate of each hydrogen halide and halogen compound shall be calculated from the concentrations and the gas stream flow rate.

(3) To determine compliance with the percent emissions reduction limit, the mass emission rate for any hydrogen halides and halogens present at the scrubber inlet shall be summed together. The mass emission rate of the compounds present at the scrubber outlet shall be summed together. Percent reduction shall be determined by comparison of the summed inlet and outlet measurements.

(4) To demonstrate compliance with the 0.45 kilograms per hour mass emission rate limit, the test results must show that the mass emission rate of the total hydrogen halides and halogens measured at the scrubber outlet is below 0.45 kilograms per hour.

(5) The owner or operator may use any other method or data to demonstrate compliance if the method or data has been validated according to the protocol of Method 301 of appendix A of this part.

(e) The owner or operator shall inspect the vapor collection system and vapor balancing system, according to the requirements for vapor collection systems in §63.148 of this subpart.

(1) Inspections shall be performed only while a tank truck or railcar is being loaded.

(2) For vapor collection systems only, an inspection shall be performed prior to each performance test required to demonstrate compliance with §63.126(b)(1) of this subpart.

(3) For each vapor collection system that is operated and maintained under negative pressure, the owner or operator is not required to comply with the requirements specified in §63.148 of this subpart.

(f) For the purposes of demonstrating vapor tightness to determine compliance with §63.126(e)(2) of this subpart, the following procedures and equipment shall be used:

(1) The pressure test procedures specified in Method 27 of 40 CFR part 60, appendix A; and

(2) A pressure measurement device which has a precision of #1B2.5 millimeters of mercury or better and which is capable of measuring above the pressure at which the tank truck or railcar is to be tested for vapor tightness.

(g) An owner or operator using a scrubber or other halogen reduction device to reduce the vent stream halogen atom mass emission rate to less than 0.45 kilograms per hour prior to a combustion device used to comply with §63.126(d)(2) shall determine the halogen atom mass emission rate prior to the combustor according to the procedures in paragraph (d)(3) of this section.

(h) For transfer racks that transfer less than 11.8 million liters per year of liquid organic HAP's, the owner or operator may comply with the requirements in paragraphs (h)(1) through (h)(3) of this section instead of the requirements in paragraph (a) or (b) of this section.

(1) The owner or operator shall prepare, as part of the Notification of Compliance Status required by §63.152(b) of this subpart, a design evaluation that shall document that the control device being used achieves the required control efficiency during reasonably expected maximum loading conditions. This documentation is to include a description of the gas stream which enters the control device, including flow and organic HAP content, and the information specified in paragraphs (h)(1)(i) through (h)(1)(v) of this section, as applicable.

(i) If the control device receives vapors, gases, or liquids, other than fuels, from emission points other than transfer racks subject to this subpart, the efficiency demonstration is to include consideration of all vapors, gases, and liquids, other than fuels, received by the control device.

(ii) If an enclosed combustion device with a minimum residence time of 0.5 seconds and a minimum temperature of 760 degrees Celsius is used to meet the 98-percent emission reduction requirement, documentation that those conditions exist is sufficient to meet the requirements of paragraph (h)(1) of this section.

(iii) Except as provided in paragraph (h)(1)(ii) of this section, for thermal incinerators, the design evaluation shall include the autoignition temperature of the organic HAP, the flow rate of the organic HAP emission stream, the combustion temperature, and the residence time at the combustion temperature.

(iv) For carbon adsorbers, the design evaluation shall include the affinity of the organic HAP vapors for carbon, the amount of carbon in each bed, the number of beds, the humidity of the feed gases, the temperature of the feed gases, the flow rate of the organic HAP emission stream, the desorption schedule, the regeneration stream pressure or temperature, and the flow rate of the regeneration stream. For vacuum desorption, pressure drop shall be included.

(v) For condensers, the design evaluation shall include the final temperature of the organic HAP vapors, the type of condenser, and the design flow rate of the organic HAP emission stream.

(2) The owner or operator shall submit, as part of the Notification of Compliance Status required by §63.152(b) of this subpart, the operating range for each monitoring parameter identified for each control device. The specified operating range shall represent the conditions for which the control device can achieve the 98-percent-or-greater emission reduction required by §63.126(b)(1) of this subpart.

(3) The owner or operator shall monitor the parameters specified in the Notification of Compliance Status required in §63.152(b) of this subpart or operating permit and shall operate and maintain the control device such that the monitored parameters remain within the ranges specified in the Notification of Compliance Status, except as provided in §§63.152(c) and 63.152(f) of this subpart.

[59 FR 19468, Apr. 22, 1994, as amended at 61 FR 64576, Dec. 5, 1996; 62 FR 2750, Jan. 17, 1997; 66 FR 6932, Jan. 22, 2001]

§ 63.129 Transfer operations provisions—reporting and recordkeeping for performance tests and notification of compliance status.

(a) Each owner or operator of a Group 1 transfer rack shall:

- (1) Keep an up-to-date, readily accessible record of the data specified in paragraphs (a)(4) through (a)(8) of this section, as applicable.
 - (2) Include the data specified in paragraphs (a)(4) through (a)(7) of this section in the Notification of Compliance Status report as specified in §63.152(b) of this subpart.
 - (3) If any subsequent performance tests are conducted after the Notification of Compliance Status has been submitted, report the data in paragraphs (a)(4) through (a)(7) of this section in the next Periodic Report as specified in §63.152(c) of this subpart.
 - (4) Record and report the following when using a control device other than a flare to achieve a 98 weight percent reduction in total organic HAP or a total organic HAP concentration of 20 parts per million by volume, as specified in §63.126(b)(1) of this subpart:
 - (i) The parameter monitoring results for thermal incinerators, catalytic incinerators, boilers or process heaters, absorbers, condensers, or carbon adsorbers specified in table 7 of this subpart, recorded during the performance test, and averaged over the time period of the performance testing.
 - (ii) The percent reduction of total organic HAP or TOC achieved by the control device determined as specified in §63.128(a) of this subpart, or the concentration of total organic HAP or TOC (parts per million by volume, by compound) determined as specified in §63.128(a) of this subpart at the outlet of the control device. For combustion devices, the concentration shall be reported on a dry basis corrected to 3 percent oxygen.
 - (iii) The parameters shall be recorded at least every 15 minutes.
 - (iv) For a boiler or process heater, a description of the location at which the vent stream is introduced into the boiler or process heater.
 - (5) Record and report the following when using a flare to comply with §63.126(b)(2) of this subpart:
 - (i) Flare design (i.e., steam-assisted, air-assisted, or non-assisted);
 - (ii) All visible emission readings, heat content determinations, flow rate measurements, and exit velocity determinations made during the compliance determination required by §63.128(b) of this subpart; and
 - (iii) All periods during the compliance determination when the pilot flame is absent.
 - (6) Record and report the following when using a scrubber following a combustion device to control a halogenated vent stream, as specified in §63.126(d) of this subpart:
 - (i) The percent reduction or scrubber outlet mass emission rate of total hydrogen halides and halogens determined according to the procedures in §63.128(d) of this subpart;
 - (ii) The parameter monitoring results for scrubbers specified in table 7 of this subpart, and averaged over the time period of the performance test; and
 - (iii) The parameters shall be recorded at least every 15 minutes.
 - (7) Record and report the halogen concentration in the vent stream determined according to the procedures as specified in §63.128(d) of this subpart.
 - (8) Report that the emission stream is being routed to a fuel gas system or a process, when complying using §63.126(b)(4).
- (b) If an owner or operator requests approval to use a control device other than those listed in table 7 of this subpart or to monitor a parameter other than those specified in table 7 of this subpart, the owner or operator shall submit a description of planned reporting and recordkeeping procedures as required under §63.151(f) or §63.152(e) of this subpart. The Administrator will specify appropriate reporting and

recordkeeping requirements as part of the review of the permit application or by other appropriate means.

(c) For each parameter monitored according to table 7 of this subpart or paragraph (b) of this section, the owner or operator shall establish a range for the parameter that indicates proper operation of the control device. In order to establish the range, the information required in §63.152(b)(2) of this subpart shall be submitted in the Notification of Compliance Status or the operating permit application or amendment.

(d) Each owner or operator shall maintain a record describing in detail the vent system used to vent each affected transfer vent stream to a control device. This document shall list all valves and vent pipes that could vent the stream to the atmosphere, thereby by-passing the control device; identify which valves are secured by car-seals or lock-and-key type configurations; and indicate the position (open or closed) of those valves which have car-seals. Equipment leaks such as low leg drains, high point bleeds, analyzer vents, open-ended valves or lines, and pressure relief valves needed for safety purposes are not subject to this paragraph.

(e) An owner or operator meeting the requirements of §63.128(h) of this subpart shall submit, as part of the Notification of Compliance Status required by §63.152(b) of this subpart, the information specified in §63.128(h)(1) of this subpart.

(f) An owner or operator meeting the requirements of §63.128(h) of this subpart shall submit, as part of the Notification of Compliance Status required by §63.152(b) of this subpart, the operating range for each monitoring parameter identified for each control device.

[59 FR 19468, Apr. 22, 1994, as amended at 61 FR 64576, Dec. 5, 1996; 62 FR 2750, Jan. 17, 1997; 64 FR 20191, Apr. 26, 1999]

§ 63.130 Transfer operations provisions—periodic recordkeeping and reporting.

(a) Each owner or operator using a control device to comply with §63.126(b)(1) or (b)(2) of this subpart shall keep the following up-to-date, readily accessible records:

(1) While the transfer vent stream is being vented to the control device, continuous records of the equipment operating parameters specified to be monitored under §63.127 of this subpart, and listed in table 7 of this subpart or specified by the Administrator in accordance with §§63.127(c) and 63.129(b). For flares, the hourly records and records of pilot flame outages specified in table 7 shall be maintained in place of continuous records.

(2) Records of the daily average value of each monitored parameter for each operating day determined according to the procedures specified in §63.152(f), except as provided in paragraphs (a)(2)(i) through (a)(2)(iii) of this section.

(i) For flares, records of the times and duration of all periods during which the pilot flame is absent shall be kept rather than daily averages.

(ii) If carbon adsorber regeneration stream flow and carbon bed regeneration temperature are monitored, the records specified in table 7 of this subpart shall be kept instead of the daily averages.

(iii) Records of the duration of all periods when the vent stream is diverted through by-pass lines shall be kept rather than daily averages.

(3) For boilers or process heaters, records of any changes in the location at which the vent stream is introduced into the flame zone as required under the reduction of total organic HAP emissions in §63.126(b)(1) of this subpart.

(b) If a vapor collection system containing valves that could divert the emission stream away from the control device is used, each owner or operator of a Group 1 transfer rack subject to the provisions of §63.127(d) of this subpart shall keep up-to-date, readily accessible records of:

(1) Hourly records of whether the flow indicator specified under §63.127(d)(1) was operating and whether a diversion was detected at any time during the hour, as well as records of the times of all periods when the vent stream is diverted from the control device or the flow indicator is not operating.

(2) Where a seal mechanism is used to comply with §63.127(d)(2), hourly records of flow are not required. In such cases, the owner or operator shall record that the monthly visual inspection of the seals or closure mechanisms has been done, and shall record the occurrence of all periods when the seal mechanism is broken, the by-pass line valve position has changed, or the key for a lock-and-key type lock has been checked out, and records of any car-seal that has broken, as listed in table 7 of this subpart.

(c) Each owner or operator of a Group 1 transfer rack who uses a flare to comply with §63.126(b)(2) of this subpart shall keep up-to-date, readily accessible records of the flare pilot flame monitoring specified under §63.127(a)(2) of this subpart.

(d) Each owner or operator of a transfer rack subject to the requirements of §63.126 of this subpart shall submit to the Administrator Periodic Reports of the following information according to the schedule in §63.152(c) of this subpart:

(1) Reports of daily average values of monitored parameters for all operating days when the daily average values were outside the range established in the Notification of Compliance Status or operating permit.

(2) Reports of the duration of periods when monitoring data are not collected for each excursion caused by insufficient monitoring data as defined in §63.152(c)(2)(ii)(A) of this subpart.

(3) Reports of the times and durations of all periods recorded under paragraph (b)(1) of this section when the vent stream was diverted from the control device.

(4) Reports of all times recorded under paragraph (b)(2) of this section when maintenance is performed on car-sealed valves, when the car seal is broken, when the by-pass line valve position is changed, or the key for a lock-and-key type configuration has been checked out.

(5) Reports of the times and durations of all periods recorded under paragraph (a)(2)(i) of this section in which all pilot flames of a flare were absent.

(6) Reports of all carbon bed regeneration cycles during which the parameters recorded under paragraph (a)(2)(vi) of this section were outside the ranges established in the Notification of Compliance Status or operating permit.

(e) The owner or operator of a Group 1 transfer rack shall record that the verification of DOT tank certification or Method 27 testing, required in §63.126(e) of this subpart, has been performed. Various methods for the record of verification can be used, such as: A check off on a log sheet; a list of DOT serial numbers or Method 27 data; or a position description for gate security, showing that the security guard will not allow any trucks on site that do not have the appropriate documentation.

(f) Each owner or operator of a Group 1 or Group 2 transfer rack shall record, update annually, and maintain the information specified in paragraphs (f)(1) through (f)(3) of this section in a readily accessible location on site:

(1) An analysis demonstrating the design and actual annual throughput of the transfer rack;

(2) An analysis documenting the weight-percent organic HAP's in the liquid loaded. Examples of acceptable documentation include but are not limited to analyses of the material and engineering calculations.

(3) An analysis documenting the annual rack weighted average HAP partial pressure of the transfer rack.

(i) For Group 2 transfer racks that are limited to transfer of organic HAP's with partial pressures less than

10.3 kilopascals, documentation is required of the organic HAP's (by compound) that are transferred. The rack weighted average partial pressure does not need to be calculated.

(ii) For racks transferring one or more organic HAP's with partial pressures greater than 10.3 kilopascals, as well as one or more organic HAP's with partial pressures less than 10.3 kilopascals, a rack weighted partial pressure shall be documented. The rack weighted average HAP partial pressure shall be weighted by the annual throughput of each chemical transferred.

[59 FR 19468, Apr. 22, 1994, as amended at 62 FR 2750, Jan. 17, 1997; 66 FR 6932, Jan. 22, 2001]

§ 63.131 [Reserved]

§ 63.132 Process wastewater provisions—general.

(a) *Existing sources.* This paragraph specifies the requirements applicable to process wastewater streams located at existing sources. The owner or operator shall comply with the requirements in paragraphs (a)(1) through (a)(3) of this section, no later than the applicable dates specified in §63.100 of subpart F of this part.

(1) *Determine wastewater streams to be controlled for Table 9 compounds.* Determine whether each wastewater stream requires control for Table 9 compounds by complying with the requirements in either paragraph (a)(1)(i) or (a)(1)(ii) of this section, and comply with the requirements in paragraph (a)(1)(iii) of this section.

(i) Comply with paragraph (c) of this section, determining whether the wastewater stream is Group 1 or Group 2 for Table 9 compounds; or

(ii) Comply with paragraph (e) of this section, designating the wastewater stream as a Group 1 wastewater stream.

(iii) Comply with paragraph (f) of this section.

(2) *Requirements for Group 1 wastewater streams.* For wastewater streams that are Group 1 for Table 9 compounds, comply with paragraphs (a)(2)(i) through (a)(2)(iv) of this section.

(i) Comply with the applicable requirements for wastewater tanks, surface impoundments, containers, individual drain systems, and oil/water separators as specified in §63.133 through §63.137 of this subpart, except as provided in paragraphs (a)(2)(i)(A) and (a)(2)(i)(B) of this section and §63.138(a)(3) of this subpart.

(A) The waste management units may be equipped with pressure relief devices that vent directly to the atmosphere provided the pressure relief device is not used for planned or routine venting of emissions.

(B) The pressure relief device remains in a closed position at all times except when it is necessary for the pressure relief device to open for the purpose of preventing physical damage or permanent deformation of the waste management unit in accordance with good engineering and safety practices.

(ii) Comply with the applicable requirements for control of Table 9 compounds as specified in §63.138 of this subpart. Alternatively, the owner or operator may elect to comply with the treatment provisions specified in §63.132(g) of this subpart.

(iii) Comply with the applicable monitoring and inspection requirements specified in §63.143 of this subpart.

(iv) Comply with the applicable recordkeeping and reporting requirements specified in §§63.146 and 63.147 of this subpart.

(3) *Requirements for Group 2 wastewater streams.* For wastewater streams that are Group 2 for table 9 compounds, comply with the applicable recordkeeping and reporting requirements specified in §§63.146

(b)(1) and 63.147(b)(8).

(b) *New sources.* This paragraph specifies the requirements applicable to process wastewater streams located at new sources. The owner or operator shall comply with the requirements in paragraphs (b)(1) through (b)(4) of this section, no later than the applicable dates specified in §63.100 of subpart F of this part.

(1) *Determine wastewater streams to be controlled for Table 8 compounds.* Determine whether each wastewater stream requires control for Table 8 compounds by complying with the requirements in either paragraph (b)(1)(i) or (b)(1)(ii) of this section, and comply with the requirements in paragraph (b)(1)(iii) of this section.

(i) Comply with paragraph (d) of this section, determining whether the wastewater stream is Group 1 or Group 2 for Table 8 compounds; or

(ii) Comply with paragraph (e) of this section, designating the wastewater stream as a Group 1 wastewater stream for Table 8 compounds.

(iii) Comply with paragraph (f) of this section.

(2) *Determine wastewater streams to be controlled for Table 9 compounds.* Determine whether each wastewater stream requires control for Table 9 compounds by complying with the requirements in either paragraph (b)(2)(i) or (b)(2)(ii) of this section, and comply with the requirements in paragraph (b)(2)(iii) of this section.

(i) Comply with paragraph (c) of this section, determining whether the wastewater stream is Group 1 or Group 2 for Table 9 compounds; or

(ii) Comply with paragraph (e) of this section, designating the wastewater stream as a Group 1 wastewater stream.

(iii) Comply with paragraph (f) of this section.

(3) *Requirements for Group 1 wastewater streams.* For wastewater streams that are Group 1 for Table 8 compounds and/or Table 9 compounds, comply with paragraphs (b)(3)(i) through (b)(3)(iv) of this section.

(i) Comply with the applicable requirements for wastewater tanks, surface impoundments, containers, individual drain systems, and oil/water separators specified in the requirements of §63.133 through §63.137 of this subpart, except as provided in paragraphs (b)(3)(i)(A) and (b)(3)(i)(B) of this section and §63.138(a)(3) of this subpart.

(A) The waste management units may be equipped with pressure relief devices that vent directly to the atmosphere provided the pressure relief device is not used for planned or routine venting of emissions.

(B) The pressure relief device remains in a closed position at all times except when it is necessary for the pressure relief device to open for the purpose of preventing physical damage or permanent deformation of the waste management unit in accordance with good engineering and safety practices.

(ii) Comply with the applicable requirements for control of Table 8 compounds specified in §63.138 of this subpart. Alternatively, the owner or operator may elect to comply with the provisions specified in §63.132(g) of this subpart.

(iii) Comply with the applicable monitoring and inspection requirements specified in §63.143 of this subpart.

(iv) Comply with the applicable recordkeeping and reporting requirements specified in §§63.146 and 63.147 of this subpart.

(4) *Requirements for Group 2 wastewater streams.* For wastewater streams that are Group 2 for both table 8 and table 9 compounds, comply with the applicable recordkeeping and reporting requirements specified in §§63.146(b)(1) and 63.147(b)(8).

(c) *How to determine Group 1 or Group 2 status for Table 9 compounds.* This paragraph provides instructions for determining whether a wastewater stream is Group 1 or Group 2 for Table 9 compounds. Total annual average concentration shall be determined according to the procedures specified in §63.144(b) of this subpart. Annual average flow rate shall be determined according to the procedures specified in §63.144(c) of this subpart.

(1) A wastewater stream is a Group 1 wastewater stream for Table 9 compounds if:

(i) The total annual average concentration of Table 9 compounds is greater than or equal to 10,000 parts per million by weight at any flow rate; or

(ii) The total annual average concentration of Table 9 compounds is greater than or equal to 1,000 parts per million by weight and the annual average flow rate is greater than or equal to 10 liters per minute.

(2) A wastewater stream is a Group 2 wastewater stream for Table 9 compounds if it is not a Group 1 wastewater stream for Table 9 compounds by the criteria in paragraph (c)(1) of this section.

(3) The owner or operator of a Group 2 wastewater shall re-determine group status for each Group 2 stream, as necessary, to determine whether the stream is Group 1 or Group 2 whenever process changes are made that could reasonably be expected to change the stream to a Group 1 stream. Examples of process changes include, but are not limited to, changes in production capacity, production rate, feedstock type, or whenever there is a replacement, removal, or addition of recovery or control equipment. For purposes of this paragraph (c)(3), process changes do not include: Process upsets; unintentional, temporary process changes; and changes that are within the range on which the original determination was based.

(d) *How to determine Group 1 or Group 2 status for Table 8 compounds.* This paragraph provides instructions for determining whether a wastewater stream is Group 1 or Group 2 for Table 8 compounds. Annual average concentration for each Table 8 compound shall be determined according to the procedures specified in §63.144(b) of this subpart. Annual average flow rate shall be determined according to the procedures specified in §63.144(c) of this subpart.

(1) A wastewater stream is a Group 1 wastewater stream for Table 8 compounds if the annual average flow rate is 0.02 liter per minute or greater and the annual average concentration of any individual table 8 compound is 10 parts per million by weight or greater.

(2) A wastewater stream is a Group 2 wastewater stream for Table 8 compounds if the annual average flow rate is less than 0.02 liter per minute or the annual average concentration for each individual Table 8 compound is less than 10 parts per million by weight.

(3) The owner or operator of a Group 2 wastewater shall re-determine group status for each Group 2 stream, as necessary, to determine whether the stream is Group 1 or Group 2 whenever process changes are made that could reasonably be expected to change the stream to a Group 1 stream. Examples of process changes include, but are not limited to, changes in production capacity, production rate, feedstock type, or whenever there is a replacement, removal, or addition of recovery or control equipment. For purposes of this paragraph (d)(3), process changes do not include: Process upsets; unintentional, temporary process changes; and changes that are within the range on which the original determination was based.

(e) *How to designate a Group 1 wastewater stream.* The owner or operator may elect to designate a wastewater stream a Group 1 wastewater stream in order to comply with paragraph (a)(1) or (b)(1) of this section. To designate a wastewater stream or a mixture of wastewater streams a Group 1 wastewater stream, the procedures specified in paragraphs (e)(1) and (e)(2) of this section and §63.144(a)(2) of this subpart shall be followed.

(1) From the point of determination for each wastewater stream that is included in the Group 1 designation to the location where the owner or operator elects to designate such wastewater stream(s)

as a Group 1 wastewater stream, the owner or operator shall comply with all applicable emission suppression requirements specified in §§63.133 through 63.137.

(2) From the location where the owner or operator designates a wastewater stream or mixture of wastewater streams to be a Group 1 wastewater stream, such Group 1 wastewater stream shall be managed in accordance with all applicable emission suppression requirements specified in §§63.133 through 63.137 and with the treatment requirements in §63.138 of this part.

(f) Owners or operators of sources subject to this subpart shall not discard liquid or solid organic materials with a concentration of greater than 10,000 parts per million of Table 9 compounds (as determined by analysis of the stream composition, engineering calculations, or process knowledge, according to the provisions of §63.144(b) of this subpart) from a chemical manufacturing process unit to water or wastewater, unless the receiving stream is managed and treated as a Group 1 wastewater stream. This prohibition does not apply to materials from the activities listed in paragraphs (f)(1) through (f)(4) of this section.

(1) Equipment leaks;

(2) Activities included in maintenance or startup/shutdown/malfunction plans;

(3) Spills; or

(4) Samples of a size not greater than reasonably necessary for the method of analysis that is used.

(g) *Off-site treatment or on-site treatment not owned or operated by the source.* The owner or operator may elect to transfer a Group 1 wastewater stream or residual removed from a Group 1 wastewater stream to an on-site treatment operation not owned or operated by the owner or operator of the source generating the wastewater stream or residual, or to an off-site treatment operation.

(1) The owner or operator transferring the wastewater stream or residual shall:

(i) Comply with the provisions specified in §§63.133 through 63.137 of this subpart for each waste management unit that receives or manages a Group 1 wastewater stream or residual removed from a Group 1 wastewater stream prior to shipment or transport.

(ii) Include a notice with the shipment or transport of each Group 1 wastewater stream or residual removed from a Group 1 wastewater stream. The notice shall state that the wastewater stream or residual contains organic hazardous air pollutants that are to be treated in accordance with the provisions of this subpart. When the transport is continuous or ongoing (for example, discharge to a publicly-owned treatment works), the notice shall be submitted to the treatment operator initially and whenever there is a change in the required treatment.

(2) The owner or operator may not transfer the wastewater stream or residual unless the transferee has submitted to the EPA a written certification that the transferee will manage and treat any Group 1 wastewater stream or residual removed from a Group 1 wastewater stream received from a source subject to the requirements of this subpart in accordance with the requirements of either §§63.133 through 63.147, or §63.102(b) of subpart F, or subpart D of this part if alternative emission limitations have been granted the transferor in accordance with those provisions. The certifying entity may revoke the written certification by sending a written statement to the EPA and the owner or operator giving at least 90 days notice that the certifying entity is rescinding acceptance of responsibility for compliance with the regulatory provisions listed in this paragraph. Upon expiration of the notice period, the owner or operator may not transfer the wastewater stream or residual to the treatment operation.

(3) By providing this written certification to the EPA, the certifying entity accepts responsibility for compliance with the regulatory provisions listed in paragraph (g)(2) of this section with respect to any shipment of wastewater or residual covered by the written certification. Failure to abide by any of those provisions with respect to such shipments may result in enforcement action by the EPA against the certifying entity in accordance with the enforcement provisions applicable to violations of these provisions by owners or operators of sources.

(4) Written certifications and revocation statements, to the EPA from the transferees of wastewater or

residuals shall be signed by the responsible official of the certifying entity, provide the name and address of the certifying entity, and be sent to the appropriate EPA Regional Office at the addresses listed in 40 CFR 63.13. Such written certifications are not transferable by the treater.

[62 FR 2751, Jan. 17, 1997, as amended at 66 FR 6933, Jan. 22, 2001; 71 FR 76614, Dec. 21, 2006]

§ 63.133 Process wastewater provisions—wastewater tanks.

(a) For each wastewater tank that receives, manages, or treats a Group 1 wastewater stream or a residual removed from a Group 1 wastewater stream, the owner or operator shall comply with the requirements of either paragraph (a)(1) or (a)(2) of this section as specified in table 10 of this subpart.

(1) The owner or operator shall operate and maintain a fixed roof except that if the wastewater tank is used for heating wastewater, or treating by means of an exothermic reaction or the contents of the tank is sparged, the owner or operator shall comply with the requirements specified in paragraph (a)(2) of this section.

(2) The owner or operator shall comply with the requirements in paragraphs (b) through (h) of this section and shall operate and maintain one of the emission control techniques listed in paragraphs (a)(2)(i) through (a)(2)(iv) of this section.

(i) A fixed roof and a closed-vent system that routes the organic hazardous air pollutants vapors vented from the wastewater tank to a control device.

(ii) A fixed roof and an internal floating roof that meets the requirements specified in §63.119(b) of this subpart;

(iii) An external floating roof that meets the requirements specified in §§63.119(c), 63.120(b)(5), and 63.120(b)(6) of this subpart; or

(iv) An equivalent means of emission limitation. Determination of equivalence to the reduction in emissions achieved by the requirements of paragraphs (a)(2)(i) through (a)(2)(iii) of this section will be evaluated according to §63.102(b) of subpart F of this part. The determination will be based on the application to the Administrator which shall include the information specified in either paragraph (a)(2)(iv)(A) or (a)(2)(iv)(B) of this section.

(A) Actual emissions tests that use full-size or scale-model wastewater tanks that accurately collect and measure all organic hazardous air pollutants emissions from a given control technique, and that accurately simulate wind and account for other emission variables such as temperature and barometric pressure, or

(B) An engineering evaluation that the Administrator determines is an accurate method of determining equivalence.

(b) If the owner or operator elects to comply with the requirements of paragraph (a)(2)(i) of this section, the fixed roof shall meet the requirements of paragraph (b)(1) of this section, the control device shall meet the requirements of paragraph (b)(2) of this section, and the closed-vent system shall meet the requirements of paragraph (b)(3) of this section.

(1) The fixed-roof shall meet the following requirements:

(i) Except as provided in paragraph (b)(4) of this section, the fixed roof and all openings (e.g., access hatches, sampling ports, and gauge wells) shall be maintained in accordance with the requirements specified in §63.148 of this subpart.

(ii) Each opening shall be maintained in a closed position (e.g., covered by a lid) at all times that the wastewater tank contains a Group 1 wastewater stream or residual removed from a Group 1 wastewater stream except when it is necessary to use the opening for wastewater sampling, removal, or for equipment inspection, maintenance, or repair.

(2) The control device shall be designed, operated, and inspected in accordance with the requirements of §63.139 of this subpart.

(3) Except as provided in paragraph (b)(4) of this section, the closed-vent system shall be inspected in accordance with the requirements of §63.148 of this subpart.

(4) For any fixed roof tank and closed-vent system that is operated and maintained under negative pressure, the owner or operator is not required to comply with the requirements specified in §63.148 of this subpart.

(c) If the owner or operator elects to comply with the requirements of paragraph (a)(2)(ii) of this section, the floating roof shall be inspected according to the procedures specified in §63.120(a)(2) and (a)(3) of this subpart.

(d) Except as provided in paragraph (e) of this section, if the owner or operator elects to comply with the requirements of paragraph (a)(2)(iii) of this section, seal gaps shall be measured according to the procedures specified in §63.120(b)(2)(i) through (b)(4) of this subpart and the wastewater tank shall be inspected to determine compliance with §63.120(b)(5) and (b)(6) of this subpart.

(e) If the owner or operator determines that it is unsafe to perform the seal gap measurements specified in §63.120(b)(2)(i) through (b)(4) of this subpart or to inspect the wastewater tank to determine compliance with §63.120(b)(5) and (b)(6) of this subpart because the floating roof appears to be structurally unsound and poses an imminent or potential danger to inspecting personnel, the owner or operator shall comply with the requirements in either paragraph (e)(1) or (e)(2) of this section.

(1) The owner or operator shall measure the seal gaps or inspect the wastewater tank within 30 calendar days of the determination that the floating roof is unsafe, or

(2) The owner or operator shall empty and remove the wastewater tank from service within 45 calendar days of determining that the roof is unsafe. If the wastewater tank cannot be emptied within 45 calendar days, the owner or operator may utilize up to two extensions of up to 30 additional calendar days each. Documentation of a decision to utilize an extension shall include an explanation of why it was unsafe to perform the inspection or seal gap measurement, shall document that alternate storage capacity is unavailable, and shall specify a schedule of actions that will ensure that the wastewater tank will be emptied as soon as practical.

(f) Except as provided in paragraph (e) of this section, each wastewater tank shall be inspected initially, and semi-annually thereafter, for improper work practices in accordance with §63.143 of this subpart. For wastewater tanks, improper work practice includes, but is not limited to, leaving open any access door or other opening when such door or opening is not in use.

(g) Except as provided in paragraph (e) of this section, each wastewater tank shall be inspected for control equipment failures as defined in paragraph (g)(1) of this section according to the schedule in paragraphs (g)(2) and (g)(3) of this section.

(1) Control equipment failures for wastewater tanks include, but are not limited to, the conditions specified in paragraphs (g)(1)(i) through (g)(1)(ix) of this section.

(i) The floating roof is not resting on either the surface of the liquid or on the leg supports.

(ii) There is stored liquid on the floating roof.

(iii) A rim seal is detached from the floating roof.

(iv) There are holes, tears, cracks or gaps in the rim seal or seal fabric of the floating roof.

(v) There are visible gaps between the seal of an internal floating roof and the wall of the wastewater tank.

(vi) There are gaps between the metallic shoe seal or the liquid mounted primary seal of an external

floating roof and the wall of the wastewater tank that exceed 212 square centimeters per meter of tank diameter or the width of any portion of any gap between the primary seal and the tank wall exceeds 3.81 centimeters.

(vii) There are gaps between the secondary seal of an external floating roof and the wall of the wastewater tank that exceed 21.2 square centimeters per meter of tank diameter or the width of any portion of any gap between the secondary seal and the tank wall exceeds 1.27 centimeters.

(viii) Where a metallic shoe seal is used on an external floating roof, one end of the metallic shoe does not extend into the stored liquid or one end of the metallic shoe does not extend a minimum vertical distance of 61 centimeters above the surface of the stored liquid.

(ix) A gasket, joint, lid, cover, or door has a crack or gap, or is broken.

(2) The owner or operator shall inspect for the control equipment failures in paragraphs (g)(1)(i) through (g)(1)(viii) of this section according to the schedule specified in paragraphs (c) and (d) of this section.

(3) The owner or operator shall inspect for the control equipment failures in paragraph (g)(1)(ix) of this section initially, and semi-annually thereafter.

(h) Except as provided in §63.140 of this subpart, when an improper work practice or a control equipment failure is identified, first efforts at repair shall be made no later than 5 calendar days after identification and repair shall be completed within 45 calendar days after identification. If a failure that is detected during inspections required by this section cannot be repaired within 45 calendar days and if the vessel cannot be emptied within 45 calendar days, the owner or operator may utilize up to 2 extensions of up to 30 additional calendar days each. Documentation of a decision to utilize an extension shall include a description of the failure, shall document that alternate storage capacity is unavailable, and shall specify a schedule of actions that will ensure that the control equipment will be repaired or the vessel will be emptied as soon as practical.

[62 FR 2753, Jan. 17, 1997, as amended at 64 FR 20191, Apr. 26, 1999]

§ 63.134 Process wastewater provisions—surface impoundments.

(a) For each surface impoundment that receives, manages, or treats a Group 1 wastewater stream or a residual removed from a Group 1 wastewater stream, the owner or operator shall comply with the requirements of paragraphs (b), (c), and (d) of this section.

(b) The owner or operator shall operate and maintain on each surface impoundment either a cover (e.g., air-supported structure or rigid cover) and a closed-vent system that routes the organic hazardous air pollutants vapors vented from the surface impoundment to a control device in accordance with paragraph (b)(1) of this section, or a floating flexible membrane cover as specified in paragraph (b)(2) of this section.

(1) The cover and all openings shall meet the following requirements:

(i) Except as provided in paragraph (b)(4) of this section, the cover and all openings (e.g., access hatches, sampling ports, and gauge wells) shall be maintained in accordance with the requirements specified in §63.148 of this subpart.

(ii) Each opening shall be maintained in a closed position (e.g., covered by a lid) at all times that a Group 1 wastewater stream or residual removed from a Group 1 wastewater stream is in the surface impoundment except when it is necessary to use the opening for sampling, removal, or for equipment inspection, maintenance, or repair.

(iii) The cover shall be used at all times that a Group 1 wastewater stream or residual removed from a Group 1 wastewater stream is in the surface impoundment except during removal of treatment residuals in accordance with 40 CFR 268.4 or closure of the surface impoundment in accordance with 40 CFR 264.228.

(2) Floating flexible membrane covers shall meet the requirements specified in paragraphs (b)(2)(i) through (b)(2)(vii) of this section.

(i) The floating flexible cover shall be designed to float on the liquid surface during normal operations, and to form a continuous barrier over the entire surface area of the liquid.

(ii) The cover shall be fabricated from a synthetic membrane material that is either:

(A) High density polyethylene (HDPE) with a thickness no less than 2.5 millimeters (100 mils); or

(B) A material or a composite of different materials determined to have both organic permeability properties that are equivalent to those of the material listed in paragraph (b)(2)(ii)(A) of this section, and chemical and physical properties that maintain the material integrity for the intended service life of the material.

(iii) The cover shall be installed in a manner such that there are no visible cracks, holes, gaps, or other open spaces between cover section seams or between the interface of the cover edge and its foundation mountings.

(iv) Except as provided for in paragraph (b)(2)(v) of this section, each opening in the floating membrane cover shall be equipped with a closure device designed to operate such that when the closure device is secured in the closed position there are no visible cracks, holes, gaps, or other open spaces in the closure device or between the perimeter of the cover opening and the closure device.

(v) The floating membrane cover may be equipped with one or more emergency cover drains for removal of stormwater. Each emergency cover drain shall be equipped with a slotted membrane fabric cover that covers at least 90 percent of the area of the opening or a flexible fabric sleeve seal.

(vi) The closure devices shall be made of suitable materials that will minimize exposure of organic hazardous air pollutants to the atmosphere, to the extent practical, and will maintain the integrity of the equipment throughout its intended service life. Factors to be considered in designing the closure devices shall include: The effects of any contact with the liquid and its vapor managed in the surface impoundment; the effects of outdoor exposure to wind, moisture, and sunlight; and the operating practices used for the surface impoundment on which the floating membrane cover is installed.

(vii) Whenever a Group 1 wastewater stream or residual from a Group 1 wastewater stream is in the surface impoundment, the floating membrane cover shall float on the liquid and each closure device shall be secured in the closed position. Opening of closure devices or removal of the cover is allowed to provide access to the surface impoundment for performing routine inspection, maintenance, or other activities needed for normal operations and/or to remove accumulated sludge or other residues from the bottom of surface impoundment. Openings shall be maintained in accordance with §63.148 of this subpart.

(3) The control device shall be designed, operated, and inspected in accordance with §63.139 of this subpart.

(4) Except as provided in paragraph (b)(5) of this section, the closed-vent system shall be inspected in accordance with §63.148 of this subpart.

(5) For any cover and closed-vent system that is operated and maintained under negative pressure, the owner or operator is not required to comply with the requirements specified in §63.148 of this subpart.

(c) Each surface impoundment shall be inspected initially, and semi-annually thereafter, for improper work practices and control equipment failures in accordance with §63.143 of this subpart.

(1) For surface impoundments, improper work practice includes, but is not limited to, leaving open any access hatch or other opening when such hatch or opening is not in use.

(2) For surface impoundments, control equipment failure includes, but is not limited to, any time a joint, lid, cover, or door has a crack or gap, or is broken.

(d) Except as provided in §63.140 of this subpart, when an improper work practice or a control equipment failure is identified, first efforts at repair shall be made no later than 5 calendar days after identification and repair shall be completed within 45 calendar days after identification.

[62 FR 2754, Jan. 17, 1997, as amended at 64 FR 20191, Apr. 26, 1999]

§ 63.135 Process wastewater provisions—containers.

(a) For each container that receives, manages, or treats a Group 1 wastewater stream or a residual removed from a Group 1 wastewater stream, the owner or operator shall comply with the requirements of paragraphs (b) through (f) of this section.

(b) The owner or operator shall operate and maintain a cover on each container used to handle, transfer, or store a Group 1 wastewater stream or residual removed from a Group 1 wastewater stream in accordance with the following requirements:

(1) Except as provided in paragraph (d)(4) of this section, if the capacity of the container is greater than 0.42 m³, the cover and all openings (e.g., bungs, hatches, sampling ports, and pressure relief devices) shall be maintained in accordance with the requirements specified in §63.148 of this subpart.

(2) If the capacity of the container is less than or equal to 0.42 m³, the owner or operator shall comply with either paragraph (b)(2)(i) or (b)(2)(ii) of this section.

(i) The container must meet existing Department of Transportation specifications and testing requirements under 49 CFR part 178; or

(ii) Except as provided in paragraph (d)(4) of this section, the cover and all openings shall be maintained without leaks as specified in §63.148 of this subpart.

(3) The cover and all openings shall be maintained in a closed position (e.g., covered by a lid) at all times that a Group 1 wastewater stream or residual removed from a Group 1 wastewater stream is in the container except when it is necessary to use the opening for filling, removal, inspection, sampling, or pressure relief events related to safety considerations.

(c) For containers with a capacity greater than or equal to 0.42 m³, a submerged fill pipe shall be used when a container is being filled by pumping with a Group 1 wastewater stream or residual removed from a Group 1 wastewater stream.

(1) The submerged fill pipe outlet shall extend to no more than 6 inches or within two fill pipe diameters of the bottom of the container while the container is being filled.

(2) The cover shall remain in place and all openings shall be maintained in a closed position except for those openings required for the submerged fill pipe and for venting of the container to prevent physical damage or permanent deformation of the container or cover.

(d) During treatment of a Group 1 wastewater stream or residual removed from a Group 1 wastewater stream, including aeration, thermal or other treatment, in a container, whenever it is necessary for the container to be open, the container shall be located within an enclosure with a closed-vent system that routes the organic hazardous air pollutants vapors vented from the container to a control device.

(1) Except as provided in paragraph (d)(4) of this section, the enclosure and all openings (e.g., doors, hatches) shall be maintained in accordance with the requirements specified in §63.148 of this subpart.

(2) The control device shall be designed, operated, and inspected in accordance with §63.139 of this subpart.

(3) Except as provided in paragraph (d)(4) of this section, the closed-vent system shall be inspected in accordance with §63.148 of this subpart.

(4) For any enclosure and closed-vent system that is operated and maintained under negative pressure, the owner or operator is not required to comply with the requirements specified in §63.148 of this subpart.

(e) Each container shall be inspected initially, and semi-annually thereafter, for improper work practices and control equipment failures in accordance with §63.143 of this subpart.

(1) For containers, improper work practice includes, but is not limited to, leaving open any access hatch or other opening when such hatch or opening is not in use.

(2) For containers, control equipment failure includes, but is not limited to, any time a cover or door has a gap or crack, or is broken.

(f) Except as provided in §63.140 of this subpart, when an improper work practice or a control equipment failure is identified, first efforts at repair shall be made no later than 5 calendar days after identification and repair shall be completed within 15 calendar days after identification.

[62 FR 2755, Jan. 17, 1997]

§ 63.136 Process wastewater provisions—individual drain systems.

(a) For each individual drain system that receives or manages a Group 1 wastewater stream or a residual removed from a Group 1 wastewater stream, the owner or operator shall comply with the requirements of paragraphs (b), (c), and (d) or with paragraphs (e), (f), and (g) of this section.

(b) If the owner or operator elects to comply with this paragraph, the owner or operator shall operate and maintain on each opening in the individual drain system a cover and if vented, route the vapors to a process or through a closed vent system to a control device. The owner or operator shall comply with the requirements of paragraphs (b)(1) through (b)(5) of this section.

(1) The cover and all openings shall meet the following requirements:

(i) Except as provided in paragraph (b)(4) of this section, the cover and all openings (e.g., access hatches, sampling ports) shall be maintained in accordance with the requirements specified in §63.148 of this subpart.

(ii) The cover and all openings shall be maintained in a closed position at all times that a Group 1 wastewater stream or residual removed from a Group 1 wastewater stream is in the drain system except when it is necessary to use the opening for sampling or removal, or for equipment inspection, maintenance, or repair.

(2) The control device shall be designed, operated, and inspected in accordance with §63.139 of this subpart.

(3) Except as provided in paragraph (b)(4) of this section, the closed-vent system shall be inspected in accordance with §63.148 of this subpart.

(4) For any cover and closed-vent system that is operated and maintained under negative pressure, the owner or operator is not required to comply with the requirements specified in §63.148 of this subpart.

(5) The individual drain system shall be designed and operated to segregate the vapors within the system from other drain systems and the atmosphere.

(c) Each individual drain system shall be inspected initially, and semi-annually thereafter, for improper work practices and control equipment failures, in accordance with the inspection requirements specified in table 11 of this subpart.

(1) For individual drain systems, improper work practice includes, but is not limited to, leaving open any access hatch or other opening when such hatch or opening is not in use for sampling or removal, or for

equipment inspection, maintenance, or repair.

(2) For individual drain systems, control equipment failure includes, but is not limited to, any time a joint, lid, cover, or door has a gap or crack, or is broken.

(d) Except as provided in §63.140 of this subpart, when an improper work practice or a control equipment failure is identified, first efforts at repair shall be made no later than 5 calendar days after identification and repair shall be completed within 15 calendar days after identification.

(e) If the owner or operator elects to comply with this paragraph, the owner or operator shall comply with the requirements in paragraphs (e)(1) through (e)(3) of this section:

(1) Each drain shall be equipped with water seal controls or a tightly fitting cap or plug. The owner or operator shall comply with paragraphs (e)(1)(i) and (e)(1)(ii) of this section.

(i) For each drain equipped with a water seal, the owner or operator shall ensure that the water seal is maintained. For example, a flow-monitoring device indicating positive flow from a main to a branch water line supplying a trap or water being continuously dripped into the trap by a hose could be used to verify flow of water to the trap. Visual observation is also an acceptable alternative.

(ii) If a water seal is used on a drain receiving a Group 1 wastewater, the owner or operator shall either extend the pipe discharging the wastewater below the liquid surface in the water seal of the receiving drain, or install a flexible shield (or other enclosure which restricts wind motion across the open area between the pipe and the drain) that encloses the space between the pipe discharging the wastewater to the drain receiving the wastewater. (Water seals which are used on hubs receiving Group 2 wastewater for the purpose of eliminating cross ventilation to drains carrying Group 1 wastewater are not required to have a flexible cap or extended subsurface discharging pipe.)

(2) Each junction box shall be equipped with a tightly fitting solid cover (i.e., no visible gaps, cracks, or holes) which shall be kept in place at all times except during inspection and maintenance. If the junction box is vented, the owner or operator shall comply with the requirements in paragraph (e)(2)(i) or (e)(2)(ii) of this section.

(i) The junction box shall be vented to a process or through a closed vent system to a control device. The closed vent system shall be inspected in accordance with the requirements of §63.148 and the control device shall be designed, operated, and inspected in accordance with the requirements of §63.139.

(ii) If the junction box is filled and emptied by gravity flow (i.e., there is no pump) or is operated with no more than slight fluctuations in the liquid level, the owner or operator may vent the junction box to the atmosphere provided that the junction box complies with the requirements in paragraphs (e)(2)(ii)(A) and (e)(2)(ii)(B) of this section.

(A) The vent pipe shall be at least 90 centimeters in length and no greater than 10.2 centimeters in nominal inside diameter.

(B) Water seals shall be installed and maintained at the wastewater entrance(s) to or exit from the junction box restricting ventilation in the individual drain system and between components in the individual drain system. The owner or operator shall demonstrate (e.g., by visual inspection or smoke test) upon request by the Administrator that the junction box water seal is properly designed and restricts ventilation.

(3) Each sewer line shall not be open to the atmosphere and shall be covered or enclosed in a manner so as to have no visible gaps or cracks in joints, seals, or other emission interfaces.

(f) Equipment used to comply with paragraphs (e)(1), (e)(2), or (e)(3) of this section shall be inspected as follows:

(1) Each drain using a tightly fitting cap or plug shall be visually inspected initially, and semi-annually thereafter, to ensure caps or plugs are in place and that there are no gaps, cracks, or other holes in the cap or plug.

(2) Each junction box shall be visually inspected initially, and semi-annually thereafter, to ensure that there are no gaps, cracks, or other holes in the cover.

(3) The unburied portion of each sewer line shall be visually inspected initially, and semi-annually thereafter, for indication of cracks or gaps that could result in air emissions.

(g) Except as provided in §63.140 of this subpart, when a gap, hole, or crack is identified in a joint or cover, first efforts at repair shall be made no later than 5 calendar days after identification, and repair shall be completed within 15 calendar days after identification.

[62 FR 2755, Jan. 17, 1997]

§ 63.137 Process wastewater provisions—oil-water separators.

(a) For each oil-water separator that receives, manages, or treats a Group 1 wastewater stream or a residual removed from a Group 1 wastewater stream, the owner or operator shall comply with the requirements of paragraphs (c) and (d) of this section and shall operate and maintain one of the following:

(1) A fixed roof and a closed vent system that routes the organic hazardous air pollutants vapors vented from the oil-water separator to a control device. The fixed roof, closed-vent system, and control device shall meet the requirements specified in paragraph (b) of this section;

(2) A floating roof meeting the requirements in 40 CFR part 60, subpart QQQ §60.693–2 (a)(1)(i), (a)(1)(ii), (a)(2), (a)(3), and (a)(4). For portions of the oil-water separator where it is infeasible to construct and operate a floating roof, such as over the weir mechanism, the owner or operator shall operate and maintain a fixed roof, closed vent system, and control device that meet the requirements specified in paragraph (b) of this section.

(3) An equivalent means of emission limitation. Determination of equivalence to the reduction in emissions achieved by the requirements of paragraphs (a)(1) and (a)(2) of this section will be evaluated according to §63.102(b) of subpart F of this part. The determination will be based on the application to the Administrator which shall include the information specified in either paragraph (a)(3)(i) or (a)(3)(ii) of this section.

(i) Actual emissions tests that use full-size or scale-model oil-water separators that accurately collect and measure all organic hazardous air pollutants emissions from a given control technique, and that accurately simulate wind and account for other emission variables such as temperature and barometric pressure, or

(ii) An engineering evaluation that the Administrator determines is an accurate method of determining equivalence.

(b) If the owner or operator elects to comply with the requirements of paragraphs (a)(1) or (a)(2) of this section, the fixed roof shall meet the requirements of paragraph (b)(1) of this section, the control device shall meet the requirements of paragraph (b)(2) of this section, and the closed-vent system shall meet the requirements of paragraph (b)(3) of this section.

(1) The fixed-roof shall meet the following requirements:

(i) Except as provided in paragraph (b)(4) of this section, the fixed roof and all openings (e.g., access hatches, sampling ports, and gauge wells) shall be maintained in accordance with the requirements specified in §63.148 of this subpart.

(ii) Each opening shall be maintained in a closed, sealed position (e.g., covered by a lid that is gasketed and latched) at all times that the oil-water separator contains a Group 1 wastewater stream or residual removed from a Group 1 wastewater stream except when it is necessary to use the opening for sampling or removal, or for equipment inspection, maintenance, or repair.

(2) The control device shall be designed, operated, and inspected in accordance with the requirements

of §63.139 of this subpart.

(3) Except as provided in paragraph (b)(4) of this section, the closed-vent system shall be inspected in accordance with the requirements of §63.148 of this subpart.

(4) For any fixed roof and closed-vent system that is operated and maintained under negative pressure, the owner or operator is not required to comply with the requirements of §63.148 of this subpart.

(c) If the owner or operator elects to comply with the requirements of paragraph (a)(2) of this section, seal gaps shall be measured according to the procedures specified in 40 CFR part 60, subpart QQQ §60.696(d)(1) and the schedule specified in paragraphs (c)(1) and (c)(2) of this section.

(1) Measurement of primary seal gaps shall be performed within 60 calendar days after installation of the floating roof and introduction of a Group 1 wastewater stream or residual removed from a Group 1 wastewater stream and once every 5 years thereafter.

(2) Measurement of secondary seal gaps shall be performed within 60 calendar days after installation of the floating roof and introduction of a Group 1 wastewater stream or residual removed from a Group 1 wastewater stream and once every year thereafter.

(d) Each oil-water separator shall be inspected initially, and semi-annually thereafter, for improper work practices in accordance with §63.143 of this subpart. For oil-water separators, improper work practice includes, but is not limited to, leaving open or ungasketed any access door or other opening when such door or opening is not in use.

(e) Each oil-water separator shall be inspected for control equipment failures as defined in paragraph (e)(1) of this section according to the schedule specified in paragraphs (e)(2) and (e)(3) of this section.

(1) For oil-water separators, control equipment failure includes, but is not limited to, the conditions specified in paragraphs (e)(1)(i) through (e)(1)(vii) of this section.

(i) The floating roof is not resting on either the surface of the liquid or on the leg supports.

(ii) There is stored liquid on the floating roof.

(iii) A rim seal is detached from the floating roof.

(iv) There are holes, tears, or other open spaces in the rim seal or seal fabric of the floating roof.

(v) There are gaps between the primary seal and the separator wall that exceed 67 square centimeters per meter of separator wall perimeter or the width of any portion of any gap between the primary seal and the separator wall exceeds 3.8 centimeters.

(vi) There are gaps between the secondary seal and the separator wall that exceed 6.7 square centimeters per meter of separator wall perimeter or the width of any portion of any gap between the secondary seal and the separator wall exceeds 1.3 centimeters.

(vii) A gasket, joint, lid, cover, or door has a gap or crack, or is broken.

(2) The owner or operator shall inspect for the control equipment failures in paragraphs (e)(1)(i) through (e)(1)(vi) of this section according to the schedule specified in paragraph (c) of this section.

(3) The owner or operator shall inspect for control equipment failures in paragraph (e)(1)(vii) of this section initially, and semi-annually thereafter.

(f) Except as provided in §63.140 of this subpart, when an improper work practice or a control equipment failure is identified, first efforts at repair shall be made no later than 5 calendar days after identification and repair shall be completed within 45 calendar days after identification.

[62 FR 2756, Jan. 17, 1997]

§ 63.138 Process wastewater provisions—performance standards for treatment processes managing Group 1 wastewater streams and/or residuals removed from Group 1 wastewater streams.

(a) *General requirements.* This section specifies the performance standards for treating Group 1 wastewater streams. The owner or operator shall comply with the requirements as specified in paragraphs (a)(1) through (a)(6) of this section. Where multiple compliance options are provided, the options may be used in combination for different wastewater streams and/or for different compounds (e.g., Table 8 versus Table 9 compounds) in the same wastewater streams, except where otherwise provided in this section. Once a Group 1 wastewater stream or residual removed from a Group 1 wastewater stream has been treated in accordance with this subpart, it is no longer subject to the requirements of this subpart.

(1) *Existing source.* If the wastewater stream, at an existing source, is Group 1 for Table 9 compounds, comply with §63.138(b).

(2) *New source.* If the wastewater stream, at a new source, is Group 1 for Table 8 compounds, comply with §63.138(c). If the wastewater stream, at a new source, is Group 1 for Table 9 compounds, comply with §63.138(b). If the wastewater stream, at a new source, is Group 1 for Table 8 and Table 9 compounds, comply with both §63.138(b) and §63.138(c).

Note to paragraph(a)(2): The requirements for Table 8 and/or Table 9 compounds are similar and often identical.

(3) *Biological treatment processes.* Biological treatment processes in compliance with this section may be either open or closed biological treatment processes as defined in §63.111. An open biological treatment process in compliance with this section need not be covered and vented to a control device as required in §63.133 through §63.137 of this subpart. An open or a closed biological treatment process in compliance with this section and using §63.145(f) or §63.145(g) of this subpart to demonstrate compliance is not subject to the requirements of §63.133 through §63.137 of this subpart. A closed biological treatment process in compliance with this section and using §63.145(e) of this subpart to demonstrate compliance shall comply with the requirements of §63.133 through §63.137 of this subpart. Waste management units upstream of an open or closed biological treatment process shall meet the requirements of §63.133 through §63.137 of this subpart, as applicable.

(4) *Performance tests and design evaluations.* If design steam stripper option (§63.138(d)) or Resource Conservation and Recovery Act (RCRA) option (§63.138(h)) is selected to comply with this section, neither a design evaluation nor a performance test is required. For any other non-biological treatment process, and for closed biological treatment processes as defined in §63.111 of this subpart, the owner or operator shall conduct either a design evaluation as specified in §63.138(j), or a performance test as specified in §63.145, of this subpart. For each open biological treatment process as defined in §63.111 of this subpart, the owner or operator shall conduct a performance test as specified in §63.145 of this subpart.

Note to paragraph(a)(4): Some open biological treatment processes may not require a performance test. Refer to §63.145(h) and table 36 of this subpart to determine whether the biological treatment process meets the criteria that exempt the owner or operator from conducting a performance test.

(5) *Control device requirements.* When gases are vented from the treatment process, the owner or operator shall comply with the applicable control device requirements specified in §63.139 and §63.145 (i) and (j), and the applicable leak inspection provisions specified in §63.148, of this subpart. This requirement does not apply to any open biological treatment process that meets the mass removal requirements. Vents from anaerobic biological treatment processes may be routed through hard-piping to a fuel gas system.

(6) *Residuals: general.* When residuals result from treating Group 1 wastewater streams, the owner or operator shall comply with the requirements for residuals specified in §63.138(k) of this subpart.

(7) *Treatment using a series of treatment processes.* In all cases where the wastewater provisions in this subpart allow or require the use of a treatment process or control device to comply with emissions limitations, the owner or operator may use multiple treatment processes or control devices, respectively. For combinations of treatment processes where the wastewater stream is conveyed by hard-piping, the owner or operator shall comply with either the requirements of paragraph (a)(7)(i) or (a)(7)(ii) of this section. For combinations of treatment processes where the wastewater stream is not conveyed by hard-piping, the owner or operator shall comply with the requirements of paragraph (a)(7)(ii) of this section. For combinations of control devices, the owner or operator shall comply with the requirements of paragraph (a)(7)(i) of this section.

(i)(A) For combinations of treatment processes, the wastewater stream shall be conveyed by hard-piping between the treatment processes. For combinations of control devices, the vented gas stream shall be conveyed by hard-piping between the control devices.

(B) For combinations of treatment processes, each treatment process shall meet the applicable requirements of §63.133 through §63.137 of this subpart except as provided in paragraph (a)(3) of this section.

(C) The owner or operator shall identify, and keep a record of, the combination of treatment processes or of control devices, including identification of the first and last treatment process or control device. The owner or operator shall include this information as part of the treatment process description reported in the Notification of Compliance Status.

(D) The performance test or design evaluation shall determine compliance across the combination of treatment processes or control devices. If a performance test is conducted, the "inlet" shall be the point at which the wastewater stream or residual enters the first treatment process, or the vented gas stream enters the first control device. The "outlet" shall be the point at which the treated wastewater stream exits the last treatment process, or the vented gas stream exits the last control device.

(ii)(A) For combinations of treatment processes, each treatment process shall meet the applicable requirements of §63.133 through §63.137 of this subpart except as provided in paragraph (a)(3) of this section.

(B) The owner or operator shall identify, and keep a record of, the combination of treatment processes, including identification of the first and last treatment process. The owner or operator shall include this information as part of the treatment process description reported in the Notification of Compliance Status.

(C) The owner or operator shall determine the mass removed or destroyed by each treatment process. The performance test or design evaluation shall determine compliance for the combination of treatment processes by adding together the mass removed or destroyed by each treatment process.

(b) *Control options: Group 1 wastewater streams for Table 9 compounds.* The owner or operator shall comply with either paragraph (b)(1) or (b)(2) of this section for the control of Table 9 compounds at new or existing sources.

(1) *50 ppmw concentration option.* The owner or operator shall comply with paragraphs (b)(1)(i) and (b)(1)(ii) of this section.

(i) Reduce, by removal or destruction, the total concentration of Table 9 compounds to a level less than 50 parts per million by weight as determined by the procedures specified in §63.145(b) of this subpart.

(ii) This option shall not be used when the treatment process is a biological treatment process. This option shall not be used when the wastewater stream is designated as a Group 1 wastewater stream as specified in §63.132(e). Dilution shall not be used to achieve compliance with this option.

(2) *Other compliance options.* Comply with the requirements specified in any one of paragraphs (d), (e), (f), (g), (h), or (i) of this section.

(c) *Control options: Group 1 wastewater streams for Table 8 compounds.* The owner or operator shall comply with either paragraph (c)(1) or (c)(2) of this section for the control of Table 8 compounds at new

sources.

(1) *10 ppmw concentration option.* The owner or operator shall comply with paragraphs (c)(1)(i) and (c)(1)(ii) of this section.

(i) Reduce, by removal or destruction, the concentration of the individual Table 8 compounds to a level less than 10 parts per million by weight as determined in the procedures specified in §63.145(b) of this subpart.

(ii) This option shall not be used when the treatment process is a biological treatment process. This option shall not be used when the wastewater stream is designated as a Group 1 wastewater stream as specified in §63.132(e). Dilution shall not be used to achieve compliance with this option.

(2) *Other compliance options.* Comply with the requirements specified in any one of paragraphs (d), (e), (f), (g), (h), or (i) of this section.

(d) *Design steam stripper option.* The owner or operator shall operate and maintain a steam stripper that meets the requirements of paragraphs (d)(1) through (d)(6) of this section.

(1) Minimum active column height of 5 meters,

(2) Countercurrent flow configuration with a minimum of 10 actual trays,

(3) Minimum steam flow rate of 0.04 kilograms of steam per liter of wastewater feed within the column,

(4) Minimum wastewater feed temperature to the steam stripper of 95 °C, or minimum column operating temperature of 95 °C,

(5) Maximum liquid loading of 67,100 liters per hour per square meter, and

(6) Operate at nominal atmospheric pressure.

(e) *Percent mass removal/destruction option.* The owner or operator of a new or existing source shall comply with paragraph (e)(1) or (e)(2) of this section for control of Table 8 and/or Table 9 compounds for Group 1 wastewater streams. This option shall not be used for biological treatment processes.

(1) *Reduce mass flow rate of Table 8 and/or Table 9 compounds by 99 percent.* For wastewater streams that are Group 1, the owner or operator shall reduce, by removal or destruction, the mass flow rate of Table 8 and/or Table 9 compounds by 99 percent or more. The removal/destruction efficiency shall be determined by the procedures specified in §63.145(c), for noncombustion processes, or §63.145(d), for combustion processes.

(2) *Reduce mass flow rate of Table 8 and/or Table 9 compounds by Fr value.* For wastewater streams that are Group 1 for Table 8 and/or Table 9 compounds, the owner or operator shall reduce, by removal or destruction, the mass flow rate by at least the fraction removal (Fr) values specified in Table 9 of this subpart. (The Fr values for Table 8 compounds are all 0.99.) The removal/destruction efficiency shall be determined by the procedures specified in §63.145(c), for noncombustion treatment processes, or §63.145(d), for combustion treatment processes.

(f) *Required mass removal (RMR) option.* The owner or operator shall achieve the required mass removal (RMR) of Table 8 compounds at a new source for a wastewater stream that is Group 1 for Table 8 compounds and/or of Table 9 compounds at a new or existing source for a wastewater stream that is Group 1 for Table 9 compounds. For nonbiological treatment processes compliance shall be determined using the procedures specified in §63.145(e) of this subpart. For aerobic biological treatment processes compliance shall be determined using the procedures specified in §63.145 (e) or (f) of this subpart. For closed anaerobic biological treatment processes compliance shall be determined using the procedures specified in §63.145(e) of this subpart. For open biological treatment processes compliance shall be determined using the procedures specified in §63.145(f) of this subpart.

(g) *95-percent RMR option, for biological treatment processes.* The owner or operator of a new or

existing source using biological treatment for at least one wastewater stream that is Group 1 for Table 9 compounds shall achieve a RMR of at least 95 percent for all Table 9 compounds. The owner or operator of a new source using biological treatment for at least one wastewater stream that is Group 1 for Table 8 compounds shall achieve a RMR of at least 95 percent for all Table 8 compounds. All Group 1 and Group 2 wastewater streams entering a biological treatment unit that are from chemical manufacturing process units subject to subpart F shall be included in the demonstration of the 95-percent mass removal. The owner or operator shall comply with paragraphs (g)(1) through (g)(4) of this section.

(1) Except as provided in paragraph (g)(4) of this section, the owner or operator shall ensure that all Group 1 and Group 2 wastewater streams from chemical manufacturing process units subject to this rule entering a biological treatment unit are treated to destroy at least 95-percent total mass of all Table 8 and/or Table 9 compounds.

(2) For open biological treatment processes compliance shall be determined using the procedures specified in §63.145(g) of this subpart. For closed aerobic biological treatment processes compliance shall be determined using the procedures specified in §63.145 (e) or (g) of this subpart. For closed anaerobic biological treatment processes compliance shall be determined using the procedures specified in §63.145(e) of this subpart.

(3) For each treatment process or waste management unit that receives, manages, or treats wastewater streams subject to this paragraph, from the point of determination of each Group 1 or Group 2 wastewater stream to the biological treatment unit, the owner or operator shall comply with §§63.133 through §63.137 of this subpart for control of air emissions. When complying with this paragraph, the term Group 1, whether used alone or in combination with other terms, in §63.133 through §63.137 of this subpart shall mean both Group 1 and Group 2.

(4) If a wastewater stream is in compliance with the requirements in paragraph (b)(1), (c)(1), (d), (e), (f), or (h) of this section before entering the biological treatment unit, the hazardous air pollutants mass of that wastewater is not required to be included in the total mass flow rate entering the biological treatment unit for the purpose of demonstrating compliance.

(h) *Treatment in a RCRA unit option.* The owner or operator shall treat the wastewater stream or residual in a unit identified in, and complying with, paragraph (h)(1), (h)(2), or (h)(3) of this section. These units are exempt from the design evaluation or performance tests requirements specified in §63.138(a)(3) and §63.138(j) of this subpart, and from the monitoring requirements specified in §63.132 (a)(2)(iii) and §63.132(b)(3)(iii) of this subpart, as well as recordkeeping and reporting requirements associated with monitoring and performance tests.

(1) The wastewater stream or residual is discharged to a hazardous waste incinerator for which the owner or operator has been issued a final permit under 40 CFR part 270 and complies with the requirements of 40 CFR part 264, subpart O, or has certified compliance with the interim status requirements of 40 CFR part 265, subpart O;

(2) The wastewater stream or residual is discharged to a process heater or boiler burning hazardous waste for which the owner or operator:

(i) Has been issued a final permit under 40 CFR part 270 and complies with the requirements of 40 CFR part 266, subpart H; or

(ii) Has certified compliance with the interim status requirements of 40 CFR part 266, subpart H.

(3) The wastewater stream or residual is discharged to an underground injection well for which the owner or operator has been issued a final permit under 40 CFR part 270 or 40 CFR part 144 and complies with the requirements of 40 CFR part 122. The owner or operator shall comply with all applicable requirements of this subpart prior to the point where the wastewater enters the underground portion of the injection well.

(i) *One megagram total source mass flow rate option.* A wastewater stream is exempt from the requirements of paragraphs (b) and (c) of this section if the owner or operator elects to comply with either paragraph (i)(1) or (2) of this section, and complies with paragraph (i)(3) of this section.

(1) *All Group 1 wastewater streams at the source.* The owner or operator shall demonstrate that the total source mass flow rate for Table 8 and/or Table 9 compounds is less than 1 megagram per year using the procedures in paragraphs (i)(1)(i) and (i)(1)(ii) of this section. The owner or operator shall include all Group 1 wastewater streams at the source in the total source mass flow rate. The total source mass flow rate shall be based on the mass as calculated before the wastewater stream is treated. The owner or operator who meets the requirements of this paragraph (i)(1) is exempt from the requirements of §§63.133 through 63.137.

(i) Calculate the annual average mass flow rate for each Group 1 wastewater stream by multiplying the annual average flow rate of the wastewater stream, as determined by procedures specified in §63.144(c), times the total annual average concentration of Table 8 and/or Table 9 compounds, as determined by procedures specified in §63.144(b) of this subpart. (The mass flow rate of compounds in a wastewater stream that is Group 1 for both Table 8 and Table 9 compounds should be included in the annual average mass flow rate only once.)

(ii) Calculate the total source mass flow rate from all Group 1 wastewater streams by adding together the annual average mass flow rate calculated for each Group 1 wastewater stream.

(2) *Untreated and partially treated Group 1 wastewater streams.* The owner or operator shall demonstrate that the total source mass flow rate for untreated Group 1 wastewater streams and Group 1 wastewater streams treated to levels less stringent than required in paragraph (b) or (c) of this section is less than 1 megagram per year using the procedures in paragraphs (i)(2)(i) and (i)(2)(ii) of this section. The owner or operator shall manage these wastewater streams in accordance with paragraph (i)(2)(iii) of this section, and shall comply with paragraph (i)(3) of this section.

(i) Calculate the annual average mass flow rate in each wastewater stream by multiplying the annual average flow rate of the wastewater stream, as determined by procedures specified in §63.144(c), times the total annual average concentration of Table 8 and/or Table 9 compounds, as determined by procedures specified in §63.144(b). (The mass flow rate of compounds in a wastewater stream that are Group 1 for both Table 8 and Table 9 compounds should be included in the annual average mass flow rate only once.) When determining the total source mass flow rate for the purposes of paragraph (i)(2)(i)(B) of this section, the concentration and flow rate shall be determined at the location specified in paragraph (i)(2)(i)(B) of this section and not at the location specified in §63.144(b) and (c).

(A) For each untreated Group 1 wastewater stream, the annual average flow rate and the total annual average concentration shall be determined for that stream's point of determination.

(B) For each Group 1 wastewater stream that is treated to levels less stringent than those required by paragraph (b) or (c) of this section, the annual average flow rate and total annual average concentration shall be determined at the discharge from the treatment process or series of treatment processes.

(C) The annual average mass flow rate for Group 1 wastewater streams treated to the levels required by paragraph (b) or (c) of this section is not included in the calculation of the total source mass flow rate.

(ii) The total source mass flow rate shall be calculated by summing the annual average mass flow rates from all Group 1 wastewater streams, except those excluded by paragraph (i)(2)(i)(C) of this section.

(iii) The owner or operator of each waste management unit that receives, manages, or treats a partially treated wastewater stream prior to or during treatment shall comply with the requirements of §§63.133 through 63.137, as applicable. For a partially treated wastewater stream that is stored, conveyed, treated, or managed in a waste management unit meeting the requirements of §§63.133 through 63.137, the owner or operator shall follow the procedures in paragraph (i)(2)(i)(B) of this section to calculate mass flow rate. A wastewater stream, either untreated or partially treated, where the mass flow rate has been calculated following the procedures in paragraph (i)(2)(i)(A) of this section, is exempt from the requirements of §§63.133 through 63.137.

(3) Wastewater streams included in this option shall be identified in the Notification of Compliance Status required by §63.152(b).

(j) *Design evaluations or performance tests for treatment processes.* Except as provided in paragraph (j)(3) or (h) of this section, the owner or operator shall demonstrate by the procedures in either paragraph (j)(1) or (j)(2) of this section that each nonbiological treatment process used to comply with paragraphs

(b)(1), (c)(1), (e), and/or (f) of this section achieves the conditions specified for compliance. The owner or operator shall demonstrate by the procedures in either paragraph (j)(1) or (j)(2) of this section that each closed biological treatment process used to comply with paragraphs (f) or (g) of this section achieves the conditions specified for compliance. If an open biological treatment unit is used to comply with paragraph (f) or (g) of this section, the owner or operator shall comply with §63.145(f) or §63.145(g), respectively, of this subpart. Some biological treatment processes may not require a performance test. Refer to §63.145(h) and table 36 of this subpart to determine whether the open biological treatment process meets the criteria that exempt the owner or operator from conducting a performance test.

(1) A design evaluation and supporting documentation that addresses the operating characteristics of the treatment process and that is based on operation at a representative wastewater stream flow rate and a concentration under which it would be most difficult to demonstrate compliance. For closed biological treatment processes, the actual mass removal shall be determined by a mass balance over the unit. The mass flow rate of Table 8 or Table 9 compounds exiting the treatment process shall be the sum of the mass flow rate of Table 8 or Table 9 compounds in the wastewater stream exiting the biological treatment process and the mass flow rate of the vented gas stream exiting the control device. The mass flow rate entering the treatment process minus the mass flow rate exiting the process determines the actual mass removal.

(2) Performance tests conducted using test methods and procedures that meet the applicable requirements specified in §63.145 of this subpart.

(3) The provisions of paragraphs (j)(1) and (j)(2) of this section do not apply to design stream strippers which meet the requirements of paragraph (d) of this section.

(k) *Residuals*. For each residual removed from a Group 1 wastewater stream, the owner or operator shall control for air emissions by complying with §§63.133–137 of this subpart and by complying with one of the provisions in paragraphs (k)(1) through (k)(4) of this section.

(1) Recycle the residual to a production process or sell the residual for the purpose of recycling. Once a residual is returned to a production process, the residual is no longer subject to this section.

(2) Return the residual to the treatment process.

(3) Treat the residual to destroy the total combined mass flow rate of Table 8 and/or Table 9 compounds by 99 percent or more, as determined by the procedures specified in §63.145(c) or (d) of this subpart.

(4) Comply with the requirements for RCRA treatment options specified in §63.138(h) of this subpart.

[62 FR 2757, Jan. 17, 1997, as amended at 66 FR 6933, Jan. 22, 2001]

§ 63.139 Process wastewater provisions—control devices.

(a) For each control device or combination of control devices used to comply with the provisions in §§63.133 through 63.138 of this subpart, the owner or operator shall operate and maintain the control device or combination of control devices in accordance with the requirements of paragraphs (b) through (f) of this section.

(b) Whenever organic hazardous air pollutants emissions are vented to a control device which is used to comply with the provisions of this subpart, such control device shall be operating.

(c) The control device shall be designed and operated in accordance with paragraph (c)(1), (c)(2), (c)(3), (c)(4), or (c)(5) of this section.

(1) An enclosed combustion device (including but not limited to a vapor incinerator, boiler, or process heater) shall meet the conditions in paragraph (c)(1)(i), (c)(1)(ii), or (c)(1)(iii) of this section, alone or in combination with other control devices. If a boiler or process heater is used as the control device, then the vent stream shall be introduced into the flame zone of the boiler or process heater.

(i) Reduce the total organic compound emissions, less methane and ethane, or total organic hazardous

air pollutants emissions vented to the control device by 95 percent by weight or greater;

(ii) Achieve an outlet total organic compound concentration, less methane and ethane, or total organic hazardous air pollutants concentration of 20 parts per million by volume on a dry basis corrected to 3 percent oxygen. The owner or operator shall use either Method 18 of 40 CFR part 60, appendix A, or any other method or data that has been validated according to the applicable procedures in Method 301 of appendix A of this part; or

(iii) Provide a minimum residence time of 0.5 seconds at a minimum temperature of 760 °C.

(2) A vapor recovery system (including but not limited to a carbon adsorption system or condenser), alone or in combination with other control devices, shall reduce the total organic compound emissions, less methane and ethane, or total organic hazardous air pollutants emissions vented to the control device of 95 percent by weight or greater or achieve an outlet total organic compound concentration, less methane and ethane, or total organic hazardous air pollutants concentration of 20 parts per million by volume, whichever is less stringent. The 20 parts per million by volume performance standard is not applicable to compliance with the provisions of §63.134 or §63.135 of this subpart.

(3) A flare shall comply with the requirements of §63.11(b) of subpart A of this part.

(4) A scrubber, alone or in combination with other control devices, shall reduce the total organic compound emissions, less methane and ethane, or total organic hazardous air pollutants emissions in such a manner that 95 weight-percent is either removed, or destroyed by chemical reaction with the scrubbing liquid or achieve an outlet total organic compound concentration, less methane and ethane, or total organic hazardous air pollutants concentration of 20 parts per million by volume, whichever is less stringent. The 20 parts per million by volume performance standard is not applicable to compliance with the provisions of §63.134 or §63.135 of this subpart.

(5) Any other control device used shall, alone or in combination with other control devices, reduce the total organic compound emissions, less methane and ethane, or total organic hazardous air pollutants emissions vented to the control device by 95 percent by weight or greater or achieve an outlet total organic compound concentration, less methane and ethane, or total organic hazardous air pollutants concentration of 20 parts per million by volume, whichever is less stringent. The 20 parts per million by volume performance standard is not applicable to compliance with the provisions of §63.134 or §63.135 of this subpart.

(d) Except as provided in paragraph (d)(4) of this section, an owner or operator shall demonstrate that each control device or combination of control devices achieves the appropriate conditions specified in paragraph (c) of this section by using one or more of the methods specified in paragraphs (d)(1), (d)(2), or (d)(3) of this section.

(1) Performance tests conducted using the test methods and procedures specified in §63.145(i) of this subpart for control devices other than flares; or

(2) A design evaluation that addresses the vent stream characteristics and control device operating parameters specified in paragraphs (d)(2)(i) through (d)(2)(vii) of this section.

(i) For a thermal vapor incinerator, the design evaluation shall consider the vent stream composition, constituent concentrations, and flow rate and shall establish the design minimum and average temperature in the combustion zone and the combustion zone residence time.

(ii) For a catalytic vapor incinerator, the design evaluation shall consider the vent stream composition, constituent concentrations, and flow rate and shall establish the design minimum and average temperatures across the catalyst bed inlet and outlet.

(iii) For a boiler or process heater, the design evaluation shall consider the vent stream composition, constituent concentrations, and flow rate; shall establish the design minimum and average flame zone temperatures and combustion zone residence time; and shall describe the method and location where the vent stream is introduced into the flame zone.

(iv) For a condenser, the design evaluation shall consider the vent stream composition, constituent

concentrations, flow rate, relative humidity, and temperature and shall establish the design outlet organic compound concentration level, design average temperature of the condenser exhaust vent stream, and the design average temperatures of the coolant fluid at the condenser inlet and outlet.

(v) For a carbon adsorption system that regenerates the carbon bed directly on-site in the control device such as a fixed-bed adsorber, the design evaluation shall consider the vent stream composition, constituent concentrations, flow rate, relative humidity, and temperature and shall establish the design exhaust vent stream organic compound concentration level, adsorption cycle time, number and capacity of carbon beds, type and working capacity of activated carbon used for carbon beds, design total regeneration stream mass or volumetric flow over the period of each complete carbon bed regeneration cycle, design carbon bed temperature after regeneration, design carbon bed regeneration time, and design service life of carbon.

(vi) For a carbon adsorption system that does not regenerate the carbon bed directly on-site in the control device such as a carbon canister, the design evaluation shall consider the vent stream composition, constituent concentrations, mass or volumetric flow rate, relative humidity, and temperature and shall establish the design exhaust vent stream organic compound concentration level, capacity of carbon bed, type and working capacity of activated carbon used for carbon bed, and design carbon replacement interval based on the total carbon working capacity of the control device and source operating schedule.

(vii) For a scrubber, the design evaluation shall consider the vent stream composition; constituent concentrations; liquid-to-vapor ratio; scrubbing liquid flow rate and concentration; temperature; and the reaction kinetics of the constituents with the scrubbing liquid. The design evaluation shall establish the design exhaust vent stream organic compound concentration level and will include the additional information in paragraphs (d)(2)(vii)(A) and (d)(2)(vii)(B) of this section for trays and a packed column scrubber.

(A) Type and total number of theoretical and actual trays;

(B) Type and total surface area of packing for entire column, and for individual packed sections if column contains more than one packed section.

(3) For flares, the compliance determination specified in §63.11(b) of subpart A of this part and §63.145(j) of this subpart.

(4) An owner or operator using any control device specified in paragraphs (d)(4)(i) through (d)(4)(iv) of this section is exempt from the requirements in paragraphs (d)(1) through (d)(3) of this section and from the requirements in §63.6(f) of subpart A of this part, and from the requirements of paragraph (e) of this section.

(i) A boiler or process heater with a design heat input capacity of 44 megawatts or greater.

(ii) A boiler or process heater into which the emission stream is introduced with the primary fuel.

(iii) A boiler or process heater burning hazardous waste for which the owner or operator:

(A) Has been issued a final permit under 40 CFR part 270 and complies with the requirements of 40 CFR part 266, subpart H, or

(B) Has certified compliance with the interim status requirements of 40 CFR part 266, subpart H.

(iv) A hazardous waste incinerator for which the owner or operator has been issued a final permit under 40 CFR part 270 and complies with the requirements of 40 CFR part 264, subpart O, or has certified compliance with the interim status requirements of 40 CFR part 265, subpart O.

(e) The owner or operator of a control device that is used to comply with the provisions of this section shall monitor the control device in accordance with §63.143 of this subpart.

(f) Except as provided in §63.140 of this subpart, if gaps, cracks, tears, or holes are observed in

ductwork, piping, or connections to covers and control devices during an inspection, a first effort to repair shall be made as soon as practical but no later than 5 calendar days after identification. Repair shall be completed no later than 15 calendar days after identification or discovery of the defect.

[62 FR 2760, Jan. 17, 1997, as amended at 64 FR 20192, Apr. 26, 1999]

§ 63.140 Process wastewater provisions—delay of repair.

(a) Delay of repair of equipment for which a control equipment failure or a gap, crack, tear, or hole has been identified, is allowed if the repair is technically infeasible without a shutdown, as defined in §63.101 of subpart F of this part, or if the owner or operator determines that emissions of purged material from immediate repair would be greater than the emissions likely to result from delay of repair. Repair of this equipment shall occur by the end of the next shutdown.

(b) Delay of repair of equipment for which a control equipment failure or a gap, crack, tear, or hole has been identified, is allowed if the equipment is emptied or is no longer used to treat or manage Group 1 wastewater streams or residuals removed from Group 1 wastewater streams.

(c) Delay of repair of equipment for which a control equipment failure or a gap, crack, tear, or hole has been identified is also allowed if additional time is necessary due to the unavailability of parts beyond the control of the owner or operator. Repair shall be completed as soon as practical. The owner or operator who uses this provision shall comply with the requirements of §63.147(b)(7) to document the reasons that the delay of repair was necessary.

[62 FR 2762, Jan. 17, 1997, as amended at 66 FR 6933, Jan. 22, 2001]

§§ 63.141-63.142 [Reserved]

§ 63.143 Process wastewater provisions—inspections and monitoring of operations.

(a) For each wastewater tank, surface impoundment, container, individual drain system, and oil-water separator that receives, manages, or treats a Group 1 wastewater stream, a residual removed from a Group 1 wastewater stream, a recycled Group 1 wastewater stream, or a recycled residual removed from a Group 1 wastewater stream, the owner or operator shall comply with the inspection requirements specified in table 11 of this subpart.

(b) For each design steam stripper and biological treatment unit used to comply with §63.138 of this subpart, the owner or operator shall comply with the monitoring requirements specified in table 12 of this subpart.

(c) If the owner or operator elects to comply with Item 1 in table 12 of this subpart, the owner or operator shall request approval to monitor appropriate parameters that demonstrate proper operation of the biological treatment unit. The request shall be submitted according to the procedures specified in §63.151(f) of this subpart, and shall include a description of planned reporting and recordkeeping procedures. The owner or operator shall include as part of the submittal the basis for the selected monitoring frequencies and the methods that will be used. The Administrator will specify appropriate reporting and recordkeeping requirements as part of the review of the permit application or by other appropriate means.

(d) If the owner or operator elects to comply with Item 3 in table 12 of this subpart, the owner or operator shall request approval to monitor appropriate parameters that demonstrate proper operation of the selected treatment process. The request shall be submitted according to the procedures specified in §63.151(f) of this subpart, and shall include a description of planned reporting and recordkeeping procedures. The Administrator will specify appropriate reporting and recordkeeping requirements as part of the review of the permit application or by other appropriate means.

(e) Except as provided in paragraphs (e)(4) and (e)(5) of this section, for each control device used to comply with the requirements of §§63.133 through 63.139 of this subpart, the owner or operator shall comply with the requirements in §63.139(d) of this subpart, and with the requirements specified in paragraph (e)(1), (e)(2), or (e)(3) of this section.

- (1) The owner or operator shall comply with the monitoring requirements specified in table 13 of this subpart; or
- (2) The owner or operator shall use an organic monitoring device installed at the outlet of the control device and equipped with a continuous recorder. Continuous recorder is defined in §63.111 of this subpart; or
- (3) The owner or operator shall request approval to monitor parameters other than those specified in paragraphs (e)(1) and (e)(2) of this section. The request shall be submitted according to the procedures specified in §63.151(f) of this subpart, and shall include a description of planned reporting and recordkeeping procedures. The Administrator will specify appropriate reporting and recordkeeping requirements as part of the review of the permit application or by other appropriate means.
- (4) For a boiler or process heater in which all vent streams are introduced with primary fuel, the owner or operator shall comply with the requirements in §63.139(d) of this subpart but the owner or operator is exempt from the monitoring requirements specified in paragraphs (e)(1) through (e)(3) of this section.
- (5) For a boiler or process heater with a design heat input capacity of 44 megawatts or greater, the owner or operator shall comply with the requirements in §63.139(d) of this subpart but the owner or operator is exempt from the monitoring requirements specified in paragraphs (e)(1) through (e)(3) of this section.
- (f) For each parameter monitored in accordance with paragraph (c), (d), or (e) of this section, the owner or operator shall establish a range that indicates proper operation of the treatment process or control device. In order to establish the range, the owner or operator shall comply with the requirements specified in §§63.146(b)(7)(ii)(A) and (b)(8)(ii) of this subpart.
- (g) Monitoring equipment shall be installed, calibrated, and maintained according to the manufacturer's specifications or other written procedures that provide adequate assurance that the equipment would reasonably be expected to monitor accurately.

[62 FR 2762, Jan. 17, 1997]

§ 63.144 Process wastewater provisions—test methods and procedures for determining applicability and Group 1/Group 2 determinations (determining which wastewater streams require control).

(a) *Procedures to determine applicability.* An owner or operator shall comply with paragraph (a)(1) or (a)(2) of this section for each wastewater stream to determine which wastewater streams require control for Table 8 and/or Table 9 compounds. The owner or operator may use a combination of the approaches in paragraphs (a)(1) and (a)(2) of this section for different wastewater streams generated at the source.

(1) *Determine Group 1 or Group 2 status.* Determine whether a wastewater stream is a Group 1 or Group 2 wastewater stream in accordance with paragraphs (b) and (c) of this section.

(2) *Designate as Group 1.* An owner or operator may designate as a Group 1 wastewater stream a single wastewater stream or a mixture of wastewater streams. The owner or operator is not required to determine the concentration or flow rate for each designated Group 1 wastewater stream for the purposes of this section.

(b) *Procedures to establish concentrations, when determining Group status under paragraph (a)(1) of this section.* An owner or operator who elects to comply with the requirements of paragraph (a)(1) of this section shall determine the annual average concentration for Table 8 and/or Table 9 compounds according to paragraph (b)(1) of this section for existing sources or paragraph (b)(2) of this section for new sources. The annual average concentration shall be a flow weighted average representative of actual or anticipated operation of the chemical manufacturing process unit generating the wastewater over a designated 12 month period. For flexible operation units, the owner or operator shall consider the anticipated production over the designated 12 month period and include all wastewater streams generated by the process equipment during this period. The owner/operator is not required to determine the concentration of Table 8 or Table 9 compounds that are not reasonably expected to be in the process.

(1) *Existing sources.* An owner or operator of an existing source who elects to comply with the requirements of paragraph (a)(1) of this section shall determine the flow weighted total annual average concentration for Table 9 compounds. For the purposes of this section, the term concentration, whether concentration is used alone or with other terms, may be adjusted by multiplying by the compound-specific fraction measured (Fm) factors listed in table 34 of this subpart unless determined by the methods in §63.144(b)(5)(i)(A) and/or (B). When concentration is determined by Method 305 as specified in §63.144(b)(5)(i)(B), concentration may be adjusted by dividing by the compound-specific Fm factors listed in table 34 of this subpart. When concentration is determined by Method 25D as specified in §63.144(b)(5)(i)(A), concentration may not be adjusted by the compound-specific Fm factors listed in table 34 of this subpart. Compound-specific Fm factors may be used only when concentrations of individual compounds are determined or when only one compound is in the wastewater stream. Flow weighted total annual average concentration for Table 9 compounds means the total mass of Table 9 compounds occurring in the wastewater stream during the designated 12-month period divided by the total mass of the wastewater stream during the same designated 12-month period. The total annual average concentration shall be determined for each wastewater stream either at the point of determination, or downstream of the point of determination with adjustment for concentration changes made according to paragraph (b)(6) of this section. The procedures specified in paragraphs (b)(3), (b)(4), and (b)(5) of this section are considered acceptable procedures for determining the annual average concentration. They may be used in combination, and no one procedure shall take precedence over another.

(2) *New sources.* An owner or operator of a new source who elects to comply with the requirements of paragraph (a)(1) of this section shall determine both the flow weighted total annual average concentration for Table 9 compounds and the flow weighted annual average concentration for each Table 8 compound. For the purposes of this section, the term concentration, whether concentration is used alone or with other terms, may be adjusted by multiplying by the compound-specific Fm factors listed in table 34 of this subpart unless determined by the methods in §63.144(b)(5)(i)(A) and/or (B). When concentration is determined by Method 305 as specified in §63.144(b)(5)(i)(B), concentration may be adjusted by dividing by the compound-specific Fm factors listed in table 34 of this subpart. When concentration is determined by Method 25D as specified in §63.144(b)(5)(i)(A), concentration may not be adjusted by the compound-specific Fm factors listed in table 34 of this subpart. Compound-specific fraction measured factors are compound specific and shall be used only when concentration of individual compounds are determined or when only one compound is in the wastewater stream. The flow weighted annual average concentration of each Table 8 compound means the mass of each Table 8 compound occurring in the wastewater stream during the designated 12-month period divided by the total mass of the wastewater stream during the same designated 12-month period. Flow weighted total annual average concentration for Table 9 compounds means the total mass of Table 9 compounds occurring in the wastewater stream during the designated 12-month period divided by the total mass of the wastewater stream during the same designated 12-month period. The annual average concentration shall be determined for each wastewater stream either at the point of determination, or downstream of the point of determination with adjustment for concentration changes made according to paragraph (b)(6) of this section. Procedures specified in paragraphs (b)(3), (b)(4), and (b)(5) of this section are considered acceptable procedures for determining the annual average concentration. They may be used in combination, and no one procedure shall take precedence over another.

(3) *Knowledge of the wastewater.* Where knowledge is used to determine the annual average concentration, the owner or operator shall provide sufficient information to document the annual average concentration for wastewater streams determined to be Group 2 wastewater streams. Documentation to determine the annual average concentration is not required for Group 1 streams. Examples of acceptable documentation include material balances, records of chemical purchases, process stoichiometry, or previous test results. If test data are used, the owner or operator shall provide documentation describing the testing protocol and the means by which any losses of volatile compounds during sampling, and the bias and accuracy of the analytical method, were accounted for in the determination.

(4) *Bench-scale or pilot-scale test data.* Where bench-scale or pilot-scale test data are used to determine the annual average concentration, the owner or operator shall provide sufficient information to document that the data are representative of the actual annual average concentration, or are reliably indicative of another relevant characteristic of the wastewater stream that could be used to predict the annual average concentration. For concentration data, the owner or operator shall also provide documentation describing the testing protocol, and the means by which any losses of volatile compounds during sampling, and the bias and accuracy of the analytical method, were accounted for in the determination of annual average concentration.

(5) *Test data from sampling at the point of determination or at a location downstream of the point of*

determination. Where an owner or operator elects to comply with paragraph (a)(1) of this section by measuring the concentration for the relevant Table 8 or Table 9 compounds, the owner or operator shall comply with the requirements of this paragraph. For each wastewater stream, measurements shall be made either at the point of determination, or downstream of the point of determination with adjustment for concentration changes made according to paragraph (b)(6) of this section. A minimum of three samples from each wastewater stream shall be taken. Samples may be grab samples or composite samples.

(i) *Methods.* The owner or operator shall use any of the methods specified in paragraphs (b)(5)(i)(A) through (b)(5)(i)(F) of this section.

(A) *Method 25D.* Use procedures specified in Method 25D of 40 CFR part 60, appendix A.

(B) *Method 305.* Use procedures specified in Method 305 of 40 CFR part 63, appendix A.

(C) *Methods 624 and 625.* Use procedures specified in Methods 624 and 625 of 40 CFR part 136, appendix A and comply with the sampling protocol requirements specified in paragraph (b)(5)(ii) of this section. If these methods are used to analyze one or more compounds that are not on the method's published list of approved compounds, the Alternative Test Procedure specified in 40 CFR 136.4 and 136.5 shall be followed. For Method 625, make corrections to the compounds to which the analysis is being conducted based on the accuracy as recovery factors in Table 7 of the method.

(D) *Method 1624 and Method 1625.* Use procedures specified in Method 1624 and Method 1625 of 40 CFR part 136, appendix A and comply with the requirements specified in paragraph (b)(5)(ii) of this section. If these methods are used to analyze one or more compounds that are not on the method's published list of approved compounds, the Alternative Test Procedure specified in 40 CFR 136.4 and 136.5 shall be followed.

(E) *Other EPA method(s).* Use procedures specified in the method and comply with the requirements specified in paragraphs (b)(5)(ii) and either paragraph (b)(5)(iii)(A) or (b)(5)(iii)(B) of this section.

(F) *Method(s) other than EPA method.* Use procedures specified in the method and comply with the requirements specified in paragraphs (b)(5)(ii) and (b)(5)(iii)(A) of this section.

(ii) *Sampling plan.* The owner or operator who is expressly referred to this paragraph by provisions of this subpart shall prepare a sampling plan. Wastewater samples shall be collected using sampling procedures which minimize loss of organic compounds during sample collection and analysis and maintain sample integrity. The sample plan shall include procedures for determining recovery efficiency of the relevant hazardous air pollutants listed in table 8 or table 9 of this subpart. An example of an acceptable sampling plan would be one that incorporates similar sampling and sample handling requirements to those of Method 25D of 40 CFR part 60, appendix A. The sampling plan shall be maintained at the facility.

(iii) *Validation of methods.* The owner or operator shall validate EPA methods other than Methods 25D, 305, 624, 625, 1624, and 1625 using the procedures specified in paragraph (b)(5)(iii)(A) or (b)(5)(iii)(B) of this section. The owner or operator shall validate other methods as specified in paragraph (b)(5)(iii)(A) of this section.

(A) *Validation of EPA methods and other methods.* The method used to measure organic hazardous air pollutants concentrations in the wastewater shall be validated according to section 5.1 or 5.3, and the corresponding calculations in section 6.1 or 6.3, of Method 301 of appendix A of this part. The data are acceptable if they meet the criteria specified in section 6.1.5 or 6.3.3 of Method 301 of appendix A of this part. If correction is required under section 6.3.3 of Method 301 of appendix A of this part, the data are acceptable if the correction factor is within the range 0.7 to 1.30. Other sections of Method 301 of appendix A of this part are not required. The concentrations of the individual organic hazardous air pollutants measured in the water may be corrected to their concentrations had they been measured by Method 305 of appendix A of this part, by multiplying each concentration by the compound-specific fraction measured (F_m) factor listed in table 34 of this subpart.

(B) *Validation for EPA methods.* Follow the procedures as specified in "Alternative Validation Procedure for EPA Waste Methods" 40 CFR part 63, appendix D.

(iv) *Calculations of average concentration.* The average concentration for each individually speciated Table 8 compound shall be calculated by adding the individual values determined for the specific compound in each sample and dividing by the number of samples. The total average concentration of Table 9 compounds shall be calculated by first summing the concentration of the individual compounds to obtain a total hazardous air pollutants concentration for the sample; add the sample totals and then divide by the number of samples in the run to obtain the sample average for the run. If the method used does not speciate the compounds, the sample results should be added and this total divided by the number of samples in the run to obtain the sample average for the run.

(6) *Adjustment for concentrations determined downstream of the point of determination.* The owner or operator shall make corrections to the annual average concentration or total annual average concentration when the concentration is determined downstream of the point of determination at a location where: two or more wastewater streams have been mixed; one or more wastewater streams have been treated; or, losses to the atmosphere have occurred. The owner or operator shall make the adjustments either to the individual data points or to the final annual average concentration.

(c) *Procedures to determine flow rate, when evaluating Group status under paragraph (a)(1) of this section.* An owner or operator who elects to comply with paragraph (a)(1) of this section shall determine the annual average flow rate of the wastewater stream either at the point of determination for each wastewater stream, or downstream of the point of determination with adjustment for flow rate changes made according to paragraph (c)(4) of this section. These procedures may be used in combination for different wastewater streams at the source. The annual average flow rate for the wastewater stream shall be representative of actual or anticipated operation of the chemical manufacturing process unit generating the wastewater over a designated 12-month period. The owner or operator shall consider the total annual wastewater volume generated by the chemical manufacturing process unit. If the chemical manufacturing process unit is a flexible operation unit, the owner or operator shall consider all anticipated production in the process equipment over the designated 12-month period. The procedures specified in paragraphs (c)(1), (c)(2), and (c)(3) of this section are considered acceptable procedures for determining the flow rate. They may be used in combination, and no one procedure shall take precedence over another.

(1) *Knowledge of the wastewater.* The owner or operator may use knowledge of the wastewater stream and/or the process to determine the annual average flow rate. The owner or operator shall use the maximum expected annual average production capacity of the process unit, knowledge of the process, and/or mass balance information to either: Estimate directly the annual average wastewater flow rate; or estimate the total annual wastewater volume and then divide total volume by 525,600 minutes in a year. Where knowledge is used to determine the annual average flow rate, the owner or operator shall provide sufficient information to document the flow rate for wastewater streams determined to be Group 2 wastewater streams. Documentation to determine the annual average flow rate is not required for Group 1 streams.

(2) *Historical Records.* The owner or operator may use historical records to determine the annual average flow rate. Derive the highest annual average flow rate of wastewater from historical records representing the most recent 5 years of operation or, if the process unit has been in service for less than 5 years but at least 1 year, from historical records representing the total operating life of the process unit. Where historical records are used to determine the annual average flow rate, the owner or operator shall provide sufficient information to document the flow rate for wastewater streams determined to be Group 2 wastewater streams. Documentation to determine the annual average flow rate is not required for Group 1 streams.

(3) *Measurements of flow rate.* Where an owner or operator elects to comply with paragraph (a)(1) of this section by measuring the flow rate, the owner or operator shall comply with the requirements of this paragraph. Measurements shall be made at the point of determination, or at a location downstream of the point of determination with adjustments for flow rate changes made according to paragraph (c)(4) of this section. Where measurement data are used to determine the annual average flow rate, the owner or operator shall provide sufficient information to document the flow rate for wastewater streams determined to be Group 2 wastewater streams. Documentation to determine the annual average flow rate is not required for Group 1 streams.

(4) *Adjustment for flow rates determined downstream of the point of determination.* The owner or operator shall make corrections to the annual average flow rate of a wastewater stream when it is determined downstream of the point of determination at a location where two or more wastewater streams have been mixed or one or more wastewater streams have been treated. The owner or operator shall make corrections for such changes in the annual average flow rate.

[62 FR 2762, Jan. 17, 1997]

§ 63.145 Process wastewater provisions—test methods and procedures to determine compliance.

(a) *General.* This section specifies the procedures for performance tests that are conducted to demonstrate compliance of a treatment process or a control device with the control requirements specified in §63.138 of this subpart. Owners or operators conducting a design evaluation shall comply with the requirements of paragraph (a)(1) or (a)(2) of this section. Owners or operators conducting a performance test shall comply with the applicable requirements in paragraphs (a) through (i) of this section.

(1) *Performance tests and design evaluations for treatment processes.* If design steam stripper option (§63.138(d)) or RCRA option (§63.138(h)) is selected to comply with §63.138, neither a design evaluation nor a performance test is required. For any other non-biological treatment process, the owner or operator shall conduct either a design evaluation as specified in §63.138(j), or a performance test as specified in this section. For closed biological treatment processes, the owner or operator shall conduct either a design evaluation as specified in §63.138(j), or a performance test as specified in this section. For each open biological treatment process, the owner or operator shall conduct a performance test as specified in this section.

Note: Some open biological treatment processes may not require a performance test. Refer to §63.145(h) and table 36 of this subpart to determine whether the biological treatment process meets the criteria that exempt the owner or operator from conducting a performance test.

(2) *Performance tests and design evaluations for control devices.* The owner or operator shall conduct either a design evaluation as specified in §63.139(d), or a performance test as specified in paragraph (i) of this section for control devices other than flares and paragraph (j) of this section for flares.

(3) *Representative process unit operating conditions.* Compliance shall be demonstrated for representative operating conditions. Operations during periods of startup, shutdown, or malfunction and periods of nonoperation shall not constitute representative conditions. The owner or operator shall record the process information that is necessary to document operating conditions during the test.

(4) *Representative treatment process or control device operating conditions.* Performance tests shall be conducted when the treatment process or control device is operating at a representative inlet flow rate and concentration. If the treatment process or control device will be operating at several different sets of representative operating conditions, the owner or operator shall comply with paragraphs (a)(4)(i) and (a)(4)(ii) of this section. The owner or operator shall record information that is necessary to document treatment process or control device operating conditions during the test.

(i) *Range of operating conditions.* If the treatment process or control device will be operated at several different sets of representative operating conditions, performance testing over the entire range is not required. In such cases, the performance test results shall be supplemented with modeling and/or engineering assessments to demonstrate performance over the operating range.

(ii) *Consideration of residence time.* If concentration and/or flow rate to the treatment process or control device are not relatively constant (i.e., comparison of inlet and outlet data will not be representative of performance), the owner or operator shall consider residence time, when determining concentration and flow rate.

(5) *Testing equipment.* All testing equipment shall be prepared and installed as specified in the applicable test methods, or as approved by the Administrator.

(6) *Compounds not required to be considered in performance tests or design evaluations.* Compounds that meet the requirements specified in paragraph (a)(6)(i), (a)(6)(ii), or (a)(6)(iii) of this section are not required to be included in the performance test. Concentration measurements based on Method 305 shall be adjusted by dividing each concentration by the compound-specific Fm factor listed in table 34 of this subpart. Concentration measurements based on methods other than Method 305 shall not be adjusted by the compound-specific Fm factor listed in table 34 of this subpart.

- (i) Compounds not used or produced by the chemical manufacturing process unit; or
- (ii) Compounds with concentrations at the point of determination that are below 1 part per million by weight; or
- (iii) Compounds with concentrations at the point of determination that are below the lower detection limit where the lower detection limit is greater than 1 part per million by weight. The method shall be an analytical method for wastewater which has that compound as a target analyte.

(7) *Treatment using a series of treatment processes.* In all cases where the wastewater provisions in this subpart allow or require the use of a treatment process to comply with emissions limitations, the owner or operator may use multiple treatment processes. The owner or operator complying with the requirements of §63.138(a)(7)(i), when wastewater is conveyed by hard-piping, shall comply with either §§63.145(a)(7)(i) or 63.145(a)(7)(ii) of this subpart. The owner or operator complying with the requirements of §63.138(a)(7)(ii) of this subpart shall comply with the requirements of §63.145(a)(7)(ii) of this subpart.

(i) The owner or operator shall conduct the performance test across each series of treatment processes. For each series of treatment processes, inlet concentration and flow rate shall be measured either where the wastewater stream enters the first treatment process in a series of treatment processes, or prior to the first treatment process as specified in §63.145(a)(9) of this subpart. For each series of treatment processes, outlet concentration and flow rate shall be measured where the wastewater stream exits the last treatment process in the series of treatment processes, except when the last treatment process is an open or a closed aerobic biological treatment process demonstrating compliance by using the procedures in §63.145 (f) or (g) of this subpart. When the last treatment process is either an open or a closed aerobic biological treatment process demonstrating compliance by using the procedures in §63.145 (f) or (g) of this subpart, inlet and outlet concentrations and flow rates shall be measured as provided in paragraphs (a)(7)(i)(A) and (a)(7)(i)(B) of this section. The mass flow rates removed or destroyed by the series of treatment processes and by the biological treatment process are all used to calculate actual mass removal (AMR) as specified in §63.145(f)(5)(ii) of this subpart.

(A) The inlet and outlet to the series of treatment processes prior to the biological treatment process are the points at which the wastewater enters the first treatment process and exits the last treatment process in the series, respectively, except as provided in paragraph (a)(9)(ii) of this section.

(B) The inlet to the biological treatment process shall be the point at which the wastewater enters the biological treatment process or the outlet from the series of treatment processes identified in paragraph (a)(7)(i)(A) of this section, except as provided in paragraph (a)(9)(ii) of this section.

(ii) The owner or operator shall conduct the performance test across each treatment process in the series of treatment processes. The mass flow rate removed or destroyed by each treatment process shall be added together to determine whether compliance has been demonstrated using §63.145 (c), (d), (e), (f), and (g), as applicable. If a biological treatment process is one of the treatment processes in the series of treatment processes, the inlet to the biological treatment process shall be the point at which the wastewater enters the biological treatment process, or the inlet to the equalization tank if all the criteria of paragraph (a)(9)(ii) of this section are met.

(8) When using a biological treatment process to comply with §63.138 of this subpart, the owner or operator may elect to calculate the AMR using a subset of Table 8 and/or Table 9 compounds determined at the point of determination or downstream of the point of determination with adjustment for concentration and flowrate changes made according to §63.144(b)(6) and §63.144(c)(4) of this subpart, respectively. All Table 8 and/or Table 9 compounds measured to determine the RMR, except as provided by §63.145(a)(6), shall be included in the RMR calculation.

(9) The owner or operator determining the inlet for purposes of demonstrating compliance with §63.145 (e), (f), or (g) of this subpart may elect to comply with paragraph (a)(9)(i) or (a)(9)(ii) of this section.

(i) When wastewater is conveyed exclusively by hard-piping from the point of determination to a treatment process that is either the only treatment process or the first in a series of treatment processes (i.e., no treatment processes or other waste management units are used upstream of this treatment process to store, handle, or convey the wastewater), the inlet to the treatment process shall be at any location from the point of determination to where the wastewater stream enters the treatment process.

When samples are taken upstream of the treatment process and before wastewater streams have converged, the owner or operator shall ensure that the mass flow rate of all Group 1 wastewater streams is accounted for when using §63.138 (e) or (f) to comply and that the mass flow rate of all Group 1 and Group 2 wastewater streams is accounted for when using §63.138(g) to comply, except as provided in §63.145(a)(6).

(ii) The owner or operator may consider the inlet to the equalization tank as the inlet to the biological treatment process if all the criteria in paragraphs (a)(9)(ii)(A) through (a)(9)(ii)(C) of this section are met. The outlet from the series of treatment processes prior to the biological treatment process is the point at which the wastewater exits the last treatment process in the series prior to the equalization tank, if the equalization tank and biological treatment process are part of a series of treatment processes. The owner or operator shall ensure that the mass flow rate of all Group 1 wastewater streams is accounted for when using §63.138 (e) or (f) to comply and that the mass flow rate of all Group 1 and Group 2 wastewater streams is accounted for when using §63.138(g) to comply, except as provided in §63.145 (a)(6).

(A) The wastewater is conveyed by hard-piping from either the last previous treatment process or the point of determination to the equalization tank.

(B) The wastewater is conveyed from the equalization tank exclusively by hard-piping to the biological treatment process and no treatment processes or other waste management units are used to store, handle, or convey the wastewater between the equalization tank and the biological treatment process.

(C) The equalization tank is equipped with a fixed roof and a closed vent system that routes emissions to a control device that meets the requirements of §63.133(a)(2)(i) and §63.133 (b)(1) through (b)(4) of this subpart.

(b) *Noncombustion treatment process—concentration limits.* This paragraph applies to performance tests that are conducted to demonstrate compliance of a noncombustion treatment process with the parts per million by weight wastewater stream concentration limits at the outlet of the treatment process. This compliance option is specified in §63.138(b)(1) and §63.138(c)(1). Wastewater samples shall be collected using sampling procedures which minimize loss of organic compounds during sample collection and analysis and maintain sample integrity per §63.144(b)(5)(ii). Samples shall be collected and analyzed using the procedures specified in §63.144 (b)(5)(i), (b)(5)(ii), and (b)(5)(iii) of this subpart. Samples may be grab samples or composite samples. Samples shall be taken at approximately equally spaced time intervals over a 1-hour period. Each 1-hour period constitutes a run, and the performance test shall consist of a minimum of 3 runs. Concentration measurements based on Method 305 may be adjusted by dividing each concentration by the compound-specific Fm factor listed in Table 34 of this subpart. Concentration measurements based on methods other than Method 305 may be adjusted by multiplying each concentration by the compound-specific Fm factor listed in table 34 of this subpart. (For wastewater streams that are Group 1 for both Table 8 and Table 9 compounds, compliance is demonstrated only if the sum of the concentrations of Table 9 compounds is less than 50 ppmw, and the concentration of each Table 8 compound is less than 10 ppmw.)

(c) *Noncombustion, nonbiological treatment process: Percent mass removal/destruction option.* This paragraph applies to performance tests that are conducted to demonstrate compliance of a noncombustion, nonbiological treatment process with the percent mass removal limits specified in §63.138(e) (1) and (2) for Table 8 and/or Table 9 compounds. The owner or operator shall comply with the requirements specified in §63.145 (c)(1) through (c)(6) of this subpart.

(1) *Concentration.* The concentration of Table 8 and/or Table 9 compounds entering and exiting the treatment process shall be determined as provided in this paragraph. Wastewater samples shall be collected using sampling procedures which minimize loss of organic compounds during sample collection and analysis and maintain sample integrity per §63.144(b)(5)(ii). The method shall be an analytical method for wastewater which has that compound as a target analyte. Samples may be grab samples or composite samples. Samples shall be taken at approximately equally spaced time intervals over a 1-hour period. Each 1-hour period constitutes a run, and the performance test shall consist of a minimum of 3 runs. Concentration measurements based on Method 305 shall be adjusted by dividing each concentration by the compound-specific Fm factor listed in Table 34 of this subpart. Concentration measurements based on methods other than Method 305 shall not adjust by the compound-specific Fm factor listed in Table 34 of this subpart.

(2) *Flow rate.* The flow rate of the entering and exiting wastewater streams shall be determined using

inlet and outlet flow measurement devices, respectively. Where the outlet flow is not greater than the inlet flow, a flow measurement device shall be used, and may be used at either the inlet or outlet. Flow rate measurements shall be taken at the same time as the concentration measurements.

(3) *Calculation of mass flow rate—for noncombustion, nonbiological treatment processes.* The mass flow rates of Table 8 and/or Table 9 compounds entering and exiting the treatment process are calculated as follows.

$$QMW_a = \frac{\rho}{p * 10^6} \left(\sum_{k=1}^p Q_{a,k} C_{T,a,k} \right) \quad (\text{Eqn WW1})$$

$$QMW_b = \frac{\rho}{p * 10^6} \left(\sum_{k=1}^p Q_{b,k} C_{T,b,k} \right) \quad (\text{Eqn WW2})$$

Where:

QMW_a , QMW_b = Mass flow rate of Table 8 or Table 9 compounds, average of all runs, in wastewater entering (QMW_a) or exiting (QMW_b) the treatment process, kilograms per hour.

ρ = Density of the wastewater, kilograms per cubic meter.

$Q_{a,k}$, $Q_{b,k}$ = Volumetric flow rate of wastewater entering ($Q_{a,k}$) or exiting ($Q_{b,k}$) the treatment process during each run k, cubic meters per hour.

$C_{T,a,k}$, $C_{T,b,k}$ = Total concentration of Table 8 or Table 9 compounds in wastewater entering ($C_{T,a,k}$) or exiting ($C_{T,b,k}$) the treatment process during each run k, parts per million by weight.

p = Number of runs.

k = Identifier for a run.

10^6 = conversion factor, mg/kg

(4) *Percent removal calculation for mass flow rate.* The percent mass removal across the treatment process shall be calculated as follows:

$$E = \frac{QMW_a - QMW_b}{QMW_a} \times 100 \quad (\text{Eqn WW3})$$

Where:

E = Removal or destruction efficiency of the treatment process, percent.

QMW_a , QMW_b = Mass flow rate of Table 8 or Table 9 compounds in wastewater entering (QMW_a) and exiting (QMW_b) the treatment process, kilograms per hour (as calculated using Equations WW1 and WW2).

(5) *Calculation of flow-weighted average of Fr values.* If complying with §63.138(e)(2), use Equation WW8 to calculate the flow-weighted average of the Fr values listed in Table 9 of this subpart. When the term "combustion" is used in Equation WW8, the term "treatment process" shall be used for the purposes of this paragraph.

(6) *Compare mass removal efficiency to required efficiency.* Compare the mass removal efficiency (calculated in Equation WW3) to the required efficiency as specified in §63.138(e) of this subpart. If complying with §63.138(e)(1), compliance is demonstrated if the mass removal efficiency is 99 percent or greater. If complying with §63.138(e)(2), compliance is demonstrated if the mass removal efficiency is greater than or equal to the flow-weighted average of the Fr values calculated in Equation WW8.

(d) *Combustion treatment processes: percent mass removal/destruction option.* This paragraph applies to performance tests that are conducted to demonstrate compliance of a combustion treatment process with the percent mass destruction limits specified in §63.138(e) (1) and (2) for Table 9 compounds, and/or §63.138(e)(1) for Table 8 compounds. The owner or operator shall comply with the requirements specified in §63.145 (d)(1) through (d)(9) of this subpart. (Wastewater streams that are Group 1 for both Table 8 and Table 9 compounds need only do the compliance demonstration for Table 9 compounds.)

(1) *Concentration in wastewater stream entering the combustion treatment process.* The concentration of Table 8 and/or Table 9 compounds entering the treatment process shall be determined as provided in this paragraph. Wastewater samples shall be collected using sampling procedures which minimize loss of organic compounds during sample collection and analysis and maintain sample integrity per §63.144 (b)(5)(ii). The method shall be an analytical method for wastewater which has that compound as a target analyte. Samples may be grab samples or composite samples. Samples shall be taken at approximately equally spaced time intervals over a 1-hour period. Each 1-hour period constitutes a run, and the performance test shall consist of a minimum of 3 runs. Concentration measurements based on Method 305 of appendix A of this part shall be adjusted by dividing each concentration by the compound-specific Fm factor listed in table 34 of this subpart. Concentration measurements based on methods other than Method 305 shall not adjust by the compound-specific Fm factor listed in table 34 of this subpart.

(2) *Flow rate of wastewater entering the combustion treatment process.* The flow rate of the wastewater stream entering the combustion treatment process shall be determined using an inlet flow meter. Flow rate measurements shall be taken at the same time as the concentration measurements.

(3) *Calculation of mass flow rate in wastewater stream entering combustion treatment processes.* The mass flow rate of Table 8 and/or Table 9 compounds entering the treatment process is calculated as follows:

$$QMW_a = \frac{\rho}{p * 10^6} \left(\sum_{k=1}^p Q_{a,k} * C_{T,a,k} \right) \quad (\text{Eqn WW4})$$

Where:

QMW_a = Mass flow rate of Table 8 or Table 9 compounds entering the combustion unit, kilograms per hour.

ρ = Density of the wastewater stream, kilograms per cubic meter.

Q_{a,k} = Volumetric flow rate of wastewater entering the combustion unit during run k, cubic meters per hour.

C_{T,a,k} = Total concentration of Table 8 or Table 9 compounds in the wastewater stream entering the combustion unit during run k, parts per million by weight.

p = Number of runs.

k = Identifier for a run.

(4) *Concentration in vented gas stream exiting the combustion treatment process.* The concentration of Table 8 and/or Table 9 compounds exiting the combustion treatment process in any vented gas stream shall be determined as provided in this paragraph. Samples may be grab samples or composite samples. Samples shall be taken at approximately equally spaced time intervals over a 1-hour period.

Each 1-hour period constitutes a run, and the performance test shall consist of a minimum of 3 runs. Concentration measurements shall be determined using Method 18 of 40 CFR part 60, appendix A. Alternatively, any other test method validated according to the procedures in Method 301 of appendix A of this part may be used.

(5) *Volumetric flow rate of vented gas stream exiting the combustion treatment process.* The volumetric flow rate of the vented gas stream exiting the combustion treatment process shall be determined using Method 2, 2A, 2C, or 2D of 40 CFR part 60, appendix A, as appropriate. Volumetric flow rate measurements shall be taken at the same time as the concentration measurements.

(6) *Calculation of mass flow rate of vented gas stream exiting combustion treatment processes.* The mass flow rate of Table 8 and/or Table 9 compounds in a vented gas stream exiting the combustion treatment process shall be calculated as follows:

(Eqn WW5) [Reserved]

$$QMG_b = K_2 \left(\sum_{i=1}^n CG_{b,i} MW_i \right) QG_b \quad (\text{Eqn WW6})$$

Where:

$CG_{a,i}$, $CG_{b,i}$ = Concentration of total organic compounds (TOC) (minus methane and ethane) or total organic hazardous air pollutants, in vented gas stream, entering ($CG_{a,i}$) and exiting ($CG_{b,i}$) the control device, dry basis, parts per million by volume.

QMG_a , QMG_b = Mass rate of TOC (minus methane and ethane) or total organic hazardous air pollutants, in vented gas stream, entering (QMG_a) and exiting (QMG_b) the control device, dry basis, kilograms per hour.

MW_i = Molecular weight of a component, kilogram/kilogram-mole.

QG_a , QG_b = Flow rate of gas stream entering (QG_a) and exiting (QG_b) the control device, dry standard cubic meters per hour.

K_2 = Constant, 41.57×10^{-9} (parts per million)⁻¹ (gram-mole per standard cubic meter) (kilogram/gram), where standard temperature (gram-mole per standard cubic meter) is 20 ° Celsius.

i = Identifier for a compound.

n = Number of components in the sample.

(7) *Destruction efficiency calculation.* The destruction efficiency of the combustion unit for Table 8 and/or Table 9 compounds shall be calculated as follows:

$$E = \frac{QMW_a - QMG_b}{QMW_a} * 100 \quad (\text{Eqn WW7})$$

Where:

E = Destruction efficiency of Table 8 or Table 9 compounds for the combustion unit, percent.

QMW_a = Mass flow rate of Table 8 or Table 9 compounds entering the combustion unit, kilograms per hour.

QMG_b = Mass flow rate of Table 8 or Table 9 compounds in vented gas stream exiting the combustion treatment process, kilograms per hour.

(8) *Calculation of flow-weighted average of Fr values.* Use Equation WW8 to calculate the flow-weighted average of the Fr values listed in table 9 of this subpart.

$$Fr_{avg} = \left[\frac{\sum_{i=1}^n \sum_{k=1}^p Fr_i * C_{i,a,k} * Q_{a,k}}{\sum_{k=1}^p \sum_{i=1}^n C_{i,a,k} * Q_{a,k}} \right] * 100 \quad (\text{Eqn WW8})$$

Where:

Fr_{avg} = Flow-weighted average of the Fr values.

$C_{i,a,k}$ = Concentration of Table 8 and/or Table 9 compounds in wastewater stream entering the combustion unit, during run k, parts per million by weight.

$Q_{a,k}$ = Volumetric flow rate of wastewater entering the combustion unit during run k, cubic meters per hour.

Fr_i = Compound-specific Fr value listed in table 9 of this subpart.

(9) *Calculate flow-weighted average of Fr values and compare to mass destruction efficiency.* Compare the mass destruction efficiency (calculated in Equation WW 7) to the required efficiency as specified in §63.138(e). If complying with §63.138(e)(1), compliance is demonstrated if the mass destruction efficiency is 99 percent or greater. If complying with §63.138(e)(2), compliance is demonstrated if the mass destruction efficiency is greater than or equal to the flow-weighted average of the Fr value calculated in Equation WW8.

(e) *Non-combustion treatment processes including closed biological treatment processes: RMR option.* This paragraph applies to performance tests for non-combustion treatment processes other than open biological treatment processes to demonstrate compliance with the mass removal provisions for Table 8 and/or Table 9 compounds. Compliance options for noncombustion treatment processes are specified in §63.138(f) of this subpart. Compliance options for closed aerobic or anaerobic biological treatment processes are specified in §63.138(f) and §63.138(g) of this subpart. When complying with §63.138(f), the owner or operator shall comply with the requirements specified in §63.145(e)(1) through (e)(6) of this subpart. When complying with §63.138(g), the owner or operator shall comply with the requirements specified in §63.145(e)(1) through (e)(6) of this subpart. (Wastewater streams that are Group 1 for both Table 8 and Table 9 compounds need only do the compliance demonstration for Table 9 compounds.)

(1) *Concentration in wastewater stream.* The concentration of Table 8 and/or Table 9 compounds shall be determined as provided in this paragraph. Concentration measurements to determine RMR shall be taken at the point of determination or downstream of the point of determination with adjustment for concentration change made according to §63.144(b)(6) of this subpart. Concentration measurements to determine AMR shall be taken at the inlet and outlet to the treatment process and as provided in §63.145(a)(7) for a series of treatment processes. Wastewater samples shall be collected using sampling procedures which minimize loss of organic compounds during sample collection and analysis and maintain sample integrity per §63.144(b)(5)(ii). The method shall be an analytical method for wastewater which has that compound as a target analyte. Samples may be grab samples or composite samples. Samples shall be taken at approximately equally spaced time intervals over a 1-hour period. Each 1-hour period constitutes a run, and the performance test shall consist of a minimum of 3 runs. Concentration measurements based on Method 305 shall be adjusted by dividing each concentration by

the compound-specific Fm factor listed in table 34 of this subpart. Concentration measurements based on methods other than Method 305 shall not adjust by the compound-specific Fm factor listed in table 34 of this subpart.

(2) *Flow rate.* Flow rate measurements to determine RMR shall be taken at the point of determination or downstream of the point of determination with adjustment for flow rate change made according to §63.144(c)(4) of this subpart. Flow rate measurements to determine AMR shall be taken at the inlet and outlet to the treatment process and as provided in §63.145(a)(7) for a series of treatment processes. Flow rate shall be determined using inlet and outlet flow measurement devices. Where the outlet flow is not greater than the inlet flow, a flow measurement device shall be used, and may be used at either the inlet or outlet. Flow rate measurements shall be taken at the same time as the concentration measurements.

(3) *Calculation of RMR for non-combustion treatment processes including closed biological treatment processes.* When using §63.138(f) to comply, the required mass removal of Table 8 and/or Table 9 compounds for each Group 1 wastewater stream shall be calculated as specified in paragraph (e)(3)(i) of this section. When using §63.138(g) to comply, the required mass removal shall be calculated as specified in paragraph (e)(3)(ii) of this section.

(i) When using §63.138(f) to comply, the required mass removal of Table 8 and/or Table 9 compounds for each Group 1 wastewater stream shall be calculated using Equation WW9.

$$RMR = \frac{\rho}{10^9} Q \sum_{i=1}^n (C_i * Fr_i) \quad (\text{Eqn WW9})$$

Where:

RMR=Required mass removal for treatment process or series of treatment processes, kilograms per hour.

ρ =Density of the Group 1 wastewater stream, kilograms per cubic meter.

Q=Volumetric flow rate of wastewater stream at the point of determination, liters per hour.

i=Identifier for a compound.

n=Number of Table 8 or Table 9 compounds in stream.

C_i =Concentration of Table 8 or Table 9 compounds at the point of determination, parts per million by weight.

Fr_i =Fraction removal value of a Table 8 or Table 9 compound. Fr values are listed in table 9 of this subpart.

10^9 =Conversion factor, mg/kg * l/m³ .

(ii) When using §63.138(g) to comply, the required mass removal is 95 percent of the mass flow rate for all Group 1 and Group 2 wastewater streams combined for treatment. The required mass removal of Table 8 and/or Table 9 compounds for all Group 1 and Group 2 wastewater streams combined for treatment when complying with §63.138(g) shall be calculated using the following equation:

$$RMR = \frac{0.95\rho}{10^9} Q \sum_{i=1}^n (C_i) \quad (\text{Eqn WW9a})$$

Where:

RMR=Required mass removal for treatment process or series of treatment processes, kilograms per hour.

ρ =Density of the Group 1 wastewater stream, kilograms per cubic meter.

Q=Volumetric flow rate of wastewater stream at the point of determination, liters per hour.

i=Identifier for a compound.

n=Number of Table 8 or Table 9 compounds in stream.

C_i =Concentration of Table 8 or Table 9 compounds at the point of determination, parts per million by weight.

10^9 =Conversion factor, mg/kg * l/m³

(4)(i) The required mass removal is calculated by summing the required mass removal for each Group 1 wastewater stream to be combined for treatment when complying with §63.138(f).

(ii) The required mass removal is calculated by summing the required mass removal for all Group 1 and Group 2 wastewater streams combined for treatment when complying with §63.138(g).

(5) *The AMR calculation procedure for non-combustion treatment processes including closed biological treatment processes.* The AMR shall be calculated as follows:

$$AMR = (QMW_a - QMW_b) \quad (\text{Eqn WW10})$$

Where:

AMR=Actual mass removal of Table 8 or Table 9 compounds achieved by treatment process or series of treatment processes, kilograms per hour.

QMW_a =Mass flow rate of Table 8 or Table 9 compounds in wastewater entering the treatment process or first treatment process in a series of treatment processes, kilograms per hour.

QMW_b =Mass flow rate of Table 8 or Table 9 compounds in wastewater exiting the last treatment process in a series of treatment processes, kilograms per hour.

(6) *Compare RMR to AMR.* When complying with §63.138(f), compare the RMR calculated in Equation WW9 to the AMR calculated in Equation WW10. Compliance is demonstrated if the AMR is greater than or equal to the RMR. When complying with §63.138(g), compare the RMR calculated in Equation WW-9a to the AMR calculated in Equation WW10. Compliance is demonstrated if the AMR is greater than or equal to 95-percent mass removal.

(f) *Open or closed aerobic biological treatment processes: Required mass removal (RMR) option.* This paragraph applies to the use of performance tests that are conducted for open or closed aerobic biological treatment processes to demonstrate compliance with the mass removal provisions for Table 8 and/or Table 9 compounds. These compliance options are specified in §63.138(f) of this subpart. The owner or operator shall comply with the requirements specified in §63.145 (f)(1) through (f)(6) of this subpart. Some compounds may not require a performance test. Refer to §63.145(h) and table 36 of this subpart to determine which compounds may be exempt from the requirements of this paragraph.

(1) *Concentration in wastewater stream.* The concentration of Table 8 and/or Table 9 compounds shall

be determined as provided in this paragraph. Concentration measurements to determine RMR shall be taken at the point of determination or downstream of the point of determination with adjustment for concentration change made according to §63.144(b)(6) of this subpart. Concentration measurements to determine AMR shall be taken at the inlet and outlet to the treatment process and as provided in §63.145(a)(7) for a series of treatment processes. Wastewater samples shall be collected using sampling procedures which minimize loss of organic compounds during sample collection and analysis and maintain sample integrity per §63.144(b)(5)(ii). The method shall be an analytical method for wastewater which has that compound as a target analyte. Samples may be grab samples or composite samples. Samples shall be taken at approximately equally spaced time intervals over a 1-hour period. Each 1-hour period constitutes a run, and the performance test shall consist of a minimum of 3 runs. Concentration measurements based on Method 305 shall be adjusted by dividing each concentration by the compound-specific Fm factor listed in table 34 of this subpart. Concentration measurements based on methods other than Method 305 shall not adjust by the compound-specific Fm factor listed in table 34 of this subpart.

(2) *Flow rate.* Flow rate measurements to determine RMR shall be taken at the point of determination or downstream of the point of determination with adjustment for flow rate change made according to §63.144(c)(4) of this subpart. Flow rate measurements to determine AMR shall be taken at the inlet and outlet to the treatment process and as provided in §63.145(a)(7) for a series of treatment processes. Flow rate shall be determined using inlet and outlet flow measurement devices. Where the outlet flow is not greater than the inlet flow, a flow measurement device shall be used, and may be used at either the inlet or outlet. Flow rate measurements shall be taken at the same time as the concentration measurements.

(3) *Calculation of RMR for open or closed aerobic biological treatment processes.* The required mass removal of Table 8 and/or Table 9 compounds for each Group 1 wastewater stream shall be calculated using the following equation:

$$RMR = \frac{\rho}{10^9} Q \sum_{i=1}^n (C_i * Fr_i) \quad (\text{Eqn WW11})$$

Where:

RMR=Required mass removal for treatment process or series of treatment processes, kilograms per hour.

ρ =Density of the Group 1 wastewater stream, kilograms per cubic meter.

Q=Volumetric flow rate of wastewater stream at the point of determination, liters per hour.

i=Identifier for a compound.

n=Number of Table 8 or Table 9 compounds in stream.

C_i =Concentration of Table 8 or Table 9 compounds at the point of determination, parts per million by weight.

Fr_i =Fraction removal value of a Table 8 or Table 9 compound. Fr values are listed in table 9 of this subpart.

10^9 =Conversion factor, mg/kg * l/m³ .

(4) The required mass removal is calculated by adding together the required mass removal for each Group 1 wastewater stream to be combined for treatment.

(5) *Actual mass removal calculation procedure for open or closed aerobic biological treatment processes.* The actual mass removal (AMR) shall be calculated using Equation WW12 as specified in

paragraph (f)(5)(i) of this section when the performance test is performed across the open or closed aerobic biological treatment process only. If compliance is being demonstrated in accordance with §63.145(a)(7)(i), the AMR for the series shall be calculated using Equation WW13 in §63.145(f)(5)(ii). (This equation is for situations where treatment is performed in a series of treatment processes connected by hard-piping.) If compliance is being demonstrated in accordance with §63.145(a)(7)(ii), the AMR for the biological treatment process shall be calculated using Equation WW12 in §63.145(f)(5)(i). The AMR for the biological treatment process used in a series of treatment processes calculated using Equation WW12 shall be added to the AMR determined for each of the other individual treatment processes in the series of treatment processes.

(i) Calculate AMR for the open or closed aerobic biological treatment process as follows:

$$AMR = QMW_a * F_{bio} \quad (Eqn WW12)$$

Where:

AMR=Actual mass removal of Table 8 or Table 9 compounds achieved by open or closed biological treatment process, kilograms per hour.

QMW_a=Mass flow rate of Table 8 or Table 9 compounds in wastewater entering the treatment process, kilograms per hour.

F_{bio}=Site-specific fraction of Table 8 or Table 9 compounds biodegraded. F_{bio} shall be determined as specified in §63.145(h) and appendix C of this subpart.

(ii) Calculate AMR across a series of treatment units where the last treatment unit is an open or closed aerobic biological treatment process as follows:

$$AMR = QMW_a - (QMW_b)(1 - F_{bio}) \quad (Eqn WW13)$$

Where:

AMR=Actual mass removal of Table 8 or Table 9 compounds achieved by a series of treatment processes, kilograms per hour.

QMW_a=Mass flow rate of Table 8 or Table 9 compounds in wastewater entering the first treatment process in a series of treatment processes, kilograms per hour.

QMW_b=Mass flow rate of Table 8 or Table 9 compounds in wastewater exiting the last treatment process in a series of treatment processes prior to the biological treatment process, kilograms per hour.

F_{bio}=Site-specific fraction of Table 8 or Table 9 compounds biodegraded. F_{bio} shall be determined as specified in §63.145(h) and appendix C of this subpart.

(6) *Compare RMR to AMR.* Compare the RMR calculated in Equation WW11 to the AMR calculated in either Equation WW12 or WW13, as applicable. Compliance is demonstrated if the AMR is greater than or equal to the RMR.

(g) *Open or closed aerobic biological treatment processes: 95-percent mass removal option.* This paragraph applies to performance tests that are conducted for open or closed aerobic biological treatment processes to demonstrate compliance with the 95-percent mass removal provisions for Table 8 and/or Table 9 compounds. This compliance option is specified in §63.138(g) of this subpart. The RMR for this option is 95-percent mass removal. The owner or operator shall comply with the requirements specified in §63.145(g)(1) to determine AMR, §63.145 (e)(3)(ii) and (e)(4)(ii) to determine

RMR, and (g)(2) of this subpart to determine whether compliance has been demonstrated. Some compounds may not require a performance test. Refer to §63.145(h) and table 36 of this subpart to determine which compounds may be exempt from the requirements of this paragraph. (Wastewater streams that are Group 1 for both Table 8 and Table 9 compounds need only do the compliance demonstration for Table 9 compounds.)

(1) The owner or operator shall comply with the requirements specified in paragraphs (f)(1), (f)(2), and (f)(5) of this section to determine AMR. References to Group 1 wastewater streams shall be deemed Group 1 and Group 2 wastewater streams for the purposes of this paragraph.

(2) *Compare RMR to AMR.* Compliance is demonstrated if the AMR is greater than or equal to RMR.

(h) *Site-specific fraction biodegraded (F_{bio}).* The compounds listed in table 9 of this subpart are divided into two sets for the purpose of determining whether F_{bio} must be determined, and if F_{bio} must be determined, which procedures may be used to determine compound-specific kinetic parameters. These sets are designated as lists 1 and 2 in table 36 of this subpart.

(1) *Performance test exemption.* If a biological treatment process meets the requirements specified in paragraphs (h)(1)(i) and (h)(1)(ii) of this section, the owner or operator is not required to determine F_{bio} and is exempt from the applicable performance test requirements specified in §63.138 of this subpart.

(i) The biological treatment process meets the definition of “enhanced biological treatment process” in §63.111 of this subpart.

(ii) At least 99 percent by weight of all compounds on table 36 of this subpart that are present in the aggregate of all wastewater streams using the biological treatment process to comply with §63.138 of this subpart are compounds on list 1 of table 36 of this subpart.

(2) *F biodetermination.* If a biological treatment process does not meet the requirement specified in paragraph (h)(1)(i) of this section, the owner or operator shall determine F_{bio} for the biological treatment process using the procedures in appendix C to part 63, and paragraph (h)(2)(ii) of this section. If a biological treatment process meets the requirements of paragraph (h)(1)(i) of this section but does not meet the requirement specified in paragraph (h)(1)(ii) of this section, the owner or operator shall determine F_{bio} for the biological treatment process using the procedures in appendix C to part 63, and paragraph (h)(2)(i) of this section.

(i) *Enhanced biological treatment processes.* If the biological treatment process meets the definition of “enhanced biological treatment process” in §63.111 of this subpart and the wastewater streams include one or more compounds on list 2 of table 36 of this subpart that do not meet the criteria in paragraph (h)(1)(ii) of this section, the owner or operator shall determine f_{bio} for the list 2 compounds using any of the procedures specified in appendix C of 40 CFR part 63. (The symbol “f_{bio}” represents the site specific fraction of an individual Table 8 or Table 9 compound that is biodegraded.) The owner or operator shall calculate f_{bio} for the list 1 compounds using the defaults for first order biodegradation rate constants (K₁) in table 37 of subpart G and follow the procedure explained in form III of appendix C, 40 CFR part 63, or any of the procedures specified in appendix C, 40 CFR part 63.

(ii) *Biological treatment processes that are not enhanced biological treatment processes.* For biological treatment processes that do not meet the definition for “enhanced biological treatment process” in §63.111 of this subpart, the owner or operator shall determine the f_{bio} for the list 1 and 2 compounds using any of the procedures in appendix C to part 63, except procedure 3 (inlet and outlet concentration measurements). (The symbol “f_{bio}” represents the site specific fraction of an individual Table 8 or Table 9 compound that is biodegraded.)

(i) *Performance tests for control devices other than flares.* This paragraph applies to performance tests that are conducted to demonstrate compliance of a control device with the efficiency limits specified in §63.139(c). If complying with the 95-percent reduction efficiency requirement, comply with the requirements specified in paragraphs (i)(1) through (i)(9) of this section. If complying with the 20 ppm by volume requirement, comply with the requirements specified in paragraphs (i)(1) through (i)(6) and (i)(9)

of this section. The 20 ppm by volume limit or 95-percent reduction efficiency requirement shall be measured as either total organic hazardous air pollutants or as TOC minus methane and ethane.

(1) *Sampling sites.* Sampling sites shall be selected using Method 1 or 1A of 40 CFR part 60, appendix A, as appropriate. For determination of compliance with the 95 percent reduction requirement, sampling sites shall be located at the inlet and the outlet of the control device. For determination of compliance with the 20 parts per million by volume limit, the sampling site shall be located at the outlet of the control device.

(2) *Concentration in gas stream entering or exiting the control device.* The concentration of total organic hazardous air pollutants or TOC in a gas stream shall be determined as provided in this paragraph. Samples may be grab samples or composite samples (i.e., integrated samples). Samples shall be taken at approximately equally spaced time intervals over a 1-hour period. Each 1-hour period constitutes a run, and the performance test shall consist of a minimum of 3 runs. Concentration measurements shall be determined using Method 18 of 40 CFR part 60, appendix A. Alternatively, any other test method validated according to the procedures in Method 301 of appendix A of this part may be used.

(3) *Volumetric flow rate of gas stream entering or exiting the control device.* The volumetric flow rate of the gas stream shall be determined using Method 2, 2A, 2C, or 2D of 40 CFR part 60, appendix A, as appropriate. Volumetric flow rate measurements shall be taken at the same time as the concentration measurements.

(4) *Calculation of TOC concentration.* The TOC concentration (CG_T) is the sum of the concentrations of the individual components. If compliance is being determined based on TOC, the owner or operator shall compute TOC for each run using the following equation:

$$CG_T = \frac{1}{m} \sum_{j=1}^m \left(\sum_{i=1}^n CGS_{i,j} \right) \quad (\text{Eqn WW14})$$

Where:

CG_T = Total concentration of TOC (minus methane and ethane) in vented gas stream, average of samples, dry basis, parts per million by volume.

$CGS_{i,j}$ = Concentration of sample components in vented gas stream for sample j, dry basis, parts per million by volume.

i = Identifier for a compound.

n = Number of components in the sample.

j = Identifier for a sample.

m = Number of samples in the sample run.

(5) *Calculation of total organic hazardous air pollutants concentration.* The owner or operator determining compliance based on total organic hazardous air pollutants concentration (C_{HAP}) shall compute C_{HAP} according to the Equation WW14, except that only Table 9 compounds shall be summed.

(6) *Percent oxygen correction for combustion control devices.* If the control device is a combustion device, comply with the requirements specified in paragraph (i)(6)(i) of this section to determine oxygen concentration, and in paragraph (i)(6)(ii) of this section to calculate the percent oxygen correction.

(i) *Oxygen concentration.* The concentration of TOC or total organic hazardous air pollutants shall be corrected to 3 percent oxygen if the control device is a combustion device. The emission rate correction factor for excess air, composite sampling (i.e., integrated sampling) and analysis procedures of Method

3B of 40 CFR part 60, appendix A shall be used to determine the actual oxygen concentration (%O_{2d}). The samples shall be taken during the same time that the TOC (minus methane or ethane) or total organic hazardous air pollutants samples are taken.

(ii) *3 percent oxygen calculation.* The concentration corrected to 3 percent oxygen (CG_c), when required, shall be computed using the following equation:

$$CG_c = CG_T \left(\frac{17.9}{20.9 - \%O_{2d}} \right) \quad (\text{Eqn WW15})$$

Where:

CG_c=Concentration of TOC or organic hazardous air pollutants corrected to 3 percent oxygen, dry basis, parts per million by volume.

CG_T=Total concentration of TOC (minus methane and ethane) in vented gas stream, average of samples, dry basis, parts per million by volume.

%O_{2d}=Concentration of oxygen measured in vented gas stream, dry basis, percent by volume.

(7) *Mass rate calculation.* The mass rate of either TOC (minus methane and ethane) or total organic hazardous air pollutants shall be calculated using the following equations. Where the mass rate of TOC is being calculated, all organic compounds (minus methane and ethane) measured by methods specified in paragraph (i)(2) of this section are summed using Equations WW16 and WW17. Where the mass rate of total organic hazardous air pollutants is being calculated, only Table 9 compounds shall be summed using Equations WW16 and WW17.

$$QMG_a = K_2 \left(\sum_{i=1}^n CG_{a,i} MW_i \right) QG_a \quad (\text{Eqn WW16})$$

$$QMG_b = K_2 \left(\sum_{i=1}^n CG_{b,i} MW_i \right) QG_b \quad (\text{Eqn WW17})$$

Where:

CG_{a,i}, CG_{b,i}=Concentration of TOC (minus methane and ethane) or total organic hazardous air pollutants, in vented gas stream, entering (CG_{a,i}) and exiting (CG_{b,i}) the control device, dry basis, parts per million by volume.

QMG_a, QMG_b=Mass rate of TOC (minus methane and ethane) or total organic hazardous air pollutants, in vented gas stream, entering (QMG_a) and exiting (QMG_b) the control device, dry basis, kilograms per hour.

MW_i=Molecular weight of a component, kilogram/kilogram-mole.

QG_a, QG_b=Flow rate of gas stream entering (QG_a) and exiting (QG_b) the control device, dry standard cubic meters per hour.

K₂=Constant, 41.57×10⁻⁹(parts per million)⁻¹(gram-mole per standard cubic meter) (kilogram/gram), where standard temperature (gram-mole per standard cubic meter) is 20 °

Celsius.

i=Identifier for a compound.

n=Number of components in the sample.

(8) *Percent reduction calculation.* The percent reduction in TOC (minus methane and ethane) or total organic hazardous air pollutants shall be calculated as follows:

$$E = \frac{QMG_a - QMG_b}{QMG_a} (100\%) \quad (\text{Eqn WW18})$$

Where:

E=Destruction efficiency of control device, percent.

QMG_a , QMG_b =Mass rate of TOC (minus methane and ethane) or total organic hazardous air pollutants, in vented gas stream entering and exiting (QMG_b) the control device, dry basis, kilograms per hour.

(9) *Compare mass destruction efficiency to required efficiency.* If complying with the 95 percent reduction efficiency requirement, compliance is demonstrated if the mass destruction efficiency (calculated in Equation WW18) is 95 percent or greater. If complying with the 20 parts per million by volume limit in §63.139 (c)(1)(ii) of this subpart, compliance is demonstrated if the outlet total organic compound concentration, less methane and ethane, or total organic hazardous air pollutants concentration is 20 parts per million by volume, or less. For combustion control devices, the concentration shall be calculated on a dry basis, corrected to 3 percent oxygen.

(j) When a flare is used to comply with §63.139(c), the owner or operator shall comply with paragraphs (j)(1) through (3) of this section. The owner or operator is not required to conduct a performance test to determine percent emission reduction or outlet organic HAP or TOC concentration.

(1) Conduct a visible emission test using the techniques specified in §63.11(b)(4).

(2) Determine the net heating value of the gas being combusted using the techniques specified in §63.11(b)(6).

(3) Determine the exit velocity using the techniques specified in either §63.11(b)(7)(i) (and §63.11(b)(7)(iii), where applicable) or §63.11(b)(8), as appropriate.

[62 FR 2765, Jan. 17, 1997, as amended at 63 FR 67793, Dec. 9, 1998; 64 FR 20192, Apr. 26, 1999; 66 FR 6933, Jan. 22, 2001]

§ 63.146 Process wastewater provisions—reporting.

(a) For each waste management unit, treatment process, or control device used to comply with §§63.138 (b)(1), (c)(1), (d), (e), (f), or (g) of this subpart for which the owner or operator seeks to monitor a parameter other than those specified in table 11, table 12, or table 13 of this subpart, the owner or operator shall submit a request for approval to monitor alternative parameters according to the procedures specified in §63.151(f) or (g) of this subpart.

(b) The owner or operator shall submit the information specified in paragraphs (b)(1) through (b)(9) of this section as part of the Notification of Compliance Status required by §63.152(b) of this subpart.

(1) *Requirements for Group 2 wastewater streams.* This paragraph does not apply to Group 2 wastewater streams that are used to comply with §63.138(g). For Group 2 wastewater streams, the

owner or operator shall include the information specified in paragraphs (b)(1)(i) through (iv) of this section in the Notification of Compliance Status Report. This information may be submitted in any form. Table 15 of this subpart is an example.

(i) Process unit identification and description of the process unit.

(ii) Stream identification code.

(iii) For existing sources, concentration of table 9 compound(s) in parts per million, by weight. For new sources, concentration of table 8 and/or table 9 compound(s) in parts per million, by weight. Include documentation of the methodology used to determine concentration.

(iv) Flow rate in liter per minute.

(2) For each new and existing source, the owner or operator shall submit the information specified in table 15 of this subpart for Table 8 and/or Table 9 compounds.

(3) [Reserved]

(4) For each treatment process identified in table 15 of this subpart that receives, manages, or treats a Group 1 wastewater stream or residual removed from a Group 1 wastewater stream, the owner or operator shall submit the information specified in table 17 of this subpart.

(5) For each waste management unit identified in table 15 of this subpart that receives or manages a Group 1 wastewater stream or residual removed from a Group 1 wastewater stream, the owner or operator shall submit the information specified in table 18 of this subpart.

(6) For each residual removed from a Group 1 wastewater stream, the owner or operator shall report the information specified in table 19 of this subpart.

(7) For each control device used to comply with §§63.133 through 63.139 of this subpart, the owner or operator shall report the information specified in paragraphs (b)(7)(i) and (b)(7)(ii) of this section.

(i) For each flare, the owner or operator shall submit the information specified in paragraphs (b)(7)(i)(A) through (b)(7)(i)(C) of this section.

(A) Flare design (i.e., steam-assisted, air-assisted, or non-assisted);

(B) All visible emission readings, heat content determinations, flow rate measurements, and exit velocity determinations made during the compliance determination required by §63.139(c)(3) of this subpart; and

(C) Reports of the times and durations of all periods during the compliance determination when the pilot flame is absent or the monitor is not operating.

(ii) For each control device other than a flare, the owner or operator shall submit the information specified in paragraph (b)(7)(ii)(A) of this section and in either paragraph (b)(7)(ii)(B) or (b)(7)(ii)(C) of this section.

(A) The information on parameter ranges specified in §63.152(b)(2) of this subpart for the applicable parameters specified in table 13 of this subpart, unless the parameter range has already been established in the operating permit; and either

(B) The design evaluation specified in §63.139(d)(2) of this subpart; or

(C) Results of the performance test specified in §63.139(d)(1) of this subpart. Performance test results shall include operating ranges of key process and control parameters during the performance test; the value of each parameter being monitored in accordance with §63.143 of this subpart; and applicable supporting calculations.

(8) For each treatment process used to comply with §63.138(b)(1), (c)(1), (d), (e), (f), or (g) of this subpart, the owner or operator shall submit the information specified in paragraphs (b)(8)(i) and (b)(8)(ii) of this section.

(i) For Items 1 and 2 in table 12 of this subpart, the owner or operator shall submit the information specified in paragraphs (b)(8)(i)(A) and (b)(8)(i)(B) of this section. An owner or operator using the design steam stripper compliance option specified §63.138(d) of this subpart does not have to submit the information specified in paragraph (b)(8)(i)(A) or (b)(8)(i)(B) of this section. However, the monitoring requirements specified in Item 2 of table 12 of this subpart still apply.

(A) The information on parameter ranges specified in §63.152(b)(2) of this subpart for the parameters approved by the Administrator, unless the parameter range has already been established in the operating permit.

(B) Results of the initial measurements of the parameters approved by the Administrator and any applicable supporting calculations.

(ii) For Item 3 in table 12 of this subpart, the owner or operator shall submit the information on parameter ranges specified in §63.152(b)(2) of this subpart for the parameters specified in Item 3 of table 12 of this subpart, unless the parameter range has already been established in the operating permit.

(9) For each waste management unit or treatment process used to comply with §63.138(b)(1), (c)(1), (e), (f), or (g), the owner or operator shall submit the information specified in either paragraph (b)(9)(i) or (ii) of this section.

(i) The design evaluation and supporting documentation specified in §63.138(j)(1) of this subpart.

(ii) Results of the performance test specified in §63.138(j)(2) of this subpart. Performance test results shall include operating ranges of key process and control parameters during the performance test; the value of each parameter being monitored in accordance with §63.143 of this subpart; and applicable supporting calculations.

(c) For each waste management unit that receives, manages, or treats a Group 1 wastewater stream or residual removed from a Group 1 wastewater stream, the owner or operator shall submit as part of the next Periodic Report required by §63.152(c) of this subpart the results of each inspection required by §63.143(a) of this subpart in which a control equipment failure was identified. Control equipment failure is defined for each waste management unit in §§63.133 through 63.137 of this subpart. Each Periodic Report shall include the date of the inspection, identification of each waste management unit in which a control equipment failure was detected, description of the failure, and description of the nature of and date the repair was made.

(d) Except as provided in paragraph (f) of this section, for each treatment process used to comply with §63.138(b)(1), (c)(1), (d), (e), (f), or (g), the owner or operator shall submit as part of the next Periodic Report required by §63.152(c) the information specified in paragraphs (d)(1), (2), and (3) of this section for the monitoring required by §63.143(b), (c), and (d).

(1) For Item 1 in table 12, the owner or operator shall submit the results of measurements that indicate that the biological treatment unit is outside the range established in the Notification of Compliance Status or operating permit.

(2) For Item 2 in table 12, the owner or operator shall submit the monitoring results for each operating day during which the daily average value of a continuously monitored parameter is outside the range established in the Notification of Compliance Status or operating permit.

(3) For Item 3 in table 12 of this subpart, the owner or operator shall submit the monitoring results for each operating day during which the daily average value of any monitored parameter approved in accordance with §63.151 (f) was outside the range established in the Notification of Compliance Status or operating permit.

(e) Except as provided in paragraph (f) of this section, for each control device used to comply with §§63.133 through 63.139 of this subpart, the owner or operator shall submit as part of the next Periodic

Report required by §63.152(c) of this subpart the information specified in either paragraph (e)(1) or (e)(2) of this section.

(1) The information specified in table 20 of this subpart, or

(2) If the owner or operator elects to comply with §63.143(e)(2) of this subpart, i.e., an organic monitoring device installed at the outlet of the control device, the owner or operator shall submit the monitoring results for each operating day during which the daily average concentration level or reading is outside the range established in the Notification of Compliance Status or operating permit.

(f) Where the owner or operator obtains approval to use a treatment process or control device other than one for which monitoring requirements are specified in §63.143 of this subpart, or to monitor parameters other than those specified in table 12 or 13 of this subpart, the Administrator will specify appropriate reporting requirements.

(g) If an extension is utilized in accordance with §63.133(e)(2) or §63.133(h) of this subpart, the owner or operator shall include in the next periodic report the information specified in §63.133 (e)(2) or §63.133 (h).

[62 FR 2774, Jan. 17, 1997, as amended at 64 FR 20192, Apr. 26, 1999; 66 FR 6933, Jan. 22, 2001]

§ 63.147 Process wastewater provisions—recordkeeping.

(a) The owner or operator transferring a Group 1 wastewater stream or residual removed from a Group 1 wastewater stream in accordance with §63.132(g) of this subpart shall keep a record of the notice sent to the treatment operator stating that the wastewater stream or residual contains organic hazardous air pollutants which are required to be managed and treated in accordance with the provisions of this subpart.

(b) The owner or operator shall keep in a readily accessible location the records specified in paragraphs (b)(1) through (8) of the section.

(1) A record that each waste management unit inspection required by §§63.133 through 63.137 of this subpart was performed.

(2) A record that each inspection for control devices required by §63.139 of this subpart was performed.

(3) A record of the results of each seal gap measurement required by §§63.133(d) and 63.137(c) of this subpart. The records shall include the date of the measurement, the raw data obtained in the measurement, and the calculations described in §63.120(b)(2), (3), and (4) of this subpart.

(4) For Item 1 and Item 3 of table 12 of this subpart, the owner or operator shall keep the records approved by the Administrator.

(5) Except as provided in paragraph (e) of this section, continuous records of the monitored parameters specified in Item 2 of table 12 and table 13 of this subpart, and in §63.143(e)(2) of this subpart.

(6) Documentation of a decision to use an extension, as specified in §63.133(e)(2) or (h) of this subpart, which shall include a description of the failure, documentation that alternate storage capacity is unavailable, and specification of a schedule of actions that will ensure that the control equipment will be repaired or the vessel will be emptied as soon as practical.

(7) Documentation of a decision to use a delay of repair due to unavailability of parts, as specified in §63.140(c), shall include a description of the failure, the reason additional time was necessary (including a statement of why replacement parts were not kept on site and when the manufacturer promised delivery), and the date when repair was completed.

(8) *Requirements for Group 2 wastewater streams.* This paragraph (b)(8) does not apply to Group 2 wastewater streams that are used to comply with §63.138(g). For all other Group 2 wastewater streams, the owner or operator shall keep in a readily accessible location the records specified in paragraphs (b)

(8)(i) through (iv) of this section.

(i) Process unit identification and description of the process unit.

(ii) Stream identification code.

(iii) For existing sources, concentration of table 9 compound(s) in parts per million, by weight. For new sources, concentration of table 8 and/or table 9 compound(s) in parts per million, by weight. Include documentation of the methodology used to determine concentration.

(iv) Flow rate in liter per minute.

(c) For each boiler or process heater used to comply with §§63.133 through 63.139 of this subpart, the owner or operator shall keep a record of any changes in the location at which the vent stream is introduced into the flame zone as required in §63.139(c)(1) of this subpart.

(d) The owner or operator shall keep records of the daily average value of each continuously monitored parameter for each operating day as specified in §63.152(f), except as provided in paragraphs (d)(1) through (3) of this section.

(1) For flares, records of the times and duration of all periods during which the pilot flame is absent shall be kept rather than daily averages.

(2) *Regenerative carbon adsorbers.* For regenerative carbon adsorbers, the owner or operator shall keep the records specified in paragraphs (d)(2)(i) and (ii) of this section instead of daily averages.

(i) Records of the total regeneration stream mass flow for each carbon bed regeneration cycle.

(ii) Records of the temperature of the carbon bed after each regeneration cycle.

(3) *Non-regenerative carbon adsorbers.* For non-regenerative carbon adsorbers using organic monitoring equipment, the owner or operator shall keep the records specified in paragraph (d)(3)(i) of this section instead of daily averages. For non-regenerative carbon adsorbers replacing the carbon adsorption system with fresh carbon at a regular predetermined time interval that is less than the carbon replacement interval that is determined by the maximum design flow rate and organic concentration in the gas stream vented to the carbon adsorption system, the owner or operator shall keep the records specified in paragraph (d)(3)(ii) of this section instead of daily averages.

(i)(A) Record of how the monitoring frequency, as specified in table 13 of this subpart, was determined.

(B) Records of when organic compound concentration of adsorber exhaust was monitored.

(C) Records of when the carbon was replaced.

(ii)(A) Record of how the carbon replacement interval, as specified in table 13 of this subpart, was determined.

(B) Records of when the carbon was replaced.

(e) Where the owner or operator obtains approval to use a control device other than one for which monitoring requirements are specified in §63.143 of this subpart, or to monitor parameters other than those specified in table 12 or table 13 of this subpart, the Administrator will specify appropriate recordkeeping requirements.

(f) If the owner or operator uses process knowledge to determine the annual average concentration of a wastewater stream as specified in §63.144(b)(3) of this subpart and/or uses process knowledge to determine the annual average flow rate as specified in §63.144(c)(1) of this subpart, and determines that the wastewater stream is not a Group 1 wastewater stream, the owner or operator shall keep in a readily accessible location the documentation of how process knowledge was used to determine the annual

average concentration and/or the annual average flow rate of the wastewater stream.

[62 FR 2775, Jan. 17, 1997, as amended at 64 FR 20192, Apr. 26, 1999; 66 FR 6933, Jan. 22, 2001]

§ 63.148 Leak inspection provisions.

(a) Except as provided in paragraph (k) of this section, for each vapor collection system, closed-vent system, fixed roof, cover, or enclosure required to comply with this section, the owner or operator shall comply with the requirements of paragraphs (b) through (j) of this section.

(b) Except as provided in paragraphs (g) and (h) of this section, each vapor collection system and closed-vent system shall be inspected according to the procedures and schedule specified in paragraphs (b)(1) and (b)(2) of this section and each fixed roof, cover, and enclosure shall be inspected according to the procedures and schedule specified in paragraph (b)(3) of this section.

(1) If the vapor collection system or closed vent system is constructed of hard-piping, the owner or operator shall:

(i) Conduct an initial inspection according to the procedures in paragraph (c) of this section, and

(ii) Conduct annual visual inspections for visible, audible, or olfactory indications of leaks.

(2) If the vapor collection system or closed vent system is constructed of ductwork, the owner or operator shall:

(i) Conduct an initial inspection according to the procedures in paragraph (c) of this section, and

(ii) Conduct annual inspections according to the procedures in paragraph (c) of this section.

(iii) Conduct annual visual inspections for visible, audible, or olfactory indications of leaks.

(3) For each fixed roof, cover, and enclosure, the owner or operator shall conduct initial visual inspections and semi-annual visual inspections for visible, audible, or olfactory indications of leaks as specified in §§63.133 through 63.137 of this subpart.

(c) Each vapor collection system and closed vent system shall be inspected according to the procedures specified in paragraphs (c)(1) through (c)(5) of this section.

(1) Inspections shall be conducted in accordance with Method 21 of 40 CFR part 60, appendix A.

(2)(i) Except as provided in paragraph (c)(2)(ii) of this section, the detection instrument shall meet the performance criteria of Method 21 of 40 CFR part 60, appendix A, except the instrument response factor criteria in section 3.1.2(a) of Method 21 shall be for the average composition of the process fluid not each individual volatile organic compound in the stream. For process streams that contain nitrogen, air, or other inerts which are not organic hazardous air pollutants or volatile organic compounds, the average stream response factor shall be calculated on an inert-free basis.

(ii) If no instrument is available at the plant site that will meet the performance criteria specified in paragraph (c)(2)(i) of this section, the instrument readings may be adjusted by multiplying by the average response factor of the process fluid, calculated on an inert-free basis as described in paragraph (c)(2)(i) of this section.

(3) The detection instrument shall be calibrated before use on each day of its use by the procedures specified in Method 21 of 40 CFR part 60, appendix A.

(4) Calibration gases shall be as follows:

(i) Zero air (less than 10 parts per million hydrocarbon in air); and

(ii) Mixtures of methane in air at a concentration less than 10,000 parts per million. A calibration gas other than methane in air may be used if the instrument does not respond to methane or if the instrument does not meet the performance criteria specified in paragraph (c)(2)(i) of this section. In such cases, the calibration gas may be a mixture of one or more of the compounds to be measured in air.

(5) An owner or operator may elect to adjust or not adjust instrument readings for background. If an owner or operator elects to not adjust readings for background, all such instrument readings shall be compared directly to the applicable leak definition to determine whether there is a leak. If an owner or operator elects to adjust instrument readings for background, the owner or operator shall measure background concentration using the procedures in §§63.180(b) and (c) of subpart H of this part. The owner or operator shall subtract background reading from the maximum concentration indicated by the instrument.

(6) The arithmetic difference between the maximum concentration indicated by the instrument and the background level shall be compared with 500 parts per million for determining compliance.

(d) Leaks, as indicated by an instrument reading greater than 500 parts per million above background or by visual inspections, shall be repaired as soon as practicable, except as provided in paragraph (e) of this section.

(1) A first attempt at repair shall be made no later than 5 calendar days after the leak is detected.

(2) Repair shall be completed no later than 15 calendar days after the leak is detected, except as provided in paragraph (d)(3) of this section.

(3) For leaks found in vapor collection systems used for transfer operations, repairs shall be completed no later than 15 calendar days after the leak is detected or at the beginning of the next transfer loading operation, whichever is later.

(e) Delay of repair of a vapor collection system, closed vent system, fixed roof, cover, or enclosure for which leaks have been detected is allowed if the repair is technically infeasible without a shutdown, as defined in §63.101 of subpart F of this part, or if the owner or operator determines that emissions resulting from immediate repair would be greater than the fugitive emissions likely to result from delay of repair. Repair of such equipment shall be complete by the end of the next shutdown.

(f) For each vapor collection system or closed vent system that contains bypass lines that could divert a vent stream away from the control device and to the atmosphere, the owner or operator shall comply with the provisions of either paragraph (f)(1) or (f)(2) of this section, except as provided in paragraph (f)(3) of this section.

(1) Install, calibrate, maintain, and operate a flow indicator that determines whether vent stream flow is present at least once every 15 minutes. Records shall be generated as specified in §63.118(a)(3) of this subpart. The flow indicator shall be installed at the entrance to any bypass line; or

(2) Secure the bypass line valve in the closed position with a car-seal or a lock-and-key type configuration. A visual inspection of the seal or closure mechanism shall be performed at least once every month to ensure the valve is maintained in the closed position and the vent stream is not diverted through the bypass line.

(3) Equipment such as low leg drains, high point bleeds, analyzer vents, open-ended valves or lines, and pressure relief valves needed for safety purposes are not subject to this paragraph.

(g) Any parts of the vapor collection system, closed vent system, fixed roof, cover, or enclosure that are designated, as described in paragraph (i)(1) of this section, as unsafe to inspect are exempt from the inspection requirements of paragraphs (b)(1), (b)(2), and (b)(3)(i) of this section if:

(1) The owner or operator determines that the equipment is unsafe to inspect because inspecting personnel would be exposed to an imminent or potential danger as a consequence of complying with paragraphs (b)(1), (b)(2), or (b)(3)(i) of this section; and

(2) The owner or operator has a written plan that requires inspection of the equipment as frequently as

practicable during safe-to-inspect times.

(h) Any parts of the vapor collection system, closed vent system, fixed roof, cover, or enclosure that are designated, as described in paragraph (i)(2) of this section, as difficult to inspect are exempt from the inspection requirements of paragraphs (b)(1), (b)(2), and (b)(3)(i) of this section if:

(1) The owner or operator determines that the equipment cannot be inspected without elevating the inspecting personnel more than 2 meters above a support surface; and

(2) The owner or operator has a written plan that requires inspection of the equipment at least once every 5 years.

(i) The owner or operator shall record the information specified in paragraphs (i)(1) through (i)(5) of this section.

(1) Identification of all parts of the vapor collection system, closed vent system, fixed roof, cover, or enclosure that are designated as unsafe to inspect, an explanation of why the equipment is unsafe to inspect, and the plan for inspecting the equipment.

(2) Identification of all parts of the vapor collection system, closed vent system, fixed roof, cover, or enclosure that are designated as difficult to inspect, an explanation of why the equipment is difficult to inspect, and the plan for inspecting the equipment.

(3) For each vapor collection system or closed vent system that contains bypass lines that could divert a vent stream away from the control device and to the atmosphere, the owner or operator shall keep a record of the information specified in either paragraph (i)(3)(i) or (i)(3)(ii) of this section.

(i) Hourly records of whether the flow indicator specified under paragraph (f)(1) of this section was operating and whether a diversion was detected at any time during the hour, as well as records of the times of all periods when the vent stream is diverted from the control device or the flow indicator is not operating.

(ii) Where a seal mechanism is used to comply with paragraph (f)(2) of this section, hourly records of flow are not required. In such cases, the owner or operator shall record whether the monthly visual inspection of the seals or closure mechanisms has been done, and shall record the occurrence of all periods when the seal mechanism is broken, the bypass line valve position has changed, or the key for a lock-and-key type configuration has been checked out, and records of any car-seal that has broken.

(4) For each inspection during which a leak is detected, a record of the information specified in paragraphs (i)(4)(i) through (i)(4)(viii) of this section.

(i) The instrument identification numbers; operator name or initials; and identification of the equipment.

(ii) The date the leak was detected and the date of the first attempt to repair the leak.

(iii) Maximum instrument reading measured by the method specified in paragraph (d) of this section after the leak is successfully repaired or determined to be nonrepairable.

(iv) "Repair delayed" and the reason for the delay if a leak is not repaired within 15 calendar days after discovery of the leak.

(v) The name, initials, or other form of identification of the owner or operator (or designee) whose decision it was that repair could not be effected without a shutdown.

(vi) The expected date of successful repair of the leak if a leak is not repaired within 15 calendar days.

(vii) Dates of shutdowns that occur while the equipment is unrepaired.

(viii) The date of successful repair of the leak.

(5) For each inspection conducted in accordance with paragraph (c) of this section during which no leaks are detected, a record that the inspection was performed, the date of the inspection, and a statement that no leaks were detected.

(6) For each visual inspection conducted in accordance with paragraph (b)(1)(ii) or (b)(3)(ii) of this section during which no leaks are detected, a record that the inspection was performed, the date of the inspection, and a statement that no leaks were detected.

(j) The owner or operator shall submit with the reports required by §63.182(b) of subpart H of this part or with the reports required by §63.152(c) of this subpart, the information specified in paragraphs (j)(1) through (j)(3) of this section.

(1) The information specified in paragraph (i)(4) of this section;

(2) Reports of the times of all periods recorded under paragraph (i)(3)(i) of this section when the vent stream is diverted from the control device through a bypass line; and

(3) Reports of all periods recorded under paragraph (i)(3)(ii) of this section in which the seal mechanism is broken, the bypass line valve position has changed, or the key to unlock the bypass line valve was checked out.

(k) If a closed-vent system subject to this section is also subject to §63.172 of subpart H of this part, the owner or operator shall comply with the provisions of §63.172 of subpart H of this part and is exempt from the requirements of this section.

[59 FR 19468, Apr. 22, 1994, as amended at 60 FR 63628, Dec. 12, 1995; 62 FR 2775, Jan. 17, 1997; 64 FR 20192, Apr. 26, 1999]

§ 63.149 Control requirements for certain liquid streams in open systems within a chemical manufacturing process unit.

(a) The owner or operator shall comply with the provisions of table 35 of this subpart, for each item of equipment meeting all the criteria specified in paragraphs (b) through (d) and either paragraph (e)(1) or (e)(2) of this section.

(b) The item of equipment is of a type identified in table 35 of this subpart;

(c) The item of equipment is part of a chemical manufacturing process unit that meets the criteria of §63.100(b) of subpart F of this part;

(d) The item of equipment is controlled less stringently than in table 35 and is not listed in §63.100(f) of subpart F of this part, and the item of equipment is not otherwise exempt from controls by the provisions of subparts A, F, G, or H of this part; and

(e) The item of equipment:

(1) is a drain, drain hub, manhole, lift station, trench, pipe, or oil/water separator that conveys water with a total annual average concentration greater than or equal to 10,000 parts per million by weight of Table 9 compounds at any flowrate; or a total annual average concentration greater than or equal to 1,000 parts per million by weight of Table 9 compounds at an annual average flow rate greater than or equal to 10 liters per minute. At a chemical manufacturing process unit subject to the new source requirements of 40 CFR 63.100(l)(1) or 40 CFR 63.100(l)(2), the criteria of this paragraph are also met if the item of equipment conveys water with an annual average concentration greater than or equal to 10 parts per million by weight of any Table 8 compound at an annual average flow rate greater than or equal to 0.02 liter per minute, or

(2) is a tank that receives one or more streams that contain water with a total annual average concentration greater than or equal to 1,000 ppm (by weight) of Table 9 compounds at an annual average flowrate greater than or equal to 10 liters per minute. At a chemical manufacturing process unit subject to the new source requirements of 40 CFR 63.100(l)(1) or 40 CFR 63.100 (l)(2), the criteria of

this paragraph are also met if the tank receives one or more streams that contain water with an annual average concentration greater than or equal to 10 parts per million by weight of any Table 8 compound at an annual average flow rate greater than or equal to 0.02 liter per minute. The owner or operator of the source shall determine the characteristics of the stream as specified in paragraphs (e)(2) (i) and (ii) of this section.

(i) The characteristics of the stream being received shall be determined at the inlet to the tank.

(ii) The characteristics shall be determined according to the procedures in §63.144 (b) and (c).

[62 FR 2776, Jan. 17, 1997]

§ 63.150 Emissions averaging provisions.

(a) This section applies to owners or operators of existing sources who seek to comply with the emission standard in §63.112(a) of this subpart by using emissions averaging according to §63.112(f) of this subpart rather than following the provisions of §§63.113 through 63.148 of this subpart. Notwithstanding the definition of process vent in §63.101 and the sampling site designation in §63.115(a), for purposes of this section the location of a process vent shall be defined, and the characteristics of its gas stream shall be determined, consistent with paragraph (g)(2)(i) of this section.

(b) Unless an operating permit application has been submitted, the owner or operator shall develop and submit for approval an Implementation Plan containing all of the information required in §63.151(d) of this subpart for all points to be included in an emissions average. The Implementation Plan or operating permit application shall identify all emission points to be included in the emissions average. This must include any Group 1 emission points to which the reference control technology (defined in §63.111 of this subpart) is not applied and all other emission points being controlled as part of the average.

(c) The following emission points can be used to generate emissions averaging credits, if control was applied after November 15, 1990 and if sufficient information is available to determine the appropriate value of credits for the emission point:

(1) Group 2 emission points.

(2) Group 1 emission points that are controlled by a technology that the Administrator or permitting authority agrees has a higher nominal efficiency than the reference control technology. Information on the nominal efficiencies for such technologies must be submitted and approved as provided in paragraph (i) of this section.

(3) Emission points from which emissions are reduced by pollution prevention measures. Percent reductions for pollution prevention measures shall be determined as specified in paragraph (j) of this section.

(i) For a Group 1 emission point, the pollution prevention measure must reduce emissions more than the reference control technology would have had the reference control technology been applied to the emission point instead of the pollution prevention measure except as provided in paragraph (c)(3)(ii) of this section.

(ii) If a pollution prevention measure is used in conjunction with other controls for a Group 1 emission point, the pollution prevention measure alone does not have to reduce emissions more than the reference control technology, but the combination of the pollution prevention measure and other controls must reduce emissions more than the reference control technology would have had it been applied instead.

(d) The following emission points cannot be used to generate emissions averaging credits:

(1) Emission points already controlled on or before November 15, 1990, unless the level of control is increased after November 15, 1990, in which case credit will be allowed only for the increase in control after November 15, 1990.

(2) Group 1 emission points that are controlled by a reference control technology, unless the reference control technology has been approved for use in a different manner and a higher nominal efficiency has been assigned according to the procedures in paragraph (i) of this section. For example, it is not allowable to claim that an internal floating roof meeting the specifications of §63.119(b) of this subpart applied to a storage vessel is achieving greater than 95 percent control.

(3) Emission points on shut-down process units. Process units that are shut down cannot be used to generate credits or debits.

(4) Wastewater that is not process wastewater or wastewater streams treated in biological treatment units. These two types of wastewater cannot be used to generate credits or debits. For the purposes of this section, the terms wastewater and wastewater stream are used to mean process wastewater.

(5) Emission points controlled to comply with a State or Federal rule other than this subpart, unless the level of control has been increased after November 15, 1990 above what is required by the other State or Federal rule. Only the control above what is required by the other State or Federal rule will be credited. However, if an emission point has been used to generate emissions averaging credit in an approved emissions average, and the point is subsequently made subject to a State or Federal rule other than this subpart, the point can continue to generate emissions averaging credit for the purpose of complying with the previously approved average.

(e) For all points included in an emissions average, the owner or operator shall:

(1) Calculate and record monthly debits for all Group 1 emission points that are controlled to a level less stringent than the reference control technology for those emission points. Equations in paragraph (g) of this section shall be used to calculate debits.

(2) Calculate and record monthly credits for all Group 1 or Group 2 emission points that are overcontrolled to compensate for the debits. Equations in paragraph (h) of this section shall be used to calculate credits. Emission points and controls that meet the criteria of paragraph (c) of this section may be included in the credit calculation, whereas those described in paragraph (d) of this section shall not be included.

(3) Demonstrate that annual credits calculated according to paragraph (h) of this section are greater than or equal to debits calculated for the same annual compliance period according to paragraph (g) of this section.

(i) The owner or operator may choose to include more than the required number of credit-generating emission points in an average in order to increase the likelihood of being in compliance.

(ii) The initial demonstration in the Implementation Plan or operating permit application that credit-generating emission points will be capable of generating sufficient credits to offset the debits from the debit-generating emission points must be made under representative operating conditions. After the compliance date, actual operating data will be used for all debit and credit calculations.

(4) Demonstrate that debits calculated for a quarterly (3-month) period according to paragraph (g) of this section are not more than 1.30 times the credits for the same period calculated according to paragraph (h) of this section. Compliance for the quarter shall be determined based on the ratio of credits and debits from that quarter, with 30 percent more debits than credits allowed on a quarterly basis.

(5) Record and report quarterly and annual credits and debits in the Periodic Reports as specified in §63.152(c) of this subpart. Every fourth Periodic Report shall include a certification of compliance with the emissions averaging provisions as required by §63.152(c)(5)(iv)(B) of this subpart.

(f) Debits and credits shall be calculated in accordance with the methods and procedures specified in paragraphs (g) and (h) of this section, respectively, and shall not include emissions from the following:

(1) More than 20 individual Group 1 or Group 2 emission points. Where pollution prevention measures (as specified in paragraph (j)(1) of this section) are used to control emission points to be included in an emissions average, no more than 25 emission points may be included in the average. For example, if two emission points to be included in an emissions average are controlled by pollution prevention

measures, the average may include up to 22 emission points.

(2) Periods of start-up, shutdown, and malfunction as described in the source's start-up, shutdown, and malfunction plan required by §63.6(e)(3) of subpart A of this part.

(3) Periods of monitoring excursions as defined in §63.152(c)(2)(ii)(A) of this subpart. For these periods, the calculation of monthly credits and debits shall be adjusted as specified in paragraphs (f)(3)(i) through (f)(3)(iii) of this section.

(i) No credits would be assigned to the credit-generating emission point.

(ii) Maximum debits would be assigned to the debit-generating emission point.

(iii) The owner or operator may demonstrate to the Administrator that full or partial credits or debits should be assigned using the procedures in paragraph (l) of this section.

(g) Debits are generated by the difference between the actual emissions from a Group 1 emission point that is uncontrolled or is controlled to a level less stringent than the reference control technology, and the emissions allowed for the Group 1 emission point. Debits shall be calculated as follows:

(1) The overall equation for calculating source-wide debits is:

$$\begin{aligned} \text{Debits} = & \sum_{i=1}^n (EPV_{iACTUAL} - (0.02)EPV_{iw}) + \sum_{i=1}^n (ES_{iACTUAL} \\ & - (0.05)ES_{iu}) + \sum_{i=1}^n (ETR_{iACTUAL} - (0.02)ETR_{iw}) \\ & + \sum_{i=1}^n (EWW_{iACTUAL} - EWW_{ic}) \end{aligned}$$

where:

Debits and all terms of the equation are in units of megagrams per month, and

$EPV_{iACTUAL}$ = Emissions from each Group 1 process vent i that is uncontrolled or is controlled to a level less stringent than the reference control technology. This is calculated according to paragraph (g)(2) of this section.

(0.02) EPV_{iw} = Emissions from each Group 1 vent i if the reference control technology had been applied to the uncontrolled emissions, calculated according to paragraph (g)(2) of this section.

$ES_{iACTUAL}$ = Emissions from each Group 1 storage vessel i that is uncontrolled or is controlled to a level less stringent than the reference control technology. This is calculated according to paragraph (g)(3) of this section.

(0.05) ES_{iu} = Emissions from each Group 1 storage vessel i if the reference control technology had been applied to the uncontrolled emissions, calculated according to paragraph (g)(3) of this section.

$ETR_{iACTUAL}$ = Emissions from each Group 1 transfer rack i that is uncontrolled or is controlled to a level less stringent than the reference control technology. This is calculated according to paragraph (g)(4) of this section.

(0.02) ETR_{iu} = Emissions from each Group 1 transfer rack i if the reference control technology had been applied to the uncontrolled emissions, calculated according to paragraph (g)(4) of this section.

$EW_{iACTUAL}$ = Emissions from each Group 1 wastewater stream i that is uncontrolled or is controlled to a level less stringent than the reference control technology. This is calculated according to paragraph (g)(5) of this section.

EW_{ic} = Emissions from each Group 1 wastewater stream i if the reference control technology had been applied to the uncontrolled emissions. This is calculated according to paragraph (g)(5) of this section.

n = The number of emission points being included in the emissions average. The value of n is not necessarily the same for process vents, storage vessels, transfer racks, and wastewater.

(2) Emissions from process vents shall be calculated according to paragraphs (g)(2)(i) through (iii) of this section.

(i) The location of a process vent shall be defined, and the characteristics of its gas stream shall be determined at a point that meets the conditions in either paragraph (g)(2)(i)(A) or (B) of this section and the conditions in paragraphs (g)(2)(i)(C) through (E) of this section.

(A) The point is after the final recovery device (if any recovery devices are present).

(B) If a gas stream included in an emissions average is combined with one or more other gas streams after a final recovery device (if any recovery devices are present), then for each gas stream, the point is at a representative point after any final recovery device and as near as feasible to, but before, the point of combination of the gas streams.

(C) The point is before any control device (for process vents, recovery devices shall not be considered control devices).

(D) The point is before discharge to the atmosphere.

(E) The measurement site for determination of the characteristics of the gas stream was selected using Method 1 or 1A of 40 CFR part 60, appendix A.

(ii) The following equation shall be used for each process vent i to calculate EPV_{iu} :

$$EPV_{iu} = (2.494 \times 10^{-9}) Qh \left(\sum_{j=1}^n C_j M_j \right)$$

where:

EPV_{iu} = Uncontrolled process vent emission rate from process vent i, megagrams per month.

Q = Vent stream flow rate, dry standard cubic meters per minute, measured using Method 2, 2A, 2C, or 2D of part 60, appendix A, as appropriate.

h = Monthly hours of operation during which positive flow is present in the vent, hours per month.

C_j = Concentration, parts per million by volume, dry basis, of organic HAP j as measured by Method 18 of part 60, appendix A.

M_j =Molecular weight of organic HAP j , gram per gram-mole.

n =Number of organic HAP's.

(A) The values of Q , C_j , and M_j shall be determined during a performance test conducted under representative operating conditions. The values of Q , C_j , and M_j shall be established in the Notification of Compliance Status and must be updated as provided in paragraph (g)(2)(ii)(B) of this section.

(B) If there is a change in capacity utilization other than a change in monthly operating hours, or if any other change is made to the process or product recovery equipment or operation such that the previously measured values of Q , C_j , and M_j are no longer representative, a new performance test shall be conducted to determine new representative values of Q , C_j , and M_j . These new values shall be used to calculate debits and credits from the time of the change forward, and the new values shall be reported in the next Periodic Report.

(iii) The following procedures and equations shall be used to calculate $EPV_{iACTUAL}$:

(A) If the vent is not controlled by a control device or pollution prevention measure, $EPV_{iACTUAL} = EPV_{iu}$, where EPV_{iu} is calculated according to the procedures in paragraphs (g)(2)(i) and (g)(2)(ii) of this section.

(B) If the vent is controlled using a control device or a pollution prevention measure achieving less than 98-percent reduction,

$$EPV_{iACTUAL} = EPV_{iu} \times \left(1 - \frac{\text{Percent reduction}}{100\%} \right)$$

(1) The percent reduction shall be measured according to the procedures in §63.116 of this subpart if a combustion control device is used. For a flare meeting the criteria in §63.116(a) of this subpart, or a boiler or process heater meeting the criteria in §63.116(b) of this subpart, the percent reduction shall be 98 percent. If a non-combustion control device is used, percent reduction shall be demonstrated by a performance test at the inlet and outlet of the device, or, if testing is not feasible, by a control design evaluation and documented engineering calculations.

(2) For determining debits from Group 1 process vents, recovery devices shall not be considered control devices and cannot be assigned a percent reduction in calculating $EPV_{iACTUAL}$. The sampling site for measurement of uncontrolled emissions is after the final recovery device. However, as provided in §63.113(a)(3), a Group 1 process vent may add sufficient recovery to raise the TRE index value above 1.0, thereby becoming a Group 2 process vent.

(3) Procedures for calculating the percent reduction of pollution prevention measures are specified in paragraph (j) of this section.

(3) Emissions from storage vessels shall be calculated as follows:

(i) The following equation shall be used for each storage vessel i to calculate ES_{iu} :

$$ES_{iu} = \frac{L_B + L_W}{12}$$

where:

ES_{iu} =Uncontrolled emissions, defined as emissions from a fixed roof vessel having identical dimensions and vessel color as vessel i , megagrams per month.

L_B =Breathing loss emissions, megagrams per year, calculated according to paragraph (g)(3)(i)(A) of this section.

L_W =Working loss emissions, megagrams per year, calculated according to paragraph (g)(3)(i)(B) of this section.

12=Constant, months per year.

(A) Breathing loss emissions shall be calculated using the following equation:

$$L_B = 1.02 \times 10^{-5} M_v \left(\frac{P}{P_A - P} \right) 0.68 D^{1.73} H^{0.51} \Delta T^{0.50} F_p C K_C$$

where:

M_v =Molecular weight of vapor in storage vessel, pound per pound-mole.

P_A =Average atmospheric pressure, pounds per square inch absolute.

P =True vapor pressure of the HAP at liquid storage temperature, pounds per square inch absolute. See table 21 of this subpart.

D = Tank diameter, feet.

H =Average vapor space height, feet. Use vessel-specific values or an assumed value of one-half the height.

ΔT =Average ambient diurnal temperature change, °F. A typical value of 20 °F may be used.

F_p =Paint factor, dimensionless, from table 22 of this subpart; use $F_p=1$ for vessels located indoors.

C =Adjustment factor for small diameter tanks, dimensionless; use $C=1$ for diameter ≥ 30 feet; use $C = 0.0771D - 0.0013D^2 - 0.1334$ for diameter < 30 feet.

K_C =Product factor, dimensionless. Use 1.0 for organic HAP's.

(B) Working losses shall be calculated using the following equation:

$$L_W = 1.089 \times 10^{-8} M_v (P)(V)(N) (K_N) (K_C)$$

where:

V =Tank capacity, gallon.

N =Number of turnovers per year.

K_N =Turnover factor, dimensionless, and

$$K_N = \frac{180 + N}{6N} \text{ for turnovers } > 36$$

$$K_N = 1 \text{ for turnovers } \leq 36.$$

M_V , P , and K_C as defined in paragraph (g)(3)(i)(A) of this section.

(C) The owner or operator may elect to calculate ES_{iU} in accordance with the methods described in American Petroleum Institute Publication 2518, Evaporative Loss from Fixed-Roof Tanks (incorporated by reference as specified in §63.14 of this part).

(1) The owner or operator who elects to use these alternative methods must use them for all storage vessels included in the emissions average as debit or credit generating points.

(2) The equations of paragraphs (g)(3)(i)(A) and (g)(3)(i)(B) of this section shall not be used in conjunction with the alternative methods provided under paragraph (g)(3)(i)(C) of this section.

(ii) The following procedures and equations shall be used for each fixed roof storage vessel i that is not controlled with a floating roof to calculate $ES_{iACTUAL}$:

(A) If the vessel is not controlled, $ES_{iACTUAL} = ES_{iU}$, where ES_{iU} is calculated according to the procedures in paragraph (g)(3)(i) of this section.

(B) Except as provided in paragraph (g)(3)(ii)(C) of this section, if the vessel is controlled using a control device or pollution prevention measure achieving less than 95-percent reduction,

$$ES_{iACTUAL} = ES_{iU} * \left(\frac{1 - \text{Percent reduction}}{100} \right)$$

(1) The percent reduction for a control device shall be determined through a design evaluation according to the procedures specified in §63.120(d) of this subpart.

(2) Procedures for calculating the percent reduction for pollution prevention measures are specified in paragraph (j) of this section.

(C) If the vessel is controlled according to the provisions of §63.119(e)(2) of this section whereby the control device is only required to achieve at least 90-percent reduction, the vessel shall not be considered to be generating debits.

(iii) The following equation shall be used for each internal floating roof vessel i that does not meet the specifications of §63.119(b) or (d) of this subpart to calculate $ES_{iACTUAL}$:

$$ES_{iACTUAL} = \frac{L_W + L_R + L_F + L_D}{12}$$

where:

L_W = Withdrawal loss emissions, megagrams per year, calculated according to paragraph (g)(3)(iii)(A) of this section.

L_R = Rim seal loss emissions, megagrams per year, calculated according to paragraph (g)(3)(iii)(B) of this section.

L_F =Fitting loss emissions, megagrams per year, calculated according to paragraph (g)(3)(iii)(C) of this section.

L_D =Deck seam loss emissions, megagrams per year, calculated according to paragraph (g)(3)(iii)(D) of this section.

12=Constant, months per year.

(A) Withdrawal loss emissions shall be calculated using the following equation:

$$L_W = \frac{1.018 \times 10^{-5} Q C W_L}{D} \left[1 + \left(\frac{N_c F_c}{D} \right) \right]$$

where:

Q=Throughput, gallon per year; (gallon/turnover) * (turnovers per year).

C=Shell clingage factor, barrel per 1,000 square foot, see table 23 of this subpart.

WL=Average liquid density, pound per gallon.

D=Tank diameter, feet.

N_c =Number of columns, dimensionless, see table 24 of this subpart.

F_c =Effective column diameter, feet [column perimeter (feet)+3.1416], see table 25 of this subpart.

(B) Rim seal loss emissions shall be calculated using the following equation:

$$L_R = \frac{K_s V^n P^* D M_v K_c}{2,205}$$

where:

M_v =Molecular weight of vapor in storage vessel, pound per pound-mole.

D=Tank diameter, feet.

K_c =Product factor, dimensionless; use 1.0 for organic HAP's.

K_s =Seal factor, pound-mole per [foot (miles per hour)ⁿ year], see table 26 of this subpart.

V=Average wind speed at the source, miles per hour. A value of 10 miles per hour may be assumed if source-specific data are not available.

n=Seal related wind speed exponent, dimensionless, see table 26 of this subpart.

2,205=Constant, pounds per megagram.

P^* =Vapor pressure function, dimensionless, and

$$P^* = \frac{\frac{P}{P_A}}{\left[1 + \left(1 - \frac{P}{P_A}\right)0.5\right]^2}$$

where:

P_A =Average atmospheric pressure, pounds per square inch absolute.

P =True vapor pressure at liquid storage temperature, pounds per square inch absolute.

(C) Fitting loss emissions shall be calculated using the following equation:

$$L_F = \frac{F_f P^* M_v K_c}{2,205}$$

where:

F_f =The total deck fitting loss factor, pound-mole per year, and

where:

$$F_f = \sum_{i=1}^n (N_{F_i} K_{F_i}) = \left[(N_{F_1} K_{F_1}) + (N_{F_2} K_{F_2}) + \dots + (N_{F_n} K_{F_n}) \right]$$

N_{F_i} =Number of fittings of a particular type, dimensionless. N_{F_i} is determined for the specific tank or estimated from tables 24 and 27 of this subpart.

K_{F_i} =Deck fitting loss factor for a particular type fitting, pound-mole per year. K_{F_i} is determined for each fitting type from table 27 of this subpart.

n =Number of different types of fittings, dimensionless.

P^* , M_v , K_c , and 2,205 as defined in paragraph (g)(3)(iii)(B) of this section.

(D) Deck seam loss emissions shall be calculated using the following equation:

$$L_D = \frac{K_D S_D D^2 P^* M_v K_c}{2,205}$$

where:

K_D =Deck seam loss factor, pound-mole per foot per year, and

$K_D=0.34$ for non-welded decks.

$K_D=0$ for welded decks.

S_D =Deck seam length factor, feet per square foot, see table 28 of this subpart.

D , P^* , M_v , K_c , and 2,205 as defined in paragraph (g)(3)(iii)(B) of this section.

(iv) The following equation shall be used for each external floating roof vessel i that does not meet the specifications of §63.119(c) of this subpart to calculate $ES_{iACTUAL}$:

$$ES_{iACTUAL} = \frac{L_W + L_R + L_F}{12}$$

where:

L_W =Withdrawal loss emissions, megagrams per year, calculated according to paragraph (g)(3)(iv)(A) of this section.

L_R =Rim seal loss emissions, megagrams per year, calculated according to paragraph (g)(3)(iv)(B) of this section.

L_F =Fitting loss emissions, megagrams per year, calculated according to paragraph (g)(3)(iv)(C) of this section.

12=Constant, months per year.

(A) Withdrawal loss emissions shall be calculated using the following equation:

$$L_W = \frac{4.28 * 10^{-4} Q C W_L}{D}$$

where:

Q =Throughput, gallons per year.

C =Shell clingage factor, barrel per 1,000 square foot, see table 23 of this subpart.

W_L =Average liquid density, pound per gallon.

D =Vessel diameter, feet.

(B) Rim seal loss emissions shall be calculated using the following equation:

$$L_R = \frac{K_s V^N P^* D M_v K_c}{2,205}$$

where:

K_s =Seal factor, pound-mole per [foot (miles per hour)^N year], see table 29 of this subpart.

V =Average wind speed, miles per hour, at the source. A value of 10 miles per hour may be assumed if source-specific data are not available.

N =Seal wind speed exponent, dimensionless, see table 29 of this subpart.

P^* =Vapor pressure function, dimensionless, as defined in paragraph (g)(3)(iii)(B) of this section.

D =Vessel diameter, feet.

M_v =Molecular weight of the HAP, pound per pound-mole.

K_c =Product factor, dimensionless; use 1.0 for organic HAP's.

2,205=Constant, pounds per megagram.

(C) Fitting loss emissions shall be calculated using the following equation:

$$L_F = \frac{F_F P^* M_v K_c}{2,205}$$

where:

F_F =The total deck fitting loss factor, pound-mole per year, and

$$F_F = \sum_{i=1}^n (N_{F_i} K_{F_i}) = \left[(N_{F_1} K_{F_1}) + (N_{F_2} K_{F_2}) + \dots + (N_{F_n} K_{F_n}) \right]$$

where:

N_{F_i} =Number of fittings of a particular type, dimensionless. N_{F_i} is determined for the specific tank or estimated from tables 30 through 32 of this subpart.

K_{F_i} =Deck fitting loss factor for a particular type fitting, pound-mole per year, and

$K_{F_i} = K_{F_{ai}} + K_{F_{bi}} V^{mi}$, pound-mole per year, see table 30 of this subpart for the appropriate values of $K_{F_{a}}$, $K_{F_{b}}$, and m for each fitting type.

V , P^* , M_v , K_c , and 2,205 as defined in paragraph (g)(3)(iv)(B) of this section.

(4) Emissions from transfer racks shall be calculated as follows:

(i) The following equation shall be used for each transfer rack i to calculate ETR_{iu} :

$$ETR_{iu} = (1.20 \times 10^{-7}) \frac{SPMG}{T}$$

where:

ETR_{iu} = Uncontrolled transfer HAP emission rate from transfer rack i, megagrams per month.

S = Saturation factor, dimensionless (see table 33 of this subpart).

P = Weighted average rack partial pressure of organic HAP's transferred at the rack during the month, kilopascals.

M = Weighted average molecular weight of organic HAP's transferred at the transfer rack during the month, gram per gram-mole.

G = Monthly volume of organic HAP's transferred, liters per month.

T = Weighted rack bulk liquid loading temperature during the month, Kelvin (°C + 273).

(ii) The following equation shall be used for each transfer rack i to calculate the weighted average rack partial pressure:

$$P = \frac{\sum_{j=1}^{j=n} (P_j)(G_j)}{G}$$

where:

P_j = Maximum true vapor pressure of individual organic HAP transferred at the rack, kilopascals.

G = Monthly volume of organic HAP transferred, liters per month, and

$$G = \sum_{j=1}^{j=n} G_j$$

G_j = Monthly volume of individual organic HAP transferred at the transfer rack, liters per month.

n = Number of organic HAP's transferred at the transfer rack.

(iii) The following equation shall be used for each transfer rack i to calculate the weighted average rack molecular weight:

$$M = \frac{\sum_{j=1}^{j=n} (M_j)(G_j)}{G}$$

where:

M_j = Molecular weight of individual organic HAP transferred at the rack, gram per gram-mole.

G, G_j , and n as defined in paragraph (g)(4)(ii) of this section.

(iv) The following equation shall be used for each transfer rack i to calculate the monthly weighted rack bulk liquid loading temperature:

$$T = \frac{\sum_{j=1}^{j=n} (T_j)(G_j)}{G}$$

where:

T_j = Average annual bulk temperature of individual organic HAP loaded at the transfer rack, Kelvin (°C + 273).

G, G_j , and n as defined in paragraph (g)(4)(ii) of this section.

(v) The following procedures and equations shall be used to calculate $ETR_{iACTUAL}$:

(A) If the transfer rack is not controlled, $ETR_{iACTUAL} = ETR_{iu}$, where ETR_{iu} is calculated using the equations specified in paragraphs (g)(4)(i) through (g)(4)(iv) of this section.

(B) If the transfer rack is controlled using a control device or a pollution prevention measure achieving less than the 98-percent reduction,

$$ETR_{iACTUAL} = ETR_{iu} \left(\frac{1 - \text{Percent reduction}}{100\%} \right)$$

(1) The percent reduction for a control device shall be measured according to the procedures and test methods specified in §63.128(a) of this subpart. For a flare meeting the criteria in §63.128(b) of this subpart or a boiler or process heater meeting the criteria in §63.128(c) of this subpart, the percent reduction shall be 98 percent. If testing is not feasible, percent reduction shall be determined through a design evaluation according to the procedures specified in §63.128(h) of this subpart.

(2) Procedures for calculating the percent reduction for pollution prevention measures are specified in paragraph (j) of this section.

(5) Emissions from wastewater shall be calculated as follows:

(i) The following equation shall be used for each wastewater stream i to calculate EWW_{ic} :

$$EWW_{ic} = (6.0 * 10^{-8}) Q_i H_i \sum_{m=1}^j (1 - Fr_m) Fe_m HAP_{im} \\ + (0.05) (6.0 * 10^{-8}) Q_i H_i \sum_{m=1}^j (Fr_m HAP_{im})$$

where:

EWW_{ic} = Monthly wastewater stream emission rate if wastewater stream i is controlled by the reference control technology, megagrams per month.

Q_i = Average flow rate for wastewater stream i , as determined by the procedure in §63.144(c)(3), liters per minute.

H_i = Number of hours during the month that wastewater stream i was generated, hours per month.

s = Total number of table 9 HAP in wastewater stream i .

Fr_m = Fraction removed of table 9 HAP m in wastewater, from table 9, dimensionless.

Fe_m = Fraction emitted of table 9 HAP m in wastewater, from table 34, dimensionless.

HAP_{im} = Average concentration of table 9 HAP m in wastewater stream i , parts per million by weight.

(A) HAP_{im} shall be determined for the point of determination or, at a location downstream of the point of determination and adjusted according as specified in §63.144(b)(6) of this subpart, by developing and using the sampling plan specified in §63.144(b)(5)(ii) of this subpart. The samples collected may be analyzed by any of the methods specified in §63.144(b)(5)(i)(B) through (b)(5)(i)(F) of this subpart. Concentration measurements based on Method 305 shall be adjusted by dividing each concentration by the compound-specific F_m factor listed on table 34 of this subpart. Concentration measurements other than Method 305 shall not be adjusted by the compound-specific F_m factor listed in table 34 of this subpart.

(B) Values for Q_i , HAP_{im} , and C_{im} shall be determined during a performance test conducted under representative conditions as specified in §63.145(a)(3) and (a)(4) of this subpart. The average value obtained from three test runs shall be used. The values of Q_i , HAP_{im} , and C_{im} shall be established in the Notification of Compliance Status and must be updated as provided in paragraph (g)(5)(i)(C) of this section.

(C) If there is a change to the process or operation such that the previously measured values of Q_i , HAP_{im} , and C_{im} are no longer representative, a new performance test shall be conducted to determine new representative values of Q_i , HAP_{im} , and C_{im} . These new values shall be used to calculate debits and credits from the time of the change forward, and the new values shall be reported in the next Periodic Report.

(ii) The following equation shall be used to calculate $EWW_{iACTUAL}$ for each wastewater stream i that is not managed according to the provisions for waste management units of §§63.133 through 63.137 of this subpart, as applicable, which specify equipment and work practices for suppressing and controlling vapors. Q_i , H_i , s , Fe_m , and HAP_{im} are as defined and determined according to paragraph (g)(5)(i) of this section.

$$EWW_{iACTUAL} = (6.0 \times 10^{-8}) Q_i H_i \sum_{m=1}^s Fe_m HAP_{im}$$

Where:

$EWW_{iACTUAL}$ = Monthly wastewater stream emission rate if wastewater stream i is uncontrolled or is controlled to a level less stringent than the reference control technology, megagrams per month.

(iii) The following equation shall be used to calculate $EWW_{iACTUAL}$ for each wastewater stream i that is managed according to the requirements of §§63.133 through 63.137 of this subpart, as applicable, and

wastewater stream i is uncontrolled or is controlled to a level less stringent than the reference control technology (for the purposes of the wastewater emissions averaging provisions, the term control is used to mean treatment). Q_i , H_i , s , Fe_m , and HAP_{im} are as defined and determined according to paragraph (g)(5)(i) of this section.

$$EWW_{iACTUAL} = (6.0 * 10^{-8}) Q_i H_i \sum_{m=1}^j [Fe_m HAP_{im} (1 - PR_{im})] + \left(1 - \frac{R_i}{100\%}\right) (6.0 * 10^{-8}) Q_i H_i \sum_{m=1}^j (HAP_{im} PR_{im})$$

Where:

$EWW_{iACTUAL}$ = Monthly wastewater stream emission rate if wastewater stream i is uncontrolled or is controlled to a level less stringent than the reference control technology, megagrams per month.

PR_{im} = The efficiency of the treatment process, or series of treatment processes, which treat wastewater stream i, in reducing the emission potential of table 9 HAP m in wastewater, dimensionless, as calculated by:

$$PR_{im} = \frac{HAP_{im-in} - HAP_{im-out}}{HAP_{im-in}}$$

Where:

HAP_{im-in} = Average concentration of table 9 HAP m, parts per million by weight, as defined and determined according to paragraph (g)(5)(i) of this section, in the wastewater entering the first treatment process in the series.

HAP_{im-out} = Average concentration of table 9 HAP m, parts per million by weight, as defined and determined according to paragraph (g)(5)(i) of this section, in the wastewater exiting the last treatment process in the series.

R_i = Reduction efficiency of the device used to control any vapor streams emitted and collected from wastewater stream i during treatment, dimensionless, as determined according to the procedures in §63.145(i) or (j) of this subpart.

(h) Credits are generated by the difference between emissions that are allowed for each Group 1 and Group 2 emission point and the actual emissions from a Group 1 or Group 2 emission point that has been controlled after November 15, 1990 to a level more stringent than what is required by this subpart or any other State or Federal rule or statute. Credits shall be calculated as follows:

(1) The overall equation for calculating source-wide credits is:

$$\begin{aligned}
Credits = & D \sum_{i=1}^n ((0.02) EPV1_{iM} - EPV1_{iACTUAL}) + D \sum_{i=1}^m (EPV2_{iBASE} - EPV2_{iACTUAL}) + D \sum_{i=1}^n \\
& ((0.05) ES1_{iM} - ES1_{iACTUAL}) + D \sum_{i=1}^m (ES2_{iBASE} - ES2_{iACTUAL}) + D \sum_{i=1}^n ((0.02) ETR1_{iM} - ETR1_{iACTUAL}) \\
& + D \sum_{i=1}^m (ETR2_{iBASE} - ETR2_{iACTUAL}) + D \sum_{i=1}^n (EWW1_{iC} - EWW1_{iACTUAL}) + D \sum_{i=1}^m (EWW2_{iBASE} - EWW2_{iACTUAL})
\end{aligned}$$

where:

Credits and all terms of the equation are in units of megagrams per month, the baseline date is November 15, 1990, and:

D=Discount factor=0.9 for all credit generating emission points except those controlled by a pollution prevention measure, which will not be discounted.

$EPV1_{iACTUAL}$ =Emissions for each Group 1 process vent i that is controlled to a level more stringent than the reference control technology, calculated according to paragraph (h)(2) of this section.

$(0.02) EPV1_{iU}$ =Emissions from each Group 1 process vent i if the reference control technology had been applied to the uncontrolled emissions. $EPV1_{iU}$ is calculated according to paragraph (h)(2) of this section.

$EPV2_{iACTUAL}$ =Emissions from each Group 2 process vent i that is controlled, calculated according to paragraph (h)(2) of this section.

$EPV2_{iBASE}$ =Emissions from each Group 2 process vent i at the baseline date, as calculated in paragraph (h)(2) of this section.

$ES1_{iACTUAL}$ =Emissions from each Group 1 storage vessel i that is controlled to a level more stringent than the reference control technology, calculated according to paragraph (h)(3) of this section.

$(0.05) ES1_{iU}$ =Emissions from each Group 1 storage vessel i if the reference control technology had been applied to the uncontrolled emissions. $ES1_{iU}$ is calculated according to paragraph (h)(3) of this section.

$ES2_{iACTUAL}$ =Emissions from each Group 2 storage vessel i that is controlled, calculated according to paragraph (h)(3) of this section.

$ES2_{iBASE}$ =Emissions from each Group 2 storage vessel i at the baseline date, as calculated in paragraph (h)(3) of this section.

$ETR1_{iACTUAL}$ =Emissions from each Group 1 transfer rack i that is controlled to a level more stringent than the reference control technology, calculated according to paragraph (h)(4) of this section.

$(0.02) ETR1_{iU}$ =Emissions from each Group 1 transfer rack i if the reference control technology

had been applied to the uncontrolled emissions. $ETR1_{iu}$ is calculated according to paragraph (h)(4) of this section.

$ETR2_{iACTUAL}$ = Emissions from each Group 2 transfer rack i that are controlled, calculated according to paragraph (h)(4) of this section.

$ETR2_{iBASE}$ = Emissions from each Group 2 transfer rack i at the baseline date, as calculated in paragraph (h)(4) of this section.

$EW1_{iACTUAL}$ = Emissions from each Group 1 wastewater stream i that is controlled to a level more stringent than the reference control technology, calculated according to paragraph (h)(5) of this section.

$EW1_{ic}$ = Emissions from each Group 1 wastewater stream i if the reference control technology had been applied to the uncontrolled emissions, calculated according to paragraph (h)(5) of this section.

$EW2_{iACTUAL}$ = Emissions from each Group 2 wastewater stream i that is controlled, calculated according to paragraph (h)(5) of this section.

$EW2_{iBASE}$ = Emissions from each Group 2 wastewater stream i at the baseline date, calculated according to paragraph (h)(5) of this section.

n = Number of Group 1 emission points included in the emissions average. The value of n is not necessarily the same for process vents, storage vessels, transfer racks, and wastewater.

m = Number of Group 2 emission points included in the emissions average. The value of m is not necessarily the same for process vents, storage vessels, transfer racks, and wastewater.

(i) For an emission point controlled using a reference control technology, the percent reduction for calculating credits shall be no greater than the nominal efficiency associated with the reference control technology, unless a higher nominal efficiency is assigned as specified in paragraph (h)(1)(ii) of this section.

(ii) For an emission point controlled to a level more stringent than the reference control technology, the nominal efficiency for calculating credits shall be assigned as described in paragraph (i) of this section. A reference control technology may be approved for use in a different manner and assigned a higher nominal efficiency according to the procedures in paragraph (i) of this section.

(iii) For an emission point controlled using a pollution prevention measure, the nominal efficiency for calculating credits shall be as determined as described in paragraph (j) of this section.

(2) Emissions from process vents shall be determined as follows:

(i) Uncontrolled emissions from Group 1 process vents, $EPV1_{iu}$, shall be calculated according to the procedures and equation for EPV_{iu} in paragraphs (g)(2)(i) and (g)(2)(ii) of this section.

(ii) Actual emissions from Group 1 process vents controlled using a technology with an approved nominal efficiency greater than 98 percent or a pollution prevention measure achieving greater than 98 percent emission reduction, $EPV1_{iACTUAL}$, shall be calculated according to the following equation:

$$EPV1_{iACTUAL} = EPV1_{iu} \left(1 - \frac{\text{Nominal efficiency \%}}{100\%} \right)$$

(iii) The following procedures shall be used to calculate actual emissions from Group 2 process vents, $EPV2_{iACTUAL}$:

(A) For a Group 2 process vent controlled by a control device, a recovery device applied as a pollution prevention project, or a pollution prevention measure, if the control achieves a percent reduction less than or equal to 98 percent reduction,

$$EPV2_{iACTUAL} = EPV2_{iu} \times \left(1 - \frac{\text{Percent reduction}}{100\%} \right)$$

(1) $EPV2_{iu}$ shall be calculated according to the equations and procedures for EPV_{iu} in paragraphs (g)(2)(i) and (g)(2)(ii) of this section, except as provided in paragraph (h)(2)(iii)(A)(3) of this section.

(2) The percent reduction shall be calculated according to the procedures in paragraphs (g)(2)(iii)(B)(1) through (g)(2)(iii)(B)(3) of this section, except as provided in paragraph (h)(2)(iii)(A)(4) of this section.

(3) If a recovery device was added as part of a pollution prevention project, $EPV2_{iu}$ shall be calculated prior to that recovery device. The equation for EPV_{iu} in paragraph (g)(2)(ii) of this section shall be used to calculate $EPV2_{iu}$; however, the sampling site for measurement of vent stream flow rate and organic HAP concentration shall be at the inlet of the recovery device.

(4) If a recovery device was added as part of a pollution prevention project, the percent reduction shall be demonstrated by conducting a performance test at the inlet and outlet of that recovery device.

(B) For a Group 2 process vent controlled using a technology with an approved nominal efficiency greater than 98 percent or a pollution prevention measure achieving greater than 98 percent reduction,

$$EPV2_{iACTUAL} = EPV2_{iu} \left(1 - \frac{\text{Nominal efficiency \%}}{100\%} \right)$$

(iv) Emissions from Group 2 process vents at baseline, $EPV2_{iBASE}$, shall be calculated as follows:

(A) If the process vent was uncontrolled on November 15, 1990, $EPV2_{iBASE} = EPV2_{iu}$ and shall be calculated according to the procedures and equation for EPV_{iu} in paragraphs (g)(2)(i) and (g)(2)(ii) of this section.

(B) If the process vent was controlled on November 15, 1990,

$$EPV2_{iBASE} = EPV2_{iu} \left(1 - \frac{\text{Percent reduction \%}}{100\%} \right)$$

where $EPV2_{iu}$ is calculated according to the procedures and equation for EPV_{iu} in paragraphs (g)(2)(i) and (g)(2)(ii) of this section. The percent reduction shall be calculated according to the procedures specified in paragraphs (g)(2)(iii)(B)(1) through (g)(2)(iii)(B)(3) of this section.

(C) If a recovery device was added to a process vent as part of a pollution prevention project initiated after November 15, 1990, $EPV2_{iBASE} = EPV2_{iu}$, where $EPV2_{iu}$ is calculated according to paragraph (h)(2)(iii)(A)(3) of this section.

(3) Emissions from storage vessels shall be determined as follows:

(i) Uncontrolled emissions from Group 1 storage vessels, $ES1_{iu}$, shall be calculated according to the equations and procedures for ES_{iu} in paragraph (g)(3)(i) of this section.

(ii) Actual emissions from Group 1 storage vessels controlled using a technology with an approved nominal efficiency greater than 95 percent or a pollution prevention measure achieving greater than 95 percent emission reduction, $ES1_{iACTUAL}$, shall be calculated according to the following equation:

$$ES1_{iACTUAL} = ES1_{iu} \left(1 - \frac{\text{Nominal efficiency \%}}{100\%} \right)$$

(iii) The following procedures shall be used to calculate actual emissions from Group 2 storage vessels, $ES2_{iACTUAL}$:

(A) For a Group 2 storage vessel controlled using a control device or a pollution prevention measure (other than an internal or external floating roof) achieving a percent reduction less than or equal to 95-percent reduction,

$$ES2_{iACTUAL} = ES2_{iw} \times \left(1 - \frac{\text{Percent reduction}}{100\%} \right)$$

(1) $ES2_{iw}$ is calculated according to the equations and procedures for ES_{iw} in paragraph (g)(3)(i) of this section.

(2) The percent reduction shall be calculated according to the procedures in paragraphs (g)(3)(ii)(B) (1) and (g)(3)(ii)(B) (2) of this section.

(3) If an internal or external floating roof meeting the specifications of §63.119 (b), (c), or (d) of this subpart is used to control the vessel, the percent reduction shall be 95 percent.

(B) If a Group 2 storage vessel is controlled with an internal or external floating roof not meeting the specifications of §63.119 (b), (c), or (d) of this subpart, $ES2_{iACTUAL}$ shall be calculated as specified for $ES_{iACTUAL}$ in paragraph (g)(3)(iii) or (g)(3)(iv) of this section.

(C) For a Group 2 storage vessel controlled using a technology with an approved nominal efficiency greater than 95 percent or a pollution prevention measure achieving greater than 95 percent reduction,

$$ES2_{iACTUAL} = ES2_{iw} \left(1 - \frac{\text{Nominal efficiency \%}}{100\%} \right)$$

(iv) Emissions from Group 2 storage vessels at baseline, $ES2_{iBASE}$, shall be calculated as follows:

(A) If the fixed-roof vessel was uncontrolled on November 15, 1990, $ES2_{iBASE} = ES2_{iu}$ and shall be calculated according to the procedures and equations for ES_{iu} in paragraph (g)(3)(i) of this section.

(B) If the storage vessel was controlled on November 15, 1990:

(1) The equations for $ES_{iACTUAL}$ in paragraph (g)(3)(iii) of this section shall be used to calculate $ES2_{iBASE}$ for vessels controlled with an internal floating roof that does not meet the specifications of §63.119 (b) or (d) of this subpart.

(2) The equations for $ES_{iACTUAL}$ in paragraph (g)(3)(iv) of this section shall be used to calculate

$ES2_{iBASE}$ for vessels controlled with an external floating roof that does not meet the specifications of §63.119(c) of this subpart.

(3) The following equations shall be used to calculate $ES2_{iBASE}$ for vessels controlled with a control device,

$$ES2_{iBASE} = ES2_{iu} \left(1 - \frac{\text{Percent reduction \%}}{100\%} \right)$$

where $ES2_{iu}$ shall be calculated according to the equations for ES_{iu} in paragraph (g)(3)(i) of this section. The percent reduction shall be calculated according to the procedures in paragraphs (g)(3)(ii)(B)(1) and (g)(3)(ii)(B)(2) of this section.

(4) Emissions from transfer racks shall be determined as follows:

(i) Uncontrolled emissions from Group 1 transfer racks, $ETR1_{iu}$, shall be calculated according to the procedures and equations for ETR_{iu} as described in paragraphs (g)(4)(i) through (g)(4)(iv) of this section.

(ii) Actual emissions from Group 1 transfer racks controlled using a technology with an approved nominal efficiency greater than 98 percent or a pollution prevention measure achieving greater than 98 percent emission reduction, $ETR1_{iACTUAL}$, shall be calculated according to the following equation:

$$ETR1_{iACTUAL} = ETR1_{iu} \left(1 - \frac{\text{Nominal efficiency}}{100\%} \right)$$

(iii) The following procedures shall be used to calculate actual emissions from Group 2 transfer racks, $ETR2_{iACTUAL}$:

(A) For a Group 2 transfer rack controlled by a control device or a pollution prevention measure achieving a percent reduction less than or equal to 98 percent reduction,

$$ETR2_{iACTUAL} = ETR2_{iu} \left(1 - \frac{\text{Percent reduction}}{100\%} \right)$$

(1) $ETR2_{iu}$ shall be calculated according to the equations and procedures for ETR_{iu} in paragraphs (g)(4)(i) through (g)(4)(iv) of this section.

(2) The percent reduction shall be calculated according to the procedures in paragraph (g)(4)(v)(B)(1) and (g)(4)(v)(B)(2) of this section.

(B) For a Group 2 transfer rack controlled using a technology with an approved nominal efficiency greater than 98 percent or a pollution prevention measure achieving greater than 98 percent reduction,

$$ETR2_{iACTUAL} = ETR2_{iu} \left(1 - \frac{\text{Nominal efficiency}}{100\%} \right)$$

(iv) Emissions from Group 2 transfer racks at baseline, $ETR2_{iBASE}$, shall be calculated as follows:

(A) If the transfer rack was uncontrolled on November 15, 1990, $ETR2_{iBASE} = ETR2_{iu}$ and shall be calculated according to the procedures and equations for ETR_{iu} in paragraphs (g)(4)(i) through (g)(4)(iv)

of this section.

(B) If the transfer rack was controlled on November 15, 1990,

$$ETR2_{iBASE} = ETR2_{iu} \left(1 - \frac{\text{Percent reduction}}{100\%} \right)$$

where $ETR2_{iu}$ is calculated according to the procedures and equations for ETR_{iu} in paragraphs (g)(4)(i) through (g)(4)(iv) of this section. Percent reduction shall be calculated according to the procedures in paragraphs (g)(4)(v)(B)(1) and (g)(4)(v)(B)(2) of this section.

(5) Emissions from wastewater shall be determined as follows:

(i) $EW1_{ic}$ shall be calculated according to the equation for $EW1_{ic}$ in paragraph (g)(5)(i) of this section.

(ii) $EW2_{iBASE}$ shall be calculated according to the equation for $EW2_{iACTUAL}$ in paragraph (g)(5)(ii) of this section for each Group 2 wastewater stream i , which on November 15, 1990, was not managed according to the requirements of §§63.133 through 63.137 of this subpart, as applicable.

(iii) $EW2_{iBASE}$ shall be calculated according to the equation for $EW2_{iACTUAL}$ in paragraph (g)(5)(iii) of this section for each Group 2 wastewater stream i , which on November 15, 1990, was managed according to the requirements of §§63.133 through 63.137 of this subpart, as applicable, and was uncontrolled or controlled to a level less stringent than the reference control technology.

(iv) For Group 2 wastewater streams that are managed according to the requirements of §§63.133 through 63.137 of this subpart, as applicable, $EW2_{iACTUAL}$ shall be calculated as follows:

(A) $EW2_{iACTUAL}$ shall be calculated according to the equation for $EW2_{iACTUAL}$ in paragraph (g)(5)(iii) of this section for each Group 2 wastewater stream i that is controlled to a level less stringent than, or equivalent to, the reference control technology.

(B) $EW2_{iACTUAL}$ shall be calculated according to the procedures for calculating $EW1_{iACTUAL}$ in paragraph (h)(5)(v) of this section for each Group 2 wastewater stream that is controlled to a level more stringent than the reference control technology.

(v) The following equations for $EW1_{iACTUAL}$ shall be used to calculate emissions from each Group 1 wastewater stream i that is managed according to the requirements of §§63.133 through 63.137 of this subpart, as applicable, and is controlled to a level more stringent than the reference control technology.

(A) If the Group 1 wastewater stream i is controlled using a treatment process or series of treatment processes with an approved nominal reduction efficiency in the concentration of table 9 HAP for stream i greater than that of the design steam stripper specified in §63.138(d) of this subpart, and the control device used to reduce table 9 HAP emissions from the vapor stream(s) vented from the treatment process(es) achieves a percent reduction equal to 95 percent, the following equation shall be used. All terms in this equation are as defined and determined in paragraph (g)(5) of this section.

$$EW1_{iACTUAL} = \left(6.0 \cdot 10^{-8} \right) Q_i H_i \sum_{m=1}^5 \left[Fe_{mHAP_{im}} (1 - PR_{im}) \right] \\ + 0.05 \left(6.0 \cdot 10^{-8} \right) Q_i H_i \sum_{m=1}^5 \left[HAP_{im} PR_{im} \right]$$

(B) If the Group 1 wastewater stream i is not controlled using a treatment process or series of treatment processes with a nominal reduction efficiency in the table 9 HAP concentration greater than that of the

design steam stripper specified in §63.138(d) of this subpart, but the vapor stream(s) vented from the treatment process(es) are controlled using a device with an approved nominal efficiency greater than 95 percent, the following equation shall be used. All terms other than nominal efficiency are as defined and determined in paragraph (g)(5) of this section.

$$EWW1_{ACTUAL} = (6.0 * 10^{-8}) Q_i H_i \sum_{m=1}^j [Fe_m HAP_{im} (1 - Fr_m)] \\ + \left(1 - \frac{\text{Nominal efficiency \%}}{100} \right) (6.0 * 10^{-8}) Q_i H_i \sum_{m=1}^j [HAP_{im} Fr_m]$$

(C) If the Group 1 wastewater stream i is controlled using a treatment process or series of treatment processes with an approved nominal reduction efficiency in the table 9 HAP concentration greater than that of the design steam stripper specified in §63.138(d) of this subpart, and the vapor stream(s) vented from the treatment process are controlled using a device with an approved nominal efficiency greater than 95 percent, the following equation shall be used. All terms other than nominal efficiency are as defined and determined in paragraph (g)(5) of this section.

$$EWW1_{ACTUAL} = (6.0 * 10^{-8}) Q_i H_i \sum_{m=1}^j [Fe_m HAP_{im} (1 - PR_{im})] \\ + \left(1 - \frac{\text{Nominal efficiency \%}}{100} \right) (6.0 * 10^{-8}) Q_i H_i \sum_{m=1}^j [HAP_{im} PR_{im}]$$

(i) The following procedures shall be followed to establish nominal efficiencies. The procedures in paragraphs (i)(1) through (i)(6) of this section shall be followed for control technologies that are different in use or design from the reference control technologies and achieve greater percent reductions than the percent efficiencies assigned to the reference control technologies in §63.111 of this subpart.

(1) In those cases where the owner or operator is seeking permission to take credit for use of a control technology that is different in use or design from the reference control technology, and the different control technology will be used in more than three applications at a single plant-site, the owner or operator shall submit the information specified in paragraphs (i)(1)(i) through (i)(1)(iv) of this section to the Director of the EPA Office of Air Quality Planning and Standards in writing:

(i) Emission stream characteristics of each emission point to which the control technology is or will be applied including the kind of emission point, flow, organic HAP concentration, and all other stream characteristics necessary to design the control technology or determine its performance.

(ii) Description of the control technology including design specifications.

(iii) Documentation demonstrating to the Administrator's satisfaction the control efficiency of the control technology. This may include performance test data collected using an appropriate EPA method or any other method validated according to Method 301 of appendix A of this part. If it is infeasible to obtain test data, documentation may include a design evaluation and calculations. The engineering basis of the calculation procedures and all inputs and assumptions made in the calculations shall be documented.

(iv) A description of the parameter or parameters to be monitored to ensure that the control technology will be operated in conformance with its design and an explanation of the criteria used for selection of that parameter (or parameters).

(2) The Administrator shall determine within 120 calendar days whether an application presents sufficient information to determine nominal efficiency. The Administrator reserves the right to request specific data in addition to the items listed in paragraph (i)(1) of this section.

(3) The Administrator shall determine within 120 calendar days of the submittal of sufficient data whether a control technology shall have a nominal efficiency and the level of that nominal efficiency. If, in the Administrator's judgment, the control technology achieves a level of emission reduction greater than the

reference control technology for a particular kind of emission point, the Administrator will publish a Federal Register notice establishing a nominal efficiency for the control technology.

(4) The Administrator may condition permission to take emission credits for use of the control technology on requirements that may be necessary to ensure operation and maintenance to achieve the specified nominal efficiency.

(5) In those cases where the owner or operator is seeking permission to take credit for use of a control technology that is different in use or design from the reference control technology and the different control technology will be used in no more than three applications at a single plant site, the information listed in paragraphs (i)(1)(i) through (i)(1)(iv) can be submitted to the permitting authority for the source for approval instead of the Administrator.

(i) In these instances, use and conditions for use of the control technology can be approved by the permitting authority as part of an operating permit application or modification. The permitting authority shall follow the procedures specified in paragraphs (i)(2) through (i)(4) of this section except that, in these instances, a Federal Register notice is not required to establish the nominal efficiency for the different technology.

(ii) If, in reviewing the application, the permitting authority believes the control technology has broad applicability for use by other sources, the permitting authority shall submit the information provided in the application to the Director of the EPA Office of Air Quality Planning and Standards. The Administrator shall review the technology for broad applicability and may publish a Federal Register notice; however, this review shall not affect the permitting authority's approval of the nominal efficiency of the control technology for the specific application.

(6) If, in reviewing an application for a control technology for an emission point, the Administrator or permitting authority determines the control technology is not different in use or design from the reference control technology, the Administrator or permitting authority shall deny the application.

(j) The following procedures shall be used for calculating the efficiency (percent reduction) of pollution prevention measures:

(1) A pollution prevention measure is any practice which meets the criteria of paragraphs (j)(1)(i) and (j)(1)(ii) of this section.

(i) A pollution prevention measure is any practice that results in a lesser quantity of organic HAP emissions per unit of product released to the atmosphere prior to out-of-process recycling, treatment, or control of emissions, while the same product is produced.

(ii) Pollution prevention measures may include: substitution of feedstocks that reduce HAP emissions; alterations to the production process to reduce the volume of materials released to the environment; equipment modifications; housekeeping measures; and in-process recycling that returns waste materials directly to production as raw materials. Production cutbacks do not qualify as pollution prevention.

(2) The emission reduction efficiency of pollution prevention measures implemented after November 15, 1990, can be used in calculating the actual emissions from an emission point in the debit and credit equations in paragraphs (g) and (h) of this section. When the term "organic HAP" is used in §63.150(j)(2) in reference to wastewater emission points, the term "table 9 HAP" shall apply for the purposes of this paragraph.

(i) For pollution prevention measures, the percent reduction used in the equations in paragraphs (g)(2) through (g)(5) of this section and paragraphs (h)(2) through (h)(5) of this section is the percent difference between the monthly organic HAP emissions for each emission point after the pollution prevention measure for the most recent month versus monthly emissions from the same emission point before the pollution prevention measure, adjusted by the volume of product produced during the two monthly periods.

(ii) The following equation shall be used to calculate the percent reduction of a pollution prevention measure for each emission point.

$$\text{Percent reduction} = \frac{E_B - \frac{(E_{PP} \times P_B)}{P_{PP}}}{E_B} \times 100\%$$

where:

Percent reduction=Efficiency of pollution prevention measure (percent organic HAP reduction).

E_B = Monthly emissions before the pollution prevention measure, megagrams per month, determined as specified in paragraphs (j)(2)(ii)(A), (j)(2)(ii)(B), and (j)(2)(ii)(C) of this section.

E_{pp} = Monthly emissions after the pollution prevention measure, megagrams per month, as determined for the most recent month, determined as specified in paragraphs (j)(2)(ii)(D) or (j)(2)(ii)(E) of this section.

P_B = Monthly production before the pollution prevention measure, megagrams per month, during the same period over which E_B is calculated.

P_{pp} = Monthly production after the pollution prevention measure, megagrams per month, as determined for the most recent month.

(A) The monthly emissions before the pollution prevention measure, E_B , shall be determined in a manner consistent with the equations and procedures in paragraphs (g)(2), (g)(3), and (g)(4) of this section for process vents, storage vessels, and transfer operations.

(B) For wastewater, E_B shall be calculated as follows:

$$E_B = \sum_{i=1}^n \left[(6.0 \times 10^{-8}) Q_{Bi} H_{Bi} \sum_{m=1}^s Fe_m HAP_{Bim} \right]$$

Where:

n = Number of wastewater streams.

Q_{Bi} = Average flow rate for wastewater stream i before the pollution prevention measure, defined and determined according to paragraph (g)(5)(i) of this section, liters per minute, before implementation of the pollution prevention measure.

H_{Bi} = Number of hours per month that wastewater stream i was discharged before the pollution prevention measure, hours per month.

s = Total number of table 9 HAP in wastewater stream i .

Fe_m = Fraction emitted of table 9 HAP m in wastewater of this subpart, dimensionless.

HAP_{Bim} = Average concentration of table 9 HAP m in wastewater stream i , defined and determined according to paragraph (g)(5)(i) of this section, before the pollution prevention measure, parts per million by weight, as measured before the implementation of the pollution

measure.

(C) If the pollution prevention measure was implemented prior to April 22, 1994, records may be used to determine E_B .

(D) The monthly emissions after the pollution prevention measure, E_{pp} , may be determined during a performance test or by a design evaluation and documented engineering calculations. Once an emissions-to-production ratio has been established, the ratio can be used to estimate monthly emissions from monthly production records.

(E) For wastewater, E_{pp} shall be calculated using the following equation:

$$E_{pp} = \sum_{i=1}^n \left[(6.0 * 10^{-8}) Q_{ppi} H_{ppi} \sum_{m=1}^s Fe_m HAP_{ppim} \right]$$

where n , Q_{ppi} , H_{ppi} , s , Fe_m , and HAP_{ppim} are defined and determined as described in paragraph (j)(2)(ii)(B) of this section except that Q_{ppi} , H_{ppi} , and HAP_{ppim} shall be determined after the pollution prevention measure has been implemented.

(iii) All equations, calculations, test procedures, test results, and other information used to determine the percent reduction achieved by a pollution prevention measure for each emission point shall be fully documented.

(iv) The same pollution prevention measure may reduce emissions from multiple emission points. In such cases, the percent reduction in emissions for each emission point must be calculated.

(v) For the purposes of the equations in paragraphs (h)(2) through (h)(5) of this section, used to calculate credits for emission points controlled more stringently than the reference control technology, the nominal efficiency of a pollution prevention measure is equivalent to the percent reduction of the pollution prevention measure. When a pollution prevention measure is used, the owner or operator of a source is not required to apply to the Administrator for a nominal efficiency and is not subject to paragraph (i) of this section.

(k) The owner or operator must demonstrate that the emissions from the emission points proposed to be included in the average will not result in greater hazard or, at the option of the operating permit authority, greater risk to human health or the environment than if the emission points were controlled according to the provisions in §§63.113 through 63.148.

(1) This demonstration of hazard or risk equivalency shall be made to the satisfaction of the operating permit authority.

(i) The Administrator may require owners and operators to use specific methodologies and procedures for making a hazard or risk determination.

(ii) The demonstration and approval of hazard or risk equivalency shall be made according to any guidance that the Administrator makes available for use.

(2) Owners and operators shall provide documentation demonstrating the hazard or risk equivalency of their proposed emissions average in their operating permit application or in their Implementation Plan if an operating permit application has not yet been submitted.

(3) An emissions averaging plan that does not demonstrate hazard or risk equivalency to the satisfaction of the Administrator shall not be approved. The Administrator may require such adjustments to the emissions averaging plan as are necessary in order to ensure that the average will not result in greater hazard or risk to human health or the environment than would result if the emission points were controlled according to §§63.113 through 63.148 of this subpart.

(4) A hazard or risk equivalency demonstration must:

- (i) Be a quantitative, bona fide chemical hazard or risk assessment;
- (ii) Account for differences in chemical hazard or risk to human health or the environment; and
- (iii) Meet any requirements set by the Administrator for such demonstrations.

(l) For periods of excursions, an owner or operator may request that the provisions of paragraphs (l)(1) through (l)(4) of this section be followed instead of the procedures in paragraphs (f)(3)(i) and (f)(3)(ii) of this section.

(1) The owner or operator shall notify the Administrator of excursions in the Periodic Reports as required in §63.152 of this subpart.

(2) The owner or operator shall demonstrate that other types of monitoring data or engineering calculations are appropriate to establish that the control device for the emission point was operating in such a fashion to warrant assigning full or partial credits and debits. This demonstration shall be made to the Administrator's satisfaction, and the Administrator may establish procedures of demonstrating compliance that are acceptable.

(3) The owner or operator shall provide documentation of the excursion and the other type of monitoring data or engineering calculations to be used to demonstrate that the control device for the emission point was operating in such a fashion to warrant assigning full or partial credits and debits.

(4) The Administrator may assign full or partial credit and debits upon review of the information provided.

(m) For each Group 1 or Group 2 emission point included in an emissions average, the owner or operator shall perform testing, monitoring, recordkeeping, and reporting equivalent to that required for Group 1 emission points complying with §§63.113 through 63.148 of this subpart. The specific requirements for process vents, storage vessels, transfer racks, and wastewater are identified in paragraphs (m)(1) through (m)(6) of this section.

(1) The source shall implement the following testing, monitoring, recordkeeping, and reporting procedures for each process vent equipped with a flare, incinerator, boiler, or process heater.

(i) Determine, consistent with paragraph (g)(2)(i) of this section, whether the process vent is Group 1 or Group 2 according to the procedures in §63.115.

(ii) Conduct initial performance tests to determine percent reduction as specified in §63.116 of this subpart;

(iii) Monitor the operating parameters, keep records, and submit reports specified in §63.114, §63.117(a), and §63.118(a), (f), and (g) of this subpart, as appropriate for the specific control device.

(2) The source shall implement the following procedures for each process vent equipped with a carbon adsorber, absorber, or condenser but not equipped with a control device:

(i) Determine, consistent with paragraph (g)(2)(i) of this section, the flow rate, organic HAP concentration, and TRE index value using the methods specified in §63.115;

(ii) Monitor the operating parameters, keep records, and submit reports specified in §63.114, §63.117(a), and §63.118(b), (f), and (g) of this subpart, as appropriate for the specific recovery device.

(3) The source shall implement the following procedures for each storage vessel controlled with an internal floating roof, external roof, or a closed vent system with a control device, as appropriate to the control technique:

(i) Perform the monitoring or inspection procedures in §63.120 of this subpart,

- (ii) Perform the reporting and recordkeeping procedures in §§63.122 and 63.123 of this subpart, and
 - (iii) For closed vent systems with control devices, conduct an initial design evaluation and submit an operating plan as specified in §63.120(d) and §63.122(a)(2) and (b) of this subpart.
- (4) The source shall implement the following procedures for each transfer rack controlled with a vapor balancing system, or a vapor collection system and an incinerator, flare, boiler, process heater, adsorber, condenser, or absorber, as appropriate to the control technique:
- (i) The monitoring and inspection procedures in §63.127 of this subpart,
 - (ii) The testing and compliance procedures in §63.128 of this subpart, and
 - (iii) The reporting and recordkeeping procedures in §63.129 and §63.130 of this subpart.
- (5) The source shall implement the following procedures for wastewater emission points, as appropriate to the control techniques:
- (i) For wastewater treatment processes, conduct tests as specified in §63.138(j) of this subpart.
 - (ii) Conduct inspections and monitoring as specified in §63.143 of this subpart.
 - (iii) A recordkeeping program as specified in §63.147 of this subpart.
 - (iv) A reporting program as specified in §63.146 of this subpart.
- (6) If an emission point in an emissions average is controlled using a pollution prevention measure or a device or technique for which no monitoring parameters or inspection procedures are specified in §63.114, §63.120, §63.127, or §63.143 of this subpart, the owner or operator shall submit the information specified in §63.151(f) of this subpart in the Implementation Plan or operating permit application.
- (n) Records of all information required to calculate emission debits and credits shall be retained for five years.
- (o) Initial Notifications, Implementation Plans, Notifications of Compliance Status, Periodic Reports, and other reports shall be submitted as required by §63.151 and §63.152 of this subpart.

[59 FR 19468, Apr. 22, 1994, as amended at 60 FR 63628, Dec. 12, 1995; 64 FR 20192, Apr. 26, 1999; 66 FR 6934, Jan. 22, 2001]

§ 63.151 Initial notification.

(a) Each owner or operator of a source subject to this subpart shall submit the reports listed in paragraphs (a)(1) through (a)(5) of this section. Owners or operators requesting an extension of compliance shall also submit the report listed in paragraph (a)(6) of this section.

- (1) An Initial Notification described in paragraph (b) of this section, and
- (2) An Implementation Plan for new sources subject to this subpart or for emission points to be included in an emissions average, unless an operating permit application has been submitted prior to the date the Implementation Plan is due and the owner or operator has elected to include the information specified in §63.152(e) in that application. The submittal date and contents of the Implementation Plan are specified in paragraphs (c) and (d) of this section.
- (3) A Notification of Compliance Status described in §63.152 of this subpart,
- (4) Periodic Reports described in §63.152 of this subpart, and

(5) Other reports described in §63.152 of this subpart.

(6) Pursuant to section 112(i)(3)(B) of the Act, an owner or operator may request an extension allowing the existing source up to 1 additional year to comply with section 112(d) standards.

(i) For purposes of this subpart, a request for an extension shall be submitted to the permitting authority as part of the operating permit application or as part of the Initial Notification or as a separate submittal. Requests for extensions shall be submitted no later than 120 days prior to the compliance dates specified in §63.100(k)(2), §63.100(l)(4), and §63.100(m) of subpart F of this part, except as provided for in paragraph (a)(6)(iv) of this section. The dates specified in §63.6(i) of subpart A of this part for submittal of requests for extensions shall not apply to sources subject to this subpart G.

(ii) A request for an extension of compliance must include the data described in §63.6(i)(6)(i) (A), (B), and (D) of subpart A of this part.

(iii) The requirements in §63.6(i)(8) through (i)(14) of subpart A will govern the review and approval of requests for extensions of compliance with this subpart.

(iv) An owner or operator may submit a compliance extension request after the date specified in paragraph (a)(6)(i) of this section provided the need for the compliance extension arose after that date and before the otherwise applicable compliance date, and the need arose due to circumstances beyond reasonable control of the owner or operator. This request shall include, in addition to the information in paragraph (a)(6)(ii) of this section, a statement of the reasons additional time is needed and the date when the owner or operator first learned of the problem.

(7) The reporting requirements for storage vessels are located in §63.122 of this subpart.

(b) Each owner or operator of an existing or new source subject to subpart G shall submit a written Initial Notification to the Administrator, containing the information described in paragraph (b)(1) of this section, according to the schedule in paragraph (b)(2) of this section. The Initial Notification provisions in §63.9 (b)(2), (b)(3), and (b)(6) of subpart A shall not apply to owners or operators of sources subject to subpart G.

(1) The Initial Notification shall include the following information:

(i) The name and address of the owner or operator;

(ii) The address (physical location) of the affected source;

(iii) An identification of the kinds of emission points within the source that are subject to this subpart;

(iv) An identification of the chemical manufacturing processes subject to subpart G; and

(v) A statement of whether the source can achieve compliance by the relevant compliance date specified in §63.100 of subpart F.

(2) The Initial Notification shall be submitted according to the schedule in paragraph (b)(2)(i), (b)(2)(ii), or (b)(2)(iii) of this section, as applicable.

(i) For an existing source, the Initial Notification shall be submitted within 120 calendar days after the date of promulgation.

(ii) For a new source that has an initial start-up 90 calendar days after the date of promulgation of this subpart or later, the application for approval of construction or reconstruction required by §63.5(d) of subpart A shall be submitted in lieu of the Initial Notification. The application shall be submitted as soon as practicable before construction or reconstruction is planned to commence (but it need not be sooner than 90 calendar days after the date of promulgation of this subpart).

(iii) For a new source that has an initial start-up prior to 90 calendar days after the date of promulgation,

the Initial Notification shall be submitted within 90 calendar days after the date of promulgation of this subpart. The application for approval of construction or reconstruction described in §63.5(d) of subpart A is not required for these sources.

(c) Each owner or operator of an existing source with emission points that will be included in an emissions average or new source subject to this subpart must submit an Implementation Plan to the Administrator by the dates specified in paragraphs (c)(1) and (c)(2) of this section, unless an operating permit application accompanied by the information specified in §63.152(e) of this subpart has been submitted. The Implementation Plan for emissions averaging is subject to Administrator approval.

(1) Each owner or operator of an existing source subject to this subpart who elects to comply with §63.112 of this subpart by using emissions averaging for any emission points, and who has not submitted an operating permit application accompanied by the information specified in §63.152(e) of this subpart at least 18 months prior to the compliance dates specified in §63.100 of subpart F of this part, shall develop an Implementation Plan for emissions averaging. For existing sources, the Implementation Plan for those emission points to be included in an emissions average shall be submitted no later than 18 months prior to the compliance dates in §63.100 of subpart F of this part.

(2) Each owner or operator of a new source shall submit an Implementation Plan by the date specified in paragraphs (c)(2)(i) or (c)(2)(ii) of this section, as applicable, unless an operating permit application containing the information in paragraph (e) of this section has been submitted by that date.

(i) For a new source that has an initial start-up 90 calendar days after the date of promulgation of this subpart or later, the Implementation Plan shall be submitted with the application for approval of construction or reconstruction by the date specified in paragraph (b)(2)(ii) of this section.

(ii) For a new source that has an initial start-up prior to 90 calendar days after the date of promulgation, the Implementation Plan shall be submitted within 90 calendar days after the date of promulgation of this subpart.

(3) The Administrator shall determine within 120 calendar days whether the Implementation Plan submitted by sources using emissions averaging presents sufficient information. The Administrator shall either approve the Implementation Plan, request changes, or request that the owner or operator submit additional information. Once the Administrator receives sufficient information, the Administrator shall approve, disapprove, or request changes to the plan within 120 calendar days.

(d) Each owner or operator required to submit an Implementation Plan for emissions averaging shall include in the plan, for all emission points included in the emissions average, the information listed in paragraphs (d)(1) through (d)(8) of this section.

(1) The identification of all emission points in the planned emissions average and notation of whether each point is a Group 1 or Group 2 emission point as defined in §63.111 of this subpart.

(2) The projected emission debits and credits for each emission point and the sum for the emission points involved in the average calculated according to §63.150 of this subpart. The projected credits must be greater than the projected debits, as required under §63.150(e)(3) of this subpart.

(3) The specific control technology or pollution prevention measure that will be used for each emission point included in the average and date of application or expected date of application.

(4) The specific identification of each emission point affected by a pollution prevention measure. To be considered a pollution prevention measure, the criteria in §63.150(j)(1) of this subpart must be met. If the same pollution prevention measure reduces or eliminates emissions from multiple emission points in the average, the owner or operator must identify each of these emission points.

(5) A statement that the compliance demonstration, monitoring, inspection, recordkeeping, and reporting provisions in §63.150(m), (n), and (o) of this subpart that are applicable to each emission point in the emissions average will be implemented beginning on the date of compliance.

(6) Documentation of the information listed in paragraph (d)(6)(i) through (d)(6)(v) of this section for each process vent, storage vessel, or transfer rack included in the average.

(i) The values of the parameters used to determine whether the emission point is Group 1 or Group 2. Where TRE index value is used for process vent group determination, the estimated or measured values of the parameters used in the TRE equation in §63.115(d) of this subpart (flow rate, organic HAP emission rate, TOC emission rate, and net heating value) and the resulting TRE index value shall be submitted.

(ii) The estimated values of all parameters needed for input to the emission debit and credit calculations in §63.150 (g) and (h) of this subpart. These parameter values, or as appropriate, limited ranges for the parameter values, shall be specified in the source's Implementation Plan (or operating permit) as enforceable operating conditions. Changes to these parameters must be reported as required by paragraph (i)(2)(ii) of this section.

(iii) The estimated percent reduction if a control technology achieving a lower percent reduction than the efficiency of the reference control technology, as defined in §63.111 of this subpart, is or will be applied to the emission point.

(iv) The anticipated nominal efficiency if a control technology achieving a greater percent emission reduction than the efficiency of the reference control technology is or will be applied to the emission point. The procedures in §63.150(i) of this subpart shall be followed to apply for a nominal efficiency.

(v) The operating plan required in §63.122(a)(2) and (b) of this subpart for each storage vessel controlled with a closed-vent system with a control device other than a flare.

(7) The information specified in §63.151(f) of this subpart shall be included in the Implementation Plan for:

(i) Each process vent or transfer rack controlled by a pollution prevention measure or control technique for which monitoring parameters or inspection procedures are not specified in §63.114, §63.126(b)(3), or §63.127 of this subpart, and

(ii) Each storage vessel controlled by pollution prevention or a control technique other than an internal or external floating roof or a closed vent system with a control device.

(8) Documentation of the information listed in paragraph (d)(8)(i) through (d)(8)(iv) for each process wastewater stream included in the average.

(i) The information used to determine whether the wastewater stream is a Group 1 or Group 2 wastewater stream.

(ii) The estimated values of all parameters needed for input to the wastewater emission credit and debit calculations in §63.150 (g)(5) and (h)(5) of this subpart.

(iii) The estimated percent reduction if:

(A) A control technology that achieves an emission reduction less than or equal to the emission reduction achieved by the design steam stripper, as specified in §63.138(g) of this subpart, is or will be applied to the wastewater stream, or

(B) A control technology achieving less than or equal to 95 percent emission reduction is or will be applied to the vapor stream(s) vented and collected from the treatment processes, or

(C) A pollution prevention measure is or will be applied.

(iv) The anticipated nominal efficiency if the owner or operator plans to apply for a nominal efficiency under §63.150(i) of this subpart. A nominal efficiency shall be applied for if:

(A) A control technology is or will be applied to the wastewater stream and achieves an emission reduction greater than the emission reduction achieved by the design steam stripper as specified in §63.138(g) of this subpart, or

(B) A control technology achieving greater than 95 percent emission reduction is or will be applied to the vapor stream(s) vented and collected from the treatment processes.

(v) For each pollution prevention measure, treatment process, or control device used to reduce air emissions of organic HAP's from wastewater and for which no monitoring parameters or inspection procedures are specified in §63.143 of this subpart, the information specified in §63.151(f) of this subpart shall be included in the Implementation Plan.

(e) An owner or operator expressly referred to this paragraph shall report, in an Implementation Plan, operating permit application, or as otherwise specified by the permitting authority, the information listed in paragraphs (e)(1) through (e)(5) of this section.

(1) A list designating each emission point complying with §§63.113 through 63.149 and whether each emission point is Group 1 or Group 2, as defined in §63.111. For each process vent within the source, provide the information listed in paragraphs (e)(1)(i) through (iv) of this section.

(i) The chemical manufacturing process unit(s) that is the origin of all or part of the vent stream that exits the process vent.

(ii) The type(s) of unit operations (*i.e.*, an air oxidation reactor, distillation unit, or reactor) that creates the vent stream that exits the process vent.

(iii) For a Group 2 process vent, the last recovery device, if any.

(iv) For a Group 1 process vent, the control device, or other equipment used for compliance.

(2) The control technology or method of compliance that will be applied to each Group 1 emission point.

(3) A statement that the compliance demonstration, monitoring, inspection, recordkeeping, and reporting provisions in §§63.113 through 63.149 of this subpart that are applicable to each emission point will be implemented beginning on the date of compliance.

(4) The operating plan required in §63.122(a)(2) and (b) of this subpart for each storage vessel controlled with a closed vent system with a control device other than a flare.

(5) The monitoring information in §63.151(f) of this subpart if, for any emission point, the owner or operator of a source seeks to comply through use of a control technique other than those for which monitoring parameters are specified in §63.114 for process vents, §63.127 for transfer, and §63.143 for process wastewater.

(f) The owner or operator who has been directed by any section of this subpart that expressly references this paragraph to set unique monitoring parameters or who requests approval to monitor a different parameter than those listed in §63.114 for process vents, §63.127 for transfer, or §63.143 for process wastewater of this subpart shall submit the information specified in paragraphs (f)(1), (f)(2), and (f)(3) of this section with the operating permit application or as otherwise specified by the permitting authority.

(1) A description of the parameter(s) to be monitored to ensure the control technology or pollution prevention measure is operated in conformance with its design and achieves the specified emission limit, percent reduction, or nominal efficiency, and an explanation of the criteria used to select the parameter(s).

(2) A description of the methods and procedures that will be used to demonstrate that the parameter indicates proper operation of the control device, the schedule for this demonstration, and a statement that the owner or operator will establish a range for the monitored parameter as part of the Notification of Compliance Status report required in §63.152(b) of this subpart, unless this information has already been included in the operating permit application.

(3) The frequency and content of monitoring, recording, and reporting if monitoring and recording is not continuous, or if reports of daily average values when the monitored parameter value is outside the range established in the operating permit or Notification of Compliance Status will not be included in

Periodic Reports required under §63.152(c) of this subpart. The rationale for the proposed monitoring, recording, and reporting system shall be included.

(g) An owner or operator may request approval to use alternatives to the continuous operating parameter monitoring and recordkeeping provisions listed in §§63.114, 63.117, and 63.118 for process vents, §§63.127, 63.129, and 63.130 for transfer operations, and §§63.143, 63.146, and 63.147 for wastewater.

(1) Requests shall be included in the operating permit application or as otherwise specified by the permitting authority and shall contain the information specified in paragraphs (g)(3) through (g)(5) of this section, as applicable.

(2) The provisions in §63.8(f)(5)(i) of subpart A shall govern the review and approval of requests.

(3) An owner or operator of a source that does not have an automated monitoring and recording system capable of measuring parameter values at least once every 15 minutes and generating continuous records may request approval to use a non-automated system with less frequent monitoring.

(i) The requested system shall include manual reading and recording of the value of the relevant operating parameter no less frequently than once per hour. Daily average values shall be calculated from these hourly values and recorded.

(ii) The request shall contain:

(A) A description of the planned monitoring and recordkeeping system;

(B) Documentation that the source does not have an automated monitoring and recording system;

(C) Justification for requesting an alternative monitoring and recordkeeping system; and

(D) Demonstration to the Administrator's satisfaction that the proposed monitoring frequency is sufficient to represent control device operating conditions considering typical variability of the specific process and control device operating parameter being monitored.

(4) An owner or operator may request approval to use an automated data compression recording system that does not record monitored operating parameter values at a set frequency (for example once every 15 minutes) but records all values that meet set criteria for variation from previously recorded values.

(i) The requested system shall be designed to:

(A) Measure the operating parameter value at least once every 15 minutes.

(B) Record at least four values each hour during periods of operation.

(C) Record the date and time when monitors are turned off or on.

(D) Recognize unchanging data that may indicate the monitor is not functioning properly, alert the operator, and record the incident.

(E) Compute daily average values of the monitored operating parameter based on recorded data.

(F) If the daily average is not an excursion, as defined in §63.152(c)(2)(ii), the data for that operating day may be converted to hourly average values and the four or more individual records for each hour in the operating day may be discarded.

(ii) The request shall contain a description of the monitoring system and data compression recording system, including the criteria used to determine which monitored values are recorded and retained, the method for calculating daily averages, and a demonstration that the system meets all criteria in

paragraph (g)(4)(i) of this section.

(5) An owner or operator may request approval to use other alternative monitoring systems according to the procedures specified in §63.8(f) of subpart A of this part.

(h) The owner or operator required to prepare an Implementation Plan, or otherwise required to submit a report, under paragraph (c), (d), or (e) of this section shall also submit a supplement for any additional alternative controls or operating scenarios that may be used to achieve compliance.

(i) The owner or operator of a source required to submit an Implementation Plan for emissions averaging under paragraphs (c) and (d) of this section shall also submit written updates of the Implementation Plan to the Administrator for approval under the circumstances described in paragraphs (i)(1) and (i)(2) of this section unless the relevant information has been included and submitted in an operating permit application or amendment.

(1) The owner or operator who plans to make a change listed in paragraph (i)(1)(i) or (i)(1)(ii) of this section shall submit an Implementation Plan update at least 120 calendar days prior to making the change.

(i) Whenever an owner or operator elects to achieve compliance with the emissions averaging provisions in §63.150 of this subpart by using a control technique other than that specified in the Implementation Plan or plans to monitor a different parameter or operate a control device in a manner other than that specified in the Implementation Plan.

(ii) Whenever an emission point or a chemical manufacturing process unit is added to an existing source and is planned to be included in an emissions average, or whenever an emission point not included in the emissions average described in the Implementation Plan is to be added to an emissions average. The information in paragraph (d) of this section shall be updated to include the additional emission point.

(2) The owner or operator who has made a change listed in paragraph (i)(2)(i) or (i)(2)(ii) of this section shall submit an Implementation Plan update within 90 calendar days after the information regarding the change is known to the source. The update may be submitted in the next quarterly Periodic Report if the change is made after the date the Notification of Compliance status is due.

(i) Whenever a process change is made such that the group status of any emission point in an emissions average changes.

(ii) Whenever a value of a parameter in the emission credit or debit equations in §63.150(g) or (h) changes such that it is outside the range specified in the Implementation Plan and causes a decrease in the projected credits or an increase in the projected debits.

(3) The Administrator shall approve or request changes to the Implementation Plan update within 120 calendar days of receipt of sufficient information regarding the change for emission points included in emissions averages.

(j) The owner or operator of a source subject to this subpart, for emission points that are not included in an emissions average, shall report to the Administrator under the circumstances described in paragraphs (j)(1), (j)(2), and (j)(3) of this section unless the relevant information has been included and submitted in an operating permit application or amendment, or as otherwise specified by the permitting authority. The information shall be submitted within 180 calendar days after the change is made or the information regarding the change is known to the source. The update may be submitted in the next Periodic Report if the change is made after the date the Notification of Compliance Status is due.

(1) Whenever a deliberate change is made such that the group status of any emission point changes. The information submitted shall include a compliance schedule as specified in §63.100 of subpart F of this part if the emission point becomes Group 1.

(2) Whenever an owner or operator elects to achieve compliance with this subpart by using a control technique other than that previously reported to the Administrator or to the permitting authority, or plans to monitor a different parameter, or operate a control device in a manner other than that previously reported.

(3) Whenever an emission point or a chemical manufacturing process unit is added to a source, written information specified under paragraphs (e)(1) through (e)(5) of this section, containing information on the new emission point(s) shall be submitted to the EPA regional office where the source is located.

[59 FR 19468, Apr. 22, 1994, as amended at 60 FR 63628, Dec. 12, 1995; 61 FR 7718, Feb. 29, 1996; 61 FR 64576, Dec. 5, 1996; 64 FR 20195, Apr. 26, 1999; 66 FR 6934, Jan. 22, 2001]

§ 63.152 General reporting and continuous records.

(a) The owner or operator of a source subject to this subpart shall submit the reports listed in paragraphs (a)(1) through (a)(5) of this section and keep continuous records of monitored parameters as specified in paragraph (f) of this section. Owners or operators requesting an extension of compliance shall also submit the report described in §63.151(a)(6) of this subpart.

(1) An Initial Notification described in §63.151(b) of this subpart.

(2) An Implementation Plan described in §63.151(c), (d), and (e) of this subpart for existing sources with emission points that are included in an emissions average or for new sources.

(3) A Notification of Compliance Status described in paragraph (b) of this section.

(4) Periodic Reports described in paragraph (c) of this section.

(5) Other reports described in paragraphs (d) and (e) of this section.

(b) Each owner or operator of a source subject to this subpart shall submit a Notification of Compliance Status within 150 calendar days after the compliance dates specified in §63.100 of subpart F of this part.

(1) The notification shall include the results of any emission point group determinations, performance tests, inspections, continuous monitoring system performance evaluations, values of monitored parameters established during performance tests, and any other information used to demonstrate compliance or required to be included in the Notification of Compliance Status under §63.110 (h) for regulatory overlaps, under §63.117 for process vents, §63.122 for storage vessels, §63.129 for transfer operations, §63.146 for process wastewater, and §63.150 for emission points included in an emissions average.

(i) For performance tests and group determinations that are based on measurements, the Notification of Compliance Status shall include one complete test report for each test method used for a particular kind of emission point. For additional tests performed for the same kind of emission point using the same method, the results and any other information required in §63.117 for process vents, §63.129 for transfer, and §63.146 for process wastewater shall be submitted, but a complete test report is not required.

(ii) A complete test report shall include a brief process description, sampling site description, description of sampling and analysis procedures and any modifications to standard procedures, quality assurance procedures, record of operating conditions during the test, record of preparation of standards, record of calibrations, raw data sheets for field sampling, raw data sheets for field and laboratory analyses, documentation of calculations, and any other information required by the test method.

(2) For each monitored parameter for which a range is required to be established under §63.114 for process vents, §63.127 for transfer, §63.143 for process wastewater, §63.150(m) for emission points in emissions averages, or §63.151(f), or §63.152(e), the Notification of Compliance Status shall include the information in paragraphs (b)(2)(i), (b)(2)(ii), and (b)(2)(iii) of this section, unless the range and the operating day definition have been established in the operating permit. The recordkeeping and reporting requirements applicable to storage vessels are located in §§63.122 and 63.123.

(i) The specific range of the monitored parameter(s) for each emission point;

(ii) The rationale for the specific range for each parameter for each emission point, including any data and calculations used to develop the range and a description of why the range indicates proper

operation of the control device.

(A) If a performance test is required by this subpart for a control device, the range shall be based on the parameter values measured during the performance test and may be supplemented by engineering assessments and/or manufacturer's recommendations. Performance testing is not required to be conducted over the entire range of permitted parameter values.

(B) If a performance test is not required by this subpart for a control device, the range may be based solely on engineering assessments and/or manufacturer's recommendations.

(iii) A definition of the source's operating day for purposes of determining daily average values of monitored parameters. The definition shall specify the times at which an operating day begins and ends.

(3) For emission points included in an emissions average, the Notification of Compliance Status shall include the values of all parameters needed for input to the emission credit and debit equations in §63.150 (g) and (h), calculated or measured according to the procedures in §63.150 (g) and (h) of this subpart, and the resulting calculation of credits and debits for the first quarter of the year. The first quarter begins on the compliance date specified in §63.100 of subpart F.

(4) If any emission point is subject to this subpart and to other standards as specified in §63.110 of this subpart and if the provisions of §63.110 of this subpart allow the owner or operator to choose which testing, monitoring, reporting, and recordkeeping provisions will be followed, then the Notification of Compliance Status shall indicate which rule's requirements will be followed for testing, monitoring, reporting, and recordkeeping.

(5) An owner or operator who transfers a Group 1 wastewater stream or residual removed from a Group 1 wastewater stream for treatment pursuant to §63.132(g) shall include in the Notification of Compliance Status the name and location of the transferee and a description of the Group 1 wastewater stream or residual sent to the treatment facility.

(6) An owner or operator complying with §63.113(i) shall include in the Notification of Compliance Status, or where applicable, a supplement to the Notification of Compliance Status, the name and location of the transferee, and the identification of the Group 1 process vent.

(c) The owner or operator of a source subject to this subpart shall submit Periodic Reports.

(1) Except as specified under paragraphs (c)(5) and (c)(6) of this section, a report containing the information in paragraphs (c)(2), (c)(3), and (c)(4) of this section shall be submitted semiannually no later than 60 calendar days after the end of each 6-month period. The first report shall be submitted no later than 8 months after the date the Notification of Compliance Status is due and shall cover the 6-month period beginning on the date the Notification of Compliance Status is due.

(2) Except as provided in paragraph (c)(2)(iv) of this section, for an owner or operator of a source complying with the provisions of §§63.113 through 63.147 for any emission points, Periodic Reports shall include all information specified in §§63.117 and 63.118 for process vents, §63.122 for storage vessels, §§63.129 and 63.130 for transfer operations, and §63.146 for process wastewater, including reports of periods when monitored parameters are outside their established ranges.

(i) For each parameter or parameters required to be monitored for a control device, the owner or operator shall establish a range of parameter values to ensure that the device is being applied, operated and maintained properly. As specified in paragraph (b)(2) of this section, these parameter values and the definition of an operating day shall be approved as part of and incorporated into the source's Notification of Compliance Status or operating permit, as appropriate.

(ii) The parameter monitoring data for Group 1 emission points and emission points included in emissions averages that are required to perform continuous monitoring shall be used to determine compliance with the required operating conditions for the monitored control devices or recovery devices. For each excursion, except for excused excursions, the owner or operator shall be deemed to have failed to have applied the control in a manner that achieves the required operating conditions.

(A) An excursion means any of the three cases listed in paragraph (c)(2)(ii)(A)(1), (c)(2)(ii)(A)(2), or (c)

(2)(ii)(A)(3) of this section. For a control device or recovery device where multiple parameters are monitored, if one or more of the parameters meets the excursion criteria in paragraph (c)(2)(ii)(A)(1), (c)(2)(ii)(A)(2), or (c)(2)(ii)(A)(3) of this section, this is considered a single excursion for the control device or recovery device.

(1) When the daily average value of one or more monitored parameters is outside the permitted range.

(2) When the period of control device or recovery device operation is 4 hours or greater in an operating day and monitoring data are insufficient to constitute a valid hour of data for at least 75 percent of the operating hours.

(3) When the period of control device or recovery device operation is less than 4 hours in an operating day and more than one of the hours during the period of operation does not constitute a valid hour of data due to insufficient monitoring data.

(4) Monitoring data are insufficient to constitute a valid hour of data, as used in paragraphs (c)(2)(ii)(A)(2) and (c)(2)(ii)(A)(3) of this section, if measured values are unavailable for any of the 15-minute periods within the hour. For data compression systems approved under §63.151(g)(4), monitoring data are insufficient to calculate a valid hour of data if there are less than 4 data values recorded during the hour.

(B) The number of excused excursions for each control device or recovery device for each semiannual period is specified in paragraphs (c)(2)(ii)(B)(1) through (c)(2)(ii)(B)(6) of this section. This paragraph applies to sources required to submit Periodic Reports semiannually or quarterly. The first semiannual period is the 6-month period starting the date the Notification of Compliance Status is due.

(1) For the first semiannual period—six excused excursions.

(2) For the second semiannual period—five excused excursions.

(3) For the third semiannual period—four excused excursions.

(4) For the fourth semiannual period—three excused excursions.

(5) For the fifth semiannual period—two excused excursions.

(6) For the sixth and all subsequent semiannual periods—one excused excursion.

(C) A monitored parameter that is outside its established range or monitoring data that are not collected are excursions. However, if the conditions in paragraph (c)(2)(ii)(C)(1) or (c)(2)(ii)(C)(2) of this section are met, these excursions are not violations and do not count toward the number of excused excursions for determining compliance.

(1) *Periods of startup, shutdown, or malfunction.* During periods of startup, shutdown, or malfunction when the source is operated during such periods in accordance with §63.102(a)(4).

(2) *Periods of nonoperation.* During periods of nonoperation of the chemical manufacturing process unit, or portion thereof, that results in cessation of the emissions to which the monitoring applies.

(D) Nothing in paragraph (c)(2)(ii) of this section shall be construed to allow or excuse a monitoring parameter excursion caused by any activity that violates other applicable provisions of subpart A, F, or G of this part.

(E) Paragraph (c)(2)(ii) of this section, except paragraph (c)(2)(ii)(C) of this section, shall apply only to emission points and control devices or recovery devices for which continuous monitoring is required by §§63.113 through 63.150.

(iii) Periodic Reports shall include the daily average values of monitored parameters for both excused and unexcused excursions, as defined in paragraph (c)(2)(ii)(A) of this section. For excursions caused

by lack of monitoring data, the duration of periods when monitoring data were not collected shall be specified.

(iv) The provisions of paragraphs (c)(2), (c)(2)(i), (c)(2)(ii), and (c)(2)(iii) of this section do not apply to any storage vessel for which the owner or operator is not required, by the applicable monitoring plan established under §63.120(d)(2), to keep continuous records. If continuous records are required, the owner or operator shall specify, in the monitoring plan, whether the provisions of paragraphs (c)(2), (c)(2)(i), (c)(2)(ii), and (c)(2)(iii) of this section apply.

(3) If any performance tests are reported in a Periodic Report, the following information shall be included:

(i) One complete test report shall be submitted for each test method used for a particular kind of emission point tested. A complete test report shall contain the information specified in paragraph (b)(1)(ii) of this section.

(ii) For additional tests performed for the same kind of emission point using the same method, results and any other information required in §63.117 for process vents, §63.129 for transfer, and §63.146 for process wastewater shall be submitted, but a complete test report is not required.

(4) Periodic Reports shall include the information in paragraphs (c)(4)(i) through (c)(4)(iv) of this section, as applicable:

(i) For process vents, reports of process changes as required under §63.118 (g), (h), (i), and (j) of this subpart,

(ii) Any supplements required under §63.151(i) and (j) of this subpart,

(iii) Notification if any Group 2 emission point becomes a Group 1 emission point, including a compliance schedule as required in §63.100 of subpart F of this part, and

(iv) For gas streams sent for disposal pursuant to §63.113(i) or for process wastewater streams sent for treatment pursuant to §63.132(g), reports of changes in the identity of the transferee.

(5) The owner or operator of a source shall submit quarterly reports for all emission points included in an emissions average.

(i) The quarterly reports shall be submitted no later than 60 calendar days after the end of each quarter. The first report shall be submitted with the Notification of Compliance Status no later than 5 months after the compliance date specified in §63.100 of subpart F.

(ii) The quarterly reports shall include the information specified in this paragraph for all emission points included in an emissions average.

(A) The credits and debits calculated each month during the quarter;

(B) A demonstration that debits calculated for the quarter are not more than 1.30 times the credits calculated for the quarter, as required under §63.150(e)(4) of this subpart.

(C) The values of any inputs to the credit and debit equations in §63.150 (g) and (h) of this subpart that change from month to month during the quarter or that have changed since the previous quarter;

(D) Results of any performance tests conducted during the reporting period including one complete report for each test method used for a particular kind of emission point as described in paragraph (c)(3) of this section;

(E) Reports of daily average values of monitored parameters for both excused and unexcused excursions as defined in paragraph (c)(2)(ii)(A) of this section. For excursions caused by lack of monitoring data, the duration of periods when monitoring data were not collected shall be specified.

(iii) Paragraphs (c)(2)(i) through (c)(2)(iii) of this section shall govern the use of monitoring data to determine compliance for Group 1 and Group 2 points included in emissions averages. For storage vessels to which the provisions of paragraphs (c)(2)(i) through (c)(2)(iii) of this section do not apply (as specified in paragraph (c)(2)(iv) of this section), the owner or operator is required to comply with the provisions of the applicable monitoring plan, and monitoring records may be used to determine compliance.

(iv) Every fourth quarterly report shall include the following:

(A) A demonstration that annual credits are greater than or equal to annual debits as required by §63.150(e)(3) of this subpart; and

(B) A certification of compliance with all the emissions averaging provisions in §63.150 of this subpart.

(6) The owner or operator of a source shall submit reports quarterly for particular emission points not included in an emissions average under the circumstances described in paragraphs (c)(6)(i) through (c)(6)(v) of this section.

(i) The owner or operator of a source subject to this subpart shall submit quarterly reports for a period of one year for an emission point that is not included in an emissions average if:

(A) The emission point has more excursions, as defined in paragraph (c)(2)(ii) of this section, than the number of excused excursions allowed under paragraph (c)(2)(ii)(B) of this section for a semiannual reporting period; and

(B) The Administrator requests the owner or operator to submit quarterly reports for the emission point.

(ii) The quarterly reports shall include all information in paragraphs (c)(2), (c)(3), and (c)(4) of this section applicable to the emission point(s) for which quarterly reporting is required under paragraph (c)(6)(i) of this section. Information applicable to other emission points within the source shall be submitted in the semiannual reports required under paragraph (c)(1) of this section.

(iii) Quarterly reports shall be submitted no later than 60 calendar days after the end of each quarter.

(iv) After quarterly reports have been submitted for an emission point for one year, the owner or operator may return to semiannual reporting for the emission point unless the Administrator requests the owner or operator to continue to submit quarterly reports.

(v) Paragraphs (c)(2)(i) through (c)(2)(iii) of this section shall govern the use of monitoring data to determine compliance for Group 1 emission points. For storage vessels to which the provisions of paragraphs (c)(2)(i) through (c)(2)(iii) of this section do not apply (as specified in paragraph (c)(2)(iv) of this section), the owner or operator is required to comply with the provisions of the applicable monitoring plan, and monitoring records may be used to determine compliance.

(d) Other reports shall be submitted as specified in subpart A of this part or in §§63.113 through 63.151 of this subpart. These reports are:

(1) Reports of start-up, shutdown, and malfunction required by §63.10(d)(5) of subpart A. The start-up, shutdown and malfunction reports may be submitted on the same schedule as the Periodic Reports required under paragraph (c) of this section instead of the schedule specified in §63.10(d)(5) of subpart A.

(2) For storage vessels, the notifications of inspections required by §63.122 (h)(1) and (h)(2) of this subpart.

(3) For owners or operators of sources required to request approval for a nominal control efficiency for use in calculating credits for an emissions average, the information specified in §63.150(i) of this subpart.

(4) If an owner or operator transfers for disposal a gas stream that has the characteristics specified in

§63.107(b) through (h) or meets the criteria specified in §63.107(i) to an off-site location or an on-site location not owned or operated by the owner or operator of the source and the vent stream was not included in the information submitted with the Notification of Compliance Status or a previous periodic report, the owner or operator shall submit a supplemental report. The supplemental report shall be submitted no later than July 23, 2001 or with the next periodic report, whichever is later. The report shall provide the information listed in paragraphs (d)(4)(i) through (iv) of this section.

(i) The chemical manufacturing process unit(s) that is the origin of all or part of the vent stream that exits the process vent.

(ii) The type(s) of unit operations (*i.e.*, an air oxidation reactor, distillation unit, or reactor) that creates the vent stream that exits the process vent.

(iii) For a Group 2 process vent, the last recovery device, if any.

(iv) For a Group 1 process vent, the identity of the transferee.

(e) An owner or operator subject to this subpart shall submit the information specified in paragraphs (e) (1) through (e)(4) of this section with the operating permit application or as otherwise specified by the permitting authority. The owner or operator shall submit written updates as amendments to the operating permit application on the schedule and under the circumstances described in §63.151(j) of this subpart. Notwithstanding, if the owner or operator has an operating permit under 40 CFR part 70 or 71, the owner or operator shall follow the schedule and format required by the permitting authority.

(1) The information specified in §63.151 (f) or (g) of this subpart for any emission points for which the owner or operator requests approval to monitor a unique parameter or use an alternative monitoring and recording system, and

(2) The information specified in §63.151(d) of this subpart for points included in an emissions average.

(3) The information specified in §63.151(e) of this subpart for points not included in an emissions average.

(4) The information specified in §63.151(h) as applicable.

(f) Owners or operators required to keep continuous records by §§63.118, 63.130, 63.147, 63.150, or other sections of this subpart shall keep records as specified in paragraphs (f)(1) through (f)(7) of this section, unless an alternative recordkeeping system has been requested and approved under §63.151(f) or (g) or §63.152(e) or under §63.8(f) of subpart A of this part, and except as provided in paragraph (c) (2)(ii)(C) of this section or in paragraph (g) of this section. If a monitoring plan for storage vessels pursuant to §63.120(d)(2)(i) requires continuous records, the monitoring plan shall specify which provisions, if any, of paragraphs (f)(1) through (f)(7) of this section apply.

(1) The monitoring system shall measure data values at least once every 15 minutes.

(2) The owner or operator shall record either:

(i) Each measured data value; or

(ii) Block average values for 15-minute or shorter periods calculated from all measured data values during each period or at least one measured data value per minute if measured more frequently than once per minute.

(3) If the daily average value of a monitored parameter for a given operating day is within the range established in the Notification of Compliance Status or operating permit, the owner or operator shall either:

(i) Retain block hourly average values for that operating day for 5 years and discard, at or after the end of that operating day, the 15-minute or more frequent average values and readings recorded under paragraph (f)(2) of this section; or

(ii) Retain the data recorded in paragraph (f)(2) of this section for 5 years.

(4) If the daily average value of a monitored parameter for a given operating day is outside the range established in the Notification of Compliance Status or operating permit, the owner or operator shall retain the data recorded that operating day under paragraph (f)(2) of this section for 5 years.

(5) Daily average values of each continuously monitored parameter shall be calculated for each operating day, and retained for 5 years, except as specified in paragraphs (f)(6) and (f)(7) of this section.

(i) The daily average shall be calculated as the average of all values for a monitored parameter recorded during the operating day. The average shall cover a 24-hour period if operation is continuous, or the number of hours of operation per operating day if operation is not continuous.

(ii) The operating day shall be the period defined in the operating permit or the Notification of Compliance Status. It may be from midnight to midnight or another daily period.

(6) If all recorded values for a monitored parameter during an operating day are within the range established in the Notification of Compliance Status or operating permit, the owner or operator may record that all values were within the range and retain this record for 5 years rather than calculating and recording a daily average for that operating day. For these operating days, the records required in paragraph (f)(3) of this section shall also be retained for 5 years.

(7) Monitoring data recorded during periods identified in paragraphs (f)(7)(i) through (f)(7)(v) of this section shall not be included in any average computed under this subpart. Records shall be kept of the times and durations of all such periods and any other periods during process or control device operation when monitors are not operating.

(i) Monitoring system breakdowns, repairs, calibration checks, and zero (low-level) and high-level adjustments;

(ii) Start-ups;

(iii) Shutdowns;

(iv) Malfunctions;

(v) Periods of non-operation of the chemical manufacturing process unit (or portion thereof), resulting in cessation of the emissions to which the monitoring applies.

(g) For any parameter with respect to any item of equipment, the owner or operator may implement the recordkeeping requirements in paragraph (g)(1) or (g)(2) of this section as alternatives to the continuous operating parameter monitoring and recordkeeping provisions listed in §§63.114, 63.117, and 63.118 for process vents, §§63.127, 63.129, and 63.130 for transfer operations, §§63.143, 63.146, and 63.147 for wastewater, and/or §63.152(f), except that §63.152(f)(7) shall apply. The owner or operator shall retain each record required by paragraph (g)(1) or (g)(2) of this section as provided in §63.103(c) of subpart F of this part, except as provided otherwise in paragraph (g)(1) or (g)(2) of this section.

(1) The owner or operator may retain only the daily average value, and is not required to retain more frequent monitored operating parameter values, for a monitored parameter with respect to an item of equipment, if the requirements of paragraphs (g)(1)(i) through (g)(1)(vi) of this section are met. An owner or operator electing to comply with the requirements of paragraph (g)(1) of this section shall notify the Administrator in the Notification of Compliance Status or, if the Notification of Compliance Status has already been submitted, in the periodic report immediately preceding implementation of the requirements of paragraph (g)(1) of this section.

(i) The monitoring system is capable of detecting unrealistic or impossible data during periods of operation other than startups, shutdowns, or malfunctions (e.g., a temperature reading of -200 °C on a boiler), and will alert the operator by alarm or other means. The owner or operator shall record the occurrence. All instances of the alarm or other alert in an operating day constitute a single occurrence.

(ii) The monitoring system generates, updated at least hourly throughout each operating day, a running average of the monitoring values that have been obtained during that operating day, and the capability to observe this average is readily available to the Administrator on-site during the operating day. The owner or operator shall record the occurrence of any period meeting the criteria in paragraphs (g)(1)(ii)(A) through (g)(1)(iii)(C) of this section. All instances in an operating day constitute a single occurrence.

(A) The running average is above the maximum or below the minimum established limits;

(B) The running average is based on at least 6 1-hour average values; and

(C) The running average reflects a period of operation other than a startup, shutdown, or malfunction.

(iii) The monitoring system is capable of detecting unchanging data during periods of operation other than startups, shutdowns, or malfunctions, except in circumstances where the presence of unchanging data is the expected operating condition based on past experience (e.g., pH in some scrubbers), and will alert the operator by alarm or other means. The owner or operator shall record the occurrence. All instances of the alarm or other alert in an operating day constitute a single occurrence.

(iv) The monitoring system will alert the owner or operator by an alarm or other means, if the running average parameter value calculated under paragraph (g)(1)(ii) of this section reaches a set point that is appropriately related to the established limit for the parameter that is being monitored.

(v) The owner or operator shall verify the proper functioning of the monitoring system, including its ability to comply with the requirements of paragraph (g)(1) of this section, at the times specified in paragraphs (g)(1)(v)(A) through (g)(1)(v)(C) of this section. The owner or operator shall document that the required verifications occurred.

(A) Upon initial installation.

(B) Annually after initial installation.

(C) After any change to the programming or equipment constituting the monitoring system, which might reasonably be expected to alter the monitoring system's ability to comply with the requirements of this section.

(vi) The owner or operator shall retain the records identified in paragraphs (g)(1)(vi) (A) through (C) of this section.

(A) Identification of each parameter, for each item of equipment, for which the owner or operator has elected to comply with the requirements of paragraph (g) of this section.

(B) A description of the applicable monitoring system(s), and of how compliance will be achieved with each requirement of paragraph (g)(1)(i) through (g)(1)(v) of this section. The description shall identify the location and format (e.g., on-line storage; log entries) for each required record. If the description changes, the owner or operator shall retain both the current and the most recent superseded description. The description, and the most recent superseded description, shall be retained as provided in §63.103(c) of subpart F of this part, except as provided in paragraph (g)(1)(vi)(D) of this section.

(C) A description, and the date, of any change to the monitoring system that would reasonably be expected to affect its ability to comply with the requirements of paragraph (g)(1) of this section.

(D) Owners and operators subject to paragraph (g)(1)(vi)(B) of this section shall retain the current description of the monitoring system as long as the description is current, but not less than 5 years from the date of its creation. The current description shall, at all times, be retained on-site or be accessible from a central location by computer or other means that provides access within 2 hours after a request. The owner or operator shall retain the most recent superseded description at least until 5 years from the date of its creation. The superseded description shall be retained on-site (or accessible from a central location by computer that provides access within 2 hours after a request) at least 6 months after its creation. Thereafter, the superseded description may be stored off-site.

(2) If an owner or operator has elected to implement the requirements of paragraph (g)(1) of this section, and a period of 6 consecutive months has passed without an excursion as defined in paragraph (g)(2)(iv) of this section, the owner or operator is no longer required to record the daily average value for that parameter for that unit of equipment, for any operating day when the daily average value is less than the maximum, or greater than the minimum established limit. With approval by the Administrator, monitoring data generated prior to the compliance date of this subpart shall be credited toward the period of 6 consecutive months, if the parameter limit and the monitoring was required and/or approved by the Administrator.

(i) If the owner or operator elects not to retain the daily average values, the owner or operator shall notify the Administrator in the next periodic report. The notification shall identify the parameter and unit of equipment.

(ii) If, on any operating day after the owner or operator has ceased recording daily averages as provided in paragraph (g)(2) of this section, there is an excursion as defined in paragraph (g)(2)(iv) of this section, the owner or operator shall immediately resume retaining the daily average value for each day, and shall notify the Administrator in the next periodic report. The owner or operator shall continue to retain each daily average value until another period of 6 consecutive months has passed without an excursion as defined in paragraph (g)(2)(iv) of this section.

(iii) The owner or operator shall retain the records specified in paragraphs (g)(1) (i), (ii), (iii), (iv), (v), and (vi) of this section. For any calendar week, if compliance with paragraphs (g)(1) (i), (ii), (iii), and (iv) of this section does not result in retention of a record of at least one occurrence or measured parameter value, the owner or operator shall record and retain at least one parameter value during a period of operation other than a startup, shutdown, or malfunction.

(iv) For purposes of paragraph (g) of this section, an excursion means that the daily average value of monitoring data for a parameter is greater than the maximum, or less than the minimum established value, except as provided in paragraphs (g)(2)(iv)(A) and (g)(2)(iv)(B) of this section.

(A) The daily average value during any startup, shutdown, or malfunction shall not be considered an excursion for purposes of this paragraph (g)(2), if the owner or operator operates the source during such periods in accordance with §63.102(a)(4).

(B) An excused excursion, as described in §63.152(c)(2)(ii) (B) and (C), shall not be considered an excursion for purposes of this paragraph (g)(2).

[59 FR 19468, Apr. 22, 1994, as amended at 60 FR 63629, Dec. 12, 1995; 61 FR 64577, Dec. 5, 1996; 62 FR 2776, Jan. 17, 1997; 64 FR 20195, Apr. 26, 1999; 66 FR 6934, Jan. 22, 2001; 71 FR 20456, Apr. 20, 2006]

§ 63.153 Implementation and enforcement.

(a) This subpart can be implemented and enforced by the U.S. EPA, or a delegated authority such as the applicable State, local, or Tribal agency. If the U.S. EPA Administrator has delegated authority to a State, local, or Tribal agency, then that agency, in addition to the U.S. EPA, has the authority to implement and enforce this subpart. Contact the applicable U.S. EPA Regional Office to find out if implementation and enforcement of this subpart is delegated to a State, local, or Tribal agency.

(b) In delegating implementation and enforcement authority of this subpart to a State, local, or Tribal agency under subpart E of this part, the authorities contained in paragraph (c) of this section are retained by the Administrator of U.S. EPA and cannot be transferred to the State, local, or Tribal agency.

(c) The authorities that cannot be delegated to State, local, or Tribal agencies are as specified in paragraphs (c)(1) through (4) of this section.

(1) Approval of alternatives to the requirements in §§63.110, 63.112 through 63.113, 63.119, 63.126, 63.132 through 63.140, 63.148 through 63.149, and 63.150(i)(1) through (4). Follow the requirements in §63.121 to request permission to use an alternative means of emission limitation for storage vessels. Where these standards reference another subpart, the cited provisions will be delegated according to the delegation provisions of the referenced subpart. Where these standards reference another subpart

and modify the requirements, the requirements shall be modified as described in this subpart. Delegation of the modified requirements will also occur according to the delegation provisions of the referenced subpart.

(2) Approval of major alternatives to test methods under §63.7(e)(2)(ii) and (f), as defined in §63.90, and as required in this subpart.

(3) Approval of major alternatives to monitoring under §63.8(f), as defined in §63.90, and as required in this subpart.

(4) Approval of major alternatives to recordkeeping and reporting under §63.10(f), as defined in §63.90, and as required in this subpart.

[68 FR 37344, June 23, 2003]

Table 1 to Subpart G of Part 63—Process Vents—Coefficients for Total Resource Effectiveness for Existing Source Nonhalogenated and Halogenated Vent Streams

Type of Stream	Control Device Basis	Values of Coefficients			
		a	b	c	d
Nonhalogenated	Flare	1.935	3.660×10^{-1}	-7.687×10^{-3}	-7.333×10^{-4}
	Thermal Incinerator 0 Percent Heat Recovery	1.492	6.267×10^{-2}	3.177×10^{-2}	-1.159×10^{-3}
	Thermal Incinerator 70 Percent Heat Recovery	2.519	1.183×10^{-2}	1.300×10^{-2}	4.790×10^{-2}
Halogenated	Thermal Incinerator and Scrubber	3.995	5.200×10^{-2}	-1.769×10^{-3}	9.700×10^{-4}

Table 1A to Subpart G of Part 63—Applicable 40 CFR Part 63 General Provisions

40 CFR part 63, subpart A, provisions applicable to subpart G
§63.1(a)(1), (a)(2), (a)(3), (a)(13), (a)(14), (b)(2) and (c)(4)
§63.2
§63.5(a)(1), (a)(2), (b), (d)(1)(ii), (d)(3)(i), (d)(3)(iii) through (d)(3)(vi), (d)(4), (e), (f)(1), and (f)(2)
§63.6(a), (b)(3), (c)(5), (i)(1), (i)(2), (i)(4)(i)(A), (i)(5) through (i)(14), (i)(16) and (j)
§63.9(a)(2), (b)(4)(i) ^a , (b)(4)(ii), (b)(4)(iii), (b)(5) ^a , (c), (d)
§63.10(d)(4)
§63.12(b)

^aThe notifications specified in §63.9(b)(4)(i) and (b)(5) shall be submitted at the times specified in 40 CFR part 65.

Table 2 to Subpart G of Part 63—Process Vents—Coefficients for Total Resource Effectiveness for New Source Nonhalogenated and Halogenated Vent Streams

Type of stream	Control device basis	Values of Coefficients			
		a	b	c	d
Nonhalogenated	Flare	0.5276	0.0998	-2.096×10^{-3}	-2.000×10^{-4}
	Thermal Incinerator 0 Percent Heat Recovery	0.4068	0.0171	8.664×10^{-3}	-3.162×10^{-4}
	Thermal Incinerator 70 Percent Heat Recovery	0.6868	3.209×10^{-3}	3.546×10^{-3}	1.306×10^{-2}
Halogenated	Thermal Incinerator and Scrubber	1.0895	1.417×10^{-2}	-4.822×10^{-4}	2.645×10^{-4}

Table 3 to Subpart G of Part 63—Process Vents—Monitoring, Recordkeeping, and Reporting Requirements for Complying With 98 Weight-Percent Reduction of Total Organic Hazardous Air Pollutants Emissions or a Limit of 20 Parts Per Million by Volume

Control device	Parameters to be monitored ^a	Recordkeeping and reporting requirements for monitored parameters
Thermal incinerator	Firebox temperature ^b [63.114(a)(1)(i)]	<ol style="list-style-type: none"> 1. Continuous records.^c 2. Record and report the firebox temperature averaged over the full period of the performance test—NCS.^d 3. Record the daily average firebox temperature for each operating day.^e 4. Report all daily average temperatures that are outside the range established in the NCS or operating permit and all operating days when insufficient monitoring data are collected^f—PR.^g
Catalytic incinerator	Temperature upstream and downstream of the catalyst bed [63.114(a)(1)]	<ol style="list-style-type: none"> 1. Continuous records. 2. Record and report the upstream and downstream

	(ii)]	<p>temperatures and the temperature difference across the catalyst bed averaged over the full period of the performance test—NCS.</p> <p>3. Record the daily average upstream temperature and temperature difference across the catalyst bed for each operating day.^e</p> <p>4. Report all daily average upstream temperatures that are outside the range established in the NCS or operating permit—PR.</p> <p>5. Report all daily average temperature differences across the catalyst bed that are outside the range established in the NCS or operating permit—PR.</p> <p>6. Report all operating days when insufficient monitoring data are collected.^f</p>
Boiler or process heater with a design heat input capacity less than 44 megawatts and vent stream is <i>not</i> introduced with or as the primary fuel	Firebox temperature ^b [63.114(a)(3)]	<p>1. Continuous records.</p> <p>2. Record and report the firebox temperature averaged over the full period of the performance test—NCS.</p> <p>3. Record the daily average firebox temperature for each operating day.^e</p> <p>4. Report all daily average firebox temperatures that are outside the range established in the NCS or operating permit and all operating days when insufficient monitoring data are collected^f—PR.</p>
Flare	Presence of a flame at the pilot light [63.114(a)(2)]	1. Hourly records of whether the monitor was continuously operating and whether the pilot flame was continuously present during each hour.

		<ol style="list-style-type: none"> 2. Record and report the presence of a flame at the pilot light over the full period of the compliance determination—NCS. 3. Record the times and durations of all periods when all pilot flames are absent or the monitor is not operating. 4. Report the times and durations of all periods when all pilot flames of a flare are absent—PR.
Recapture devices	The appropriate monitoring device identified in table 4 when, in the table, the term "recapture" is substituted for "recovery." [63.114(a)(5)]	<ol style="list-style-type: none"> 1. The recordkeeping and reporting requirements for monitored parameters identified for the appropriate monitoring device in table 4 of this subpart.
Scrubber for halogenated vent streams (Note: Controlled by a combustion device other than a flare)	pH of scrubber effluent [63.114(a)(4)(i)], and	<ol style="list-style-type: none"> 1. Continuous records. 2. Record and report the pH of the scrubber effluent averaged over the full period of the performance test—NCS. 3. Record the daily average pH of the scrubber effluent for each operating day.^e 4. Report all daily average pH values of the scrubber effluent that are outside the range established in the NCS or operating permit and all operating days when insufficient monitoring data are collected^f—PR.
Scrubber for halogenated vent streams (Note: Controlled by a combustion device other than a flare) (Continued)	Scrubber liquid and gas flow rates [63.114(a)(4)(ii)]	<ol style="list-style-type: none"> 1. Continuous records of scrubber liquid flow rate. 2. Record and report the scrubber liquid/gas ratio averaged over the full period of the performance test—NCS. 3. Record the daily average scrubber liquid/gas ratio for each operating day.^e 4. Report all daily average

		scrubber liquid/gas ratios that are outside the range established in the NCS or operating permit and all operating days when insufficient monitoring data are collected ^f —PR.
All control devices	Presence of flow diverted to the atmosphere from the control device [63.114(d)(1)] <i>or</i>	1. Hourly records of whether the flow indicator was operating and whether diversion was detected at any time during each hour. 2. Record and report the times and durations of all periods when the vent stream is diverted through a bypass line or the monitor is not operating—PR.
	Monthly inspections of sealed valves [63.114(d)(2)]	1. Records that monthly inspections were performed. 2. Record and report all monthly inspections that show the valves are moved to the diverting position or the seal has been changed—PR.

^aRegulatory citations are listed in brackets.

^bMonitor may be installed in the firebox or in the ductwork immediately downstream of the firebox before any substantial heat exchange is encountered.

^c“Continuous records” is defined in §63.111 of this subpart.

^dNCS=Notification of Compliance Status described in §63.152 of this subpart.

^eThe daily average is the average of all recorded parameter values for the operating day. If all recorded values during an operating day are within the range established in the NCS or operating permit, a statement to this effect can be recorded instead of the daily average.

^fThe periodic reports shall include the duration of periods when monitoring data is not collected for each excursion as defined in §63.152(c)(2)(ii)(A) of this subpart.

^gPR=Periodic Reports described in §63.152 of this subpart.

Table 4 to Subpart G of Part 63—Process Vents—Monitoring, Recordkeeping, and Reporting Requirements For Maintaining a TRE Index Value >1.0 and. ≤4.0

Final recovery	Parameters to be	Recordkeeping and reporting requirements for monitored
----------------	------------------	--

device	monitored ^a	parameters
Absorber ^b	Exit temperature of the absorbing liquid [63.114(b)(1)], and	1. Continuous records ^c . 2. Record and report the exit temperature of the absorbing liquid averaged over the full period of the TRE determination—NCS ^d .
		3. Record the daily average exit temperature of the absorbing liquid for each operating day ^e .
		4. Report all the daily average exit temperatures of the absorbing liquid that are outside the range established in the NCS or operating permit—PR ^f .
	Exit specific gravity [63.114(b)(1)]	1. Continuous records. 2. Record and report the exit specific gravity averaged over the full period of the TRE determination—NCS.
		3. Record the daily average exit specific gravity for each operating day ^e .
		4. Report all daily average exit specific gravity values that are outside the range established in the NCS or operating permit—PR.
Condenser ^d	Exit (product side) temperature [63.114(b)(2)]	1. Continuous records. 2. Record and report the exit temperature averaged over the full period of the TRE determination—NCS.
		3. Record the daily average exit temperature for each operating day ^e .
		4. Report all daily average exit temperatures that are outside the range established in the NCS or operating permit—PR.
Carbon adsorber ^d	Total regeneration stream mass or volumetric flow during carbon bed regeneration cycle(s) [63.114(b)(3)], and	1. Record of total regeneration stream mass or volumetric flow for each carbon bed regeneration cycle. 2. Record and report the total regeneration stream mass or

		volumetric flow during each carbon bed regeneration cycle during the period of the TRE determination—NCS.
		3. Report all carbon bed regeneration cycles when the total regeneration stream mass or volumetric flow is outside the range established in the NCS or operating permit—PR.
	Temperature of the carbon bed after regeneration [and within 15 minutes of completing any cooling cycle(s)] [63.114(b)(3)]	1. Records of the temperature of the carbon bed after each regeneration. 2. Record and report the temperature of the carbon bed after each regeneration during the period of the TRE determination—NCS.
		3. Report all carbon bed regeneration cycles during which temperature of the carbon bed after regeneration is outside the range established in the NCS or operating permit—PR.
All recovery devices (as an alternative to the above)	Concentration level or reading indicated by an organic monitoring device at the outlet of the recovery device [63.114 (b)]	1. Continuous records. 2. Record and report the concentration level or reading averaged over the full period of the TRE determination—NCS.
		3. Record the daily average concentration level or reading for each operating day ^e .
		4. Report all daily average concentration levels or readings that are outside the range established in the NCS or operating permit—PR.

^aRegulatory citations are listed in brackets.

^bAlternatively, these devices may comply with the organic monitoring device provisions listed at the end of this table under “All Recovery Devices.”

^c“Continuous records” is defined in §63.111 of this subpart.

^dNCS = Notification of Compliance Status described in §63.152 of this subpart.

^eThe daily average is the average of all values recorded during the operating day. If all recorded values during an operating day are within the range established in the NCS or operating permit, a statement to this effect can be recorded instead of the daily average.

^fPR= Periodic Reports described in §63.152 of this subpart.

Table 5 to Subpart G of Part 63—Group 1 Storage Vessels at Existing Sources

Vessel capacity (cubic meters)	Vapor Pressure ¹ (kilopascals)
75 ≤ capacity <151	≥13.1
151 ≤ capacity	≥5.2

¹Maximum true vapor pressure of total organic HAP at storage temperature.

Table 6 to Subpart G of Part 63—Group 1 Storage Vessels at New Sources

Vessel capacity (cubic meters)	Vapor pressure ^a (kilopascals)
38 ≤ capacity <151	≥13.1
151 ≤ capacity	≥0.7

^aMaximum true vapor pressure of total organic HAP at storage temperature.

Table 7 to Subpart G of Part 63—Transfer Operations—Monitoring, Recordkeeping, and Reporting Requirements for Complying With 98 Weight-Percent Reduction of Total Organic Hazardous Air Pollutants Emissions or a Limit of 20 Parts Per Million by Volume

Control device	Parameters to be monitored ^a	Recordkeeping and reporting requirements for monitored parameters
Thermal incinerator	Firebox temperature ^b [63.127(a)(1)(i)]	1. Continuous records ^c during loading. 2. Record and report the firebox temperature averaged over the full period of the performance test—NCS. ^d
		3. Record the daily average firebox temperature for each operating day ^e
		4. Report daily average temperatures that are outside the range established in the NCS or operating permit and all operating days when insufficient monitoring data are collected ^f —

		PR ^g
Catalytic incinerator	Temperature upstream and downstream of the catalyst bed [63.127(a)(1)(ii)]	1. Continuous records during loading. 2. Record and report the upstream and downstream temperatures and the temperature difference across the catalyst bed averaged over the full period of the performance test—NCS.
		3. Record the daily average upstream temperature and temperature difference across catalyst bed for each operating day. ^e
		4. Report all daily average upstream temperatures that are outside the range established in the NCS or operating permit—PR.
		5. Report all daily average temperature differences across the catalyst bed that are outside the range established in the NCS or operating permit—PR.
		6. Report all operating days when insufficient monitoring data are collected. ^f
Boiler or process heater with a design heat input capacity less than 44 megawatts and vent stream is not introduced with or as the primary fuel	Firebox temperature ^b [63.127(a)(3)]	1. Continuous records during loading. 2. Record and report the firebox temperature averaged over the full period of the performance test—NCS.
		3. Record the daily average firebox temperature for each operating day. ^e
		4. Report all daily average firebox temperatures that are outside the range established in the NCS or operating permit and all operating days when insufficient data are collected—PR.
Flare	Presence of a flame	1. Hourly records of whether the

	at the pilot light [63.127(a)(2)]	monitor was continuously operating and whether the pilot flame was continuously present during each hour.
		2. Record and report the presence of a flame at the pilot light over the full period of the compliance determination—NCS.
		3. Record the times and durations of all periods when all pilot flames are absent or the monitor is not operating.
		4. Report the duration of all periods when all pilot flames of a flare are absent—PR.
Scrubber for halogenated vent streams (Note: Controlled by a combustion device other than a flare)	pH of scrubber effluent [63.127(a)(4)(i)], and	1. Continuous records during loading. 2. Record and report the pH of the scrubber effluent averaged over the full period of the performance test—NCS.
		3. Record the daily average pH of the scrubber effluent for each operating day. ^e
		4. Report all daily average pH values of the scrubber effluent that are outside the range established in the NCS or operating permit and all operating days when insufficient monitoring data are collected ^f —PR.
	Scrubber liquid and gas flow rates [63.127(a)(4)(ii)]	1. Continuous records during loading of scrubber liquid flow rate. 2. Record and report the scrubber liquid/gas ratio averaged over the full period of the performance test—NCS.
		3. Record the daily average scrubber liquid/gas ratio for each operating day. ^e
		4. Report all daily average scrubber liquid/gas ratios that are outside the range established in the NCS or

		operating permit and all operating days when insufficient monitoring data are collected ^f —PR.
Absorber ^h	Exit temperature of the absorbing liquid [63.127(b)(1)], and	1. Continuous records during loading. 2. Record and report the exit temperature of the absorbing liquid averaged over the full period of the performance test—NCS.
		3. Record the daily average exit temperature of the absorbing liquid for each operating day. ^e
		4. Report all daily average exit temperatures of the absorbing liquid that are outside the range established in the NCS or operating permit and all operating days when insufficient monitoring data are collected ^f —PR.
	Exit specific gravity [63.127(b)(1)]	1. Continuous records during loading. 2. Record and report the exit specific gravity averaged over the full period of the performance test—NCS.
		3. Record the daily average exit specific gravity for each operating day. ^e
		4. Report all daily average exit specific gravity values that are outside the range established in the NCS or operating permit and all operating days when insufficient monitoring data are collected ^f —PR.
Condenser ^h	Exit (product side) temperature [63.127(b)(2)]	1. Continuous records during loading. 2. Record and report the exit temperature averaged over the full period of the performance test—NCS.
		3. Record the daily average exit temperature for each operating

		day. ^e
		4. Report all daily average exit temperatures that are outside the range established in the NCS or operating permit and all operating days when insufficient monitoring data are collected ^f —PR.
Carbon adsorber ^h	Total regeneration stream mass or volumetric or volumetric flow during carbon bed regeneration cycle(s) [63.127(b)(3)], and	1. Record of total regeneration stream mass or volumetric flow for each carbon bed regeneration cycle. 2. Record and report the total regeneration stream mass or volumetric flow during each carbon bed regeneration cycle during the period of the performance test—NCS.
		3. Report all carbon bed regeneration cycles when the total regeneration stream mass or volumetric flow is outside the range established in the NCS or operating permit and all operating days when insufficient monitoring data are collected ^f —PR.
	Temperature of the carbon bed after regeneration [and within 15 minutes of completing any cooling cycle(s)] [63.127(b)(3)]	1. Records of the temperature of the carbon bed after each regeneration. 2. Record and report the temperature of the carbon bed after each regeneration during the period of the performance test—NCS.
		3. Report all the carbon bed regeneration cycles during which the temperature of the carbon bed after regeneration is outside the range established in the NCS or operating permit and all operating days when insufficient monitoring data are collected ^f —PR.
All recovery devices (as an alternative to the above)	Concentration level or reading indicated by an organic	1. Continuous records during loading. 2. Record and report the

	monitoring device at the outlet of the recovery device [63.127(b)]	concentration level or reading averaged over the full period of the performance test—NCS.
		3. Record the daily average concentration level or reading for each operating day. ^d
		4. Report all daily average concentration levels or readings that are outside the range established in the NCS or operating permit and all operating days when insufficient monitoring data are collected ^f —PR.
All control devices and vapor balancing systems	Presence of flow diverted to the atmosphere from the control device [63.127(d)(1)] or	1. Hourly records of whether the flow indicator was operating and whether a diversion was detected at any time during each hour.
		2. Record and report the duration of all periods when the vent stream is diverted through a bypass line or the monitor is not operating—PR.
	Monthly inspections of sealed valves [63.127(d)(2)]	1. Records that monthly inspections were performed. 2. Record and report all monthly inspections that show the valves are moved to the diverting position or the seal has been changed.

^aRegulatory citations are listed in brackets.

^bMonitor may be installed in the firebox or in the ductwork immediately downstream of the firebox before any substantial heat exchange is encountered.

^c“Continuous records” is defined in §63.111 of this subpart.

^dNCS = Notification of Compliance Status described in §63.152 of this subpart.

^eThe daily average is the average of all recorded parameter values for the operating day. If all recorded values during an operating day are within the range established in the NCS or operating permit, a statement to this effect can be recorded instead of the daily average.

^fThe periodic reports shall include the duration of periods when monitoring data are not collected for each excursion as defined in §63.152(c)(2)(ii)(A) of this subpart.

⁹PR = Periodic Reports described in §63.152 of this subpart.

^hAlternatively, these devices may comply with the organic monitoring device provisions listed at the end of this table under "All Recovery Devices."

Table 8 to Subpart G of Part 63—Organic HAP's Subject to the Wastewater Provisions for Process Units at New Sources

Chemical name	CAS No. ^a
Allyl chloride	107051
Benzene	71432
Butadiene (1,3-)	106990
Carbon disulfide	75150
Carbon tetrachloride	56235
Cumene	98828
Ethylbenzene	100414
Ethyl chloride (Chloroethane)	75003
Ethylidene dichloride (1,1-Dichloroethane).	75343
Hexachlorobutadiene	87683
Hexachloroethane	67721
Hexane	100543
Methyl bromide (Bromomethane)	74839
Methyl chloride (Chloromethane)	74873
Phosgene	75445
Tetrachloroethylene (Perchloroethylene)	127184
Toluene	108883
Trichloroethane (1,1,1-) (Methyl chloroform)	71556
Trichloroethylene	79016
Trimethylpentane (2,2,4-)	540841
Vinyl chloride (chloroethylene)	75014
Vinylidene chloride (1,1-Dichloroethylene).	75354
Xylene (m-)	108383
Xylene (p-)	106423

^aCAS numbers refer to the Chemical Abstracts Service registry number assigned to specific compounds, isomers, or mixtures of compounds.

Note. The list of organic HAP's on table 8 is a subset of the list of organic HAP's on table 9 of this subpart.

Table 9 to Subpart G of Part 63—Organic HAP's Subject to the Wastewater Provisions for Process Units at New and Existing Sources and Corresponding Fraction Removed (Fr) Values

Chemical name	CAS No. ^a	Fr
Acetaldehyde	75070	0.95
Acetonitrile	75058	0.62
Acetophenone	98862	0.72
Acrolein	107028	0.96
Acrylonitrile	107131	0.96
Allyl chloride	107051	0.99
Benzene	71432	0.99
Benzyl chloride	100447	0.99
Biphenyl	92524	0.99
Bromoform	75252	0.99
Butadiene (1,3-)	106990	0.99
Carbon disulfide	75150	0.99
Carbon tetrachloride	56235	0.99
Chlorobenzene	108907	0.99
Chloroform	67663	0.99
Chloroprene (2-Chloro-1,3-butadiene)	126998	0.99
Cumene	98828	0.99
Dichlorobenzene (p-)	106467	0.99
Dichloroethane (1,2-) (Ethylene dichloride)	107062	0.99
Dichloroethyl ether (Bis(2-chloroethyl)ether)	111444	0.87
Dichloropropene (1,3-)	542756	0.99
Diethyl sulfate	64675	0.90
Dimethyl sulfate	77781	0.53
Dimethylaniline (N,N-)	121697	0.99
Dimethylhydrazine (1,1-)	57147	0.57
Dinitrophenol (2,4-)	51285	0.99
Dinitrotoluene (2,4-)	121142	0.38
Dioxane (1,4-) (1,4-Diethyleneoxide)	123911	0.37
Epichlorohydrin(1-Chloro-2,3-epoxypropane)	106898	0.91
Ethyl acrylate	140885	0.99
Ethylbenzene	100414	0.99
Ethyl chloride (Chloroethane)	75003	0.99
Ethylene dibromide (Dibromomethane)	106934	0.99
Ethylene glycol dimethyl ether	110714	0.90
Ethylene glycol monobutyl ether acetate	112072	0.76
Ethylene glycol monomethyl ether acetate	110496	0.28
Ethylene oxide	75218	0.98
Ethylidene dichloride (1,1-Dichloroethane)	75343	0.99
Hexachlorobenzene	118741	0.99

Hexachlorobutadiene	87683	0.99
Hexachloroethane	67721	0.99
Hexane	110543	0.99
Isophorone	78591	0.60
Methanol	67561	0.31
Methyl bromide (Bromomethane)	74839	0.99
Methyl chloride (Chloromethane)	74873	0.99
Methyl isobutyl ketone (Hexone)	108101	0.99
Methyl methacrylate	80626	0.98
Methyl tert-butyl ether	1634044	0.99
Methylene chloride (Dichloromethane)	75092	0.99
Naphthalene	91203	0.99
Nitrobenzene	98953	0.80
Nitropropane (2-)	79469	0.98
Phosgene	75445	0.99
Propionaldehyde	123386	0.99
Propylene dichloride (1,2-Dichloropropane)	78875	0.99
Propylene oxide	75569	0.99
Styrene	100425	0.99
Tetrachloroethane (1,1,2,2-)	79345	0.99
Tetrachloroethylene (Perchloroethylene)	127184	0.99
Toluene	108883	0.99
Toluidine (o-)	95534	0.44
Trichlorobenzene (1,2,4-)	120821	0.99
Trichloroethane (1,1,1-) (Methyl chloroform)	71556	0.99
Trichloroethane (1,1,2-) (Vinyl trichloride)	79005	0.99
Trichloroethylene	79016	0.99
Trichlorophenol (2,4,5-)	95954	0.96
Triethylamine	121448	0.99
Trimethylpentane (2,2,4-)	540841	0.99
Vinyl acetate	108054	0.99
Vinyl chloride (Chloroethylene)	75014	0.99
Vinylidene chloride (1,1-Dichloroethylene)	75354	0.99
Xylene (m-)	108383	0.99
Xylene (o-)	95476	0.99
Xylene (p-)	106423	0.99

^aCAS numbers refer to the Chemical Abstracts Service registry number assigned to specific compounds, isomers, or mixtures of compounds.

[59 FR 19468, Apr. 22, 1994, as amended at 71 FR 76615, Dec. 21, 2006]

Table 10 to Subpart G of Part 63—Wastewater—Compliance Options for Wastewater Tanks

Capacity (m ³)	Maximum true vapor pressure (kPa)	Control requirements
<75		§63.133(a)(1)
"75 and <151	<13.1	§63.133(a)(1)
	"13.1	§63.133(a)(2)
"151	<5.2	§63.133(a)(1)
	"5.2	§63.133(a)(2)

Table 11 to Subpart G of Part 63—Wastewater—Inspection and Monitoring Requirements for Waste Management Units

To comply with	Inspection or monitoring requirement	Frequency of inspection or monitoring	Method
Tanks:			
63.133 (b)(1)	Inspect fixed roof and all openings for leaks	Initially Semi-annually	Visual.
63.133 (c)	Inspect floating roof in accordance with §§63.120 (a)(2) and (a)(3)	See §63.120 (a)(2) and (a)(3)	Visual.
63.133 (d)	Measure floating roof seal gaps in accordance with §§63.120 (b)(2)(i) through (b)(4)		See §63.120 (b)(2)(i) through (b)(4).
	—Primary seal gaps	Once every 5 years Initially Annually	
	—Secondary seal gaps		
63.133(f) 63.133 (g)	Inspect wastewater tank for control equipment failures and improper work practices	Initially Semi-annually	Visual.
Surface impoundments:			
63.134 (b)(1)	Inspect cover and all openings for leaks	Initially Semi-annually	Visual.
63.134 (c)	Inspect surface impoundment for control equipment failures and improper work practices	Initially Semi-annually	Visual.
Containers:			

63.135 (b)(1), 63.135 (b)(2) (ii)	Inspect cover and all openings for leaks	Initially Semi-annually	Visual.
63.135 (d)(1)	Inspect enclosure and all openings for leaks	Initially Semi-annually	Visual.
63.135 (e)	Inspect container for control equipment failures and improper work practices	Initially Semi-annually	Visual.
Individual Drain Systems ^a :			
63.136 (b)(1)	Inspect cover and all openings to ensure there are no gaps, cracks, or holes	Initially Semi-annually	Visual.
63.136 (c)	Inspect individual drain system for control equipment failures and improper work practices	Initially Semi-annually	Visual.
63.136 (e)(1)	Verify that sufficient water is present to properly maintain integrity of water seals	Initially Semi-annually	Visual.
63.136 (e)(2), 63.136(f) (1)	Inspect all drains using tightly-fitted caps or plugs to ensure caps and plugs are in place and properly installed	Initially Semi-annually	Visual.
63.136(f) (2)	Inspect all junction boxes to ensure covers are in place and have no visible gaps, cracks, or holes	Initially Semi-annually	Visual or smoke test or other means as specified.
63.136(f) (3)	Inspect unburied portion of all sewer lines for cracks and gaps	Initially Semi-annually	Visual.
Oil-water separators:			
63.137 (b)(1)	Inspect fixed roof and all openings for leaks	Initially Semi-annually	Visual.
63.137 (c)	Measure floating roof seal gaps in accordance with 40 CFR 60.696(d)(1)	Initially ^b	See 40 CFR 60.696(d)(1).
	—Primary seal gaps	Once every 5	

		years	
63.137 (c)	—Secondary seal gaps	Initially ^b Annually	
63.137 (d)	Inspect oil-water separator for control equipment failures and improper work practices	Initially Semi-annually	Visual.

^aAs specified in §63.136(a), the owner or operator shall comply with either the requirements of §63.136 (b) and (c) or §63.136 (e) and (f).

^bWithin 60 days of installation as specified in §63.137(c).

Table 12 to Subpart G of Part 63—Monitoring Requirements for Treatment Processes

To comply with	Parameters to be monitored	Frequency	Methods
1. Required mass removal of Table 8 and/or Table 9 compound(s) from wastewater treated in a properly operated biological treatment unit, §63.138(f), and §63.138(g)	Appropriate parameters as specified in §63.143(c) and approved by permitting authority	Appropriate frequency as specified in §63.143 and approved by permitting authority	Appropriate methods as specified in §63.143 and as approved by permitting authority.
2. Steam stripper	(i) Steam flow rate; and	Continuously	Integrating steam flow monitoring device equipped with a continuous recorder.
	(ii) Wastewater feed mass flow rate; and	Continuously	Liquid flow meter installed at stripper influent and equipped with a continuous recorder.
	(iii) Wastewater feed temperature; or (iv) Column operating temperature	Continuously	(A) Liquid temperature monitoring device installed at stripper influent and equipped with a continuous or recorder; or (B) Liquid temperature

			monitoring device installed in the column top tray liquid phase (<i>i.e.</i> , at the downcomer) and equipped with a continuous recorder.
3. Other treatment processes or alternative monitoring parameters to those listed in item 2 of this table	Other parameters may be monitored upon approval from the Administrator with the requirements specified in §63.151(f)		

Table 13 to Subpart G of Part 63—Wastewater—Monitoring Requirements for Control Devices

Control Device	Monitoring equipment required	Parameters to be monitored	Frequency
All control devices	1. Flow indicator installed at all bypass lines to the atmosphere and equipped with continuous recorder ^b <i>or</i>	1. Presence of flow diverted from the control device to the atmosphere <i>or</i>	Hourly records of whether the flow indicator was operating and whether a diversion was detected at any time during each hour
	2. Valves sealed closed with car-seal or lock-and-key configuration	2. Monthly inspections of sealed valves	Monthly.
Thermal Incinerator	Temperature monitoring device installed in firebox or in ductwork immediately downstream of firebox ^a and equipped with a continuous recorder ^b	Firebox temperature	Continuous.
Catalytic	Temperature	1. Temperature	Continuous.

Incinerator	monitoring device installed in gas stream immediately before and after catalyst bed and equipped with a continuous recorder ^b	upstream of catalyst bed or 2. Temperature difference across catalyst bed	
Flare	Heat sensing device installed at the pilot light and equipped with a continuous recorder ^a	Presence of a flame at the pilot light	Hourly records of whether the monitor was continuously operating and whether the pilot flame was continuously present during each hour.
Boiler or process heater <44 megawatts and vent stream is not mixed with the primary fuel	Temperature monitoring device installed in firebox ^a and equipped with continuous recorder ^b	Combustion temperature	Continuous.
Condenser	Temperature monitoring device installed at condenser exit and equipped with continuous recorder ^b	Condenser exit (product side) temperature	Continuous.
Carbon adsorber (regenerative)	Integrating regeneration stream flow monitoring device having an accuracy of ± 10 percent, <i>and</i>	Total regeneration stream mass or volumetric flow during carbon bed regeneration cycle(s)	For each regeneration cycle, record the total regeneration stream mass or volumetric flow.
	Carbon bed temperature monitoring device	Temperature of carbon bed after regeneration [and within 15 minutes of completing any cooling cycle(s)]	For each regeneration cycle and within 15 minutes of completing any cooling cycle, record the carbon bed temperature.

Carbon adsorber (Non-regenerative)	Organic compound concentration monitoring device. ^c	Organic compound concentration of adsorber exhaust	Daily or at intervals no greater than 20 percent of the design carbon replacement interval, whichever is greater.
Alternative monitoring parameters	Other parameters may be monitored upon approval from the Administrator in accordance with the requirements in §63.143(e)(3)		

^aMonitor may be installed in the firebox or in the ductwork immediately downstream of the firebox before any substantial heat exchange is encountered.

^b“Continuous recorder” is defined in §63.111 of this subpart.

^cAs an alternative to conducting this monitoring, an owner or operator may replace the carbon in the carbon adsorption system with fresh carbon at a regular predetermined time interval that is less than the carbon replacement interval that is determined by the maximum design flow rate and organic concentration in the gas stream vented to the carbon adsorption system.

Tables 14–14b to Subpart G of Part 63 [Reserved]

Table 15 to Subpart G of Part 63—Wastewater—Information on Table 8 and/or Table 9 Compounds To Be Submitted With Notification of Compliance Status for Process Units at New and/or Existing Sources^{a,b}

Process unit identification code ^c	Stream identification code	Concentration of table 8 and/or table 9 compound(s) (ppmw) ^{d,e}	Flow rate (lpm) ^{e,f}	Group 1 or Group 2 ^g	Compliance approach ^h	Treatment process(es) identification ⁱ	Wa manag uni identifi

^aThe information specified in this table must be submitted; however, it may be submitted in any format. This table presents an example format.

^bOther requirements for the NCS are specified in §63.152(b) of this subpart.

^cAlso include a description of the process unit (e.g., benzene process unit).

^dExcept when §63.132(e) is used, annual average concentration as specified in §63.132 (c) or (d) and

§63.144.

^eWhen §63.132(e) is used, indicate the wastewater stream is a designated Group 1 wastewater stream.

^fExcept when §63.132(e) is used, annual average flow rate as specified in §63.132 (c) or (d) and in §63.144.

^gIndicate whether stream is Group 1 or Group 2. If Group 1, indicate whether it is Group 1 for Table 8 or Table 9 compounds or for both Table 8 and Table 9 compounds.

^hCite §63.138 compliance option used.

Table 16 to Subpart G of Part 63 [Reserved]

Table 17 to Subpart G of Part 63—Information for Treatment Processes To Be Submitted With Notification of Compliance Status^{a,b}

Treatment process identification ^c	Description ^d	Wastewater stream (s) treated ^e	Monitoring parameters ^f

^aThe information specified in this table must be submitted; however, it may be submitted in any format. This table presents an example format.

^bOther requirements for the Notification of Compliance Status are specified in §63.152(b) of this Subpart.

^cIdentification codes should correspond to those listed in Table 15.

^dDescription of treatment process.

^eStream identification code for each wastewater stream treated by each treatment unit. Identification codes should correspond to entries listed in Table 15.

^fParameter(s) to be monitored or measured in accordance with Table 12 and §63.143.

Table 18 to Subpart G of Part 63—Information for Waste Management Units To Be Submitted With Notification of Compliance Status^{a,b}

Waste management unit identification ^c	Description ^d	Wastewater stream(s) received or managed ^e

^aThe information specified in this table must be submitted; however, it may be submitted in any format. This table presents an example format.

^bOther requirements for the Notification of Compliance Status are specified in §63.152(b) of this Subpart.

^cIdentification codes should correspond to those listed in Table 15.

^dDescription of waste management unit.

^eStream identification code for each wastewater stream received or managed by each waste management unit. Identification codes should correspond to entries listed in Table 15.

Table 19 to Subpart G of Part 63—Wastewater—Information on Residuals To Be Submitted With Notification of Compliance Status^{a,b}

Residual identification ^c	Residual description ^d	Wastewater stream identification ^e	Treatment process ^f	Fate ^g	Control device identification code	Control device description ^h	Control device efficiency ⁱ

^aThe information specified in this table must be submitted; however, it may be submitted in any format. This table presents an example format.

^bOther requirements for the Notification of Compliance Status are specified in §63.152(b) of this subpart.

^cName or identification code of residual removed from Group 1 wastewater stream.

^dDescription of residual (e.g., steam stripper A-13 overhead condensates).

^eIdentification of stream from which residual is removed.

^fTreatment process from which residual originates.

^gIndicate whether residual is sold, returned to production process, or returned to waste management unit or treatment process; or whether HAP mass of residual is destroyed by 99 percent.

^hIf the fate of the residual is such that the HAP mass is destroyed by 99 percent, give description of device used for HAP destruction.

ⁱIf the fate of the residual is such that the HAP mass is destroyed by 99 percent, provide an estimate of control device efficiency and attach substantiation in accordance with §63.146(b)(9) of this subpart.

Table 20 to Subpart G of Part 63—Wastewater—Periodic Reporting Requirements for Control Devices Subject to §63.139 Used To Comply With §§63.13 Through 63.139

Control device	Reporting requirements
(1) Thermal Incinerator	Report all daily average ^a temperatures that are outside the range established in the

	NCS ^b or operating permit and all operating days when insufficient monitoring data are collected. ^c
(2) Catalytic Incinerator	(i) Report all daily average ^a upstream temperatures that are outside the range established in the NCS ^b or operating permit.
	(ii) Report all daily average ^a temperature differences across the catalyst bed that are outside the range established in the NCS ^b or operating permit.
	(iii) Report all operating days when insufficient monitoring data are collected. ^c
(3) Boiler or Process Heater with a design heat input capacity less than 44 megawatts and vent stream is not mixed with the primary fuel	Report all daily average ^a firebox temperatures that are outside the range established in the NCS ^b or operating permit and all operating days when insufficient monitoring data are collected. ^c
(4) Flare	Report the duration of all periods when all pilot flames are absent.
(5) Condenser	Report all daily average ^a exit temperatures that are outside the range established in the NCS ^b or operating permit and all operating days when insufficient monitoring data are collected. ^c
(6) Carbon Adsorber (Regenerative)	(i) Report all carbon bed regeneration cycles when the total regeneration stream mass or volumetric flow is outside the range established in the NCS ^b or operating permit.
	(ii) Report all carbon bed regeneration cycles during which the temperature of the carbon bed after regeneration is outside the range established in the NCS ^b or operating permit.
	(iii) Report all operating days when insufficient monitoring data are collected. ^c
(7) Carbon Adsorber (Non-Regenerative)	(i) Report all operating days when inspections not done according to the schedule developed as specified in table 13 of this subpart.
	(ii) Report all operating days when carbon has not been replaced at the frequency specified in table 13 of this subpart.
(8) All Control Devices	(i) Report the times and durations of all periods when the vent stream is diverted

	through a bypass line or the monitor is not operating, or
	(ii) Report all monthly inspections that show the valves are moved to the diverting position or the seal has been changed.

^aThe daily average is the average of all values recorded during the operating day, as specified in §63.147(d).

^bNCS = Notification of Compliance Status described in §63.152.

^cThe periodic reports shall include the duration of periods when monitoring data are not collected for each excursion as defined in §63.152(c)(2)(ii)(A).

Table 21 to Subpart G of Part 63—Average Storage Temperature (T_s) as a Function of Tank Paint Color

Tank Color	Average Storage Temperature (T_s)
White	$T_A^a = 0$
Aluminum	$T_A = 2.5$
Gray	$T_A = 3.5$
Black	$T_A = 5.0$

^a T_A is the average annual ambient temperature in degrees Fahrenheit.

Table 22 to Subpart G of Part 63—Paint Factors for Fixed Roof Tanks

Tank color		Paint factors (F_p) Paint Condition	
Roof	Shell	Good	Poor
White	White	1.00	1.15
Aluminum (specular)	White	1.04	1.18
White	Aluminum (specular)	1.16	1.24
Aluminum (specular)	Aluminum (specular)	1.20	1.29
White	Aluminum (diffuse)	1.30	1.38
Aluminum (diffuse)	Aluminum (diffuse)	1.39	1.46
White	Gray	1.30	1.38
Light gray	Light gray	1.33	1.44
Medium gray	Medium gray	1.40	1.58

Table 23 to Subpart G of Part 63—Average Clingage Factors (c)^a

	Shell condition
--	-----------------

Liquid	Light rust ^b	Dense rust	Gunitite lined
Gasoline	0.0015	0.0075	0.15
Single component stocks	0.0015	0.0075	0.15
Crude oil	0.0060	0.030	0.60

^aUnits for average clingage factors are barrels per 1,000 square feet.

^bIf no specific information is available, these values can be assumed to represent the most common condition of tanks currently in use.

Table 24 to Subpart G of Part 63—Typical Number of Columns as a Function of Tank Diameter for Internal Floating Roof Tanks With Column Supported Fixed Roofs^a

Tank diameter range (D in feet)	Typical number of columns, (N _C)
0 < D ≤ 85	1
85 < D ≤ 100	6
100 < D ≤ 120	7
120 < D ≤ 135	8
135 < D ≤ 150	9
150 < D ≤ 170	16
170 < D ≤ 190	19
190 < D ≤ 220	22
220 < D ≤ 235	31
235 < D ≤ 270	37
270 < D ≤ 275	43
275 < D ≤ 290	49
290 < D ≤ 330	61
330 < D ≤ 360	71
360 < D ≤ 400	81

^aData in this table should not supersede information on actual tanks.

Table 25 to Subpart G of Part 63—Effective Column Diameter (F_c)

Column type	F _c (feet)
9-inch by 7-inch built-up columns	1.1
8-inch-diameter pipe columns	0.7
No construction details known	1.0

Table 26 to Subpart G of Part 63—Seal Related Factors for Internal Floating Roof Vessels

Seal type	K _S	n
Liquid mounted resilient seal:		
Primary seal only	3.0	0
With rim-mounted secondary seal ^a	1.6	0
Vapor mounted resilient seal:		
Primary seal only	6.7	0
With rim-mounted secondary seal ^a	2.5	0

^aIf vessel-specific information is not available about the secondary seal, assume only a primary seal is present.

Table 27 to Subpart G of Part 63—Summary of Internal Floating Deck Fitting Loss Factors (K_F) and Typical Number of Fittings (N_F)

Deck fitting type	Deck fitting loss factor (K _F) a	Typical number of fittings (N _F)
Access hatch		1.
Bolted cover, gasketed	1.6	
Unbolted cover, gasketed	11	
Unbolted cover, ungasketed	^b 25	
Automatic gauge float well		1.
Bolted cover, gasketed	5.1	
Unbolted cover, gasketed	15	
Unbolted cover, ungasketed	^b 28	
Column well		(see Table 24).
Builtup column-sliding cover, gasketed	33	
Builtup column-sliding cover, ungasketed	^b 47 10	
Pipe column-flexible fabric sleeve seal	19	
Pipe column-sliding cover, gasketed	32	
Pipe column-sliding cover, ungasketed		
Ladder well		1.
Sliding cover, gasketed	56	
Sliding cover, ungasketed	^b 76	
Roof leg or hanger well		$(5+D/10+D^2/600)^c$.

Adjustable	^b 7.9	
Fixed	0	
Sample pipe or well		1.
Slotted pipe-sliding cover, gasketed	44	
Slotted pipe-sliding cover, ungasketed	57	
Sample well-slit fabric seal, 10 percent open area	^b 12	
Stub drain, 1-in diameter ^d	1.2	(D ² /125) ^c .
Vacuum breaker		1.
Weighted mechanical actuation, gasketed	^b 0.7	
Weighted mechanical actuation, ungasketed	0.9	

^aUnits for K_p are pound-moles per year.

^bIf no specific information is available, this value can be assumed to represent the most common/typical deck fittings currently used.

^cD=Tank diameter (feet).

^dNot used on welded contact internal floating decks.

Table 28 to Subpart G of Part 63—Deck Seam Length Factors^a (S_D) for Internal Floating Roof Tanks

Deck construction	Typical deck seam length factor
Continuous sheet construction ^b :	
5-foot wide sheets	0.2 ^c
6-foot wide sheets	0.17
7-foot wide sheets	0.14
Panel construction ^d :	
5 × 7.5 feet rectangular	0.33
5 × 12 feet rectangular	0.28

^aDeck seam loss applies to bolted decks only. Units for S^D are feet per square feet.

^bS_D=1/W, where W = sheet width (feet).

^cIf no specific information is available, these factors can be assumed to represent the most common bolted decks currently in use.

^dS_D=(L+W)/LW, where W = panel width (feet), and L = panel length (feet).

Table 29 to Subpart G of Part 63—Seal Related Factors for External Floating Roof Vessels

Seal type	Welded vessels		Riveted vessels	
	K _S	N	K _S	N
Metallic shoe seal:				
Primary seal only	1.2	1.5	1.3	1.5
With shoe-mounted secondary seal	0.8	1.2	1.4	1.2
With rim-mounted secondary seal	0.2	1.0	0.2	1.6
Liquid mounted resilient seal:				
Primary seal only	1.1	1.0	^a NA	NA
With weather shield	0.8	0.9	NA	NA
With rim-mounted secondary seal	0.7	0.4	NA	NA
Vapor mounted resilient seal:				
Primary seal only	1.2	2.3	NA	NA
With weather shield	0.9	2.2	NA	NA
With rim-mounted secondary seal	0.2	2.6	NA	NA

^aNA=Not applicable.

Table 30 to Subpart G of Part 63—Roof Fitting Loss Factors, K_{Fa}, K_{Fb}, and m,^a and Typical Number of Fittings, N_T

Fitting type and construction details	Loss factors ^b			Typical number of fittings, N _T
	K _{Fa} (lb-mole/yr)	K _{Fb} (lb-mole/[mi/hr]m-yr)	m (dimensionless)	
Access hatch (24-in-diameter well)				1.
Bolted cover, gasketed	0	0	^c 0	
Unbolted cover, ungasketed	2.7	7.1	1.0	
Unbolted cover, gasketed	2.9	0.41	1.0	
Unslotted guide-pole well (8-in-diameter unslotted pole, 21-in-diameter well)				1.

Ungasketed sliding cover	0	67	^c 0.98	
Gasketed sliding cover	0	3.0	1.4	
Slotted guide-pole/sample well (8-in-diameter unslotted pole, 21-in-diameter well)				(^d).
Ungasketed sliding cover, without float	0	310	1.2	
Ungasketed sliding cover, with float	0	29	2.0	
Gasketed sliding cover, without float	0	260	1.2	
Gasketed sliding cover, with float	0	8.5	1.4	
Gauge-float well (20-inch diameter)				1.
Unbolted cover, ungasketed	2.3	5.9	^c 1.0	
Unbolted cover, gasketed	2.4	0.34	1.0	
Bolted cover, gasketed	0	0	0	
Gauge-hatch/sample well (8-inch diameter)				1.
Weighted mechanical actuation, gasketed	0.95	0.14	^c 1.0	
Weighted mechanical actuation, ungasketed	0.91	2.4	1.0	
Vacuum breaker (10-in-diameter well)				N _{F6} (Table 31).
Weighted mechanical actuation, gasketed	1.2	0.17	^c 1.0	
Weighted mechanical actuation,	1.2	3.0	1.0	

ungasketed				
Roof drain (3-in-diameter)				N_{F7} (Table 31).
Open	0	7.0	^e 1.4	N_{F8} (Table 32 ^f).
90 percent closed	0.51	0.81	1.0	
Roof leg (3-in-diameter)				N_{F8} (Table 32 ^f).
Adjustable, pontoon area	1.5	0.20	^c 1.0	
Adjustable, center area	0.25	0.067	^c 1.0	
Adjustable, double-deck roofs	0.25	0.067	1.0	
Fixed	0	0	0	
Roof leg (2 1/2-in-diameter)				N_{F8} (Table 32 ^f).
Adjustable, pontoon area	1.7	0	0	
Adjustable, center area	0.41	0	0	
Adjustable, double-deck roofs	0.41	0	0	
Fixed	0	0	0	
Rim vent (6-in-diameter)				^g 19.
Weighted mechanical actuation, gasketed	0.71	0.10	^c 1.0	
Weighted mechanical actuation, ungasketed	0.68	1.8	1.0	

^aThe roof fitting loss factors, K_{Fa} , K_{Fb} , and m , may only be used for wind speeds from 2 to 15 miles per hour.

^bUnit abbreviations are as follows: lb = pound; mi = miles; hr = hour; yr = year.

^cIf no specific information is available, this value can be assumed to represent the most common or typical roof fittings currently in use.

^dA slotted guide-pole/sample well is an optional fitting and is not typically used.

^eRoof drains that drain excess rainwater into the product are not used on pontoon floating roofs. They are, however, used on double-deck floating roofs and are typically left open.

^fThe most common roof leg diameter is 3 inches. The loss factors for 2 1/2-inch diameter roof legs are provided for use if this smaller size roof is used on a particular floating roof.

^gRim vents are used only with mechanical-shoe primary seals.

Table 31 to Subpart G of Part 63—Typical Number of Vacuum Breakers, N_{F6} and Roof Drains,^a N_{F7}

Tank diameter D (feet) ^b	No. of vacuum breakers, N_{F6}		No. of roof drains, N_{F7} double-deck roof ^c
	Pontoon roof	Double-deck roof	
50	1	1	1
100	1	1	1
150	2	2	2
200	3	2	3
250	4	3	5
300	5	3	7
350	6	4	d
400	7	4	d

^aThis table should not supersede information based on actual tank data.

^bIf the actual diameter is between the diameters listed, the closest diameter listed should be used. If the actual diameter is midway between the diameters listed, the next larger diameter should be used.

^cRoof drains that drain excess rainwater into the product are not used on pontoon floating roofs. They are, however, used on double-deck floating roofs, and are typically left open.

^dFor tanks more than 300 feet in diameter, actual tank data or the manufacturer's recommendations may be needed for the number of roof drains.

Table 32 to Subpart G of Part 63—Typical Number of Roof Legs,^a N_{F8}

Tank diameter D (feet) ^b	Pontoon roof		No. of legs on double-deck roof
	No. of pontoon legs	No. of center legs	
30	4	2	6
40	4	4	7
50	6	6	8
60	9	7	10
70	13	9	13

80	15	10	16
90	16	12	20
100	17	16	25
110	18	20	29
120	19	24	34
130	20	28	40
140	21	33	46
150	23	38	52
160	26	42	58
170	27	49	66
180	28	56	74
190	29	62	82
200	30	69	90
210	31	77	98
220	32	83	107
230	33	92	115
240	34	101	127
250	34	109	138
260	36	118	149
270	36	128	162
280	37	138	173
290	38	148	186
300	38	156	200
310	39	168	213
320	39	179	226
330	40	190	240
340	41	202	255
350	42	213	270
360	44	226	285
370	45	238	300
380	46	252	315
390	47	266	330
400	48	281	345

^aThis table should not supersede information based on actual tank data.

^bIf the actual diameter is between the diameters listed, the closest diameter listed should be used. If the actual diameter is midway between the diameters listed, the next larger diameter should be used.

Table 33 to Subpart G of Part 63—Saturation Factors

	S
--	----------

Cargo carrier	Mode of operation	factor
Tank trucks and rail tank cars	Submerged loading of a clean cargo tank	0.50
	Submerged loading: dedicated normal service	0.60
	Submerged loading: dedicated vapor balance service	1.00
	Splash loading of a clean cargo tank	1.45
	Splash loading: dedicated normal service	1.45
	Splash loading: dedicated vapor balance service	1.00

Table 34 to Subpart G of Part 63—Fraction Measured (F_m) and Fraction Emitted (F_e) For HAP Compounds in Wastewater Streams

Chemical name	CAS Number ^a	F_m	F_e
Acetaldehyde	75070	1.00	0.48
Acetonitrile	75058	0.99	0.36
Acetophenone	98862	0.31	0.14
Acrolein	107028	1.00	0.43
Acrylonitrile	107131	1.00	0.43
Allyl chloride	107051	1.00	0.89
Benzene	71432	1.00	0.80
Benzyl chloride	100447	1.00	0.47
Biphenyl	92524	0.86	0.45
Bromoform	75252	1.00	0.49
Butadiene (1,3-)	106990	1.00	0.98
Carbon disulfide	75150	1.00	0.92
Carbon tetrachloride	56235	1.00	0.94
Chlorobenzene	108907	1.00	0.73
Chloroform	67663	1.00	0.78
Chloroprene (2-Chloro-1,3-butadiene)	126998	1.00	0.68
Cumene	98828	1.00	0.88
Dichlorobenzene (p-)	106467	1.00	0.72
Dichloroethane (1,2-) (Ethylene dichloride)	107062	1.00	0.64
Dichloroethyl ether (Bis(2-Chloroethyl ether))	111444	0.76	0.21
Dichloropropene (1,3-)	542756	1.00	0.76
Diethyl sulfate	64675	0.0025	0.11
Dimethyl sulfate	77781	0.086	0.079
Dimethylaniline (N,N-)	121697	0.00080	0.34
Dimethylhydrazine (1,1-)	57147	0.38	0.054

Dinitrophenol (2,4-)	51285	0.0077	0.060
Dinitrotoluene (2,4-)	121142	0.085	0.18
Dioxane (1,4-) (1,4-Diethyleneoxide)	123911	0.87	0.18
Epichlorohydrin(1-Chloro-2,3-epoxypropane)	106898	0.94	0.35
Ethyl acrylate	140885	1.00	0.48
Ethylbenzene	100414	1.00	0.83
Ethyl chloride (Chloroethane)	75003	1.00	0.90
Ethylene dibromide (Dibromomethane)	106934	1.00	0.57
Ethylene glycol dimethyl ether	110714	0.86	0.32
Ethylene glycol monobutyl ether acetate	112072	0.043	0.067
Ethylene glycol monomethyl ether acetate	110496	0.093	0.048
Ethylene oxide	75218	1.00	0.50
Ethylidene dichloride (1,1-Dichloroethane)	75343	1.00	0.79
Hexachlorobenzene	118741	0.97	0.64
Hexachlorobutadiene	87683	0.88	0.86
Hexachloroethane	67721	0.50	0.85
Hexane	110543	1.00	1.00
Isophorone	78591	0.51	0.11
Methanol	67561	0.85	0.17
Methyl bromide (Bromomethane)	74839	1.00	0.85
Methyl chloride (Chloromethane)	74873	1.00	0.84
Methyl isobutyl ketone (Hexone)	108101	0.98	0.53
Methyl methacrylate	80626	1.00	0.37
Methyl tert-butyl ether	1634044	1.00	0.57
Methylene chloride (Dichloromethane)	75092	1.00	0.77
Naphthalene	91203	0.99	0.51
Nitrobenzene	98953	0.39	0.23
Nitropropane (2-)	79469	0.99	0.44
Phosgene	75445	1.00	0.87
Propionaldehyde	123386	1.00	0.41
Propylene dichloride (1,2-Dichloropropane)	78875	1.00	0.72
Propylene oxide	75569	1.00	0.60
Styrene	100425	1.00	0.80
Tetrachloroethane (1,1,2,2-)	79345	1.00	0.46
Tetrachloroethylene (Perchloroethylene)	127184	1.00	0.92
Toluene	108883	1.00	0.80
Toluidine (o-)	95534	0.15	0.052
Trichlorobenzene (1,2,4-)	120821	1.00	0.64
Trichloroethane (1,1,1-) (Methyl chloroform)	71556	1.00	0.91
Trichloroethane (1,1,2-) (Vinyl Trichloride)	79005	1.00	0.60

Trichloroethylene	79016	1.00	0.87
Trichlorophenol (2,4,5-)	95954	0.11	0.086
Triethylamine	121448	1.00	0.38
Trimethylpentane (2,2,4-)	540841	1.00	1.00
Vinyl acetate	108054	1.00	0.59
Vinyl chloride (Chloroethylene)	75014	1.00	0.97
Vinylidene chloride (1,1-Dichloroethylene)	75354	1.00	0.94
Xylene (m-)	108383	1.00	0.82
Xylene (o-)	95476	1.00	0.79
Xylene (p-)	106423	1.00	0.82

^aCAS numbers refer to the Chemical Abstracts Service registry number assigned to specific compounds, isomers, or mixtures of compounds.

[59 FR 19468, Apr. 22, 1994, as amended at 71 FR 76615, Dec. 21, 2006]

Table 35 to Subpart G of Part 63—Control Requirements for Items of Equipment That Meet the Criteria of §63.149 of Subpart G

Item of equipment	Control requirement ^a
Drain or drain hub	(a) Tightly fitting solid cover (TFSC); or (b) TFSC with a vent to either a process, or to a fuel gas system, or to a control device meeting the requirements of §63.139(c); or (c) Water seal with submerged discharge or barrier to protect discharge from wind.
Manhole ^b	(a) TFSC; or (b) TSFC with a vent to either a process, or to a fuel gas system, or to a control device meeting the requirements of §63.139(c); or (c) If the item is vented to the atmosphere, use a TFSC with a properly operating water seal at the entrance or exit to the item to restrict ventilation in the collection system. The vent pipe shall be at least 90 cm in length and not exceeding 10.2 cm in nominal inside diameter.
Lift station	(a) TFSC; or (b) TFSC with a vent to either a process, or to a fuel gas system, or to a control device meeting the requirements of §63.139(c); or (c) If the lift station is vented to the atmosphere, use a TFSC with a properly operating water seal at the entrance or exit to the item to restrict ventilation in the collection system. The vent pipe shall be at least 90 cm in length and not exceeding 10.2 cm in nominal inside diameter. The lift station shall be level controlled to minimize changes in the liquid level.
Trench	(a) TFSC; or

	(b) TFSC with a vent to either a process, or to a fuel gas system, or to a control device meeting the requirements of §63.139(c); or (c) If the item is vented to the atmosphere, use a TFSC with a properly operating water seal at the entrance or exit to the item to restrict ventilation in the collection system. The vent pipe shall be at least 90 cm in length and not exceeding 10.2 cm in nominal inside diameter.
Pipe	Each pipe shall have no visible gaps in joints, seals, or other emission interfaces.
Oil/Water separator	(a) Equip with a fixed roof and route vapors to a process or to a fuel gas system, or equip with a closed vent system that routes vapors to a control device meeting the requirements of §63.139 (c); or (b) Equip with a floating roof that meets the equipment specifications of §60.693 (a)(1)(i), (a)(1)(ii), (a)(2), (a)(3), and (a)(4).
Tank ^c	Maintain a fixed roof. ^d If the tank is sparged ^e or used for heating or treating by means of an exothermic reaction, a fixed roof and a system shall be maintained that routes the organic hazardous air pollutants vapors to other process equipment or a fuel gas system, or a closed vent system that routes vapors to a control device that meets the requirements of 40 CFR §63.119 (e)(1) or (e)(2).

^aWhere a tightly fitting solid cover is required, it shall be maintained with no visible gaps or openings, except during periods of sampling, inspection, or maintenance.

^bManhole includes sumps and other points of access to a conveyance system.

^cApplies to tanks with capacities of 38 m³or greater.

^dA fixed roof may have openings necessary for proper venting of the tank, such as pressure/vacuum vent, j-pipe vent.

^eThe liquid in the tank is agitated by injecting compressed air or gas.

Table 36 to Subpart G of Part 63—Compound Lists Used for Compliance Demonstrations for Enhanced Biological Treatment Processes (See §63.145(h))

List 1	List 2
Acetonitrile	Acetaldehyde.
Acetophenone	Acrolein.
Acrylonitrile	Allyl Chloride.
Biphenyl	Benzene.
Chlorobenzene	Benzyl Chloride,
Dichloroethyl Ether	Bromoform.

Diethyl Sulfate	Bromomethane.
Dimethyl Sulfate	Butadiene 1,3.
Dimethyl Hydrazine 1,1	Carbon Disulfide.
Dinitrophenol 2,4	Carbon Tetrachloride
Dinitrotoluene 2,4	Chloroethane (ethyl chloride).
Dioxane 1,4	Chloroform.
Ethylene Glycol Monobutyl Ether Acetate	Chloroprene.
Ethylene Glycol Monomethyl Ether Acetate	Cumene (isopropylbenzene).
Ethylene Glycol Dimethyl Ether	Dibromoethane 1,2.
Hexachlorobenzene	Dichlorobenzene 1,4.
Isophorone	Dichloroethane 1,2.
Methanol	Dichloroethane 1,1 (ethylidene dichloride).
Methyl Methacrylate	Dichloroethene 1,1 (vinylidene chloride).
Nitrobenzene	Dichloropropane 1,2.
Toluidine	Dichloropropene 1,3.
Trichlorobenzene 1,2,4.	Dimethylaniline N,N.
Trichlorophenol 2,4,6	Epichlorohydrin.
Triethylamine	Ethyl Acrylate.
	Ethylbenzene.
	Ethylene Oxide.
	Ethylene Dibromide.
	Hexachlorobutadiene.
	Hexachloroethane.
	Hexane-n.
	Methyl Isobutyl Ketone.
	Methyl Tertiary Butyl Ether.
	Methyl Chloride.
	Methylene Chloride (dichloromethane).
	Naphthalene.
	Nitropropane 2
	Phosgene.
	Propionaldehyde.
	Propylene Oxide.
	Styrene.
	Tetrachloroethane 1,1,2,2.
	Toluene Trichloroethane 1,1,1 (methyl chloroform).
	Trichloroethane 1,1,2.

	Trichloroethylene.
	Trimethylpentane 2,2,4.
	Vinyl Chloride.
	Vinyl Acetate.
	Xylene-m.
	Xylene-o.
	Xylene-p.

[59 FR 19468, Apr. 22, 1994, as amended at 71 FR 76615, Dec. 21, 2006]

Table 37 to Subpart G of Part 63—Default Biorates for List 1 Compounds

Compound name	Biorate, K1 L/g MLVSS-hr
Acetonitrile	0.100
Acetophenone	0.538
Acrylonitrile	0.750
Biphenyl	5.643
Chlorobenzene	10.000
Dichloroethyl ether	0.246
Diethyl sulfate	0.105
Dimethyl hydrazine(1,1)	0.227
DIMethyl sulfate	0.178
Dinitrophenol 2,4	0.620
Dinitrotoluene(2,4)	0.784
Dioxane(1,4)	0.393
Ethylene glycol dimethyl ether	0.364
Ethylene glycol monomethyl ether acetate	0.159
Ethylene glycol monobutyl ether acetate	0.496
Hexachlorobenzene	16.179
ISophorone	0.598
Methanol	0.200
Methyl methacrylate	4.300
Nitrobenzene	2.300
Toluidine (-0)	0.859
Trichlorobenzene 1,2,4	4.393
Trichlorophenol 2,4,5	4.477
Triethylamine	1.064

Figure 1 to Subpart G of Part 63—Definitions of Terms Used in Wastewater Equations

Main Terms

AMR=Actual mass removal of Table 8 and/or Table 9 compounds achieved by treatment process or a series of treatment processes, kg/hr.

C=Concentration of Table 8 and/or Table 9 compounds in wastewater, ppmw.

CG=Concentration of TOC (minus methane and ethane) or total organic hazardous air pollutants, in vented gas stream, dry basis, ppmv.

CG_c =Concentration of TOC or organic hazardous air pollutants corrected to 3-percent oxygen, in vented gas stream, dry basis, ppmv.

CGS=Concentration of sample compounds in vented gas stream, dry basis, ppmv.

E=Removal or destruction efficiency, percent.

F_{bio} =Site-specific fraction of Table 8 and/or Table 9 compounds biodegraded, unitless.

f^{bio} =Site-specific fraction of an individual Table 8 or Table 9 compound biodegraded, unitless.

Fm=Compound-specific fraction measured factor, unitless (listed in table 34).

Fr=Fraction removal value for Table 8 and/or Table 9 compounds, unitless (listed in Table 9).

Fr_{avg} =Flow-weighted average of the Fr values.

i=Identifier for a compound.

j=Identifier for a sample.

k=Identifier for a run.

K_2 =Constant, $41.57 * 10^{-9}$, (ppm)⁻¹(gram-mole per standard m³) (kg/g), where standard temperature (gram-mole per standard m³) is 20 °C.

m=Number of samples.

M=Mass, kg.

MW=Molecular weight, kg/kg-mole.

n=Number of compounds.

p=Number of runs.

%O_{2d}=Concentration of oxygen, dry basis, percent by volume.

Q=Volumetric flowrate of wastewater, m³/hr.

QG=Volumetric flow rate of vented gas stream, dry standard, m³/min.

QMG=Mass flowrate of TOC (minus methane and ethane) or organic hazardous air pollutants, in vented gas stream, kg/hr.

QMW=Mass flowrate of Table 8 and/or Table 9 compounds in wastewater, kg/hr.

ρ =Density, kg/m³.

RMR=Required mass removal achieved by treatment process or a series of treatment processes, kg/hr.

t_T =Total time of all runs, hr.

Subscripts

a=Entering.

b=Exiting.

i=Identifier for a compound.

j=Identifier for a sample.

k=Identifier for a run.

m=Number of samples.

n=Number of compounds.

p=Number of runs.

T=Total; sum of individual.

[59 FR 19468, Apr. 22, 1994, as amended at 59 FR 29201, June 6, 1994; 61 FR 63629–63630, Dec. 12, 1995; 62 FR 2779, Jan. 17, 1997; 63 FR 67793, Dec. 9, 1998; 64 FR 20195, Apr. 26, 1999; 65 FR 78284, Dec. 14, 2000; 66 FR 6935, Jan. 22, 2001]

[Browse Previous](#) | [Browse Next](#)

For questions or comments regarding e-CFR editorial content, features, or design, email ecfr@nara.gov.

For questions concerning e-CFR programming and delivery issues, email webteam@gpo.gov.

[Section 508 / Accessibility](#)

[Home Page](#) > [Executive Branch](#) > [Code of Federal Regulations](#) > [Electronic Code of Federal Regulations](#)

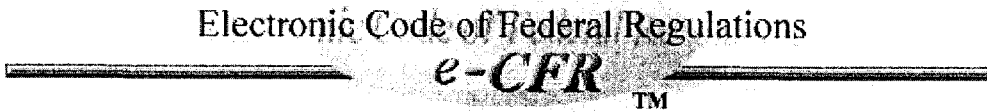

e-CFR Data is current as of August 1, 2007

Title 40: Protection of Environment

PART 63—NATIONAL EMISSION STANDARDS FOR HAZARDOUS AIR POLLUTANTS FOR SOURCE CATEGORIES

[Browse Previous](#) | [Browse Next](#)

Subpart H—National Emission Standards for Organic Hazardous Air Pollutants for Equipment Leaks

Source: 59 FR 19568, Apr. 22, 1994, unless otherwise noted.

§ 63.160 Applicability and designation of source.

(a) The provisions of this subpart apply to pumps, compressors, agitators, pressure relief devices, sampling connection systems, open-ended valves or lines, valves, connectors, surge control vessels, bottoms receivers, instrumentation systems, and control devices or closed vent systems required by this subpart that are intended to operate in organic hazardous air pollutant service 300 hours or more during the calendar year within a source subject to the provisions of a specific subpart in 40 CFR part 63 that references this subpart.

(b) After the compliance date for a process unit, equipment to which this subpart applies that are also subject to the provisions of:

(1) 40 CFR part 60 will be required to comply only with the provisions of this subpart.

(2) 40 CFR part 61 will be required to comply only with the provisions of this subpart.

(c) If a process unit subject to the provisions of this subpart has equipment to which this subpart does not apply, but which is subject to a standard identified in paragraph (c)(1), (c)(2), or (c)(3) of this section, the owner or operator may elect to apply this subpart to all such equipment in the process unit. If the owner or operator elects this method of compliance, all VOC in such equipment shall be considered, for purposes of applicability and compliance with this subpart, as if it were organic hazardous air pollutant (HAP). Compliance with the provisions of this subpart, in the manner described in this paragraph, shall be deemed to constitute compliance with the standard identified in paragraph (c)(1), (c)(2), or (c)(3) of this section.

(1) 40 CFR part 60, subpart VV, GGG, or KKK; (2) 40 CFR part 61, subpart F or J; or (3) 40 CFR part 264, subpart BB or 40 CFR part 265, subpart BB.

(2) [Reserved]

(d) The provisions in §63.1(a)(3) of subpart A of this part do not alter the provisions in paragraph (b) of this section.

(e) Except as provided in any subpart that references this subpart, lines and equipment not containing

process fluids are not subject to the provisions of this subpart. Utilities, and other non-process lines, such as heating and cooling systems which do not combine their materials with those in the processes they serve, are not considered to be part of a process unit.

(f) The provisions of this subpart do not apply to research and development facilities or to bench-scale batch processes, regardless of whether the facilities or processes are located at the same plant site as a process subject to the provisions of this subpart.

(g) *Alternative means of compliance* —(1) *Option to comply with part 65.* Owners or operators of CMPU that are subject to §63.100 may choose to comply with the provisions of 40 CFR part 65 for all Group 1 and Group 2 process vents, Group 1 storage vessels, Group 1 transfer operations, and equipment that are subject to §63.100, that are part of the CMPU. Other provisions applying to an owner or operator who chooses to comply with 40 CFR part 65 are provided in 40 CFR 65.1.

(i) For equipment, 40 CFR part 65 satisfies the requirements of §§63.102, 63.103, and 63.162 through 63.182. When choosing to comply with 40 CFR part 65, the requirements of §63.180(d) continue to apply.

(ii) For Group 1 and Group 2 process vents, Group 1 storage vessels, and Group 1 transfer operations, comply with §63.110(i)(1).

(2) *Part 65, subpart C or F.* For owners or operators choosing to comply with 40 CFR part 65, each surge control vessel and bottoms receiver subject to §63.100 that meets the conditions specified in table 2 or table 3 of this subpart shall meet the requirements for storage vessels in 40 CFR part 65, subpart C; all other equipment subject to §63.100 shall meet the requirements in 40 CFR part 65, subpart F.

(3) *Part 63, subpart A.* Owners or operators who choose to comply with 40 CFR part 65, subpart C or F, for equipment subject to §63.100 must also comply with the applicable general provisions of this part 63 listed in table 4 of this subpart. All sections and paragraphs of subpart A of this part that are not mentioned in table 4 of this subpart do not apply to owners or operators of equipment subject to §63.100 of subpart F complying with 40 CFR part 65, subpart C or F, except that provisions required to be met prior to implementing 40 CFR part 65 still apply. Owners and operators who choose to comply with 40 CFR part 65, subpart C or F, must comply with 40 CFR part 65, subpart A.

[59 FR 19568, Apr. 22, 1994, as amended at 59 FR 48176, Sept. 20, 1994; 59 FR 53360, Oct. 24, 1994; 60 FR 18029, Apr. 10, 1995; 61 FR 31439, June 20, 1996; 64 FR 20198, Apr. 26, 1999; 65 FR 78285, Dec. 14, 2000]

§ 63.161 Definitions.

All terms used in this subpart shall have the meaning given them in the Act and in this section as follows, except as provided in any subpart that references this subpart.

Batch process means a process in which the equipment is fed intermittently or discontinuously. Processing then occurs in this equipment after which the equipment is generally emptied. Examples of industries that use batch processes include pharmaceutical production and pesticide production.

Batch product-process equipment train means the collection of equipment (e.g., connectors, reactors, valves, pumps, etc.) configured to produce a specific product or intermediate by a batch process.

Bench-scale batch process means a batch process (other than a research and development facility) that is operated on a small scale, such as one capable of being located on a laboratory bench top. This bench-scale equipment will typically include reagent feed vessels, a small reactor and associated product separator, recovery and holding equipment. These processes are only capable of producing small quantities of product.

Bottoms receiver means a tank that collects distillation bottoms before the stream is sent for storage or for further downstream processing.

Closed-loop system means an enclosed system that returns process fluid to the process and is not

vented to the atmosphere except through a closed-vent system.

Closed-purge system means a system or combination of system and portable containers, to capture purged liquids. Containers must be covered or closed when not being filled or emptied.

Closed-vent system means a system that is not open to the atmosphere and that is composed of hard-piping, ductwork, connections and, if necessary, flow-inducing devices that transport gas or vapor from a piece or pieces of equipment to a control device or back into a process.

Combustion device means an individual unit of equipment, such as a flare, incinerator, process heater, or boiler, used for the combustion of organic hazardous air pollutant emissions.

Compliance date means the dates specified in §63.100(k) or §63.100(l)(3) of subpart F of this part for process units subject to subpart F of this part; the dates specified in §63.190(e) of subpart I of this part for process units subject to subpart I of this part. For sources subject to other subparts in 40 CFR part 63 that reference this subpart, compliance date will be defined in those subparts. However, the compliance date for §63.170 shall be no later than 3 years after the effective date of those subparts unless otherwise specified in such other subparts.

Connector means flanged, screwed, or other joined fittings used to connect two pipe lines or a pipe line and a piece of equipment. A common connector is a flange. Joined fittings welded completely around the circumference of the interface are not considered connectors for the purpose of this regulation. For the purpose of reporting and recordkeeping, connector means joined fittings that are not inaccessible, glass, or glass-lined as described in §63.174(h) of this subpart.

Control device means any equipment used for recovering, recapturing, or oxidizing organic hazardous air pollutant vapors. Such equipment includes, but is not limited to, absorbers, carbon adsorbers, condensers, flares, boilers, and process heaters.

Double block and bleed system means two block valves connected in series with a bleed valve or line that can vent the line between the two block valves.

Duct work means a conveyance system such as those commonly used for heating and ventilation systems. It is often made of sheet metal and often has sections connected by screws or crimping. Hard-piping is not ductwork.

Equipment means each pump, compressor, agitator, pressure relief device, sampling connection system, open-ended valve or line, valve, connector, surge control vessel, bottoms receiver, and instrumentation system in organic hazardous air pollutant service; and any control devices or systems required by this subpart.

First attempt at repair means to take action for the purpose of stopping or reducing leakage of organic material to the atmosphere, followed by monitoring as specified in §63.180 (b) and (c), as appropriate, to verify whether the leak is repaired, unless the owner or operator determines by other means that the leak is not repaired.

Flow indicator means a device which indicates whether gas flow is, or whether the valve position would allow gas flow to be, present in a line.

Fuel gas means gases that are combusted to derive useful work or heat.

Fuel gas system means the offsite and onsite piping and control system that gathers gaseous stream(s) generated by onsite operations, may blend them with other sources of gas, and transports the gaseous stream for use as fuel gas in combustion devices or in in-process combustion equipment such as furnaces and gas turbines, either singly or in combination.

Hard-piping means pipe or tubing that is manufactured and properly installed using good engineering judgement and standards, such as ANSI B31-3.

In food/medical service means that a piece of equipment in organic hazardous air pollutant service

contacts a process stream used to manufacture a Food and Drug Administration regulated product where leakage of a barrier fluid into the process stream would cause any of the following:

- (1) A dilution of product quality so that the product would not meet written specifications,
- (2) An exothermic reaction which is a safety hazard,
- (3) The intended reaction to be slowed down or stopped, or
- (4) An undesired side reaction to occur.

In gas/vapor service means that a piece of equipment in organic hazardous air pollutant service contains a gas or vapor at operating conditions.

In heavy liquid service means that a piece of equipment in organic hazardous air pollutant service is not in gas/vapor service or in light liquid service.

In light liquid service means that a piece of equipment in organic hazardous air pollutant service contains a liquid that meets the following conditions:

- (1) The vapor pressure of one or more of the organic compounds is greater than 0.3 kilopascals at 20 °C,
- (2) The total concentration of the pure organic compounds constituents having a vapor pressure greater than 0.3 kilopascals at 20 °C is equal to or greater than 20 percent by weight of the total process stream, and
- (3) The fluid is a liquid at operating conditions.

Note: Vapor pressures may be determined by the methods described in 40 CFR 60.485(e)(1).

In liquid service means that a piece of equipment in organic hazardous air pollutant service is not in gas/vapor service.

In organic hazardous air pollutant or in organic HAP service means that a piece of equipment either contains or contacts a fluid (liquid or gas) that is at least 5 percent by weight of total organic HAP's as determined according to the provisions of §63.180(d) of this subpart. The provisions of §63.180(d) of this subpart also specify how to determine that a piece of equipment is not in organic HAP service.

In vacuum service means that equipment is operating at an internal pressure which is at least 5 kilopascals below ambient pressure.

In volatile organic compound or in VOC service means, for the purposes of this subpart, that:

- (1) The piece of equipment contains or contacts a process fluid that is at least 10 percent VOC by weight (see 40 CFR 60.2 for the definition of VOC, and 40 CFR 60.485(d) to determine whether a piece of equipment is not in VOC service); and
- (2) The piece of equipment is not in heavy liquid service as defined in 40 CFR 60.481.

In-situ sampling systems means nonextractive samplers or in-line samplers.

Initial start-up means the first time a new or reconstructed source begins production. Initial start-up does not include operation solely for testing equipment. Initial start-up does not include subsequent start-ups (as defined in this section) of process units following malfunctions or process unit shutdowns.

Instrumentation system means a group of equipment components used to condition and convey a sample of the process fluid to analyzers and instruments for the purpose of determining process

operating conditions (e.g., composition, pressure, flow, etc.). Valves and connectors are the predominant type of equipment used in instrumentation systems; however, other types of equipment may also be included in these systems. Only valves nominally 0.5 inches and smaller, and connectors nominally 0.75 inches and smaller in diameter are considered instrumentation systems for the purposes of this subpart. Valves greater than nominally 0.5 inches and connectors greater than nominally 0.75 inches associated with instrumentation systems are not considered part of instrumentation systems and must be monitored individually.

Liquids dripping means any visible leakage from the seal including dripping, spraying, misting, clouding, and ice formation. Indications of liquid dripping include puddling or new stains that are indicative of an existing evaporated drip.

Nonrepairable means that it is technically infeasible to repair a piece of equipment from which a leak has been detected without a process unit shutdown.

On-site or On site means, with respect to records required to be maintained by this subpart, that the records are stored at a location within a major source which encompasses the affected source. On-site includes, but is not limited to, storage at the chemical manufacturing process unit to which the records pertain, or storage in central files elsewhere at the major source.

Open-ended valve or line means any valve, except pressure relief valves, having one side of the valve seat in contact with process fluid and one side open to atmosphere, either directly or through open piping.

Plant site means all contiguous or adjoining property that is under common control, including properties that are separated only by a road or other public right-of-way. Common control includes properties that are owned, leased, or operated by the same entity, parent entity, subsidiary, or any combination thereof.

Polymerizing monomer means a molecule or compound usually containing carbon and of relatively low molecular weight and simple structure (e.g., hydrogen cyanide, acrylonitrile, styrene), which is capable of conversion to polymers, synthetic resins, or elastomers by combination with itself due to heat generation caused by a pump mechanical seal surface, contamination by a seal fluid (e.g., organic peroxides or chemicals that will form organic peroxides), or a combination of both with the resultant polymer buildup causing rapid mechanical seal failure.

Pressure release means the emission of materials resulting from the system pressure being greater than the set pressure of the pressure relief device. This release can be one release or a series of releases over a short time period due to a malfunction in the process.

Pressure relief device or valve means a safety device used to prevent operating pressures from exceeding the maximum allowable working pressure of the process equipment. A common pressure relief device is a spring-loaded pressure relief valve. Devices that are actuated either by a pressure of less than or equal to 2.5 psig or by a vacuum are not pressure relief devices.

Process unit means a chemical manufacturing process unit as defined in subpart F of this part, a process subject to the provisions of subpart I of this part, or a process subject to another subpart in 40 CFR part 63 that references this subpart.

Process unit shutdown means a work practice or operational procedure that stops production from a process unit or part of a process unit during which it is technically feasible to clear process material from a process unit or part of a process unit consistent with safety constraints and during which repairs can be effected. An unscheduled work practice or operational procedure that stops production from a process unit or part of a process unit for less than 24 hours is not a process unit shutdown. An unscheduled work practice or operational procedure that would stop production from a process unit or part of a process unit for a shorter period of time than would be required to clear the process unit or part of the process unit of materials and start up the unit, and would result in greater emissions than delay of repair of leaking components until the next scheduled process unit shutdown, is not a process unit shutdown. The use of spare equipment and technically feasible bypassing of equipment without stopping production are not process unit shutdowns.

Recapture device means an individual unit of equipment capable of and used for the purpose of recovering chemicals, but not normally for use, reuse, or sale. Recapture devices include, but are not

limited to, absorbers, carbon absorbers, and condensers.

Recovery device means an individual unit of equipment capable of and normally used for the purpose of recovering chemicals for fuel value (i.e., net positive heating value), use, reuse, or for sale for fuel value, use or reuse. Recovery devices include, but are not limited to, absorbers, carbon absorbers, and condensers. For purposes of the monitoring, recordkeeping, and reporting requirements of this subpart, recapture devices are considered recovery devices.

Repaired means that equipment:

(1) Is adjusted, or otherwise altered, to eliminate a leak as defined in the applicable sections of this subpart, and

(2) Unless otherwise specified in applicable provisions of this subpart, is monitored as specified in §63.180 (b) and (c), as appropriate, to verify that emissions from the equipment are below the applicable leak definition.

Routed to a process or route to a process means the emissions are conveyed by hard-piping or a closed vent system to any enclosed portion of a process unit where the emissions are predominately recycled and/or consumed in the same manner as a material that fulfills the same function in the process; and/or transformed by chemical reaction into materials that are not organic hazardous air pollutants; and/or incorporated into a product; and/or recovered.

Sampling connection system means an assembly of equipment within a process unit used during periods of representative operation to take samples of the process fluid. Equipment used to take non-routine grab samples is not considered a sampling connection system.

Screwed connector means a threaded pipe fitting where the threads are cut on the pipe wall and the fitting requires only two pieces to make the connection (i.e., the pipe and the fitting).

Sensor means a device that measures a physical quantity or the change in a physical quantity, such as temperature, pressure, flow rate, pH, or liquid level.

Set pressure means the pressure at which a properly operating pressure relief device begins to open to relieve atypical process system operating pressure.

Start-up means the setting in operation of a piece of equipment or a control device that is subject to this subpart.

Surge control vessel means feed drums, recycle drums, and intermediate vessels. Surge control vessels are used within a process unit (as defined in the specific subpart that references this subpart) when in-process storage, mixing, or management of flow rates or volumes is needed to assist in production of a product.

[59 FR 19568, Apr. 22, 1994, as amended at 59 FR 48176, Sept. 20, 1994; 60 FR 18024, 18029, Apr. 10, 1995; 61 FR 31439, June 20, 1996; 62 FR 2788, Jan. 17, 1997]

§ 63.162 Standards: General.

(a) Compliance with this subpart will be determined by review of the records required by §63.181 of this subpart and the reports required by §63.182 of this subpart, review of performance test results, and by inspections.

(b)(1) An owner or operator may request a determination of alternative means of emission limitation to the requirements of §§63.163 through 63.170, and §§63.172 through 63.174 of this subpart as provided in §63.177.

(2) If the Administrator makes a determination that a means of emission limitation is a permissible alternative to the requirements of §§63.163 through 63.170, and §§63.172 through 63.174 of this subpart, the owner or operator shall comply with the alternative.

(c) Each piece of equipment in a process unit to which this subpart applies shall be identified such that it can be distinguished readily from equipment that is not subject to this subpart. Identification of the equipment does not require physical tagging of the equipment. For example, the equipment may be identified on a plant site plan, in log entries, or by designation of process unit boundaries by some form of weatherproof identification.

(d) Equipment that is in vacuum service is excluded from the requirements of this subpart.

(e) Equipment that is in organic HAP service less than 300 hours per calendar year is excluded from the requirements of §§63.163 through 63.174 of this subpart and §63.178 of this subpart if it is identified as required in §63.181(j) of this subpart.

(f) When each leak is detected as specified in §§63.163 and 63.164; §§63.168 and 63.169; and §§63.172 through 63.174 of this subpart, the following requirements apply:

(1) Clearly identify the leaking equipment.

(2) The identification on a valve may be removed after it has been monitored as specified in §§63.168(f)(3), and 63.175(e)(7)(i)(D) of this subpart, and no leak has been detected during the follow-up monitoring. If the owner or operator elects to comply using the provisions of §63.174(c)(1)(i) of this subpart, the identification on a connector may be removed after it is monitored as specified in §63.174(c)(1)(i) and no leak is detected during that monitoring.

(3) The identification which has been placed on equipment determined to have a leak, except for a valve or for a connector that is subject to the provisions of §63.174(c)(1)(i), may be removed after it is repaired.

(g) Except as provided in paragraph (g)(1) of this section, all terms in this subpart that define a period of time for completion of required tasks (e.g., weekly, monthly, quarterly, annual), refer to the standard calendar periods unless specified otherwise in the section or subsection that imposes the requirement.

(1) If the initial compliance date does not coincide with the beginning of the standard calendar period, an owner or operator may elect to utilize a period beginning on the compliance date, or may elect to comply in accordance with the provisions of paragraphs (g)(2) or (g)(3) of this section.

(2) Time periods specified in this subpart for completion of required tasks may be changed by mutual agreement between the owner or operator and the Administrator, as specified in subpart A of this part. For each time period that is changed by agreement, the revised period shall remain in effect until it is changed. A new request is not necessary for each recurring period.

(3) Except as provided in paragraph (g)(1) or (g)(2) of this section, where the period specified for compliance is a standard calendar period, if the initial compliance date does not coincide with the beginning of the calendar period, compliance shall be required according to the schedule specified in paragraphs (g)(3)(i) or (g)(3)(ii) of this section, as appropriate.

(i) Compliance shall be required before the end of the standard calendar period within which the compliance deadline occurs, if there remain at least 3 days for tasks that must be performed weekly, at least 2 weeks for tasks that must be performed monthly, at least 1 month for tasks that must be performed each quarter, or at least 3 months for tasks that must be performed annually; or

(ii) In all other cases, compliance shall be required before the end of the first full standard calendar period after the period within which the initial compliance deadline occurs.

(4) In all instances where a provision of this subpart requires completion of a task during each of multiple successive periods, an owner or operator may perform the required task at any time during each period, provided the task is conducted at a reasonable interval after completion of the task during the previous period.

(h) In all cases where the provisions of this subpart require an owner or operator to repair leaks by a specified time after the leak is detected, it is a violation of this subpart to fail to take action to repair the leaks within the specified time. If action is taken to repair the leaks within the specified time, failure of

that action to successfully repair the leak is not a violation of this subpart. However, if the repairs are unsuccessful, a leak is detected and the owner or operator shall take further action as required by applicable provisions of this subpart.

[59 FR 19568, Apr. 22, 1994, as amended at 59 FR 48176, Sept. 20, 1994; 62 FR 2789, Jan. 17, 1997; 68 FR 37345, June 23, 2003]

§ 63.163 Standards: Pumps in light liquid service.

(a) The provisions of this section apply to each pump that is in light liquid service.

(1) The provisions are to be implemented on the dates specified in the specific subpart in 40 CFR part 63 that references this subpart in the phases specified below:

(i) For each group of existing process units at existing sources subject to the provisions of subparts F or I of this part, the phases of the standard are:

(A) Phase I, beginning on the compliance date;

(B) Phase II, beginning no later than 1 year after the compliance date; and

(C) Phase III, beginning no later than 21/2years after the compliance date.

(ii) For new sources subject to the provisions of subparts F or I of this part, the applicable phases of the standard are:

(A) After initial start-up, comply with the Phase II requirements; and

(B) Beginning no later than 1 year after initial start-up, comply with the Phase III requirements.

(2) The owner or operator of a source subject to the provisions of subparts F or I of this part may elect to meet the requirements of a later phase during the time period specified for an earlier phase.

(3) Sources subject to other subparts in 40 CFR part 63 that reference this subpart shall comply on the dates specified in the applicable subpart.

(b)(1) The owner or operator of a process unit subject to this subpart shall monitor each pump monthly to detect leaks by the method specified in §63.180(b) of this subpart and shall comply with the requirements of paragraphs (a) through (d) of this section, except as provided in §63.162(b) of this subpart and paragraphs (e) through (j) of this section.

(2) The instrument reading, as determined by the method as specified in §63.180(b) of this subpart, that defines a leak in each phase of the standard is:

(i) For Phase I, an instrument reading of 10,000 parts per million or greater.

(ii) For Phase II, an instrument reading of 5,000 parts per million or greater.

(iii) For Phase III, an instrument reading of:

(A) 5,000 parts per million or greater for pumps handling polymerizing monomers;

(B) 2,000 parts per million or greater for pumps in food/medical service; and

(C) 1,000 parts per million or greater for all other pumps.

(3) Each pump shall be checked by visual inspection each calendar week for indications of liquids

dripping from the pump seal. If there are indications of liquids dripping from the pump seal, a leak is detected.

(c)(1) When a leak is detected, it shall be repaired as soon as practicable, but not later than 15 calendar days after it is detected, except as provided in paragraph (c)(3) of this section or §63.171 of this subpart.

(2) A first attempt at repair shall be made no later than 5 calendar days after the leak is detected. First attempts at repair include, but are not limited to, the following practices where practicable:

(i) Tightening of packing gland nuts.

(ii) Ensuring that the seal flush is operating at design pressure and temperature.

(3) For pumps in Phase III to which a 1,000 parts per million leak definition applies, repair is not required unless an instrument reading of 2,000 parts per million or greater is detected.

(d)(1) The owner or operator shall decide no later than the first monitoring period whether to calculate percent leaking pumps on a process unit basis or on a source-wide basis. Once the owner or operator has decided, all subsequent percent calculations shall be made on the same basis.

(2) If, in Phase III, calculated on a 6-month rolling average, the greater of either 10 percent of the pumps in a process unit or three pumps in a process unit leak, the owner or operator shall implement a quality improvement program for pumps that complies with the requirements of §63.176 of this subpart.

(3) The number of pumps at a process unit shall be the sum of all the pumps in organic HAP service, except that pumps found leaking in a continuous process unit within 1 month after start-up of the pump shall not count in the percent leaking pumps calculation for that one monitoring period only.

(4) Percent leaking pumps shall be determined by the following equation:

$$\%P_L = ((P_L - P_S) / (P_T - P_S)) \times 100$$

where:

$\%P_L$ = Percent leaking pumps

P_L = Number of pumps found leaking as determined through monthly monitoring as required in paragraphs (b)(1) and (b)(2) of this section.

P_T = Total pumps in organic HAP service, including those meeting the criteria in paragraphs (e) and (f) of this section.

P_S = Number of pumps leaking within 1 month of start-up during the current monitoring period.

(e) Each pump equipped with a dual mechanical seal system that includes a barrier fluid system is exempt from the requirements of paragraphs (a) through (d) of this section, provided the following requirements are met:

(1) Each dual mechanical seal system is:

(i) Operated with the barrier fluid at a pressure that is at all times greater than the pump stuffing box pressure; or

(ii) Equipped with a barrier fluid degassing reservoir that is routed to a process or fuel gas system or connected by a closed-vent system to a control device that complies with the requirements of §63.172 of this subpart; or

- (iii) Equipped with a closed-loop system that purges the barrier fluid into a process stream.
- (2) The barrier fluid is not in light liquid service.
- (3) Each barrier fluid system is equipped with a sensor that will detect failure of the seal system, the barrier fluid system, or both.
- (4) Each pump is checked by visual inspection each calendar week for indications of liquids dripping from the pump seal.
 - (i) If there are indications of liquids dripping from the pump seal at the time of the weekly inspection, the pump shall be monitored as specified in §63.180(b) of this subpart to determine if there is a leak of organic HAP in the barrier fluid.
 - (ii) If an instrument reading of 1,000 parts per million or greater is measured, a leak is detected.
- (5) Each sensor as described in paragraph (e)(3) of this section is observed daily or is equipped with an alarm unless the pump is located within the boundary of an unmanned plant site.
- (6)(i) The owner or operator determines, based on design considerations and operating experience, criteria applicable to the presence and frequency of drips and to the sensor that indicates failure of the seal system, the barrier fluid system, or both.
 - (ii) If indications of liquids dripping from the pump seal exceed the criteria established in paragraph (e)(6)(i) of this section, or if, based on the criteria established in paragraph (e)(6)(i) of this section, the sensor indicates failure of the seal system, the barrier fluid system, or both, a leak is detected.
 - (iii) When a leak is detected, it shall be repaired as soon as practicable, but not later than 15 calendar days after it is detected, except as provided in §63.171 of this subpart.
 - (iv) A first attempt at repair shall be made no later than 5 calendar days after each leak is detected.
- (f) Any pump that is designed with no externally actuated shaft penetrating the pump housing is exempt from the requirements of paragraphs (a) through (c) of this section.
- (g) Any pump equipped with a closed-vent system capable of capturing and transporting any leakage from the seal or seals to a process or to a fuel gas system or to a control device that complies with the requirements of §63.172 of this subpart is exempt from the requirements of paragraphs (b) through (e) of this section.
- (h) Any pump that is located within the boundary of an unmanned plant site is exempt from the weekly visual inspection requirement of paragraphs (b)(3) and (e)(4) of this section, and the daily requirements of paragraph (e)(5) of this section, provided that each pump is visually inspected as often as practicable and at least monthly.
- (i) If more than 90 percent of the pumps at a process unit meet the criteria in either paragraph (e) or (f) of this section, the process unit is exempt from the requirements of paragraph (d) of this section.
- (j) Any pump that is designated, as described in §63.181(b)(7)(i) of this subpart, as an unsafe-to-monitor pump is exempt from the requirements of paragraphs (b) through (e) of this section if:
 - (1) The owner or operator of the pump determines that the pump is unsafe to monitor because monitoring personnel would be exposed to an immediate danger as a consequence of complying with paragraphs (b) through (d) of this section; and
 - (2) The owner or operator of the pump has a written plan that requires monitoring of the pump as frequently as practical during safe-to-monitor times, but not more frequently than the periodic monitoring schedule otherwise applicable.

[59 FR 19568, Apr. 22, 1994, as amended at 59 FR 48176, Sept. 20, 1994; 61 FR 31439, June 20, 1996; 62 FR 2789, Jan. 17, 1997; 64 FR 20198, Apr. 26, 1999]

§ 63.164 Standards: Compressors.

(a) Each compressor shall be equipped with a seal system that includes a barrier fluid system and that prevents leakage of process fluid to the atmosphere, except as provided in §63.162(b) of this subpart and paragraphs (h) and (i) of this section.

(b) Each compressor seal system as required in paragraph (a) of this section shall be:

(1) Operated with the barrier fluid at a pressure that is greater than the compressor stuffing box pressure; or

(2) Equipped with a barrier fluid system degassing reservoir that is routed to a process or fuel gas system or connected by a closed-vent system to a control device that complies with the requirements of §63.172 of this subpart; or

(3) Equipped with a closed-loop system that purges the barrier fluid directly into a process stream.

(c) The barrier fluid shall not be in light liquid service.

(d) Each barrier fluid system as described in paragraphs (a) through (c) of this section shall be equipped with a sensor that will detect failure of the seal system, barrier fluid system, or both.

(e)(1) Each sensor as required in paragraph (d) of this section shall be observed daily or shall be equipped with an alarm unless the compressor is located within the boundary of an unmanned plant site.

(2) The owner or operator shall determine, based on design considerations and operating experience, a criterion that indicates failure of the seal system, the barrier fluid system, or both.

(f) If the sensor indicates failure of the seal system, the barrier fluid system, or both based on the criterion determined under paragraph (e)(2) of this section, a leak is detected.

(g)(1) When a leak is detected, it shall be repaired as soon as practicable, but not later than 15 calendar days after it is detected, except as provided in §63.171 of this subpart.

(2) A first attempt at repair shall be made no later than 5 calendar days after each leak is detected.

(h) A compressor is exempt from the requirements of paragraphs (a) through (g) of this section if it is equipped with a closed-vent system to capture and transport leakage from the compressor drive shaft seal back to a process or a fuel gas system or to a control device that complies with the requirements of §63.172 of this subpart.

(i) Any compressor that is designated, as described in §63.181(b)(2)(ii) of this subpart, to operate with an instrument reading of less than 500 parts per million above background, is exempt from the requirements of paragraphs (a) through (h) of this section if the compressor:

(1) Is demonstrated to be operating with an instrument reading of less than 500 parts per million above background, as measured by the method specified in §63.180(c) of this subpart; and

(2) Is tested for compliance with paragraph (i)(1) of this section initially upon designation, annually, and at other times requested by the Administrator.

[59 FR 19568, Apr. 22, 1994, as amended at 59 FR 48176, Sept. 20, 1994; 62 FR 2790, Jan. 17, 1997; 64 FR 20198, Apr. 26, 1999]

§ 63.165 Standards: Pressure relief devices in gas/vapor service.

(a) Except during pressure releases, each pressure relief device in gas/vapor service shall be operated with an instrument reading of less than 500 parts per million above background except as provided in paragraph (b) of this section, as measured by the method specified in §63.180(c) of this subpart.

(b)(1) After each pressure release, the pressure relief device shall be returned to a condition indicated by an instrument reading of less than 500 parts per million above background, as soon as practicable, but no later than 5 calendar days after each pressure release, except as provided in §63.171 of this subpart.

(2) No later than 5 calendar days after the pressure release and being returned to organic HAP service, the pressure relief device shall be monitored to confirm the condition indicated by an instrument reading of less than 500 parts per million above background, as measured by the method specified in §63.180(c) of this subpart.

(c) Any pressure relief device that is routed to a process or fuel gas system or equipped with a closed-vent system capable of capturing and transporting leakage from the pressure relief device to a control device as described in §63.172 of this subpart is exempt from the requirements of paragraphs (a) and (b) of this section.

(d)(1) Any pressure relief device that is equipped with a rupture disk upstream of the pressure relief device is exempt from the requirements of paragraphs (a) and (b) of this section, provided the owner or operator complies with the requirements in paragraph (d)(2) of this section.

(2) After each pressure release, a rupture disk shall be installed upstream of the pressure relief device as soon as practicable, but no later than 5 calendar days after each pressure release, except as provided in §63.171 of this subpart.

[59 FR 19568, Apr. 22, 1994, as amended at 59 FR 48176, Sept. 20, 1994; 62 FR 2790, Jan. 17, 1997]

§ 63.166 Standards: Sampling connection systems.

(a) Each sampling connection system shall be equipped with a closed-purge, closed-loop, or closed-vent system, except as provided in §63.162(b) of this subpart. Gases displaced during filling of the sample container are not required to be collected or captured.

(b) Each closed-purge, closed-loop, or closed-vent system as required in paragraph (a) of this section shall:

(1) Return the purged process fluid directly to the process line; or

(2) Collect and recycle the purged process fluid to a process; or

(3) Be designed and operated to capture and transport the purged process fluid to a control device that complies with the requirements of §63.172 of this subpart; or

(4) Collect, store, and transport the purged process fluid to a system or facility identified in paragraph (b) (4)(i), (ii), or (iii) of this section.

(i) A waste management unit as defined in §63.111 of subpart G of this part, if the waste management unit is subject to, and operated in compliance with the provisions of subpart G of this part applicable to group 1 wastewater streams. If the purged process fluid does not contain any organic HAP listed in Table 9 of subpart G of part 63, the waste management unit need not be subject to, and operated in compliance with the requirements of 40 CFR part 63, subpart G applicable to group 1 wastewater streams provided the facility has an NPDES permit or sends the wastewater to an NPDES permitted facility.

(ii) A treatment, storage, or disposal facility subject to regulation under 40 CFR part 262, 264, 265, or 266; or

(iii) A facility permitted, licensed, or registered by a State to manage municipal or industrial solid waste, if

the process fluids are not hazardous waste as defined in 40 CFR part 261.

(c) *In-situ* sampling systems and sampling systems without purges are exempt from the requirements of paragraphs (a) and (b) of this section.

[59 FR 19568, Apr. 22, 1994, as amended at 61 FR 31439, June 20, 1996]

§ 63.167 Standards: Open-ended valves or lines.

(a)(1) Each open-ended valve or line shall be equipped with a cap, blind flange, plug, or a second valve, except as provided in §63.162(b) of this subpart and paragraphs (d) and (e) of this section.

(2) The cap, blind flange, plug, or second valve shall seal the open end at all times except during operations requiring process fluid flow through the open-ended valve or line, or during maintenance or repair.

(b) Each open-ended valve or line equipped with a second valve shall be operated in a manner such that the valve on the process fluid end is closed before the second valve is closed.

(c) When a double block and bleed system is being used, the bleed valve or line may remain open during operations that require venting the line between the block valves but shall comply with paragraph (a) of this section at all other times.

(d) Open-ended valves or lines in an emergency shutdown system which are designed to open automatically in the event of a process upset are exempt from the requirements of paragraphs (a), (b) and (c) of this section.

(e) Open-ended valves or lines containing materials which would autocatalytically polymerize or, would present an explosion, serious overpressure, or other safety hazard if capped or equipped with a double block and bleed system as specified in paragraphs (a) through (c) of this section are exempt from the requirements of paragraph (a) through (c) of this section.

[59 FR 19568, Apr. 22, 1994, as amended at 61 FR 31440, June 20, 1996]

§ 63.168 Standards: Valves in gas/vapor service and in light liquid service.

(a) The provisions of this section apply to valves that are either in gas service or in light liquid service.

(1) The provisions are to be implemented on the dates set forth in the specific subpart in 40 CFR part 63 that references this subpart as specified in paragraph (a)(1)(i), (a)(1)(ii), or (a)(1)(iii) of this section.

(i) For each group of existing process units at existing sources subject to the provisions of subpart F or I of this part, the phases of the standard are:

- (A) Phase I, beginning on the compliance date;
- (B) Phase II, beginning no later than 1 year after the compliance date; and
- (C) Phase III, beginning no later than 21/2years after the compliance date.

(ii) For new sources subject to the provisions of subpart F or I of this part, the applicable phases of the standard are:

- (A) After initial start-up, comply with the Phase II requirements; and
- (B) Beginning no later than 1 year after initial start-up, comply with the Phase III requirements.

(iii) Sources subject to other subparts in 40 CFR part 63 that reference this subpart shall comply on the dates specified in the applicable subpart.

(2) The owner or operator of a source subject to this subpart may elect to meet the requirements of a later phase during the time period specified for an earlier phase.

(3) The use of monitoring data generated before April 22, 1994 to qualify for less frequent monitoring is governed by the provisions of §63.180(b)(6) of this subpart.

(b) The owner or operator of a source subject to this subpart shall monitor all valves, except as provided in §63.162(b) of this subpart and paragraphs (h) and (i) of this section, at the intervals specified in paragraphs (c) and (d) of this section and shall comply with all other provisions of this section, except as provided in §63.171, §63.177, §63.178, and §63.179 of this subpart.

(1) The valves shall be monitored to detect leaks by the method specified in §63.180(b) of this subpart.

(2) The instrument reading that defines a leak in each phase of the standard is:

(i) For Phase I, an instrument reading of 10,000 parts per million or greater.

(ii) For Phase II, an instrument reading of 500 parts per million or greater.

(iii) For Phase III, an instrument reading of 500 parts per million or greater.

(c) In Phases I and II, each valve shall be monitored quarterly.

(d) In Phase III, the owner or operator shall monitor valves for leaks at the intervals specified below:

(1) At process units with 2 percent or greater leaking valves, calculated according to paragraph (e) of this section, the owner or operator shall either:

(i) Monitor each valve once per month; or

(ii) Within the first year after the onset of Phase III, implement a quality improvement program for valves that complies with the requirements of §63.175 (d) or (e) of this subpart and monitor quarterly.

(2) At process units with less than 2 percent leaking valves, the owner or operator shall monitor each valve once each quarter, except as provided in paragraphs (d)(3) and (d)(4) of this section.

(3) At process units with less than 1 percent leaking valves, the owner or operator may elect to monitor each valve once every 2 quarters.

(4) At process units with less than 0.5 percent leaking valves, the owner or operator may elect to monitor each valve once every 4 quarters.

(e)(1) Percent leaking valves at a process unit shall be determined by the following equation:

$$\%V_L = (V_L / (V_T + V_C)) \times 100$$

where:

$\%V_L$ = Percent leaking valves as determined through periodic monitoring required in paragraphs (b) through (d) of this section.

V_L = Number of valves found leaking excluding nonrepairables as provided in paragraph (e)(3) (i) of this section.

V_T = Total valves monitored, in a monitoring period excluding valves monitored as required by (f)(3) of this section.

V_C = Optional credit for removed valves = $0.67 \times$ net number (i.e., total removed – total added) of valves in organic HAP service removed from process unit after the date set forth in §63.100(k) of subpart F for existing process units, and after the date of initial start-up for new sources. If credits are not taken, then $V_C = 0$.

(2) For use in determining monitoring frequency, as specified in paragraph (d) of this section, the percent leaking valves shall be calculated as a rolling average of two consecutive monitoring periods for monthly, quarterly, or semiannual monitoring programs; and as an average of any three out of four consecutive monitoring periods for annual monitoring programs.

(3)(i) Nonrepairable valves shall be included in the calculation of percent leaking valves the first time the valve is identified as leaking and nonrepairable and as required to comply with paragraph (e)(3)(ii) of this section. Otherwise, a number of nonrepairable valves (identified and included in the percent leaking calculation in a previous period) up to a maximum of 1 percent of the total number of valves in organic HAP service at a process unit may be excluded from calculation of percent leaking valves for subsequent monitoring periods.

(ii) If the number of nonrepairable valves exceeds 1 percent of the total number of valves in organic HAP service at a process unit, the number of nonrepairable valves exceeding 1 percent of the total number of valves in organic HAP service shall be included in the calculation of percent leaking valves.

(f)(1) When a leak is detected, it shall be repaired as soon as practicable, but no later than 15 calendar days after the leak is detected, except as provided in §63.171 of this subpart.

(2) A first attempt at repair shall be made no later than 5 calendar days after each leak is detected.

(3) When a leak has been repaired, the valve shall be monitored at least once within the first 3 months after its repair.

(i) The monitoring shall be conducted as specified in §63.180 (b) and (c), as appropriate, to determine whether the valve has resumed leaking.

(ii) Periodic monitoring required by paragraphs (b) through (d) of this section may be used to satisfy the requirements of this paragraph (f)(3), if the timing of the monitoring period coincides with the time specified in this paragraph (f)(3). Alternatively, other monitoring may be performed to satisfy the requirements of this paragraph (f)(3), regardless of whether the timing of the monitoring period for periodic monitoring coincides with the time specified in this paragraph (f)(3).

(iii) If a leak is detected by monitoring that is conducted pursuant to paragraph (f)(3) of this section, the owner or operator shall follow the provisions of paragraphs (f)(3)(iii)(A) and (f)(3)(iii)(B) of this section, to determine whether that valve must be counted as a leaking valve for purposes of §63.168(e) of this subpart.

(A) If the owner or operator elected to use periodic monitoring required by paragraphs (b) through (d) of this section to satisfy the requirements of paragraph (f)(3) of this section, then the valve shall be counted as a leaking valve.

(B) If the owner or operator elected to use other monitoring, prior to the periodic monitoring required by paragraphs (b) through (d) of this section, to satisfy the requirements of paragraph (f)(3) of this section, then the valve shall be counted as a leaking valve unless it is repaired and shown by periodic monitoring not to be leaking.

(g) First attempts at repair include, but are not limited to, the following practices where practicable:

(1) Tightening of bonnet bolts,

(2) Replacement of bonnet bolts,

(3) Tightening of packing gland nuts, and

(4) Injection of lubricant into lubricated packing.

(h) Any valve that is designated, as described in §63.181(b)(7)(i) of this subpart, as an unsafe-to-monitor valve is exempt from the requirements of paragraphs (b) through (f) of this section if:

(1) The owner or operator of the valve determines that the valve is unsafe to monitor because monitoring personnel would be exposed to an immediate danger as a consequence of complying with paragraphs (b) through (d) of this section; and

(2) The owner or operator of the valve has a written plan that requires monitoring of the valve as frequently as practicable during safe-to-monitor times, but not more frequently than the periodic monitoring schedule otherwise applicable.

(i) Any valve that is designated, as described in §63.181(b)(7)(ii) of this subpart, as a difficult-to-monitor valve is exempt from the requirements of paragraphs (b) through (d) of this section if:

(1) The owner or operator of the valve determines that the valve cannot be monitored without elevating the monitoring personnel more than 2 meters above a support surface or it is not accessible at anytime in a safe manner;

(2) The process unit within which the valve is located is an existing source or the owner or operator designates less than 3 percent of the total number of valves in a new source as difficult-to-monitor; and

(3) The owner or operator of the valve follows a written plan that requires monitoring of the valve at least once per calendar year.

(j) Any equipment located at a plant site with fewer than 250 valves in organic HAP service is exempt from the requirements for monthly monitoring and a quality improvement program specified in paragraph (d)(1) of this section. Instead, the owner or operator shall monitor each valve in organic HAP service for leaks once each quarter, or comply with paragraph (d)(3) or (d)(4) of this section except as provided in paragraphs (h) and (i) of this section.

[59 FR 19568, Apr. 22, 1994, as amended at 59 FR 48176, Sept. 20, 1994; 61 FR 31440, June 20, 1996; 62 FR 2790, Jan. 17, 1997]

§ 63.169 Standards: Pumps, valves, connectors, and agitators in heavy liquid service; instrumentation systems; and pressure relief devices in liquid service.

(a) Pumps, valves, connectors, and agitators in heavy liquid service, pressure relief devices in light liquid or heavy liquid service, and instrumentation systems shall be monitored within 5 calendar days by the method specified in §63.180(b) of this subpart if evidence of a potential leak to the atmosphere is found by visual, audible, olfactory, or any other detection method. If such a potential leak is repaired as required in paragraphs (c) and (d) of this section, it is not necessary to monitor the system for leaks by the method specified in §63.180(b) of this subpart.

(b) If an instrument reading of 10,000 parts per million or greater for agitators, 5,000 parts per million or greater for pumps handling polymerizing monomers, 2,000 parts per million or greater for all other pumps (including pumps in food/medical service), or 500 parts per million or greater for valves, connectors, instrumentation systems, and pressure relief devices is measured, a leak is detected.

(c)(1) When a leak is detected, it shall be repaired as soon as practicable, but not later than 15 calendar days after it is detected, except as provided in §63.171 of this subpart.

(2) The first attempt at repair shall be made no later than 5 calendar days after each leak is detected.

(3) For equipment identified in paragraph (a) of this section that is not monitored by the method specified in §63.180(b), repaired shall mean that the visual, audible, olfactory, or other indications of a leak to the atmosphere have been eliminated; that no bubbles are observed at potential leak sites during a leak check using soap solution; or that the system will hold a test pressure.

(d) First attempts at repair include, but are not limited to, the practices described under §§63.163(c)(2) and 63.168(g) of this subpart, for pumps and valves, respectively.

[59 FR 19568, Apr. 22, 1994, as amended at 59 FR 48177, Sept. 20, 1994; 60 FR 18029, Apr. 10, 1995; 62 FR 2790, Jan. 17, 1997; 65 FR 78285, Dec. 14, 2000]

§ 63.170 Standards: Surge control vessels and bottoms receivers.

Each surge control vessel or bottoms receiver that is not routed back to the process and that meets the conditions specified in table 2 or table 3 of this subpart shall be equipped with a closed-vent system that routes the organic vapors vented from the surge control vessel or bottoms receiver back to the process or to a control device that complies with the requirements in §63.172 of this subpart, except as provided in §63.162(b) of this subpart, or comply with the requirements of §63.119(b) or (c) of subpart G of this part.

[60 FR 18024, Apr. 10, 1995]

§ 63.171 Standards: Delay of repair.

(a) Delay of repair of equipment for which leaks have been detected is allowed if repair within 15 days is technically infeasible without a process unit shutdown. Repair of this equipment shall occur by the end of the next process unit shutdown.

(b) Delay of repair of equipment for which leaks have been detected is allowed for equipment that is isolated from the process and that does not remain in organic HAP service.

(c) Delay of repair for valves, connectors, and agitators is also allowed if:

(1) The owner or operator determines that emissions of purged material resulting from immediate repair would be greater than the fugitive emissions likely to result from delay of repair, and

(2) When repair procedures are effected, the purged material is collected and destroyed or recovered in a control device complying with §63.172 of this subpart.

(d) Delay of repair for pumps is also allowed if:

(1) Repair requires replacing the existing seal design with a new system that the owner or operator has determined under the provisions of §63.176(d) of this subpart will provide better performance or:

(i) A dual mechanical seal system that meets the requirements of §63.163(e) of this subpart,

(ii) A pump that meets the requirements of §63.163(f) of this subpart, or

(iii) A closed-vent system and control device that meets the requirements of §63.163(g) of this subpart; and

(2) Repair is completed as soon as practicable, but not later than 6 months after the leak was detected.

(e) Delay of repair beyond a process unit shutdown will be allowed for a valve if valve assembly replacement is necessary during the process unit shutdown, valve assembly supplies have been depleted, and valve assembly supplies had been sufficiently stocked before the supplies were depleted. Delay of repair beyond the second process unit shutdown will not be allowed unless the third process unit shutdown occurs sooner than 6 months after the first process unit shutdown.

[59 FR 19568, Apr. 22, 1994, as amended at 59 FR 48177, Sept. 20, 1994; 65 FR 78285, Dec. 14, 2000]

§ 63.172 Standards: Closed-vent systems and control devices.

(a) Owners or operators of closed-vent systems and control devices used to comply with provisions of this subpart shall comply with the provisions of this section, except as provided in §63.162(b) of this subpart.

(b) Recovery or recapture devices (e.g., condensers and absorbers) shall be designed and operated to recover the organic hazardous air pollutant emissions or volatile organic compounds emissions vented to them with an efficiency of 95 percent or greater, or to an exit concentration of 20 parts per million by volume, whichever is less stringent. The 20 parts per million by volume performance standard is not applicable to the provisions of §63.179.

(c) Enclosed combustion devices shall be designed and operated to reduce the organic hazardous air pollutant emissions or volatile organic compounds emissions vented to them with an efficiency of 95 percent or greater, or to an exit concentration of 20 parts per million by volume, on a dry basis, corrected to 3 percent oxygen, whichever is less stringent, or to provide a minimum residence time of 0.50 seconds at a minimum temperature of 760 °C.

(d) Flares used to comply with this subpart shall comply with the requirements of §63.11(b) of subpart A of this part.

(e) Owners or operators of control devices that are used to comply with the provisions of this subpart shall monitor these control devices to ensure that they are operated and maintained in conformance with their design.

Note: The intent of this provision is to ensure proper operation and maintenance of the control device.

(f) Except as provided in paragraphs (k) and (l) of this section, each closed-vent system shall be inspected according to the procedures and schedule specified in paragraphs (f)(1) and (f)(2) of this section.

(1) If the closed-vent system is constructed of hard-piping, the owner or operator shall:

- (i) Conduct an initial inspection according to the procedures in paragraph (g) of this section, and
- (ii) Conduct annual visual inspections for visible, audible, or olfactory indications of leaks.

(2) If the vapor collection system or closed-vent system is constructed of duct work, the owner or operator shall:

- (i) Conduct an initial inspection according to the procedures in paragraph (g) of this section, and
- (ii) Conduct annual inspections according to the procedures in paragraph (g) of this section.

(g) Each closed-vent system shall be inspected according to the procedures in §63.180(b) of this subpart.

(h) Leaks, as indicated by an instrument reading greater than 500 parts per million above background or by visual inspections, shall be repaired as soon as practicable, except as provided in paragraph (i) of this section.

(1) A first attempt at repair shall be made no later than 5 calendar days after the leak is detected.

(2) Repair shall be completed no later than 15 calendar days after the leak is detected, except as provided in paragraph (i) of this section.

(i) Delay of repair of a closed-vent system for which leaks have been detected is allowed if the repair is technically infeasible without a process unit shutdown or if the owner or operator determines that emissions resulting from immediate repair would be greater than the fugitive emissions likely to result from delay of repair. Repair of such equipment shall be complete by the end of the next process unit shutdown.

(j) For each closed-vent system that contains bypass lines that could divert a vent stream away from the control device and to the atmosphere, the owner or operator shall comply with the provisions of either paragraph (j)(1) or (j)(2) of this section, except as provided in paragraph (j)(3) of this section.

(1) Install, set or adjust, maintain, and operate a flow indicator that takes a reading at least once every 15 minutes. Records shall be generated as specified in §63.118(a)(3) of subpart G of this part. The flow indicator shall be installed at the entrance to any bypass line; or

(2) Secure the bypass line valve in the non-diverting position with a car-seal or a lock-and-key type configuration. A visual inspection of the seal or closure mechanism shall be performed at least once every month to ensure the valve is maintained in the non-diverting position and the vent stream is not diverted through the bypass line.

(3) Equipment such as low leg drains, high point bleeds, analyzer vents, open-ended valves or lines, and pressure relief valves needed for safety purposes are not subject to this paragraph.

(k) Any parts of the closed-vent system that are designated, as described in paragraph 63.181(b)(7)(i), as unsafe to inspect are exempt from the inspection requirements of paragraphs (f)(1) and (f)(2) of this section if:

(1) The owner or operator determines that the equipment is unsafe to inspect because inspecting personnel would be exposed to an imminent or potential danger as a consequence of complying with paragraph (f)(1) or (f)(2) of this section; and

(2) The owner or operator has a written plan that requires inspection of the equipment as frequently as practicable during safe-to-inspect times, but not more frequently than annually.

(l) Any parts of the closed-vent system that are designated, as described in §63.181 (b)(7)(i) of this subpart, as difficult to inspect are exempt from the inspection requirements of paragraphs (f)(1) and (f)(2) of this section if:

(1) The owner or operator determines that the equipment cannot be inspected without elevating the inspecting personnel more than 2 meters above a support surface; and

(2) The owner or operator has a written plan that requires inspection of the equipment at least once every 5 years.

(m) Whenever organic HAP emissions are vented to a closed-vent system or control device used to comply with the provisions of this subpart, such system or control device shall be operating.

(n) After the compliance dates specified in §63.100 of subpart F of this part, the owner or operator of any control device subject to this subpart that is also subject to monitoring, recordkeeping, and reporting requirements in 40 CFR part 264, subpart BB, or is subject to monitoring and recordkeeping requirements in 40 CFR part 265, subpart BB, may elect to comply either with the monitoring, recordkeeping, and reporting requirements of this subpart, or with the monitoring, recordkeeping, and reporting requirements in 40 CFR parts 264 and/or 265, as described in this paragraph, which shall constitute compliance with the monitoring, recordkeeping and reporting requirements of this subpart. The owner or operator shall identify which option has been chosen, in the next periodic report required by §63.182(d).

[59 FR 19568, Apr. 22, 1994, as amended at 59 FR 48177, Sept. 20, 1994; 61 FR 31440, June 20, 1996; 62 FR 2790, Jan. 17, 1997]

§ 63.173 Standards: Agitators in gas/vapor service and in light liquid service.

(a)(1) Each agitator shall be monitored monthly to detect leaks by the methods specified in §63.180(b) of this subpart, except as provided in §63.162(b) of this subpart.

(2) If an instrument reading of 10,000 parts per million or greater is measured, a leak is detected.

(b)(1) Each agitator shall be checked by visual inspection each calendar week for indications of liquids dripping from the agitator.

(2) If there are indications of liquids dripping from the agitator, a leak is detected.

(c)(1) When a leak is detected, it shall be repaired as soon as practicable, but not later than 15 calendar days after it is detected, except as provided in §63.171 of this subpart.

(2) A first attempt at repair shall be made no later than 5 calendar days after each leak is detected.

(d) Each agitator equipped with a dual mechanical seal system that includes a barrier fluid system is exempt from the requirements of paragraph (a) of this section, provided the requirements specified in paragraphs (d)(1) through (d)(6) of this section are met:

(1) Each dual mechanical seal system is:

(i) Operated with the barrier fluid at a pressure that is at all times greater than the agitator stuffing box pressure; or

(ii) Equipped with a barrier fluid degassing reservoir that is routed to a process or fuel gas system or connected by a closed-vent system to a control device that complies with the requirements of §63.172 of this subpart; or

(iii) Equipped with a closed-loop system that purges the barrier fluid into a process stream.

(2) The barrier fluid is not in light liquid organic HAP service.

(3) Each barrier fluid system is equipped with a sensor that will detect failure of the seal system, the barrier fluid system, or both.

(4) Each agitator is checked by visual inspection each calendar week for indications of liquids dripping from the agitator seal.

(i) If there are indications of liquids dripping from the agitator seal at the time of the weekly inspection, the agitator shall be monitored as specified in §63.180(b) of this subpart to determine the presence of organic HAP in the barrier fluid.

(ii) If an instrument reading of 10,000 parts per million or greater is measured, a leak is detected.

(5) Each sensor as described in paragraph (d)(3) of this section is observed daily or is equipped with an alarm unless the agitator is located within the boundary of an unmanned plant site.

(6)(i) The owner or operator determines, based on design considerations and operating experience, criteria applicable to the presence and frequency of drips and to the sensor that indicates failure of the seal system, the barrier fluid system, or both.

(ii) If indications of liquids dripping from the agitator seal exceed the criteria established in paragraph (d)(6)(i) of this section, or if, based on the criteria established in paragraph (d)(6)(i) of this section, the sensor indicates failure of the seal system, the barrier fluid system, or both, a leak is detected.

(iii) When a leak is detected, it shall be repaired as soon as practicable, but not later than 15 calendar days after it is detected, except as provided in §63.171 of this subpart.

- (iv) A first attempt at repair shall be made no later than 5 calendar days after each leak is detected.
- (e) Any agitator that is designed with no externally actuated shaft penetrating the agitator housing is exempt from paragraphs (a) through (c) of this section.
- (f) Any agitator equipped with a closed-vent system capable of capturing and transporting any leakage from the seal or seals to a process or fuel gas system or to a control device that complies with the requirements of §63.172 of this subpart is exempt from the requirements of paragraphs (a) through (c) of the section.
- (g) Any agitator that is located within the boundary of an unmanned plant site is exempt from the weekly visual inspection requirement of paragraphs (b)(1) and (d)(4) of this section, and the daily requirements of paragraph (d)(5) of this section, provided that each agitator is visually inspected as often as practical and at least monthly.
- (h) Any agitator that is difficult-to-monitor is exempt from the requirements of paragraphs (a) through (d) of this section if:
- (1) The owner or operator determines that the agitator cannot be monitored without elevating the monitoring personnel more than two meters above a support surface or it is not accessible at anytime in a safe manner;
 - (2) The process unit within which the agitator is located is an existing source or the owner or operator designates less than three percent of the total number of agitators in a new source as difficult-to-monitor; and
 - (3) The owner or operator follows a written plan that requires monitoring of the agitator at least once per calendar year.
- (i) Any agitator that is obstructed by equipment or piping that prevents access to the agitator by a monitor probe is exempt from the monitoring requirements of paragraphs (a) through (d) of this section.
- (j) Any agitator that is designated, as described in §63.181(b)(7)(i) of this subpart, as an unsafe-to-monitor agitator is exempt from the requirements of paragraphs (a) through (d) of this section if:
- (1) The owner or operator of the agitator determines that the agitator is unsafe to monitor because monitoring personnel would be exposed to an immediate danger as a consequence of complying with paragraphs (a) through (d) of this section; and
 - (2) The owner or operator of the agitator has a written plan that requires monitoring of the agitator as frequently as practical during safe-to-monitor times, but not more frequently than the periodic monitoring schedule otherwise applicable.

[59 FR 19568, Apr. 22, 1994, as amended at 61 FR 31440, June 20, 1996; 62 FR 2791, Jan. 17, 1997; 64 FR 20198, Apr. 26, 1999]

§ 63.174 Standards: Connectors in gas/vapor service and in light liquid service.

- (a) The owner or operator of a process unit subject to this subpart shall monitor all connectors in gas/vapor and light liquid service, except as provided in §63.162(b) of this subpart, and in paragraphs (f) through (h) of this section, at the intervals specified in paragraph (b) of this section.
- (1) The connectors shall be monitored to detect leaks by the method specified in §63.180(b) of this subpart.
 - (2) If an instrument reading greater than or equal to 500 parts per million is measured, a leak is detected.
- (b) The owner or operator shall monitor for leaks at the intervals specified in either paragraph (b)(1) or

(b)(2) of this section and in paragraph (b)(3) of this section.

(1) For each group of existing process units within an existing source, by no later than 12 months after the compliance date, the owner or operator shall monitor all connectors, except as provided in paragraphs (f) through (h) of this section.

(2) For new sources, within the first 12 months after initial start-up or by no later than 12 months after the date of promulgation of a specific subpart that references this subpart, whichever is later, the owner or operator shall monitor all connectors, except as provided in paragraphs (f) through (h) of this section.

(3) After conducting the initial survey required in paragraph (b)(1) or (b)(2) of this section, the owner or operator shall perform all subsequent monitoring of connectors at the frequencies specified in paragraphs (b)(3)(i) through (b)(3)(v) of this section, except as provided in paragraph (c)(2) of this section:

(i) Once per year (i.e., 12-month period), if the percent leaking connectors in the process unit was 0.5 percent or greater during the last required annual or biennial monitoring period.

(ii) Once every 2 years, if the percent leaking connectors was less than 0.5 percent during the last required monitoring period. An owner or operator may comply with this paragraph by monitoring at least 40 percent of the connectors in the first year and the remainder of the connectors in the second year. The percent leaking connectors will be calculated for the total of all monitoring performed during the 2-year period.

(iii) If the owner or operator of a process unit in a biennial leak detection and repair program calculates less than 0.5 percent leaking connectors from the 2-year monitoring period, the owner or operator may monitor the connectors one time every 4 years. An owner or operator may comply with the requirements of this paragraph by monitoring at least 20 percent of the connectors each year until all connectors have been monitored within 4 years.

(iv) If a process unit complying with the requirements of paragraph (b) of this section using a 4-year monitoring interval program has greater than or equal to 0.5 percent but less than 1 percent leaking connectors, the owner or operator shall increase the monitoring frequency to one time every 2 years. An owner or operator may comply with the requirements of this paragraph by monitoring at least 40 percent of the connectors in the first year and the remainder of the connectors in the second year. The owner or operator may again elect to use the provisions of paragraph (b)(3)(iii) of this section when the percent leaking connectors decreases to less than 0.5 percent.

(v) If a process unit complying with requirements of paragraph (b)(3)(iii) of this section using a 4-year monitoring interval program has 1 percent or greater leaking connectors, the owner or operator shall increase the monitoring frequency to one time per year. The owner or operator may again elect to use the provisions of paragraph (b)(3)(iii) of this section when the percent leaking connectors decreases to less than 0.5 percent.

(4) The use of monitoring data generated before April 22, 1994 to qualify for less frequent monitoring is governed by the provisions of §63.180(b)(6).

(c)(1)(i) Except as provided in paragraph (c)(1)(ii) of this section, each connector that has been opened or has otherwise had the seal broken shall be monitored for leaks when it is reconnected or within the first 3 months after being returned to organic hazardous air pollutants service. If the monitoring detects a leak, it shall be repaired according to the provisions of paragraph (d) of this section, unless it is determined to be nonrepairable, in which case it is counted as a nonrepairable connector for the purposes of paragraph (i)(2) of this section.

(ii) As an alternative to the requirements in paragraph (c)(1)(i) of this section, an owner or operator may choose not to monitor connectors that have been opened or otherwise had the seal broken. In this case, the owner or operator may not count nonrepairable connectors for the purposes of paragraph (i)(2) of this section. The owner or operator shall calculate the percent leaking connectors for the monitoring periods described in paragraph (b) of this section, by setting the nonrepairable component, C_{AN} , in the equation in paragraph (i)(2) of this section to zero for all monitoring periods.

(iii) An owner or operator may switch alternatives described in paragraphs (c)(1) (i) and (ii) of this section at the end of the current monitoring period he is in, provided that it is reported as required in §63.182 of this subpart and begin the new alternative in annual monitoring. The initial monitoring in the new alternative shall be completed no later than 12 months after reporting the switch.

(2) As an alternative to the requirements of paragraph (b)(3) of this section, each screwed connector 2 inches or less in nominal inside diameter installed in a process unit before the dates specified in paragraph (c)(2)(iii) or (c)(2)(iv) of this section may:

(i) Comply with the requirements of §63.169 of this subpart, and

(ii) Be monitored for leaks within the first 3 months after being returned to organic hazardous air pollutants service after having been opened or otherwise had the seal broken. If that monitoring detects a leak, it shall be repaired according to the provisions of paragraph (d) of this section.

(iii) For sources subject to subparts F and I of this part, the provisions of paragraph (c)(2) of this section apply to screwed connectors installed before December 31, 1992.

(iv) For sources not identified in paragraph (c)(2)(iii) of this section, the provisions of paragraph (c)(2) of this section apply to screwed connectors installed before the date of proposal of the applicable subpart of this part that references this subpart.

(d) When a leak is detected, it shall be repaired as soon as practicable, but no later than 15 calendar days after the leak is detected, except as provided in paragraph (g) of this section and in §63.171 of this subpart. A first attempt at repair shall be made no later than 5 calendar days after the leak is detected.

(e) [Reserved]

(f) Any connector that is designated, as described in §63.181(b)(7)(i) of this subpart, as an unsafe-to-monitor connector is exempt from the requirements of paragraph (a) of this section if:

(1) The owner or operator determines that the connector is unsafe to monitor because personnel would be exposed to an immediate danger as a result of complying with paragraphs (a) through (e) of this section; and

(2) The owner or operator has a written plan that requires monitoring of the connector as frequently as practicable during safe to monitor periods, but not more frequently than the periodic schedule otherwise applicable.

(g) Any connector that is designated, as described in §63.181(b)(7)(iii) of this subpart, as an unsafe-to-repair connector is exempt from the requirements of paragraphs (a), (d), and (e) of this section if:

(1) The owner or operator determines that repair personnel would be exposed to an immediate danger as a consequence of complying with paragraph (d) of this section; and

(2) The connector will be repaired before the end of the next scheduled process unit shutdown.

(h)(1) Any connector that is inaccessible or is ceramic or ceramic-lined (e.g., porcelain, glass, or glass-lined), is exempt from the monitoring requirements of paragraphs (a) and (c) of this section and from the recordkeeping and reporting requirements of §63.181 and §63.182 of this subpart. An inaccessible connector is one that is:

(i) Buried;

(ii) Insulated in a manner that prevents access to the connector by a monitor probe;

(iii) Obstructed by equipment or piping that prevents access to the connector by a monitor probe;

(iv) Unable to be reached from a wheeled scissor-lift or hydraulic-type scaffold which would allow access

to connectors up to 7.6 meters (25 feet) above the ground;

(v) Inaccessible because it would require elevating the monitoring personnel more than 2 meters above a permanent support surface or would require the erection of scaffold; or

(vi) Not able to be accessed at any time in a safe manner to perform monitoring. Unsafe access includes, but is not limited to, the use of a wheeled scissor-lift on unstable or uneven terrain, the use of a motorized man-lift basket in areas where an ignition potential exists, or access would require near proximity to hazards such as electrical lines, or would risk damage to equipment.

(2) If any inaccessible or ceramic or ceramic-lined connector is observed by visual, audible, olfactory, or other means to be leaking, the leak shall be repaired as soon as practicable, but no later than 15 calendar days after the leak is detected, except as provided in §63.171 of this subpart and paragraph (g) of this section.

(3) A first attempt at repair shall be made no later than 5 calendar days after the leak is detected.

(i) For use in determining the monitoring frequency, as specified in paragraph (b) of this section, the percent leaking connectors shall be calculated as specified in paragraphs (i)(1) and (i)(2) of this section.

(1) For the first monitoring period, use the following equation:

$$\% C_L = C_L / (C_t + C_C) \times 100$$

where:

$\% C_L$ = Percent leaking connectors as determined through periodic monitoring required in paragraphs (a) and (b) of this section.

C_L = Number of connectors measured at 500 parts per million or greater, by the method specified in §63.180(b) of this subpart.

C_t = Total number of monitored connectors in the process unit.

C_C = Optional credit for removed connectors = $0.67 \times$ net (i.e., total removed—total added) number of connectors in organic hazardous air pollutants service removed from the process unit after the compliance date set forth in the applicable subpart for existing process units, and after the date of initial start-up for new process units. If credits are not taken, then $C_C = 0$.

(2) For subsequent monitoring periods, use the following equation:

$$\% C_L = [(C_L - C_{AN}) / (C_t + C_C)] \times 100$$

where:

$\% C_L$ = Percent leaking connectors as determined through periodic monitoring required in paragraphs (a) and (b) of this section.

C_L = Number of connectors, including nonrepairables, measured at 500 parts per million or greater, by the method specified in §63.180(b) of this subpart.

C_{AN} = Number of allowable nonrepairable connectors, as determined by monitoring required in paragraphs (b)(3) and (c) of this section, not to exceed 2 percent of the total connector population, C_t .

C_t = Total number of monitored connectors, including nonrepairables, in the process unit.

C_c = Optional credit for removed connectors = $0.67 \times$ net number (i.e., total removed—total added) of connectors in organic hazardous air pollutants service removed from the process unit after the compliance date set forth in the applicable subpart for existing process units, and after the date of initial start-up for new process units. If credits are not taken, then $C_c = 0$.

(j) Optional credit for removed connectors. If an owner or operator eliminates a connector subject to monitoring under paragraph (b) of this section, the owner or operator may receive credit for elimination of the connector, as described in paragraph (i) of this section, provided the requirements in paragraphs (j)(1) through (j)(4) are met.

(1) The connector was welded after the date of proposal of the specific subpart that references this subpart.

(2) The integrity of the weld is demonstrated by monitoring it according to the procedures in §63.180(b) of this subpart or by testing using X-ray, acoustic monitoring, hydrotesting, or other applicable method.

(3) Welds created after the date of proposal but before the date of promulgation of a specific subpart that references this subpart are monitored or tested by 3 months after the compliance date specified in the applicable subpart.

(4) Welds created after promulgation of the subpart that references this subpart are monitored or tested within 3 months after being welded.

(5) If an inadequate weld is found or the connector is not welded completely around the circumference, the connector is not considered a welded connector and is therefore not exempt from the provisions of this subpart.

[59 FR 19568, Apr. 22, 1994, as amended at 59 FR 48177, Sept. 20, 1994; 61 FR 31440, June 20, 1996; 62 FR 2791, Jan. 17, 1997]

§ 63.175 Quality improvement program for valves.

(a) In Phase III, an owner or operator may elect to comply with one of the alternative quality improvement programs specified in paragraphs (d) and (e) of this section. The decision to use one of these alternative provisions to comply with the requirements of §63.168(d)(1)(ii) of this subpart must be made during the first year of Phase III for existing process units and for new process units.

(b) An owner or operator of a process unit subject to the requirements of paragraph (d) or (e) of this section shall comply with those requirements until the process unit has fewer than 2 percent leaking valves, calculated as a rolling average of 2 consecutive quarters, as specified in §63.168(e) of this subpart.

(c) After the process unit has fewer than 2 percent leaking valves, the owner or operator may elect to comply with the requirements in §63.168 of this subpart, to continue to comply with the requirements in paragraph (e) (or (d), if appropriate) of this section, or comply with both the requirements in §63.168 and §63.175.

(1) If the owner or operator elects to continue the quality improvement program, the owner or operator is exempt from the requirements for performance trials as specified in paragraph (e)(6) of this section, or further progress as specified in paragraph (d)(4) of this section, as long as the process unit has fewer than 2 percent leaking valves calculated according to §63.168(e).

(2) If the owner or operator elects to comply with both paragraph (e) of this section and §63.168 of this subpart, he may also take advantage of the lower monitoring frequencies associated with lower leak rates in §63.168 (d)(2), (d)(3), and (d)(4) of this subpart.

(3) If the owner or operator elects not to continue the quality improvement program, the program is no

longer an option if the process unit again exceeds 2 percent leaking valves, and in such case, monthly monitoring will be required.

(d) The following requirements shall be met if an owner or operator elects to use a quality improvement program to demonstrate further progress:

(1) The owner or operator shall continue to comply with the requirements in §63.168 of this subpart except each valve shall be monitored quarterly.

(2) The owner or operator shall collect the following data, and maintain records as required in §63.181(h)(1) of this subpart, for each valve in each process unit subject to the quality improvement program:

(i) The maximum instrument reading observed in each monitoring observation before repair, the response factor for the stream if appropriate, the instrument model number, and date of the observation.

(ii) Whether the valve is in gas or light liquid service.

(iii) If a leak is detected, the repair methods used and the instrument readings after repair.

(3) The owner or operator shall continue to collect data on the valves as long as the process unit remains in the quality improvement program.

(4) The owner or operator must demonstrate progress in reducing the percent leaking valves each quarter the process unit is subject to the requirements of paragraph (d) of this section, except as provided in paragraphs (d)(4)(ii) and (d)(4)(iii) of this section.

(i) Demonstration of progress shall mean that for each quarter there is at least a 10-percent reduction in the percent leaking valves from the percent leaking valves determined for the preceding monitoring period. The percent leaking valves shall be calculated as a rolling average of two consecutive quarters of monitoring data. The percent reduction shall be calculated using the rolling average percent leaking valves, according to the following:

$$\%LV_R = (\%LV_{AVG1} - \%LV_{AVG2}) / \%LV_{AVG1} \times 100$$

where:

$\%LV_R$ = Percent leaking valve reduction.

$\%LV_{AVG1} = (\%V_{Li=1} + \%V_{Li=2}) / 2$.

$\%LV_{AVG2} = (\%V_{Li=1} + \%V_{Li=2}) / 2$.

where:

$\%V_{Li}$, $\%V_{Li=1}$, $\%V_{Li=2}$ are percent leaking valves calculated for subsequent monitoring periods, i , $i+1$, $i+2$.

(ii) An owner or operator who fails for two consecutive rolling averages to demonstrate at least a 10-percent reduction per quarter in percent leaking valves, and whose overall average percent reduction based on two or more rolling averages is less than 10 percent per quarter, shall either comply with the requirements in §63.168(d)(1)(i) of this subpart using monthly monitoring or shall comply using a quality improvement program for technology review as specified in paragraph (e) of this section. If the owner or operator elects to comply with the requirements of paragraph (e) of this section, the schedule for performance trials and valve replacements remains as specified in paragraph (e) of this section.

(iii) As an alternative to the provisions in paragraph (d)(4)(i), an owner or operator may use the procedure specified in paragraphs (d)(4)(iii)(A) and (d)(4)(iii)(B) of this section to demonstrate progress

in reducing the percent leaking valves.

(A) The percent reduction that must be achieved each quarter shall be calculated as follows:

$$\%RR = \frac{\%V_L - 2\%}{0.10}$$

%RR = percent reduction required each quarter, as calculated according to §63.168(e)

%V_L = percent leaking valves, calculated according to §63.168(e), at the time elected to use provisions of §63.168(d)(1)(ii)

(B) The owner or operator shall achieve less than 2 percent leaking valves no later than 2 years after electing to use the demonstration of progress provisions in §63.175(d) of this subpart.

(e) The following requirements shall be met if an owner or operator elects to use a quality improvement program of technology review and improvement:

(1) The owner or operator shall comply with the requirements in §63.168 of this subpart except the requirement for monthly monitoring in §63.168(d)(1)(i) of this subpart does not apply.

(2) The owner or operator shall collect the data specified below, and maintain records as required in §63.181(h)(2), for each valve in each process unit subject to the quality improvement program. The data may be collected and the records may be maintained on a process unit or group of process units basis. The data shall include the following:

(i) Valve type (e.g., ball, gate, check); valve manufacturer; valve design (e.g., external stem or actuating mechanism, flanged body); materials of construction; packing material; and year installed.

(ii) Service characteristics of the stream such as operating pressure, temperature, line diameter, and corrosivity.

(iii) Whether the valve is in gas or light liquid service.

(iv) The maximum instrument readings observed in each monitoring observation before repair, response factor for the stream if adjusted, instrument model number, and date of the observation.

(v) If a leak is detected, the repair methods used and the instrument readings after repair.

(vi) If the data will be analyzed as part of a larger analysis program involving data from other plants or other types of process units, a description of any maintenance or quality assurance programs used in the process unit that are intended to improve emission performance.

(3) The owner or operator shall continue to collect data on the valves as long as the process unit remains in the quality improvement program.

(4) The owner or operator shall inspect all valves removed from the process unit due to leaks. The inspection shall determine which parts of the valve have failed and shall include recommendations, as appropriate, for design changes or changes in specifications to reduce leak potential.

(5)(i) The owner or operator shall analyze the data collected to comply with the requirements of paragraph (e)(2) of this section to determine the services, operating or maintenance practices, and valve designs or technologies that have poorer than average emission performance and those that have better than average emission performance. The analysis shall determine if specific trouble areas can be identified on the basis of service, operating conditions or maintenance practices, equipment design, or other process specific factors.

(ii) The analysis shall also be used to identify any superior performing valve technologies that are applicable to the service(s), operating conditions, or valve designs associated with poorer than average emission performance. A superior performing valve technology is one for which a group of such valves has a leak frequency of less than 2 percent for specific applications in such a process unit. A candidate superior performing valve technology is one demonstrated or reported in the available literature or through a group study as having low emission performance and as being capable of achieving less than 2 percent leaking valves in the process unit.

(iii) The analysis shall include consideration of:

(A) The data obtained from the inspections of valves removed from the process unit due to leaks,

(B) Information from the available literature and from the experience of other plant sites that will identify valve designs or technologies and operating conditions associated with low emission performance for specific services, and

(C) Information on limitations on the service conditions for the valve design and operating conditions as well as information on maintenance procedures to ensure continued low emission performance.

(iv) The data analysis may be conducted through an inter- or intra-company program (or through some combination of the two approaches) and may be for a single process unit, a company, or a group of process units.

(v) The first analysis of the data shall be completed no later than 18 months after the start of Phase III. The first analysis shall be performed using a minimum of two quarters of data. An analysis of the data shall be done each year the process unit is in the quality improvement program.

(6) A trial evaluation program shall be conducted at each plant site for which the data analysis does not identify superior performing valve designs or technologies that can be applied to the operating conditions and services identified as having poorer than average performance, except as provided in paragraph (e)(6)(v) of this section. The trial program shall be used to evaluate the feasibility of using in the process unit the valve designs or technologies that have been identified by others as having low emission performance.

(i) The trial program shall include on-line trials of valves or operating and maintenance practices that have been identified in the available literature or in analysis by others as having the ability to perform with leak rates below 2 percent in similar services, as having low probability of failure, or as having no external actuating mechanism in contact with the process fluid. If any of the candidate superior performing valve technologies is not included in the performance trials, the reasons for rejecting specific technologies from consideration shall be documented as required in §63.181(h)(5)(ii) of this subpart.

(ii) The number of valves in the trial evaluation program shall be the lesser of 1 percent or 20 valves for programs involving single process units and the lesser of 1 percent or 50 valves for programs involving groups of process units.

(iii) The trial evaluation program shall specify and include documentation of:

(A) The candidate superior performing valve designs or technologies to be evaluated, the stages for evaluating the identified candidate valve designs or technologies, including the estimated time period necessary to test the applicability;

(B) The frequency of monitoring or inspection of the equipment;

(C) The range of operating conditions over which the component will be evaluated; and

(D) Conclusions regarding the emission performance and the appropriate operating conditions and services for the trial valves.

(iv) The performance trials shall initially be conducted for, at least, a 6-month period beginning not later than 18 months after the start of Phase III. Not later than 24 months after the start of Phase III, the

owner or operator shall have identified valve designs or technologies that, combined with appropriate process, operating, and maintenance practices, operate with low emission performance for specific applications in the process unit. The owner or operator shall continue to conduct performance trials as long as no superior performing design or technology has been identified, except as provided in paragraph (e)(6)(vi) of this section. The compilation of candidate and demonstrated superior emission performance valve designs or technologies shall be amended in the future, as appropriate, as additional information and experience is obtained.

(v) Any plant site with fewer than 400 valves and owned by a corporation with fewer than 100 total employees shall be exempt from trial evaluations of valves. Plant sites exempt from the trial evaluations of valves shall begin the program at the start of the fourth year of Phase III.

(vi) An owner or operator who has conducted performance trials on all candidate superior emission performance technologies suitable for the required applications in the process unit may stop conducting performance trials provided that a superior performing design or technology has been demonstrated or there are no technically feasible candidate superior technologies remaining. The owner or operator shall prepare an engineering evaluation documenting the physical, chemical, or engineering basis for the judgment that the superior emission performance technology is technically infeasible or demonstrating that it would not reduce emissions.

(7) Each owner or operator who elects to use a quality improvement program for technology review and improvement shall prepare and implement a valve quality assurance program that details purchasing specifications and maintenance procedures for all valves in the process unit. The quality assurance program may establish any number of categories, or classes, of valves as needed to distinguish among operating conditions and services associated with poorer than average emission performance as well as those associated with better than average emission performance. The quality assurance program shall be developed considering the findings of the data analysis required under paragraph (e)(5) of this section, if applicable, the findings of the trial evaluation required in paragraph (e)(6) of this section, and the operating conditions in the process unit. The quality assurance program shall be reviewed and, as appropriate, updated each year as long as the process unit has 2 percent or more leaking valves.

(i) The quality assurance program shall:

(A) Establish minimum design standards for each category of valves. The design standards shall specify known critical parameters such as tolerance, manufacturer, materials of construction, previous usage, or other applicable identified critical parameters;

(B) Require that all equipment orders specify the design standard (or minimum tolerances) for the valve;

(C) Include a written procedure for bench testing of valves that specifies performance criteria for acceptance of valves and specifies criteria for the precision and accuracy of the test apparatus. All valves repaired off-line after preparation of the quality assurance plan shall be bench-tested for leaks. This testing may be conducted by the owner or operator of the process unit, by the vendor, or by a designated representative. The owner or operator shall install only those valves that have been documented through bench-testing to be nonleaking.

(D) Require that all valves repaired on-line be monitored using the method specified in §63.180(b) of this subpart for leaks for 2 successive months, after repair.

(E) Provide for an audit procedure for quality control of purchased equipment to ensure conformance with purchase specifications. The audit program may be conducted by the owner or operator of the process unit or by a designated representative.

(F) Detail off-line valve maintenance and repair procedures. These procedures shall include provisions to ensure that rebuilt or refurbished valves will meet the design specifications for the valve type and will operate such that emissions are minimized.

(ii) The quality assurance program shall be established no later than the start of the third year of Phase III for plant sites with 400 or more valves or owned by a corporation with 100 or more employees; and no later than the start of the fourth year of Phase III for plant sites with less than 400 valves and owned by a corporation with less than 100 employees.

(8) Beginning at the start of the third year of Phase III for plant sites with 400 or more valves or owned by a corporation with 100 or more employees and at the start of the fourth year of Phase III for plant sites with less than 400 valves and owned by a corporation with less than 100 employees, each valve that is replaced for any reason shall be replaced with a new or modified valve that complies with the quality assurance standards for the valve category and that is identified as superior emission performance technology. Superior emission performance technology means valves or valve technologies identified with emission performance that, combined with appropriate process, operating, and maintenance practices, will result in less than 2 percent leaking valves for specific applications in a large population, except as provided in paragraph (e)(8)(ii) of this section.

(i) The valves shall be maintained as specified in the quality assurance program.

(ii) If a superior emission performance technology cannot be identified, then valve replacement shall be with one of (if several) the lowest emission performance technologies that has been identified for the specific application.

[59 FR 19568, Apr. 22, 1994, as amended at 60 FR 63631, Dec. 12, 1995]

§ 63.176 Quality improvement program for pumps.

(a) In Phase III, if, on a 6-month rolling average, the greater of either 10 percent of the pumps in a process unit (or plant site) or three pumps in a process unit (or plant site) leak, the owner or operator shall comply with the requirements of this section as specified below:

(1) Pumps that are in food/medical service or in polymerizing monomer service shall comply with all requirements except for those specified in paragraph (d)(8) of this section.

(2) Pumps that are not in food/medical or polymerizing monomer service shall comply with all requirements of this section.

(b) The owner or operator shall comply with the requirements of this section until the number of leaking pumps is less than the greater of either 10 percent of the pumps or three pumps, calculated as a 6-month rolling average, in the process unit (or plant site). Once the performance level is achieved, the owner or operator shall comply with the requirements in §63.163 of this subpart.

(c) If in a subsequent monitoring period, the process unit (or plant site) has greater than 10 percent of the pumps leaking or three pumps leaking (calculated as a 6-month rolling average), the owner or operator shall resume the quality improvement program starting at performance trials.

(d) The quality improvement program shall include the following:

(1) The owner or operator shall comply with the requirements in §63.163 of this subpart.

(2) The owner or operator shall collect the following data, and maintain records as required in §63.181(h)(3), for each pump in each process unit (or plant site) subject to the quality improvement program. The data may be collected and the records may be maintained on a process unit or plant site basis.

(i) Pump type (e.g., piston, horizontal or vertical centrifugal, gear, bellows); pump manufacturer; seal type and manufacturer; pump design (e.g., external shaft, flanged body); materials of construction; if applicable, barrier fluid or packing material; and year installed.

(ii) Service characteristics of the stream such as discharge pressure, temperature, flow rate, corrosivity, and annual operating hours.

(iii) The maximum instrument readings observed in each monitoring observation before repair, response factor for the stream if appropriate, instrument model number, and date of the observation.

(iv) If a leak is detected, the repair methods used and the instrument readings after repair.

(v) If the data will be analyzed as part of a larger analysis program involving data from other plants or other types of process units, a description of any maintenance or quality assurance programs used in the process unit that are intended to improve emission performance.

(3) The owner or operator shall continue to collect data on the pumps as long as the process unit (or plant site) remains in the quality improvement program.

(4) The owner or operator shall inspect all pumps or pump seals which exhibited frequent seal failures and were removed from the process unit due to leaks. The inspection shall determine the probable cause of the pump seal failure or of the pump leak and shall include recommendations, as appropriate, for design changes or changes in specifications to reduce leak potential.

(5)(i) The owner or operator shall analyze the data collected to comply with the requirements of paragraph (d)(2) of this section to determine the services, operating or maintenance practices, and pump or pump seal designs or technologies that have poorer than average emission performance and those that have better than average emission performance. The analysis shall determine if specific trouble areas can be identified on the basis of service, operating conditions or maintenance practices, equipment design, or other process specific factors.

(ii) The analysis shall also be used to determine if there are superior performing pump or pump seal technologies that are applicable to the service(s), operating conditions, or pump or pump seal designs associated with poorer than average emission performance. A superior performing pump or pump seal technology is one with a leak frequency of less than 10 percent for specific applications in the process unit or plant site. A candidate superior performing pump or pump seal technology is one demonstrated or reported in the available literature or through a group study as having low emission performance and as being capable of achieving less than 10 percent leaking pumps in the process unit (or plant site).

(iii) The analysis shall include consideration of:

(A) The data obtained from the inspections of pumps and pump seals removed from the process unit due to leaks;

(B) Information from the available literature and from the experience of other plant sites that will identify pump designs or technologies and operating conditions associated with low emission performance for specific services; and

(C) Information on limitations on the service conditions for the pump seal technology operating conditions as well as information on maintenance procedures to ensure continued low emission performance.

(iv) The data analysis may be conducted through an inter- or intra-company program (or through some combination of the two approaches) and may be for a single process unit, a plant site, a company, or a group of process units.

(v) The first analysis of the data shall be completed no later than 18 months after the start of the quality improvement program. The first analysis shall be performed using a minimum of 6 months of data. An analysis of the data shall be done each year the process unit is in the quality improvement program.

(6) A trial evaluation program shall be conducted at each plant site for which the data analysis does not identify use of superior performing pump seal technology or pumps that can be applied to the areas identified as having poorer than average performance, except as provided in paragraph (d)(6)(v) of this section. The trial program shall be used to evaluate the feasibility of using in the process unit (or plant site) the pump designs or seal technologies, and operating and maintenance practices that have been identified by others as having low emission performance.

(i) The trial program shall include on-line trials of pump seal technologies or pump designs and operating and maintenance practices that have been identified in the available literature or in analysis by others as having the ability to perform with leak rates below 10 percent in similar services, as having low probability of failure, or as having no external actuating mechanism in contact with the process fluid. If any of the candidate superior performing pump seal technologies or pumps is not included in the performance trials, the reasons for rejecting specific technologies from consideration shall be

documented as required in §63.181(h)(5)(ii).

(ii) The number of pump seal technologies or pumps in the trial evaluation program shall be the lesser of 1 percent or two pumps for programs involving single process units and the lesser of 1 percent or five pumps for programs involving a plant site or groups of process units. The minimum number of pumps or pump seal technologies in a trial program shall be one.

(iii) The trial evaluation program shall specify and include documentation of:

(A) The candidate superior performing pump seal designs or technologies to be evaluated, the stages for evaluating the identified candidate pump designs or pump seal technologies, including the time period necessary to test the applicability;

(B) The frequency of monitoring or inspection of the equipment;

(C) The range of operating conditions over which the component will be evaluated; and

(D) Conclusions regarding the emission performance and the appropriate operating conditions and services for the trial pump seal technologies or pumps.

(iv) The performance trials shall initially be conducted, at least, for a 6-month period beginning not later than 18 months after the start of the quality improvement program. No later than 24 months after the start of the quality improvement program, the owner or operator shall have identified pump seal technologies or pump designs that, combined with appropriate process, operating, and maintenance practices, operate with low emission performance for specific applications in the process unit. The owner or operator shall continue to conduct performance trials as long as no superior performing design or technology has been identified, except as provided in paragraph (d)(6)(vi) of this section. The initial list of superior emission performance pump designs or pump seal technologies shall be amended in the future, as appropriate, as additional information and experience is obtained.

(v) Any plant site with fewer than 400 valves and owned by a corporation with fewer than 100 employees shall be exempt from trial evaluations of pump seals or pump designs. Plant sites exempt from the trial evaluations of pumps shall begin the pump seal or pump replacement program at the start of the fourth year of the quality improvement program.

(vi) An owner or operator who has conducted performance trials on all alternative superior emission performance technologies suitable for the required applications in the process unit may stop conducting performance trials provided that a superior performing design or technology has been demonstrated or there are no technically feasible alternative superior technologies remaining. The owner or operator shall prepare an engineering evaluation documenting the physical, chemical, or engineering basis for the judgment that the superior emission performance technology is technically infeasible or demonstrating that it would not reduce emissions.

(7) Each owner or operator shall prepare and implement a pump quality assurance program that details purchasing specifications and maintenance procedures for all pumps and pump seals in the process unit. The quality assurance program may establish any number of categories, or classes, of pumps as needed to distinguish among operating conditions and services associated with poorer than average emission performance as well as those associated with better than average emission performance. The quality assurance program shall be developed considering the findings of the data analysis required under paragraph (d)(5) of this section, if applicable, the findings of the trial evaluation required in paragraph (d)(6) of this section, and the operating conditions in the process unit. The quality assurance program shall be updated each year as long as the process unit has the greater of either 10 percent or more leaking pumps or has three leaking pumps.

(i) The quality assurance program shall:

(A) Establish minimum design standards for each category of pumps or pump seal technology. The design standards shall specify known critical parameters such as tolerance, manufacturer, materials of construction, previous usage, or other applicable identified critical parameters;

(B) Require that all equipment orders specify the design standard (or minimum tolerances) for the pump

or the pump seal;

(C) Provide for an audit procedure for quality control of purchased equipment to ensure conformance with purchase specifications. The audit program may be conducted by the owner or operator of the plant site or process unit or by a designated representative; and

(D) Detail off-line pump maintenance and repair procedures. These procedures shall include provisions to ensure that rebuilt or refurbished pumps and pump seals will meet the design specifications for the pump category and will operate such that emissions are minimized.

(ii) The quality assurance program shall be established no later than the start of the third year of the quality improvement program for plant sites with 400 or more valves or 100 or more employees; and no later than the start of the fourth year of the quality improvement program for plant sites with less than 400 valves and less than 100 employees.

(8) Beginning at the start of the third year of the quality improvement program for plant sites with 400 or more valves or 100 or more employees and at the start of the fourth year of the quality improvement program for plant sites with less than 400 valves and less than 100 employees, the owner or operator shall replace, as described in paragraphs (d)(8)(i) and (d)(8)(ii) of this section, the pumps or pump seals that are not superior emission performance technology with pumps or pump seals that have been identified as superior emission performance technology and that comply with the quality assurance standards for the pump category. Superior emission performance technology is that category or design of pumps or pump seals with emission performance which, when combined with appropriate process, operating, and maintenance practices, will result in less than 10 percent leaking pumps for specific applications in the process unit or plant site. Superior emission performance technology includes material or design changes to the existing pump, pump seal, seal support system, installation of multiple mechanical seals or equivalent, or pump replacement.

(i) Pumps or pump seals shall be replaced at the rate of 20 percent per year based on the total number of pumps in light liquid service. The calculated value shall be rounded to the nearest nonzero integer value. The minimum number of pumps or pump seals shall be one. Pump replacement shall continue until all pumps subject to the requirements of §63.163 of this subpart are pumps determined to be superior performance technology.

(ii) The owner or operator may delay replacement of pump seals or pumps with superior technology until the next planned process unit shutdown, provided the number of pump seals and pumps replaced is equivalent to the 20 percent or greater annual replacement rate.

(iii) The pumps shall be maintained as specified in the quality assurance program.

§ 63.177 Alternative means of emission limitation: General.

(a) Permission to use an alternative means of emission limitation under section 112(h)(3) of the Act shall be governed by the following procedures in paragraphs (b) through (e) of this section.

(b) Where the standard is an equipment, design, or operational requirement:

(1) Each owner or operator applying for permission to use an alternative means of emission limitation under §63.6(g) of subpart A of this part shall be responsible for collecting and verifying emission performance test data for an alternative means of emission limitation.

(2) The Administrator will compare test data for the means of emission limitation to test data for the equipment, design, and operational requirements.

(3) The Administrator may condition the permission on requirements that may be necessary to ensure operation and maintenance to achieve the same emission reduction as the equipment, design, and operational requirements.

(c) Where the standard is a work practice:

- (1) Each owner or operator applying for permission shall be responsible for collecting and verifying test data for an alternative means of emission limitation.
 - (2) For each kind of equipment for which permission is requested, the emission reduction achieved by the required work practices shall be demonstrated for a minimum period of 12 months.
 - (3) For each kind of equipment for which permission is requested, the emission reduction achieved by the alternative means of emission limitation shall be demonstrated.
 - (4) Each owner or operator applying for permission shall commit, in writing, for each kind of equipment to work practices that provide for emission reductions equal to or greater than the emission reductions achieved by the required work practices.
 - (5) The Administrator will compare the demonstrated emission reduction for the alternative means of emission limitation to the demonstrated emission reduction for the required work practices and will consider the commitment in paragraph (c)(4) of this section.
 - (6) The Administrator may condition the permission on requirements that may be necessary to ensure operation and maintenance to achieve the same or greater emission reduction as the required work practices of this subpart.
- (d) An owner or operator may offer a unique approach to demonstrate the alternative means of emission limitation.
- (e)(1) Manufacturers of equipment used to control equipment leaks of an organic HAP may apply to the Administrator for permission for an alternative means of emission limitation that achieves a reduction in emissions of the organic HAP achieved by the equipment, design, and operational requirements of this subpart.
- (2) The Administrator will grant permission according to the provisions of paragraphs (b), (c), and (d) of this section.

§ 63.178 Alternative means of emission limitation: Batch processes.

- (a) As an alternative to complying with the requirements of §§63.163 through 63.171 and §§63.173 through 63.176, an owner or operator of a batch process that operates in organic HAP service during the calendar year may comply with one of the standards specified in paragraphs (b) and (c) of this section, or the owner or operator may petition for approval of an alternative standard under the provisions of §63.177 of this subpart. The alternative standards of this section provide the options of pressure testing or monitoring the equipment for leaks. The owner or operator may switch among the alternatives provided the change is documented as specified in §63.181.
- (b) The following requirements shall be met if an owner or operator elects to use pressure testing of batch product-process equipment to demonstrate compliance with this subpart. An owner or operator who complies with the provisions of this paragraph is exempt from the monitoring provisions of §63.163, §63.168 and 63.169, and §§63.173 through 63.176 of this subpart.
- (1) Each time equipment is reconfigured for production of a different product or intermediate, the batch product-process equipment train shall be pressure-tested for leaks before organic HAP is first fed to the equipment and the equipment is placed in organic HAP service.
 - (i) When the batch product-process train is reconfigured to produce a different product, pressure testing is required only for the new or disturbed equipment.
 - (ii) Each batch product process that operates in organic HAP service during a calendar year shall be pressure tested at least once during that calendar year.
 - (iii) Pressure testing is not required for routine seal breaks, such as changing hoses or filters, which are not part of the reconfiguration to produce a different product or intermediate.

(2) The batch product process equipment shall be tested either using the procedures specified in §63.180(f) of this subpart for pressure or vacuum loss or with a liquid using the procedures specified in §63.180(g) of this subpart.

(3)(i) For pressure or vacuum tests, a leak is detected if the rate of change in pressure is greater than 6.9 kilopascals (1 psig) in 1 hour or if there is visible, audible, or olfactory evidence of fluid loss.

(ii) For pressure tests using a liquid, a leak is detected if there are indications of liquids dripping or if there is other evidence of fluid loss.

(4)(i) If a leak is detected, it shall be repaired and the batch product-process equipment shall be retested before start-up of the process.

(ii) If a batch product-process fails the retest or the second of two consecutive pressure tests, it shall be repaired as soon as practicable, but not later than 30 calendar days after the second pressure test, provided the conditions specified in paragraph (d) of this section are met.

(c) The following requirements shall be met if an owner or operator elects to monitor the equipment to detect leaks by the method specified in §63.180(b) of this subpart to demonstrate compliance with this subpart.

(1) The owner or operator shall comply with the requirements of §§63.163 through 63.170, and §§63.172 through 63.176 of this subpart.

(2) The equipment shall be monitored for leaks by the method specified in §63.180(b) of this subpart when the equipment is in organic HAP service, in use with an acceptable surrogate volatile organic compound which is not an organic HAP, or is in use with any other detectable gas or vapor.

(3) The equipment shall be monitored for leaks as specified below:

(i) Each time the equipment is reconfigured for the production of a new product, the reconfigured equipment shall be monitored for leaks within 30 days of start-up of the process. This initial monitoring of reconfigured equipment shall not be included in determining percent leaking equipment in the process unit.

(ii) Connectors shall be monitored in accordance with the requirements in §63.174 of this subpart.

(iii) Equipment other than connectors shall be monitored at the frequencies specified in table 1 of this subpart. The operating time shall be determined as the proportion of the year the batch product-process that is subject to the provisions of this subpart is operating.

(iv) The monitoring frequencies specified in table 1 of this subpart are not requirements for monitoring at specific intervals and can be adjusted to accommodate process operations. An owner or operator may monitor anytime during the specified monitoring period (e.g., month, quarter, year), provided the monitoring is conducted at a reasonable interval after completion of the last monitoring campaign. For example, if the equipment is not operating during the scheduled monitoring period, the monitoring can be done during the next period when the process is operating.

(4) If a leak is detected, it shall be repaired as soon as practicable but not later than 15 calendar days after it is detected, except as provided in paragraph (d) of this section.

(d) Delay of repair of equipment for which leaks have been detected is allowed if the replacement equipment is not available providing the following conditions are met:

(1) Equipment supplies have been depleted and supplies had been sufficiently stocked before the supplies were depleted.

(2) The repair is made no later than 10 calendar days after delivery of the replacement equipment.

§ 63.179 Alternative means of emission limitation: Enclosed-vented process units.

Process units enclosed in such a manner that all emissions from equipment leaks are vented through a closed-vent system to a control device meeting the requirements of §63.172 of this subpart are exempt from the requirements of §63.163, through 63.171, and §§63.173 and 63.174 of this subpart. The enclosure shall be maintained under a negative pressure at all times while the process unit is in operation to ensure that all emissions are routed to a control device.

§ 63.180 Test methods and procedures.

(a) Each owner or operator subject to the provisions of this subpart shall comply with the test methods and procedures requirements provided in this section.

(b) Monitoring, as required under this subpart, shall comply with the following requirements:

(1) Monitoring shall comply with Method 21 of 40 CFR part 60, appendix A.

(2)(i) Except as provided for in paragraph (b)(2)(ii) of this section, the detection instrument shall meet the performance criteria of Method 21 of 40 CFR part 60, appendix A, except the instrument response factor criteria in Section 3.1.2(a) of Method 21 shall be for the average composition of the process fluid not each individual VOC in the stream. For process streams that contain nitrogen, water, air, or other inerts which are not organic HAP's or VOC's, the average stream response factor may be calculated on an inert-free basis. The response factor may be determined at any concentration for which monitoring for leaks will be conducted.

(ii) If no instrument is available at the plant site that will meet the performance criteria specified in paragraph (b)(2)(i) of this section, the instrument readings may be adjusted by multiplying by the average response factor of the process fluid, calculated on an inert-free basis as described in paragraph (b)(2)(i) of this section.

(3) The instrument shall be calibrated before use on each day of its use by the procedures specified in Method 21 of 40 CFR part 60, appendix A.

(4) Calibration gases shall be:

(i) Zero air (less than 10 parts per million of hydrocarbon in air); and

(ii) Mixtures of methane in air at the concentrations specified in paragraphs (b)(4)(ii)(A) through (b)(4)(ii)(C) of this section. A calibration gas other than methane in air may be used if the instrument does not respond to methane or if the instrument does not meet the performance criteria specified in paragraph (b)(2)(i) of this section. In such cases, the calibration gas may be a mixture of one or more of the compounds to be measured in air.

(A) For Phase I, a mixture of methane or other compounds, as applicable, in air at a concentration of approximately, but less than, 10,000 parts per million.

(B) For Phase II, a mixture of methane or other compounds, as applicable, and air at a concentration of approximately, but less than, 10,000 parts per million for agitators, 5,000 parts per million for pumps, and 500 parts per million for all other equipment, except as provided in paragraph (b)(4)(iii) of this section.

(C) For Phase III, a mixture of methane or other compounds, as applicable, and air at a concentration of approximately, but less than, 10,000 parts per million methane for agitators; 2,000 parts per million for pumps in food/medical service; 5,000 parts per million for pumps in polymerizing monomer service; 1,000 parts per million for all other pumps; and 500 parts per million for all other equipment, except as provided in paragraph (b)(4)(iii) of this section.

(iii) The instrument may be calibrated at a higher methane concentration than the concentration specified for that piece of equipment. The concentration of the calibration gas may exceed the concentration specified as a leak by no more than 2,000 parts per million. If the monitoring instrument's

design allows for multiple calibration scales, then the lower scale shall be calibrated with a calibration gas that is no higher than 2,000 parts per million above the concentration specified as a leak and the highest scale shall be calibrated with a calibration gas that is approximately equal to 10,000 parts per million. If only one scale on an instrument will be used during monitoring, the owner or operator need not calibrate the scales that will not be used during that day's monitoring.

(5) Monitoring shall be performed when the equipment is in organic HAP service, in use with an acceptable surrogate volatile organic compound which is not an organic HAP, or is in use with any other detectable gas or vapor.

(6) Monitoring data that do not meet the criteria specified in paragraphs (b)(1) through (b)(5) of this section may be used to qualify for less frequent monitoring under the provisions in §63.168(d)(2) and (d)(3) or §63.174(b)(3)(ii) or (b)(3)(iii) of this subpart provided the data meet the conditions specified in paragraphs (b)(6)(i) and (b)(6)(ii) of this section.

(i) The data were obtained before April 22, 1994.

(ii) The departures from the criteria specified in paragraphs (b)(1) through (b)(5) of this section or from the specified monitoring frequency of §63.168(c) are minor and do not significantly affect the quality of the data. Examples of minor departures are monitoring at a slightly different frequency (such as every six weeks instead of monthly or quarterly), following the performance criteria of section 3.1.2(a) of Method 21 of appendix A of 40 CFR part 60 instead of paragraph (b)(2) of this section, or monitoring at a different leak definition if the data would indicate the presence or absence of a leak at the concentration specified in this subpart. Failure to use a calibrated instrument is not considered a minor departure.

(c) When equipment is monitored for compliance as required in §§63.164(i), 63.165(a), and 63.172(f) or when equipment subject to a leak definition of 500 ppm is monitored for leaks as required by this subpart, the owner or operator may elect to adjust or not to adjust the instrument readings for background. If an owner or operator elects to not adjust instrument readings for background, the owner or operator shall monitor the equipment according to the procedures specified in paragraphs (b)(1) through (b)(4) of this section. In such case, all instrument readings shall be compared directly to the applicable leak definition to determine whether there is a leak. If an owner or operator elects to adjust instrument readings for background, the owner or operator shall monitor the equipment according to the procedures specified in paragraphs (c)(1) through (c)(4) of this section.

(1) The requirements of paragraphs (b) (1) through (4) of this section shall apply.

(2) The background level shall be determined, using the same procedures that will be used to determine whether the equipment is leaking.

(3) The instrument probe shall be traversed around all potential leak interfaces as close to the interface as possible as described in Method 21 of 40 CFR part 60, appendix A.

(4) The arithmetic difference between the maximum concentration indicated by the instrument and the background level is compared with 500 parts per million for determining compliance.

(d)(1) Each piece of equipment within a process unit that can reasonably be expected to contain equipment in organic HAP service is presumed to be in organic HAP service unless an owner or operator demonstrates that the piece of equipment is not in organic HAP service. For a piece of equipment to be considered not in organic HAP service, it must be determined that the percent organic HAP content can be reasonably expected not to exceed 5 percent by weight on an annual average basis. For purposes of determining the percent organic HAP content of the process fluid that is contained in or contacts equipment, Method 18 of 40 CFR part 60, appendix A shall be used.

(2)(i) An owner or operator may use good engineering judgment rather than the procedures in paragraph (d)(1) of this section to determine that the percent organic HAP content does not exceed 5 percent by weight. When an owner or operator and the Administrator do not agree on whether a piece of equipment is not in organic HAP service, however, the procedures in paragraph (d)(1) of this section shall be used to resolve the disagreement.

(ii) Conversely, the owner or operator may determine that the organic HAP content of the process fluid

does not exceed 5 percent by weight by, for example, accounting for 98 percent of the content and showing that organic HAP is less than 3 percent.

(3) If an owner or operator determines that a piece of equipment is in organic HAP service, the determination can be revised after following the procedures in paragraph (d)(1) of this section, or by documenting that a change in the process or raw materials no longer causes the equipment to be in organic HAP service.

(4) Samples used in determining the percent organic HAP content shall be representative of the process fluid that is contained in or contacts the equipment.

(e) When a flare is used to comply with §63.172(d), the owner or operator shall comply with paragraphs (e)(1) through (3) of this section. The owner or operator is not required to conduct a performance test to determine percent emission reduction or outlet organic HAP or TOC concentration.

(1) Conduct a visible emission test using the techniques specified in §63.11(b)(4).

(2) Determine the net heating value of the gas being combusted using the techniques specified in §63.11(b)(6).

(3) Determine the exit velocity using the techniques specified in either §63.11(b)(7)(i) (and §63.11(b)(7)(iii), where applicable) or §63.11(b)(8), as appropriate.

(f) The following procedures shall be used to pressure test batch product-process equipment for pressure or vacuum loss to demonstrate compliance with the requirements of §63.178(b)(3)(i) of this subpart.

(1) The batch product-process equipment train shall be pressurized with a gas to a pressure less than the set pressure of any safety relief devices or valves or to a pressure slightly above the operating pressure of the equipment, or alternatively, the equipment shall be placed under a vacuum.

(2) Once the test pressure is obtained, the gas source or vacuum source shall be shut off.

(3) The test shall continue for not less than 15 minutes unless it can be determined in a shorter period of time that the allowable rate of pressure drop or of pressure rise was exceeded. The pressure in the batch product-process equipment shall be measured after the gas or vacuum source is shut off and at the end of the test period. The rate of change in pressure in the batch product-process equipment shall be calculated using the following equation:

$$\Delta \frac{P}{t} = \frac{(P_f - P_i)}{(t_f - t_i)}$$

where:

$\Delta P/t$ =Change in pressure, psig/hr.

P_f =Final pressure, psig.

P_i =Initial pressure, psig.

$t_f - t_i$ =Elapsed time, hours.

(4) The pressure shall be measured using a pressure measurement device (gauge, manometer, or equivalent) which has a precision of ± 2.5 millimeter mercury in the range of test pressure and is capable of measuring pressures up to the relief set pressure of the pressure relief device. If such a pressure

measurement device is not reasonably available, the owner or operator shall use a pressure measurement device with a precision of at least +10 percent of the test pressure of the equipment and shall extend the duration of the test for the time necessary to detect a pressure loss or rise that equals a rate of one psig per hour.

(5) An alternative procedure may be used for leak testing the equipment if the owner or operator demonstrates the alternative procedure is capable of detecting a pressure loss or rise.

(g) The following procedures shall be used to pressure-test batch product-process equipment using a liquid to demonstrate compliance with the requirements of §63.178(b)(3)(ii) of this subpart.

(1) The batch product-process equipment train, or section of the train, shall be filled with the test liquid (e.g., water, alcohol) until normal operating pressure is obtained. Once the equipment is filled, the liquid source shall be shut off.

(2) The test shall be conducted for a period of at least 60 minutes, unless it can be determined in a shorter period of time that the test is a failure.

(3) Each seal in the equipment being tested shall be inspected for indications of liquid dripping or other indications of fluid loss. If there are any indications of liquids dripping or of fluid loss, a leak is detected.

(4) An alternative procedure may be used for leak testing the equipment, if the owner or operator demonstrates the alternative procedure is capable of detecting losses of fluid.

[59 FR 19568, Apr. 22, 1994, as amended at 59 FR 48177, Sept. 20, 1994; 61 FR 31440, June 20, 1996; 62 FR 2792, Jan. 17, 1997; 66 FR 6936, Jan. 22, 2001]

§ 63.181 Recordkeeping requirements.

(a) An owner or operator of more than one process unit subject to the provisions of this subpart may comply with the recordkeeping requirements for these process units in one recordkeeping system if the system identifies each record by process unit and the program being implemented (e.g., quarterly monitoring, quality improvement) for each type of equipment. All records and information required by this section shall be maintained in a manner that can be readily accessed at the plant site. This could include physically locating the records at the plant site or accessing the records from a central location by computer at the plant site.

(b) Except as provided in paragraph (e) of this section, the following information pertaining to all equipment in each process unit subject to the requirements in §§63.162 through 63.174 of this subpart shall be recorded:

(1)(i) A list of identification numbers for equipment (except connectors exempt from monitoring and recordkeeping identified in §63.174 of this subpart and instrumentation systems) subject to the requirements of this subpart. Connectors need not be individually identified if all connectors in a designated area or length of pipe subject to the provisions of this subpart are identified as a group, and the number of connectors subject is indicated. With respect to connectors, the list shall be complete no later than the completion of the initial survey required by §63.174 (b)(1) or (b)(2) of this subpart.

(ii) A schedule by process unit for monitoring connectors subject to the provisions of §63.174(a) of this subpart and valves subject to the provisions of §63.168(d) of this subpart.

(iii) Physical tagging of the equipment to indicate that it is in organic HAP service is not required. Equipment subject to the provisions of this subpart may be identified on a plant site plan, in log entries, or by other appropriate methods.

(2)(i) A list of identification numbers for equipment that the owner or operator elects to equip with a closed-vent system and control device, under the provisions of §63.163(g), §63.164(h), §63.165(c), or §63.173(f) of this subpart.

(ii) A list of identification numbers for compressors that the owner or operator elects to designate as

operating with an instrument reading of less than 500 parts per million above background, under the provisions of §63.164(i) of this subpart.

(iii) Identification of surge control vessels or bottoms receivers subject to the provisions of this subpart that the owner or operator elects to equip with a closed-vent system and control device, under the provisions of §63.170 of this subpart.

(3)(i) A list of identification numbers for pressure relief devices subject to the provisions in §63.165(a) of this subpart.

(ii) A list of identification numbers for pressure relief devices equipped with rupture disks, under the provisions of §63.165(d) of this subpart.

(4) Identification of instrumentation systems subject to the provisions of this subpart. Individual components in an instrumentation system need not be identified.

(5) Identification of screwed connectors subject to the requirements of §63.174(c)(2) of this subpart. Identification can be by area or grouping as long as the total number within each group or area is recorded.

(6) The following information shall be recorded for each dual mechanical seal system:

(i) Design criteria required in §§63.163(e)(6)(i), 63.164(e)(2), and 63.173(d)(6)(i) of this subpart and an explanation of the design criteria; and

(ii) Any changes to these criteria and the reasons for the changes.

(7) The following information pertaining to all pumps subject to the provisions of §63.163(j), valves subject to the provisions of §63.168(h) and (i) of this subpart, agitators subject to the provisions of §63.173(h) through (j), and connectors subject to the provisions of §63.174(f) and (g) of this subpart shall be recorded:

(i) Identification of equipment designated as unsafe to monitor, difficult to monitor, or unsafe to inspect and the plan for monitoring or inspecting this equipment.

(ii) A list of identification numbers for the equipment that is designated as difficult to monitor, an explanation of why the equipment is difficult to monitor, and the planned schedule for monitoring this equipment.

(iii) A list of identification numbers for connectors that are designated as unsafe to repair and an explanation why the connector is unsafe to repair.

(8)(i) A list of valves removed from and added to the process unit, as described in §63.168(e)(1) of this subpart, if the net credits for removed valves is expected to be used.

(ii) A list of connectors removed from and added to the process unit, as described in §63.174(i)(1) of this subpart, and documentation of the integrity of the weld for any removed connectors, as required in §63.174(j) of this subpart. This is not required unless the net credits for removed connectors is expected to be used.

(9)(i) For batch process units that the owner or operator elects to monitor as provided under §63.178(c) of this subpart, a list of equipment added to batch product process units since the last monitoring period required in §63.178(c)(3)(ii) and (3)(iii) of this subpart.

(ii) Records demonstrating the proportion of the time during the calendar year the equipment is in use in a batch process that is subject to the provisions of this subpart. Examples of suitable documentation are records of time in use for individual pieces of equipment or average time in use for the process unit. These records are not required if the owner or operator does not adjust monitoring frequency by the time in use, as provided in §63.178(c)(3)(iii) of this subpart.

(10) For any leaks detected as specified in §§63.163 and 63.164; §§63.168 and 63.169; and §§63.172 through 63.174 of this subpart, a weatherproof and readily visible identification, marked with the equipment identification number, shall be attached to the leaking equipment.

(c) For visual inspections of equipment subject to the provisions of this subpart (e.g., §63.163(b)(3), §63.163(e)(4)(i)), the owner or operator shall document that the inspection was conducted and the date of the inspection. The owner or operator shall maintain records as specified in paragraph (d) of this section for leaking equipment identified in this inspection, except as provided in paragraph (e) of this section. These records shall be retained for 2 years.

(d) When each leak is detected as specified in §§63.163 and 63.164; §§63.168 and 63.169; and §§63.172 through 63.174 of this subpart, the following information shall be recorded and kept for 2 years:

(1) The instrument and the equipment identification number and the operator name, initials, or identification number.

(2) The date the leak was detected and the date of first attempt to repair the leak.

(3) The date of successful repair of the leak.

(4) Maximum instrument reading measured by Method 21 of 40 CFR part 60, appendix A after it is successfully repaired or determined to be nonreparable.

(5) "Repair delayed" and the reason for the delay if a leak is not repaired within 15 calendar days after discovery of the leak.

(i) The owner or operator may develop a written procedure that identifies the conditions that justify a delay of repair. The written procedures may be included as part of the startup/shutdown/malfunction plan, required by §63.6(e)(3), for the source or may be part of a separate document that is maintained at the plant site. In such cases, reasons for delay of repair may be documented by citing the relevant sections of the written procedure.

(ii) If delay of repair was caused by depletion of stocked parts, there must be documentation that the spare parts were sufficiently stocked on-site before depletion and the reason for depletion.

(6) Dates of process unit shutdowns that occur while the equipment is unrepaired.

(7)(i) Identification, either by list, location (area or grouping), or tagging of connectors that have been opened or otherwise had the seal broken since the last monitoring period required in §63.174(b) of this subpart, as described in §63.174(c)(1) of this subpart, unless the owner or operator elects to comply with the provisions of §63.174(c)(1)(ii) of this subpart.

(ii) The date and results of monitoring as required in §63.174(c) of this subpart. If identification of connectors that have been opened or otherwise had the seal broken is made by location under paragraph (d)(7)(i) of this section, then all connectors within the designated location shall be monitored.

(8) The date and results of the monitoring required in §63.178(c)(3)(i) of this subpart for equipment added to a batch process unit since the last monitoring period required in §63.178 (c)(3)(ii) and (c)(3)(iii) of this subpart. If no leaking equipment is found in this monitoring, the owner or operator shall record that the inspection was performed. Records of the actual monitoring results are not required.

(9) Copies of the periodic reports as specified in §63.182(d) of this subpart, if records are not maintained on a computerized database capable of generating summary reports from the records.

(e) The owner or operator of a batch product process who elects to pressure test the batch product process equipment train to demonstrate compliance with this subpart is exempt from the requirements of paragraphs (b), (c), (d), and (f) of this section. Instead, the owner or operator shall maintain records of the following information:

(1) The identification of each product, or product code, produced during the calendar year. It is not necessary to identify individual items of equipment in a batch product process equipment train.

(2) [Reserved]

(3) Physical tagging of the equipment to identify that it is in organic HAP service and subject to the provisions of this subpart is not required. Equipment in a batch product process subject to the provisions of this subpart may be identified on a plant site plan, in log entries, or by other appropriate methods.

(4) The dates of each pressure test required in §63.178(b) of this subpart, the test pressure, and the pressure drop observed during the test.

(5) Records of any visible, audible, or olfactory evidence of fluid loss.

(6) When a batch product process equipment train does not pass two consecutive pressure tests, the following information shall be recorded in a log and kept for 2 years:

(i) The date of each pressure test and the date of each leak repair attempt.

(ii) Repair methods applied in each attempt to repair the leak.

(iii) The reason for the delay of repair.

(iv) The expected date for delivery of the replacement equipment and the actual date of delivery of the replacement equipment.

(v) The date of successful repair.

(f) The dates and results of each compliance test required for compressors subject to the provisions in §63.164(i) and the dates and results of the monitoring following a pressure release for each pressure relief device subject to the provisions in §§63.165 (a) and (b) of this subpart. The results shall include:

(1) The background level measured during each compliance test.

(2) The maximum instrument reading measured at each piece of equipment during each compliance test.

(g) The owner or operator shall maintain records of the information specified in paragraphs (g)(1) through (g)(3) of this section for closed-vent systems and control devices subject to the provisions of §63.172 of this subpart. The records specified in paragraph (g)(1) of this section shall be retained for the life of the equipment. The records specified in paragraphs (g)(2) and (g)(3) of this section shall be retained for 2 years.

(1) The design specifications and performance demonstrations specified in paragraphs (g)(1)(i) through (g)(1)(iv) of this section.

(i) Detailed schematics, design specifications of the control device, and piping and instrumentation diagrams.

(ii) The dates and descriptions of any changes in the design specifications.

(iii) The flare design (i.e., steam-assisted, air-assisted, or non-assisted) and the results of the compliance demonstration required by §63.11(b) of subpart A of this part.

(iv) A description of the parameter or parameters monitored, as required in §63.172(e) of this subpart, to ensure that control devices are operated and maintained in conformance with their design and an explanation of why that parameter (or parameters) was selected for the monitoring.

(2) Records of operation of closed-vent systems and control devices, as specified in paragraphs (g)(2)(i) through (g)(2)(iii) of this section.

(i) Dates and durations when the closed-vent systems and control devices required in §§63.163 through 63.166, and §63.170 of this subpart are not operated as designed as indicated by the monitored parameters, including periods when a flare pilot light system does not have a flame.

(ii) Dates and durations during which the monitoring system or monitoring device is inoperative.

(iii) Dates and durations of start-ups and shutdowns of control devices required in §§63.163 through 63.166, and §63.170 of this subpart.

(3) Records of inspections of closed-vent systems subject to the provisions of §63.172 of this subpart, as specified in paragraphs (g)(3)(i) and (g)(3)(ii) of this section.

(i) For each inspection conducted in accordance with the provisions of §63.172(f)(1) or (f)(2) of this subpart during which no leaks were detected, a record that the inspection was performed, the date of the inspection, and a statement that no leaks were detected.

(ii) For each inspection conducted in accordance with the provisions of §63.172(f)(1) or (f)(2) of this subpart during which leaks were detected, the information specified in paragraph (d) of this section shall be recorded.

(h) Each owner or operator of a process unit subject to the requirements of §§63.175 and 63.176 of this subpart shall maintain the records specified in paragraphs (h)(1) through (h)(9) of this section for the period of the quality improvement program for the process unit.

(1) For owners or operators who elect to use a reasonable further progress quality improvement program, as specified in §63.175(d) of this subpart:

(i) All data required in §63.175(d)(2) of this subpart.

(ii) The percent leaking valves observed each quarter and the rolling average percent reduction observed in each quarter.

(iii) The beginning and ending dates while meeting the requirements of §63.175(d) of this subpart.

(2) For owners or operators who elect to use a quality improvement program of technology review and improvement, as specified in §63.175(e) of this subpart:

(i) All data required in §63.175(e)(2) of this subpart.

(ii) The percent leaking valves observed each quarter.

(iii) Documentation of all inspections conducted under the requirements of §63.175(e)(4) of this subpart, and any recommendations for design or specification changes to reduce leak frequency.

(iv) The beginning and ending dates while meeting the requirements of §63.175(e) of this subpart.

(3) For owners or operators subject to the requirements of the pump quality improvement program as specified in §63.176 of this subpart:

(i) All data required in §63.176(d)(2) of this subpart.

(ii) The rolling average percent leaking pumps.

(iii) Documentation of all inspections conducted under the requirements of §63.176(d)(4) of this subpart, and any recommendations for design or specification changes to reduce leak frequency.

(iv) The beginning and ending dates while meeting the requirements of §63.176(d) of this subpart.

(4) If a leak is not repaired within 15 calendar days after discovery of the leak, the reason for the delay and the expected date of successful repair.

(5) Records of all analyses required in §§63.175(e) and 63.176(d) of this subpart. The records will include the following:

(i) A list identifying areas associated with poorer than average performance and the associated service characteristics of the stream, the operating conditions and maintenance practices.

(ii) The reasons for rejecting specific candidate superior emission performing valve or pump technology from performance trials.

(iii) The list of candidate superior emission performing valve or pump technologies, and documentation of the performance trial program items required under §§63.175(e)(6)(iii) and 63.176(d)(6)(iii) of this subpart.

(iv) The beginning date and duration of performance trials of each candidate superior emission performing technology.

(6) All records documenting the quality assurance program for valves or pumps as specified in §§63.175(e)(7) and 63.176(d)(7) of this subpart.

(7) Records indicating that all valves or pumps replaced or modified during the period of the quality improvement program are in compliance with the quality assurance requirements in §63.175(e)(7) and §63.176(d)(7) of this subpart.

(8) Records documenting compliance with the 20 percent or greater annual replacement rate for pumps as specified in §63.176(d)(8) of this subpart.

(9) Information and data to show the corporation has fewer than 100 employees, including employees providing professional and technical contracted services.

(i) The owner or operator of equipment in heavy liquid service shall comply with the requirements of either paragraph (i)(1) or (i)(2) of this section, as provided in paragraph (i)(3) of this section.

(1) Retain information, data, and analyses used to determine that a piece of equipment is in heavy liquid service.

(2) When requested by the Administrator, demonstrate that the piece of equipment or process is in heavy liquid service.

(3) A determination or demonstration that a piece of equipment or process is in heavy liquid service shall include an analysis or demonstration that the process fluids do not meet the definition of "in light liquid service." Examples of information that could document this include, but are not limited to, records of chemicals purchased for the process, analyses of process stream composition, engineering calculations, or process knowledge.

(j) Identification, either by list, location (area or group) of equipment in organic HAP service less than 300 hours per year within a process unit subject to the provisions of this subpart under §63.160 of this subpart.

(k) Owners and operators choosing to comply with the requirements of §63.179 of this subpart shall maintain the following records:

(1) Identification of the process unit(s) and the organic HAP's they handle.

(2) A schematic of the process unit, enclosure, and closed-vent system.

(3) A description of the system used to create a negative pressure in the enclosure to ensure that all emissions are routed to the control device.

[59 FR 19568, Apr. 22, 1994, as amended at 59 FR 48177, Sept. 20, 1994; 60 FR 18030, Apr. 10, 1995; 61 FR 31441, June 20, 1996; 62 FR 2792, Jan. 17, 1997; 64 FR 20198, Apr. 26, 1999; 68 FR 37344, June 23, 2003]

§ 63.182 Reporting requirements.

(a) Each owner or operator of a source subject to this subpart shall submit the reports listed in paragraphs (a)(1) through (a)(5) of this section. Owners or operators requesting an extension of compliance shall also submit the report listed in paragraph (a)(6) of this section.

(1) An Initial Notification described in paragraph (b) of this section, and

(2) A Notification of Compliance Status described in paragraph (c) of this section,

(3) Periodic Reports described in paragraph (d) of this section, and

(4)–(5) [Reserved]

(6) Pursuant to section 112(i)(3)(B) of the Act, an owner or operator may request an extension allowing an existing source up to 1 additional year beyond the compliance date specified in the subpart that references this subpart.

(i) For purposes of this subpart, a request for an extension shall be submitted to the operating permit authority as part of the operating permit application. If the State in which the source is located does not have an approved operating permit program, a request for an extension shall be submitted to the Administrator as a separate submittal. The dates specified in §63.6(i) of subpart A of this part for submittal of requests for extensions shall not apply to sources subject to this subpart.

(ii) A request for an extension of compliance must include the data described in §63.6(i)(6)(i) (A), (B), and (D) of subpart A of this part.

(iii) The requirements in §63.6(i)(8) through (i)(14) of subpart A of this part will govern the review and approval of requests for extensions of compliance with this subpart.

(b) Each owner or operator of an existing or new source subject to the provisions of this subpart shall submit a written Initial Notification to the Administrator, containing the information described in paragraph (b)(1), according to the schedule in paragraph (b)(2) of this section. The Initial Notification provisions in §63.9(b)(1) through (b)(3) of subpart A of this part shall not apply to owners or operators of sources subject to this subpart.

(1) The Initial Notification shall include the following information:

(i) The name and address of the owner or operator;

(ii) The address (physical location) of the affected source;

(iii) An identification of the chemical manufacturing processes subject to this subpart; and

(iv) A statement of whether the source can achieve compliance by the applicable compliance date specified in the subpart in 40 CFR part 63 that references this subpart.

(2) The Initial Notification shall be submitted according to the schedule in paragraph (b)(2)(i), (b)(2)(ii), or (b)(2)(iii) of this section, as applicable.

(i) For an existing source, the Initial Notification shall be submitted within 120 days after the date of

promulgation of the subpart that references this subpart.

(ii) For a new source that has an initial start-up 90 days after the date of promulgation of this subpart or later, the application for approval of construction or reconstruction required by §63.5(d) of subpart A of this part shall be submitted in lieu of the Initial Notification. The application shall be submitted as soon as practicable before the construction or reconstruction is planned to commence (but it need not be sooner than 90 days after the date of promulgation of the subpart that references this subpart).

(iii) For a new source that has an initial start-up prior to 90 days after the date of promulgation of the applicable subpart, the Initial Notification shall be submitted within 90 days after the date of promulgation of the subpart that references this subpart.

(c) Each owner or operator of a source subject to this subpart shall submit a Notification of Compliance Status within 90 days after the compliance dates specified in the subpart in 40 CFR part 63 that references this subpart, except as provided in paragraph (c)(4) of this section.

(1) The notification shall provide the information listed in paragraphs (c)(1)(i) through (c)(1)(iv) of this section for each process unit subject to the requirements of §63.163 through §63.174 of this subpart.

(i) Process unit identification.

(ii) Number of each equipment type (e.g., valves, pumps) excluding equipment in vacuum service.

(iii) Method of compliance with the standard (for example, "monthly leak detection and repair" or "equipped with dual mechanical seals").

(iv) Planned schedule for each phase of the requirements in §63.163 and §63.168 of this subpart.

(2) The notification shall provide the information listed in paragraphs (c)(2)(i) and (c)(2)(ii) of this section for each process unit subject to the requirements of §63.178(b) of this subpart.

(i) Batch products or product codes subject to the provisions of this subpart, and

(ii) Planned schedule for pressure testing when equipment is configured for production of products subject to the provisions of this subpart.

(3) The notification shall provide the information listed in paragraphs (c)(3)(i) and (c)(3)(ii) of this section for each process unit subject to the requirements in §63.179 of this subpart.

(i) Process unit identification.

(ii) A description of the system used to create a negative pressure in the enclosure and the control device used to comply with the requirements of §63.172 of this subpart.

(4) For existing sources subject to subpart F of this part, the Notification of Compliance Status shall be submitted for the group of process units with the earliest compliance date specified in §63.100(k) of subpart F of this part, by no later than 90 days after the compliance date for that group. The Notification of Compliance Status for each subsequent group shall be submitted as part of the first periodic report that is due not less than 90 days after the compliance date for that group.

(d) The owner or operator of a source subject to this subpart shall submit Periodic Reports.

(1) A report containing the information in paragraphs (d)(2), (d)(3), and (d)(4) of this section shall be submitted semiannually starting 6 months after the Notification of Compliance Status, as required in paragraph (c) of this section. The first periodic report shall cover the first 6 months after the compliance date specified in §63.100(k)(3) of subpart F. Each subsequent periodic report shall cover the 6 month period following the preceding period.

(2) For each process unit complying with the provisions of §63.163 through §63.174 of this subpart, the

summary information listed in paragraphs (i) through (xvi) of this paragraph for each monitoring period during the 6-month period.

- (i) The number of valves for which leaks were detected as described in §63.168(b) of this subpart, the percent leakers, and the total number of valves monitored;
 - (ii) The number of valves for which leaks were not repaired as required in §63.168(f) of this subpart, identifying the number of those that are determined nonreparable;
 - (iii) The number of pumps for which leaks were detected as described in §63.163(b) of this subpart, the percent leakers, and the total number of pumps monitored;
 - (iv) The number of pumps for which leaks were not repaired as required in §63.163(c) of this subpart;
 - (v) The number of compressors for which leaks were detected as described in §63.164(f) of this subpart;
 - (vi) The number of compressors for which leaks were not repaired as required in §63.164(g) of this subpart;
 - (vii) The number of agitators for which leaks were detected as described in §63.173(a) and (b) of this subpart;
 - (viii) The number of agitators for which leaks were not repaired as required in §63.173(c) of this subpart;
 - (ix) The number of connectors for which leaks were detected as described in §63.174(a) of this subpart, the percent of connectors leaking, and the total number of connectors monitored;
 - (x) [Reserved]
 - (xi) The number of connectors for which leaks were not repaired as required in §63.174(d) of this subpart, identifying the number of those that are determined nonreparable;
 - (xii) [Reserved]
 - (xiii) The facts that explain any delay of repairs and, where appropriate, why a process unit shutdown was technically infeasible.
 - (xiv) The results of all monitoring to show compliance with §§63.164(i), 63.165(a), and 63.172(f) of this subpart conducted within the semiannual reporting period.
 - (xv) If applicable, the initiation of a monthly monitoring program under §63.168(d)(1)(i) of this subpart, or a quality improvement program under either §§63.175 or 63.176 of this subpart.
 - (xvi) If applicable, notification of a change in connector monitoring alternatives as described in §63.174(c)(1) of this subpart.
 - (xvii) If applicable, the compliance option that has been selected under §63.172(n).
- (3) For owners or operators electing to meet the requirements of §63.178(b) of this subpart, the report shall include the information listed in paragraphs (i) through (v) of this paragraph for each process unit.
- (i) Batch product process equipment train identification;
 - (ii) The number of pressure tests conducted;
 - (iii) The number of pressure tests where the equipment train failed the pressure test;

(iv) The facts that explain any delay of repairs; and

(v) The results of all monitoring to determine compliance with §63.172(f) of this subpart.

(4) The information listed in paragraph (c) of this section for the Notification of Compliance Status for process units with later compliance dates. Any revisions to items reported in earlier Notification of Compliance Status, if the method of compliance has changed since the last report.

[59 FR 19568, Apr. 22, 1994, as amended at 59 FR 48178, Sept. 20, 1994; 60 FR 18030, Apr. 10, 1995; 60 FR 63631, Dec. 12, 1995; 62 FR 2792, Jan. 17, 1997]

§ 63.183 Implementation and enforcement.

(a) This subpart can be implemented and enforced by the U.S. EPA, or a delegated authority such as the applicable State, local, or Tribal agency. If the U.S. EPA Administrator has delegated authority to a State, local, or Tribal agency, then that agency, in addition to the U.S. EPA, has the authority to implement and enforce this subpart. Contact the applicable U.S. EPA Regional Office to find out if implementation and enforcement of this subpart is delegated to a State, local, or Tribal agency.

(b) In delegating implementation and enforcement authority of this subpart to a State, local, or Tribal agency under subpart E of this part, the authorities contained in paragraph (c) of this section are retained by the Administrator of U.S. EPA and cannot be transferred to the State, local, or Tribal agency.

(c) The authorities that cannot be delegated to State, local, or Tribal agencies are as specified in paragraphs (c)(1) through (4) of this section.

(1) Approval of alternatives to the requirements in §§63.160, 63.162 through 63.176, 63.178 through 63.179. Follow the applicable procedures of §63.177 to request an alternative means of emission limitation for batch processes and enclosed-vented process units. Where these standards reference another subpart, the cited provisions will be delegated according to the delegation provisions of the referenced subpart. Where these standards reference another subpart and modify the requirements, the requirements shall be modified as described in this subpart. Delegation of the modified requirements will also occur according to the delegation provisions of the referenced subpart.

(2) Approval of major alternatives to test methods under §63.7(e)(2)(ii) and (f), as defined in §63.90, and as required in this subpart.

(3) Approval of major alternatives to monitoring under §63.8(f), as defined in §63.90, and as required in this subpart.

(4) Approval of major alternatives to recordkeeping and reporting under §63.10(f), as defined in §63.90, and as required in this subpart.

[68 FR 37345, June 23, 2003]

Table 1 to Subpart H of Part 63—Batch Processes

Monitoring Frequency for Equipment Other than Connectors

Operating time (% of year)	Equivalent continuous process monitoring frequency time in use		
	Monthly	Quarterly	Semiannually
0 to <25	Quarterly	Annually	Annually.
25 to <50	Quarterly	Semiannually	Annually.
50 to <75	Bimonthly	Three times	Semiannually.
75 to 100	Monthly	Quarterly	Semiannually.

Table 2 to Subpart H of Part 63—Surge Control Vessels and Bottoms Receivers at Existing Sources

Vessel capacity (cubic meters)	Vapor pressure ¹ (kilopascals)
75 ≤ capacity < 151	≥ 13.1
151 ≤ capacity	≥ 5.2 ^a

¹Maximum true vapor pressure of total organic HAP at operating temperature as defined in subpart G of this part.

[60 FR 18025, Apr. 10, 1995]

Table 3 to Subpart H of Part 63—Surge Control Vessels and Bottoms Receivers at New Sources

Vessel capacity (cubic meters)	Vapor pressure ¹ (kilopascals)
38 ≤ capacity < 151	≥ 13.1
151 ≤ capacity	≥ 0.7

¹Maximum true vapor pressure of total organic HAP at operating temperature as defined in subpart G of this part.

[60 FR 18025, Apr. 10, 1995]

Table 4 to Subpart H of Part 63—Applicable 40 CFR Part 63 General Provisions

40 CFR part 63, subpart A, provisions applicable to subpart H
§63.1(a)(1), (a)(2), (a)(3), (a)(13), (a)(14), (b)(2) and (c)(4)
§63.2
§63.5(a)(1), (a)(2), (b), (d)(1)(ii), (d)(4), (e), (f)(1) and (f)(2)
§63.6(a), (b)(3), (c)(5), (i)(1), (i)(2), (i)(4)(i)(A), (i)(5) through (i)(14), (i)(16) and (j)
§63.9(a)(2), (b)(4)(i) ^a , (b)(4)(ii), (b)(4)(iii), (b)(5)a, (c) and (d)
§63.10(d)(4)
§63.12(b)

^aThe notifications specified in §63.9(b)(4)(i) and (b)(5) shall be submitted at the times specified in 40 CFR part 65.

[65 FR 78285, Dec. 14, 2000]

[Browse Previous](#) | [Browse Next](#)

For questions or comments regarding e-CFR editorial content, features, or design, email ecfr@nara.gov.

For questions concerning e-CFR programming and delivery issues, email webteam@gpo.gov.

[Section 508 / Accessibility](#)

[Home Page](#) > [Executive Branch](#) > [Code of Federal Regulations](#) > [Electronic Code of Federal Regulations](#)

Electronic Code of Federal Regulations

e-CFR
TM

e-CFR Data is current as of August 1, 2007

Title 40: Protection of Environment

PART 63—NATIONAL EMISSION STANDARDS FOR HAZARDOUS AIR POLLUTANTS FOR SOURCE CATEGORIES

[Browse Previous](#) | [Browse Next](#)

Subpart I—National Emission Standards for Organic Hazardous Air Pollutants for Certain Processes Subject to the Negotiated Regulation for Equipment Leaks

Source: 59 FR 19587, Apr. 22, 1994, unless otherwise noted.

§ 63.190 Applicability and designation of source.

(a) This subpart provides applicability provisions, definitions, and other general provisions that are applicable to sources subject to this subpart.

(b) Except as provided in paragraph (b)(7) of this section, the provisions of subparts I and H of this part apply to emissions of the designated organic HAP from the processes specified in paragraphs (b)(1) through (b)(6) of this section that are located at a plant site that is a major source as defined in section 112(a) of the Act. The specified processes are further defined in §63.191.

(1) Styrene-butadiene rubber production (butadiene and styrene emissions only).

(2) Polybutadiene rubber production (butadiene emissions only).

(3) The processes producing the agricultural chemicals listed in paragraphs (b)(3)(i) through (b)(3)(v) of this section (butadiene, carbon tetrachloride, methylene chloride, and ethylene dichloride emissions only).

(i) Captafol[®],

(ii) Captan[®],

(iii) Chlorothalonil,

(iv) Dacthal, and

(v) Tordon[®] acid.

(4) Processes producing the polymers/resins or other chemical products listed in paragraphs (b)(4)(i) through (b)(4)(vi) of this section (carbon tetrachloride, methylene chloride, tetrachloroethylene, chloroform, and ethylene dichloride emissions only).

- (i) Hypalon[®],
 - (ii) Oxybisphenoxarsine/1,3-diisocyanate (OBPA[®]),
 - (iii) Polycarbonates,
 - (iv) Polysulfide rubber,
 - (v) Chlorinated paraffins, and
 - (vi) Symmetrical tetrachloropyridine.
- (5) Pharmaceutical production processes using carbon tetrachloride or methylene chloride (carbon tetrachloride and methylene chloride emissions only).
- (6) Processes producing the polymers/resins or other chemical products listed in paragraphs (b)(6)(i) through (b)(6)(v) of this section (butadiene emissions only).
- (i) [Reserved]
 - (ii) Methylmethacrylate-butadiene-styrene resins (MBS)
 - (iii) Butadiene-furfural cotrimer,
 - (iv) Methylmethacrylate-acrylonitrile-butadiene-styrene (MABS) resins, and
 - (v) Ethylidene norbornene.
- (7) The owner or operator of a plant site at which a process specified in paragraphs (b)(1) through (b)(6) of this section is located is exempt from all requirements of this subpart I until not later than April 22, 1997 if the owner or operator certifies, in a notification to the appropriate EPA Regional Office, not later than May 14, 1996, that the plant site at which the process is located emits, and will continue to emit, during any 12-month period, less than 10 tons per year of any individual HAP, and less than 25 tons per year of any combination of HAP.
- (i) If such a determination is based on limitations and conditions that are not federally enforceable (as defined in subpart A of this part), the owner or operator shall document the basis for the determination as specified in paragraphs (b)(7)(i)(A) through (b)(7)(i)(C).
- (A) The owner or operator shall identify all HAP emission points at the plant site, including those emission points subject to and emission points not subject to subparts F, G, and H of this part;
 - (B) The owner or operator shall calculate the amount of annual HAP emissions released from each emission point at the plant site, using acceptable measurement or estimating techniques for maximum expected operating conditions at the plant site. Examples of estimating procedures that are considered acceptable include the calculation procedures in §63.150 of subpart G, the early reduction demonstration procedures specified in §§63.74(c)(2), (c)(3), (d)(2), (d)(3), and (g), or accepted engineering practices. If the total annual HAP emissions for the plant site are annually reported under EPCRA section 313, then such reported annual emissions may be used to satisfy the requirements of this paragraph.
 - (C) The owner or operator shall sum the amount of annual HAP emissions from all emission points on the plant site. If the total emissions of any one HAP are less than 10 tons per year and the total emissions of any combination of HAP are less than 25 tons per year, the plant site qualifies for the exemption described in paragraph (b)(7) of this section, provided that emissions are kept below these thresholds.
- (ii) If such a determination is based on limitations and conditions that are federally enforceable, and the

plant site is not a major source (as defined in subpart A of this part), the owner or operator is not subject to the provisions of paragraph (b)(7) of this section.

(c) The owner or operator of a process listed in paragraph (b) of this section that does not have the designated organic hazardous air pollutants present in the process shall comply only with the requirements of §63.192(k) of this subpart. To comply with this subpart, such processes shall not be required to comply with the provisions of subpart A of this part.

(d) For the purposes of subparts I and H of this part, the source includes pumps, compressors, agitators, pressure relief devices, sampling connection systems, open-ended valves or lines, valves, connectors, surge control vessels, bottoms receivers, and instrumentation systems that are associated with the processes identified in paragraph (b) of this section and are intended to operate in organic hazardous air pollutant service (as defined in §63.191 of this subpart) for 300 hours or more during the calendar year. If specific items of equipment, comprising part of a process unit subject to this subpart, are managed by different administrative organizations (e.g., different companies, affiliates, departments, divisions, etc.) those items of equipment may be aggregated with any process unit within the source for all purposes under subpart H of this part, providing there is no delay in the applicable compliance date in paragraph (e) of this section.

(e) The owner or operator of a process subject to this subpart is required to comply with the provisions of subpart H of this part on or before the dates specified in paragraph (e)(1) or (e)(2) of this section, unless the owner or operator eliminates the use or production of all HAP's that cause the process to be subject to this rule no later than 18 months after April 22, 1994.

(1) New sources that commence construction or reconstruction after December 31, 1992 shall comply upon initial start-up or April 22, 1994.

(2) Existing sources shall comply no later than October 24, 1994, except as provided in paragraphs (e)(3) through (e)(6) of this section or unless an extension has been granted by the EPA Regional Office or operating permit authority, as provided in §63.6(i) of subpart A of this part.

(3) Existing process units shall be in compliance with the requirements of §63.164 of subpart H no later than May 10, 1995, for any compressor meeting one or more of the criteria in paragraphs (e)(3)(i) through (e)(3)(iv) of this section, if the work can be accomplished without a process unit shutdown, as defined in §63.161.

(i) The seal system will be replaced;

(ii) A barrier fluid system will be installed;

(iii) A new barrier fluid will be utilized which requires changes to the existing barrier fluid system; or

(iv) The compressor must be modified to permit connecting the compressor to a closed vent system.

(4) Existing process units shall be in compliance with the requirements of §63.164 of subpart H no later than January 23, 1996, for any compressor meeting the criteria in paragraphs (e)(4)(i) through (e)(4)(iv) of this section.

(i) The compressor meets one or more of the criteria specified in paragraphs (e)(3) (i) through (iv) of this section;

(ii) The work can be accomplished without a process unit shutdown as defined in §63.161;

(iii) The additional time is actually necessary due to the unavailability of parts beyond the control of the owner or operator; and

(iv) The owner or operator submits a request to the appropriate EPA Regional Office at the addresses listed in §63.13 of subpart A of this part no later than May 10, 1995. The request shall include the information specified in paragraphs (e)(4)(iv)(A) through (e)(4)(iv)(E) of this section. Unless the EPA Regional Office objects to the request within 30 days after receipt, the request shall be deemed

approved.

(A) The name and address of the owner or operator and the address of the existing source if it differs from the address of the owner or operator;

(B) The name, address, and telephone number of a contact person for further information;

(C) An identification of the process unit, and of the specific equipment for which additional compliance time is required;

(D) The reason compliance cannot reasonably be achieved by May 10, 1995; and

(E) The date by which the owner or operator expects to achieve compliance.

(5)(i) If compliance with the compressor provisions of §63.164 of subpart H of this part cannot reasonably be achieved without a process unit shutdown, as defined in §63.161 of subpart H, the owner or operator shall achieve compliance no later than April 22, 1996, except as provided in paragraph (e)(5)(ii) of this section. The owner or operator who elects to use this provision shall also comply with the requirements of §63.192(m) of this subpart.

(ii) If compliance with the compressor provisions of §63.164 of subpart H of this part cannot be achieved without replacing the compressor or recasting the distance piece, the owner or operator shall achieve compliance no later than April 22, 1997. The owner or operator who elects to use this provision shall also comply with the requirements of §63.192(m) of this subpart.

(6) Existing sources shall be in compliance with the provisions of §63.170 of subpart H no later than April 22, 1997.

(f) The provisions of subparts I and H of this part do not apply to research and development facilities or to bench-scale batch processes, regardless of whether the facilities or processes are located at the same plant site as a process subject to the provisions of subpart I and H of this part.

(g)(1) If an additional process unit specified in paragraph (b) of this section is added to a plant site that is a major source as defined in Section 112(a) of the CAA, the addition shall be subject to the requirements for a new source in subparts H and I of this part if:

(i) It is an addition that meets the definition of construction in §63.2 of subpart A of this part;

(ii) Such construction commenced after December 31, 1992; and

(iii) The addition has the potential to emit 10 tons per year or more of any HAP or 25 tons per year or more of any combination of HAP's, unless the Administrator establishes a lesser quantity.

(2) If any change is made to a process subject to this subpart, the change shall be subject to the requirements for a new source in subparts H and I of this part if:

(i) It is a change that meets the definition of reconstruction in §63.2 of subpart A of this part;

(ii) Such reconstruction commenced after December 31, 1992.

(3) If an additional process unit is added to a plant site or a change is made to a process unit and the addition or change is determined to be subject to the new source requirements according to paragraphs (g)(1) or (g)(2) of this section:

(i) The new or reconstructed source shall be in compliance with the new source requirements of subparts H and I of this part upon initial start-up of the new or reconstructed source or by April 22, 1994, whichever is later; and

(ii) The owner or operator of the new or reconstructed source shall comply with the reporting and recordkeeping requirements in subparts H and I of this part that are applicable to new sources. The applicable reports include, but are not limited to:

(A) Reports required by §63.182(b), if not previously submitted, §63.182 (c) and (d) of subpart H of this part; and

(B) Reports and notifications required by sections of subpart A of this part that are applicable to subparts H and I of this part, as identified in §63.192(a) of this subpart.

(4) If an additional process unit is added to a plant site, if a surge control vessel or bottoms receiver becomes subject to §63.170 of subpart H, or if a compressor becomes subject to §63.164 of subpart H, and if the addition or change is not subject to the new source requirements as determined according to paragraphs (g)(1) or (g)(2) of this section, the requirements in paragraphs (g)(4)(i) through (g)(4)(iii) of this section shall apply. Examples of process changes include, but are not limited to, changes in production capacity, feedstock type, or catalyst type, or whenever there is replacement, removal, or addition of recovery equipment. For purposes of this paragraph, process changes do not include: process upsets, unintentional temporary process changes, and changes that are within the equipment configuration and operating conditions documented in the Notification of Compliance Status required by §63.182(c) of subpart H of this part.

(i) The added emission point(s) and any emission point(s) within the added or changed process unit are subject to the requirements of subparts H and I of this part for an existing source;

(ii) The added emission point(s) and any emission point(s) within the added or changed process unit shall be in compliance with subparts H and I of this part by the dates specified in paragraphs (g)(4)(ii)(A) or (g)(4)(ii)(B) of this section, as applicable.

(A) If a process unit is added to a plant site or an emission point(s) is added to an existing process unit, the added process unit or emission point(s) shall be in compliance upon initial start-up of the added process unit or emission point(s) or by April 22, 1997, whichever is later.

(B) If a surge control vessel or bottoms receiver becomes subject to §63.170 of subpart H, if a compressor becomes subject to §63.164 of subpart H, or if a deliberate operational process change causes equipment to become subject to subpart H of this part, the owner or operator shall be in compliance upon initial start-up or by April 22, 1997, whichever is later, unless the owner or operator demonstrates to the Administrator that achieving compliance will take longer than making the change. The owner or operator shall submit to the Administrator for approval a compliance schedule, along with a justification for the schedule. The Administrator shall approve the compliance schedule or request changes within 120 calendar days of receipt of the compliance schedule and justification.

(iii) The owner or operator of a process unit or emission point that is added to a plant site and is subject to the requirements for existing sources shall comply with the reporting and recordkeeping requirements of subparts H and I of this part that are applicable to existing sources, including, but not limited to, the reports listed in paragraphs (g)(4)(iii)(A) and (g)(4)(iii)(B) of this section.

(A) Reports required by §63.182 of subpart H of this part; and

(B) Reports and notifications required by sections of subpart A of this part that are applicable to subparts H and I of this part, as identified in §63.192(a) of this subpart.

(h) *Rules stayed for reconsideration.* Notwithstanding any other provision of this subpart, the effectiveness of subpart I is stayed from October 24, 1994, to April 24, 1995, only as applied to those sources for which the owner or operator makes a representation in writing to the Administrator that the resolution of the area source definition issues could have an effect on the compliance status of the source with respect to subpart I.

(i) *Sections stayed for reconsideration.* Notwithstanding any other provision of this subpart, the effectiveness of §§63.164 and 63.170 of subpart H is stayed from October 28, 1994, to April 24, 1995, only as applied to those sources subject to §63.190(e)(2).

(j) If a change that does not meet the criteria in paragraph (g)(4) of this section is made to a process unit subject to subparts H and I of this part, and the change causes equipment to become subject to the provisions of subpart H of this part, then the owner or operator shall comply with the requirements of subpart H of this part for the equipment as expeditiously as practical, but in no event later than three years after the equipment becomes subject.

(1) The owner or operator shall submit to the Administrator for approval a compliance schedule, along with a justification for the schedule.

(2) The Administrator shall approve the compliance schedule or request changes within 120 calendar days of receipt of the compliance schedule and justification.

[59 FR 19587, Apr. 22, 1994, as amended at 59 FR 48178, Sept. 20, 1994; 59 FR 53360, Oct. 24, 1994; 59 FR 54132, Oct. 28, 1994; 60 FR 5321, Jan. 27, 1995; 60 FR 18025, Apr. 10, 1995; 61 FR 7718, Feb. 29, 1996; 61 FR 31441, June 20, 1996; 62 FR 2792, Jan. 17, 1997]

§ 63.191 Definitions.

(a) The following terms as used in subparts I and H of this part shall have the meaning given them in subpart A of this part: Act, Administrator, approved permit program, commenced, compliance date, construction, effective date, EPA, equivalent emission limitation, existing source, Federally enforceable, hazardous air pollutant, lesser quantity, major source, malfunction, new source, owner or operator, performance evaluation, performance test, permit program, permitting authority, reconstruction, relevant standard, responsible official, run, standard conditions, State, and stationary source.

(b) All other terms used in this subpart and in subpart H of this part shall have the meaning given them in the Act and in this section. If the same term is defined in subpart A or H of this part and in this section, it shall have the meaning given in this section for purposes of subparts I and H of this part.

Bench-scale batch process means a batch process (other than a research and development facility) that is operated on a small scale, such as one capable of being located on a laboratory bench top. This bench-scale equipment will typically include reagent feed vessels, a small reactor and associated product separator, recovery and holding equipment. These processes are only capable of producing small quantities of product.

Bottoms receiver means a tank that collects distillation bottoms before the stream is sent for storage or for further downstream processing.

Butadiene-furfural cotrimer (R-11) means the product of reaction of butadiene with excess furfural in a liquid phase reactor. R-11 is usually used as an insect repellent and as a delousing agent for cows in the dairy industry.

Captafol® means the fungicide Captafol ([cis-N(1,1,2,2-tetrachloroethyl)-thio]-4-cyclohexene-1,2-dicarboximide). The category includes any production process units that store, react, or otherwise process 1,3-butadiene in the production of Captafol.

Captan® means the fungicide Captan. The production process typically includes, but is not limited to, the reaction of tetrahydrophthalimide and perchloromethyl mercaptan with caustic.

Chlorinated paraffins means dry chlorinated paraffins, which are mainly straight-chain, saturated hydrocarbons. The category includes, but is not limited to, production of chlorinated paraffins by passing gaseous chlorine into a paraffin hydrocarbon or by chlorination by using solvents, such as carbon tetrachloride, under reflux.

Chlorothalonil means the agricultural fungicide, bactericide and nematocide Chlorothalonil (Daconil). The category includes any process units utilized to dissolve tetrachlorophthalic acid chloride in an organic solvent, typically carbon tetrachloride, with the subsequent addition of ammonia.

Dacthal™ means the pre-emergent herbicide Dacthal™, also known as DCPA, DAC, and dimethyl ester 2,3,5,6-tetrachloroterephthalic acid. The category includes, but is not limited to, chlorination

processes and the following production process units: photochlorination reactors, thermal chlorination reactors, and condensers.

Ethylidene Norbornene means the diene with CAS number 16219–75–3. Ethylidene norbornene is used in the production of ethylene-propylene rubber products.

*Hypalon*TM (*chlorosulfonated polyethylene*) means a synthetic rubber produced by reacting polyethylene with chloric and sulfur dioxide, transforming the thermoplastic polyethylene into a vulcanized elastomer. The reaction is conducted in a solvent (carbon tetrachloride) reaction medium.

Initial start-up means the first time a new or reconstructed source begins production. Initial start-up does not include operation solely for testing equipment. For purposes of subpart H of this part, initial start-up does not include subsequent start-ups (as defined in §63.161 of subpart H of this part) of process units (as defined in §63.161 of subpart H of this part) following malfunctions or process unit shutdowns.

In organic hazardous air pollutant service or in organic HAP service means that a piece of equipment either contains or contacts a fluid (liquid or gas) that is at least 5 percent by weight of the designated organic HAP's listed in §63.190(b) of this subpart.

Methyl Methacrylate-Acrylonitrile-Butadiene-Styrene (MABS) Resins means styrenic polymers containing methyl methacrylate, acrylonitrile, 1,3-butadiene, and styrene. The MABS copolymers are prepared by dissolving or dispersing polybutadiene rubber in a mixture of methyl methacrylate-acrylonitrile-styrene and butadiene monomer. The graft polymerization is carried out by a bulk or a suspension process.

Methyl Methacrylate-Butadiene-Styrene (MBS) Resins means styrenic polymers containing methyl methacrylate, 1,3-butadiene, and styrene. Production of MBS terpolymers is achieved using an emulsion process in which methyl methacrylate and styrene are grafted onto a styrene-butadiene rubber.

On-site or On site means, with respect to records required to be maintained by this subpart, that the records are stored at a location within a major source which encompasses the affected source. On-site includes, but is not limited to, storage at the process unit to which the records pertain, or storage in central files elsewhere at the major source.

Oxybisphenoxarsine (OBPA)/1,3-Diisocyanate means the chemical with CAS number 58–36–6. The chemical is primarily used for fungicidal and bactericidal protection of plastics. The process uses chloroform as a solvent.

Pharmaceutical production process means a process that synthesizes one or more pharmaceutical intermediate or final products using carbon tetrachloride or methylene chloride as a reactant or process solvent. Pharmaceutical production process does not mean process operations involving formulation activities, such as tablet coating or spray coating of drug particles, or solvent recovery or waste management operations.

Polybutadiene production means a process that produces polybutadiene through the polymerization of 1,3-butadiene.

Polycarbonates means a special class of polyester formed from any dihydroxy compound and any carbonate diester or by ester interchange. Polycarbonates may be produced by solution or emulsion polymerization, although other methods may be used. A typical method for the manufacture of polycarbonates includes the reaction of bisphenol-A with phosgene in the presence of pyridine to form a polycarbonate. Methylene chloride is used as a solvent in this polymerization reaction.

Polysulfide rubber means a synthetic rubber produced by reaction of sodium sulfide and p-dichlorobenzene at an elevated temperature in a polar solvent. This rubber is resilient and has low temperature flexibility.

Process Unit means the group of equipment items used to process raw materials and to manufacture a product. For the purposes of this subpart, process unit includes all unit operations and associated equipment (e.g., reactors and associated product separators and recovery devices), associated unit operations (e.g., extraction columns), any feed and product storage vessels, and any transfer racks for

distribution of final product.

Research and development facility means laboratory and pilot plant operations whose primary purpose is to conduct research and development into new processes and products, where the operations are under the close supervision of technically trained personnel, and is not engaged in the manufacture of products except in a de minimis manner.

Source means the collection of equipment listed in §63.190(d) to which this subpart applies as determined by the criteria in §63.190. For purposes of subparts H and I of this part, the term *affected source* as used in subpart A of this part has the same meaning as the term *source* defined here.

Styrene-butadiene rubber production means a process that produces styrene-butadiene copolymers, whether in solid (elastomer) or emulsion (latex) form.

Surge control vessel means feed drums, recycle drums, and intermediate vessels. Surge control vessels are used within a process unit when in-process storage, mixing, or management of flow rates or volumes is needed to assist in production of a product.

Symmetrical tetrachloropyridine means the chemical with CAS number 2402-79-1.

*Tordon acid*TM means the synthetic herbicide 4-amino-3,5,6-trichloropicolinic acid, picloram. The category includes, but is not limited to, chlorination processes utilized in TordonTM acid production.

[59 FR 19587, Apr. 22, 1994, as amended at 59 FR 48178, Sept. 20, 1994; 60 FR 18026, 18030, Apr. 10, 1995; 61 FR 31442, June 20, 1996; 62 FR 2792, Jan. 17, 1997]

§ 63.192 Standard.

(a)(1) The owner or operator of a source subject to this subpart shall comply with the requirements of subpart H of this part for the processes and designated organic HAP's listed in §63.190(b) of this subpart.

(2) The owner or operator of a pharmaceutical production process subject to this subpart may define a process unit as a set of operations, within a source, producing a product, as all operations collocated within a building or structure or as all affected operations at the source.

(b) All provisions in §§63.1 through 63.15 of subpart A of this part which apply to owners and operators of sources subject to subparts I and H of this part, are:

(1) The applicability provisions of §63.1 (a)(1), (a)(2), (a)(10), (a)(12) through (a)(14);

(2) The definitions of §63.2 unless changed or modified by specific entry in §63.191 or §63.161;

(3) The units and abbreviations in §63.3;

(4) The prohibited activities and circumvention provisions of §63.4 (a)(1), (a)(2), (a)(3), (a)(5), and (b);

(5) The construction and reconstruction provisions of §63.5(a), (b)(1), (b)(3), (d) (except the review is limited to the equipment subject to the provisions of subpart H), (e), and (f);

(6)(i) The compliance with standards and maintenance requirements of §63.6(a), (b)(3), (c)(5), (e), (i)(1), (i)(2), (i)(4)(i)(A), (i)(6)(i), (i)(8) through (i)(10), (i)(12) through (i)(14), (i)(16), and (j);

(ii) The operational and maintenance requirements of §63.6(e). The startup, shutdown, and malfunction plan requirement of §63.6(e)(3) is limited to control devices subject to the provisions of subpart H of part 63 and is optional for other equipment subject to subpart H. The startup, shutdown, and malfunction plan may include written procedures that identify conditions that justify a delay of repair.

(7) With respect to flares, the performance testing requirements of §63.7(a)(3), (d), (e)(1), (e)(2), (e)(4), and (h);

(8) The notification requirements of §63.9 (a)(1), (a)(3), (a)(4), (b)(1)(i), (b)(4), (b)(5) (except, use the schedule specified in subpart H), (c), (d), and (i);

(9) The recordkeeping and reporting requirements of §63.10(a) and (f);

(10) The control device requirements of §63.11(b); and

(11) The provisions of §63.12 through §63.15.

(c) Initial performance tests and initial compliance determinations shall be required only as specified in subpart H of this part.

(1) Performance tests and compliance determinations shall be conducted according to the applicable sections of subpart H.

(2) The owner or operator shall notify the Administrator of the intention to conduct a performance test at least 30 days before the performance test is scheduled to allow the Administrator the opportunity to have an observer present during the test.

Note: This requirement does not apply to equipment subject to monitoring using Method 21 of part 60, appendix A.

(3) Performance tests shall be conducted according to the provisions of §63.7(e) of subpart A of this part, except that performance tests shall be conducted at maximum representative operating conditions for the process. During the performance test, an owner or operator may operate the control or recovery device at maximum or minimum representative operating conditions for monitored control or recovery device parameters, whichever results in lower emission reduction.

(4) Data shall be reduced in accordance with the EPA-approved methods specified in the applicable subpart, or, if other test methods are used, the data and methods shall be validated according to the protocol in Method 301 of appendix A of this part.

(d) An application for approval of construction or reconstruction, 40 CFR 63.5 of this chapter, will not be required if:

(1) The new process unit complies with the applicable standards in §63.162 or §63.178 of subpart H of this part; and

(2) In the next semiannual report required by §63.182(d) of subpart H of this part, the information in §63.182(c) of subpart H of this part is reported.

(e) If an owner or operator of a process plans to eliminate the use or production of all HAP's that cause the process to be subject to the provisions of subparts I and H of this part no later than 18 months after April 22, 1994, the owner or operator shall submit to the Administrator a brief description of the change, identify the HAP's eliminated, and the expected date of cessation of operation of the current process, by no later than January 23, 1995.

(f) Each owner or operator of a source subject to subparts I and H of this part shall keep copies of all applicable reports and records required by subpart H for at least 2 years, except as otherwise specified in subpart H. If an owner or operator submits copies of reports to the applicable EPA Regional Office, the owner or operator is not required to maintain copies of reports. If the EPA Regional Office has waived the requirement of §63.10(a)(4)(ii) for submittal of copies of reports, the owner or operator is not required to maintain copies of reports.

(1) All applicable records shall be maintained in such a manner that they can be readily accessed. The most recent 6 months of records shall be retained on site or shall be accessible from a central location by computer or other means that provides access within 2 hours after a request.

(2) The owner or operator subject to subparts I and H of this part shall keep the records specified in this paragraph, as well as records specified in subpart H of this part.

(i) Records of the occurrence and duration of each start-up, shutdown, and malfunction of operation of a process subject to this subpart as specified in §63.190(b) of this subpart.

(ii) Records of the occurrence and duration of each malfunction of air pollution control equipment or continuous monitoring systems used to comply with subparts I and H of this part.

(iii) For each start-up, shutdown, and malfunction, records that the procedures specified in the source's start-up, shutdown, and malfunction plan were followed, and documentation of actions taken that are not consistent with the plan. These records may take the form of a "checklist," or other form of recordkeeping that confirms conformance with the startup, shutdown, and malfunction plan for the event.

(g) All reports required under subpart H shall be sent to the Administrator at the addresses listed in §63.13 of subpart A of this part.

(1) Wherever subpart A specifies "postmark" dates, submittals may be sent by methods other than the U.S. Mail (e.g., by fax or courier). Submittals shall be sent on or before the specified date.

(2) If acceptable to both the Administrator and the owner or operator of a source, reports may be submitted on electronic media.

(h) If, in the judgment of the Administrator, an alternative means of emission limitation will achieve a reduction in organic HAP emissions at least equivalent to the reduction in organic HAP emissions from that source achieved under any design, equipment, work practice, or operational standards in subpart H of this part, the Administrator will publish in the Federal Register a notice permitting the use of the alternative means for purposes of compliance with that requirement.

(1) The notice may condition the permission on requirements related to the operation and maintenance of the alternative means.

(2) Any notice under paragraph (h) of this section shall be published only after public notice and an opportunity for a hearing.

(3) Any person seeking permission to use an alternative means of compliance under this section shall collect, verify, and submit to the Administrator information showing that the alternative means achieves equivalent emission reductions.

(i) Each owner or operator of a source subject to this subpart shall obtain a permit under 40 CFR part 70 or part 71 from the appropriate permitting authority.

(1) If EPA has approved a State operating permit program under 40 CFR part 70, the permit shall be obtained from the State authority.

(2) If the State operating permit program has not been approved, the source shall apply to the EPA regional office pursuant to 40 CFR part 71.

(j) The requirements in subparts I and H of this part are Federally enforceable under section 112 of the Act on and after the dates specified in §63.190(d) of this subpart.

(k) The owner or operator of a process unit which meets the criteria of §63.190 (c), shall comply with the requirements of either paragraph (k)(1) or (k)(2) of this section.

(1) Retain information, data, and analysis used to determine that the process unit does not have the designated organic hazardous air pollutant present in the process. Examples of information that could document this include, but are not limited to, records of chemicals purchased for the process, analyses of process stream composition, engineering calculations, or process knowledge.

(2) When requested by the Administrator, demonstrate that the chemical manufacturing process unit does not have the designated organic hazardous air pollutant present in the process.

(l) To qualify for the exemption specified in §63.190(b)(7) of this subpart, the owner or operator shall maintain the documentation of the information required pursuant to §63.190(b)(7)(i), and documentation of any update of this information requested by the EPA Regional Office, and shall provide the documentation to the EPA Regional Office upon request. The EPA Regional Office will notify the owner or operator, after reviewing such documentation, whether, in the EPA Regional Office's judgement, the source does not qualify for the exemption specified in §63.190(b)(7) of this subpart. In such cases, compliance with this subpart shall be required no later than 90 days after the date of such notification by the EPA Regional Office.

(m) An owner or operator who elects to use the compliance extension provisions of §63.190(e)(5) (i) or (ii) shall submit a compliance extension request to the appropriate EPA Regional Office no later than May 10, 1995. The request shall contain the information specified in §63.190(e)(4)(iv) and the reason compliance cannot reasonably be achieved without a process unit shutdown, as defined in §63.161 of subpart H or replacement of the compressor or recasting of the distance piece.

[59 FR 19587, Apr. 22, 1994, as amended at 59 FR 48178, Sept. 20, 1994; 60 FR 18026, 18030, Apr. 10, 1995; 61 FR 31442, June 20, 1996; 62 FR 2793, Jan. 17, 1997]

§ 63.193 Implementation and enforcement.

(a) This subpart can be implemented and enforced by the U.S. EPA, or a delegated authority such as the applicable State, local, or Tribal agency. If the U.S. EPA Administrator has delegated authority to a State, local, or Tribal agency, then that agency, in addition to the U.S. EPA, has the authority to implement and enforce this subpart. Contact the applicable U.S. EPA Regional Office to find out if implementation and enforcement of this subpart is delegated to a State, local, or Tribal agency.

(b) In delegating implementation and enforcement authority of this subpart to a State, local, or Tribal agency under subpart E of this part, the authorities contained in paragraph (c) of this section are retained by the Administrator of U.S. EPA and cannot be transferred to the State, local, or Tribal agency.

(c) The authorities that cannot be delegated to State, local, or Tribal agencies are as specified in paragraphs (c)(1) through (4) of this section.

(1) Approval of alternatives to the requirements in §§63.190 and 63.192(a) through (b), (e), and (h) through (j). Where these standards reference another subpart, the cited provisions will be delegated according to the delegation provisions of the referenced subpart.

(2) Approval of major alternatives to test methods under §63.7(e)(2)(ii) and (f), as defined in §63.90, and as required in this subpart.

(3) Approval of major alternatives to monitoring under §63.8(f), as defined in §63.90, and as required in this subpart.

(4) Approval of major alternatives to recordkeeping and reporting under §63.10(f), as defined in §63.90, and as required in this subpart.

[68 FR 37345, June 23, 2003]

[Browse Previous](#) | [Browse Next](#)

For questions or comments regarding e-CFR editorial content, features, or design, email ecfr@nara.gov.

For questions concerning e-CFR programming and delivery issues, email webteam@gpo.gov.

[Section 508 / Accessibility](#)

materials used for source categories other than wood furniture (surface coating), but excluding materials used in routine janitorial or facility grounds maintenance, personal uses by employees or other persons, the use of products for the purpose of maintaining motor vehicles operated by the facility, or the use of toxic chemicals contained in intake water (used for processing or noncontact cooling) or intake air (used either as compressed air or for combustion). A rolling 12-month period includes the previous 12 months of operation. The owner or operator of the source shall maintain records of the total gallons of coating, gluing, cleaning, and washoff materials used each month and the total gallons used each previous month, and upon request submit such records to the Administrator. Because records are needed over the previous set of 12 months, the owner or operator shall keep monthly records beginning no less than one year before the compliance date specified in §63.800(e). Records shall be maintained for five years.

(3) The source emits no more than 4.5 Mg (5 tons) of any one HAP per rolling 12-month period and no more than 11.4 Mg (12.5 tons) of any combination of HAP per rolling 12-month period, and at least 90 percent of the plantwide emissions per rolling 12-month period are associated with the manufacture of wood furniture or wood furniture components.

(c) This subpart does not apply to research or laboratory facilities as defined in §63.801.

(d) Owners or operators of affected sources shall also comply with the requirements of subpart A of this part (General Provisions), according to the applicability of subpart A to such sources, as identified in Table 1 of this subpart.

(e) The compliance date for existing affected sources that emit less than 50 tons per year of HAP in 1996 is December 7, 1998. The compliance date for existing affected sources that emit 50 tons or more of hazardous air pollutants in 1996 is November 21, 1997. The owner or operator of an existing area source that increases its emissions of (or its potential to emit) HAP such that the source becomes a major source that is subject to this subpart shall comply with this subpart one year after becoming a major source.

(f) New affected sources must comply with the provisions of this standard immediately upon startup or by December 7, 1995, whichever is later. New area sources that become major sources shall comply with the provisions of this standard immediately upon becoming a major source.

(g) Reconstructed affected sources are subject to the requirements for new affected sources. The costs associated with the purchase and installation of air pollution control equipment (e.g., incinerators, carbon adsorbers, etc.) are not considered in determining whether the facility has been reconstructed, unless the control equipment is required as part of the process (e.g., product recovery). Additionally, the costs of retrofitting and replacement of equipment that is installed specifically to comply with this subpart are not considered reconstruction costs. For example, an affected source may convert to waterborne coatings to meet the requirements of this subpart. At most facilities, this conversion will require the replacement of existing storage tanks, mix equipment, and transfer lines. The cost of replacing the equipment is not considered in determining whether the facility has been reconstructed.

[60 FR 62936, Dec. 7, 1995, as amended at 62 FR 30259, June 3, 1997]

§ 63.801 Definitions.

(a) All terms used in this subpart that are not defined below have the meaning given to them in the CAA and in subpart A (General Provisions) of this part.

Adhesive means any chemical substance that is applied for the purpose of bonding two surfaces together other than by mechanical means. Under this subpart, adhesives shall not be considered coatings or finishing materials. Products used on humans and animals, adhesive tape, contact paper, or any other product with an adhesive incorporated onto or in an inert substrate shall not be considered adhesives under this subpart.

Administrator means the Administrator of the United States Environmental Protection Agency or his or her authorized representative.

Aerosol adhesive means an adhesive that is dispensed from a pressurized container as a suspension of fine solid or liquid particles in gas.

Affected source means a wood furniture manufacturing facility that is engaged, either in part or in whole, in the manufacture of wood furniture or wood furniture components and that is located at a plant site that is a major source as defined in 40 CFR part 63.2, excluding sources that meet the criteria established in §63.800(a), (b) and (c) of this subpart.

Alternative method means any method of sampling and analyzing for an air pollutant that is not a reference or equivalent method but has been demonstrated to the Administrator's satisfaction to, in specific cases, produce results adequate for a determination of compliance.

As applied means the HAP and solids content of the coating or contact adhesive that is actually used for coating or gluing the substrate. It includes the contribution of materials used for in-house dilution of the coating or contact adhesive.

Basecoat means a coat of colored material, usually opaque, that is applied before graining inks, glazing coats, or other opaque finishing materials, and is usually topcoated for protection.

Baseline conditions means the conditions that exist prior to an affected source implementing controls, such as a control system.

Building enclosure means a building housing a process that meets the requirements of a temporary total enclosure. The EPA Method 204E is used to identify all emission points from the building enclosure and to determine which emission points must be tested. For additional information see *Guidelines for Determining Capture Efficiency*, January 1994. Docket No. A-93-10, Item No. IV-B-1.

Capture device means a hood, enclosed room, floor sweep, or other means of collecting solvent emissions or other pollutants into a duct so that the pollutant can be directed to a pollution control device such as an incinerator or carbon adsorber.

Capture efficiency means the fraction of all organic vapors generated by a process that are directed to a control device.

Certified product data sheet (CPDS) means documentation furnished by coating or adhesive suppliers or an outside laboratory that provides:

(1) The VHAP content of a finishing material, contact adhesive, or solvent, by percent weight, measured using the EPA Method 311 (as promulgated in this subpart), or an equivalent or alternative method (or formulation data if the coating meets the criteria specified in §63.805(a));

(2) The solids content of a finishing material or contact adhesive by percent weight, determined using data from the EPA Method 24, or an alternative or equivalent method (or formulation data if the coating meets the criteria specified in §63.805 (a)); and

(3) The density, measured by EPA Method 24 or an alternative or equivalent method. Therefore, the reportable VHAP content shall represent the maximum aggregate emissions potential of the finishing material, adhesive, or solvent in concentrations greater than or equal to 1.0 percent by weight or 0.1 percent for VHAP that are carcinogens, as defined by the Occupational Safety and Health Administration Hazard Communication Standard (29 CFR part 1910), as formulated. Only VHAP present in concentrations greater than or equal to 1.0 percent by weight, or 0.1 percent for VHAP that are carcinogens, must be reported on the CPDS. The purpose of the CPDS is to assist the affected source in demonstrating compliance with the emission limitations presented in §63.802.

Note: Because the optimum analytical conditions under EPA Method 311 vary by coating, the coating or adhesive supplier may also choose to include on the CPDS the optimum analytical conditions for analysis of the coating, adhesive, or solvent using EPA Method 311. Such information may include, but not be limited to, separation column, oven temperature, carrier gas, injection port temperature, extraction solvent, and internal standard.)

Cleaning operations means operations in which organic HAP solvent is used to remove coating materials or adhesives from equipment used in wood furniture manufacturing operations.

Coating means a protective, decorative, or functional film applied in a thin layer to a surface. Such materials include, but are not limited to, paints, topcoats, varnishes, sealers, stains, washcoats, basecoats, enamels, inks, and temporary protective coatings. Aerosol spray paints used for touch-up and repair are not considered coatings under this subpart.

Coating application station means the part of a coating operation where the coating is applied, e.g., a spray booth.

Coating operation means those activities in which a coating is applied to a substrate and is subsequently air-dried, cured in an oven, or cured by radiation.

Coating solids (or solids) means the part of the coating which remains after the coating is dried or cured; solids content is determined using data from the EPA Method 24, or an equivalent or alternative method.

Compliant coating/contact adhesive means a finishing material, contact adhesive, or strippable booth coating that meets the emission limits specified in Table 3 of this subpart.

Contact adhesive means an adhesive that is applied to two substrates, dried, and mated under only enough pressure to result in good contact. The bond is immediate and sufficiently strong to hold pieces together without further clamping, pressure, or airing.

Continuous coater means a finishing system that continuously applies finishing materials onto furniture parts moving along a conveyor. Finishing materials that are not transferred to the part are recycled to a reservoir. Several types of application methods can be used with a continuous coater including spraying, curtain coating, roll coating, dip coating, and flow coating.

Continuous compliance means that the affected source is meeting the emission limitations and other requirements of the rule at all times and is fulfilling all monitoring and recordkeeping provisions of the rule in order to demonstrate compliance.

Control device means any equipment that reduces the quantity of a pollutant that is emitted to the air. The device may destroy or secure the pollutant for subsequent recovery. Includes, but is not limited to, incinerators, carbon adsorbers, and condensers.

Control device efficiency means the ratio of the pollutant released by a control device and the pollutant introduced to the control device.

Control system means the combination of capture and control devices used to reduce emissions to the atmosphere.

Conventional air spray means a spray coating method in which the coating is atomized by mixing it with compressed air and applied at an air pressure greater than 10 pounds per square inch (gauge) at the point of atomization. Airless and air assisted airless spray technologies are not conventional air spray because the coating is not atomized by mixing it with compressed air. Electrostatic spray technology is also not considered conventional air spray because an electrostatic charge is employed to attract the coating to the workpiece.

Data quality objective (DQO) approach means a set of approval criteria that must be met so that data from an alternative test method can be used in determining the capture efficiency of a control system. For additional information, see *Guidelines for Determining Capture Efficiency*, January 1994. (Docket No. A-93-10, Item No. IV-B-1).

Day means a period of 24 consecutive hours beginning at midnight local time, or beginning at a time consistent with a facility's operating schedule.

Disposed offsite means sending used organic HAP solvent or coatings outside of the facility boundaries for disposal.

Emission means the release or discharge, whether directly or indirectly, of HAP into the ambient air.

Enamel means a coat of colored material, usually opaque, that is applied as a protective topcoat over a basecoat, primer, or previously applied enamel coats. In some cases, another finishing material may be applied as a topcoat over the enamel.

Equipment leak means emissions of VHAP from pumps, valves, flanges, or other equipment used to transfer or apply coatings, adhesives, or organic HAP solvents.

Equivalent method means any method of sampling and analyzing for an air pollutant that has been demonstrated to the Administrator's satisfaction to have a consistent and quantitatively known relationship to the reference method, under specific conditions.

Finishing material means a coating used in the wood furniture industry. Such materials include, but are not limited to, stains, basecoats, washcoats, enamels, sealers, and topcoats.

Finishing operation means those operations in which a finishing material is applied to a substrate and is subsequently air-dried, cured in an oven, or cured by radiation.

Foam adhesive means a contact adhesive used for gluing foam to fabric, foam to foam, and fabric to wood.

Gluing operation means those operations in which adhesives are used to join components, for example, to apply a laminate to a wood substrate or foam to fabric.

Incidental wood furniture manufacturer means a major source that is primarily engaged in the manufacture of products other than wood furniture or wood furniture components and that uses no more than 100 gallons per month of finishing material or adhesives in the manufacture of wood furniture or wood furniture components.

Incinerator means, for the purposes of this industry, an enclosed combustion device that thermally oxidizes volatile organic compounds to CO and CO₂. This term does not include devices that burn municipal or hazardous waste material.

Janitorial maintenance means the upkeep of equipment or building structures that is not directly related to the manufacturing process, for example, cleaning of restroom facilities.

Lower confidence limit (LCL) approach means a set of approval criteria that must be met so that data from an alternative test method can be used in determining the capture efficiency of a control system. For additional information, see *Guidelines for Determining Capture Efficiency*, January 1994. (Docket No. A-93-10, Item No. IV-B-1).

Material safety data sheet (MSDS) means the documentation required for hazardous chemicals by the Occupational Safety and Health Administration (OSHA) Hazard Communication Standard (29 CFR Part 1910) for a solvent, cleaning material, contact adhesive, coating, or other material that identifies select reportable hazardous ingredients of the material, safety and health considerations, and handling procedures.

Noncompliant coating/contact adhesive means a finishing material, contact adhesive, or strippable booth coating that has a VHAP content (VOC content for the strippable booth coating) greater than the emission limitation presented in Table 3 of this subpart.

Nonporous substrate means a surface that is impermeable to liquids. Examples include metal, rigid plastic, flexible vinyl, and rubber.

Normally closed container means a container that is closed unless an operator is actively engaged in activities such as emptying or filling the container.

Operating parameter value means a minimum or maximum value established for a control device or process parameter that, if achieved by itself or in combination with one or more other operating parameter values, determines that an owner or operator has complied with an applicable emission limit.

Organic HAP solvent means a HAP that is a volatile organic liquid used for dissolving or dispersing constituents in a coating or contact adhesive, adjusting the viscosity of a coating or contact adhesive, or cleaning equipment. When used in a coating or contact adhesive, the organic HAP solvent evaporates during drying and does not become a part of the dried film.

Overall control efficiency means the efficiency of a control system, calculated as the product of the capture and control device efficiencies, expressed as a percentage.

Permanent total enclosure means a permanently installed enclosure that completely surrounds a source of emissions such that all emissions are captured and contained for discharge through a control device. For additional information, see *Guidelines for Determining Capture Efficiency*, January 1994. (Docket No. A-93-10, Item No. IV-B-1).

Recycled onsite means the reuse of an organic HAP solvent in a process other than cleaning or washoff.

Reference method means any method of sampling and analyzing for an air pollutant that is published in Appendix A of 40 CFR part 60.

Research or laboratory facility means any stationary source whose primary purpose is to conduct research and development to develop new processes and products where such source is operated under the close supervision of technically trained personnel and is not engaged in the manufacture of products for commercial sale in commerce, except in a de minimis manner.

Responsible official has the meaning given to it in 40 CFR part 70, State Operating Permit Programs (Title V permits).

Sealer means a finishing material used to seal the pores of a wood substrate before additional coats of finishing material are applied. Special purpose finishing materials that are used in some finishing systems to optimize aesthetics are not sealers.

Solvent means a liquid used in a coating or contact adhesive to dissolve or disperse constituents and/or to adjust viscosity. It evaporates during drying and does not become a part of the dried film.

Stain means any color coat having a solids content by weight of no more than 8.0 percent that is applied in single or multiple coats directly to the substrate. It includes, but is not limited to, nongrain raising stains, equalizer stains, prestains, sap stains, body stains, no-wipe stains, penetrating stains, and toners.

Storage containers means vessels or tanks, including mix equipment, used to hold finishing, gluing, cleaning, or washoff materials.

Strippable spray booth material means a coating that:

- (1) Is applied to a spray booth wall to provide a protective film to receive over spray during finishing operations;
- (2) That is subsequently peeled off and disposed; and
- (3) By achieving (1) and (2) of this definition reduces or eliminates the need to use organic HAP solvents to clean spray booth walls.

Substrate means the surface onto which a coating or contact adhesive is applied (or into which a coating or contact adhesive is impregnated).

Temporary total enclosure means an enclosure that meets the requirements of §63.805(e)(1) (i) through (iv) and is not permanent, but constructed only to measure the capture efficiency of pollutants emitted from a given source. Additionally, any exhaust point from the enclosure shall be at least four equivalent duct or hood diameters from each natural draft opening. For additional information, see *Guidelines for Determining Capture Efficiency*, January 1994. (Docket No. A-93-10, Item No. IV-B-1).

Thinner means a volatile liquid that is used to dilute coatings or contact adhesives (to reduce viscosity, color strength, and solids, or to modify drying conditions).

Topcoat means the last film-building finishing material that is applied in a finishing system.

Touchup and repair means the application of finishing materials to cover minor finishing imperfections.

VHAP means any volatile hazardous air pollutant listed in Table 2 to Subpart JJ.

VHAP of potential concern means any VHAP from the list in table 6 of this subpart.

Volatile organic compound (VOC) means any organic compound which participates in atmospheric photochemical reactions, that is, any organic compound other than those which the Administrator designates as having negligible photochemical reactivity. A VOC may be measured by a reference method, an equivalent method, an alternative method, or by procedures specified under any rule. A reference method, an equivalent method, or an alternative method, however, may also measure nonreactive organic compounds. In such cases, the owner or operator may exclude the nonreactive organic compounds when determining compliance with a standard. For a list of compounds that the Administrator has designated as having negligible photochemical reactivity, refer to 40 CFR part 51.10.

Washcoat means a transparent special purpose finishing material having a solids content by weight of 12.0 percent by weight or less. Washcoats are applied over initial stains to protect, to control color, and to stiffen the wood fibers in order to aid sanding.

Washoff operations means those operations in which organic HAP solvent is used to remove coating from wood furniture or a wood furniture component.

Wood furniture means any product made of wood, a wood product such as rattan or wicker, or an engineered wood product such as particleboard that is manufactured under any of the following standard industrial classification codes: 2434, 2511, 2512, 2517, 2519, 2521, 2531, 2541, 2599, or 5712.

Wood furniture component means any part that is used in the manufacture of wood furniture. Examples include, but are not limited to, drawer sides, cabinet doors, seat cushions, and laminated tops. However, foam seat cushions manufactured and fabricated at a facility that does not engage in any other wood furniture or wood furniture component manufacturing operation are excluded from this definition.

Wood furniture manufacturing operations means the finishing, gluing, cleaning, and washoff operations associated with the production of wood furniture or wood furniture components.

(b) The nomenclature used in this subpart has the following meaning:

(1) A_k = the area of each natural draft opening (k) in a total enclosure, in square meters.

(2) C_c = the VHAP content of a finishing material (c), in kilograms of volatile hazardous air pollutants per kilogram of coating solids (kg VHAP/kg solids), as supplied. Also given in pounds of volatile hazardous air pollutants per pound of coating solids (lb VHAP/lb solids).

(3) C_{aj} = the concentration of VHAP in gas stream (j) exiting the control device, in parts per million by volume.

(4) C_{bi} = the concentration of VHAP in gas stream (i) entering the control device, in parts per million by volume.

(5) C_{di} = the concentration of VHAP in gas stream (i) entering the control device from the affected source, in parts per million by volume.

- (6) C_{fk} = the concentration of VHAP in uncontrolled gas stream (k) emitted directly to the atmosphere from the affected source, in parts per million by volume.
- (7) E = the emission limit achieved by an emission point or a set of emission points, in kg VHAP/kg solids (lb VHAP/lb solids).
- (8) F = the control device efficiency, expressed as a fraction.
- (9) FV = the average inward face velocity across all natural draft openings in a total enclosure, in meters per hour.
- (10) G = the VHAP content of a contact adhesive, in kg VHAP/kg solids (lb VHAP/lb solids), as applied.
- (11) M = the mass of solids in finishing material used monthly, kg solids/month (lb solids/month).
- (12) N = the capture efficiency, expressed as a fraction.
- (13) Q_{aj} = the volumetric flow rate of gas stream (j) exiting the control device, in dry standard cubic meters per hour.
- (14) Q_{bi} = the volumetric flow rate of gas stream (i) entering the control device, in dry standard cubic meters per hour.
- (15) Q_{di} = the volumetric flow rate of gas stream (i) entering the control device from the emission point, in dry standard cubic meters per hour.
- (16) Q_{fk} = the volumetric flow rate of uncontrolled gas stream (k) emitted directly to the atmosphere from the emission point, in dry standard cubic meters per hour.
- (17) Q_{ini} = the volumetric flow rate of gas stream (i) entering the total enclosure through a forced makeup air duct, in standard cubic meters per hour (wet basis).
- (18) Q_{outj} = the volumetric flow rate of gas stream (j) exiting the total enclosure through an exhaust duct or hood, in standard cubic meters per hour (wet basis).
- (19) R = the overall efficiency of the control system, expressed as a percentage.
- (20) S = the VHAP content of a solvent, expressed as a weight fraction, added to finishing materials.
- (21) W = the amount of solvent, in kilograms (pounds), added to finishing materials during the monthly averaging period.
- (22) ac = after the control system is installed and operated.
- (23) bc = before control.

[60 FR 62936, Dec. 7, 1995, as amended at 62 FR 30260, June 3, 1997; 62 FR 31363, June 9, 1997; 63 FR 71380, Dec. 28, 1998]

§ 63.802 Emission limits.

(a) Each owner or operator of an existing affected source subject to this subpart shall:

(1) Limit VHAP emissions from finishing operations by meeting the emission limitations for existing sources presented in Table 3 of this subpart, using any of the compliance methods in §63.804(a). To

determine VHAP emissions from a finishing material containing formaldehyde or styrene, the owner or operator of the affected source shall use the methods presented in §63.803(l)(2) for determining styrene and formaldehyde usage.

(2) Limit VHAP emissions from contact adhesives by achieving a VHAP limit for contact adhesives based on the following criteria:

(i) For foam adhesives (contact adhesives used for upholstery operations) used in products that meet the upholstered seating flammability requirements of California Technical Bulletin 116, 117, or 133, the Business and Institutional Furniture Manufacturers Association's (BIFMA's) X5.7, UFAC flammability testing, or any similar requirements from local, State, or Federal fire regulatory agencies, the VHAP content of the adhesive shall not exceed 1.8 kg VHAP/kg solids (1.8 lb VHAP/lb solids), as applied; or

(ii) For all other contact adhesives (including foam adhesives used in products that do not meet the standards presented in paragraph (a)(2)(i) of this section, but excluding aerosol adhesives and excluding contact adhesives applied to nonporous substrates, the VHAP content of the adhesive shall not exceed 1.0 kg VHAP/kg solids (1.0 lb VHAP/lb solids), as applied.

(3) Limit HAP emissions from strippable spray booth coatings by using coatings that contain no more than 0.8 kg VOC/kg solids (0.8 lb VOC/lb solids), as applied.

(b) Each owner or operator of a new affected source subject to this subpart shall:

(1) Limit VHAP emissions from finishing operations by meeting the emission limitations for new sources presented in Table 3 of this subpart using any of the compliance methods in §63.804(d). To determine VHAP emissions from a finishing material containing formaldehyde or styrene, the owner or operator of the affected source shall use the methods presented in §63.803(l)(2) for determining styrene and formaldehyde usage.

(2) Limit VHAP emissions from contact adhesives by achieving a VHAP limit for contact adhesives, excluding aerosol adhesives and excluding contact adhesives applied to nonporous substrates, of no greater than 0.2 kg VHAP/kg solids (0.2 lb VHAP/lb solids), as applied, using either of the compliance methods in §63.804(e).

(3) Limit HAP emissions from strippable spray booth coatings by using coatings that contain no more than 0.8 kg VOC/kg solids (0.8 lb VOC/lb solids), as applied.

§ 63.803 Work practice standards.

(a) *Work practice implementation plan.* (1) Each owner or operator of an affected source subject to this subpart shall prepare and maintain a written work practice implementation plan that defines environmentally desirable work practices for each wood furniture operation manufacturing operation and addresses each of the work practice standards presented in paragraphs (b) through (l) of this section. The plan shall be developed no more than 60 days after the compliance date.

(2) The written work practice implementation plan shall be available for inspection by the Administrator (or delegated State, local, or Tribal authority) upon request. If the Administrator (or delegated State, local, or Tribal authority) determines that the work practice implementation plan does not include sufficient mechanisms for ensuring that the work practice standards are being implemented, the Administrator (or delegated State, local, or Tribal authority) may require the affected source to modify the plan. Revisions or modifications to the plan do not require a revision of the source's Title V permit.

(3) The inspection and maintenance plan required by paragraph (c) of this section and the formulation assessment plan for finishing operations required by paragraph (l) of this section are also reviewable by the Administrator (or delegated State, local, or Tribal authority).

(b) *Operator training course.* Each owner or operator of an affected source shall train all new and existing personnel, including contract personnel, who are involved in finishing, gluing, cleaning, and washoff operations, use of manufacturing equipment, or implementation of the requirements of this subpart. All new personnel, those hired after the compliance date of the standard, shall be trained upon hiring. All existing personnel, those hired before the compliance date of the standard, shall be trained

within six months of the compliance date of the standard. All personnel shall be given refresher training annually. The affected source shall maintain a copy of the training program with the work practice implementation plan. The training program shall include, at a minimum, the following:

- (1) A list of all current personnel by name and job description that are required to be trained;
- (2) An outline of the subjects to be covered in the initial and refresher training for each position or group of personnel;
- (3) Lesson plans for courses to be given at the initial and the annual refresher training that include, at a minimum, appropriate application techniques, appropriate cleaning and washoff procedures, appropriate equipment setup and adjustment to minimize finishing material usage and overspray, and appropriate management of cleanup wastes; and
- (4) A description of the methods to be used at the completion of initial or refresher training to demonstrate and document successful completion.

(c) *Inspection and maintenance plan.* Each owner or operator of an affected source shall prepare and maintain with the work practice implementation plan a written leak inspection and maintenance plan that specifies:

- (1) A minimum visual inspection frequency of once per month for all equipment used to transfer or apply coatings, adhesives, or organic HAP solvents;
- (2) An inspection schedule;
- (3) Methods for documenting the date and results of each inspection and any repairs that were made;
- (4) The timeframe between identifying the leak and making the repair, which adheres, at a minimum, to the following schedule:
 - (i) A first attempt at repair (e.g., tightening of packing glands) shall be made no later than five calendar days after the leak is detected; and
 - (ii) Final repairs shall be made within 15 calendar days after the leak is detected, unless the leaking equipment is to be replaced by a new purchase, in which case repairs shall be completed within three months.

(d) *Cleaning and washoff solvent accounting system.* Each owner or operator of an affected source shall develop an organic HAP solvent accounting form to record:

- (1) The quantity and type of organic HAP solvent used each month for washoff and cleaning, as defined in §63.801 of this subpart;
- (2) The number of pieces washed off, and the reason for the washoff; and
- (3) The quantity of spent organic HAP solvent generated from each washoff and cleaning operation each month, and whether it is recycled onsite or disposed offsite.

(e) *Chemical composition of cleaning and washoff solvents.* Each owner or operator of an affected source shall not use cleaning or washoff solvents that contain any of the pollutants listed in Table 4 to this subpart, in concentrations subject to MSDS reporting as required by OSHA.

(f) *Spray booth cleaning.* Each owner or operator of an affected source shall not use compounds containing more than 8.0 percent by weight of VOC for cleaning spray booth components other than conveyors, continuous coaters and their enclosures, or metal filters, or plastic filters unless the spray booth is being refurbished. If the spray booth is being refurbished, that is the spray booth coating or other protective material used to cover the booth is being replaced, the affected source shall use no more than 1.0 gallon of organic HAP solvent per booth to prepare the surface of the booth prior to

applying the booth coating.

(g) *Storage requirements.* Each owner or operator of an affected source shall use normally closed containers for storing finishing, gluing, cleaning, and washoff materials.

(h) *Application equipment requirements.* Each owner or operator of an affected source shall use conventional air spray guns to apply finishing materials only under any of the following circumstances:

(1) To apply finishing materials that have a VOC content no greater than 1.0 lb VOC/lb solids, as applied;

(2) For touchup and repair under the following conditions:

(i) The touchup and repair occurs after completion of the finishing operation; or

(ii) The touchup and repair occurs after the application of stain and before the application of any other type of finishing material, and the materials used for touchup and repair are applied from a container that has a volume of no more than 2.0 gallons.

(3) When spray is automated, that is, the spray gun is aimed and triggered automatically, not manually;

(4) When emissions from the finishing application station are directed to a control device;

(5) The conventional air gun is used to apply finishing materials and the cumulative total usage of that finishing material is no more than 5.0 percent of the total gallons of finishing material used during that semiannual period; or

(6) The conventional air gun is used to apply stain on a part for which it is technically or economically infeasible to use any other spray application technology.

The affected source shall demonstrate technical or economic infeasibility by submitting to the Administrator a videotape, a technical report, or other documentation that supports the affected source's claim of technical or economic infeasibility. The following criteria shall be used, either independently or in combination, to support the affected source's claim of technical or economic infeasibility:

(i) The production speed is too high or the part shape is too complex for one operator to coat the part and the application station is not large enough to accommodate an additional operator; or

(ii) The excessively large vertical spray area of the part makes it difficult to avoid sagging or runs in the stain.

(i) *Line cleaning.* Each owner or operator of an affected source shall pump or drain all organic HAP solvent used for line cleaning into a normally closed container.

(j) *Gun cleaning.* Each owner or operator of an affected source shall collect all organic HAP solvent used to clean spray guns into a normally closed container.

(k) *Washoff operations.* Each owner or operator of an affected source shall control emissions from washoff operations by:

(1) Using normally closed tanks for washoff; and

(2) Minimizing dripping by tilting or rotating the part to drain as much solvent as possible.

(l) *Formulation assessment plan for finishing operations.* Each owner or operator of an affected source shall prepare and maintain with the work practice implementation plan a formulation assessment plan that:

(1) Identifies VHAP from the list presented in Table 5 of this subpart that are being used in finishing operations by the affected source;

(2) Establishes a baseline level of usage by the affected source, for each VHAP identified in paragraph (l)(1) of this section. The baseline usage level shall be the highest annual usage from 1994, 1995, or 1996, for each VHAP identified in paragraph (l)(1) of this section. For formaldehyde, the baseline level of usage shall be based on the amount of free formaldehyde present in the finishing material when it is applied. For styrene, the baseline level of usage shall be an estimate of unreacted styrene, which shall be calculated by multiplying the amount of styrene monomer in the finishing material, when it is applied, by a factor of 0.16. Sources using a control device to reduce emissions may adjust their usage based on the overall control efficiency of the control system, which is determined using the equation in §63.805 (d) or (e).

(3) Tracks the annual usage of each VHAP identified in (l)(1) by the affected source that is present in amounts subject to MSDS reporting as required by OSHA.

(4) If, after November 1998, the annual usage of the VHAP identified in paragraph (l)(1) exceeds its baseline level, then the owner or operator of the affected source shall provide a written notification to the permitting authority that describes the amount of the increase and explains the reasons for exceedance of the baseline level. The following explanations would relieve the owner or operator from further action, unless the affected source is not in compliance with any State regulations or requirements for that VHAP:

(i) The exceedance is no more than 15.0 percent above the baseline level;

(ii) Usage of the VHAP is below the *de minimis* level presented in Table 5 of this subpart for that VHAP (sources using a control device to reduce emissions may adjust their usage based on the overall control efficiency of the control system, which is determined using the procedures in §63.805 (d) or (e));

(iii) The affected source is in compliance with its State's air toxic regulations or guidelines for the VHAP; or

(iv) The source of the pollutant is a finishing material with a VOC content of no more than 1.0 kg VOC/kg solids (1.0 lb VOC/lb solids), as applied.

(5) If none of the above explanations are the reason for the increase, the owner or operator shall confer with the permitting authority to discuss the reason for the increase and whether there are practical and reasonable technology-based solutions for reducing the usage. The evaluation of whether a technology is reasonable and practical shall be based on cost, quality, and marketability of the product, whether the technology is being used successfully by other wood furniture manufacturing operations, or other criteria mutually agreed upon by the permitting authority and owner or operator. If there are no practical and reasonable solutions, the facility need take no further action. If there are solutions, the owner or operator shall develop a plan to reduce usage of the pollutant to the extent feasible. The plan shall address the approach to be used to reduce emissions, a timetable for implementing the plan, and a schedule for submitting notification of progress.

(6) If, after November 1998, an affected source uses a VHAP of potential concern listed in table 6 of this subpart for which a baseline level has not been previously established, then the baseline level shall be established as the *de minimis* level provided in that same table for that chemical. The affected source shall track the annual usage of each VHAP of potential concern identified in this paragraph that is present in amounts subject to MSDS reporting as required by OSHA. If usage of the VHAP of potential concern exceeds the *de minimis* level listed in table 6 of this subpart for that chemical, then the affected source shall provide an explanation to the permitting authority that documents the reason for the exceedance of the *de minimis* level. If the explanation is not one of those listed in paragraphs (l)(4)(i) through (l)(4)(iv) of this section, the affected source shall follow the procedures in paragraph (l)(5) of this section.

[60 FR 62936, Dec. 7, 1995, as amended at 63 FR 71380, Dec. 28, 1998; 68 FR 37353, June 23, 2003]

§ 63.804 Compliance procedures and monitoring requirements.

(a) The owner or operator of an existing affected source subject to §63.802(a)(1) shall comply with those provisions using any of the methods presented in §63.804 (a)(1) through (a)(4).

(1) Calculate the average VHAP content for all finishing materials used at the facility using Equation 1, and maintain a value of E no greater than 1.0;

$$E = \frac{(M_{c1}C_{c1} + M_{c2}C_{c2} + \dots + M_{cn}C_{cn} + S_1W_1 + S_2W_2 + \dots + S_nW_n)}{(M_{c1} + M_{c2} + \dots + M_{cn})} \quad \text{Equation 1}$$

(2) Use compliant finishing materials according to the following criteria:

(i) Demonstrate that each stain, sealer, and topcoat has a VHAP content of no more than 1.0 kg VHAP/kg solids (1.0 lb VHAP/lb solids), as applied, and each thinner contains no more than 10.0 percent VHAP by weight by maintaining certified product data sheets for each coating and thinner;

(ii) Demonstrate that each washcoat, basecoat, and enamel that is purchased pre-made, that is, it is not formulated onsite by thinning another finishing material, has a VHAP content of no more than 1.0 kg VHAP/kg solids (1.0 lb VHAP/lb solids), as applied, and each thinner contains no more than 10.0 percent VHAP by weight by maintaining certified product data sheets for each coating and thinner; and

(iii) Demonstrate that each washcoat, basecoat, and enamel that is formulated at the affected source is formulated using a finishing material containing no more than 1.0 kg VHAP/kg solids (1.0 lb VHAP/lb solids) and a thinner containing no more than 3.0 percent VHAP by weight.

(3) Use a control system with an overall control efficiency (R) such that the value of E_{ac} in Equation 2 is no greater than 1.0.

$$R = [(E_{bc} - E_{ac}) / E_{bc}] (100) \quad \text{Equation 2}$$

The value of E_{bc} in Equation 2 shall be calculated using Equation 1; or

(4) Use any combination of an averaging approach, as described in paragraph (a)(1) of this section, compliant finishing materials, as described in paragraph (a)(2) of this section, and a control system, as described in paragraph (a)(3) of this section.

(b) The owner or operator of an affected source subject to §63.802(a)(2)(i) shall comply with the provisions by using compliant foam adhesives with a VHAP content no greater than 1.8 kg VHAP/kg solids (1.8 lb VHAP/lb solids), as applied.

(c) The owner or operator of an affected source subject to §63.802(a)(2)(ii) shall comply with those provisions by using either of the methods presented in §63.804 (c)(1) and (c)(2).

(1) Use compliant contact adhesives with a VHAP content no greater than 1.0 kg VHAP/kg solids (1.0 lb VHAP/lb solids), as applied; or

(2) Use a control system with an overall control efficiency (R) such that the value of G_{ac} is no greater than 1.0.

$$R = [(G_{bc} - G_{ac}) / G_{bc}] (100) \quad \text{Equation 3}$$

(d) The owner or operator of a new affected source subject to §63.802(b)(1) may comply with those provisions by using any of the following methods:

(1) Calculate the average VHAP content across all finishing materials used at the facility using Equation 1, and maintain a value of E no greater than 0.8;

(2) Use compliant finishing materials according to the following criteria:

(i) Demonstrate that each sealer and topcoat has a VHAP content of no more than 0.8 kg VHAP/kg solids (0.8 lb VHAP/lb solids), as applied, each stain has a VHAP content of no more than 1.0 kg VHAP/kg solids (1.0 lb VHAP/lb solids), as applied, and each thinner contains no more than 10.0 percent VHAP by weight;

(ii) Demonstrate that each washcoat, basecoat, and enamel that is purchased pre-made, that is, it is not formulated onsite by thinning another finishing material, has a VHAP content of no more than 0.8 kg VHAP/kg solids (0.8 lb VHAP/lb solids), as applied, and each thinner contains no more than 10.0 percent VHAP by weight; and

(iii) Demonstrate that each washcoat, basecoat, and enamel that is formulated onsite is formulated using a finishing material containing no more than 0.8 kg VHAP/kg solids (0.8 lb VHAP/lb solids) and a thinner containing no more than 3.0 percent HAP by weight.

(3) Use a control system with an overall control efficiency (R) such that the value of E_{ac} in Equation 4 is no greater than 0.8.

$$R = [(E_{bc} - E_{ac}) / E_{bc}] (100) \quad \text{Equation 4}$$

The value of E_{bc} in Equation 4 shall be calculated using Equation 1; or

(4) Use any combination of an averaging approach, as described in (d)(1), compliant finishing materials, as described in (d)(2), and a control system, as described in (d)(3).

(e) The owner or operator of a new affected source subject to §63.802(b)(2) shall comply with the provisions using either of the following methods:

(1) Use compliant contact adhesives with a VHAP content no greater than 0.2 kg VHAP/kg solids (0.2 lb VHAP/lb solids), as applied; or

(2) Use a control system with an overall control efficiency (R) such that the value of G_{ac} in Equation 3 is no greater than 0.2.

(f) *Initial compliance.* (1) Owners or operators of an affected source subject to the provisions of §63.802 (a)(1) or (b)(1) that comply through the procedures established in §63.804 (a)(1) or (d)(1) shall submit the results of the averaging calculation (Equation 1) for the first month with the initial compliance status report required by §63.807(b). The first month's calculation shall include data for the entire month in which the compliance date falls. For example, if the source's compliance date is November 21, 1997, the averaging calculation shall include data from November 1, 1997 to November 30, 1997.

(2) Owners or operators of an affected source subject to the provisions of §63.802 (a)(1) or (b)(1) that comply through the procedures established in §63.804 (a)(2) or (d)(2) shall submit an initial compliance status report, as required by §63.807(b), stating that compliant stains, washcoats, sealers, topcoats, basecoats, enamels, and thinners, as applicable, are being used by the affected source.

(3) Owners or operators of an affected source subject to the provisions of §63.802 (a)(1) or (b)(1) that are complying through the procedures established in §63.804 (a)(2) or (d)(2) and are applying coatings using continuous coaters shall demonstrate initial compliance by:

(i) Submitting an initial compliance status report, as required by §63.807(b), stating that compliant coatings, as determined by the VHAP content of the coating in the reservoir and the VHAP content as calculated from records, and compliant thinners are being used; or

(ii) Submitting an initial compliance status report, as required by §63.807(b), stating that compliant coatings, as determined by the VHAP content of the coating in the reservoir, are being used; the viscosity of the coating in the reservoir is being monitored; and compliant thinners are being used. The affected source shall also submit data that demonstrate that viscosity is an appropriate parameter for demonstrating compliance.

(4) Owners or operators of an affected source subject to the provisions of §63.802 (a)(1) or (b)(1) that comply through the procedures established in §63.804 (a)(3) or (d)(3) shall demonstrate initial compliance by:

(i) Submitting a monitoring plan that identifies each operating parameter to be monitored for the capture device and discusses why each parameter is appropriate for demonstrating continuous compliance;

(ii) Conducting an initial performance test as required under §63.7 using the procedures and test methods listed in §63.7 and §63.805 (c) and (d) or (e);

(iii) Calculating the overall control efficiency (R) following the procedures in §63.805 (d) or (e); and

(iv) Determining those operating conditions critical to determining compliance and establishing one or more operating parameters that will ensure compliance with the standard.

(A) For compliance with a thermal incinerator, minimum combustion temperature shall be the operating parameter.

(B) For compliance with a catalytic incinerator equipped with a fixed catalyst bed, the minimum gas temperature both upstream and downstream of the catalyst bed shall be the operating parameter.

(C) For compliance with a catalytic incinerator equipped with a fluidized catalyst bed, the minimum gas temperature upstream of the catalyst bed and the pressure drop across the catalyst bed shall be the operating parameters.

(D) For compliance with a carbon adsorber, the operating parameters shall be the total regeneration mass stream flow for each regeneration cycle and the carbon bed temperature after each regeneration, or the concentration level of organic compounds exiting the adsorber, unless the owner or operator requests and receives approval from the Administrator to establish other operating parameters.

(E) For compliance with a control device not listed in this section, one or more operating parameter values shall be established using the procedures identified in §63.804(g)(4)(vi).

(v) Owners or operators complying with §63.804(f)(4) shall calculate each site-specific operating parameter value as the arithmetic average of the maximum or minimum operating parameter values, as appropriate, that demonstrate compliance with the standards, during the three test runs required by §63.805(c)(1).

(5) Owners or operators of an affected source subject to the provisions of §63.802 (a)(2) or (b)(2) that comply through the procedures established in §63.804 (b), (c)(1), or (e)(1), shall submit an initial compliance status report, as required by §63.807(b), stating that compliant contact adhesives are being used by the affected source.

(6) Owners or operators of an affected source subject to the provisions of §63.802 (a)(2)(ii) or (b)(2) that comply through the procedures established in §63.804 (c)(2) or (e)(2), shall demonstrate initial compliance by:

(i) Submitting a monitoring plan that identifies each operating parameter to be monitored for the capture device and discusses why each parameter is appropriate for demonstrating continuous compliance;

(ii) Conducting an initial performance test as required under §63.7 using the procedures and test methods listed in §63.7 and §63.805 (c) and (d) or (e);

(iii) Calculating the overall control efficiency (R) following the procedures in §63.805 (d) or (e); and

(iv) Determining those operating conditions critical to determining compliance and establishing one or more operating parameters that will ensure compliance with the standard.

(A) For compliance with a thermal incinerator, minimum combustion temperature shall be the operating

parameter.

(B) For compliance with a catalytic incinerator equipped with a fixed catalyst bed, the minimum gas temperature both upstream and downstream of the catalyst shall be the operating parameter.

(C) For compliance with a catalytic incinerator equipped with a fluidized catalyst bed, the minimum gas temperature upstream of the catalyst bed and the pressure drop across the catalyst bed shall be the operating parameters.

(v) Owners or operators complying with §63.804(f)(6) shall calculate each site-specific operating parameter value as the arithmetic average of the maximum or minimum operating values as appropriate, that demonstrate compliance with the standards, during the three test runs required by §63.805(c)(1).

(7) Owners or operators of an affected source subject to the provisions of §63.802 (a)(3) or (b)(3) shall submit an initial compliance status report, as required by §63.807(b), stating that compliant strippable spray booth coatings are being used by the affected source.

(8) Owners or operators of an affected source subject to the work practice standards in §63.803 shall submit an initial compliance status report, as required by §63.807(b), stating that the work practice implementation plan has been developed and procedures have been established for implementing the provisions of the plan.

(g) *Continuous compliance demonstrations.* (1) Owners or operators of an affected source subject to the provisions of §63.802 (a)(1) or (b)(1) that comply through the procedures established in §63.804 (a)(1) or (d)(1) shall demonstrate continuous compliance by submitting the results of the averaging calculation (Equation 1) for each month within that semiannual period and submitting a compliance certification with the semiannual report required by §63.807(c).

(i) The compliance certification shall state that the value of (E), as calculated by Equation 1, is no greater than 1.0 for existing sources or 0.8 for new sources. An affected source is in violation of the standard if E is greater than 1.0 for existing sources or 0.8 for new sources for any month. A violation of the monthly average is a separate violation of the standard for each day of operation during the month, unless the affected source can demonstrate through records that the violation of the monthly average can be attributed to a particular day or days during the period.

(ii) The compliance certification shall be signed by a responsible official of the company that owns or operates the affected source.

(2) Owners or operators of an affected source subject to the provisions of §63.802 (a)(1) or (b)(1) that comply through the procedures established in §63.804 (a)(2) or (d)(2) shall demonstrate continuous compliance by using compliant coatings and thinners, maintaining records that demonstrate the coatings and thinners are compliant, and submitting a compliance certification with the semiannual report required by §63.807(c).

(i) The compliance certification shall state that compliant stains, washcoats, sealers, topcoats, basecoats, enamels, and thinners, as applicable, have been used each day in the semiannual reporting period or should otherwise identify the periods of noncompliance and the reasons for noncompliance. An affected source is in violation of the standard whenever a noncompliant coating, as demonstrated by records or by a sample of the coating, is used.

(ii) The compliance certification shall be signed by a responsible official of the company that owns or operates the affected source.

(3) Owners or operators of an affected source subject to the provisions of §63.802 (a)(1) or (b)(1) that are complying through the procedures established in §63.804 (a)(2) or (d)(2) and are applying coatings using continuous coaters shall demonstrate continuous compliance by following the procedures in paragraph (g)(3) (i) or (ii) of this section.

(i) Using compliant coatings, as determined by the VHAP content of the coating in the reservoir and the VHAP content as calculated from records, using compliant thinners, and submitting a compliance certification with the semiannual report required by §63.807(c).

(A) The compliance certification shall state that compliant coatings have been used each day in the semiannual reporting period, or should otherwise identify the days of noncompliance and the reasons for noncompliance. An affected source is in violation of the standard whenever a noncompliant coating, as determined by records or by a sample of the coating, is used. Use of a noncompliant coating is a separate violation for each day the noncompliant coating is used.

(B) The compliance certification shall be signed by a responsible official of the company that owns or operates the affected source.

(ii) Using compliant coatings, as determined by the VHAP content of the coating in the reservoir, using compliant thinners, maintaining a viscosity of the coating in the reservoir that is no less than the viscosity of the initial coating by monitoring the viscosity with a viscosity meter or by testing the viscosity of the initial coating and retesting the coating in the reservoir each time solvent is added, maintaining records of solvent additions, and submitting a compliance certification with the semiannual report required by §63.807(c).

(A) The compliance certification shall state that compliant coatings, as determined by the VHAP content of the coating in the reservoir, have been used each day in the semiannual reporting period. Additionally, the certification shall state that the viscosity of the coating in the reservoir has not been less than the viscosity of the initial coating, that is, the coating that is initially mixed and placed in the reservoir, for any day in the semiannual reporting period.

(B) The compliance certification shall be signed by a responsible official of the company that owns or operates the affected source.

(C) An affected source is in violation of the standard when a sample of the as-applied coating exceeds the applicable limit established in §63.804 (a)(2) or (d)(2), as determined using EPA Method 311, or the viscosity of the coating in the reservoir is less than the viscosity of the initial coating.

(4) Owners or operators of an affected source subject to the provisions of §63.802 (a)(1) or (b)(1) that comply through the procedures established in §63.804 (a)(3) or (d)(3) shall demonstrate continuous compliance by installing, calibrating, maintaining, and operating the appropriate monitoring equipment according to manufacturer's specifications. The owner or operator shall also submit the excess emissions and continuous monitoring system performance report and summary report required by §63.807(d) and §63.10(e) of subpart A.

(i) Where a capture/control device is used, a device to monitor each site-specific operating parameter established in accordance with §63.804(f)(6)(i) is required.

(ii) Where an incinerator is used, a temperature monitoring device equipped with a continuous recorder is required.

(A) Where a thermal incinerator is used, a temperature monitoring device shall be installed in the firebox or in the ductwork immediately downstream of the firebox in a position before any substantial heat exchange occurs.

(B) Where a catalytic incinerator equipped with a fixed catalyst bed is used, temperature monitoring devices shall be installed in the gas stream immediately before and after the catalyst bed.

(C) Where a catalytic incinerator equipped with a fluidized catalyst bed is used, a temperature monitoring device shall be installed in the gas stream immediately before the bed. In addition, a pressure monitoring device shall be installed to determine the pressure drop across the catalyst bed. The pressure drop shall be measured monthly at a constant flow rate.

(iii) Where a carbon adsorber is used one of the following is required:

(A) An integrating stream flow monitoring device having an accuracy of ± 10 percent, capable of recording the total regeneration stream mass flow for each regeneration cycle; and a carbon bed temperature monitoring device, having an accuracy of ± 1 percent of the temperature being monitored or ± 0.5 °C, whichever is greater, and capable of recording the carbon bed temperature after each regeneration and within 15 minutes of completing any cooling cycle;

(B) An organic monitoring device, equipped with a continuous recorder, to indicate the concentration level of organic compounds exiting the carbon adsorber; or

(C) Any other monitoring device that has been approved by the Administrator in accordance with §63.804(f)(4)(iv)(D).

(iv) Owners or operators of an affected source shall not operate the capture or control device at a daily average value greater than or less than (as appropriate) the operating parameter values. The daily average value shall be calculated as the average of all values for a monitored parameter recorded during the operating day.

(v) Owners or operators of an affected source that are complying through the use of a catalytic incinerator equipped with a fluidized catalyst bed shall maintain a constant pressure drop, measured monthly, across the catalyst bed.

(vi) An owner or operator who uses a control device not listed in §63.804(f)(4) shall submit, for the Administrator's approval, a description of the device, test data verifying performance, and appropriate site-specific operating parameters that will be monitored to demonstrate continuous compliance with the standard.

(5) Owners or operators of an affected source subject to the provisions of §63.802 (a)(2) (i) or (ii) or (b) (2) that comply through the procedures established in §63.804 (b), (c)(1), or (e)(1), shall submit a compliance certification with the semiannual report required by §63.807(c).

(i) The compliance certification shall state that compliant contact and/or foam adhesives have been used each day in the semiannual reporting period, or should otherwise identify each day noncompliant contact and/or foam adhesives were used. Each day a noncompliant contact or foam adhesive is used is a single violation of the standard.

(ii) The compliance certification shall be signed by a responsible official of the company that owns or operates the affected source.

(6) Owners or operators of an affected source subject to the provisions of §63.802 (a)(2)(ii) or (b)(2) that comply through the procedures established in §63.804 (c)(2) or (e)(2), shall demonstrate continuous compliance by installing, calibrating, maintaining, and operating the appropriate monitoring equipment according to the manufacturer's specifications. The owner or operator shall also submit the excess emissions and continuous monitoring system performance report and summary report required by §63.807(d) and §63.10(e) of subpart A of this part.

(i) Where a capture/control device is used, a device to monitor each site-specific operating parameter established in accordance with §63.804(f)(6)(i) is required.

(ii) Where an incinerator is used, a temperature monitoring device equipped with a continuous recorder is required.

(A) Where a thermal incinerator is used, a temperature monitoring device shall be installed in the firebox or in the ductwork immediately downstream of the firebox in a position before any substantial heat exchange occurs.

(B) Where a catalytic incinerator equipped with a fixed catalyst bed is used, temperature monitoring devices shall be installed in the gas stream immediately before and after the catalyst bed.

(C) Where a catalytic incinerator equipped with a fluidized catalyst bed is used, a temperature monitoring device shall be installed in the gas stream immediately before the bed. In addition, a pressure monitoring device shall be installed to measure the pressure drop across the catalyst bed. The pressure drop shall be measured monthly at a constant flow rate.

(iii) Where a carbon adsorber is used one of the following is required:

(A) An integrating stream flow monitoring device having an accuracy of ± 10 percent, capable of

recording the total regeneration stream mass flow for each regeneration cycle; and a carbon bed temperature monitoring device, having an accuracy of ± 1 percent of the temperature being monitored or ± 0.5 °C, whichever is greater, and capable of recording the carbon bed temperature after each regeneration and within 15 minutes of completing any cooling cycle;

(B) An organic monitoring device, equipped with a continuous recorder, to indicate the concentration level of organic compounds exiting the carbon adsorber; or

(C) Any other monitoring device that has been approved by the Administrator in accordance with §63.804(f)(4)(iv)(D).

(iv) Owners or operators of an affected source shall not operate the capture or control device at a daily average value greater than or less than (as appropriate) the operating parameter values. The daily average value shall be calculated as the average of all values for a monitored parameter recorded during the operating day.

(v) Owners or operators of an affected source that are complying through the use of a catalytic incinerator equipped with a fluidized catalyst bed shall maintain a constant pressure drop, measured monthly, across the catalyst bed.

(vi) An owner or operator using a control device not listed in this section shall submit to the Administrator a description of the device, test data verifying the performance of the device, and appropriate operating parameter values that will be monitored to demonstrate continuous compliance with the standard. Compliance using this device is subject to the Administrator's approval.

(7) Owners or operators of an affected source subject to the provisions of §63.802 (a)(3) or (b)(3) shall submit a compliance certification with the semiannual report required by §63.807(c).

(i) The compliance certification shall state that compliant strippable spray booth coatings have been used each day in the semiannual reporting period, or should otherwise identify each day noncompliant materials were used. Each day a noncompliant strippable booth coating is used is a single violation of the standard.

(ii) The compliance certification shall be signed by a responsible official of the company that owns or operates the affected source.

(8) Owners or operators of an affected source subject to the work practice standards in §63.803 shall submit a compliance certification with the semiannual report required by §63.807(c).

(i) The compliance certification shall state that the work practice implementation plan is being followed, or should otherwise identify the provisions of the plan that have not been implemented and each day the provisions were not implemented. During any period of time that an owner or operator is required to implement the provisions of the plan, each failure to implement an obligation under the plan during any particular day is a violation.

(ii) The compliance certification shall be signed by a responsible official of the company that owns or operates the affected source.

§ 63.805 Performance test methods.

(a) The EPA Method 311 of appendix A of part 63 shall be used in conjunction with formulation data to determine the VHAP content of the liquid coating. Formulation data shall be used to identify VHAP present in the coating. The EPA Method 311 shall then be used to quantify those VHAP identified through formulation data. The EPA Method 311 shall not be used to quantify HAP such as styrene and formaldehyde that are emitted during the cure. The EPA Method 24 (40 CFR part 60, appendix A) shall be used to determine the solids content by weight and the density of coatings. If it is demonstrated to the satisfaction of the Administrator that a coating does not release VOC or HAP byproducts during the cure, for example, all VOC and HAP present in the coating is solvent, then batch formulation information shall be accepted. The owner or operator of an affected source may request approval from the Administrator to use an alternative method for determining the VHAP content of the coating. In the event of any inconsistency between the EPA Method 24 or Method 311 test data and a facility's formulation data, that

is, if the EPA Method 24/311 value is higher, the EPA Method 24/311 test shall govern unless after consultation, a regulated source could demonstrate to the satisfaction of the enforcement agency that the formulation data were correct. Sampling procedures shall follow the guidelines presented in "Standard Procedures for Collection of Coating and Ink Samples for VOC Content Analysis by Reference Method 24 and Reference Method 24A," EPA-340/1-91-010. (Docket No. A-93-10, Item No. IV-A-1).

(b) Owners or operators demonstrating compliance in accordance with §63.804 (f)(4) or (f)(6) and §63.804 (g)(4) or (g)(6), or complying with any of the other emission limits of §63.802 by operating a capture or control device shall determine the overall control efficiency of the control system (R) as the product of the capture and control device efficiency, using the test methods cited in §63.805(c) and the procedures in §63.805 (d) or (e).

(c) When an initial compliance demonstration is required by §63.804 (f)(4) or (f)(6) of this subpart, the procedures in paragraphs (c)(1) through (c)(6) of this section shall be used in determining initial compliance with the provisions of this subpart.

(1) The EPA Method 18 (40 CFR part 60, appendix A) shall be used to determine the HAP concentration of gaseous air streams. The test shall consist of three separate runs, each lasting a minimum of 30 minutes.

(2) The EPA Method 1 or 1A (40 CFR part 60, appendix A) shall be used for sample and velocity traverses.

(3) The EPA Method 2, 2A, 2C, or 2D (40 CFR part 60, appendix A) shall be used to measure velocity and volumetric flow rates.

(4) The EPA Method 3 (40 CFR part 60, appendix A) shall be used to analyze the exhaust gases.

(5) The EPA Method 4 (40 CFR part 60, appendix A) shall be used to measure the moisture in the stack gas.

(6) The EPA Methods 2, 2A, 2C, 2D, 3, and 4 shall be performed, as applicable, at least twice during each test period.

(d) Each owner or operator of an affected source demonstrating compliance in accordance with §63.804 (f)(4) or (f)(6) shall perform a gaseous emission test using the following procedures:

(1) Construct the overall HAP emission reduction system so that all volumetric flow rates and total HAP emissions can be accurately determined by the applicable test methods specified in §63.805(c) (1) through (6);

(2) Determine capture efficiency from the affected emission point(s) by capturing, venting, and measuring all HAP emissions from the affected emission point(s). During a performance test, the owner or operator shall isolate affected emission point(s) located in an area with other nonaffected gaseous emission sources from all other gaseous emission point(s) by any of the following methods:

(i) Build a temporary total enclosure (see §63.801) around the affected emission point(s); or

(ii) Use the building that houses the process as the enclosure (see §63.801);

(iii) Use any alternative protocol and test method provided they meet either the requirements of the data quality objective (DQO) approach or the lower confidence level (LCL) approach (see §63.801);

(iv) Shut down all nonaffected HAP emission point(s) and continue to exhaust fugitive emissions from the affected emission point(s) through any building ventilation system and other room exhausts such as drying ovens. All exhaust air must be vented through stacks suitable for testing; or

(v) Use another methodology approved by the Administrator provided it complies with the EPA criteria for acceptance under part 63, appendix A, Method 301.

(3) Operate the control device with all affected emission points that will subsequently be delivered to the control device connected and operating at maximum production rate;

(4) Determine the efficiency (F) of the control device using the following equation:

$$F = \frac{\sum_{i=1}^n Q_{di} C_{di} - \sum_{j=1}^p Q_{uj} C_{uj}}{\sum_{i=1}^n Q_{di} C_{di}} \quad (\text{Equation 5})$$

(5) Determine the efficiency (N) of the capture system using the following equation:

$$N = \frac{\sum_{i=1}^n Q_{ai} C_{ai}}{\sum_{i=1}^n Q_{ai} C_{ai} + \sum_{k=1}^p Q_{fk} C_{fk}} \quad (\text{Equation 6})$$

(6) For each affected source complying with §63.802(a)(1) in accordance with §63.804(a)(3), compliance is demonstrated if the product of (F×N)(100) yields a value (R) such that the value of E_{ac} in Equation 2 is no greater than 1.0.

(7) For each new affected source complying with §63.802(b)(1) in accordance with §63.804(d)(3), compliance is demonstrated if the product of (F×N)(100) yields a value (R) such that the value of E_{ac} in Equation 4 is no greater than 0.8.

(8) For each affected source complying with §63.802(a)(2)(ii) in accordance with §63.804(c)(2), compliance is demonstrated if the product of (F×N)(100) yields a value (R) such that the value of G_{ac} in Equation 3 is no greater than 1.0.

(9) For each new affected source complying with §63.802(b)(2) in accordance with §63.804(e)(2), compliance is demonstrated if the product of (F×N)(100) yields a value (R) such that the value of G_{ac} in Equation 3 is no greater than 0.2.

(e) An alternative method to the compliance method in §63.805(d) is the installation of a permanent total enclosure around the affected emission point(s). A permanent total enclosure presents prima facie evidence that all HAP emissions from the affected emission point(s) are directed to the control device. Each affected source that complies using a permanent total enclosure shall:

(1) Demonstrate that the total enclosure meets the requirements in paragraphs (e)(1) (i) through (iv). The owner or operator of an enclosure that does not meet these requirements may apply to the Administrator for approval of the enclosure as a total enclosure on a case-by-case basis. The enclosure shall be considered a total enclosure if it is demonstrated to the satisfaction of the Administrator that all HAP emissions from the affected emission point(s) are contained and vented to the control device. The requirements for automatic approval are as follows:

(i) The total area of all natural draft openings shall not exceed 5 percent of the total surface area of the total enclosure's walls, floor, and ceiling;

(ii) All sources of emissions within the enclosure shall be a minimum of four equivalent diameters away from each natural draft opening;

(iii) The average inward face velocity (FV) across all natural draft openings shall be a minimum of 3,600 meters per hour as determined by the following procedures:

(A) All forced makeup air ducts and all exhaust ducts are constructed so that the volumetric flow rate in each can be accurately determined by the test methods specified in §63.805 (c)(2) and (3). Volumetric flow rates shall be calculated without the adjustment normally made for moisture content; and

(B) Determine FV by the following equation:

$$FV = \frac{\sum_{j=1}^n Q_{out j} - \sum_{i=1}^p Q_{in i}}{\sum_{k=1}^q A_k} \quad (\text{Equation 7})$$

(iv) All access doors and windows whose areas are not included as natural draft openings and are not included in the calculation of FV shall be closed during routine operation of the process.

(2) Determine the control device efficiency using Equation (5), and the test methods and procedures specified in §63.805 (c)(1) through (6).

(3) For each affected source complying with §63.802(a)(1) in accordance with §63.804(a)(3), compliance is demonstrated if:

(i) The installation of a permanent total enclosure is demonstrated (N=1);

(ii) The value of F is determined from Equation (5); and

(iii) The product of (F×N)(100) yields a value (R) such that the value of E_{ac} in Equation 2 is no greater than 1.0.

(4) For each new affected source complying with §63.802(b)(1) in accordance with §63.804(d)(3), compliance is demonstrated if:

(i) The installation of a permanent total enclosure is demonstrated (N = 1);

(ii) The value of F is determined from Equation (5); and

(iii) The product of (F×N)(100) yields a value (R) such that the value of E_{ac} in Equation 4 is no greater than 0.8.

(5) For each affected source complying with §63.802(a)(2)(ii) in accordance with §63.804(c)(2), compliance is demonstrated if:

(i) The installation of a permanent total enclosure is demonstrated (N=1);

(ii) The value of F is determined from Equation (5); and

(iii) The product of (F×N)(100) yields a value (R) such that the value of G_{ac} in Equation 3 is no greater than 1.0.

(6) For each new affected source complying with §63.802(b)(2) in accordance with §63.804(e)(2), compliance is demonstrated if:

(i) The installation of a permanent total enclosure is demonstrated (N=1);

(ii) The value of F is determined from Equation (5); and

(iii) The product of $(F \times N)(100)$ yields a value (R) such that the value of G_{ac} in Equation 3 is no greater than 0.2.

§ 63.806 Recordkeeping requirements.

(a) The owner or operator of an affected source subject to this subpart shall fulfill all recordkeeping requirements of §63.10 of subpart A, according to the applicability criteria in §63.800(d) of this subpart.

(b) The owner or operator of an affected source subject to the emission limits in §63.802 of this subpart shall maintain records of the following:

(1) A certified product data sheet for each finishing material, thinner, contact adhesive, and strippable spray booth coating subject to the emission limits in §63.802; and

(2) The VHAP content, in kg VHAP/kg solids (lb VHAP/lb solids), as applied, of each finishing material and contact adhesive subject to the emission limits in §63.802; and

(3) The VOC content, in kg VOC/kg solids (lb VOC/lb solids), as applied, of each strippable booth coating subject to the emission limits in §63.802 (a)(3) or (b)(3).

(c) The owner or operator of an affected source following the compliance method in §63.804 (a)(1) or (d) (1) shall maintain copies of the averaging calculation for each month following the compliance date, as well as the data on the quantity of coatings and thinners used that is necessary to support the calculation of E in Equation 1.

(d) The owner or operator of an affected source following the compliance procedures of §63.804 (f)(3)(ii) and (g)(3)(ii) shall maintain the records required by §63.806(b) as well as records of the following:

(1) Solvent and coating additions to the continuous coater reservoir;

(2) Viscosity measurements; and

(3) Data demonstrating that viscosity is an appropriate parameter for demonstrating compliance.

(e) The owner or operator of an affected source subject to the work practice standards in §63.803 of this subpart shall maintain onsite the work practice implementation plan and all records associated with fulfilling the requirements of that plan, including, but not limited to:

(1) Records demonstrating that the operator training program required by §63.803(b) is in place;

(2) Records collected in accordance with the inspection and maintenance plan required by §63.803(c);

(3) Records associated with the cleaning solvent accounting system required by §63.803(d);

(4) Records associated with the limitation on the use of conventional air spray guns showing total finishing material usage and the percentage of finishing materials applied with conventional air spray guns for each semiannual period as required by §63.803(h)(5).

(5) Records associated with the formulation assessment plan required by §63.803(l); and

(6) Copies of documentation such as logs developed to demonstrate that the other provisions of the work practice implementation plan are followed.

(f) The owner or operator of an affected source following the compliance method of §63.804 (f)(4) or (g) (4) shall maintain copies of the calculations demonstrating that the overall control efficiency (R) of the control system results in the value of E_{ac} required by Equations 2 or 4, records of the operating parameter values, and copies of the semiannual compliance reports required by §63.807(d).

(g) The owner or operator of an affected source following the compliance method of §63.804 (f)(6) or (g) (6), shall maintain copies of the calculations demonstrating that the overall control efficiency (R) of the control system results in the applicable value of G_{ac} calculated using Equation 3, records of the operating parameter values, and copies of the semiannual compliance reports required by §63.807(d).

(h) The owner or operator of an affected source subject to the emission limits in §63.802 and following the compliance provisions of §63.804(f) (1), (2), (3), (5), (7) and (8) and §63.804(g) (1), (2), (3), (5), (7), and (8) shall maintain records of the compliance certifications submitted in accordance with §63.807(c) for each semiannual period following the compliance date.

(i) The owner or operator of an affected source shall maintain records of all other information submitted with the compliance status report required by §63.9(h) and §63.807(b) and the semiannual reports required by §63.807(c).

(j) The owner or operator of an affected source shall maintain all records in accordance with the requirements of §63.10(b)(1).

§ 63.807 Reporting requirements.

(a) The owner or operator of an affected source subject to this subpart shall fulfill all reporting requirements of §63.7 through §63.10 of subpart A (General Provisions) according to the applicability criteria in §63.800(d) of this subpart.

(b) The owner or operator of an affected source demonstrating compliance in accordance with §63.804 (f) (1), (2), (3), (5), (7) and (8) shall submit the compliance status report required by §63.9(h) of subpart A (General Provisions) no later than 60 days after the compliance date. The report shall include the information required by §63.804(f) (1), (2), (3), (5), (7), and (8) of this subpart.

(c) The owner or operator of an affected source demonstrating compliance in accordance with §63.804 (g) (1), (2), (3), (5), (7), and (8) shall submit a report covering the previous 6 months of wood furniture manufacturing operations:

(1) The first report shall be submitted 30 calendar days after the end of the first 6-month period following the compliance date.

(2) Subsequent reports shall be submitted 30 calendar days after the end of each 6-month period following the first report.

(3) The semiannual reports shall include the information required by §63.804(g) (1), (2), (3), (5), (7), and (8), a statement of whether the affected source was in compliance or noncompliance, and, if the affected source was in noncompliance, the measures taken to bring the affected source into compliance.

(4) The frequency of the reports required by paragraph (c) of this section shall not be reduced from semiannually regardless of the history of the owner's or operator's compliance status.

(d) The owner or operator of an affected source demonstrating compliance in accordance with §63.804 (g) (4) and (6) of this subpart shall submit the excess emissions and continuous monitoring system performance report and summary report required by §63.10(e) of subpart A. The report shall include the monitored operating parameter values required by §63.804(g) (4) and (6). If the source experiences excess emissions, the report shall be submitted quarterly for at least 1 year after the excess emissions occur and until a request to reduce reporting frequency is approved, as indicated in §63.10(e)(3)(C). If no excess emissions occur, the report shall be submitted semiannually.

(e) The owner or operator of an affected source required to provide a written notification under §63.803 (1)(4) shall include in the notification one or more statements that explains the reasons for the usage increase. The notification shall be submitted no later than 30 calendar days after the end of the annual period in which the usage increase occurred.

§ 63.808 Implementation and enforcement.

(a) This subpart can be implemented and enforced by the U.S. EPA, or a delegated authority such as the applicable State, local, or Tribal agency. If the U.S. EPA Administrator has delegated authority to a State, local, or Tribal agency, then that agency, in addition to the U.S. EPA, has the authority to implement and enforce this subpart. Contact the applicable U.S. EPA Regional Office to find out if implementation and enforcement of this subpart is delegated to a State, local, or Tribal agency.

(b) In delegating implementation and enforcement authority of this subpart to a State, local, or Tribal agency under subpart E of this part, the authorities contained in paragraph (c) of this section are retained by the Administrator of U.S. EPA and cannot be transferred to the State, local, or Tribal agency.

(c) The authorities that cannot be delegated to State, local, or Tribal agencies are as specified in paragraphs (c)(1) through (5) of this section.

(1) Approval of alternatives to the requirements in §§63.800, 63.802, and 63.803(a)(1), (b), (c) introductory text, and (d) through (l).

(2) Approval of alternatives to the monitoring and compliance requirements in §§63.804(f)(4)(iv)(D) and (E), 63.804(g)(4)(iii)(C), 63.804(g)(4)(vi), and 63.804(g)(6)(vi).

(3) Approval of major alternatives to test methods under §63.7(e)(2)(ii) and (f), as defined in §63.90, and as required in this subpart, as well as approval of any alternatives to the specific test methods under §§63.805(a), 63.805(d)(2)(v), and 63.805(e)(1).

(4) Approval of major alternatives to monitoring under §63.8(f), as defined in §63.90, and as required in this subpart.

(5) Approval of major alternatives to recordkeeping and reporting under §63.10(f), as defined in §63.90, and as required in this subpart.

[68 FR 37354, June 23, 2003]

§§ 63.809-63.819 [Reserved]

Table 1 to Subpart JJ of Part 63—General Provisions Applicability to Subpart JJ

Reference	Applies to subpart JJ	Comment
63.1(a)	Yes	
63.1(b)(1)	No	Subpart JJ specifies applicability.
63.1(b)(2)	Yes	
63.1(b)(3)	Yes	
63.1(c)(1)	No	Subpart JJ specifies applicability.
63.1(c)(2)	No	Area sources are not subject to subpart JJ.
63.1(c)(4)	Yes	
63.1(c)(5)	Yes	
63.1(e)	Yes	
63.2	Yes	Additional terms are defined in 63.801(a) of subpart JJ. When overlap between subparts A and JJ occurs, subpart JJ takes precedence.
63.3	Yes	Other units used in subpart JJ are defined in 63.801(b).

63.4	Yes	
63.5	Yes	
63.6(a)	Yes	
63.6(b)(1)	Yes	
63.6(b)(2)	Yes	
63.6(b)(3)	Yes	
63.6(b)(4)	No	May apply when standards are proposed under Section 112(f) of the CAA.
63.6(b)(5)	Yes	
63.6(b)(7)	Yes	
63.6(c)(1)	Yes	
63.6(c)(2)	No	
63.6(c)(5)	Yes	
63.6(e)(1)	Yes	
63.6(e)(2)	Yes	
63.6(e)(3)	Yes	Applies only to affected sources using a control device to comply with the rule.
63.6(f)(1)	No	Affected sources complying through the procedures specified in 63.804 (a)(1), (a)(2), (b), (c)(1), (d)(1), (d)(2), (e)(1), and (e)(2) are subject to the emission standards at all times, including periods of startup, shutdown, and malfunction.
63.6(f)(2)	Yes	
63.6(f)(3)	Yes	
63.6(g)	Yes	
63.6(h)	No	
63.6 (i)(1)–(i)(3)	Yes	
63.6(i)(4)(i)	Yes	
63.6(i)(4)(ii)	No	
63.6 (i)(5)–(i)(14)	Yes	
63.6(i)(16)	Yes	
63.6(j)	Yes	
63.7	Yes	Applies only to affected sources using a control device to comply with the rule.
63.8	Yes	Applies only to affected sources using a control device to comply with the rule.
63.9(a)	Yes	
63.9(b)	Yes	Existing sources are required to submit initial notification report within 270 days of the effective date.
63.9(c)	Yes	

63.9(d)	Yes	
63.9(e)	Yes	Applies only to affected sources using a control device to comply with the rule.
63.9(f)	No	
63.9(g)	Yes	Applies only to affected sources using a control device to comply with the rule.
63.9(h)	Yes	63.9(h)(2)(ii) applies only to affected sources using a control device to comply with the rule.
63.9(i)	Yes	
63.9(j)	Yes	
63.10(a)	Yes	
63.10(b)(1)	Yes	
63.10(b)(2)	Yes	Applies only to affected sources using a control device to comply with the rule.
63.10(b)(3)	Yes	
63.10(c)	Yes	
63.10(d)(1)	Yes	
63.10(d)(2)	Yes	Applies only to affected sources using a control device to comply with the rule.
63.10(d)(3)	No	
63.10(d)(4)	Yes	
63.10(d)(5)	Yes	Applies only to affected sources using a control device to comply with the rule.
63.10(e)	Yes	Applies only to affected sources using a control device to comply with the rule.
63.10(f)	Yes	
63.11	No	
63.12– 63.15	Yes	

Table 2 to Subpart JJ of Part 63—List of Volatile Hazardous Air Pollutants

Chemical name	CAS No.
Acetaldehyde	75070
Acetamide	60355
Acetonitrile	75058
Acetophenone	98862
2-Acetylaminofluorine	53963
Acrolein	107028
Acrylamide	79061
Acrylic acid	79107
Acrylonitrile	107131

Allyl chloride	107051
4-Aminobiphenyl	92671
Aniline	62533
o-Anisidine	90040
Benzene	71432
Benzidine	92875
Benzotrichloride	98077
Benzyl chloride	100447
Biphenyl	92524
Bis (2-ethylhexyl) phthalate (DEHP)	117817
Bis (chloromethyl) ether	542881
Bromoform	75252
1,3-Butadiene	106990
Carbon disulfide	75150
Carbon tetrachloride	56235
Carbonyl sulfide	463581
Catechol	120809
Chloroacetic acid	79118
2-Chloroacetophenone	532274
Chlorobenzene	108907
Chloroform	67663
Chloromethyl methyl ether	107302
Chloroprene	126998
Cresols (isomers and mixture)	1319773
o-Cresol	95487
m-Cresol	108394
p-Cresol	106445
Cumene	98828
2,4-D (2,4-Dichlorophenoxyacetic acid, including salts and esters)	94757
DDE (1,1-Dichloro-2,2-bis(p-chlorophenyl)ethylene)	72559
Diazomethane	334883
Dibenzofuran	132649
1,2-Dibromo-3-chloropropane	96128
Dibutylphthalate	84742
1,4-Dichlorobenzene	106467
3,3'-Dichlorobenzidine	91941
Dichloroethyl ether (Bis(2-chloroethyl)ether)	111444
1,3-Dichloropropene	542756
Diethanolamine	111422
N,N-Dimethylaniline	121697

Methyl chloride (Chloromethane)	74873
Methyl chloroform (1,1,1-Trichloroethane)	71556
Methyl ethyl ketone (2-Butanone)	78933
Methylhydrazine	60344
Methyl iodide (Iodomethane)	74884
Methyl isobutyl ketone (Hexone)	108101
Methyl isocyanate	624839
Methyl methacrylate	80626
Methyl tert-butyl ether	1634044
4,4'-Methylenebis (2-chloroaniline)	101144
Methylene chloride (Dichloromethane)	75092
4,4'-Methylenediphenyl diisocyanate (MDI)	101688
4,4'-Methylenedianiline	101779
Naphthalene	91203
Nitrobenzene	98953
4-Nitrobiphenyl	92933
4-Nitrophenol	100027
2-Nitropropane	79469
N-Nitroso-N-methylurea	684935
N-Nitrosodimethylamine	62759
N-Nitrosomorpholine	59892
Phenol	108952
p-Phenylenediamine	106503
Phosgene	75445
Phthalic anhydride	85449
Polychlorinated biphenyls (Aroclors)	1336363
Polycyclic Organic Matter ^b	
1,3-Propane sultone	1120714
beta-Propiolactone	57578
Propionaldehyde	123386
Propoxur (Baygon)	114261
Propylene dichloride (1,2-Dichloropropane)	78875
Propylene oxide	75569
1,2-Propylenimine (2-Methyl aziridine)	75558
Quinone	106514
Styrene	100425
Styrene oxide	96093
2,3,7,8-Tetrachlorodibenzo-p-dioxin	1746016
1,1,2,2-Tetrachloroethane	79345
Tetrachloroethylene (Perchloroethylene)	127184

Toluene	108883
2,4-Toluenediamine	95807
Toluene-2,4-diisocyanate	584849
o-Toluidine	95534
1,2,4-Trichlorobenzene	120821
1,1,2-Trichloroethane	79005
Trichloroethylene	79016
2,4,5-Trichlorophenol	95954
2,4,6-Trichlorophenol	88062
Triethylamine	121448
Trifluralin	1582098
2,2,4-Trimethylpentane	540841
Vinyl acetate	108054
Vinyl bromide	593602
Vinyl chloride	75014
Vinylidene chloride (1,1-Dichloroethylene)	75354
Xylenes (isomers and mixture)	1330207
o-Xylene	95476
m-Xylene	108383
p-Xylene	106423

^aIncludes mono- and di-ethers of ethylene glycol, diethylene glycols and triethylene glycol; R-(OCH₂CH₂)_n RR-OR where:

n = 1, 2, or 3,

R = alkyl or aryl groups

R' = R, H, or groups which, when removed, yield glycol ethers with the structure: R-(OCH₂CH₂)_n-OH. Polymers are excluded from the glycol category.

^bIncludes organic compounds with more than one benzene ring, and which have a boiling point greater than or equal to 100°C.

[63 FR 71381, Dec. 28, 1998]

Table 3 to Subpart JJ of Part 63—Summary of Emission Limits

Emission point	Existing source	New source
Finishing Operations:		
(a) Achieve a weighted average VHAP content across all coatings (maximum kg VHAP/kg solids [lb VHAP/lb solids], as applied	^a 1.0	^a 0.8
(b) Use compliant finishing materials (maximum kg		

VHAP/kg solids [lb VHAP/lb solids], as applied):		
—stains	^a 1.0	^a 1.0
—washcoats	^{a,b} 1.0	^{a,b} 0.8
—sealers	^a 1.0	^a 0.8
—topcoats	^a 1.0	^a 0.8
—basecoats	^{a,b} 1.0	^{a,b} 0.8
—enamels	^{a,b} 1.0	^{a,b} 0.8
—thinners (maximum percent VHAP allowable); or	10.0	10.0
(c) As an alternative, use control device; or	^c 1.0	^c 0.8
(d) Use any combination of (a), (b), and (c)	1.0	0.8
Cleaning Operations:		
Strippable spray booth material (maximum VOC content, kg VOC/kg solids [lb VOC/lb solids])	0.8	0.8
Contact Adhesives:		
(a) Use compliant contact adhesives (maximum kg VHAP/kg solids [lb VHAP/lb solids], as applied) based on following criteria:		
i. For aerosol adhesives, and for contact adhesives applied to nonporous substrates	^d NA	^d NA
ii. For foam adhesives used in products that meet flammability requirements	1.8	0.2
iii. For all other contact adhesives (including foam adhesives used in products that do not meet flammability requirements); or	1.0	0.2
(b) Use a control device	^e 1.0	^e 0.2

^aThe limits refer to the VHAP content of the coating, as applied.

^bWashcoats, basecoats, and enamels must comply with the limits presented in this table if they are purchased premade, that is, if they are not formulated onsite by thinning other finishing materials. If they are formulated onsite, they must be formulated using compliant finishing materials, i.e., those that meet the limits specified in this table, and thinners containing no more than 3.0 percent VHAP by weight.

^cThe control device must operate at an efficiency that is equivalent to no greater than 1.0 kilogram (or 0.8 kilogram) of VHAP being emitted from the affected emission source per kilogram of solids used.

^dThere is no limit on the VHAP content of these adhesives.

^eThe control device must operate at an efficiency that is equivalent to no greater than 1.0 kilogram (or 0.2 kilogram) of VHAP being emitted from the affected emission source per kilogram of solids used.

[60 FR 62936, Dec. 7, 1995, as amended at 62 FR 30260, June 3, 1997]

Table 4 to Subpart JJ of Part 63—Pollutants Excluded From Use in Cleaning and Washoff Solvents

Chemical name	CAS No.
4-Aminobiphenyl	92671
Styrene oxide	96093
Diethyl sulfate	64675
N-Nitrosomorpholine	59892
Dimethyl formamide	68122
Hexamethylphosphoramide	680319
Acetamide	60355
4,4'-Methylenedianiline	101779
o-Anisidine	90040
2,3,7,8-Tetrachlorodibenzo-p-dioxin	1746016
Beryllium salts	
Benzidine	92875
N-Nitroso-N-methylurea	684935
Bis (chloromethyl) ether	542881
Dimethyl carbamoyl chloride	79447
Chromium compounds (hexavalent)	
1,2-Propylenimine (2-Methyl aziridine)	75558
Arsenic and inorganic arsenic compounds	99999904
Hydrazine	302012
1,1-Dimethyl hydrazine	57147
Beryllium compounds	7440417
1,2-Dibromo-3-chloropropane	96128
N-Nitrosodimethylamine	62759
Cadmium compounds	
Benzo (a) pyrene	50328
Polychlorinated biphenyls (Aroclors)	1336363
Heptachlor	76448
3,3'-Dimethyl benzidine	119937
Nickel subsulfide	12035722
Acrylamide	79061
Hexachlorobenzene	118741
Chlordane	57749
1,3-Propane sultone	1120714
1,3-Butadiene	106990
Nickel refinery dust	
2-Acetylaminoflourine	53963
3,3'-Dichlorobenzidine	53963

Lindane (hexachlorcyclohexane, gamma)	58899
2,4-Toluene diamine	95807
Dichloroethyl ether (Bis(2-chloroethyl) ether)	111444
1,2-Diphenylhydrazine	122667
Toxaphene (chlorinated camphene)	8001352
2,4-Dinitrotoluene	121142
3,3'-Dimethoxybenzidine	119904
Formaldehyde	50000
4,4'-Methylene bis (2-chloroaniline)	101144
Acrylonitrile	107131
Ethylene dibromide (1,2-Dibromoethane)	106934
DDE (1,1-p-chlorophenyl 1-2 dichloroethylene)	72559
Chlorobenzilate	510156
Dichlorvos	62737
Vinyl chloride	75014
Coke Oven Emissions	
Ethylene oxide	75218
Ethylene thiourea	96457
Vinyl bromide (bromoethene)	593602
Selenium sulfide (mono and di)	7488564
Chloroform	67663
Pentachlorophenol	87865
Ethyl carbamate (Urethane)	51796
Ethylene dichloride (1,2-Dichloroethane)	107062
Propylene dichloride (1,2-Dichloropropane)	78875
Carbon tetrachloride	56235
Benzene	71432
Methyl hydrazine	60344
Ethyl acrylate	140885
Propylene oxide	75569
Aniline	62533
1,4-Dichlorobenzene(p)	106467
2,4,6-Trichlorophenol	88062
Bis (2-ethylhexyl) phthalate (DEHP)	117817
o-Toluidine	95534
Propoxur	114261
1,4-Dioxane (1,4-Diethyleneoxide)	123911
Acetaldehyde	75070
Bromoform	75252
Captan	133062

Epichlorohydrin	106898
Methylene chloride (Dichloromethane)	75092
Dibenz (ah) anthracene	53703
Chrysene	218019
Dimethyl aminoazobenzene	60117
Benzo (a) anthracene	56553
Benzo (b) fluoranthene	205992
Antimony trioxide	1309644
2-Nitropropane	79469
1,3-Dichloropropene	542756
7, 12-Dimethylbenz(a) anthracene	57976
Benz(c) acridine	225514
Indeno(1,2,3-cd)pyrene	193395
1,2:7,8-Dibenzopyrene	189559

[63 FR 71382, Dec. 28, 1998]

Table 5 to Subpart JJ of Part 63—List of VHAP of Potential Concern Identified by Industry

CAS No.	Chemical name	EPA de minimis, tons/yr
68122	Dimethyl formamide	1.0
50000	Formaldehyde	0.2
75092	Methylene chloride	4.0
79469	2-Nitropropane	1.0
78591	Isophorone	0.7
1000425	Styrene monomer	1.0
108952	Phenol	0.1
111422	Dimethanolamine	5.0
109864	2-Methoxyethanol	10.0
111159	2-Ethoxyethyl acetate	10.0

[63 FR 71382, Dec. 28, 1998]

Table 6 to Subpart JJ of Part 63—VHAP of Potential Concern

CAS No.	Chemical name	EPA de minimis, tons/yr*
92671	4-Aminobiphenyl	1.0
96093	Styrene oxide	1.0
64675	Diethyl sulfate	1.0
59892	N-Nitrosomorpholine	1.0
68122	Dimethyl formamide	1.0

680319	Hexamethylphosphoramide	0.01
60355	Acetamide	1.0
101779	4,4'-Methylenedianiline	1.0
90040	o-Anisidine	1.0
1746016	2,3,7,8-Tetrachlorodibenzo-p-dioxin	0.00000006
92875	Benzidine	0.00003
684935	N-Nitroso-N-methylurea	0.00002
542881	Bis(chloromethyl) ether	0.00003
79447	Dimethyl carbamoyl chloride	0.002
75558	1,2-Propylenimine (2-Methyl aziridine)	0.0003
57147	1,1-Dimethyl hydrazine	0.0008
96128	1,2-Dibromo-3-chloropropane	0.001
62759	N-Nitrosodimethylamine	0.0001
50328	Benzo (a) pyrene	0.001
1336363	Polychlorinated biphenyls (Aroclors)	0.0009
76448	Heptachlor	0.002
119937	3,3'-Dimethyl benzidine	0.001
79061	Acrylamide	0.002
118741	Hexachlorobenzene	0.004
57749	Chlordane	0.005
1120714	1,3-Propane sultone	0.003
106990	1,3-Butadiene	0.007
53963	2-Acetylaminoflourine	0.0005
91941	3,3'-Dichlorobenzidine	0.02
58899	Lindane (hexachlorocyclohexane, gamma)	0.005
95807	2,4-Toluene diamine	0.002
111444	Dichloroethyl ether (Bis(2-chloroethyl) ether)	0.006
122667	1,2—Diphenylhydrazine	0.009
8001352	Toxaphene (chlorinated camphene)	0.006
121142	2,4-Dinitrotoluene	0.002
119904	3,3'-Dimethoxybenzidine	0.01
50000	Formaldehyde	0.2
101144	4,4'-Methylene bis(2-chloroaniline)	0.02
107131	Acrylonitrile	0.03
106934	Ethylene dibromide(1,2-Dibromoethane)	0.01
72559	DDE (1,1-p-chlorophenyl 1-2 dichloroethylene)	0.01
510156	Chlorobenzilate	0.04
62737	Dichlorvos	0.02
75014	Vinyl chloride	0.02

75218	Ethylene oxide	0.09
96457	Ethylene thiourea	0.06
593602	Vinyl bromide (bromoethene)	0.06
67663	Chloroform	0.09
87865	Pentachlorophenol	0.07
51796	Ethyl carbamate (Urethane)	0.08
107062	Ethylene dichloride (1,2-Dichloroethane)	0.08
78875	Propylene dichloride (1,2-Dichloropropane)	0.1
56235	Carbon tetrachloride	0.1
71432	Benzene	0.2
140885	Ethyl acrylate	0.1
75569	Propylene oxide	0.5
62533	Aniline	0.1
106467	1,4-Dichlorobenzene(p)	0.3
88062	2,4,6-Trichlorophenol	0.6
117817	Bis (2-ethylhexyl) phthalate (DEHP)	0.5
95534	o-Toluidine	0.4
114261	Propoxur	2.0
79016	Trichloroethylene	1.0
123911	1,4-Dioxane (1,4-Diethyleneoxide)	0.6
75070	Acetaldehyde	0.9
75252	Bromoform	2.0
133062	Captan	2.0
106898	Epichlorohydrin	2.0
75092	Methylene chloride (Dichloromethane)	4.0
127184	Tetrachloroethylene (Perchloroethylene)	4.0
53703	Dibenz (ah) anthracene	0.01
218019	Chrysene	0.01
60117	Dimethyl aminoazobenzene	1.0
56553	Benzo (a) anthracene	0.01
205992	Benzo (b) fluoranthene	0.01
79469	2-Nitropropane	1.0
542756	1,3-Dichloropropene	1.0
57976	7,12-Dimethylbenz (a) anthracene	0.01
225514	Benz(c)acridine	0.01
193395	Indeno(1,2,3-cd)pyrene	0.01
189559	1,2:7,8-Dibenzopyrene	0.01
79345	1,1,2,2-Tetrachloroethane	0.03
91225	Quinoline	0.0006
75354	Vinylidene chloride (1,1-Dichloroethylene)	0.04

87683	Hexachlorobutadiene	0.09
82688	Pentachloronitrobenzene (Quintobenzene)	0.03
78591	Isophorone	0.7
79005	1,1,2-Trichloroethane	0.1
74873	Methyl chloride (Chloromethane)	1.0
67721	Hexachloroethane	0.5
1582098	Trifluralin	0.9
1319773	Cresols/Cresylic acid (isomers and mixture)	1.0
108394	m-Cresol	1.0
75343	Ethylidene dichloride (1,1-Dichloroethane)	1.0
95487	o-Cresol	1.0
106445	p-Cresol	1.0
74884	Methyl iodide (Iodomethane)	1.0
100425	Styrene	1.0
107051	Allyl chloride	1.0
334883	Diazomethane	1.0
95954	2,4,5—Trichlorophenol	1.0
133904	Chloramben	1.0
106887	1,2—Epoxybutane	1.0
108054	Vinyl acetate	1.0
126998	Chloroprene	1.0
123319	Hydroquinone	1.0
92933	4-Nitrobiphenyl	1.0
56382	Parathion	0.1
13463393	Nickel Carbonyl	0.1
60344	Methyl hydrazine	0.006
151564	Ethylene imine	0.0003
77781	Dimethyl sulfate	0.1
107302	Chloromethyl methyl ether	0.1
57578	beta-Propiolactone	0.1
100447	Benzyl chloride	0.04
98077	Benzotrichloride	0.0006
107028	Acrolein	0.04
584849	2,4—Toluene diisocyanate	0.1
75741	Tetramethyl lead	0.01
78002	Tetraethyl lead	0.01
12108133	Methylcyclopentadienyl manganese	0.1
624839	Methyl isocyanate	0.1
77474	Hexachlorocyclopentadiene	0.1
62207765	Fluomine	0.1

10210681	Cobalt carbonyl	0.1
79118	Chloroacetic acid	0.1
534521	4,6-Dinitro-o-cresol, and salts	0.1
101688	Methylene diphenyl diisocyanate	0.1
108952	Phenol	0.1
62384	Mercury, (acetato-o) phenyl	0.01
98862	Acetophenone	1.0
108316	Maleic anhydride	1.0
532274	2-Chloroacetophenone	0.06
51285	2,4-Dinitrophenol	1.0
109864	2-Methoxy ethanol	10.0
98953	Nitrobenzene	1.0
74839	Methyl bromide (Bromomethane)	10.0
75150	Carbon disulfide	1.0
121697	N,N-Dimethylaniline	1.0
106514	Quinone	5.0
123386	Propionaldehyde	5.0
120809	Catechol	5.0
85449	Phthalic anhydride	5.0
463581	Carbonyl sulfide	5.0
132649	Dibenzofurans	5.0
100027	4-Nitrophenol	5.0
540841	2,2,4-Trimethylpentane	5.0
111422	Diethanolamine	5.0
822060	Hexamethylene-1,6-diisocyanate	5.0
	Glycol ethers ^a	5.0
	Polycyclic organic matter ^b	0.01

*These values are based on the de minimis levels provided in the proposed rulemaking pursuant to section 112(g) of the Act using a 70-year lifetime exposure duration for all VHAP. Default assumptions and the de minimis values based on inhalation reference doses (RfC) are not changed by this adjustment.

^aExcept for ethylene glycol butyl ether, ethylene glycol ethyl ether (2-ethoxy ethanol), ethylene glycol hexyl ether, ethylene glycol methyl ether (2-methoxyethanol), ethylene glycol phenyl ether, ethylene glycol propyl ether, ethylene glycol mono-2-ethylhexyl ether, diethylene glycol butyl ether, diethylene glycol ethyl ether, diethylene glycol methyl ether, diethylene glycol hexyl ether, diethylene glycol phenyl ether, diethylene glycol propyl ether, triethylene glycol butyl ether, triethylene glycol ethyl ether, triethylene glycol methyl ether, triethylene glycol propyl ether, ethylene glycol butyl ether acetate, ethylene glycol ethyl ether acetate, and diethylene glycol ethyl ether acetate.

^bExcept for benzo(b)fluoranthene, benzo(a)anthracene, benzo(a)pyrene, 7,12-dimethylbenz(a)anthracene, benz(c)acridine, chrysene, dibenz(ah)anthracene, 1,2:7,8-dibenzopyrene, indeno(1,2,3-cd)pyrene, but including dioxins and furans.

[63 FR 71383, Dec. 28, 1998]

[Browse Previous](#) | [Browse Next](#)

For questions or comments regarding e-CFR editorial content, features, or design, email ecfr@nara.gov.

For questions concerning e-CFR programming and delivery issues, email webteam@gpo.gov.

[Section 508 / Accessibility](#)

[Home Page](#) > [Executive Branch](#) > [Code of Federal Regulations](#) > [Electronic Code of Federal Regulations](#)

Electronic Code of Federal Regulations

e-CFR

TM

e-CFR Data is current as of August 1, 2007

Title 40: Protection of Environment

PART 63—NATIONAL EMISSION STANDARDS FOR HAZARDOUS AIR POLLUTANTS FOR SOURCE CATEGORIES

[Browse Previous](#) | [Browse Next](#)

Subpart EEEE—National Emission Standards for Hazardous Air Pollutants: Organic Liquids Distribution (Non-Gasoline)

Source: 69 FR 5063, Feb. 3, 2004, unless otherwise noted.

What This Subpart Covers

§ 63.2330 What is the purpose of this subpart?

This subpart establishes national emission limitations, operating limits, and work practice standards for organic hazardous air pollutants (HAP) emitted from organic liquids distribution (OLD) (non-gasoline) operations at major sources of HAP emissions. This subpart also establishes requirements to demonstrate initial and continuous compliance with the emission limitations, operating limits, and work practice standards.

§ 63.2334 Am I subject to this subpart?

(a) Except as provided for in paragraphs (b) and (c) of this section, you are subject to this subpart if you own or operate an OLD operation that is located at, or is part of, a major source of HAP emissions. An OLD operation may occupy an entire plant site or be collocated with other industrial (e.g., manufacturing) operations at the same plant site.

(b) Organic liquid distribution operations located at research and development facilities, consistent with section 112(c)(7) of the Clean Air Act (CAA), are not subject to this subpart.

(c) Organic liquid distribution operations do not include the activities and equipment, including product loading racks, used to process, store, or transfer organic liquids at facilities listed in paragraph (c) (1) and (2) of this section.

(1) Oil and natural gas production field facilities, as the term "facility" is defined in §63.761 of subpart HH.

(2) Natural gas transmission and storage facilities, as the term "facility" is defined in §63.1271 of subpart HHH.

§ 63.2338 What parts of my plant does this subpart cover?

(a) This subpart applies to each new, reconstructed, or existing OLD operation affected source.

(b) Except as provided in paragraph (c) of this section, the affected source is the collection of activities and equipment used to distribute organic liquids into, out of, or within a facility that is a major source of HAP. The affected source is composed of:

(1) All storage tanks storing organic liquids.

(2) All transfer racks at which organic liquids are loaded into or unloaded out of transport vehicles and/or containers.

(3) All equipment leak components in organic liquids service that are associated with:

(i) Storage tanks storing organic liquids;

(ii) Transfer racks loading or unloading organic liquids;

(iii) Pipelines that transfer organic liquids directly between two storage tanks that are subject to this subpart;

(iv) Pipelines that transfer organic liquids directly between a storage tank subject to this subpart and a transfer rack subject to this subpart; and

(v) Pipelines that transfer organic liquids directly between two transfer racks that are subject to this subpart.

(4) All transport vehicles while they are loading or unloading organic liquids at transfer racks subject to this subpart.

(5) All containers while they are loading or unloading organic liquids at transfer racks subject to this subpart.

(c) The equipment listed in paragraphs (c)(1) through (4) of this section and used in the identified operations is excluded from the affected source.

(1) Storage tanks, transfer racks, transport vehicles, containers, and equipment leak components that are part of an affected source under another 40 CFR part 63 national emission standards for hazardous air pollutants (NESHAP).

(2) Non-permanent storage tanks, transfer racks, transport vehicles, containers, and equipment leak components when used in special situation distribution loading and unloading operations (such as maintenance or upset liquids management).

(3) Storage tanks, transfer racks, transport vehicles, containers, and equipment leak components when used to conduct maintenance activities, such as stormwater management, liquid removal from tanks for inspections and maintenance, or changeovers to a different liquid stored in a storage tank.

(d) An affected source is a new affected source if you commenced construction of the affected source after April 2, 2002, and you meet the applicability criteria in §63.2334 at the time you commenced operation.

(e) An affected source is reconstructed if you meet the criteria for reconstruction as defined in §63.2.

(f) An affected source is existing if it is not new or reconstructed.

[69 FR 5063, Feb. 3, 2004, as amended at 71 FR 42904, July 28, 2006]

§ 63.2342 When do I have to comply with this subpart?

(a) If you have a new or reconstructed affected source, you must comply with this subpart according to

the schedule identified in paragraph (a)(1), (a)(2), or (a)(3) of this section, as applicable.

(1)(i) Except as provided in paragraph (a)(1)(ii) of this section, if you startup your new affected source on or before February 3, 2004 or if you reconstruct your affected source on or before February 3, 2004, you must comply with the emission limitations, operating limits, and work practice standards for new and reconstructed sources in this subpart no later than February 3, 2004.

(ii) For any emission source listed in paragraph §63.2338(b) at an affected source that commenced construction or reconstruction after April 2, 2002, but before February 3, 2004, that is required to be controlled based on the applicability criteria in this subpart, but:

(A) Would not have been required to be controlled based on the applicability criteria as proposed for this subpart, you must comply with the emission limitations, operating limits, and work practice standards for each such emission source based on the schedule found in paragraph (b) of this section or at startup, whichever is later; or

(B) Would have been subject to a less stringent degree of control requirement as proposed for this subpart, you must comply with the emission limitations, operating limits, and work practice standards in this subpart for each such emission source based on the schedule found in paragraph (b) of this section or at startup, whichever is later, and if you start up your affected new or reconstructed source before February 5, 2007, you must comply with the emission limitations, operating limits, and work practice standards for each such emission source as proposed for this subpart, until you are required to comply with the emission limitations, operating limits, and work practice standards in this subpart for each such emission source based on the schedule found in paragraph (b) of this section.

(2) If you commence construction of or reconstruct your affected source after February 3, 2004, you must comply with the emission limitations, operating limits, and work practice standards for new and reconstructed sources in this subpart upon startup of your affected source.

(3) If, after startup of a new affected source, the total actual annual facility-level organic liquid loading volume at that source exceeds the criteria for control in Table 2 to this subpart, items 9 and 10, the owner or operator must comply with the transfer rack requirements specified in §63.2346(b) immediately; that is, be in compliance the first day of the period following the end of the 3-year period triggering the control criteria.

(b)(1) If you have an existing affected source, you must comply with the emission limitations, operating limits, and work practice standards for existing affected sources no later than February 5, 2007, except as provided in paragraphs (b)(2) and (3) of this section.

(2) Floating roof storage tanks at existing affected sources must be in compliance with the work practice standards in Table 4 to this subpart, item 1, at all times after the next degassing and cleaning activity or within 10 years after February 3, 2004, whichever occurs first. If the first degassing and cleaning activity occurs during the 3 years following February 3, 2004, the compliance date is February 5, 2007.

(3)(i) If an addition or change other than reconstruction as defined in §63.2 is made to an existing affected facility that causes the total actual annual facility-level organic liquid loading volume to exceed the criteria for control in Table 2 to this subpart, items 7 and 8, the owner or operator must comply with the transfer rack requirements specified in §63.2346(b) immediately; that is, be in compliance the first day of the period following the end of the 3-year period triggering the control criteria.

(ii) If the owner or operator believes that compliance with the transfer rack emission limits cannot be achieved immediately, as specified in paragraph (b)(3)(i) of this section, the owner or operator may submit a request for a compliance extension, as specified in paragraphs (b)(3)(ii)(A) through (I) of this section. Subject to paragraph (b)(3)(ii)(B) of this section, until an extension of compliance has been granted by the Administrator (or a State with an approved permit program) under this paragraph (b)(3)(ii), the owner or operator of the transfer rack subject to the requirements of this section shall comply with all applicable requirements of this subpart. Advice on requesting an extension of compliance may be obtained from the Administrator (or the State with an approved permit program).

(A) *Submittal.* The owner or operator shall submit a request for a compliance extension to the Administrator (or a State, when the State has an approved 40 CFR part 70 permit program and the source is required to obtain a 40 CFR part 70 permit under that program, or a State, when the State has

been delegated the authority to implement and enforce the emission standard for that source) seeking an extension allowing the source up to 1 additional year to comply with the transfer rack standard, if such additional period is necessary for the installation of controls. The owner or operator of the affected source who has requested an extension of compliance under this paragraph (b)(3)(ii)(A) and who is otherwise required to obtain a title V permit shall apply for such permit, or apply to have the source's title V permit revised to incorporate the conditions of the extension of compliance. The conditions of an extension of compliance granted under this paragraph (b)(3)(ii)(A) will be incorporated into the affected source's title V permit according to the provisions of 40 CFR part 70 or Federal title V regulations in this chapter (42 U.S.C. 7661), whichever are applicable.

(B) *When to submit.* (1) Any request submitted under paragraph (b)(3)(ii)(A) of this section must be submitted in writing to the appropriate authority no later than 120 days prior to the affected source's compliance date (as specified in paragraph (b)(3)(i) of this section), except as provided for in paragraph (b)(3)(ii)(B)(2) of this section. Nonfrivolous requests submitted under this paragraph (b)(3)(ii)(B)(1) will stay the applicability of the rule as to the emission points in question until such time as the request is granted or denied. A denial will be effective as of the date of denial.

(2) An owner or operator may submit a compliance extension request after the date specified in paragraph (b)(3)(ii)(B)(1) of this section provided the need for the compliance extension arose after that date, and before the otherwise applicable compliance date and the need arose due to circumstances beyond reasonable control of the owner or operator. This request must include, in addition to the information required in paragraph (b)(3)(ii)(C) of this section, a statement of the reasons additional time is needed and the date when the owner or operator first learned of the problems. Nonfrivolous requests submitted under this paragraph (b)(3)(ii)(B)(2) will stay the applicability of the rule as to the emission points in question until such time as the request is granted or denied. A denial will be effective as of the original compliance date.

(C) *Information required.* The request for a compliance extension under paragraph (b)(3)(ii)(A) of this section shall include the following information:

(1) The name and address of the owner or operator and the address of the existing source if it differs from the address of the owner or operator;

(2) The name, address, and telephone number of a contact person for further information;

(3) An identification of the organic liquid distribution operation and of the specific equipment for which additional compliance time is required;

(4) A description of the controls to be installed to comply with the standard;

(5) Justification for the length of time being requested; and

(6) A compliance schedule, including the date by which each step toward compliance will be reached. At a minimum, the list of dates shall include:

(i) The date by which on-site construction, installation of emission control equipment, or a process change is planned to be initiated;

(ii) The date by which on-site construction, installation of emission control equipment, or a process change is to be completed; and

(iii) The date by which final compliance is to be achieved.

(D) *Approval of request for extension of compliance.* Based on the information provided in any request made under paragraph (b)(3)(ii)(C) of this section, or other information, the Administrator (or the State with an approved permit program) may grant an extension of compliance with the transfer rack emission standard, as specified in paragraph (b)(3)(ii) of this section. The extension will be in writing and will—

(1) Identify each affected source covered by the extension;

(2) Specify the termination date of the extension;

(3) Specify the dates by which steps toward compliance are to be taken, if appropriate;

(4) Specify other applicable requirements to which the compliance extension applies (e.g., performance tests);

(5) Specify the contents of the progress reports to be submitted and the dates by which such reports are to be submitted, if required pursuant to paragraph (b)(3)(ii)(E) of this section.

(6) Under paragraph (b)(3)(ii) of this section, specify any additional conditions that the Administrator (or the State) deems necessary to assure installation of the necessary controls and protection of the health of persons during the extension period.

(E) *Progress reports.* The owner or operator of an existing source that has been granted an extension of compliance under paragraph (b)(3)(ii)(D) of this section may be required to submit to the Administrator (or the State with an approved permit program) progress reports indicating whether the steps toward compliance outlined in the compliance schedule have been reached.

(F) *Notification of approval or intention to deny.*

(1) The Administrator (or the State with an approved permit program) will notify the owner or operator in writing of approval or intention to deny approval of a request for an extension of compliance within 30 calendar days after receipt of sufficient information to evaluate a request submitted under paragraph (b) (3)(ii) of this section. The Administrator (or the State) will notify the owner or operator in writing of the status of his/her application; that is, whether the application contains sufficient information to make a determination, within 30 calendar days after receipt of the original application and within 30 calendar days after receipt of any supplementary information that is submitted. The 30-day approval or denial period will begin after the owner or operator has been notified in writing that his/her application is complete. Failure by the Administrator to act within 30 calendar days to approve or disapprove a request submitted under paragraph (b)(3)(ii) of this section does not constitute automatic approval of the request.

(2) When notifying the owner or operator that his/her application is not complete, the Administrator will specify the information needed to complete the application and provide notice of opportunity for the applicant to present, in writing, within 30 calendar days after he/she is notified of the incomplete application, additional information or arguments to the Administrator to enable further action on the application.

(3) Before denying any request for an extension of compliance, the Administrator (or the State with an approved permit program) will notify the owner or operator in writing of the Administrator's (or the State's) intention to issue the denial, together with:

(i) Notice of the information and findings on which the intended denial is based; and

(ii) Notice of opportunity for the owner or operator to present in writing, within 15 calendar days after he/she is notified of the intended denial, additional information or arguments to the Administrator (or the State) before further action on the request.

(4) The Administrator's final determination to deny any request for an extension will be in writing and will set forth the specific grounds on which the denial is based. The final determination will be made within 30 calendar days after presentation of additional information or argument (if the application is complete), or within 30 calendar days after the final date specified for the presentation if no presentation is made.

(G) *Termination of extension of compliance.* The Administrator (or the State with an approved permit program) may terminate an extension of compliance at an earlier date than specified if any specification under paragraph (b)(3)(ii)(D)(3) or paragraph (b)(3)(ii)(D)(4) of this section is not met. Upon a determination to terminate, the Administrator will notify, in writing, the owner or operator of the Administrator's determination to terminate, together with:

(1) Notice of the reason for termination; and

(2) Notice of opportunity for the owner or operator to present in writing, within 15 calendar days after he/she is notified of the determination to terminate, additional information or arguments to the Administrator before further action on the termination.

(3) A final determination to terminate an extension of compliance will be in writing and will set forth the specific grounds on which the termination is based. The final determination will be made within 30 calendar days after presentation of additional information or arguments, or within 30 calendar days after the final date specified for the presentation if no presentation is made.

(H) The granting of an extension under this section shall not abrogate the Administrator's authority under section 114 of the CAA.

(I) *Limitation on use of compliance extension.* The owner or operator may request an extension of compliance under the provisions specified in paragraph (b)(3)(ii) of this section only once for each facility.

(c) If you have an area source that does not commence reconstruction but increases its emissions or its potential to emit such that it becomes a major source of HAP emissions and an existing affected source subject to this subpart, you must be in compliance by 3 years after the area source becomes a major source.

(d) You must meet the notification requirements in §§63.2343 and 63.2382(a), as applicable, according to the schedules in §63.2382(a) and (b)(1) through (3) and in subpart A of this part. Some of these notifications must be submitted before the compliance dates for the emission limitations, operating limits, and work practice standards in this subpart.

[69 FR 5063, Feb. 3, 2004, as amended at 71 FR 42905, July 28, 2006]

§ 63.2343 What are my requirements for emission sources not requiring control?

This section establishes the notification, recordkeeping, and reporting requirements for emission sources identified in §63.2338 that do not require control under this subpart (i.e., under paragraphs (a) through (e) of §63.2346). Such emission sources are not subject to any other notification, recordkeeping, or reporting sections in this subpart, including §63.2350(c), except as indicated in paragraphs (a) through (d) of this section.

(a) For each storage tank subject to this subpart having a capacity of less than 18.9 cubic meters (5,000 gallons) and for each transfer rack subject to this subpart that only unloads organic liquids (i.e., no organic liquids are loaded at any of the transfer racks), you must keep documentation that verifies that each storage tank and transfer rack identified in paragraph (a) of this section is not required to be controlled. The documentation must be kept up-to-date (i.e., all such emission sources at a facility are identified in the documentation regardless of when the documentation was last compiled) and must be in a form suitable and readily available for expeditious inspection and review according to §63.10(b)(1), including records stored in electronic form in a separate location. The documentation may consist of identification of the tanks and transfer racks identified in paragraph (a) of this section on a plant site plan or process and instrumentation diagram (P&ID).

(b) For each storage tank subject to this subpart having a capacity of 18.9 cubic meters (5,000 gallons) or more that is not subject to control based on the criteria specified in Table 2 to this subpart, items 1 through 6, you must comply with the requirements specified in paragraphs (b)(1) through (3) of this section.

(1)(i) You must submit the information in §63.2386(c)(1), (2), (3), and (10)(i) in either the Notification of Compliance Status, according to the schedule specified in Table 12 to this subpart, or in your first Compliance report, according to the schedule specified in §63.2386(b), whichever occurs first.

(ii)(A) If you submit your first Compliance report before your Notification of Compliance Status, the Notification of Compliance Status must contain the information specified in §63.2386(d)(3) and (4) if any of the changes identified in paragraph (d) of this section have occurred since the filing of the first

Compliance report. If none of the changes identified in paragraph (d) of this section have occurred since the filing of the first Compliance report, you do not need to report the information specified in §63.2386(c)(10)(i) when you submit your Notification of Compliance Status.

(B) If you submit your Notification of Compliance Status before your first Compliance report, your first Compliance report must contain the information specified in §63.2386(d)(3) and (4) if any of the changes specified in paragraph (d) of this section have occurred since the filing of the Notification of Compliance Status.

(iii) If you are already submitting a Notification of Compliance Status or a first Compliance report under §63.2386(c), you do not need to submit a separate Notification of Compliance Status or first Compliance report for each storage tank that meets the conditions identified in paragraph (b) of this section (i.e., a single Notification of Compliance Status or first Compliance report should be submitted).

(2)(i) You must submit a subsequent Compliance report according to the schedule in §63.2386(b) whenever any of the events in paragraph (d) of this section occur, as applicable.

(ii) Your subsequent Compliance reports must contain the information in §63.2386(c)(1), (2), (3) and, as applicable, in §63.2386(d)(3) and (4). If you are already submitting a subsequent Compliance report under §63.2386(d), you do not need to submit a separate subsequent Compliance report for each storage tank that meets the conditions identified in paragraph (b) of this section (i.e., a single subsequent Compliance report should be submitted).

(3) For each storage tank that meets the conditions identified in paragraph (b) of this section, you must keep documentation, including a record of the annual average true vapor pressure of the total Table 1 organic HAP in the stored organic liquid, that verifies the storage tank is not required to be controlled under this subpart. The documentation must be kept up-to-date and must be in a form suitable and readily available for expeditious inspection and review according to §63.10(b)(1), including records stored in electronic form in a separate location.

(c) For each transfer rack subject to this subpart that loads organic liquids but is not subject to control based on the criteria specified in Table 2 to this subpart, items 7 through 10, you must comply with the requirements specified in paragraphs (c)(1) through (3) of this section.

(1)(i) You must submit the information in §63.2386(c)(1), (2), (3), and (10)(i) in either the Notification of Compliance Status, according to the schedule specified in Table 12 to this subpart, or a first Compliance report, according to the schedule specified in §63.2386(b), whichever occurs first.

(ii)(A) If you submit your first Compliance report before your Notification of Compliance Status, the Notification of Compliance Status must contain the information specified in §63.2386(d)(3) and (4) if any of the changes identified in paragraph (d) of this section have occurred since the filing of the first Compliance report. If none of the changes identified in paragraph (d) of this section have occurred since the filing of the first Compliance report, you do not need to report the information specified in §63.2386(c)(10)(i) when you submit your Notification of Compliance Status.

(B) If you submit your Notification of Compliance Status before your first Compliance report, your first Compliance report must contain the information specified in §63.2386(d)(3) and (4) if any of the changes specified in paragraph (d) of this section have occurred since the filing of the Notification of Compliance Status.

(iii) If you are already submitting a Notification of Compliance Status or a first Compliance report under §63.2386(c), you do not need to submit a separate Notification of Compliance Status or first Compliance report for each transfer rack that meets the conditions identified in paragraph (b) of this section (i.e., a single Notification of Compliance Status or first Compliance report should be submitted).

(2)(i) You must submit a subsequent Compliance report according to the schedule in §63.2386(b) whenever any of the events in paragraph (d) of this section occur, as applicable.

(ii) Your subsequent Compliance reports must contain the information in §63.2386(c)(1), (2), (3) and, as applicable, in §63.2386(d)(3) and (4). If you are already submitting a subsequent Compliance report under §63.2386(d), you do not need to submit a separate subsequent Compliance report for each

transfer rack that meets the conditions identified in paragraph (c) of this section (i.e., a single subsequent Compliance report should be submitted).

(3) For each transfer rack that meets the conditions identified in paragraph (c) of this section, you must keep documentation, including the records specified in §63.2390(d), that verifies the transfer rack is not required to be controlled under this subpart. The documentation must be kept up-to-date and must be in a form suitable and readily available for expeditious inspection and review according to §63.10(b)(1), including records stored in electronic form in a separate location.

(d) If one or more of the events identified in paragraphs (d)(1) through (4) of this section occur since the filing of the Notification of Compliance Status or the last Compliance report, you must submit a subsequent Compliance report as specified in paragraphs (b)(3) and (c)(3) of this section.

(1) Any storage tank or transfer rack became subject to control under this subpart EEEE; or

(2) Any storage tank equal to or greater than 18.9 cubic meters (5,000 gallons) became part of the affected source but is not subject to any of the emission limitations, operating limits, or work practice standards of this subpart; or

(3) Any transfer rack (except those racks at which only unloading of organic liquids occurs) became part of the affected source; or

(4) Any of the information required in §63.2386(c)(1), §63.2386(c)(2), or §63.2386(c)(3) has changed.

[71 FR 42906, July 28, 2006]

Emission Limitations, Operating Limits, and Work Practice Standards

§ 63.2346 What emission limitations, operating limits, and work practice standards must I meet?

(a) *Storage tanks.* For each storage tank storing organic liquids that meets the tank capacity and liquid vapor pressure criteria for control in Table 2 to this subpart, items 1 through 5, you must comply with paragraph (a)(1), (a)(2), (a)(3), or (a)(4) of this section. For each storage tank storing organic liquids that meets the tank capacity and liquid vapor pressure criteria for control in Table 2 to this subpart, item 6, you must comply with paragraph (a)(1), (a)(2), or (a)(4) of this section.

(1) Meet the emission limits specified in Table 2 to this subpart and comply with the applicable requirements specified in 40 CFR part 63, subpart SS, for meeting emission limits, except substitute the term "storage tank" at each occurrence of the term "storage vessel" in subpart SS.

(2) Route emissions to fuel gas systems or back into a process as specified in 40 CFR part 63, subpart SS.

(3) Comply with 40 CFR part 63, subpart WW (control level 2).

(4) Use a vapor balancing system that complies with the requirements specified in paragraphs (a)(4)(i) through (vii) of this section and with the recordkeeping requirements specified in §63.2390(e).

(i) The vapor balancing system must be designed and operated to route organic HAP vapors displaced from loading of the storage tank to the transport vehicle from which the storage tank is filled.

(ii) Transport vehicles must have a current certification in accordance with the United States Department of Transportation (U.S. DOT) pressure test requirements of 49 CFR part 180 for cargo tanks and 49 CFR 173.31 for tank cars.

(iii) Organic liquids must only be unloaded from cargo tanks or tank cars when vapor collection systems are connected to the storage tank's vapor collection system.

(iv) No pressure relief device on the storage tank, or on the cargo tank or tank car, shall open during loading or as a result of diurnal temperature changes (breathing losses).

(v) Pressure relief devices must be set to no less than 2.5 pounds per square inch guage (psig) at all times to prevent breathing losses. Pressure relief devices may be set at values less than 2.5 psig if the owner or operator provides rationale in the notification of compliance status report explaining why the alternative value is sufficient to prevent breathing losses at all times. The owner or operator shall comply with paragraphs (a)(4)(iv)(A) through (C) of this section for each pressure relief valve.

(A) The pressure relief valve shall be monitored quarterly using the method described in §63.180(b).

(B) An instrument reading of 500 parts per million by volume (ppmv) or greater defines a leak.

(C) When a leak is detected, it shall be repaired as soon as practicable, but no later than 5 days after it is detected, and the owner or operator shall comply with the recordkeeping requirements of §63.181(d) (1) through (4).

(vi) Cargo tanks and tank cars that deliver organic liquids to a storage tank must be reloaded or cleaned at a facility that utilizes the control techniques specified in paragraph (a)(4)(vi)(A) or (a)(4)(vi)(B) of this section.

(A) The cargo tank or tank car must be connected to a closed-vent system with a control device that reduces inlet emissions of total organic HAP by 95 percent by weight or greater or to an exhaust concentration less than or equal to 20 ppmv, on a dry basis corrected to 3 percent oxygen for combustion devices using supplemental combustion air.

(B) A vapor balancing system designed and operated to collect organic HAP vapor displaced from the cargo tank or tank car during reloading must be used to route the collected vapor to the storage tank from which the liquid being transferred originated or to another storage tank connected to a common header.

(vii) The owner or operator of the facility where the cargo tank or tank car is reloaded or cleaned must comply with paragraphs (a)(4)(vii)(A) through (D) of this section.

(A) Submit to the owner or operator of the storage tank and to the Administrator a written certification that the reloading or cleaning facility will meet the requirements of paragraph (a)(4)(vii)(A) through (C) of this section. The certifying entity may revoke the written certification by sending a written statement to the owner or operator of the storage tank giving at least 90 days notice that the certifying entity is rescinding acceptance of responsibility for compliance with the requirements of this paragraph (a)(4)(vii) of this section.

(B) If complying with paragraph (a)(4)(vi)(A) of this section, comply with the requirements for a closed vent system and control device as specified in this subpart EEEE. The notification requirements in §63.2382 and the reporting requirements in §63.2386 do not apply to the owner or operator of the offsite cleaning or reloading facility.

(C) If complying with paragraph (a)(4)(vi)(B) of this section, keep the records specified in §63.2390(e)(3) or equivalent recordkeeping approved by the Administrator.

(D) After the compliance dates specified in §63.2342, at an offsite reloading or cleaning facility subject to §63.2346(a)(4), compliance with the monitoring, recordkeeping, and reporting provisions of any other subpart of this part 63 that has monitoring, recordkeeping, and reporting provisions constitutes compliance with the monitoring, recordkeeping and reporting provisions of §63.2346(a)(4)(vii)(B) or §63.2346(a)(4)(vii)(C). You must identify in your notification of compliance status report required by §63.2382(d) the subpart of this part 63 with which the owner or operator of the offsite reloading or cleaning facility complies.

(b) *Transfer racks.* For each transfer rack that is part of the collection of transfer racks that meets the total actual annual facility-level organic liquid loading volume criterion for control in Table 2 to this subpart, items 7 through 10, you must comply with paragraph (b)(1), (b)(2), or (b)(3) of this section for each arm in the transfer rack loading an organic liquid whose organic HAP content meets the organic

HAP criterion for control in Table 2 to this subpart, items 7 through 10. For existing affected sources, you must comply with paragraph (b)(1), (b)(2), or (b)(3)(i) of this section during the loading of organic liquids into transport vehicles. For new affected sources, you must comply with paragraph (b)(1), (b)(2), or (b)(3)(i) and (ii) of this section during the loading of organic liquids into transport vehicles and containers. If the total actual annual facility-level organic liquid loading volume at any affected source is equal to or greater than the loading volume criteria for control in Table 2 to this subpart, but at a later date is less than the loading volume criteria for control, compliance with paragraph (b)(1), (b)(2), or (b)(3) of this section is no longer required. For new sources and reconstructed sources, as defined in §63.2338(d) and (e), if at a later date, the total actual annual facility-level organic liquid loading volume again becomes equal to or greater than the loading volume criteria for control in Table 2 to this subpart, the owner or operator must comply with paragraph (b)(1), (b)(2), or (b)(3)(i) and (ii) of this section immediately, as specified in §63.2342(a)(3). For existing sources, as defined in §63.2338(f), if at a later date, the total actual annual facility-level organic liquid loading volume again becomes equal to or greater than the loading volume criteria for control in Table 2 to this subpart, the owner or operator must comply with paragraph (b)(1), (b)(2), or (b)(3)(i) of this section immediately, as specified in §63.2342(b)(3)(i), unless an alternative compliance schedule has been approved under §63.2342(b)(3)(ii) and subject to the use limitation specified in §63.2342(b)(3)(ii)(I).

(1) Meet the emission limits specified in Table 2 to this subpart and comply with the applicable requirements for transfer racks specified in 40 CFR part 63, subpart SS, for meeting emission limits.

(2) Route emissions to fuel gas systems or back into a process as specified in 40 CFR part 63, subpart SS.

(3)(i) Use a vapor balancing system that routes organic HAP vapors displaced from the loading of organic liquids into transport vehicles to the storage tank from which the liquid being loaded originated or to another storage tank connected to a common header.

(ii) Use a vapor balancing system that routes the organic HAP vapors displaced from the loading of organic liquids into containers directly (e.g., no intervening tank or containment area such as a room) to the storage tank from which the liquid being loaded originated or to another storage tank connected to a common header.

(c) *Equipment leak components.* For each pump, valve, and sampling connection that operates in organic liquids service for at least 300 hours per year, you must comply with the applicable requirements under 40 CFR part 63, subpart TT (control level 1), subpart UU (control level 2), or subpart H. Pumps, valves, and sampling connectors that are insulated to provide protection against persistent sub-freezing temperatures are subject to the "difficult to monitor" provisions in the applicable subpart selected by the owner or operator. This paragraph only applies if the affected source has at least one storage tank or transfer rack that meets the applicability criteria for control in Table 2 to this subpart.

(d) *Transport vehicles.* For each transport vehicle equipped with vapor collection equipment that is loaded at a transfer rack that is subject to control based on the criteria specified in Table 2 to this subpart, items 7 through 10, you must comply with paragraph (d)(1) of this section. For each transport vehicle without vapor collection equipment that is loaded at a transfer rack that is subject to control based on the criteria specified in Table 2 to this subpart, items 7 through 10, you must comply with paragraph (d)(2) of this section.

(1) Follow the steps in 40 CFR 60.502(e) to ensure that organic liquids are loaded only into vapor-tight transport vehicles and comply with the provisions in 40 CFR 60.502(f) through (i), except substitute the term "transport vehicle" at each occurrence of the term "tank truck" or "gasoline tank truck" in those paragraphs.

(2) Ensure that organic liquids are loaded only into transport vehicles that have a current certification in accordance with the U.S. Department of Transportation (DOT) pressure test requirements in 49 CFR part 180 for cargo tanks or 49 CFR 173.31 for tank cars.

(e) *Operating limits.* For each high throughput transfer rack, you must meet each operating limit in Table 3 to this subpart for each control device used to comply with the provisions of this subpart whenever emissions from the loading of organic liquids are routed to the control device. For each storage tank and low throughput transfer rack, you must comply with the requirements for monitored parameters as specified in subpart SS of this part for storage vessels and, during the loading of organic liquids, for low throughput transfer racks, respectively. Alternatively, you may comply with the operating limits in Table 3

to this subpart.

(f) If you elect to demonstrate compliance with a percent reduction requirement in Table 2 to this subpart using total organic compounds (TOC) rather than organic HAP, you must first demonstrate, subject to approval of the Administrator, that TOC is an appropriate surrogate for organic HAP in your case; that is, for your storage tank(s) and/or transfer rack(s), the percent destruction of organic HAP is equal to or higher than the percent destruction of TOC. This demonstration must be conducted prior to or during the initial compliance test.

(g) As provided in §63.6(g), you may request approval from the Administrator to use an alternative to the emission limitations, operating limits, and work practice standards in this section. You must follow the procedures in §63.177(b) through (e) in applying for permission to use such an alternative. If you apply for permission to use an alternative to the emission limitations, operating limits, and work practice standards in this section, you must submit the information described in §63.6(g)(2).

(h) [Reserved]

(i) Opening of a safety device is allowed at any time that it is required to avoid unsafe operating conditions.

(j) If you elect to comply with this subpart by combining emissions from different emission sources subject to this subpart in a single control device, then you must comply with the provisions specified in §63.982(f).

[69 FR 5063, Feb. 3, 2004, as amended at 71 FR 42908, July 28, 2006]

General Compliance Requirements

§ 63.2350 What are my general requirements for complying with this subpart?

(a) You must be in compliance with the emission limitations, operating limits, and work practice standards in this subpart at all times when the equipment identified in §63.2338(b)(1) through (4) is in OLD operation.

(b) You must always operate and maintain your affected source, including air pollution control and monitoring equipment, according to the provisions in §63.6(e)(1)(i).

(c) Except for emission sources not required to be controlled as specified in §63.2343, you must develop a written startup, shutdown, and malfunction (SSM) plan according to the provisions in §63.6(e)(3).

[69 FR 5063, Feb. 3, 2004, as amended at 71 FR 20463, Apr. 20, 2006; 71 FR 42909, July 28, 2006]

Testing and Initial Compliance Requirements

§ 63.2354 What performance tests, design evaluations, and performance evaluations must I conduct?

(a)(1) For each performance test that you conduct, you must use the procedures specified in subpart SS of this part and the provisions specified in paragraph (b) of this section.

(2) For each design evaluation you conduct, you must use the procedures specified in subpart SS of this part.

(3) For each performance evaluation of a continuous emission monitoring system (CEMS) you conduct, you must follow the requirements in §63.8(e).

(b)(1) For nonflare control devices, you must conduct each performance test according to the requirements in §63.7(e)(1), and either §63.988(b), §63.990(b), or §63.995(b), using the procedures

specified in §63.997(e).

(2) You must conduct three separate test runs for each performance test on a nonflare control device as specified in §§63.7(e)(3) and 63.997(e)(1)(v). Each test run must last at least 1 hour, except as provided in §63.997(e)(1)(v)(A) and (B).

(3)(i) In addition to EPA Method 25 or 25A of 40 CFR part 60, appendix A, to determine compliance with the organic HAP or TOC emission limit, you may use EPA Method 18 of 40 CFR part 60, appendix A, as specified in paragraph (b)(3)(i) of this section. As an alternative to EPA Method 18, you may use ASTM D6420–99 (Reapproved 2004), Standard Test Method for Determination of Gaseous Organic Compounds by Direct Interface Gas Chromatography-Mass Spectrometry (incorporated by reference, see §63.14), under the conditions specified in paragraph (b)(3)(ii) of this section.

(A) If you use EPA Method 18 to measure compliance with the percentage efficiency limit, you must first determine which organic HAP are present in the inlet gas stream (i.e., uncontrolled emissions) using knowledge of the organic liquids or the screening procedure described in EPA Method 18. In conducting the performance test, you must analyze samples collected as specified in EPA Method 18, simultaneously at the inlet and outlet of the control device. Quantify the emissions for the same organic HAP identified as present in the inlet gas stream for both the inlet and outlet gas streams of the control device.

(B) If you use EPA Method 18 of 40 CFR part 60, appendix A, to measure compliance with the emission concentration limit, you must first determine which organic HAP are present in the inlet gas stream using knowledge of the organic liquids or the screening procedure described in EPA Method 18. In conducting the performance test, analyze samples collected as specified in EPA Method 18 at the outlet of the control device. Quantify the control device outlet emission concentration for the same organic HAP identified as present in the inlet or uncontrolled gas stream.

(ii) You may use ASTM D6420–99 (Reapproved 2004), Standard Test Method for Determination of Gaseous Organic Compounds by Direct Interface Gas Chromatography-Mass Spectrometry (incorporated by reference, see §63.14), as an alternative to EPA Method 18 if the target concentration is between 150 parts per billion by volume and 100 ppmv and either of the conditions specified in paragraph (b)(2)(ii)(A) or (B) of this section exists. For target compounds not listed in Section 1.1 of ASTM D6420–99 (Reapproved 2004) and not amenable to detection by mass spectrometry, you may not use ASTM D6420–99 (Reapproved 2004).

(A) The target compounds are those listed in Section 1.1 of ASTM D6420–99 (Reapproved 2004), Standard Test Method for Determination of Gaseous Organic Compounds by Direct Interface Gas Chromatography-Mass Spectrometry (incorporated by reference, see §63.14);; or

(B) For target compounds not listed in Section 1.1 of ASTM D6420–99 (Reapproved 2004), Standard Test Method for Determination of Gaseous Organic Compounds by Direct Interface Gas Chromatography-Mass Spectrometry (incorporated by reference, see §63.14), but potentially detected by mass spectrometry, the additional system continuing calibration check after each run, as detailed in ASTM D6420–99 (Reapproved 2004), Section 10.5.3, must be followed, met, documented, and submitted with the data report, even if there is no moisture condenser used or the compound is not considered water-soluble.

(4) If a principal component of the uncontrolled or inlet gas stream to the control device is formaldehyde, you may use EPA Method 316 of appendix A of this part instead of EPA Method 18 of 40 CFR part 60, appendix A, for measuring the formaldehyde. If formaldehyde is the predominant organic HAP in the inlet gas stream, you may use EPA Method 316 alone to measure formaldehyde either at the inlet and outlet of the control device using the formaldehyde control efficiency as a surrogate for total organic HAP or TOC efficiency, or at the outlet of a combustion device for determining compliance with the emission concentration limit.

(5) You may not conduct performance tests during periods of SSM, as specified in §63.7(e)(1).

(c) To determine the HAP content of the organic liquid, you may use EPA Method 311 of 40 CFR part 63, appendix A, or other method approved by the Administrator. In addition, you may use other means, such as voluntary consensus standards, material safety data sheets (MSDS), or certified product data sheets, to determine the HAP content of the organic liquid. If the method you select to determine the

HAP content provides HAP content ranges, you must use the upper end of each HAP content range in determining the total HAP content of the organic liquid. The EPA may require you to test the HAP content of an organic liquid using EPA Method 311 or other method approved by the Administrator. If the results of the EPA Method 311 (or any other approved method) are different from the HAP content determined by another means, the EPA Method 311 (or approved method) results will govern.

[69 FR 5063, Feb. 3, 2004, as amended at 71 FR 42909, July 28, 2006]

§ 63.2358 By what date must I conduct performance tests and other initial compliance demonstrations?

(a) You must conduct initial performance tests and design evaluations according to the schedule in §63.7(a)(2), or by the compliance date specified in any applicable State or Federal new source review construction permit to which the affected source is already subject, whichever is earlier.

(b)(1) For storage tanks and transfer racks at existing affected sources complying with the emission limitations listed in Table 2 to this subpart, you must demonstrate initial compliance with the emission limitations within 180 days after February 5, 2007.

(2) For storage tanks and transfer racks at reconstructed or new affected sources complying with the emission limitations listed in Table 2 to this subpart, you must conduct your initial compliance demonstration with the emission limitations within 180 days after the initial startup date for the affected source or February 3, 2004, whichever is later.

(c)(1) For storage tanks at existing affected sources complying with the work practice standard in Table 4 to this subpart, you must conduct your initial compliance demonstration the next time the storage tank is emptied and degassed, but not later than 10 years after February 3, 2004.

(2) For transfer racks and equipment leak components at existing affected sources complying with the work practice standards in Table 4 to this subpart, you must conduct your initial compliance demonstration within 180 days after February 5, 2007.

(d) For storage tanks, transfer racks, and equipment leak components at reconstructed or new affected sources complying with the work practice standards in Table 4 to this subpart, you must conduct your initial compliance demonstration within 180 days after the initial startup date for the affected source.

§ 63.2362 When must I conduct subsequent performance tests?

(a) For nonflare control devices, you must conduct subsequent performance testing required in Table 5 to this subpart, item 1, at any time the EPA requests you to in accordance with section 114 of the CAA.

(b)(1) For each transport vehicle that you own that is equipped with vapor collection equipment and that is loaded with organic liquids at a transfer rack that is subject to control based on the criteria specified in Table 2 to this subpart, items 7 through 10, you must perform the vapor tightness testing required in Table 5 to this subpart, item 2, on that transport vehicle at least once per year.

(2) For transport vehicles that you own that do not have vapor collection equipment, you must maintain current certification in accordance with the U.S. DOT pressure test requirements in 49 CFR part 180 for cargo tanks or 49 CFR 173.31 for tank cars.

[69 FR 5063, Feb. 3, 2004, as amended at 71 FR 42910, July 28, 2006]

§ 63.2366 What are my monitoring installation, operation, and maintenance requirements?

(a) You must install, operate, and maintain a CMS on each control device required in order to comply with this subpart. If you use a continuous parameter monitoring system (CPMS) (as defined in §63.981), you must comply with the applicable requirements for CPMS in subpart SS of this part for the control device being used. If you use a continuous emissions monitoring system (CEMS), you must comply with the requirements in §63.8.

(b) For nonflare control devices controlling storage tanks and low throughput transfer racks, you must submit a monitoring plan according to the requirements in subpart SS of this part for monitoring plans.

§ 63.2370 How do I demonstrate initial compliance with the emission limitations, operating limits, and work practice standards?

(a) You must demonstrate initial compliance with each emission limitation and work practice standard that applies to you as specified in Tables 6 and 7 to this subpart.

(b) You demonstrate initial compliance with the operating limits requirements specified in §63.2346(e) by establishing the operating limits during the initial performance test or design evaluation.

(c) You must submit the results of the initial compliance determination in the Notification of Compliance Status according to the requirements in §63.2382(d).

[69 FR 5063, Feb. 3, 2004, as amended at 71 FR 42910, July 28, 2006]

Continuous Compliance Requirements

§ 63.2374 When do I monitor and collect data to demonstrate continuous compliance and how do I use the collected data?

(a) You must monitor and collect data according to subpart SS of this part and paragraphs (b) and (c) of this section.

(b) When using a control device to comply with this subpart, you must monitor continuously or collect data at all required intervals at all times that the emission source and control device are in OLD operation, except for CMS malfunctions (including any malfunction preventing the CMS from operating properly), associated repairs, and required quality assurance or control activities (including, as applicable, calibration checks and required zero and span adjustments).

(c) Do not use data recorded during CMS malfunctions, associated repairs, required quality assurance or control activities, or periods when emissions from organic liquids are not routed to the control device in data averages and calculations used to report emission or operating levels. Do not use such data in fulfilling a minimum data availability requirement, if applicable. You must use all of the data collected during all other periods, including periods of SSM, in assessing the operation of the control device.

§ 63.2378 How do I demonstrate continuous compliance with the emission limitations, operating limits, and work practice standards?

(a) You must demonstrate continuous compliance with each emission limitation, operating limit, and work practice standard in Tables 2 through 4 to this subpart that applies to you according to the methods specified in subpart SS of this part and in Tables 8 through 10 to this subpart, as applicable.

(b) You must follow the requirements in §63.6(e)(1) and (3) during periods of startup, shutdown, malfunction, or nonoperation of the affected source or any part thereof. In addition, the provisions of paragraphs (b)(1) through (3) of this section apply.

(1) The emission limitations in this subpart apply at all times except during periods of nonoperation of the affected source (or specific portion thereof) resulting in cessation of the emissions to which this subpart applies. The emission limitations of this subpart apply during periods of SSM, except as provided in paragraphs (b)(2) and (3) of this section. However, if a SSM, or period of nonoperation of one portion of the affected source does not affect the ability of a particular emission source to comply with the emission limitations to which it is subject, then that emission source is still required to comply with the applicable emission limitations of this subpart during the startup, shutdown, malfunction, or period of nonoperation.

(2) The owner or operator must not shut down control devices or monitoring systems that are required or utilized for achieving compliance with this subpart during periods of SSM while emissions are being routed to such items of equipment if the shutdown would contravene requirements of this subpart

applicable to such items of equipment. This paragraph (b)(2) does not apply if the item of equipment is malfunctioning. This paragraph (b)(2) also does not apply if the owner or operator shuts down the compliance equipment (other than monitoring systems) to avoid damage due to a contemporaneous SSM of the affected source or portion thereof. If the owner or operator has reason to believe that monitoring equipment would be damaged due to a contemporaneous SSM of the affected source or portion thereof, the owner or operator must provide documentation supporting such a claim in the next Compliance report required in Table 11 to this subpart, item 1. Once approved by the Administrator, the provision for ceasing to collect, during a SSM, monitoring data that would otherwise be required by the provisions of this subpart must be incorporated into the SSM plan.

(3) During SSM, you must implement, to the extent reasonably available, measures to prevent or minimize excess emissions. For purposes of this paragraph (b)(3), the term "excess emissions" means emissions greater than those allowed by the emission limits that apply during normal operational periods. The measures to be taken must be identified in the SSM plan, and may include, but are not limited to, air pollution control technologies, recovery technologies, work practices, pollution prevention, monitoring, and/or changes in the manner of operation of the affected source. Back-up control devices are not required, but may be used if available.

(c) Periods of planned routine maintenance of a control device used to control storage tanks or transfer racks, during which the control device does not meet the emission limits in Table 2 to this subpart, must not exceed 240 hours per year.

(d) If you elect to route emissions from storage tanks or transfer racks to a fuel gas system or to a process, as allowed by §63.982(d), to comply with the emission limits in Table 2 to this subpart, the total aggregate amount of time during which the emissions bypass the fuel gas system or process during the calendar year without being routed to a control device, for all reasons (except SSM or product changeovers of flexible operation units and periods when a storage tank has been emptied and degassed), must not exceed 240 hours.

[69 FR 5063, Feb. 3, 2004, as amended at 71 FR 20463, Apr. 20, 2006]

Notifications, Reports, and Records

§ 63.2382 What notifications must I submit and when and what information should be submitted?

(a) You must submit each notification in subpart SS of this part, Table 12 to this subpart, and paragraphs (b) through (d) of this section that applies to you. You must submit these notifications according to the schedule in Table 12 to this subpart and as specified in paragraphs (b) through (d) of this section.

(b)(1) *Initial Notification.* If you startup your affected source before February 3, 2004, you must submit the Initial Notification no later than 120 calendar days after February 3, 2004.

(2) If you startup your new or reconstructed affected source on or after February 3, 2004, you must submit the Initial Notification no later than 120 days after initial startup.

(c) If you are required to conduct a performance test, you must submit the Notification of Intent to conduct the test at least 60 calendar days before it is initially scheduled to begin as required in §63.7(b)(1).

(d)(1) *Notification of Compliance Status.* If you are required to conduct a performance test, design evaluation, or other initial compliance demonstration as specified in Table 5, 6, or 7 to this subpart, you must submit a Notification of Compliance Status.

(2) The Notification of Compliance Status must include the information required in §63.999(b) and in paragraphs (d)(2)(i) through (viii) of this section.

(i) The results of any applicability determinations, emission calculations, or analyses used to identify and quantify organic HAP emissions from the affected source.

(ii) The results of emissions profiles, performance tests, engineering analyses, design evaluations, flare compliance assessments, inspections and repairs, and calculations used to demonstrate initial compliance according to Tables 6 and 7 to this subpart. For performance tests, results must include descriptions of sampling and analysis procedures and quality assurance procedures.

(iii) Descriptions of monitoring devices, monitoring frequencies, and the operating limits established during the initial compliance demonstrations, including data and calculations to support the levels you establish.

(iv) Descriptions of worst-case operating and/or testing conditions for the control device(s).

(v) Identification of emission sources subject to overlapping requirements described in §63.2396 and the authority under which you will comply.

(vi) The applicable information specified in §63.1039(a)(1) through (3) for all pumps and valves subject to the work practice standards for equipment leak components in Table 4 to this subpart, item 4.

(vii) If you are complying with the vapor balancing work practice standard for transfer racks according to Table 4 to this subpart, item 3.a, include a statement to that effect and a statement that the pressure vent settings on the affected storage tanks are greater than or equal to 2.5 psig.

(viii) The information specified in §63.2386(c)(10)(i), unless the information has already been submitted with the first Compliance report. If the information specified in §63.2386(c)(10)(i) has already been submitted with the first Compliance report, the information specified in §63.2386(d)(3) and (4), as applicable, shall be submitted instead.

[69 FR 5063, Feb. 3, 2004, as amended at 71 FR 42910, July 28, 2006]

§ 63.2386 What reports must I submit and when and what information is to be submitted in each?

(a) You must submit each report in subpart SS of this part, Table 11 to this subpart, Table 12 to this subpart, and in paragraphs (c) through (e) of this section that applies to you.

(b) Unless the Administrator has approved a different schedule for submission of reports under §63.10(a), you must submit each report according to Table 11 to this subpart and by the dates shown in paragraphs (b)(1) through (3) of this section, by the dates shown in subpart SS of this part, and by the dates shown in Table 12 to this subpart, whichever are applicable.

(1)(i) The first Compliance report must cover the period beginning on the compliance date that is specified for your affected source in §63.2342 and ending on June 30 or December 31, whichever date is the first date following the end of the first calendar half after the compliance date that is specified for your affected source in §63.2342.

(ii) The first Compliance report must be postmarked no later than July 31 or January 31, whichever date follows the end of the first calendar half after the compliance date that is specified for your affected source in §63.2342.

(2)(i) Each subsequent Compliance report must cover the semiannual reporting period from January 1 through June 30 or the semiannual reporting period from July 1 through December 31.

(ii) Each subsequent Compliance report must be postmarked no later than July 31 or January 31, whichever date is the first date following the end of the semiannual reporting period.

(3) For each affected source that is subject to permitting regulations pursuant to 40 CFR part 70 or 40 CFR part 71, if the permitting authority has established dates for submitting semiannual reports pursuant to 40 CFR 70.6(a)(3)(iii)(A) or 40 CFR 71.6(a)(3)(iii)(A), you may submit the first and subsequent Compliance reports according to the dates the permitting authority has established instead of according to the dates in paragraphs (b)(1) and (2) of this section.

(c) *First Compliance report.* The first Compliance report must contain the information specified in paragraphs (c)(1) through (10) of this section.

(1) Company name and address.

(2) Statement by a responsible official, including the official's name, title, and signature, certifying that, based on information and belief formed after reasonable inquiry, the statements and information in the report are true, accurate, and complete.

(3) Date of report and beginning and ending dates of the reporting period.

(4) Any changes to the information listed in §63.2382(d)(2) that have occurred since the submittal of the Notification of Compliance Status.

(5) If you had a SSM during the reporting period and you took actions consistent with your SSM plan, the Compliance report must include the information described in §63.10(d)(5)(i).

(6) If there are no deviations from any emission limitation or operating limit that applies to you and there are no deviations from the requirements for work practice standards, a statement that there were no deviations from the emission limitations, operating limits, or work practice standards during the reporting period.

(7) If there were no periods during which the CMS was out of control as specified in §63.8(c)(7), a statement that there were no periods during which the CMS was out of control during the reporting period.

(8) For closed vent systems and control devices used to control emissions, the information specified in paragraphs (c)(8)(i) and (ii) of this section for those planned routine maintenance activities that would require the control device to not meet the applicable emission limit.

(i) A description of the planned routine maintenance that is anticipated to be performed for the control device during the next 6 months. This description must include the type of maintenance necessary, planned frequency of maintenance, and lengths of maintenance periods.

(ii) A description of the planned routine maintenance that was performed for the control device during the previous 6 months. This description must include the type of maintenance performed and the total number of hours during those 6 months that the control device did not meet the applicable emission limit due to planned routine maintenance.

(9) A listing of all transport vehicles into which organic liquids were loaded at transfer racks that are subject to control based on the criteria specified in Table 2 to this subpart, items 7 through 10, during the previous 6 months for which vapor tightness documentation as required in §63.2390(c) was not on file at the facility.

(10)(i) A listing of all transfer racks (except those racks at which only unloading of organic liquids occurs) and of tanks greater than or equal to 18.9 cubic meters (5,000 gallons) that are part of the affected source but are not subject to any of the emission limitations, operating limits, or work practice standards of this subpart.

(ii) If the information specified in paragraph (c)(10)(i) of this section has already been submitted with the Notification of Compliance Status, the information specified in paragraphs (d)(3) and (4) of this section, as applicable, shall be submitted instead.

(d) *Subsequent Compliance reports.* Subsequent Compliance reports must contain the information in paragraphs (c)(1) through (9) of this section and, where applicable, the information in paragraphs (d)(1) through (4) of this section.

(1) For each deviation from an emission limitation occurring at an affected source where you are using a CMS to comply with an emission limitation in this subpart, you must include in the Compliance report the applicable information in paragraphs (d)(1)(i) through (xii) of this section. This includes periods of SSM.

- (i) The date and time that each malfunction started and stopped.
 - (ii) The dates and times that each CMS was inoperative, except for zero (low-level) and high-level checks.
 - (iii) For each CMS that was out of control, the information in §63.8(c)(8).
 - (iv) The date and time that each deviation started and stopped, and whether each deviation occurred during a period of SSM, or during another period.
 - (v) A summary of the total duration of the deviations during the reporting period, and the total duration as a percentage of the total emission source operating time during that reporting period.
 - (vi) A breakdown of the total duration of the deviations during the reporting period into those that are due to startup, shutdown, control equipment problems, process problems, other known causes, and other unknown causes.
 - (vii) A summary of the total duration of CMS downtime during the reporting period, and the total duration of CMS downtime as a percentage of the total emission source operating time during that reporting period.
 - (viii) An identification of each organic HAP that was potentially emitted during each deviation based on the known organic HAP contained in the liquid(s).
 - (ix) A brief description of the emission source(s) at which the CMS deviation(s) occurred.
 - (x) A brief description of each CMS that was out of control during the period.
 - (xi) The date of the latest certification or audit for each CMS.
 - (xii) A brief description of any changes in CMS, processes, or controls since the last reporting period.
- (2) Include in the Compliance report the information in paragraphs (d)(2)(i) through (iii) of this section, as applicable.
- (i) For each storage tank and transfer rack subject to control requirements, include periods of planned routine maintenance during which the control device did not comply with the applicable emission limits in Table 2 to this subpart.
 - (ii) For each storage tank controlled with a floating roof, include a copy of the inspection record (required in §63.1065(b)) when inspection failures occur.
 - (iii) If you elect to use an extension for a floating roof inspection in accordance with §63.1063(c)(2)(iv)(B) or (e)(2), include the documentation required by those paragraphs.
- (3)(i) A listing of any storage tank that became subject to controls based on the criteria for control specified in Table 2 to this subpart, items 1 through 6, since the filing of the last Compliance report.
- (ii) A listing of any transfer rack that became subject to controls based on the criteria for control specified in Table 2 to this subpart, items 7 through 10, since the filing of the last Compliance report.
- (4)(i) A listing of tanks greater than or equal to 18.9 cubic meters (5,000 gallons) that became part of the affected source but are not subject to any of the emission limitations, operating limits, or work practice standards of this subpart, since the last Compliance report.
- (ii) A listing of all transfer racks (except those racks at which only the unloading of organic liquids occurs) that became part of the affected source but are not subject to any of the emission limitations, operating limits, or work practice standards of this subpart, since the last Compliance report.

(e) Each affected source that has obtained a title V operating permit pursuant to 40 CFR part 70 or 40 CFR part 71 must report all deviations as defined in this subpart in the semiannual monitoring report required by 40 CFR 70.6(a)(3)(iii)(A) or 71.6(a)(3)(iii)(A). If an affected source submits a Compliance report pursuant to Table 11 to this subpart along with, or as part of, the semiannual monitoring report required by 40 CFR 70.6(a)(3)(iii)(A) or 71.6(a)(3)(iii)(A), and the Compliance report includes all required information concerning deviations from any emission limitation in this subpart, we will consider submission of the Compliance report as satisfying any obligation to report the same deviations in the semiannual monitoring report. However, submission of a Compliance report will not otherwise affect any obligation the affected source may have to report deviations from permit requirements to the applicable title V permitting authority.

[69 FR 5063, Feb. 3, 2004, as amended at 71 FR 42910, July 28, 2006]

§ 63.2390 What records must I keep?

(a) For each emission source identified in §63.2338 that does not require control under this subpart, you must keep all records identified in §63.2343.

(b) For each emission source identified in §63.2338 that does require control under this subpart:

(1) You must keep all records identified in subpart SS of this part and in Table 12 to this subpart that are applicable, including records related to notifications and reports, SSM, performance tests, CMS, and performance evaluation plans; and

(2) You must keep the records required to show continuous compliance, as required in subpart SS of this part and in Tables 8 through 10 to this subpart, with each emission limitation, operating limit, and work practice standard that applies to you.

(c) For each transport vehicle into which organic liquids are loaded at a transfer rack that is subject to control based on the criteria specified in Table 2 to this subpart, items 7 through 10, you must keep the applicable records in paragraphs (c)(1) and (2) of this section or alternatively the verification records in paragraph (c)(3) of this section.

(1) For transport vehicles equipped with vapor collection equipment, the documentation described in 40 CFR 60.505(b), except that the test title is: Transport Vehicle Pressure Test-EPA Reference Method 27.

(2) For transport vehicles without vapor collection equipment, current certification in accordance with the U.S. DOT pressure test requirements in 49 CFR part 180 for cargo tanks or 49 CFR 173.31 for tank cars.

(3) In lieu of keeping the records specified in paragraph (c)(1) or (2) of this section, as applicable, the owner or operator shall record that the verification of U.S. DOT tank certification or Method 27 of appendix A to 40 CFR part 60 testing, required in Table 5 to this subpart, item 2, has been performed. Various methods for the record of verification can be used, such as: A check-off on a log sheet, a list of U.S. DOT serial numbers or Method 27 data, or a position description for gate security showing that the security guard will not allow any trucks on site that do not have the appropriate documentation.

(d) You must keep records of the total actual annual facility-level organic liquid loading volume as defined in §63.2406 through transfer racks to document the applicability, or lack thereof, of the emission limitations in Table 2 to this subpart, items 7 through 10.

(e) An owner or operator who elects to comply with §63.2346(a)(4) shall keep the records specified in paragraphs (e)(1) through (3) of this section.

(1) A record of the U.S. DOT certification required by §63.2346(a)(4)(ii).

(2) A record of the pressure relief vent setting specified in §63.2348(a)(4)(v).

(3) If complying with §63.2348(a)(4)(vi)(B), keep the records specified in paragraphs (e)(3)(i) and (ii) of this section.

(i) A record of the equipment to be used and the procedures to be followed when reloading the cargo tank or tank car and displacing vapors to the storage tank from which the liquid originates.

(ii) A record of each time the vapor balancing system is used to comply with §63.2348(a)(4)(vi)(B).

[69 FR 5063, Feb. 3, 2004, as amended at 71 FR 42910, July 28, 2006]

§ 63.2394 In what form and how long must I keep my records?

(a) Your records must be in a form suitable and readily available for expeditious inspection and review according to §63.10(b)(1), including records stored in electronic form at a separate location.

(b) As specified in §63.10(b)(1), you must keep your files of all information (including all reports and notifications) for at least 5 years following the date of each occurrence, measurement, maintenance, corrective action, report, or record.

(c) You must keep each record on site for at least 2 years after the date of each occurrence, measurement, maintenance, corrective action, report, or record, according to §63.10(b)(1). You may keep the records off site for the remaining 3 years.

[69 FR 5063, Feb. 3, 2004, as amended at 71 FR 42911, July 28, 2006]

Other Requirements and Information

§ 63.2396 What compliance options do I have if part of my plant is subject to both this subpart and another subpart?

(a) *Compliance with other regulations for storage tanks* . (1) After the compliance dates specified in §63.2342, you are in compliance with the provisions of this subpart for any storage tank that is assigned to the OLD affected source and that is both controlled with a floating roof and is in compliance with the provisions of either 40 CFR part 60, subpart Kb, or 40 CFR part 61, subpart Y, except that records shall be kept for 5 years rather than 2 years for storage tanks that are assigned to the OLD affected source.

(2) After the compliance dates specified in §63.2342, you are in compliance with the provisions of this subpart for any storage tank with a fixed roof that is assigned to the OLD affected source and that is both controlled with a closed vent system and control device and is in compliance with either 40 CFR part 60, subpart Kb, or 40 CFR part 61, subpart Y, except that you must comply with the monitoring, recordkeeping, and reporting requirements in this subpart.

(3) As an alternative to paragraphs (a)(1) and (2) of this section, if a storage tank assigned to the OLD affected source is subject to control under 40 CFR part 60, subpart Kb, or 40 CFR part 61, subpart Y, you may elect to comply only with the requirements of this subpart for storage tanks meeting the applicability criteria for control in Table 2 to this subpart.

(b) *Compliance with other regulations for transfer racks* . After the compliance dates specified in §63.2342, if you have a transfer rack that is subject to 40 CFR part 61, subpart BB, and that transfer rack is in OLD operation, you must meet all of the requirements of this subpart for that transfer rack when the transfer rack is in OLD operation during the loading of organic liquids.

(c) *Compliance with other regulations for equipment leak components*. (1) After the compliance dates specified in §63.2342, if you have pumps, valves, or sampling connections that are subject to a 40 CFR part 60 subpart, and those pumps, valves, and sampling connections are in OLD operation and in organic liquids service, as defined in this subpart, you must comply with the provisions of each subpart for those equipment leak components.

(2) After the compliance dates specified in §63.2342, if you have pumps, valves, or sampling connections subject to 40 CFR part 63, subpart GGG, and those pumps, valves, and sampling connections are in OLD operation and in organic liquids service, as defined in this subpart, you may elect to comply with the provisions of this subpart for all such equipment leak components. You must identify in the Notification of Compliance Status required by §63.2382(b) the provisions with which you

will comply.

(d) [Reserved]

(e) *Overlap with other regulations for monitoring, recordkeeping, and reporting . (1) Control devices .* After the compliance dates specified in §63.2342, if any control device subject to this subpart is also subject to monitoring, recordkeeping, and reporting requirements of another 40 CFR part 63 subpart, the owner or operator must be in compliance with the monitoring, recordkeeping, and reporting requirements of this subpart EEEE. If complying with the monitoring, recordkeeping, and reporting requirements of the other subpart satisfies the monitoring, recordkeeping, and reporting requirements of this subpart, the owner or operator may elect to continue to comply with the monitoring, recordkeeping, and reporting requirements of the other subpart. In such instances, the owner or operator will be deemed to be in compliance with the monitoring, recordkeeping, and reporting requirements of this subpart. The owner or operator must identify the other subpart being complied with in the Notification of Compliance Status required by §63.2382(b).

(2) *Equipment leak components .* After the compliance dates specified in §63.2342, if you are applying the applicable recordkeeping and reporting requirements of another 40 CFR part 63 subpart to the valves, pumps, and sampling connection systems associated with a transfer rack subject to this subpart that only unloads organic liquids directly to or via pipeline to a non-tank process unit component or to a storage tank subject to the other 40 CFR part 63 subpart, the owner or operator must be in compliance with the recordkeeping and reporting requirements of this subpart EEEE. If complying with the recordkeeping and reporting requirements of the other subpart satisfies the recordkeeping and reporting requirements of this subpart, the owner or operator may elect to continue to comply with the recordkeeping and reporting requirements of the other subpart. In such instances, the owner or operator will be deemed to be in compliance with the recordkeeping and reporting requirements of this subpart. The owner or operator must identify the other subpart being complied with in the Notification of Compliance Status required by §63.2382(b).

[69 FR 5063, Feb. 3, 2004, as amended at 71 FR 42911, July 28, 2006]

§ 63.2398 What parts of the General Provisions apply to me?

Table 12 to this subpart shows which parts of the General Provisions in §§63.1 through 63.15 apply to you.

§ 63.2402 Who implements and enforces this subpart?

(a) This subpart can be implemented and enforced by the U.S. Environmental Protection Agency (U.S. EPA) or a delegated authority such as your State, local, or eligible tribal agency. If the EPA Administrator has delegated authority to your State, local, or eligible tribal agency, then that agency, as well as the EPA, has the authority to implement and enforce this subpart. You should contact your EPA Regional Office (see list in §63.13) to find out if this subpart is delegated to your State, local, or eligible tribal agency.

(b) In delegating implementation and enforcement authority for this subpart to a State, local, or eligible tribal agency under 40 CFR part 63, subpart E, the authorities contained in paragraphs (b)(1) through (4) of this section are retained by the EPA Administrator and are not delegated to the State, local, or eligible tribal agency.

(1) Approval of alternatives to the nonopacity emission limitations, operating limits, and work practice standards in §63.2346(a) through (c) under §63.6(g).

(2) Approval of major changes to test methods under §63.7(e)(2)(ii) and (f) and as defined in §63.90.

(3) Approval of major changes to monitoring under §63.8(f) and as defined in §63.90.

(4) Approval of major changes to recordkeeping and reporting under §63.10(f) and as defined in §63.90.

[69 FR 5063, Feb. 3, 2004, as amended at 71 FR 42911, July 28, 2006]

§ 63.2406 What definitions apply to this subpart?

Terms used in this subpart are defined in the CAA, in §63.2, 40 CFR part 63, subparts H, PP, SS, TT, UU, and WW, and in this section. If the same term is defined in another subpart and in this section, it will have the meaning given in this section for purposes of this subpart. Notwithstanding the introductory language in §63.921, the terms "container" and "safety device" shall have the meaning found in this subpart and not in §63.921.

Actual annual average temperature, for organic liquids, means the temperature determined using the following methods:

(1) For heated or cooled storage tanks, use the calculated annual average temperature of the stored organic liquid as determined from a design analysis of the storage tank.

(2) For ambient temperature storage tanks:

(i) Use the annual average of the local (nearest) normal daily mean temperatures reported by the National Climatic Data Center; or

(ii) Use any other method that the EPA approves.

Annual average true vapor pressure means the equilibrium partial pressure exerted by the total Table 1 organic HAP in the stored or transferred organic liquid. For the purpose of determining if a liquid meets the definition of an organic liquid, the vapor pressure is determined using standard conditions of 77 degrees F and 29.92 inches of mercury. For the purpose of determining whether an organic liquid meets the applicability criteria in Table 2, items 1 through 6, to this subpart, use the actual annual average temperature as defined in this subpart. The vapor pressure value in either of these cases is determined:

(1) In accordance with methods described in American Petroleum Institute Publication 2517, Evaporative Loss from External Floating-Roof Tanks (incorporated by reference, see §63.14);

(2) Using standard reference texts;

(3) By the American Society for Testing and Materials Method D2879-83, 96 (incorporated by reference, see §63.14); or

(4) Using any other method that the EPA approves.

Bottoms receiver means a tank that collects distillation bottoms before the stream is sent for storage or for further processing downstream.

Cargo tank means a liquid-carrying tank permanently attached and forming an integral part of a motor vehicle or truck trailer. This term also refers to the entire cargo tank motor vehicle or trailer. For the purpose of this subpart, vacuum trucks used exclusively for maintenance or spill response are not considered cargo tanks.

Closed vent system means a system that is not open to the atmosphere and is composed of piping, ductwork, connections, and, if necessary, flow-inducing devices that transport gas or vapors from an emission point to a control device. This system does not include the vapor collection system that is part of some transport vehicles or the loading arm or hose that is used for vapor return. For transfer racks, the closed vent system begins at, and includes, the first block valve on the downstream side of the loading arm or hose used to convey displaced vapors.

Combustion device means an individual unit of equipment, such as a flare, oxidizer, catalytic oxidizer, process heater, or boiler, used for the combustion of organic emissions.

Container means a portable unit in which a material can be stored, transported, treated, disposed of, or otherwise handled. Examples of containers include, but are not limited to, drums and portable cargo containers known as "portable tanks" or "totes."

Control device means any combustion device, recovery device, recapture device, or any combination of these devices used to comply with this subpart. Such equipment or devices include, but are not limited to, absorbers, adsorbers, condensers, and combustion devices. Primary condensers, steam strippers, and fuel gas systems are not considered control devices.

Crude oil means any of the naturally occurring liquids commonly referred to as crude oil, regardless of specific physical properties. Only those crude oils downstream of the first point of custody transfer after the production field are considered crude oils in this subpart.

Custody transfer means the transfer of hydrocarbon liquids after processing and/or treatment in the producing operations, or from storage tanks or automatic transfer facilities to pipelines or any other forms of transportation.

Design evaluation means a procedure for evaluating control devices that complies with the requirements in §63.985(b)(1)(i).

Deviation means any instance in which an affected source subject to this subpart, or portion thereof, or an owner or operator of such a source:

- (1) Fails to meet any requirement or obligation established by this subpart including, but not limited to, any emission limitation (including any operating limit) or work practice standard;
- (2) Fails to meet any term or condition that is adopted to implement an applicable requirement in this subpart, and that is included in the operating permit for any affected source required to obtain such a permit; or
- (3) Fails to meet any emission limitation (including any operating limit) or work practice standard in this subpart during SSM.

Emission limitation means an emission limit, opacity limit, operating limit, or visible emission limit.

Equipment leak component means each pump, valve, and sampling connection system used in organic liquids service at an OLD operation. Valve types include control, globe, gate, plug, and ball. Relief and check valves are excluded.

Gasoline means any petroleum distillate or petroleum distillate/alcohol blend having a Reid vapor pressure of 27.6 kilopascals (4.0 pounds per square inch absolute (psia)) or greater which is used as a fuel for internal combustion engines. Aviation gasoline is included in this definition.

High throughput transfer rack means those transfer racks that transfer into transport vehicles (for existing affected sources) or into transport vehicles and containers (for new affected sources) a total of 11.8 million liters per year or greater of organic liquids.

In organic liquids service means that an equipment leak component contains or contacts organic liquids having 5 percent by weight or greater of the organic HAP listed in Table 1 to this subpart.

Low throughput transfer rack means those transfer racks that transfer into transport vehicles (for existing affected sources) or into transport vehicles and containers (for new affected sources) less than 11.8 million liters per year of organic liquids.

On-site or on site means, with respect to records required to be maintained by this subpart or required by another subpart referenced by this subpart, that records are stored at a location within a major source which encompasses the affected source. On-site includes, but is not limited to, storage at the affected source to which the records pertain, storage in central files elsewhere at the major source, or electronically available at the site.

Organic liquid means:

- (1) Any non-crude oil liquid or liquid mixture that contains 5 percent by weight or greater of the organic HAP listed in Table 1 to this subpart, as determined using the procedures specified in §63.2354(c).

(2) Any crude oils downstream of the first point of custody transfer.

(3) Organic liquids for purposes of this subpart do not include the following liquids:

(i) Gasoline (including aviation gasoline), kerosene (No. 1 distillate oil), diesel (No. 2 distillate oil), asphalt, and heavier distillate oils and fuel oils;

(ii) Any fuel consumed or dispensed on the plant site directly to users (such as fuels for fleet refueling or for refueling marine vessels that support the operation of the plant);

(iii) Hazardous waste;

(iv) Wastewater;

(v) Ballast water: or

(vi) Any non-crude oil liquid with an annual average true vapor pressure less than 0.7 kilopascals (0.1 psia).

Organic liquids distribution (OLD) operation means the combination of activities and equipment used to store or transfer organic liquids into, out of, or within a plant site regardless of the specific activity being performed. Activities include, but are not limited to, storage, transfer, blending, compounding, and packaging.

Permitting authority means one of the following:

(1) The State Air Pollution Control Agency, local agency, or other agency authorized by the EPA Administrator to carry out a permit program under 40 CFR part 70; or

(2) The EPA Administrator, in the case of EPA-implemented permit programs under title V of the CAA (42 U.S.C. 7661) and 40 CFR part 71.

Plant site means all contiguous or adjoining surface property that is under common control, including surface properties that are separated only by a road or other public right-of-way. Common control includes surface properties that are owned, leased, or operated by the same entity, parent entity, subsidiary, or any combination.

Research and development facility means laboratory and pilot plant operations whose primary purpose is to conduct research and development into new processes and products, where the operations are under the close supervision of technically trained personnel, and which are not engaged in the manufacture of products for commercial sale, except in a *de minimis* manner.

Responsible official means responsible official as defined in 40 CFR 70.2 and 40 CFR 71.2, as applicable.

Safety device means a closure device such as a pressure relief valve, frangible disc, fusible plug, or any other type of device that functions exclusively to prevent physical damage or permanent deformation to a unit or its air emission control equipment by venting gases or vapors directly to the atmosphere during unsafe conditions resulting from an unplanned, accidental, or emergency event.

Shutdown means the cessation of operation of an OLD affected source, or portion thereof (other than as part of normal operation of a batch-type operation), including equipment required or used to comply with this subpart, or the emptying and degassing of a storage tank. Shutdown as defined here includes, but is not limited to, events that result from periodic maintenance, replacement of equipment, or repair.

Startup means the setting in operation of an OLD affected source, or portion thereof (other than as part of normal operation of a batch-type operation), for any purpose. Startup also includes the placing in operation of any individual piece of equipment required or used to comply with this subpart including, but not limited to, control devices and monitors.

Storage tank means a stationary unit that is constructed primarily of nonearthen materials (such as wood, concrete, steel, or reinforced plastic) that provide structural support and is designed to hold a bulk quantity of liquid. Storage tanks do not include:

- (1) Units permanently attached to conveyances such as trucks, trailers, rail cars, barges, or ships;
- (2) Pressure vessels designed to operate in excess of 204.9 kilopascals and without emissions to the atmosphere;
- (3) Bottoms receivers;
- (4) Surge control vessels;
- (5) Vessels storing wastewater; or
- (6) Reactor vessels associated with a manufacturing process unit.

Tank car means a car designed to carry liquid freight by rail, and including a permanently attached tank.

Total actual annual facility-level organic liquid loading volume means the total facility-level actual volume of organic liquid loaded for transport within or out of the facility through transfer racks that are part of the affected source into transport vehicles (for existing affected sources) or into transport vehicles and containers (for new affected sources) based on a 3-year rolling average, calculated annually.

(1) For existing affected sources, each 3-year rolling average is based on actual facility-level loading volume during each calendar year (January 1 through December 31) in the 3-year period. For calendar year 2004 only (the first year of the initial 3-year rolling average), if an owner or operator of an affected source does not have actual loading volume data for the time period from January 1, 2004, through February 2, 2004 (the time period prior to the effective date of the OLD NESHP), the owner or operator shall compute a facility-level loading volume for this time period as follows: At the end of the 2004 calendar year, the owner or operator shall calculate a daily average facility-level loading volume (based on the actual loading volume for February 3, 2004, through December 31, 2004) and use that daily average to estimate the facility-level loading volume for the period of time from January 1, 2004, through February 2, 2004. The owner or operator shall then sum the estimated facility-level loading volume from January 1, 2004, through February 2, 2004, and the actual facility-level loading volume from February 3, 2004, through December 31, 2004, to calculate the annual facility-level loading volume for calendar year 2004.

(2)(i) For new affected sources, the 3-year rolling average is calculated as an average of three 12-month periods. An owner or operator must select as the beginning calculation date with which to start the calculations as either the initial startup date of the new affected source or the first day of the calendar month following the month in which startup occurs. Once selected, the date with which the calculations begin cannot be changed.

(ii) The initial 3-year rolling average is based on the projected maximum facility-level annual loading volume for each of the 3 years following the selected beginning calculation date. The second 3-year rolling average is based on actual facility-level loading volume for the first year of operation plus a new projected maximum facility-level annual loading volume for second and third years following the selected beginning calculation date. The third 3-year rolling average is based on actual facility-level loading volume for the first 2 years of operation plus a new projected maximum annual facility-level loading volume for the third year following the beginning calculation date. Subsequent 3-year rolling averages are based on actual facility-level loading volume for each year in the 3-year rolling average.

Transfer rack means a single system used to load organic liquids into, or unload organic liquids out of, transport vehicles or containers. It includes all loading and unloading arms, pumps, meters, shutoff valves, relief valves, and other piping and equipment necessary for the transfer operation. Transfer equipment and operations that are physically separate (i.e., do not share common piping, valves, and other equipment) are considered to be separate transfer racks.

Transport vehicle means a cargo tank or tank car.

Vapor balancing system means: (1) A piping system that collects organic HAP vapors displaced from transport vehicles or containers during loading and routes the collected vapors to the storage tank from which the liquid being loaded originated or to another storage tank connected to a common header. For containers, the piping system must route the displaced vapors directly to the appropriate storage tank or to another storage tank connected to a common header in order to qualify as a vapor balancing system; or (2) a piping system that collects organic HAP vapors displaced from the loading of a storage tank and routes the collected vapors to the transport vehicle from which the storage tank is filled.

Vapor collection system means any equipment located at the source (i.e., at the OLD operation) that is not open to the atmosphere; that is composed of piping, connections, and, if necessary, flow-inducing devices; and that is used for:

- (1) Containing and conveying vapors displaced during the loading of transport vehicles to a control device;
- (2) Containing and directly conveying vapors displaced during the loading of containers; or
- (3) Vapor balancing. This does not include any of the vapor collection equipment that is installed on the transport vehicle.

Vapor-tight transport vehicle means a transport vehicle that has been demonstrated to be vapor-tight. To be considered vapor-tight, a transport vehicle equipped with vapor collection equipment must undergo a pressure change of no more than 250 pascals (1 inch of water) within 5 minutes after it is pressurized to 4,500 pascals (18 inches of water). This capability must be demonstrated annually using the procedures specified in EPA Method 27 of 40 CFR part 60, appendix A. For all other transport vehicles, vapor tightness is demonstrated by performing the U.S. DOT pressure test procedures for tank cars and cargo tanks.

Work practice standard means any design, equipment, work practice, or operational standard, or combination thereof, that is promulgated pursuant to section 112(h) of the CAA.

[69 FR 5063, Feb. 3, 2004, as amended at 71 FR 42911, July 28, 2006]

Table 1 to Subpart EEEE of Part 63—Organic Hazardous Air Pollutants

You must use the organic HAP information listed in the following table to determine which of the liquids handled at your facility meet the HAP content criteria in the definition of Organic Liquid in §63.2406.

Compound name	CAS No. ¹
2,4-D salts and esters	94-75-7
Acetaldehyde	75-07-0
Acetonitrile	75-05-8
Acetophenone	98-86-2
Acrolein	107-02-8
Acrylamide	79-06-1
Acrylic acid	79-10-7
Acrylonitrile	107-13-1
Allyl chloride	107-05-1
Aniline	62-53-3
Benzene	71-43-2
Biphenyl	92-52-4
Butadiene (1,3-)	106-99-0

Carbon tetrachloride	56-23-5
Chloroacetic acid	79-11-8
Chlorobenzene	108-90-7
2-Chloro-1,3-butadiene (Chloroprene)	126-99-8
Chloroform	67-66-3
m-Cresol	108-39-4
o-Cresol	95-48-7
p-Cresol	106-44-5
Cresols/cresylic acid	1319-77-3
Cumene	98-82-8
Dibenzofurans	132-64-9
Dibutylphthalate	84-74-2
Dichloroethane (1,2-) (Ethylene dichloride) (EDC)	107-06-2
Dichloropropene (1,3-)	542-75-6
Diethanolamine	111-42-2
Diethyl aniline (N,N-)	121-69-7
Diethylene glycol monobutyl ether	112-34-5
Diethylene glycol monomethyl ether	111-77-3
Diethyl sulfate	64-67-5
Dimethyl formamide	68-12-2
Dimethylhydrazine (1,1-)	57-14-7
Dioxane (1,4-) (1,4-Diethyleneoxide)	123-91-1
Epichlorohydrin (1-Chloro-2,3-epoxypropane)	106-89-8
Epoxybutane (1,2-)	106-88-7
Ethyl acrylate	140-88-5
Ethylbenzene	100-41-4
Ethyl chloride (Chloroethane)	75-00-3
Ethylene dibromide (Dibromomethane)	106-93-4
Ethylene glycol	107-21-1
Ethylene glycol dimethyl ether	110-71-4
Ethylene glycol monomethyl ether	109-86-4
Ethylene glycol monomethyl ether acetate	110-49-6
Ethylene glycol monophenyl ether	122-99-6
Ethylene oxide	75-21-8
Ethylidene dichloride (1,1-Dichloroethane)	75-34-3
Formaldehyde	50-00-0
Hexachloroethane	67-72-1
Hexane	110-54-3
Hydroquinone	123-31-9
Isophorone	78-59-1

Maleic anhydride	108-31-6
Methanol	67-56-1
Methyl chloride (Chloromethane)	74-87-3
Methylene chloride (Dichloromethane)	75-09-2
Methylenedianiline (4,4'-)	101-77-9
Methylene diphenyl diisocyanate	101-68-8
Methyl hydrazine	60-34-4
Methyl isobutyl ketone (Hexone) (MIBK)	108-10-1
Methyl methacrylate	80-62-6
Methyl tert-butyl ether (MTBE)	1634-04-4
Naphthalene	91-20-3
Nitrobenzene	98-95-3
Phenol	108-9-52
Phthalic anhydride	85-44-9
Polycyclic organic matter	50-32-8
Propionaldehyde	123-38-6
Propylene dichloride (1,2-Dichloropropane)	78-87-5
Propylene oxide	75-56-9
Quinoline	91-22-5
Styrene	100-42-5
Styrene oxide	96-09-3
Tetrachloroethane (1,1,2,2-)	79-34-5
Tetrachloroethylene (Perchloroethylene)	127-18-4
Toluene	108-88-3
Toluene diisocyanate (2,4-)	584-84-9
o-Toluidine	95-53-4
Trichlorobenzene (1,2,4-)	120-82-1
Trichloroethane (1,1,1-) (Methyl chloroform)	71-55-6
Trichloroethane (1,1,2-) (Vinyl trichloride)	79-00-5
Trichloroethylene	79-01-6
Triethylamine	121-44-8
Trimethylpentane (2,2,4-)	540-84-1
Vinyl acetate	108-05-4
Vinyl chloride (Chloroethylene)	75-01-4
Vinylidene chloride (1,1-Dichloroethylene)	75-35-4
Xylene (m-)	108-38-3
Xylene (o-)	95-47-6
Xylene (p-)	106-42-3
Xylenes (isomers and mixtures)	1330-20-7

¹CAS numbers refer to the Chemical Abstracts Services registry number assigned to specific

compounds, isomers, or mixtures of compounds.

[69 FR 5063, Feb. 3, 2004, as amended at 71 FR 42913, July 28, 2006]

Table 2 to Subpart EEEE of Part 63—Emission Limits

As stated in §63.2346, you must comply with the emission limits for the organic liquids distribution emission sources as follows:

If you own or operate . . .	And if . . .	Then you must . . .
1. A storage tank at an existing affected source with a capacity \geq 18.9 cubic meters (5,000 gallons) and <189.3 cubic meters (50,000 gallons)	a. The stored organic liquid is not crude oil and if the annual average true vapor pressure of the total Table 1 organic HAP in the stored organic liquid is \geq 27.6 kilopascals (4.0 psia) and <76.6 kilopascals (11.1 psia)	i. Reduce emissions of total organic HAP (or, upon approval, TOC) by at least 95 weight-percent or, as an option, to an exhaust concentration less than or equal to 20 ppmv, on a dry basis corrected to 3 percent oxygen for combustion devices using supplemental combustion air, by venting emissions through a closed vent system to any combination of control devices meeting the applicable requirements of 40 CFR part 63, subpart SS; OR
		ii. Comply with the work practice standards specified in Table 4 to this subpart, items 1.a, 1.b, or 1.c for tanks storing liquids described in that table.
	b. The stored organic liquid is crude oil	i. See the requirement in item 1.a.i or 1.a.ii of this table.
2. A storage tank at an existing affected source with a capacity \geq 189.3 cubic meters (50,000 gallons).	a. The stored organic liquid is not crude oil and if the annual average true vapor pressure of the total Table 1 organic HAP in the stored organic liquid is <76.6 kilopascals (11.1 psia).	i. See the requirement in item 1.a.i or 1.a.ii of this table.
	b. The stored organic liquid is crude oil.	i. See the requirement in item 1.a.i or 1.a.ii of this table.
3. A storage tank at a	a. The stored	i. See the requirement in item 1.a.i

<p>reconstructed or new affected source with a capacity ≥ 18.9 cubic meters (5,000 gallons) and < 37.9 cubic meters (10,000 gallons).</p>	<p>organic liquid is not crude oil and if the annual average true vapor pressure of the total Table 1 organic HAP in the stored organic liquid is ≥ 27.6 kilopascals (4.0 psia) and < 76.6 kilopascals (11.1 psia).</p>	<p>or 1.a.ii of this table.</p>
	<p>b. The stored organic liquid is crude oil.</p>	<p>i. See the requirement in item 1.a.i or 1.a.ii of this table.</p>
<p>4. A storage tank at a reconstructed or new affected source with a capacity ≥ 37.9 cubic meters (10,000 gallons) and < 189.3 cubic meters (50,000 gallons).</p>	<p>a. The stored organic liquid is not crude oil and if the annual average true vapor pressure of the total Table 1 organic HAP in the stored organic liquid is ≥ 0.7 kilopascals (0.1 psia) and < 76.6 kilopascals (11.1 psia).</p>	<p>i. See the requirement in item 1.a.i or 1.a.ii of this table.</p>
	<p>b. The stored organic liquid is crude oil.</p>	<p>i. See the requirement in item 1.a.i or 1.a.ii of this table.</p>
<p>5. A storage tank at a reconstructed or new affected source with a capacity ≥ 189.3 cubic meters (50,000 gallons).</p>	<p>a. The stored organic liquid is not crude oil and if the annual average true vapor pressure of the total Table 1 organic HAP in the stored organic liquid is < 76.6 kilopascals (11.1 psia).</p>	<p>i. See the requirement in item 1.a.i or 1.a.ii of this table.</p>
	<p>b. The stored organic liquid is crude oil.</p>	<p>i. See the requirement in item 1.a.i or 1.a.ii of this table.</p>

6. A storage tank at an existing, reconstructed, or new affected source meeting the capacity criteria specified in Table 2 of this subpart, items 1 through 5	a. The stored organic liquid is not crude oil and if the annual average true vapor pressure of the total Table 1 organic HAP in the stored organic liquid is ≥ 76.6 kilopascals (11.1 psia)	i. Reduce emissions of total organic HAP (or, upon approval, TOC) by at least 95 weight-percent or, as an option, to an exhaust concentration less than or equal to 20 ppmv, on a dry basis corrected to 3 percent oxygen for combustion devices using supplemental combustion air, by venting emissions through a closed vent system to any combination of control devices meeting the applicable requirements of 40 CFR part 63, subpart SS; OR
		ii. Comply with the work practice standards specified in Table 4 to this subpart, item 2.a, for tanks storing the liquids described in that table.
7. A transfer rack at an existing facility where the total actual annual facility-level organic liquid loading volume through transfer racks is equal to or greater than 800,000 gallons and less than 10 million gallons	a. The total Table 1 organic HAP content of the organic liquid being loaded through one or more of the transfer rack's arms is at least 98 percent by weight and is being loaded into a transport vehicle	i. For all such loading arms at the rack, reduce emissions of total organic HAP (or, upon approval, TOC) from the loading of organic liquids either by venting the emissions that occur during loading through a closed vent system to any combination of control devices meeting the applicable requirements of 40 CFR part 63, subpart SS, achieving at least 98 weight-percent HAP reduction, OR, as an option, to an exhaust concentration less than or equal to 20 ppmv, on a dry basis corrected to 3 percent oxygen for combustion devices using supplemental combustion air; OR
		ii. During the loading of organic liquids, comply with the work practice standards specified in item 3 of Table 4 to this subpart.
8. A transfer rack at an existing facility where the total actual annual facility-level organic liquid loading volume through transfer racks is ≥ 10	a. One or more of the transfer rack's arms is loading an organic liquid into a transport vehicle	i. See the requirements in items 7.a.i and 7.a.ii of this table.

million gallons.		
9. A transfer rack at a new facility where the total actual annual facility-level organic liquid loading volume through transfer racks is less than 800,000 gallons	a. The total Table 1 organic HAP content of the organic liquid being loaded through one or more of the transfer rack's arms is at least 25 percent by weight and is being loaded into a transport vehicle	i. See the requirements in items 7.a.i and 7.a.ii of this table.
	b. One or more of the transfer rack's arms is filling a container with a capacity equal to or greater than 55 gallons	i. For all such loading arms at the rack during the loading of organic liquids, comply with the provisions of §§63.924 through 63.927 of 40 CFR part 63, Subpart PP— National Emission Standards for Containers, Container Level 3 controls; OR ii. During the loading of organic liquids, comply with the work practice standards specified in item 3.a of Table 4 to this subpart.
10. A transfer rack at a new facility where the total actual annual facility-level organic liquid loading volume through transfer racks is equal to or greater than 800,000 gallons	a. One or more of the transfer rack's arms is loading an organic liquid into a transport vehicle	i. See the requirements in items 7.a.i and 7.a.ii of this table.
	b. One or more of the transfer rack's arms is filling a container with a capacity equal to or greater than 55 gallons	i. For all such loading arms at the rack during the loading of organic liquids, comply with the provisions of §§63.924 through 63.927 of 40 CFR part 63, Subpart PP— National Emission Standards for Containers, Container Level 3 controls; OR
		ii. During the loading of organic liquids, comply with the work practice standards specified in item 3.a of Table 4 to this subpart.

[69 FR 5063, Feb. 3, 2004, as amended at 71 FR 42913, July 28, 2006]

Table 3 to Subpart EEEE of Part 63—Operating Limits—High Throughput Transfer Racks

As stated in §63.2346(e), you must comply with the operating limits for existing, reconstructed, or new affected sources as follows:

For each existing, each reconstructed, and each new affected source using . . .	You must . . .
1. A thermal oxidizer to comply with an emission limit in Table 2 to this subpart	Maintain the daily average fire box or combustion zone temperature greater than or equal to the reference temperature established during the design evaluation or performance test that demonstrated compliance with the emission limit.
2. A catalytic oxidizer to comply with an emission limit in Table 2 to this subpart	a. Replace the existing catalyst bed before the age of the bed exceeds the maximum allowable age established during the design evaluation or performance test that demonstrated compliance with the emission limit; AND
	b. Maintain the daily average temperature at the inlet of the catalyst bed greater than or equal to the reference temperature established during the design evaluation or performance test that demonstrated compliance with the emission limit; AND
	c. Maintain the daily average temperature difference across the catalyst bed greater than or equal to the minimum temperature difference established during the design evaluation or performance test that demonstrated compliance with the emission limit.
3. An absorber to comply with an emission limit in Table 2 to this subpart	a. Maintain the daily average concentration level of organic compounds in the absorber exhaust less than or equal to the reference concentration established during the design evaluation or performance test that demonstrated compliance with the emission limit; OR
	b. Maintain the daily average scrubbing liquid temperature less than or equal to the reference temperature established during the design evaluation or performance test that demonstrated compliance with the emission limit; AND
	Maintain the difference between the specific gravities of the saturated and fresh scrubbing fluids greater than or equal to the difference established during the design evaluation or

	performance test that demonstrated compliance with the emission limit.
4. A condenser to comply with an emission limit in Table 2 to this subpart	a. Maintain the daily average concentration level of organic compounds at the condenser exit less than or equal to the reference concentration established during the design evaluation or performance test that demonstrated compliance with the emission limit; OR
	b. Maintain the daily average condenser exit temperature less than or equal to the reference temperature established during the design evaluation or performance test that demonstrated compliance with the emission limit.
5. An adsorption system with adsorbent regeneration to comply with an emission limit in Table 2 to this subpart	a. Maintain the daily average concentration level of organic compounds in the adsorber exhaust less than or equal to the reference concentration established during the design evaluation or performance test that demonstrated compliance with the emission limit; OR
	b. Maintain the total regeneration stream mass flow during the adsorption bed regeneration cycle greater than or equal to the reference stream mass flow established during the design evaluation or performance test that demonstrated compliance with the emission limit; AND
	Before the adsorption cycle commences, achieve and maintain the temperature of the adsorption bed after regeneration less than or equal to the reference temperature established during the design evaluation or performance test that demonstrated compliance with the emission limit; AND
	Achieve a pressure reduction during each adsorption bed regeneration cycle greater than or equal to the pressure reduction established during the design evaluation or performance test that demonstrated compliance with the emission limit.
6. An adsorption system without adsorbent regeneration to comply with an emission limit in Table 2 to this subpart	a. Maintain the daily average concentration level of organic compounds in the adsorber exhaust less than or equal to the reference concentration established during the design evaluation or performance test that demonstrated compliance with the emission limit; OR
	b. Replace the existing adsorbent in each segment of the bed with an adsorbent that meets the replacement specifications established during the design evaluation or performance test before the age of the adsorbent exceeds the maximum

	allowable age established during the design evaluation or performance test that demonstrated compliance with the emission limit; AND
	Maintain the temperature of the adsorption bed less than or equal to the reference temperature established during the design evaluation or performance test that demonstrated compliance with the emission limit.
7. A flare to comply with an emission limit in Table 2 to this subpart	a. Comply with the equipment and operating requirements in §63.987(a); AND b. Conduct an initial flare compliance assessment in accordance with §63.987(b); AND
	c. Install and operate monitoring equipment as specified in §63.987(c).
8. Another type of control device to comply with an emission limit in Table 2 to this subpart	Submit a monitoring plan as specified in §§63.995 (c) and 63.2366(b), and monitor the control device in accordance with that plan.

[69 FR 5063, Feb. 3, 2004, as amended at 71 FR 42914, July 28, 2006]

Table 4 to Subpart EEEE of Part 63—Work Practice Standards

As stated in §63.2346, you may elect to comply with one of the work practice standards for existing, reconstructed, or new affected sources in the following table. If you elect to do so, . . .

For each . . .	You must . . .
1. Storage tank at an existing, reconstructed, or new affected source meeting any set of tank capacity and organic HAP vapor pressure criteria specified in Table 2 to this subpart, items 1 through 5	a. Comply with the requirements of 40 CFR part 63, subpart WW (control level 2), if you elect to meet 40 CFR part 63, subpart WW (control level 2) requirements as an alternative to the emission limit in Table 2 to this subpart, items 1 through 5; OR
	b. Comply with the requirements of §63.984 for routing emissions to a fuel gas system or back to a process; OR
	c. Comply with the requirements of §63.2346(a)(4) for vapor balancing emissions to the transport vehicle from which the storage tank is filled.
2. Storage tank at an existing, reconstructed, or new affected source meeting any set of tank capacity and organic HAP vapor pressure criteria specified in Table 2 to this subpart, item 6	a. Comply with the requirements of §63.984 for routing emissions to a fuel gas system or back to a process; OR b. Comply with the requirements of §63.2346(a)(4) for vapor balancing emissions to the transport vehicle from which the storage tank is filled.

3. Transfer rack subject to control based on the criteria specified in Table 2 to this subpart, items 7 through 10, at an existing, reconstructed, or new affected source	a. If the option of a vapor balancing system is selected, install and, during the loading of organic liquids, operate a system that meets the requirements in Table 7 to this subpart, item 3.b.i and item 3.b.ii, as applicable; OR
	b. Comply with the requirements of §63.984 during the loading of organic liquids, for routing emissions to a fuel gas system or back to a process.
4. Pump, valve, and sampling connection that operates in organic liquids service at least 300 hours per year at an existing, reconstructed, or new affected source	Comply with the requirements for pumps, valves, and sampling connections in 40 CFR part 63, subpart TT (control level 1), subpart UU (control level 2), or subpart H.
5. Transport vehicles equipped with vapor collection equipment that are loaded at transfer racks that are subject to control based on the criteria specified in Table 2 to this subpart, items 7 through 10	Follow the steps in 40 CFR 60.502(e) to ensure that organic liquids are loaded only into vapor-tight transport vehicles, and comply with the provisions in 40 CFR 60.502(f), (g), (h), and (i), except substitute the term transport vehicle at each occurrence of tank truck or gasoline tank truck in those paragraphs.
6. Transport vehicles equipped without vapor collection equipment that are loaded at transfer racks that are subject to control based on the criteria specified in Table 2 to this subpart, items 7 through 10	Ensure that organic liquids are loaded only into transport vehicles that have a current certification in accordance with the U.S. DOT pressure test requirements in 49 CFR 180 (cargo tanks) or 49 CFR 173.31 (tank cars).

[71 FR 42915, July 28, 2006]

Table 5 to Subpart EEEE of Part 63—Requirements for Performance Tests and Design Evaluations

As stated in §§63.2354(a) and 63.2362, you must comply with the requirements for performance tests and design evaluations for existing, reconstructed, or new affected sources as follows:

For ...	You must conduct ...	According to ...	Using ...	To determine ..	According to the following requirements ..
1. Each existing, each reconstructed, and each new	a. A performance test to determine	i. §63.985(b)(1)(ii), §63.988(b), §63.990(b),	(1) EPA Method 1 or 1A in appendix A	(A) Sampling port locations and the required	(i) Sampling sites must be located at the inlet and outlet

affected source using a nonflare control device to comply with an emission limit in Table 2 to this subpart, items 1 through 10	the organic HAP (or, upon approval, TOC) control efficiency of each nonflare control device, OR the exhaust concentration of each combustion device; OR	or §63.995(b)	of 40 CFR part 60, as appropriate	number of traverse points	of each control device if complying with the control efficiency requirement or at the outlet of the control device if complying with the exhaust concentration requirement; AND (ii) The outlet sampling site must be located at each control device prior to any releases to the atmosphere.
			(2) EPA Method 2, 2A, 2C, 2D, 2F, or 2G in appendix A of 40 CFR part 60, as appropriate	(A) Stack gas velocity and volumetric flow rate	See the requirements in items 1.a.i.(1) (A)(i) and (ii) of this table.
			(3) EPA Method 3 or 3B in appendix A of 40 CFR part 60, as appropriate	(A) Concentration of CO ₂ and O ₂ and dry molecular weight of the stack gas	See the requirements in items 1.a.i.(1) (A)(i) and (ii) of this table.
			(4) EPA Method 4 in appendix A of 40 CFR part 60	(A) Moisture content of the stack gas	See the requirements in items 1.a.i.(1) (A)(i) and (ii) of this table.
			(5) EPA Method 18, 25, or 25A in appendix A of 40 CFR part 60, as	(A) Total organic HAP (or, upon approval, TOC), or formaldehyde	(i) The organic HAP used for the calibration gas for EPA Method 25A must be the

			appropriate, or EPA Method 316 in appendix A of 40 CFR part 63 for measuring formaldehyde	emissions	single organic HAP representing the largest percent by volume of emissions; AND (ii) During the performance test, you must establish the operating parameter limits within which total organic HAP (or, upon approval, TOC) emissions are reduced by the required weight-percent or, as an option for nonflare combustion devices, to 20 ppmv exhaust concentration.
		b. A design evaluation (for nonflare control devices) to determine the organic HAP (or, upon approval, TOC) control efficiency of each nonflare control device, or the exhaust concentration of each combustion	§63.985(b)(1)(i).		During a design evaluation, you must establish the operating parameter limits within which total organic HAP, (or, upon approval, TOC) emissions are reduced by at least 95 weight-percent for storage tanks or 98 weight-percent for transfer racks, or, as an

		control device.			option for nonflare combustion devices, to 20 ppmv exhaust concentration.
2. Each transport vehicle that you own that is equipped with vapor collection equipment and is loaded with organic liquids at a transfer rack that is subject to control based on the criteria specified in Table 2 to this subpart, items 7 through 10, at an existing, reconstructed, or new affected source	A performance test to determine the vapor tightness of the tank and then repair as needed until it passes the test.		EPA Method 27 in appendix A of 40 CFR part 60	Vapor tightness	The pressure change in the tank must be no more than 250 pascals (1 inch of water) in 5 minutes after it is pressurized to 4,500 pascals (18 inches of water).

[71 FR 42916, July 28, 2006]

Table 6 to Subpart EEEE of Part 63—Initial Compliance With Emission Limits

As stated in §§63.2370(a) and 63.2382(b), you must show initial compliance with the emission limits for existing, reconstructed, or new affected sources as follows:

For each . . .	For the following emission limit . . .	You have demonstrated initial compliance if . . .
1. Storage tank at an existing, reconstructed, or new affected source meeting either set of tank capacity and liquid organic HAP	Reduce total organic HAP (or, upon approval, TOC) emissions by at least 95 weight-percent, or as an option for combustion devices to	Total organic HAP (or, upon approval, TOC) emissions, based on the results of the performance testing or design evaluation specified in Table 5 to this subpart, item 1.a or 1.b, respectively, are reduced by

vapor pressure criteria specified in Table 2 to this subpart, items 1 through 6	an exhaust concentration of ≤ 20 ppmv	at least 95 weight-percent or as an option for nonflare combustion devices to an exhaust concentration ≤ 20 ppmv.
2. Transfer rack that is subject to control based on the criteria specified in Table 2 to this subpart, items 7 through 10, at an existing, reconstructed, or new affected source	Reduce total organic HAP (or, upon approval, TOC) emissions from the loading of organic liquids by at least 98 weight-percent, or as an option for nonflare combustion devices to an exhaust concentration of ≤ 20 ppmv	Total organic HAP (or, upon approval, TOC) emissions from the loading of organic liquids, based on the results of the performance testing or design evaluation specified in Table 5 to this subpart, item 1.a or 1.b, respectively, are reduced by at least 98 weight-percent or as an option for nonflare combustion devices to an exhaust concentration of ≤ 20 ppmv.

[71 FR 42918, July 28, 2006]

Table 7 to Subpart EEEE of Part 63—Initial Compliance With Work Practice Standards

For each . . .	If you . . .	You have demonstrated initial compliance if . . .
1. Storage tank at an existing affected source meeting either set of tank capacity and liquid organic HAP vapor pressure criteria specified in Table 2 to this subpart, items 1 or 2	a. Install a floating roof or equivalent control that meets the requirements in Table 4 to this subpart, item 1.a	i. After emptying and degassing, you visually inspect each internal floating roof before the refilling of the storage tank and perform seal gap inspections of the primary and secondary rim seals of each external floating roof within 90 days after the refilling of the storage tank.
	b. Route emissions to a fuel gas system or back to a process	i. You meet the requirements in §63.984(b) and submit the statement of connection required by §63.984(c).
	c. Install and, during the filling of the storage tank with organic liquids, operate a vapor balancing system	i. You meet the requirements in §3.2346(a)(4).
2. Storage tank at a reconstructed or new	a. Install a floating roof or equivalent	i. You visually inspect each internal floating roof before the

affected source meeting any set of tank capacity and liquid organic HAP vapor pressure criteria specified in Table 2 to this subpart, items 3 through 5	control that meets the requirements in Table 4 to this subpart, item 1.a	initial filling of the storage tank, and perform seal gap inspections of the primary and secondary rim seals of each external floating roof within 90 days after the initial filling of the storage tank.
	b. Route emissions to a fuel gas system or back to a process	i. See item 1.b.i of this table.
	c. Install and, during the filling of the storage tank with organic liquids, operate a vapor balancing system	i. See item 1.c.i of this table.
3. Transfer rack that is subject to control based on the criteria specified in Table 2 to this subpart, items 7 through 10, at an existing, reconstructed, or new affected source	a. Load organic liquids only into transport vehicles having current vapor tightness certification as described in Table 4 to this subpart, item 5 and item 6	i. You comply with the provisions specified in Table 4 to this subpart, item 5 or item 6, as applicable.
	b. Install and, during the loading of organic liquids, operate a vapor balancing system	i. You design and operate the vapor balancing system to route organic HAP vapors displaced from loading of organic liquids into transport vehicles to the storage tank from which the liquid being loaded originated or to another storage tank connected to a common header. ii. You design and operate the vapor balancing system to route organic HAP vapors displaced from loading of organic liquids into containers directly (e.g., no intervening tank or containment area such as a room) to the storage tank from which the liquid being loaded originated or to another storage tank connected to a common header.

	c. Route emissions to a fuel gas system or back to a process	i. See item 1.b.i of this table.
4. Equipment leak component, as defined in §63.2406, that operates in organic liquids service ≥300 hours per year at an existing, reconstructed, or new affected source	a. Carry out a leak detection and repair program or equivalent control according to one of the subparts listed in Table 4 to this subpart, item 4.a	i. You specify which one of the control programs listed in Table 4 to this subpart you have selected, OR ii. Provide written specifications for your equivalent control approach.

[71 FR 42918, July 28, 2006]

Table 8 to Subpart EEEE of Part 63—Continuous Compliance With Emission Limits

As stated in §§63.2378(a) and (b) and 63.2390(b), you must show continuous compliance with the emission limits for existing, reconstructed, or new affected sources according to the following table:

For each . . .	For the following emission limit . . .	You must demonstrate continuous compliance by . . .
1. Storage tank at an existing, reconstructed, or new affected source meeting any set of tank capacity and liquid organic HAP vapor pressure criteria specified in Table 2 to this subpart, items 1 through 6	a. Reduce total organic HAP (or, upon approval, TOC) emissions from the closed vent system and control device by 95 weight-percent or greater, or as an option to 20 ppmv or less of total organic HAP (or, upon approval, TOC) in the exhaust of combustion devices	i. Performing CMS monitoring and collecting data according to §§63.2366, 63.2374, and 63.2378; AND ii. Maintaining the operating limits established during the design evaluation or performance test that demonstrated compliance with the emission limit.
2. Transfer rack that is subject to control based on the criteria specified in Table 2 to this subpart, items 7 through 10, at an existing, reconstructed, or new affected source	a. Reduce total organic HAP (or, upon approval, TOC) emissions during the loading of organic liquids from the closed vent system and control device by 98 weight-percent or greater, or as an option to 20 ppmv or less of total organic HAP (or, upon approval, TOC) in the exhaust of combustion	i. Performing CMS monitoring and collecting data according to §§63.2366, 63.2374, and 63.2378 during the loading of organic liquids; AND ii. Maintaining the operating limits established during the design evaluation or

	devices	performance test that demonstrated compliance with the emission limit during the loading of organic liquids.
--	---------	--

[71 FR 42919, July 28, 2006]

Table 9 to Subpart EEEE of Part 63—Continuous Compliance With Operating Limits—High Throughput Transfer Racks

As stated in §63.2378(a) and (b) and 63.2390(b), you must show continuous compliance with the operating limits for existing, reconstructed, or new affected sources according to the following table:

For each existing, reconstructed, and each new affected source using . . .	For the following operating limit . . .	You must demonstrate continuous compliance by . . .
1. A thermal oxidizer to comply with an emission limit in Table 2 to this subpart.	a. Maintain the daily average fire box or combustion zone, as applicable, temperature greater than or equal to the reference temperature established during the design evaluation or performance test that demonstrated compliance with the emission limit.	i. Continuously monitoring and recording fire box or combustion zone, as applicable, temperature every 15 minutes and maintaining the daily average fire box temperature greater than or equal to the reference temperature established during the design evaluation or performance test that demonstrated compliance with the emission limit; AND ii. Keeping the applicable records required in §63.998.
2. A catalytic oxidizer to comply with an emission limit in Table 2 to this subpart	a. Replace the existing catalyst bed before the age of the bed exceeds the maximum allowable age established during the design evaluation or performance test that demonstrated compliance with the emission limit; AND	i. Replacing the existing catalyst bed before the age of the bed exceeds the maximum allowable age established during the design evaluation or performance test that demonstrated compliance with the emission limit; AND ii. Keeping the applicable records required in §63.998.
	b. Maintain the daily average temperature at the inlet of the catalyst	i. Continuously monitoring and recording the temperature at the inlet of the catalyst bed at

	bed greater than or equal to the reference temperature established during the design evaluation or performance test that demonstrated compliance with the emission limit; AND	least every 15 minutes and maintaining the daily average temperature at the inlet of the catalyst bed greater than or equal to the reference temperature established during the design evaluation or performance test that demonstrated compliance with the emission limit; AND ii. Keeping the applicable records required in §63.998.
	c. Maintain the daily average temperature difference across the catalyst bed greater than or equal to the minimum temperature difference established during the design evaluation or performance test that demonstrated compliance with the emission limit	i. Continuously monitoring and recording the temperature at the outlet of the catalyst bed every 15 minutes and maintaining the daily average temperature difference across the catalyst bed greater than or equal to the minimum temperature difference established during the design evaluation or performance test that demonstrated compliance with the emission limit; AND ii. Keeping the applicable records required in §63.998.
3. An absorber to comply with an emission limit in Table 2 to this subpart	a. Maintain the daily average concentration level of organic compounds in the absorber exhaust less than or equal to the reference concentration established during the design evaluation or performance test that demonstrated compliance with the emission limit; OR	i. Continuously monitoring the organic concentration in the absorber exhaust and maintaining the daily average concentration less than or equal to the reference concentration established during the design evaluation or performance test that demonstrated compliance with the emission limit; AND ii. Keeping the applicable records required in §63.998.
	b. Maintain the daily average scrubbing liquid temperature less than or equal to the reference temperature established during the design evaluation or performance test that	i. Continuously monitoring the scrubbing liquid temperature and maintaining the daily average temperature less than or equal to the reference temperature established during the design evaluation or performance test that

	demonstrated compliance with the emission limit; AND Maintain the difference between the specific gravities of the saturated and fresh scrubbing fluids greater than or equal to the difference established during the design evaluation or performance test that demonstrated compliance with the emission limit	demonstrated compliance with the emission limit; AND ii. Maintaining the difference between the specific gravities greater than or equal to the difference established during the design evaluation or performance test that demonstrated compliance with the emission limit; AND iii. Keeping the applicable records required in §63.998.
4. A condenser to comply with an emission limit in Table 2 to this subpart	a. Maintain the daily average concentration level of organic compounds at the exit of the condenser less than or equal to the reference concentration established during the design evaluation or performance test that demonstrated compliance with the emission limit; OR	i. Continuously monitoring the organic concentration at the condenser exit and maintaining the daily average concentration less than or equal to the reference concentration established during the design evaluation or performance test that demonstrated compliance with the emission limit; AND ii. Keeping the applicable records required in §63.998.
	b. Maintain the daily average condenser exit temperature less than or equal to the reference temperature established during the design evaluation or performance test that demonstrated compliance with the emission limit	i. Continuously monitoring and recording the temperature at the exit of the condenser at least every 15 minutes and maintaining the daily average temperature less than or equal to the reference temperature established during the design evaluation or performance test that demonstrated compliance with the emission limit; AND ii. Keeping the applicable records required in §63.998.
5. An adsorption system with adsorbent regeneration to comply with an emission limit in Table 2 to this	a. Maintain the daily average concentration level of organic compounds in the adsorber exhaust less than or equal to the reference concentration	i. Continuously monitoring the daily average organic concentration in the adsorber exhaust and maintaining the concentration less than or equal to the reference concentration established

subpart	established during the design evaluation or performance test that demonstrated compliance with the emission limit; OR	during the design evaluation or performance test that demonstrated compliance with the emission limit; AND ii. Keeping the applicable records required in §63.998.
	b. Maintain the total regeneration stream mass flow during the adsorption bed regeneration cycle greater than or equal to the reference stream mass flow established during the design evaluation or performance test that demonstrated compliance with the emission limit; AND Before the adsorption cycle commences, achieve and maintain the temperature of the adsorption bed after regeneration less than or equal to the reference temperature established during the design evaluation or performance test; AND Achieve greater than or equal to the pressure reduction during the adsorption bed regeneration cycle established during the design evaluation or performance test that demonstrated compliance with the emission limit	i. Maintaining the total regeneration stream mass flow during the adsorption bed regeneration cycle greater than or equal to the reference stream mass flow established during the design evaluation or performance test that demonstrated compliance with the emission limit; AND ii. Maintaining the temperature of the adsorption bed after regeneration less than or equal to the reference temperature established during the design evaluation or performance test that demonstrated compliance with the emission limit; AND iii. Achieving greater than or equal to the pressure reduction during the regeneration cycle established during the design evaluation or performance test that demonstrated compliance with the emission limit; AND iv. Keeping the applicable records required in §63.998.
6. An adsorption system without adsorbent regeneration to comply with an emission limit in Table 2 to this	a. Maintain the daily average concentration level of organic compounds in the adsorber exhaust less than or equal to the reference concentration	i. Continuously monitoring the organic concentration in the adsorber exhaust and maintaining the concentration less than or equal to the reference concentration established during the design

subpart	established during the design evaluation or performance test that demonstrated compliance with the emission limit; OR	evaluation or performance test that demonstrated compliance with the emission limit; AND ii. Keeping the applicable records required in §63.998.
	b. Replace the existing adsorbent in each segment of the bed before the age of the adsorbent exceeds the maximum allowable age established during the design evaluation or performance test that demonstrated compliance with the emission limit; AND Maintain the temperature of the adsorption bed less than or equal to the reference temperature established during the design evaluation or performance test that demonstrated compliance with the emission limit	i. Replacing the existing adsorbent in each segment of the bed with an adsorbent that meets the replacement specifications established during the design evaluation or performance test before the age of the adsorbent exceeds the maximum allowable age established during the design evaluation or performance test that demonstrated compliance with the emission limit; AND ii. Maintaining the temperature of the adsorption bed less than or equal to the reference temperature established during the design evaluation or performance test that demonstrated compliance with the emission limit; AND iii. Keeping the applicable records required in §63.998.
7. A flare to comply with an emission limit in Table 2 to this subpart	a. Maintain a pilot flame in the flare at all times that vapors may be vented to the flare (§63.11(b)(5)); AND	i. Continuously operating a device that detects the presence of the pilot flame; AND ii. Keeping the applicable records required in §63.998.
	b. Maintain a flare flame at all times that vapors are being vented to the flare (§63.11(b)(5)); AND	i. Maintaining a flare flame at all times that vapors are being vented to the flare; AND ii. Keeping the applicable records required in §63.998.
	c. Operate the flare with no visible emissions, except for up to 5 minutes in any 2 consecutive hours (§63.11(b)(4)); AND EITHER	i. Operating the flare with no visible emissions exceeding the amount allowed; AND ii. Keeping the applicable records required in §63.998.

	d.1. Operate the flare with an exit velocity that is within the applicable limits in §63.11(b)(7) and (8) and with a net heating value of the gas being combusted greater than the applicable minimum value in §63.11(b)(6)(ii); OR	i. Operating the flare within the applicable exit velocity limits; AND ii. Operating the flare with the gas heating value greater than the applicable minimum value; AND iii. Keeping the applicable records required in §63.998.
	d.2. Adhere to the requirements in §63.11(b)(6)(i)	i. Operating the flare within the applicable limits in 63.11(b)(6)(i); AND ii. Keeping the applicable records required in §63.998.
8. Another type of control device to comply with an emission limit in Table 2 to this subpart.	Submit a monitoring plan as specified in §§63.995(c) and 63.2366(c), and monitor the control device in accordance with that plan.	Submitting a monitoring plan and monitoring the control device according to that plan.

[69 FR 5063, Feb. 3, 2004, as amended at 71 FR 42919, July 28, 2006]

Table 10 to Subpart EEEE of Part 63—Continuous Compliance With Work Practice Standards

As stated in §§63.2378(a) and (b) and 63.2386(c)(6), you must show continuous compliance with the work practice standards for existing, reconstructed, or new affected sources according to the following table:

For each . . .	For the following standard . . .	You must demonstrate continuous compliance by . . .
1. Internal floating roof (IFR) storage tank at an existing, reconstructed, or new affected source meeting any set of tank capacity, and vapor pressure criteria specified in Table 2 to this subpart, items 1 through 5	a. Install a floating roof designed and operated according to the applicable specifications in §63.1063(a) and (b)	i. Visually inspecting the floating roof deck, deck fittings, and rim seals of each IFR once per year (§63.1063(d)(2)); AND ii. Visually inspecting the floating roof deck, deck fittings, and rim seals of each IFR either each time the storage tank is completely emptied and degassed or every 10 years, whichever occurs first (§63.1063(c)(1), (d)(1), and (e)); AND iii. Keeping the tank records required in §63.1065.
2. External floating roof (EFR) storage	a. Install a floating roof designed and	i. Visually inspecting the floating roof deck, deck fittings, and rim

<p>tank at an existing, reconstructed, or new affected source meeting any set of tank capacity and vapor pressure criteria specified in Table 2 to this subpart, items 1 through 5</p>	<p>operated according to the applicable specifications in §63.1063(a) and (b)</p>	<p>seals of each EFR either each time the storage tank is completely emptied and degassed or every 10 years, whichever occurs first (§63.1063(c)(2), (d), and (e)); AND ii. Performing seal gap measurements on the secondary seal of each EFR at least once every year, and on the primary seal of each EFR at least every 5 years (§63.1063(c)(2), (d), and (e)); AND iii. Keeping the tank records required in §63.1065.</p>
<p>3. IFR or EFR tank at an existing, reconstructed, or new affected source meeting any set of tank capacity and vapor pressure criteria specified in Table 2 to this subpart, items 1 through 5.</p>	<p>a. Repair the conditions causing storage tank inspection failures (§63.1063(e)).</p>	<p>i. Repairing conditions causing inspection failures: before refilling the storage tank with organic liquid, or within 45 days (or up to 105 days with extensions) for a tank containing organic liquid; AND ii. Keeping the tank records required in §63.1065(b).</p>
<p>4. Transfer rack that is subject to control based on the criteria specified in Table 2 to this subpart, items 7 through 10, at an existing, reconstructed, or new affected source</p>	<p>a. Ensure that organic liquids are loaded into transport vehicles in accordance with the requirements in Table 4 to this subpart, items 5 or 6, as applicable</p>	<p>i. Ensuring that organic liquids are loaded into transport vehicles in accordance with the requirements in Table 4 to this subpart, items 5 or 6, as applicable.</p>
	<p>b. Install and, during the loading of organic liquids, operate a vapor balancing system</p>	<p>i. Monitoring each potential source of vapor leakage in the system quarterly during the loading of a transport vehicle or the filling of a container using the methods and procedures described in the rule requirements selected for the work practice standard for equipment leak components as specified in Table 4 to this subpart, item 4. An instrument reading of 500 ppmv defines a leak. Repair of leaks is performed according to the repair requirements specified in your</p>

		selected equipment leak standards.
	c. Route emissions to a fuel gas system or back to a process	i. Continuing to meet the requirements specified in §63.984 (b).
5. Equipment leak component, as defined in §63.2406, that operates in organic liquids service at least 300 hours per year	a. Comply with the requirements of 40 CFR part 63, subpart TT, UU, or H	i. Carrying out a leak detection and repair program in accordance with the subpart selected from the list in item 5.a of this table.
6. Storage tank at an existing, reconstructed, or new affected source meeting any of the tank capacity and vapor pressure criteria specified in Table 2 to this subpart, items 1 through 6	a. Route emissions to a fuel gas system or back to the process	i. Continuing to meet the requirements specified in §63.984 (b).
	b. Install and, during the filling of the storage tank with organic liquids, operate a vapor balancing system	i. Monitoring each potential source of vapor leakage in the system quarterly during the loading of a transport vehicle or the filling of a container using the methods and procedures described in the rule requirements selected for the work practice standard for equipment leak components as specified in Table 4 to this subpart, item 4. An instrument reading of 500 ppmv defines a leak. Repair of leaks is performed according to the repair requirements specified in your selected equipment leak standards.

[69 FR 5063, Feb. 3, 2004, as amended at 71 FR 42922, July 28, 2006]

Table 11 to Subpart EEEE of Part 63—Requirements for Reports

As stated in §63.2386(a), (b), and (f), you must submit compliance reports and startup, shutdown, and malfunction reports according to the following table:

You must submit a(n) .	The report must contain .	You must submit the
-------------------------------	----------------------------------	----------------------------

..	..	report ...
1. Compliance report or Periodic Report	a. The information specified in §63.2386(c), (d), (e). If you had a SSM during the reporting period and you took actions consistent with your SSM plan, the report must also include the information in §63.10(d)(5)(i); AND	Semiannually, and it must be postmarked by January 31 or July 31, in accordance with §63.2386(b).
	b. The information required by 40 CFR part 63, subpart TT, UU, or H, as applicable, for pumps, valves, and sampling connections; AND	See the submission requirement in item 1.a of this table.
	c. The information required by §63.999(c); AND	See the submission requirement in item 1.a of this table.
	d. The information specified in §63.1066(b) including: Notification of inspection, inspection results, requests for alternate devices, and requests for extensions, as applicable.	See the submission requirement in item 1.a of this table.
2. Immediate SSM report if you had a SSM that resulted in an applicable emission standard in the relevant standard being exceeded, and you took an action that was not consistent with your SSM plan	a. The information required in §63.10(d)(5)(ii)	i. By letter within 7 working days after the end of the event unless you have made alternative arrangements with the permitting authority (§63.10(d)(5)(ii)).

[71 FR 42923, July 28, 2006]

Table 12 to Subpart EEEE of Part 63—Applicability of General Provisions to Subpart EEEE

As stated in §§63.2382 and 63.2398, you must comply with the applicable General Provisions requirements as follows:

Citation	Subject	Brief description	Applies to subpart EEEE

§63.1	Applicability	Initial applicability determination; Applicability after standard established; Permit requirements; Extensions, Notifications	Yes.
§63.2	Definitions	Definitions for part 63 standards	Yes.
§63.3	Units and Abbreviations	Units and abbreviations for part 63 standards	Yes.
§63.4	Prohibited Activities and Circumvention	Prohibited activities; Circumvention, Severability	Yes.
§63.5	Construction/Reconstruction	Applicability; Applications; Approvals	Yes.
§63.6(a)	Compliance with Standards/O&M Applicability	GP apply unless compliance extension; GP apply to area sources that become major	Yes.
§63.6(b)(1)–(4)	Compliance Dates for New and Reconstructed Sources	Standards apply at effective date; 3 years after effective date; upon startup; 10 years after construction or reconstruction commences for section 112(f)	Yes.
§63.6(b)(5)	Notification	Must notify if commenced construction or reconstruction after proposal	Yes.
§63.6(b)(6)	[Reserved].		
§63.6(b)(7)	Compliance Dates for New and Reconstructed Area Sources That Become Major	Area sources that become major must comply with major source standards immediately upon becoming major, regardless of whether required to comply when they were an area source	Yes.
§63.6(c)(1)–(2)	Compliance Dates for Existing Sources	Comply according to date in this subpart, which must be no later than 3 years after effective date; for section 112(f) standards, comply within 90 days of effective date unless compliance extension	Yes.
§63.6(c)	[Reserved].		

(3)–(4)			
§63.6(c) (5)	Compliance Dates for Existing Area Sources That Become Major	Area sources that become major must comply with major source standards by date indicated in this subpart or by equivalent time period (e.g ., 3 years)	Yes.
§63.6(d)	[Reserved].		
§63.6(e) (1)	Operation & Maintenance	Operate to minimize emissions at all times; correct malfunctions as soon as practicable; and operation and maintenance requirements independently enforceable; information Administrator will use to determine if operation and maintenance requirements were met	Yes.
§63.6(e) (2)	[Reserved].		
§63.6(e) (3)	SSM Plan	Requirement for SSM plan; content of SSM plan; actions during SSM	Yes; however, (1) the 2-day reporting requirement in paragraph §63.6(e)(3)(iv) does not apply and (2) §63.6(e)(3) does not apply to emissions sources not requiring control.
§63.6(f) (1)	Compliance Except During SSM	You must comply with emission standards at all times except during SSM	Yes.
§63.6(f) (2)–(3)	Methods for Determining Compliance	Compliance based on performance test, operation and maintenance plans, records, inspection	Yes.
§63.6(g) (1)–(3)	Alternative Standard	Procedures for getting an alternative standard	Yes.
§63.6(h)	Opacity/Visible Emission Standards	Requirements for compliance with opacity	No; except as it applies to

		and visible emission standards	flares for which Method 22 observations are required as part of a flare compliance assessment.
§63.6(i)(1)–(14)	Compliance Extension	Procedures and criteria for Administrator to grant compliance extension	Yes.
§63.6(j)	Presidential Compliance Exemption	President may exempt any source from requirement to comply with this subpart	Yes.
§63.7(a)(2)	Performance Test Dates	Dates for conducting initial performance testing; must conduct 180 days after compliance date	Yes.
§63.7(a)(3)	Section 114 Authority	Adminsitrator may require a performance test under CAA section 114 at any time	Yes.
§63.7(b)(1)	Notification of Performance Test	Must notify Administrator 60 days before the test	Yes.
§63.7(b)(2)	Notification of Rescheduling	If you have to reschedule performance test, must notify Administrator of rescheduled date as soon as practicable and without delay	Yes.
§63.7(c)	Quality Assurance (QA)/Test Plan	Requirement to submit site-specific test plan 60 days before the test or on date Administrator agrees with; test plan approval procedures; performance audit requirements; internal and external QA procedures for testing	Yes.
§63.7(d)	Testing Facilities	Requirements for testing facilities	Yes.
§63.7(e)(1)	Conditions for Conducting Performance Tests	Performance tests must be conducted under representative conditions; cannot conduct performance tests during	Yes.

		SSM	
§63.7(e) (2)	Conditions for Conducting Performance Tests	Must conduct according to this subpart and EPA test methods unless Administrator approves alternative	Yes.
§63.7(e) (3)	Test Run Duration	Must have three test runs of at least 1 hour each; compliance is based on arithmetic mean of three runs; conditions when data from an additional test run can be used	Yes; however, for transfer racks per §§63.987(b)(3)(i)(A)–(B) and 63.997(e)(1)(v)(A)–(B) provide exceptions to the requirement for test runs to be at least 1 hour each.
§63.7(f)	Alternative Test Method	Procedures by which Administrator can grant approval to use an intermediate or major change, or alternative to a test method	Yes.
§63.7(g)	Performance Test Data Analysis	Must include raw data in performance test report; must submit performance test data 60 days after end of test with the Notification of Compliance Status; keep data for 5 years	Yes; however, performance test data is to be submitted with the Notification of Compliance Status according to the schedule specified in §63.9(h)(1)–(6) below.
§63.7(h)	Waiver of Tests	Procedures for Administrator to waive performance test	Yes.
§63.8(a) (1)	Applicability of Monitoring Requirements	Subject to all monitoring requirements in standard	Yes.
§63.8(a) (2)	Performance Specifications	Performance Specifications in appendix B of 40 CFR part 60 apply	Yes.
§63.8(a)	[Reserved].		

(3)			
§63.8(a) (4)	Monitoring of Flares	Monitoring requirements for flares in §63.11	Yes; however, monitoring requirements in §63.987(c) also apply.
§63.8(b) (1)	Monitoring	Must conduct monitoring according to standard unless Administrator approves alternative	Yes.
§63.8(b) (2)–(3)	Multiple Effluents and Multiple Monitoring Systems	Specific requirements for installing monitoring systems; must install on each affected source or after combined with another affected source before it is released to the atmosphere provided the monitoring is sufficient to demonstrate compliance with the standard; if more than one monitoring system on an emission point, must report all monitoring system results, unless one monitoring system is a backup	Yes.
§63.8(c) (1)	Monitoring System Operation and Maintenance	Maintain monitoring system in a manner consistent with good air pollution control practices	Yes.
§63.8(c) (1)(i)– (iii)	Routine and Predictable SSM	Keep parts for routine repairs readily available; reporting requirements for SSM when action is described in SSM plan.	Yes.
§63.8(c) (2)–(3)	Monitoring System Installation	Must install to get representative emission or parameter measurements; must verify operational status before or at performance test	Yes.
§63.8(c) (4)	CMS Requirements	CMS must be operating except during breakdown, out-of control, repair, maintenance, and high-level calibration drifts; COMS must have a	Yes; however, COMS are not applicable.

		minimum of one cycle of sampling and analysis for each successive 10-second period and one cycle of data recording for each successive 6-minute period; CEMS must have a minimum of one cycle of operation for each successive 15-minute period	
§63.8(c)(5)	COMS Minimum Procedures	COMS minimum procedures	No.
§63.8(c)(6)–(8)	CMS Requirements	Zero and high level calibration check requirements. Out-of-control periods	Yes, but only applies for CEMS. 40 CFR part 63, subpart SS provides requirements for CPMS.
§63.8(d)	CMS Quality Control	Requirements for CMS quality control, including calibration, etc.; must keep quality control plan on record for 5 years; keep old versions for 5 years after revisions	Yes, but only applies for CEMS. 40 CFR part 63, subpart SS provides requirements for CPMS.
§63.8(e)	CMS Performance Evaluation	Notification, performance evaluation test plan, reports	Yes, but only applies for CEMS.
§63.8(f)(1)–(5)	Alternative Monitoring Method	Procedures for Administrator to approve alternative monitoring	Yes, but 40 CFR part 63, subpart SS also provides procedures for approval of CPMS.
§63.8(f)(6)	Alternative to Relative Accuracy Test	Procedures for Administrator to approve alternative relative accuracy tests for CEMS	Yes.
§63.8(g)	Data Reduction	COMS 6-minute averages calculated over at least 36 evenly spaced data points; CEMS 1 hour averages computed over at least 4	Yes; however, COMS are not applicable.

		equally spaced data points; data that cannot be used in average	
§63.9(a)	Notification Requirements	Applicability and State delegation	Yes.
§63.9(b) (1)–(2), (4)–(5)	Initial Notifications	Submit notification within 120 days after effective date; notification of intent to construct/reconstruct, notification of commencement of construction/reconstruction, notification of startup; contents of each	Yes.
§63.9(c)	Request for Compliance Extension	Can request if cannot comply by date or if installed best available control technology or lowest achievable emission rate (BACT/LAER)	Yes.
§63.9(d)	Notification of Special Compliance Requirements for New Sources	For sources that commence construction between proposal and promulgation and want to comply 3 years after effective date	Yes.
§63.9(e)	Notification of Performance Test	Notify Administrator 60 days prior	Yes.
§63.9(f)	Notification of VE/Opacity Test	Notify Administrator 30 days prior	No.
§63.9(g)	Additional Notifications When Using CMS	Notification of performance evaluation; notification about use of COMS data; notification that exceeded criterion for relative accuracy alternative	Yes; however, there are no opacity standards.
§63.9(h) (1)–(6)	Notification of Compliance Status	Contents due 60 days after end of performance test or other compliance demonstration, except for opacity/visible emissions, which are due 30 days after; when to submit to Federal vs. State authority	Yes; however, (1) there are no opacity standards and (2) all initial Notification of Compliance Status, including all performance test data, are to be

			submitted at the same time, either within 240 days after the compliance date or within 60 days after the last performance test demonstrating compliance has been completed, whichever occurs first.
§63.9(i)	Adjustment of Submittal Deadlines	Procedures for Administrator to approve change in when notifications must be submitted	Yes.
§63.9(j)	Change in Previous Information	Must submit within 15 days after the change	No. These changes will be reported in the first and subsequent compliance reports.
§63.10 (a)	Recordkeeping/Reporting	Applies to all, unless compliance extension; when to submit to Federal vs. State authority; procedures for owners of more than one source	Yes.
§63.10 (b)(1)	Recordkeeping/Reporting	General requirements; keep all records readily available; keep for 5 years	Yes.
§63.10 (b)(2) (i)-(iv)	Records Related to Startup, Shutdown, and Malfunction	Occurrence of each for operations (process equipment); occurrence of each malfunction of air pollution control equipment; maintenance on air pollution control equipment; actions during SSM	Yes.
§63.10 (b)(2)	CMS Records	Malfunctions, inoperative, out-of-control periods	Yes.

(vi)–(xi)			
§63.10 (b)(2) (xii)	Records	Records when under waiver	Yes.
§63.10 (b)(2) (xiii)	Records	Records when using alternative to relative accuracy test	Yes.
§63.10 (b)(2) (xiv)	Records	All documentation supporting initial notification and notification of compliance status	Yes.
§63.10 (b)(3)	Records	Applicability determinations	Yes.
§63.10 (c)	Records	Additional records for CMS	Yes.
§63.10 (d)(1)	General Reporting Requirements	Requirement to report	Yes.
§63.10 (d)(2)	Report of Performance Test Results	When to submit to Federal or State authority	Yes.
§63.10 (d)(3)	Reporting Opacity or VE Observations	What to report and when	Yes.
§63.10 (d)(4)	Progress Reports	Must submit progress reports on schedule if under compliance extension	Yes.
§63.10 (d)(5)	SSM Reports	Contents and submission	Yes.
§63.10 (e)(1)– (2)	Additional CMS Reports	Must report results for each CEMS on a unit; written copy of CMS performance evaluation; 2–3 copies of COMS performance evaluation	Yes; however, COMS are not applicable.
§63.10 (e)(3) (i)–(iii)	Reports	Schedule for reporting excess emissions and parameter monitor exceedance (now defined as deviations)	Yes; however, note that the title of the report is the compliance report; deviations include excess emissions and parameter exceedances.

§63.10 (e)(3) (iv)–(v)	Excess Emissions Reports	Requirement to revert to quarterly submission if there is an excess emissions or parameter monitoring exceedance (now defined as deviations); provision to request semiannual reporting after compliance for 1 year; submit report by 30th day following end of quarter or calendar half; if there has not been an exceedance or excess emissions (now defined as deviations), report contents in a statement that there have been no deviations; must submit report containing all of the information in §§63.8(c)(7)–(8) and 63.10(c)(5)–(13)	Yes.
§63.10 (e)(3) (vi)– (viii)	Excess Emissions Report and Summary Report	Requirements for reporting excess emissions for CMS (now called deviations); requires all of the information in §§63.10(c)(5)–(13) and 63.8(c)(7)–(8)	Yes.
§63.10 (e)(4)	Reporting COMS Data	Must submit COMS data with performance test data	No.
§63.10 (f)	Waiver for Recordkeeping/Reporting	Procedures for Administrator to waive	Yes.
§63.11 (b)	Flares	Requirements for flares	Yes; §63.987 requirements apply, and the section references §63.11(b).
§63.12	Delegation	State authority to enforce standards	Yes.
§63.13	Addresses	Addresses where reports, notifications, and requests are sent	Yes.
§63.14	Incorporation by Reference	Test methods incorporated by reference	Yes.
§63.15	Availability of Information	Public and confidential information	Yes.

[69 FR 5063, Feb. 3, 2004, as amended at 71 FR 20463, Apr. 20, 2006; 71 FR 42924, July 28, 2006]

[Browse Previous](#) | [Browse Next](#)

For questions or comments regarding e-CFR editorial content, features, or design, email ecfr@nara.gov.

For questions concerning e-CFR programming and delivery issues, email webteam@gpo.gov.

[Section 508 / Accessibility](#)

[Home Page](#) > [Executive Branch](#) > [Code of Federal Regulations](#) > [Electronic Code of Federal Regulations](#)

Electronic Code of Federal Regulations

e-CFR
TM

e-CFR Data is current as of August 1, 2007

Title 40: Protection of Environment

PART 63—NATIONAL EMISSION STANDARDS FOR HAZARDOUS AIR POLLUTANTS FOR SOURCE CATEGORIES

[Browse Previous](#) | [Browse Next](#)

Subpart FFFF—National Emission Standards for Hazardous Air Pollutants: Miscellaneous Organic Chemical Manufacturing

Source: 68 FR 63888, Nov. 10, 2003, unless otherwise noted.

What This Subpart Covers

§ 63.2430 What is the purpose of this subpart?

This subpart establishes national emission standards for hazardous air pollutants (NESHAP) for miscellaneous organic chemical manufacturing. This subpart also establishes requirements to demonstrate initial and continuous compliance with the emission limits, operating limits, and work practice standards.

§ 63.2435 Am I subject to the requirements in this subpart?

(a) You are subject to the requirements in this subpart if you own or operate miscellaneous organic chemical manufacturing process units (MCPU) that are located at, or are part of, a major source of hazardous air pollutants (HAP) emissions as defined in section 112(a) of the Clean Air Act (CAA).

(b) An MCPU includes equipment necessary to operate a miscellaneous organic chemical manufacturing process, as defined in §63.2550, that satisfies all of the conditions specified in paragraphs (b)(1) through (3) of this section. An MCPU also includes any assigned storage tanks and transfer racks; equipment in open systems that is used to convey or store water having the same concentration and flow characteristics as wastewater; and components such as pumps, compressors, agitators, pressure relief devices, sampling connection systems, open-ended valves or lines, valves, connectors, and instrumentation systems that are used to manufacture any material or family of materials described in paragraphs (b)(1)(i) through (v) of this section.

(1) The MCPU produces material or family of materials that is described in paragraph (b)(1)(i), (ii), (iii), (iv), or (v) of this section.

(i) An organic chemical(s) classified using the 1987 version of SIC code 282, 283, 284, 285, 286, 287, 289, or 386, except as provided in paragraph (c)(5) of this section.

(ii) An organic chemical(s) classified using the 1997 version of NAICS code 325, except as provided in paragraph (c)(5) of this section.

(iii) Quaternary ammonium compounds and ammonium sulfate produced with caprolactam.

(iv) Hydrazine.

(v) Organic solvents classified in any of the SIC or NAICS codes listed in paragraph (b)(1)(i) or (ii) of this section that are recovered using nondedicated solvent recovery operations.

(2) The MCPU processes, uses, or generates any of the organic HAP listed in section 112(b) of the CAA or hydrogen halide and halogen HAP, as defined in §63.2550.

(3) The MCPU is not an affected source or part of an affected source under another subpart of this part 63, except for process vents from batch operations within a chemical manufacturing process unit (CMPU), as identified in §63.100(j)(4). For this situation, the MCPU is the same as the CMPU as defined in §63.100, and you are subject only to the requirements for batch process vents in this subpart.

(c) The requirements in this subpart do not apply to the operations specified in paragraphs (c)(1) through (7) of this section.

(1) Research and development facilities, as defined in section 112(c)(7) of the CAA.

(2) The manufacture of ammonium sulfate as a by-product, if the slurry entering the by-product manufacturing process contains 50 parts per million by weight (ppmw) HAP or less or 10 ppmw benzene or less. You must retain information, data, and analysis to document the HAP concentration in the entering slurry in order to claim this exemption.

(3) The affiliated operations located at an affected source under subparts GG (National Emission Standards for Aerospace Manufacturing and Rework Facilities), KK (National Emission Standards for the Printing and Publishing Industry), JJJJ (NESHAP: Paper and Other Web Coating), future MMMM (NESHAP: Surface Coating of Miscellaneous Metal Parts and Products), and SSSS (NESHAP: Surface Coating of Metal Coil) of this part 63. Affiliated operations include, but are not limited to, mixing or dissolving of coating ingredients; coating mixing for viscosity adjustment, color tint or additive blending, or pH adjustment; cleaning of coating lines and coating line parts; handling and storage of coatings and solvent; and conveyance and treatment of wastewater.

(4) Fabricating operations (such as spinning or compressing a solid polymer into its end use); compounding operations (in which blending, melting, and resolidification of a solid polymer product occur for the purpose of incorporating additives, colorants, or stabilizers); and extrusion and drawing operations (converting an already produced solid polymer into a different shape by melting or mixing the polymer and then forcing it or pulling it through an orifice to create an extruded product). An operation is not exempt if it involves processing with HAP solvent or if an intended purpose of the operation is to remove residual HAP monomer.

(5) Production activities described using the 1997 version of NAICS codes 325131, 325181, 325188 (except the requirements do apply to hydrazine), 325314, 325991 (except the requirements do apply to reformulating plastics resins from recycled plastics products), and 325992 (except the requirements do apply to photographic chemicals).

(6) Tall oil recovery systems.

(7) Carbon monoxide production.

(d) If the predominant use of a transfer rack loading arm or storage tank (including storage tanks in series) is associated with a miscellaneous organic chemical manufacturing process, and the loading arm or storage tank is not part of an affected source under a subpart of this part 63, then you must assign the loading arm or storage tank to the MCPU for that miscellaneous organic chemical manufacturing process. If the predominant use cannot be determined, then you may assign the loading arm or storage tank to any MCPU that shares it and is subject to this subpart. If the use varies from year to year, then you must base the determination on the utilization that occurred during the year preceding November 10, 2003 or, if the loading arm or storage tank was not in operation during that year, you must base the use on the expected use for the first 5-year period after startup. You must include the determination in the notification of compliance status report specified in §63.2520(d). You must redetermine the primary use at least once every 5 years, or any time you implement emissions averaging or pollution prevention after the compliance date.

(e) For nondedicated equipment used to create at least one MCPU, you may elect to develop process unit groups (PUG), determine the primary product of each PUG, and comply with the requirements of the subpart in 40 CFR part 63 that applies to that primary product as specified in §63.2535(l).

[68 FR 63888, Nov. 10, 2003, as amended at 71 FR 40331, July 14, 2006]

§ 63.2440 What parts of my plant does this subpart cover?

(a) This subpart applies to each miscellaneous organic chemical manufacturing affected source.

(b) The miscellaneous organic chemical manufacturing affected source is the facilitywide collection of MCPU and heat exchange systems, wastewater, and waste management units that are associated with manufacturing materials described in §63.2435(b)(1).

(c) A new affected source is described by either paragraph (c)(1) or (2) of this section.

(1) Each affected source defined in paragraph (b) of this section for which you commenced construction or reconstruction after April 4, 2002, and you meet the applicability criteria at the time you commenced construction or reconstruction.

(2) Each dedicated MCPU that has the potential to emit 10 tons per year (tpy) of any one HAP or 25 tpy of combined HAP, and you commenced construction or reconstruction of the MCPU after April 4, 2002. For the purposes of this paragraph, an MCPU is an affected source in the definition of the term "reconstruction" in §63.2.

(d) An MCPU that is also a CMPU under §63.100 is reconstructed for the purposes of this subpart if, and only if, the CMPU meets the requirements for reconstruction in §63.100(l)(2).

Compliance Dates

§ 63.2445 When do I have to comply with this subpart?

(a) If you have a new affected source, you must comply with this subpart according to the requirements in paragraphs (a)(1) and (2) of this section.

(1) If you startup your new affected source before November 10, 2003, then you must comply with the requirements for new sources in this subpart no later than November 10, 2003.

(2) If you startup your new affected source after November 10, 2003, then you must comply with the requirements for new sources in this subpart upon startup of your affected source.

(b) If you have an existing source on November 10, 2003, you must comply with the requirements for existing sources in this subpart no later than May 10, 2008.

(c) You must meet the notification requirements in §63.2515 according to the dates specified in that section and in subpart A of this part 63. Some of the notifications must be submitted before you are required to comply with the emission limits, operating limits, and work practice standards in this subpart.

(d) If you have a Group 2 emission point that becomes a Group 1 emission point after the compliance date for your affected source, you must comply with the Group 1 requirements beginning on the date the switch occurs. An initial compliance demonstration as specified in this subpart must be conducted within 150 days after the switch occurs.

(e) If, after the compliance date for your affected source, hydrogen halide and halogen HAP emissions from process vents in a process increase to more than 1,000 lb/yr, or HAP metals emissions from a process at a new affected source increase to more than 150 lb/yr, you must comply with the applicable emission limits specified in Table 3 to this subpart and the associated compliance requirements beginning on the date the emissions exceed the applicable threshold. An initial compliance demonstration as specified in this subpart must be conducted within 150 days after the switch occurs.

(f) If you have a small control device for process vent or transfer rack emissions that becomes a large control device, as defined in §63.2550(i), you must comply with monitoring and associated recordkeeping and reporting requirements for large control devices beginning on the date the switch occurs. An initial compliance demonstration as specified in this subpart must be conducted within 150 days after the switch occurs.

[68 FR 63888, Nov. 10, 2003, as amended at 71 FR 10442, Mar. 1, 2006; 71 FR 40332, July 14, 2006]

Emission Limits, Work Practice Standards, and Compliance Requirements

§ 63.2450 What are my general requirements for complying with this subpart?

(a) You must be in compliance with the emission limits and work practice standards in Tables 1 through 7 to this subpart at all times, except during periods of startup, shutdown, and malfunction (SSM), and you must meet the requirements specified in §§63.2455 through 63.2490 (or the alternative means of compliance in §63.2495, §63.2500, or §63.2505), except as specified in paragraphs (b) through (s) of this section. You must meet the notification, reporting, and recordkeeping requirements specified in §§63.2515, 63.2520, and 63.2525.

(b) *Determine halogenated vent streams.* You must determine if an emission stream is a halogenated vent stream, as defined in §63.2550, by calculating the mass emission rate of halogen atoms in accordance with §63.115(d)(2)(v). Alternatively, you may elect to designate the emission stream as halogenated.

(c) *Requirements for combined emission streams.* When organic HAP emissions from different emission types (e.g., continuous process vents, batch process vents, storage tanks, transfer operations, and waste management units) are combined, you must comply with the requirements of either paragraph (c) (1) or (2) of this section.

(1) Comply with the applicable requirements of this subpart for each kind of organic HAP emissions in the stream (e.g., the requirements of Table 1 to this subpart for continuous process vents and the requirements of Table 4 to this subpart for emissions from storage tanks).

(2) Determine the applicable requirements based on the hierarchy presented in paragraphs (c)(2)(i) through (vi) of this section. For a combined stream, the applicable requirements are specified in the highest-listed paragraph in the hierarchy that applies to any of the individual streams that make up the combined stream. For example, if a combined stream consists of emissions from Group 1 batch process vents and any other type of emission stream, then you must comply with the requirements in paragraph (c)(2)(i) of this section for the combined stream; compliance with the requirements in paragraph (c)(2)(i) of this section constitutes compliance for the other emission streams in the combined stream. Two exceptions are that you must comply with the requirements in Table 3 to this subpart and §63.2465 for all process vents with hydrogen halide and halogen HAP emissions, and recordkeeping requirements for Group 2 applicability or compliance are still required (e.g., the requirement in §63.2525(f) to track the number of batches produced and calculate rolling annual emissions for processes with Group 2 batch process vents).

(i) The requirements of Table 2 to this subpart and §63.2460 for Group 1 batch process vents, including applicable monitoring, recordkeeping, and reporting.

(ii) The requirements of Table 1 to this subpart and §63.2455 for continuous process vents that are routed to a control device, as defined in §63.981, including applicable monitoring, recordkeeping, and reporting.

(iii) The requirements of Table 5 to this subpart and §63.2475 for transfer operations, including applicable monitoring, recordkeeping, and reporting.

(iv) The requirements of Table 7 to this subpart and §63.2485 for emissions from waste management units that are used to manage and treat Group 1 wastewater streams and residuals from Group 1 wastewater streams, including applicable monitoring, recordkeeping, and reporting.

(v) The requirements of Table 4 to this subpart and §63.2470 for control of emissions from storage

tanks, including applicable monitoring, recordkeeping, and reporting.

(vi) The requirements of Table 1 to this subpart and §63.2455 for continuous process vents after a recovery device including applicable monitoring, recordkeeping, and reporting.

(d) [Reserved]

(e) *Requirements for control devices.* (1) Except when complying with §63.2485, if you reduce organic HAP emissions by venting emissions through a closed-vent system to any combination of control devices (except a flare) or recovery devices, you must meet the requirements of §63.982(c) and the requirements referenced therein.

(2) Except when complying with §63.2485, if you reduce organic HAP emissions by venting emissions through a closed-vent system to a flare, you must meet the requirements of §63.982(b) and the requirements referenced therein.

(3) If you use a halogen reduction device to reduce hydrogen halide and halogen HAP emissions from halogenated vent streams, you must meet the requirements of §63.994 and the requirements referenced therein. If you use a halogen reduction device before a combustion device, you must determine the halogen atom emission rate prior to the combustion device according to the procedures in §63.115(d)(2)(v).

(f) *Requirements for flare compliance assessments.* (1) As part of a flare compliance assessment required in §63.987(b), you have the option of demonstrating compliance with the requirements of §63.11(b) by complying with the requirements in either §63.11(b)(6)(i) or §63.987(b)(3)(ii).

(2) If you elect to meet the requirements in §63.11(b)(6)(i), you must keep flare compliance assessment records as specified in paragraphs (f)(2)(i) and (ii) of this section.

(i) Keep records as specified in §63.998(a)(1)(i), except that a record of the heat content determination is not required.

(ii) Keep records of the flare diameter, hydrogen content, exit velocity, and maximum permitted velocity. Include these records in the flare compliance report required in §63.999(a)(2).

(g) *Requirements for performance tests.* The requirements specified in paragraphs (g)(1) through (5) of this section apply instead of or in addition to the requirements specified in subpart SS of this part 63.

(1) Conduct gas molecular weight analysis using Method 3, 3A, or 3B in appendix A to part 60 of this chapter.

(2) Measure moisture content of the stack gas using Method 4 in appendix A to part 60 of this chapter.

(3) If the uncontrolled or inlet gas stream to the control device contains carbon disulfide, you must conduct emissions testing according to paragraph (g)(3)(i) or (ii) of this section.

(i) If you elect to comply with the percent reduction emission limits in Tables 1 through 7 to this subpart, and carbon disulfide is the principal organic HAP component (*i.e.*, greater than 50 percent of the HAP in the stream by volume), then you must use Method 18, or Method 15 (40 CFR part 60, appendix A) to measure carbon disulfide at the inlet and outlet of the control device. Use the percent reduction in carbon disulfide as a surrogate for the percent reduction in total organic HAP emissions.

(ii) If you elect to comply with the outlet total organic compound (TOC) concentration emission limits in Tables 1 through 7 to this subpart, and the uncontrolled or inlet gas stream to the control device contains greater than 10 percent (volume concentration) carbon disulfide, you must use Method 18 or Method 15 to separately determine the carbon disulfide concentration. Calculate the total HAP or TOC emissions by totaling the carbon disulfide emissions measured using Method 18 or 15 and the other HAP emissions measured using Method 18 or 25A.

(4) As an alternative to using Method 18, Method 25/25A, or Method 26/26A of 40 CFR part 60,

appendix A, to comply with any of the emission limits specified in Tables 1 through 7 to this subpart, you may use Method 320 of 40 CFR part 60, appendix A. When using Method 320, you must follow the analyte spiking procedures of section 13 of Method 320, unless you demonstrate that the complete spiking procedure has been conducted at a similar source.

(5) Section 63.997(c)(1) does not apply. For the purposes of this subpart, results of all initial compliance demonstrations must be included in the notification of compliance status report, which is due 150 days after the compliance date, as specified in §63.2520(d)(1).

(h) *Design evaluation.* To determine the percent reduction of a small control device that is used to comply with an emission limit specified in Table 1, 2, 3, or 5 to this subpart, you may elect to conduct a design evaluation as specified in §63.1257(a)(1) instead of a performance test as specified in subpart SS of this part 63. You must establish the value(s) and basis for the operating limits as part of the design evaluation. For continuous process vents, the design evaluation must be conducted at maximum representative operating conditions for the process, unless the Administrator specifies or approves alternate operating conditions. For transfer racks, the design evaluation must demonstrate that the control device achieves the required control efficiency during the reasonably expected maximum transfer loading rate.

(i) *Outlet concentration correction for combustion devices.* When §63.997(e)(2)(iii)(C) requires you to correct the measured concentration at the outlet of a combustion device to 3 percent oxygen if you add supplemental combustion air, the requirements in either paragraph (i)(1) or (2) of this section apply for the purposes of this subpart.

(1) You must correct the concentration in the gas stream at the outlet of the combustion device to 3 percent oxygen if you add supplemental gases, as defined in §63.2550, to the vent stream, or;

(2) You must correct the measured concentration for supplemental gases using Equation 1 of §63.2460; you may use process knowledge and representative operating data to determine the fraction of the total flow due to supplemental gas.

(j) *Continuous emissions monitoring systems.* Each continuous emissions monitoring system (CEMS) must be installed, operated, and maintained according to the requirements in §63.8 and paragraphs (j)(1) through (5) of this section.

(1) Each CEMS must be installed, operated, and maintained according to the applicable Performance Specification of 40 CFR part 60, appendix B, and according to paragraph (j)(2) of this section, except as specified in paragraph (j)(1)(i) of this section. For any CEMS meeting Performance Specification 8, you must also comply with appendix F, procedure 1 of 40 CFR part 60.

(i) If you wish to use a CEMS other than an Fourier Transform Infrared Spectroscopy (FTIR) meeting the requirements of Performance Specification 15 to measure hydrogen halide and halogen HAP before we promulgate a Performance Specification for such CEMS, you must prepare a monitoring plan and submit it for approval in accordance with the procedures specified in §63.8.

(ii) [Reserved]

(2) You must determine the calibration gases and reporting units for TOC CEMS in accordance with paragraph (j)(2)(i), (ii), or (iii) of this section.

(i) For CEMS meeting Performance Specification 9 or 15 requirements, determine the target analyte(s) for calibration using either process knowledge of the control device inlet stream or the screening procedures of Method 18 on the control device inlet stream.

(ii) For CEMS meeting Performance Specification 8 used to monitor performance of a combustion device, calibrate the instrument on the predominant organic HAP and report the results as carbon (C1), and use Method 25A or any approved alternative as the reference method for the relative accuracy tests.

(iii) For CEMS meeting Performance Specification 8 used to monitor performance of a noncombustion device, determine the predominant organic HAP using either process knowledge or the screening

procedures of Method 18 on the control device inlet stream, calibrate the monitor on the predominant organic HAP, and report the results as C_1 . Use Method 18, ASTM D6420–99, or any approved alternative as the reference method for the relative accuracy tests, and report the results as C_1 .

(3) You must conduct a performance evaluation of each CEMS according to the requirements in 40 CFR 63.8 and according to the applicable Performance Specification of 40 CFR part 60, appendix B, except that the schedule in §63.8(e)(4) does not apply, and the results of the performance evaluation must be included in the notification of compliance status report.

(4) The CEMS data must be reduced to operating day or operating block averages computed using valid data consistent with the data availability requirements specified in §63.999(c)(6)(i)(B) through (D), except monitoring data also are sufficient to constitute a valid hour of data if measured values are available for at least two of the 15-minute periods during an hour when calibration, quality assurance, or maintenance activities are being performed. An operating block is a period of time from the beginning to end of batch operations within a process. Operating block averages may be used only for batch process vent data.

(5) If you add supplemental gases, you must correct the measured concentrations in accordance with paragraph (i) of this section and §63.2460(c)(6).

(k) *Continuous parameter monitoring.* The provisions in paragraphs (k)(1) through (6) of this section apply in addition to the requirements for continuous parameter monitoring system (CPMS) in subpart SS of this part 63.

(1) You must record the results of each calibration check and all maintenance performed on the CPMS as specified in §63.998(c)(1)(ii)(A).

(2) When subpart SS of this part 63 uses the term “a range” or “operating range” of a monitored parameter, it means an “operating limit” for a monitored parameter for the purposes of this subpart.

(3) As an alternative to continuously measuring and recording pH as specified in §§63.994(c)(1)(i) and 63.998(a)(2)(ii)(D), you may elect to continuously monitor and record the caustic strength of the effluent. For halogen scrubbers used to control only batch process vents you may elect to monitor and record either the pH or the caustic strength of the scrubber effluent at least once per day.

(4) As an alternative to the inlet and outlet temperature monitoring requirements for catalytic incinerators as specified in §63.988(c)(2) and the related recordkeeping requirements specified in §63.998(a)(2)(ii)(B)(2) and (c)(2)(ii), you may elect to comply with the requirements specified in paragraphs (k)(4)(i) through (iv) of this section.

(i) Monitor and record the inlet temperature as specified in subpart SS of this part 63.

(ii) Check the activity level of the catalyst at least every 12 months and take any necessary corrective action, such as replacing the catalyst to ensure that the catalyst is performing as designed.

(iii) Maintain records of the annual checks of catalyst activity levels and the subsequent corrective actions.

(iv) Recording the downstream temperature and temperature difference across the catalyst bed as specified in §63.998(a)(2)(ii)(B)(2) and (b)(2)(ii) is not required.

(5) For absorbers that control organic compounds and use water as the scrubbing fluid, you must conduct monitoring and recordkeeping as specified in paragraphs (k)(5)(i) through (iii) of this section instead of the monitoring and recordkeeping requirements specified in §§63.990(c)(1), 63.993(c)(1), and 63.998(a)(2)(ii)(C).

(i) You must use a flow meter capable of providing a continuous record of the absorber influent liquid flow.

(ii) You must determine gas stream flow using one of the procedures specified in §63.994(c)(1)(ii)(A)

through (D).

(iii) You must record the absorber liquid-to-gas ratio averaged over the time period of any performance test.

(6) For a control device with total inlet HAP emissions less than 1 tpy, you must establish an operating limit(s) for a parameter(s) that you will measure and record at least once per averaging period (i.e., daily or block) to verify that the control device is operating properly. You may elect to measure the same parameter(s) that is required for control devices that control inlet HAP emissions equal to or greater than 1 tpy. If the parameter will not be measured continuously, you must request approval of your proposed procedure in the precompliance report. You must identify the operating limit(s) and the measurement frequency, and you must provide rationale to support how these measurements demonstrate the control device is operating properly.

(l) *Startup, shutdown, and malfunction.* Sections 63.152(f)(7)(ii) through (iv) and 63.998(b)(2)(iii) and (b)(6)(i)(A), which apply to the exclusion of monitoring data collected during periods of SSM from daily averages, do not apply for the purposes of this subpart.

(m) *Reporting.* (1) When §§63.2455 through 63.2490 reference other subparts in this part 63 that use the term "periodic report," it means "compliance report" for the purposes of this subpart. The compliance report must include the information specified in §63.2520(e), as well as the information specified in referenced subparts.

(2) When there are conflicts between this subpart and referenced subparts for the due dates of reports required by this subpart, reports must be submitted according to the due dates presented in this subpart.

(3) Excused excursions, as defined in subparts G and SS of this part 63, are not allowed.

(n) [Reserved]

(o) You may not use a flare to control halogenated vent streams or hydrogen halide and halogen HAP emissions.

(p) Opening a safety device, as defined in §63.2550, is allowed at any time conditions require it to avoid unsafe conditions.

(q) If an emission stream contains energetics or organic peroxides that, for safety reasons, cannot meet an applicable emission limit specified in Tables 1 through 7 to this subpart, then you must submit documentation in your precompliance report explaining why an undue safety hazard would be created if the air emission controls were installed, and you must describe the procedures that you will implement to minimize HAP emissions from these vent streams.

(r) *Surge control vessels and bottoms receivers.* For each surge control vessel or bottoms receiver that meets the capacity and vapor pressure thresholds for a Group 1 storage tank, you must meet emission limits and work practice standards specified in Table 4 to this subpart.

(s) For the purposes of determining Group status for continuous process vents, batch process vents, and storage tanks in §§63.2455, 63.2460, and 63.2470, hydrazine is to be considered an organic HAP.

[68 FR 63888, Nov. 10, 2003, as amended at 70 FR 38559, July 1, 2005; 71 FR 40332, July 14, 2006]

§ 63.2455 What requirements must I meet for continuous process vents?

(a) You must meet each emission limit in Table 1 to this subpart that applies to your continuous process vents, and you must meet each applicable requirement specified in paragraphs (b) through (c) of this section.

(b) For each continuous process vent, you must either designate the vent as a Group 1 continuous process vent or determine the total resource effectiveness (TRE) index value as specified in §63.115(d), except as specified in paragraphs (b)(1) through (3) of this section.

(1) You are not required to determine the Group status or the TRE index value for any continuous process vent that is combined with Group 1 batch process vents before a control device or recovery device because the requirements of §63.2450(c)(2)(i) apply to the combined stream.

(2) When a TRE index value of 4.0 is referred to in §63.115(d), TRE index values of 5.0 for existing affected sources and 8.0 for new and reconstructed affected sources apply for the purposes of this subpart.

(3) When §63.115(d) refers to "emission reductions specified in §63.113(a)," the reductions specified in Table 1 to this subpart apply for the purposes of this subpart.

(c) If you use a recovery device to maintain the TRE above a specified threshold, you must meet the requirements of §63.982(e) and the requirements referenced therein, except as specified in §63.2450 and paragraph (c)(1) of this section.

(1) When §63.993 uses the phrase "the TRE index value is between the level specified in a referencing subpart and 4.0," the phrase "the TRE index value is >1.9 but ≤ 5.0 " applies for an existing affected source, and the phrase "the TRE index value is >5.0 but ≤ 8.0 " applies for a new and reconstructed affected source, for the purposes of this subpart.

(2) [Reserved]

§ 63.2460 What requirements must I meet for batch process vents?

(a) You must meet each emission limit in Table 2 to this subpart that applies to you, and you must meet each applicable requirement specified in paragraphs (b) and (c) of this section.

(b) *Group status.* If a process has batch process vents, as defined in §63.2550, you must determine the group status of the batch process vents by determining and summing the uncontrolled organic HAP emissions from each of the batch process vents within the process using the procedures specified in §63.1257(d)(2)(i) and (ii), except as specified in paragraphs (b)(1) through (7) of this section.

(1) To calculate emissions caused by the heating of a vessel without a process condenser to a temperature lower than the boiling point, you must use the procedures in §63.1257(d)(2)(i)(C)(3).

(2) To calculate emissions from depressurization of a vessel without a process condenser, you must use the procedures in §63.1257(d)(2)(i)(D)(10).

(3) To calculate emissions from vacuum systems for the purposes of this subpart, the receiving vessel is part of the vacuum system, and terms used in Equation 33 to 40 CFR part 63, subpart GGG, are defined as follows:

P_{system} = absolute pressure of the receiving vessel;

P_i = partial pressure of the HAP determined at the exit temperature and exit pressure conditions of the condenser or at the conditions of the dedicated receiver;

P_j = partial pressure of condensables (including HAP) determined at the exit temperature and exit pressure conditions of the condenser or at the conditions of the dedicated receiver;

MW_{HAP} = molecular weight of the HAP determined at the exit temperature and exit pressure conditions of the condenser or at the conditions of the dedicated receiver.

(4) To calculate uncontrolled emissions when a vessel is equipped with a process condenser, you must use the procedures in §63.1257(d)(3)(i)(B), except as specified in paragraphs (b)(4)(i) through (vii) of this section.

(i) You must determine the flowrate of gas (or volume of gas), partial pressures of condensables,

temperature (T), and HAP molecular weight (MW_{HAP}) at the exit temperature and exit pressure conditions of the condenser or at the conditions of the dedicated receiver.

(ii) You must assume that all of the components contained in the condenser exit vent stream are in equilibrium with the same components in the exit condensate stream (except for noncondensables).

(iii) You must perform a material balance for each component.

(iv) For the emissions from gas evolution, the term for time, t , must be used in Equation 12 to 40 CFR part 63, subpart GGG.

(v) Emissions from empty vessel purging shall be calculated using Equation 36 to 40 CFR part 63, subpart GGG and the exit temperature and exit pressure conditions of the condenser or the conditions of the dedicated receiver.

(vi) You must conduct an engineering assessment as specified in §63.1257(d)(2)(ii) for each emission episode that is not due to vapor displacement, purging, heating, depressurization, vacuum operations, gas evolution, air drying, or empty vessel purging. The requirements of paragraphs (b)(3) through (4) of this section shall apply.

(vii) You may elect to conduct an engineering assessment if you can demonstrate to the Administrator that the methods in §63.1257(d)(3)(i)(B) are not appropriate.

(5) You may elect to designate the batch process vents within a process as Group 1 and not calculate uncontrolled emissions under either of the situations in paragraph (b)(5)(i), (ii), or (iii) of this section.

(i) If you comply with the alternative standard specified in §63.2505.

(ii) If all Group 1 batch process vents within a process are controlled; you conduct the performance test under hypothetical worst case conditions, as defined in §63.1257(b)(8)(i)(B); and the emission profile is based on capture and control system limitations as specified in §63.1257(b)(8)(ii)(C).

(iii) If you comply with an emission limit using a flare that meets the requirements specified in §63.987.

(6) You may change from Group 2 to Group 1 in accordance with either paragraph (b)(6)(i) or (ii) of this section. You must comply with the requirements of this section and submit the test report in the next Compliance report.

(i) You may switch at any time after operating as Group 2 for at least 1 year so that you can show compliance with the 10,000 pounds per year (lb/yr) threshold for Group 2 batch process vents for at least 365 days before the switch. You may elect to start keeping records of emissions from Group 2 batch process vents before the compliance date. Report a switch based on this provision in your next compliance report in accordance with §63.2520(e)(10)(i).

(ii) If the conditions in paragraph (b)(6)(i) of this section are not applicable, you must provide a 60-day advance notice in accordance with §63.2520(e)(10)(ii) before switching.

(7) As an alternative to determining the uncontrolled organic HAP emissions as specified in §63.1257(d)(2)(i) and (ii), you may elect to demonstrate that non-reactive organic HAP are the only HAP used in the process and non-reactive HAP usage in the process is less than 10,000 lb/yr. You must provide data and supporting rationale in your notification of compliance status report explaining why the non-reactive organic HAP usage will be less than 10,000 lb/yr. You must keep records of the non-reactive organic HAP usage as specified in §63.2525(e)(2) and include information in compliance reports as specified in §63.2520(e)(5)(iv).

(c) Exceptions to the requirements in subparts SS and WW of this part 63 are specified in paragraphs (c)(1) through (9) of this section.

(1) *Process condensers*. Process condensers, as defined in §63.2550(i), are not considered to be

control devices for batch process vents. You must determine whether a condenser is a control device for a batch process vent or a process condenser from which the uncontrolled HAP emissions are evaluated as part of the initial compliance demonstration for each MCPU and report the results with supporting rationale in your notification of compliance status report.

(2) *Initial compliance.* (i) To demonstrate initial compliance with a percent reduction emission limit in Table 2 to this subpart FFFF, you must compare the sums of the controlled and uncontrolled emissions for the applicable Group 1 batch process vents within the process, and show that the specified reduction is met. This requirement does not apply if you comply with the emission limits of Table 2 to this subpart FFFF by using a flare that meets the requirements of §63.987.

(ii) When you conduct a performance test or design evaluation for a non-flare control device used to control emissions from batch process vents, you must establish emission profiles and conduct the test under worst-case conditions according to §63.1257(b)(8) instead of under normal operating conditions as specified in §63.7(e)(1). The requirements in §63.997(e)(1)(i) and (iii) also do not apply for performance tests conducted to determine compliance with the emission limits for batch process vents. For purposes of this subpart FFFF, references in §63.997(b)(1) to “methods specified in §63.997(e)” include the methods specified in §63.1257(b)(8).

(iii) As an alternative to conducting a performance test or design evaluation to demonstrate initial compliance with a percent reduction requirement for a condenser, you may determine controlled emissions using the procedures specified in §63.1257(d)(3)(i)(B) and paragraphs (b)(3) through (4) of this section.

(iv) When §63.1257(d)(3)(i)(B)(7) specifies that condenser-controlled emissions from an air dryer must be calculated using Equation 11 of 40 CFR part 63, subpart GGG, with “V equal to the air flow rate,” it means “V equal to the dryer outlet gas flow rate,” for the purposes of this subpart. Alternatively, you may use Equation 12 of 40 CFR part 63, subpart GGG, with V equal to the dryer inlet air flow rate. Account for time as appropriate in either equation.

(v) If a process condenser is used for any boiling operations, you must demonstrate that it is properly operated according to the procedures specified in §63.1257(d)(2)(i)(C)(4)(ii) and (d)(3)(iii)(B), and the demonstration must occur only during the boiling operation. The reference in §63.1257(d)(3)(iii)(B) to the alternative standard in §63.1254(c) means §63.2505 for the purposes of this subpart. As an alternative to measuring the exhaust gas temperature, as required by §63.1257(d)(3)(iii)(B), you may elect to measure the liquid temperature in the receiver.

(vi) You must conduct a subsequent performance test or compliance demonstration equivalent to an initial compliance demonstration within 180 days of a change in the worst-case conditions.

(3) *Establishing operating limits.* You must establish operating limits under the conditions required for your initial compliance demonstration, except you may elect to establish operating limit(s) for conditions other than those under which a performance test was conducted as specified in paragraph (c)(3)(i) of this section and, if applicable, paragraph (c)(3)(ii) of this section.

(i) The operating limits may be based on the results of the performance test and supplementary information such as engineering assessments and manufacturer's recommendations. These limits may be established for conditions as unique as individual emission episodes for a batch process. You must provide rationale in the precompliance report for the specific level for each operating limit, including any data and calculations used to develop the limit and a description of why the limit indicates proper operation of the control device. The procedures provided in this paragraph (c)(3)(i) have not been approved by the Administrator and determination of the operating limit using these procedures is subject to review and approval by the Administrator.

(ii) If you elect to establish separate monitoring levels for different emission episodes within a batch process, you must maintain records in your daily schedule or log of processes indicating each point at which you change from one operating limit to another, even if the duration of the monitoring for an operating limit is less than 15 minutes. You must maintain a daily schedule or log of processes according to §63.2525(c).

(4) *Averaging periods.* As an alternative to the requirement for daily averages in §63.998(b)(3), you may determine averages for operating blocks. An operating block is a period of time that is equal to the time

from the beginning to end of batch process operations within a process.

(5) [Reserved]

(6) *Outlet concentration correction for supplemental gases.* If you use a control device other than a combustion device to comply with a TOC, organic HAP, or hydrogen halide and halogen HAP outlet concentration emission limit for batch process vents, you must correct the actual concentration for supplemental gases using Equation 1 of this section; you may use process knowledge and representative operating data to determine the fraction of the total flow due to supplemental gas.

$$C_a = C_m \left(\frac{Q_s + Q_a}{Q_a} \right) \quad (\text{Eq. 1})$$

Where:

C_a = corrected outlet TOC, organic HAP, or hydrogen halide and halogen HAP concentration, dry basis, ppmv;

C_m = actual TOC, organic HAP, or hydrogen halide and halogen HAP concentration measured at control device outlet, dry basis, ppmv;

Q_a = total volumetric flowrate of all gas streams vented to the control device, except supplemental gases;

Q_s = total volumetric flowrate of supplemental gases.

(7) If flow to a control device could be intermittent, you must install, calibrate, and operate a flow indicator at the inlet or outlet of the control device to identify periods of no flow. Periods of no flow may not be used in daily or block averages, and it may not be used in fulfilling a minimum data availability requirement.

(8) *Terminology.* When the term "storage vessel" is used in subpart WW of this part 63, the term "process tank," as defined in §63.2550(i), applies for the purposes of this section.

(9) *Requirements for a biofilter.* If you use a biofilter to meet either the 95 percent reduction requirement or outlet concentration requirement specified in Table 2 to this subpart, you must meet the requirements specified in paragraphs (c)(9)(i) through (iv) of this section.

(i) *Operational requirements.* The biofilter must be operated at all times when emissions are vented to it.

(ii) *Performance tests.* To demonstrate initial compliance, you must conduct a performance test according to the procedures in §63.997 and paragraphs (c)(9)(ii)(A) through (D) of this section. The design evaluation option for small control devices is not applicable if you use a biofilter.

(A) Keep up-to-date, readily accessible continuous records of either the biofilter bed temperature averaged over the full period of the performance test or the outlet total organic HAP or TOC concentration averaged over the full period of the performance test. Include these data in your notification of compliance status report as required by §63.999(b)(3)(ii).

(B) Record either the percent reduction of total organic HAP achieved by the biofilter determined as specified in §63.997(e)(2)(iv) or the concentration of TOC or total organic HAP determined as specified in §63.997(e)(2)(iii) at the outlet of the biofilter, as applicable.

(C) If you monitor the biofilter bed temperature, you may elect to use multiple thermocouples in representative locations throughout the biofilter bed and calculate the average biofilter bed temperature across these thermocouples prior to reducing the temperature data to 15 minute (or shorter) averages

for purposes of establishing operating limits for the biofilter. If you use multiple thermocouples, include your rationale for their site selection in your notification of compliance status report.

(D) Submit a performance test report as specified in §63.999(a)(2)(i) and (ii). Include the records from paragraph (c)(9)(ii)(B) of this section in your performance test report.

(iii) *Monitoring requirements.* Use either a biofilter bed temperature monitoring device (or multiple devices) capable of providing a continuous record or an organic monitoring device capable of providing a continuous record. Keep records of temperature or other parameter monitoring results as specified in §63.998(b) and (c), as applicable. General requirements for monitoring are contained in §63.996. If you monitor temperature, the operating temperature range must be based on only the temperatures measured during the performance test; these data may not be supplemented by engineering assessments or manufacturer's recommendations as otherwise allowed in §63.999(b)(3)(ii)(A). If you establish the operating range (minimum and maximum temperatures) using data from previous performance tests in accordance with §63.996(c)(6), replacement of the biofilter media with the same type of media is not considered a process change under §63.997(b)(1). You may expand your biofilter bed temperature operating range by conducting a repeat performance test that demonstrates compliance with the 95 percent reduction requirement or outlet concentration limit, as applicable.

(iv) *Repeat performance tests.* You must conduct a repeat performance test using the applicable methods specified in §63.997 within 2 years following the previous performance test and within 150 days after each replacement of any portion of the biofilter bed media with a different type of media or each replacement of more than 50 percent (by volume) of the biofilter bed media with the same type of media.

[68 FR 63888, Nov. 10, 2003, as amended at 70 FR 38559, July 1, 2005; 71 FR 40333, July 14, 2006]

§ 63.2465 What requirements must I meet for process vents that emit hydrogen halide and halogen HAP or HAP metals?

(a) You must meet each emission limit in Table 3 to this subpart that applies to you, and you must meet each applicable requirement in paragraphs (b) through (d) of this section.

(b) If any process vents within a process emit hydrogen halide and halogen HAP, you must determine and sum the uncontrolled hydrogen halide and halogen HAP emissions from each of the process vents within the process using the procedures specified in §63.1257(d)(2)(i) and/or (ii), as appropriate. When §63.1257(d)(2)(ii)(E) requires documentation to be submitted in the precompliance report, it means the notification of compliance status report for the purposes of this paragraph.

(c) If collective uncontrolled hydrogen halide and halogen HAP emissions from the process vents within a process are greater than or equal to 1,000 pounds per year (lb/yr), you must comply with §63.994 and the requirements referenced therein, except as specified in paragraphs (c)(1) through (3) of this section.

(1) When §63.994(b)(1) requires a performance test, you may elect to conduct a design evaluation in accordance with §63.1257(a)(1).

(2) When §63.994(b)(1) refers to "a combustion device followed by a halogen scrubber or other halogen reduction device," it means any combination of control devices used to meet the emission limits specified in Table 3 to this subpart.

(3) Section 63.994(b)(2) does not apply for the purposes of this section.

(d) To demonstrate compliance with the emission limit in Table 3 to this subpart for HAP metals at a new source, you must comply with paragraphs (d)(1) through (3) of this section.

(1) Determine the mass emission rate of HAP metals based on process knowledge, engineering assessment, or test data.

(2) Conduct an initial performance test of each control device that is used to comply with the emission limit for HAP metals specified in Table 3 to this subpart. Conduct the performance test according to the procedures in §63.997. Use Method 29 of appendix A of 40 CFR part 60 to determine the HAP metals at

the inlet and outlet of each control device, or use Method 5 of appendix A of 40 CFR part 60 to determine the total particulate matter (PM) at the inlet and outlet of each control device. You have demonstrated initial compliance if the overall reduction of either HAP metals or total PM from the process is greater than or equal to 97 percent by weight.

(3) Comply with the monitoring requirements specified in §63.1366(b)(1)(xi) for each fabric filter used to control HAP metals.

[68 FR 63888, Nov. 10, 2003, as amended at 71 FR 40333, July 14, 2006]

§ 63.2470 What requirements must I meet for storage tanks?

(a) You must meet each emission limit in Table 4 to this subpart that applies to your storage tanks, and you must meet each applicable requirement specified in paragraphs (b) through (e) of this section.

(b) [Reserved]

(c) *Exceptions to subparts SS and WW of this part 63.* (1) If you conduct a performance test or design evaluation for a control device used to control emissions only from storage tanks, you must establish operating limits, conduct monitoring, and keep records using the same procedures as required in subpart SS of this part 63 for control devices used to reduce emissions from process vents instead of the procedures specified in §§63.985(c), 63.998(d)(2)(i), and 63.999(b)(2).

(2) When the term “storage vessel” is used in subparts SS and WW of this part 63, the term “storage tank,” as defined in §63.2550 applies for the purposes of this subpart.

(d) *Planned routine maintenance.* The emission limits in Table 4 to this subpart for control devices used to control emissions from storage tanks do not apply during periods of planned routine maintenance. Periods of planned routine maintenance of each control device, during which the control device does not meet the emission limit specified in Table 4 to this subpart, must not exceed 240 hours per year (hr/yr). You may submit an application to the Administrator requesting an extension of this time limit to a total of 360 hr/yr. The application must explain why the extension is needed, it must indicate that no material will be added to the storage tank between the time the 240-hr limit is exceeded and the control device is again operational, and it must be submitted at least 60 days before the 240-hr limit will be exceeded.

(e) *Vapor balancing alternative.* As an alternative to the emission limits specified in Table 4 to this subpart, you may elect to implement vapor balancing in accordance with §63.1253(f), except as specified in paragraphs (e)(1) through (3) of this section.

(1) When §63.1253(f)(6)(i) refers to a 90 percent reduction, 95 percent applies for the purposes of this subpart.

(2) To comply with §63.1253(f)(6)(i), the owner or operator of an offsite cleaning or reloading facility must comply with §§63.2445 through 63.2550 instead of complying with §63.1253(f)(7)(ii), except as specified in paragraph (e)(2)(i) or (ii) of this section.

(i) The reporting requirements in §63.2520 do not apply to the owner or operator of the offsite cleaning or reloading facility.

(ii) As an alternative to complying with the monitoring, recordkeeping, and reporting provisions in §§63.2445 through 63.2550, the owner or operator of an offsite cleaning or reloading facility may comply as specified in §63.2535(a)(2) with any other subpart of this part 63 which has monitoring, recordkeeping, and reporting provisions as specified in §63.2535(a)(2).

(3) You may elect to set a pressure relief device to a value less than the 2.5 pounds per square inch gage pressure (psig) required in §63.1253(f)(5) if you provide rationale in your notification of compliance status report explaining why the alternative value is sufficient to prevent breathing losses at all times.

(4) You may comply with the vapor balancing alternative in §63.1253(f) when your storage tank is filled from a barge. All requirements for tank trucks and railcars specified in §63.1253(f) also apply to barges,

except as specified in §63.2470(e)(4)(i).

(i) When §63.1253(f)(2) refers to pressure testing certifications, the requirements in 40 CFR 61.304(f) apply for barges.

(ii) [Reserved]

[68 FR 63888, Nov. 10, 2003, as amended at 70 FR 38559, July 1, 2005; 71 FR 40335, July 14, 2006]

§ 63.2475 What requirements must I meet for transfer racks?

(a) You must comply with each emission limit and work practice standard in Table 5 to this subpart that applies to your transfer racks, and you must meet each applicable requirement in paragraphs (b) and (c) of this section.

(b) When the term "high throughput transfer rack" is used in subpart SS of this part 63, the term "Group 1 transfer rack," as defined in §63.2550, applies for the purposes of this subpart.

[68 FR 63888, Nov. 10, 2003, as amended at 71 FR 40335, July 14, 2006]

§ 63.2480 What requirements must I meet for equipment leaks?

(a) You must meet each requirement in Table 6 to this subpart that applies to your equipment leaks, except as specified in paragraphs (b) through (d) of this section.

(b) If you comply with either subpart H or subpart UU of this part 63, you may elect to comply with the provisions in paragraphs (b)(1) through (5) of this section as an alternative to the referenced provisions in subpart H or subpart UU of this part.

(1) The requirements for pressure testing in §63.179(b) or §63.1036(b) may be applied to all processes, not just batch processes.

(2) For the purposes of this subpart, pressure testing for leaks in accordance with §63.179(b) or §63.1036(b) is not required after reconfiguration of an equipment train if flexible hose connections are the only disturbed equipment.

(3) For an existing source, you are not required to develop an initial list of identification numbers for connectors as would otherwise be required under §63.1022(b)(1) or §63.181(b)(1)(i).

(4) For connectors in gas/vapor and light liquid service at an existing source, you may elect to comply with the requirements in §63.169 or §63.1029 for connectors in heavy liquid service, including all associated recordkeeping and reporting requirements, rather than the requirements of §63.174 or §63.1027.

(5) For pumps in light liquid service in an MCPU that has no continuous process vents and is part of an existing source, you may elect to consider the leak definition that defines a leak to be 10,000 parts per million (ppm) or greater as an alternative to the values specified in §63.1026(b)(2)(i) through (iii) or §63.163(b)(2).

(c) If you comply with 40 CFR part 65, subpart F, you may elect to comply with the provisions in paragraphs (c)(1) through (9) of this section as an alternative to the referenced provisions in 40 CFR part 65, subpart F.

(1) The requirements for pressure testing in §65.117(b) may be applied to all processes, not just batch processes.

(2) For the purposes of this subpart, pressure testing for leaks in accordance with §65.117(b) is not required after reconfiguration of an equipment train if flexible hose connections are the only disturbed equipment.

- (3) For an existing source, you are not required to develop an initial list of identification numbers for connectors as would otherwise be required under §65.103(b)(1).
- (4) You may elect to comply with the monitoring and repair requirements specified in §65.108(e)(3) as an alternative to the requirements specified in §65.108(a) through (d) for any connectors at your affected source.
- (5) For pumps in light liquid service in an MCPU that has no continuous process vents and is part of an existing source, you may elect to consider the leak definition that defines a leak to be 10,000 ppm or greater as an alternative to the values specified in §65.107(b)(2)(i) through (iii).
- (6) When 40 CFR part 65, subpart F refers to the implementation date specified in §65.1(f), it means the compliance date specified in §63.2445.
- (7) When §§65.105(f) and 65.117(d)(3) refer to §65.4, it means §63.2525.
- (8) When §65.120(a) refers to §65.5(d), it means §63.2515.
- (9) When §65.120(b) refers to §65.5(e), it means §63.2520.
- (d) The provisions of this section do not apply to bench-scale processes, regardless of whether the processes are located at the same plant site as a process subject to the provisions of this subpart.

[71 FR 40335, July 14, 2006]

§ 63.2485 What requirements must I meet for wastewater streams and liquid streams in open systems within an MCPU?

- (a) You must meet each requirement in Table 7 to this subpart that applies to your wastewater streams and liquid streams in open systems within an MCPU, except as specified in paragraphs (b) through (o) of this section.
- (b) *Wastewater HAP.* Where §63.105 and §§63.132 through 63.148 refer to compounds in Table 9 of subpart G of this part 63, the compounds in Tables 8 and 9 to this subpart apply for the purposes of this subpart.
- (c) *Group 1 wastewater.* Section 63.132(c)(1) (i) and (ii) do not apply. For the purposes of this subpart, a process wastewater stream is Group 1 for compounds in Tables 8 and 9 to this subpart if any of the conditions specified in paragraphs (c) (1) through (3) of this section are met.
- (1) The total annual average concentration of compounds in Table 8 to this subpart is greater than or equal to 10,000 ppmw at any flowrate, and the total annual load of compounds in Table 8 to this subpart is greater than or equal to 200 lb/yr.
- (2) The total annual average concentration of compounds in Table 8 to this subpart is greater than or equal to 1,000 ppmw, and the annual average flowrate is greater than or equal to 1 l/min.
- (3) The combined total annual average concentration of compounds in Tables 8 and 9 to this subpart is greater than or equal to 30,000 ppmw, and the combined total annual load of compounds in Tables 8 and 9 to this subpart is greater than or equal to 1 tpy.
- (d) *Wastewater tank requirements.* (1) When §§63.133 and 63.147 reference floating roof requirements in §§63.119 and 63.120, the corresponding requirements in subpart WW of this part 63 may be applied for the purposes of this subpart.
- (2) When §63.133(a) refers to Table 10 of subpart G of this part 63, the maximum true vapor pressure in the table shall be limited to the HAP listed in Tables 8 and 9 of this subpart FFFF.
- (3) For the purposes of this subpart, the requirements of §63.133(a)(2) are satisfied by operating and

maintaining a fixed roof if you demonstrate that the total soluble and partially soluble HAP emissions from the wastewater tank are no more than 5 percent higher than the emissions would be if the contents of the wastewater tank were not heated, treated by an exothermic reaction, or sparged.

(4) The emission limits specified in §§63.133(b)(2) and 63.139 for control devices used to control emissions from wastewater tanks do not apply during periods of planned routine maintenance of the control device(s) of no more than 240 hr/yr. You may request an extension to a total of 360 hr/yr in accordance with the procedures specified in §63.2470(d).

(e) *Individual drain systems.* The provisions of §63.136(e)(3) apply except as specified in paragraph (e)(1) of this section.

(1) A sewer line connected to drains that are in compliance with §63.136(e)(1) may be vented to the atmosphere, provided that the sewer line entrance to the first downstream junction box is water sealed and the sewer line vent pipe is designed as specified in §63.136(e)(2)(ii)(A).

(2) [Reserved]

(f) *Closed-vent system requirements.* When §63.148(k) refers to closed vent systems that are subject to the requirements of §63.172, the requirements of either §63.172 or §63.1034 apply for the purposes of this subpart.

(g) *Halogenated vent stream requirements.* For each halogenated vent stream from a Group 1 wastewater stream or residual removed from a Group 1 wastewater stream that is vented through a closed-vent system to a combustion device to reduce organic HAP emissions, you must meet the same emission limits as specified for batch process vents in item 2 of Table 2 to this subpart.

(h) *Alternative test methods.* (1) As an alternative to the test methods specified in §63.144(b)(5)(i), you may use Method 8260 or 8270 as specified in §63.1257(b)(10)(iii).

(2) As an alternative to using the methods specified in §63.144(b)(5)(i), you may conduct wastewater analyses using Method 1666 or 1671 of 40 CFR part 136 and comply with the sampling protocol requirements specified in §63.144(b)(5)(ii). The validation requirements specified in §63.144(b)(5)(iii) do not apply if you use Method 1666 or 1671 of 40 CFR part 136.

(3) As an alternative to using Method 18 of 40 CFR part 60, as specified in §§63.139(c)(1)(ii) and 63.145(i)(2), you may elect to use Method 25A of 40 CFR part 60 as specified in §63.997.

(i) *Offsite management and treatment option.* (1) If you ship wastewater to an offsite treatment facility that meets the requirements of §63.138(h), you may elect to document in your notification of compliance status report that the wastewater will be treated as hazardous waste at a facility that meets the requirements of §63.138(h) as an alternative to having the offsite facility submit the certification specified in §63.132(g)(2).

(2) As an alternative to the management and treatment options specified in §63.132(g)(2), any affected wastewater stream (or residual removed from an affected wastewater stream) with a total annual average concentration of compounds in Table 8 to this subpart less than 50 ppmw may be transferred offsite in accordance with paragraphs (i)(2) (i) and (ii) of this section.

(i) The transferee (or you) must demonstrate that less than 5 percent of the HAP in Table 9 to this subpart is emitted from the waste management units up to the activated sludge unit.

(ii) The transferee must treat the wastewater stream or residual in a biological treatment unit in accordance with §§63.138 and 63.145 and the requirements referenced therein.

(j) You must determine the annual average concentration and annual average flowrate for wastewater streams for each MCPU. The procedures for flexible operation units specified in §63.144 (b) and (c) do not apply for the purposes of this subpart.

(k) The requirement to correct outlet concentrations from combustion devices to 3 percent oxygen in

§§63.139(c)(1)(ii) and 63.146(i)(6) applies only if supplemental gases are combined with a vent stream from a Group 1 wastewater stream. If emissions are controlled with a vapor recovery system as specified in §63.139(c)(2), you must correct for supplemental gases as specified in §63.2460(c)(6).

(l) *Requirements for liquid streams in open systems.* (1) References in §63.149 to §63.100(b) mean §63.2435(b) for the purposes of this subpart.

(2) When §63.149(e) refers to 40 CFR 63.100(l) (1) or (2), §63.2445(a) applies for the purposes of this subpart.

(3) When §63.149 uses the term “chemical manufacturing process unit,” the term “MCPU” applies for the purposes of this subpart.

(4) When §63.149(e)(1) refers to characteristics of water that contain compounds in Table 9 to 40 CFR part 63, subpart G, the characteristics specified in paragraphs (c) (1) through (3) of this section apply for the purposes of this subpart.

(5) When §63.149(e)(2) refers to characteristics of water that contain compounds in Table 9 to 40 CFR part 63, subpart G, the characteristics specified in paragraph (c)(2) of this section apply for the purposes of this subpart.

(m) When §63.132(f) refers to “a concentration of greater than 10,000 ppmw of Table 9 compounds,” the phrase “a concentration of greater than 30,000 ppmw of total partially soluble HAP (PSHAP) and soluble HAP (SHAP) or greater than 10,000 ppmw of PSHAP” shall apply for the purposes of this subpart.

(n) *Alternative requirements for wastewater that is Group 1 for soluble HAP only.* The option specified in this paragraph (n) applies to wastewater that is Group 1 for soluble HAP in accordance with paragraph (c)(3) of this section and is discharged to biological treatment. Except as provided in paragraph (n)(4) of this section, this option does not apply to wastewater that is Group 1 for partially soluble HAP in accordance with paragraph (c)(1), (c)(2), or (c)(4) of this section. For wastewater that is Group 1 for SHAP, you need not comply with §§63.133 through 63.137 for any equalization unit, neutralization unit, and/or clarifier prior to the activated sludge unit, and you need not comply with the venting requirements in §63.136(e)(2)(ii)(A) for lift stations with a volume larger than 10,000 gal, provided you comply with the requirements specified in paragraphs (n)(1) through (3) of this section and all otherwise applicable requirements specified in Table 7 to this subpart. For this option, the treatment requirements in §63.138 and the performance testing requirements in §63.145 do not apply to the biological treatment unit, except as specified in paragraphs (n)(2)(i) through (iv) of this section.

(1) Wastewater must be hard-piped between the equalization unit, clarifier, and activated sludge unit. This requirement does not apply to the transfer between any of these types of units that are part of the same structure and one unit overflows into the next.

(2) Calculate the destruction efficiency of the biological treatment unit using Equation 1 of this section in accordance with the procedures described in paragraphs (n)(2)(i) through (vi) of this section. You have demonstrated initial compliance if E is greater than or equal to 90 percent.

$$E = \frac{(QMW_a - QMG_a - QMG_e - QMG_c)(F_{\text{bio}})}{QMW_a} \times 100 \quad (\text{Eq. 1})$$

Where:

E = destruction efficiency of total PSHAP and SHAP for the biological treatment unit including the equalization unit, neutralization unit, and/or clarifier, percent;

QMW_a = mass flow rate of total PSHAP and SHAP compounds entering the equalization unit (or whichever of the three types of units is first), kilograms per hour (kg/hr);

QMG_e = mass flow rate of total PSHAP and SHAP compounds emitted from the equalization unit, kg/hr;

QMG_n = mass flow rate of total PSHAP and SHAP compounds emitted from the neutralization unit, kg/hr;

QMG_c = mass flow rate of total PSHAP and SHAP compounds emitted from the clarifier, kg/hr

F_{bio} = site-specific fraction of PSHAP and SHAP compounds biodegraded in the biological treatment unit.

(i) Include all PSHAP and SHAP compounds in both Group 1 and Group 2 wastewater streams from all MCPU, except you may exclude any compounds that meet the criteria specified in §63.145(a)(6)(ii) or (iii).

(ii) Conduct the demonstration under representative process unit and treatment unit operating conditions in accordance with §63.145(a)(3) and (4).

(iii) Determine PSHAP and SHAP concentrations and the total wastewater flow rate at the inlet to the equalization unit in accordance with §63.145(f)(1) and (2). References in §63.145(f)(1) and (2) to required mass removal and actual mass removal do not apply for the purposes of this section.

(iv) Determine F_{bio} for the activated sludge unit as specified in §63.145(h), except as specified in paragraph (n)(2)(iv)(A) or paragraph (n)(2)(iv)(B) of this section.

(A) If the biological treatment process meets both of the requirements specified in §63.145(h)(1)(i) and (ii), you may elect to replace the F_{bio} term in Equation 1 of this section with the numeral "1."

(B) You may elect to assume f_{bio} is zero for any compounds on List 2 of Table 36 in subpart G.

(v) Determine QMG_e , QMG_n , and QMG_c using EPA's WATER9 model or the most recent update to this model, and conduct testing or use other procedures to validate the modeling results.

(vi) Submit the data and results of your demonstration, including both a description of and the results of your WATER9 modeling validation procedures, in your notification of compliance status report as specified in §63.2520(d)(2)(ii).

(3) As an alternative to the venting requirements in §63.136(e)(2)(ii)(A), a lift station with a volume larger than 10,000 gal may have openings necessary for proper venting of the lift station. The size and other design characteristics of these openings may be established based on manufacturer recommendations or engineering judgment for venting under normal operating conditions. You must describe the design of such openings and your supporting calculations and other rationale in your notification of compliance status report.

(4) For any wastewater streams that are Group 1 for both PSHAP and SHAP, you may elect to meet the requirements specified in Table 7 to this subpart for the PSHAP and then comply with paragraphs (n)(1) through (3) of this section for the SHAP in the wastewater system. You may determine the SHAP mass removal rate, in kg/hr, in treatment units that are used to meet the requirements for PSHAP and add this amount to both the numerator and denominator in Equation 1 of this section.

(o) *Compliance records.* For each CPMS used to monitor a nonflare control device for wastewater emissions, you must keep records as specified in §63.998(c)(1) in addition to the records required in §63.147(d).

[68 FR 63888, Nov. 10, 2003, as amended at 70 FR 38559, July 1, 2005; 71 FR 40335, July 14, 2006]

§ 63.2490 What requirements must I meet for heat exchange systems?

(a) You must comply with each requirement in Table 10 to this subpart that applies to your heat exchange systems, except as specified in paragraphs (b) and (c) of this section.

(b) The phrase "a chemical manufacturing process unit meeting the conditions of §63.100 (b)(1) through

(b)(3) of this section" in §63.104(a) means "an MCPU meeting the conditions of §63.2435" for the purposes of this subpart.

(c) The reference to §63.100(c) in §63.104(a) does not apply for the purposes of this subpart.

Alternative Means of Compliance

§ 63.2495 How do I comply with the pollution prevention standard?

(a) You may elect to comply with the pollution prevention alternative requirements specified in paragraphs (a) (1) and (2) of this section in lieu of the emission limitations and work practice standards contained in Tables 1 through 7 to this subpart for any MCPU for which initial startup occurred before April 4, 2002.

(1) You must reduce the production-indexed HAP consumption factor (HAP factor) by at least 65 percent from a 3-year average baseline beginning no earlier than the 1994 through 1996 calendar years. For any reduction in the HAP factor that you achieve by reducing HAP that are also volatile organic compounds (VOC), you must demonstrate an equivalent reduction in the production-indexed VOC consumption factor (VOC factor) on a mass basis. For any reduction in the HAP factor that you achieve by reducing a HAP that is not a VOC, you may not increase the VOC factor.

(2) Any MCPU for which you seek to comply by using the pollution prevention alternative must begin with the same starting material(s) and end with the same product(s). You may not comply by eliminating any steps of a process by transferring the step offsite (to another manufacturing location). You may also not merge a solvent recovery step conducted offsite to onsite and as part of an existing process as a method of reducing consumption.

(3) You may comply with the requirements of paragraph (a)(1) of this section for a series of processes, including situations where multiple processes are merged, if you demonstrate to the satisfaction of the Administrator that the multiple processes were merged after the baseline period into an existing process or processes.

(b) *Exclusions.* (1) You must comply with the emission limitations and work practice standards contained in Tables 1 through 7 of this subpart for all HAP that are generated in the MCPU and that are not included in consumption, as defined in §63.2550. If any vent stream routed to the combustion control is a halogenated vent stream, as defined in §63.2550, then hydrogen halides that are generated as a result of combustion control must be controlled according to the requirements of §63.994 and the requirements referenced therein.

(2) You may not merge nondedicated formulation or nondedicated solvent recovery processes with any other processes.

(c) *Initial compliance procedures.* To demonstrate initial compliance with paragraph (a) of this section, you must prepare a demonstration summary in accordance with paragraph (c) (1) of this section and calculate baseline and target annual HAP and VOC factors in accordance with paragraphs (c) (2) and (3) of this section.

(1) *Demonstration plan.* You must prepare a pollution prevention demonstration plan that contains, at a minimum, the information in paragraphs (c)(1) (i) through (iii) of this section for each MCPU for which you comply with paragraph (a) of this section.

(i) Descriptions of the methodologies and forms used to measure and record consumption of HAP and VOC compounds.

(ii) Descriptions of the methodologies and forms used to measure and record production of the product (s).

(iii) Supporting documentation for the descriptions provided in accordance with paragraphs (c)(1) (i) and (ii) of this section including, but not limited to, samples of operator log sheets and daily, monthly, and/or annual inventories of materials and products. You must describe how this documentation will be used to

calculate the annual factors required in paragraph (d) of this section.

(2) *Baseline factors.* You must calculate baseline HAP and VOC factors by dividing the consumption of total HAP and total VOC by the production rate, per process, for the first 3-year period in which the process was operational, beginning no earlier than the period consisting of the 1994 through 1996 calendar years.

(3) *Target annual factors.* You must calculate target annual HAP and VOC factors. The target annual HAP factor must be equal to 35 percent of the baseline HAP factor. The target annual VOC factor must be lower than the baseline VOC factor by an amount equivalent to the reduction in any HAP that is also a VOC, on a mass basis. The target annual VOC factor may be the same as the baseline VOC factor if the only HAP you reduce is not a VOC.

(d) *Continuous compliance requirements.* You must calculate annual rolling average values of the HAP and VOC factors (annual factors) in accordance with the procedures specified in paragraphs (d) (1) through (3) of this section. To show continuous compliance, the annual factors must be equal to or less than the target annual factors calculated according to paragraph (c)(3) of this section.

(1) To calculate the annual factors, you must divide the consumption of both total HAP and total VOC by the production rate, per process, for 12-month periods at the frequency specified in either paragraph (d) (2) or (3) of this section, as applicable.

(2) For continuous processes, you must calculate the annual factors every 30 days for the 12-month period preceding the 30th day (i.e., annual rolling average calculated every 30 days). A process with both batch and continuous operations is considered a continuous process for the purposes of this section.

(3) For batch processes, you must calculate the annual factors every 10 batches for the 12-month period preceding the 10th batch (i.e., annual rolling average calculated every 10 batches), except as specified in paragraphs (d)(3) (i) and (ii) of this section.

(i) If you produce more than 10 batches during a month, you must calculate the annual factors at least once during that month.

(ii) If you produce less than 10 batches in a 12-month period, you must calculate the annual factors for the number of batches in the 12-month period since the previous calculations.

(e) *Records.* You must keep records of HAP and VOC consumption, production, and the rolling annual HAP and VOC factors for each MCPU for which you are complying with paragraph (a) of this section.

(f) *Reporting.* (1) You must include the pollution prevention demonstration plan in the precompliance report required by §63.2520(c).

(2) You must identify all days when the annual factors were above the target factors in the compliance reports.

[68 FR 63888, Nov. 10, 2003, as amended at 71 FR 40336, July 14, 2006]

§ 63.2500 How do I comply with emissions averaging?

(a) For an existing source, you may elect to comply with the percent reduction emission limitations in Tables 1, 2, 4, 5, and 7 to this subpart by complying with the emissions averaging provisions specified in §63.150, except as specified in paragraphs (b) through (f) of this section.

(b) The batch process vents in an MCPU collectively are considered one individual emission point for the purposes of emissions averaging, except that only individual batch process vents must be excluded to meet the requirements of §63.150(d)(5).

(c) References in §63.150 to §§63.112 through 63.130 mean the corresponding requirements in §§63.2450 through 63.2490, including applicable monitoring, recordkeeping, and reporting.

(d) References to “periodic reports” in §63.150 mean “compliance report” for the purposes of this subpart.

(e) For batch process vents, estimate uncontrolled emissions for a standard batch using the procedures in §63.1257(d)(2)(i) and (ii) instead of the procedures in §63.150(g)(2). Multiply the calculated emissions per batch by the number of batches per month when calculating the monthly emissions for use in calculating debits and credits.

(f) References to “storage vessels” in §63.150 mean “storage tank” as defined in §63.2550 for the purposes of this subpart.

§ 63.2505 How do I comply with the alternative standard?

As an alternative to complying with the emission limits and work practice standards for process vents and storage tanks in Tables 1 through 4 to this subpart and the requirements in §§63.2455 through 63.2470, you may comply with the emission limits in paragraph (a) of this section and demonstrate compliance in accordance with the requirements in paragraph (b) of this section.

(a) *Emission limits and work practice standards.* (1) You must route vent streams through a closed-vent system to a control device that reduces HAP emissions as specified in either paragraph (a)(1)(i) or (ii) of this section.

(i) If you use a combustion control device, it must reduce HAP emissions as specified in paragraphs (a)(1)(i)(A), (B), and (C) of this section.

(A) To an outlet TOC concentration of 20 parts per million by volume (ppmv) or less.

(B) To an outlet concentration of hydrogen halide and halogen HAP of 20 ppmv or less.

(C) As an alternative to paragraph (a)(1)(i)(B) of this section, if you control halogenated vent streams emitted from a combustion device followed by a scrubber, reduce the hydrogen halide and halogen HAP generated in the combustion device by greater than or equal to 95 percent by weight in the scrubber.

(ii) If you use a noncombustion control device(s), it must reduce HAP emissions to an outlet total organic HAP concentration of 50 ppmv or less, and an outlet concentration of hydrogen halide and halogen HAP of 50 ppmv or less.

(2) Any Group 1 process vents within a process that are not controlled according to this alternative standard must be controlled according to the emission limits in Tables 1 through 3 to this subpart.

(b) *Compliance requirements.* To demonstrate compliance with paragraph (a) of this section, you must meet the requirements of §63.1258(b)(5) beginning no later than the initial compliance date specified in §63.2445, except as specified in paragraphs (b)(1) through (9) of this section.

(1) You must comply with the requirements in §63.983 and the requirements referenced therein for closed-vent systems.

(2) When §63.1258(b)(5)(i) refers to §§63.1253(d) and 63.1254(c), the requirements in paragraph (a) of this section apply for the purposes of this subpart FFFF.

(3) When §63.1258(b)(5)(i)(B) refers to “HCl,” it means “total hydrogen halide and halogen HAP” for the purposes of this subpart FFFF.

(4) When §63.1258(b)(5)(ii) refers to §63.1257(a)(3), it means §63.2450(j)(5) for the purposes of this subpart FFFF.

(5) You must submit the results of any determination of the target analytes of predominant HAP in the notification of compliance status report.

(6) If you elect to comply with the requirement to reduce hydrogen halide and halogen HAP by greater than or equal to 95 percent by weight in paragraph (a)(1)(i)(C) of this section, you must meet the requirements in paragraphs (b)(6)(i) and (ii) of this section.

(i) Demonstrate initial compliance with the 95 percent reduction by conducting a performance test and setting a site-specific operating limit(s) for the scrubber in accordance with §63.994 and the requirements referenced therein. You must submit the results of the initial compliance demonstration in the notification of compliance status report.

(ii) Install, operate, and maintain CPMS for the scrubber as specified in §§63.994(c) and 63.2450(k), instead of as specified in §63.1258(b)(5)(i)(C).

(7) If flow to the scrubber could be intermittent, you must install, calibrate, and operate a flow indicator as specified in §63.2460(c)(7).

(8) Use the operating day as the averaging period for CEMS data and scrubber parameter monitoring data.

(9) The requirements in paragraph (a) of this section do not apply to emissions from storage tanks during periods of planned routine maintenance of the control device that do not exceed 240 hr/yr. You may submit an application to the Administrator requesting an extension of this time limit to a total of 360 hr/yr in accordance with the procedures specified in §63.2470(d). You must comply with the recordkeeping and reporting specified in §§63.998(d)(2)(ii) and 63.999(c)(4) for periods of planned routine maintenance.

[68 FR 63888, Nov. 10, 2003, as amended at 70 FR 38559, July 1, 2005]

Notification, Reports, and Records

§ 63.2515 What notifications must I submit and when?

(a) You must submit all of the notifications in §§63.6(h)(4) and (5), 63.7(b) and (c), 63.8(e), (f)(4) and (6), and 63.9(b) through (h) that apply to you by the dates specified.

(b) *Initial notification.* As specified in §63.9(b)(2), if you startup your affected source before November 10, 2003, you must submit an initial notification not later than 120 calendar days after November 10, 2003.

(2) As specified in §63.9(b)(3), if you startup your new affected source on or after November 10, 2003, you must submit an initial notification not later than 120 calendar days after you become subject to this subpart.

(c) *Notification of performance test.* If you are required to conduct a performance test, you must submit a notification of intent to conduct a performance test at least 60 calendar days before the performance test is scheduled to begin as required in §63.7(b)(1). For any performance test required as part of the initial compliance procedures for batch process vents in Table 2 to this subpart, you must also submit the test plan required by §63.7(c) and the emission profile with the notification of the performance test.

§ 63.2520 What reports must I submit and when?

(a) You must submit each report in Table 11 to this subpart that applies to you.

(b) Unless the Administrator has approved a different schedule for submission of reports under §63.10 (a), you must submit each report by the date in Table 11 to this subpart and according to paragraphs (b) (1) through (5) of this section.

(1) The first compliance report must cover the period beginning on the compliance date that is specified for your affected source in §63.2445 and ending on June 30 or December 31, whichever date is the first date following the end of the first 6 months after the compliance date that is specified for your affected

source in §63.2445.

(2) The first compliance report must be postmarked or delivered no later than August 31 or February 28, whichever date is the first date following the end of the first reporting period specified in paragraph (b)(1) of this section.

(3) Each subsequent compliance report must cover the semiannual reporting period from January 1 through June 30 or the semiannual reporting period from July 1 through December 31.

(4) Each subsequent compliance report must be postmarked or delivered no later than August 31 or February 28, whichever date is the first date following the end of the semiannual reporting period.

(5) For each affected source that is subject to permitting regulations pursuant to 40 CFR part 70 or 40 CFR part 71, and if the permitting authority has established dates for submitting semiannual reports pursuant to 40 CFR 70.6(a)(3)(iii)(A) or 40 CFR 71.6(a)(3)(iii)(A), you may submit the first and subsequent compliance reports according to the dates the permitting authority has established instead of according to the dates in paragraphs (b)(1) through (4) of this section.

(c) *Precompliance report.* You must submit a precompliance report to request approval for any of the items in paragraphs (c)(1) through (7) of this section. We will either approve or disapprove the report within 90 days after we receive it. If we disapprove the report, you must still be in compliance with the emission limitations and work practice standards in this subpart by the compliance date. To change any of the information submitted in the report, you must notify us 60 days before the planned change is to be implemented.

(1) Requests for approval to set operating limits for parameters other than those specified in §§63.2455 through 63.2485 and referenced therein. Alternatively, you may make these requests according to §63.8(f).

(2) Descriptions of daily or per batch demonstrations to verify that control devices subject to §63.2460(c)(5) are operating as designed.

(3) A description of the test conditions, data, calculations, and other information used to establish operating limits according to §63.2460(c)(3).

(4) Data and rationale used to support an engineering assessment to calculate uncontrolled emissions in accordance with §63.1257(d)(2)(ii). This requirement does not apply to calculations of hydrogen halide and halogen HAP emissions as specified in §63.2465(b), to determinations that the total HAP concentration is less than 50 ppmv, or if you use previous test data to establish the uncontrolled emissions.

(5) The pollution prevention demonstration plan required in §63.2495(c)(1), if you are complying with the pollution prevention alternative.

(6) Documentation of the practices that you will implement to minimize HAP emissions from streams that contain energetics and organic peroxides, and rationale for why meeting the emission limit specified in Tables 1 through 7 to this subpart would create an undue safety hazard.

(7) For fabric filters that are monitored with bag leak detectors, an operation and maintenance plan that describes proper operation and maintenance procedures, and a corrective action plan that describes corrective actions to be taken, and the timing of those actions, when the PM concentration exceeds the set point and activates the alarm.

(d) *Notification of compliance status report.* You must submit a notification of compliance status report according to the schedule in paragraph (d)(1) of this section, and the notification of compliance status report must contain the information specified in paragraph (d)(2) of this section.

(1) You must submit the notification of compliance status report no later than 150 days after the applicable compliance date specified in §63.2445.

(2) The notification of compliance status report must include the information in paragraphs (d)(2)(i) through (ix) of this section.

(i) The results of any applicability determinations, emission calculations, or analyses used to identify and quantify HAP usage or HAP emissions from the affected source.

(ii) The results of emissions profiles, performance tests, engineering analyses, design evaluations, flare compliance assessments, inspections and repairs, and calculations used to demonstrate initial compliance according to §§63.2455 through 63.2485. For performance tests, results must include descriptions of sampling and analysis procedures and quality assurance procedures.

(iii) Descriptions of monitoring devices, monitoring frequencies, and the operating limits established during the initial compliance demonstrations, including data and calculations to support the levels you establish.

(iv) All operating scenarios.

(v) Descriptions of worst-case operating and/or testing conditions for control devices.

(vi) Identification of parts of the affected source subject to overlapping requirements described in §63.2535 and the authority under which you will comply.

(vii) The information specified in §63.1039(a)(1) through (3) for each process subject to the work practice standards for equipment leaks in Table 6 to this subpart.

(viii) Identify storage tanks for which you are complying with the vapor balancing alternative in §63.2470 (e).

(ix) Records as specified in §63.2535(l)(1) through (3) of process units used to create a PUG and calculations of the initial primary product of the PUG.

(e) *Compliance report.* The compliance report must contain the information specified in paragraphs (e) (1) through (10) of this section.

(1) Company name and address.

(2) Statement by a responsible official with that official's name, title, and signature, certifying the accuracy of the content of the report.

(3) Date of report and beginning and ending dates of the reporting period.

(4) For each SSM during which excess emissions occur, the compliance report must include records that the procedures specified in your startup, shutdown, and malfunction plan (SSMP) were followed or documentation of actions taken that are not consistent with the SSMP, and include a brief description of each malfunction.

(5) The compliance report must contain the information on deviations, as defined in §63.2550, according to paragraphs (e)(5)(i), (ii), (iii), and (iv) of this section.

(i) If there are no deviations from any emission limit, operating limit or work practice standard specified in this subpart, include a statement that there were no deviations from the emission limits, operating limits, or work practice standards during the reporting period.

(ii) For each deviation from an emission limit, operating limit, and work practice standard that occurs at an affected source where you are not using a continuous monitoring system (CMS) to comply with the emission limit or work practice standard in this subpart, you must include the information in paragraphs (e)(5)(ii)(A) through (C) of this section. This includes periods of SSM.

(A) The total operating time of the affected source during the reporting period.

(B) Information on the number, duration, and cause of deviations (including unknown cause, if applicable), as applicable, and the corrective action taken.

(C) Operating logs of processes with batch vents from batch operations for the day(s) during which the deviation occurred, except operating logs are not required for deviations of the work practice standards for equipment leaks.

(iii) For each deviation from an emission limit or operating limit occurring at an affected source where you are using a CMS to comply with an emission limit in this subpart, you must include the information in paragraphs (e)(5)(iii)(A) through (L) of this section. This includes periods of SSM.

(A) The date and time that each CMS was inoperative, except for zero (low-level) and high-level checks.

(B) The date, time, and duration that each CEMS was out-of-control, including the information in §63.8(c)(8).

(C) The date and time that each deviation started and stopped, and whether each deviation occurred during a period of startup, shutdown, or malfunction or during another period.

(D) A summary of the total duration of the deviation during the reporting period, and the total duration as a percent of the total operating time of the affected source during that reporting period.

(E) A breakdown of the total duration of the deviations during the reporting period into those that are due to startup, shutdown, control equipment problems, process problems, other known causes, and other unknown causes.

(F) A summary of the total duration of CMS downtime during the reporting period, and the total duration of CMS downtime as a percent of the total operating time of the affected source during that reporting period.

(G) An identification of each HAP that is known to be in the emission stream.

(H) A brief description of the process units.

(I) A brief description of the CMS.

(J) The date of the latest CMS certification or audit.

(K) Operating logs of processes with batch vents from batch operations for each day(s) during which the deviation occurred.

(L) The operating day or operating block average values of monitored parameters for each day(s) during which the deviation occurred.

(iv) If you documented in your notification of compliance status report that an MCPU has Group 2 batch process vents because the non-reactive HAP is the only HAP and usage is less than 10,000 lb/yr, the total uncontrolled organic HAP emissions from the batch process vents in an MCPU will be less than 1,000 lb/yr for the anticipated number of standard batches, or total uncontrolled hydrogen halide and halogen HAP emissions from all batch process vents and continuous process vents in a process are less than 1,000 lb/yr, include the records associated with each calculation required by §63.2525(e) that exceeds an applicable HAP usage or emissions threshold.

(6) If you use a CEMS, and there were no periods during which it was out-of-control as specified in §63.8(c)(7), include a statement that there were no periods during which the CEMS was out-of-control during the reporting period.

(7) Include each new operating scenario which has been operated since the time period covered by the last compliance report and has not been submitted in the notification of compliance status report or a previous compliance report. For each new operating scenario, you must provide verification that the

operating conditions for any associated control or treatment device have not been exceeded and that any required calculations and engineering analyses have been performed. For the purposes of this paragraph, a revised operating scenario for an existing process is considered to be a new operating scenario.

(8) Records of process units added to a PUG as specified in §63.2525(i)(4) and records of primary product redeterminations as specified in §63.2525(i)(5).

(9) Applicable records and information for periodic reports as specified in referenced subparts F, G, H, SS, UU, WW, and GGG of this part and subpart F of 40 CFR part 65.

(10) *Notification of process change.* (i) Except as specified in paragraph (e)(10)(ii) of this section, whenever you make a process change, or change any of the information submitted in the notification of compliance status report or a previous compliance report, that is not within the scope of an existing operating scenario, you must document the change in your compliance report. A process change does not include moving within a range of conditions identified in the standard batch, and a nonstandard batch does not constitute a process change. The notification must include all of the information in paragraphs (e)(10)(i)(A) through (C) of this section.

(A) A description of the process change.

(B) Revisions to any of the information reported in the original notification of compliance status report under paragraph (d) of this section.

(C) Information required by the notification of compliance status report under paragraph (d) of this section for changes involving the addition of processes or equipment at the affected source.

(ii) You must submit a report 60 days before the scheduled implementation date of any of the changes identified in paragraph (e)(10)(ii)(A), (B), or (C) of this section.

(A) Any change to the information contained in the precompliance report.

(B) A change in the status of a control device from small to large.

(C) A change from Group 2 to Group 1 for any emission point except for batch process vents that meet the conditions specified in §63.2460(b)(6)(i).

[68 FR 63888, Nov. 10, 2003, as amended at 70 FR 38560, July 1, 2005; 71 FR 40336, July 14, 2006]

§ 63.2525 What records must I keep?

You must keep the records specified in paragraphs (a) through (k) of this section.

(a) Each applicable record required by subpart A of this part 63 and in referenced subparts F, G, SS, UU, WW, and GGG of this part 63 and in referenced subpart F of 40 CFR part 65.

(b) Records of each operating scenario as specified in paragraphs (b)(1) through (8) of this section.

(1) A description of the process and the type of process equipment used.

(2) An identification of related process vents, including their associated emissions episodes if not complying with the alternative standard in §63.2505; wastewater point of determination (POD); storage tanks; and transfer racks.

(3) The applicable control requirements of this subpart, including the level of required control, and for vents, the level of control for each vent.

(4) The control device or treatment process used, as applicable, including a description of operating

and/or testing conditions for any associated control device.

(5) The process vents, wastewater POD, transfer racks, and storage tanks (including those from other processes) that are simultaneously routed to the control device or treatment process(s).

(6) The applicable monitoring requirements of this subpart and any parametric level that assures compliance for all emissions routed to the control device or treatment process.

(7) Calculations and engineering analyses required to demonstrate compliance.

(8) For reporting purposes, a change to any of these elements not previously reported, except for paragraph (b)(5) of this section, constitutes a new operating scenario.

(c) A schedule or log of operating scenarios for processes with batch vents from batch operations updated each time a different operating scenario is put into effect.

(d) The information specified in paragraphs (d)(1) and (2) of this section for Group 1 batch process vents in compliance with a percent reduction emission limit in Table 2 to this subpart if some of the vents are controlled to less the percent reduction requirement.

(1) Records of whether each batch operated was considered a standard batch.

(2) The estimated uncontrolled and controlled emissions for each batch that is considered to be a nonstandard batch.

(e) The information specified in paragraph (e)(2), (3), or (4) of this section, as applicable, for each process with Group 2 batch process vents or uncontrolled hydrogen halide and halogen HAP emissions from the sum of all batch and continuous process vents less than 1,000 lb/yr. No records are required for situations described in paragraph (e)(1) of this section.

(1) No records are required if you documented in your notification of compliance status report that the MCPU meets any of the situations described in paragraph (e)(1)(i), (ii), or (iii) of this section.

(i) The MCPU does not process, use, or generate HAP.

(ii) You control the Group 2 batch process vents using a flare that meets the requirements of §63.987.

(iii) You control the Group 2 batch process vents using a control device for which your determination of worst case for initial compliance includes the contribution of all Group 2 batch process vents.

(2) If you documented in your notification of compliance status report that an MCPU has Group 2 batch process vents because the non-reactive organic HAP is the only HAP and usage is less than 10,000 lb/yr, as specified in §63.2460(b)(7), you must keep records of the amount of HAP material used, and calculate the daily rolling annual sum of the amount used no less frequently than monthly. If a record indicates usage exceeds 10,000 lb/yr, you must estimate emissions for the preceding 12 months based on the number of batches operated and the estimated emissions for a standard batch, and you must begin recordkeeping as specified in paragraph (e)(4) of this section. After 1 year, you may revert to recording only usage if the usage during the year is less than 10,000 lb.

(3) If you documented in your notification of compliance status report that total uncontrolled organic HAP emissions from the batch process vents in an MCPU will be less than 1,000 lb/yr for the anticipated number of standard batches, then you must keep records of the number of batches operated and calculate a daily rolling annual sum of batches operated no less frequently than monthly. If the number of batches operated results in organic HAP emissions that exceed 1,000 lb/yr, you must estimate emissions for the preceding 12 months based on the number of batches operated and the estimated emissions for a standard batch, and you must begin recordkeeping as specified in paragraph (e)(4) of this section. After 1 year, you may revert to recording only the number of batches if the number of batches operated during the year results in less than 1,000 lb of organic HAP emissions.

(4) If you meet none of the conditions specified in paragraphs (e)(1) through (3) of this section, you must

keep records of the information specified in paragraphs (e)(4)(i) through (iv) of this section.

(i) A record of the day each batch was completed and/or the operating hours per day for continuous operations with hydrogen halide and halogen emissions.

(ii) A record of whether each batch operated was considered a standard batch.

(iii) The estimated uncontrolled and controlled emissions for each batch that is considered to be a nonstandard batch.

(iv) Records of the daily 365-day rolling summations of emissions, or alternative records that correlate to the emissions (e.g., number of batches), calculated no less frequently than monthly.

(f) A record of each time a safety device is opened to avoid unsafe conditions in accordance with §63.2450(s).

(g) Records of the results of each CPMS calibration check and the maintenance performed, as specified in §63.2450(k)(1).

(h) For each CEMS, you must keep records of the date and time that each deviation started and stopped, and whether the deviation occurred during a period of startup, shutdown, or malfunction or during another period.

(i) For each PUG, you must keep records specified in paragraphs (i)(1) through (5) of this section.

(1) Descriptions of the MCPU and other process units in the initial PUG required by §63.2535(l)(1)(v).

(2) Rationale for including each MCPU and other process unit in the initial PUG (*i.e.*, identify the overlapping equipment between process units) required by §63.2535(l)(1)(v).

(3) Calculations used to determine the primary product for the initial PUG required by §63.2535(l)(2)(iv).

(4) Descriptions of process units added to the PUG after the creation date and rationale for including the additional process units in the PUG as required by §63.2535(l)(1)(v).

(5) The calculation of each primary product redetermination required by §63.2535(l)(2)(iv).

(j) In the SSMP required by §63.6(e)(3), you are not required to include Group 2 emission points, unless those emission points are used in an emissions average. For equipment leaks, the SSMP requirement is limited to control devices and is optional for other equipment.

(k) For each bag leak detector used to monitor PM HAP emissions from a fabric filter, maintain records of any bag leak detection alarm, including the date and time, with a brief explanation of the cause of the alarm and the corrective action taken.

[68 FR 63888, Nov. 10, 2003, as amended at 70 FR 38560, July 1, 2005; 71 FR 40337, July 14, 2006]

Other Requirements and Information

§ 63.2535 What compliance options do I have if part of my plant is subject to both this subpart and another subpart?

For any equipment, emission stream, or wastewater stream subject to the provisions of both this subpart and another rule, you may elect to comply only with the provisions as specified in paragraphs (a) through (l) of this section. You also must identify the subject equipment, emission stream, or wastewater stream, and the provisions with which you will comply, in your notification of compliance status report required by §63.2520(d).

(a) *Compliance with other subparts of this part 63.* (1) If you have an MCPU that includes a batch process vent that also is part of a CMPU as defined in subparts F and G of this part 63, you must comply with the emission limits; operating limits; work practice standards; and the compliance, monitoring, reporting, and recordkeeping requirements for batch process vents in this subpart, and you must continue to comply with the requirements in subparts F, G, and H of this part 63 that are applicable to the CMPU and associated equipment.

(2) After the compliance dates specified in §63.2445, at an offsite reloading or cleaning facility subject to §63.1253(f), as referenced from §63.2470(e), compliance with the monitoring, recordkeeping, and reporting provisions of any other subpart of this part 63 constitutes compliance with the monitoring, recordkeeping, and reporting provisions of §63.1253(f)(7)(ii) or §63.1253(f)(7)(iii). You must identify in your notification of compliance status report required by §63.2520(d) the subpart of this part 63 with which the owner or operator of the offsite reloading or cleaning facility complies.

(b) *Compliance with 40 CFR parts 264 and 265, subparts AA, BB, and/or CC.* (1) After the compliance dates specified in §63.2445, if a control device that you use to comply with this subpart is also subject to monitoring, recordkeeping, and reporting requirements in 40 CFR part 264, subpart AA, BB, or CC; or the monitoring and recordkeeping requirements in 40 CFR part 265, subpart AA, BB, or CC; and you comply with the periodic reporting requirements under 40 CFR part 264, subpart AA, BB, or CC that would apply to the device if your facility had final-permitted status, you may elect to comply either with the monitoring, recordkeeping, and reporting requirements of this subpart; or with the monitoring and recordkeeping requirements in 40 CFR part 264 or 265 and the reporting requirements in 40 CFR part 264, as described in this paragraph (b)(1), which constitute compliance with the monitoring, recordkeeping, and reporting requirements of this subpart. If you elect to comply with the monitoring, recordkeeping, and reporting requirements in 40 CFR parts 264 and/or 265, you must report the information described in §63.2520(e).

(2) After the compliance dates specified in §63.2445, if you have an affected source with equipment that is also subject to 40 CFR part 264, subpart BB, or to 40 CFR part 265, subpart BB, then compliance with the recordkeeping and reporting requirements of 40 CFR parts 264 and/or 265 may be used to comply with the recordkeeping and reporting requirements of this subpart, to the extent that the requirements of 40 CFR parts 264 and/or 265 duplicate the requirements of this subpart.

(c) *Compliance with 40 CFR part 60, subpart Kb and 40 CFR part 61, subpart Y.* After the compliance dates specified in §63.2445, you are in compliance with the provisions of this subpart FFFF for any storage tank that is assigned to an MCPU and that is both controlled with a floating roof and in compliance with the provisions of either 40 CFR part 60, subpart Kb, or 40 CFR part 61, subpart Y. You are in compliance with this subpart FFFF if you have a storage tank with a fixed roof, closed-vent system, and control device in compliance with the provisions of either 40 CFR part 60, subpart Kb, or 40 CFR part 61, subpart Y, except that you must comply with the monitoring, recordkeeping, and reporting requirements in this subpart FFFF. Alternatively, if a storage tank assigned to an MCPU is subject to control under 40 CFR part 60, subpart Kb, or 40 CFR part 61, subpart Y, you may elect to comply only with the requirements for Group 1 storage tanks in this subpart FFFF.

(d) *Compliance with subpart I, GGG, or MMM of this part 63.* After the compliance dates specified in §63.2445, if you have an affected source with equipment subject to subpart I, GGG, or MMM of this part 63, you may elect to comply with the provisions of subpart H, GGG, or MMM of this part 63, respectively, for all such equipment.

(e) *Compliance with subpart GGG of this part 63 for wastewater.* After the compliance dates specified in §63.2445, if you have an affected source subject to this subpart and you have an affected source that generates wastewater streams that meet the applicability thresholds specified in §63.1256, you may elect to comply with the provisions of this subpart FFFF for all such wastewater streams.

(f) *Compliance with subpart MMM of this part 63 for wastewater.* After the compliance dates specified in §63.2445, if you have an affected source subject to this subpart, and you have an affected source that generates wastewater streams that meet the applicability thresholds specified in §63.1362(d), you may elect to comply with the provisions of this subpart FFFF for all such wastewater streams (except that the 99 percent reduction requirement for streams subject to §63.1362(d)(10) still applies).

(g) *Compliance with other regulations for wastewater.* After the compliance dates specified in §63.2445, if you have a Group 1 wastewater stream that is also subject to provisions in 40 CFR parts 260 through 272, you may elect to determine whether this subpart or 40 CFR parts 260 through 272 contain the more

stringent control requirements (e.g., design, operation, and inspection requirements for waste management units; numerical treatment standards; etc.) and the more stringent testing, monitoring, recordkeeping, and reporting requirements. Compliance with provisions of 40 CFR parts 260 through 272 that are determined to be more stringent than the requirements of this subpart constitute compliance with this subpart. For example, provisions of 40 CFR parts 260 through 272 for treatment units that meet the conditions specified in §63.138(h) constitute compliance with this subpart. You must identify in the notification of compliance status report required by §63.2520(d) the information and procedures that you used to make any stringency determinations.

(h) *Compliance with 40 CFR part 60, subpart DDD, III, NNN, or RRR.* After the compliance dates specified in §63.2445, if you have an MCPU that contains equipment subject to the provisions of this subpart that are also subject to the provisions of 40 CFR part 60, subpart DDD, III, NNN, or RRR, you may elect to apply this subpart to all such equipment in the MCPU. If an MCPU subject to the provisions of this subpart has equipment to which this subpart does not apply but which is subject to a standard in 40 CFR part 60, subpart DDD, III, NNN, or RRR, you may elect to comply with the requirements for Group 1 process vents in this subpart for such equipment. If you elect any of these methods of compliance, you must consider all total organic compounds, minus methane and ethane, in such equipment for purposes of compliance with this subpart, as if they were organic HAP. Compliance with the provisions of this subpart, in the manner described in this paragraph (h), will constitute compliance with 40 CFR part 60, subpart DDD, III, NNN, or RRR, as applicable.

(i) *Compliance with 40 CFR part 61, subpart BB.* (1) After the compliance dates specified in §63.2445, a Group 1 transfer rack, as defined in §63.2550, that is also subject to the provisions of 40 CFR part 61, subpart BB, you are required to comply only with the provisions of this subpart.

(2) After the compliance dates specified in §63.2445, a Group 2 transfer rack, as defined in §63.2550, that is also subject to the provisions of 40 CFR part 61, subpart BB, is required to comply with the provisions of either paragraph (l)(2)(i) or (ii) of this section.

(i) If the transfer rack is subject to the control requirements specified in §61.302 of 40 CFR part 61, subpart BB, then you may elect to comply with either the requirements of 40 CFR part 61, subpart BB, or the requirements for Group 1 transfer racks under this subpart FFFF.

(ii) If the transfer rack is subject only to reporting and recordkeeping requirements under 40 CFR part 61, subpart BB, then you are required to comply only with the reporting and recordkeeping requirements specified in this subpart for Group 2 transfer racks, and you are exempt from the reporting and recordkeeping requirements in 40 CFR part 61, subpart BB.

(j) *Compliance with 40 CFR part 61, subpart FF.* After the compliance date specified in §63.2445, for a Group 1 or Group 2 wastewater stream that is also subject to the provisions of 40 CFR 61.342(c) through (h), and is not exempt under 40 CFR 61.342(c)(2) or (3), you may elect to comply only with the requirements for Group 1 wastewater streams in this subpart FFFF. If a Group 2 wastewater stream is exempted from 40 CFR 61.342(c)(1) under 40 CFR 61.342(c)(2) or (3), then you are required to comply only with the reporting and recordkeeping requirements specified in this subpart for Group 2 wastewater streams, and you are exempt from the requirements in 40 CFR part 61, subpart FF.

(k) *Compliance with 40 CFR part 60, subpart VV, and 40 CFR part 61, subpart V.* After the compliance date specified in §63.2445, if you have an affected source with equipment that is also subject to the requirements of 40 CFR part 60, subpart VV, or 40 CFR part 61, subpart V, you may elect to apply this subpart to all such equipment. After the compliance date specified in §63.2445, if you have an affected source with equipment to which this subpart does not apply, but which is subject to the requirements of 40 CFR part 60, subpart VV, or 40 CFR part 61, subpart V, you may elect to apply this subpart to all such equipment. If you elect either of these methods of compliance, you must consider all total organic compounds, minus methane and ethane, in such equipment for purposes of compliance with this subpart, as if they were organic HAP. Compliance with the provisions of this subpart, in the manner described in this paragraph (k), will constitute compliance with 40 CFR part 60, subpart VV and 40 CFR part 61, subpart V, as applicable.

(l) *Applicability of process units included in a process unit group.* You may elect to develop and comply with the requirements for PUG in accordance with paragraphs (l)(1) through (3) of this section.

(1) *Procedures to create process unit groups.* Develop and document changes in a PUG in accordance with the procedures specified in paragraphs (l)(1)(i) through (v) of this section.

(i) Initially, identify an MCPU that is created from nondedicated equipment that will operate on or after November 10, 2003 and identify all processing equipment that is part of this MCPU, based on descriptions in operating scenarios.

(ii) Add to the group any other nondedicated MCPU and other nondedicated process units expected to be operated in the 5 years after the date specified in paragraph (l)(1)(i) of this section, provided they satisfy the criteria specified in paragraphs (l)(1)(ii)(A) through (C) of this section. Also identify all of the processing equipment used for each process unit based on information from operating scenarios and other applicable documentation.

(A) Each process unit that is added to a group must have some processing equipment that is also part of one or more process units in the group.

(B) No process unit may be part of more than one PUG.

(C) The processing equipment used to satisfy the requirement of paragraph (l)(1)(ii)(A) of this section may not be a storage tank or control device.

(iii) The initial PUG consists of all of the processing equipment for the process units identified in paragraphs (l)(1)(i) and (ii) of this section. As an alternative to the procedures specified in paragraphs (l)(1)(i) and (ii) of this section, you may use a PUG that was developed in accordance with §63.1360(h) as your initial PUG.

(iv) Add process units developed in the future in accordance with the conditions specified in paragraphs (l)(1)(ii)(A) and (B) of this section.

(v) Maintain records that describe the process units in the initial PUG, the procedure used to create the PUG, and subsequent changes to each PUG as specified in §63.2525(i). Submit the records in reports as specified in §63.2520(d)(2)(ix) and (e)(8).

(2) *Determine primary product.* You must determine the primary product of each PUG created in paragraph (l)(1) of this section according to the procedures specified in paragraphs (l)(2)(i) through (iv) of this section.

(i) The primary product is the type of product (e.g., organic chemicals subject to §63.2435(b)(1), pharmaceutical products subject to §63.1250, or pesticide active ingredients subject to §63.1360) expected to be produced for the greatest operating time in the 5-year period specified in paragraph (l)(1)(ii) of this section.

(ii) If the PUG produces multiple types of products equally based on operating time, then the primary product is the type of product with the greatest production on a mass basis over the 5-year period specified in paragraph (l)(1)(ii) of this section.

(iii) At a minimum, you must redetermine the primary product of the PUG following the procedure specified in paragraphs (l)(2)(i) and (ii) of this section every 5 years.

(iv) You must record the calculation of the initial primary product determination as specified in §63.2525(i)(3) and report the results in the notification of compliance status report as specified in §63.2520(d)(8)(ix). You must record the calculation of each redetermination of the primary product as specified in §63.2525(i)(5) and report the calculation in a compliance report submitted no later than the report covering the period for the end of the 5th year after cessation of production of the previous primary product, as specified in §63.2520(e)(8).

(3) *Compliance requirements.* (i) If the primary product of the PUG is determined according to paragraph (l)(2) of this section to be material described in §63.2435(b)(1), then you must comply with this subpart for each MCPU in the PUG. You may also elect to comply with this subpart for all other process units in the PUG, which constitutes compliance with other part 63 rules.

(ii) If the primary product of the PUG is determined according to paragraph (l)(2) of this section to be material not described in §63.2435(b)(1), then you must comply with paragraph (l)(3)(ii)(A), (B), or (C) of this section, as applicable.

(A) If the primary product is subject to subpart GGG of this part 63, then comply with the requirements of subpart GGG for each MCPU in the PUG.

(B) If the primary product is subject to subpart MMM of this part 63, then comply with the requirements of subpart MMM for each MCPU in the PUG.

(C) If the primary product is subject to any subpart in this part 63 other than subpart GGG or subpart MMM, then comply with the requirements of this subpart for each MCPU in the PUG.

(iii) The requirements for new and reconstructed sources in the alternative subpart apply to all MCPU in the PUG if and only if the affected source under the alternative subpart meets the requirements for construction or reconstruction.

[68 FR 63888, Nov. 10, 2003, as amended at 71 FR 40337, July 14, 2006]

§ 63.2540 What parts of the General Provisions apply to me?

Table 12 to this subpart shows which parts of the General Provisions in §§63.1 through 63.15 apply to you.

§ 63.2545 Who implements and enforces this subpart?

(a) This subpart can be implemented and enforced by us, the U.S. Environmental Protection Agency (U.S. EPA), or a delegated authority such as your State, local, or tribal agency. If the U.S. EPA Administrator has delegated authority to your State, local, or tribal agency, then that agency also has the authority to implement and enforce this subpart. You should contact your U.S. EPA Regional Office to find out if this subpart is delegated to your State, local, or tribal agency.

(b) In delegating implementation and enforcement authority of this subpart to a State, local, or tribal agency under 40 CFR part 63, subpart E, the authorities contained in paragraphs (b)(1) through (4) of this section are retained by the Administrator of U.S. EPA and are not delegated to the State, local, or tribal agency.

(1) Approval of alternatives to the non-opacity emission limits and work practice standards in §63.2450 (a) under §63.6(g).

(2) Approval of major alternatives to test methods under §63.7(e)(2)(ii) and (f) and as defined in §63.90.

(3) Approval of major alternatives to monitoring under §63.8(f) and as defined in §63.90.

(4) Approval of major alternatives to recordkeeping and reporting under §63.10(f) and as defined in §63.90.

§ 63.2550 What definitions apply to this subpart?

(a) For an affected source complying with the requirements in subpart SS of this part 63, the terms used in this subpart and in subpart SS of this part 63 have the meaning given them in §63.981, except as specified in §§63.2450(k)(2) and (m), 63.2470(c)(2), 63.2475(b), and paragraph (i) of this section.

(b) For an affected source complying with the requirements in 40 CFR part 65, subpart F, the terms used in this subpart and in 40 CFR part 65, subpart F have the meaning given to them in §65.2.

(c) For an affected source complying with the requirements in subpart UU of this part 63, the terms used in this subpart and in subpart UU of this part 63 have the meaning given them in §63.1020.

(d) For an affected source complying with the requirements in subpart WW of this part 63, the terms used in this subpart and subpart WW of this part 63 have the meaning given them in §63.1061, except as specified in §§63.2450(m), 63.2470(c)(2), and paragraph (i) of this section.

(e) For an affected source complying with the requirements in §§63.132 through 63.149, the terms used in this subpart and §§63.132 through 63.149 have the meaning given them in §§63.101 and 63.111, except as specified in §63.2450(m) and paragraph (i) of this section.

(f) For an affected source complying with the requirements in §§63.104 and 63.105, the terms used in this subpart and in §§63.104 and 63.105 of this subpart have the meaning given them in §63.101, except as specified in §§63.2450(m), 63.2490(b), and paragraph (i) of this section.

(g) For an affected source complying with requirements in §§63.1253, 63.1257, and 63.1258, the terms used in this subpart and in §§63.1253, 63.1257, and 63.1258 have the meaning given them in §63.1251, except as specified in §63.2450(m) and paragraph (i) of this section.

(h) For an affected source complying with the requirements in 40 CFR part 65, subpart F, the terms used in this subpart and in 40 CFR part 65, subpart F, have the meaning given them in 40 CFR 65.2.

(i) All other terms used in this subpart are defined in the Clean Air Act (CAA), in 40 CFR 63.2, and in this paragraph (i). If a term is defined in §63.2, §63.101, §63.111, §63.981, §63.1020, §63.1061, §63.1251, or §65.2 and in this paragraph (i), the definition in this paragraph (i) applies for the purposes of this subpart.

Ancillary activities means boilers and incinerators (not used to comply with the emission limits in Tables 1 through 7 to this subpart), chillers and refrigeration systems, and other equipment and activities that are not directly involved (*i.e.*, they operate within a closed system and materials are not combined with process fluids) in the processing of raw materials or the manufacturing of a product or isolated intermediate.

Batch operation means a noncontinuous operation involving intermittent or discontinuous feed into equipment, and, in general, involves the emptying of the equipment after the operation ceases and prior to beginning a new operation. Addition of raw material and withdrawal of product do not occur simultaneously in a batch operation.

Batch process vent means a vent from a unit operation or vents from multiple unit operations within a process that are manifolded together into a common header, through which a HAP-containing gas stream is, or has the potential to be, released to the atmosphere. Examples of batch process vents include, but are not limited to, vents on condensers used for product recovery, reactors, filters, centrifuges, and process tanks. The following are not batch process vents for the purposes of this subpart:

- (1) Continuous process vents;
- (2) Bottoms receivers;
- (3) Surge control vessels;
- (4) Gaseous streams routed to a fuel gas system(s);
- (5) Vents on storage tanks, wastewater emission sources, or pieces of equipment subject to the emission limits and work practice standards in Tables 4, 6, and 7 to this subpart;
- (6) Drums, pails, and totes;
- (7) Flexible elephant trunk systems that draw ambient air (*i.e.*, the system is not ducted, piped, or otherwise connected to the unit operations) away from operators when vessels are opened; and
- (8) Emission streams from emission episodes that are undiluted and uncontrolled containing less than 50 ppmv HAP are not part of any batch process vent. A vent from a unit operation, or a vent from multiple unit operations that are manifolded together, from which total uncontrolled HAP emissions are less than 200 lb/yr is not a batch process vent; emissions for all emission episodes associated with the unit operation(s) must be included in the determination of the total mass emitted. The HAP concentration or mass emission rate may be determined using any of the following: process knowledge that no HAP

are present in the emission stream; an engineering assessment as discussed in §63.1257(d)(2)(ii), except that you do not need to demonstrate that the equations in §63.1257(d)(2)(i) do not apply, and the precompliance reporting requirements specified in §63.1257(d)(2)(ii)(E) do not apply for the purposes of this demonstration; equations specified in §63.1257(d)(2)(i), as applicable; test data using Method 18 of 40 CFR part 60, appendix A; or any other test method that has been validated according to the procedures in Method 301 of appendix A of this part.

Biofilter means an enclosed control system such as a tank or series of tanks with a fixed roof that contact emissions with a solid media (such as bark) and use microbiological activity to transform organic pollutants in a process vent stream to innocuous compounds such as carbon dioxide, water, and inorganic salts. Wastewater treatment processes such as aeration lagoons or activated sludge systems are not considered to be biofilters.

Bottoms receiver means a tank that collects bottoms from continuous distillation before the stream is sent for storage or for further downstream processing.

Construction means the onsite fabrication, erection, or installation of an affected source or MCPU. Addition of new equipment to an MCPU subject to existing source standards does not constitute construction, but it may constitute reconstruction of the affected source or MCPU if it satisfies the definition of reconstruction in §63.2.

Consumption means the quantity of all HAP raw materials entering a process in excess of the theoretical amount used as reactant, assuming 100 percent stoichiometric conversion. The raw materials include reactants, solvents, and any other additives. If a HAP is generated in the process as well as added as a raw material, consumption includes the quantity generated in the process.

Continuous operation means any operation that is not a batch operation.

Continuous process vent means the point of discharge to the atmosphere (or the point of entry into a control device, if any) of a gas stream if the gas stream has the characteristics specified in §63.107(b) through (h), or meets the criteria specified in §63.107(i), except:

- (1) The reference in §63.107(e) to a chemical manufacturing process unit that meets the criteria of §63.100(b) means an MCPU that meets the criteria of §63.2435(b);
- (2) The reference in §63.107(h)(4) to §63.113 means Table 1 to this subpart;
- (3) The references in §63.107(h)(7) to §§63.119 and 63.126 mean Tables 4 and 5 to this subpart; and
- (4) For the purposes of §63.2455, all references to the characteristics of a process vent (e.g., flowrate, total HAP concentration, or TRE index value) mean the characteristics of the gas stream.
- (5) The reference to "total organic HAP" in §63.107(d) means "total HAP" for the purposes of this subpart FFFF.
- (6) The references to an "air oxidation reactor, distillation unit, or reactor" in §63.107 mean any continuous operation for the purposes of this subpart.
- (7) A separate determination is required for the emissions from each MCPU, even if emission streams from two or more MCPU are combined prior to discharge to the atmosphere or to a control device.

Dedicated MCPU means an MCPU that consists of equipment that is used exclusively for one process, except that storage tanks assigned to the process according to the procedures in §63.2435(d) also may be shared by other processes.

Deviation means any instance in which an affected source subject to this subpart, or an owner or operator of such a source:

- (1) Fails to meet any requirement or obligation established by this subpart including, but not limited to, any emission limit, operating limit, or work practice standard; or

(2) Fails to meet any term or condition that is adopted to implement an applicable requirement in this subpart and that is included in the operating permit for any affected source required to obtain such a permit; or

(3) Fails to meet any emission limit, operating limit, or work practice standard in this subpart during startup, shutdown, or malfunction, regardless of whether or not such failure is permitted by this subpart.

Emission point means each continuous process vent, batch process vent, storage tank, transfer rack, and wastewater stream.

Energetics means propellants, explosives, and pyrotechnics and include materials listed at 49 CFR 172.101 as Hazard Class I Hazardous Materials, Divisions 1.1 through 1.6.

Equipment means each pump, compressor, agitator, pressure relief device, sampling connection system, open-ended valve or line, valve, connector, and instrumentation system in organic HAP service; and any control devices or systems used to comply with Table 6 to this subpart.

Excess emissions means emissions greater than those allowed by the emission limit.

Family of materials means a grouping of materials with the same basic composition or the same basic end use or functionality produced using the same basic feedstocks with essentially identical HAP emission profiles (primary constituent and relative magnitude on a pound per product basis) and manufacturing equipment configuration. Examples of families of materials include multiple grades of the same product or different variations of a product (e.g., blue, black, and red resins).

Group 1 batch process vent means each of the batch process vents in a process for which the collective uncontrolled organic HAP emissions from all of the batch process vents are greater than or equal to 10,000 lb/yr at an existing source or greater than or equal to 3,000 lb/yr at a new source.

Group 2 batch process vent means each batch process vent that does not meet the definition of Group 1 batch process vent.

Group 1 continuous process vent means a continuous process vent for which the flow rate is greater than or equal to 0.005 standard cubic meter per minute, and the total resource effectiveness index value, calculated according to §63.2455(b), is less than or equal to 1.9 at an existing source and less than or equal to 5.0 at a new source.

Group 2 continuous process vent means a continuous process vent that does not meet the definition of a Group 1 continuous process vent.

Group 1 storage tank means a storage tank with a capacity greater than or equal to 10,000 gal storing material that has a maximum true vapor pressure of total HAP greater than or equal to 6.9 kilopascals at an existing source or greater than or equal to 0.69 kilopascals at a new source.

Group 2 storage tank means a storage tank that does not meet the definition of a Group 1 storage tank.

Group 1 transfer rack means a transfer rack that loads more than 0.65 million liters/year of liquids that contain organic HAP with a rack-weighted average partial pressure, as defined in §63.111, greater than or equal to 1.5 pound per square inch absolute.

Group 2 transfer rack means a transfer rack that does not meet the definition of a Group 1 transfer rack.

Group 1 wastewater stream means a wastewater stream consisting of process wastewater at an existing or new source that meets the criteria for Group 1 status in §63.2485(c) for compounds in Tables 8 and 9 to this subpart and/or a wastewater stream consisting of process wastewater at a new source that meets the criteria for Group 1 status in §63.132(d) for compounds in Table 8 to subpart G of this part 63.

Group 2 wastewater stream means any process wastewater stream that does not meet the definition of a Group 1 wastewater stream.

Halogenated vent stream means a vent stream determined to have a mass emission rate of halogen atoms contained in organic compounds of 0.45 kilograms per hour or greater determined by the procedures presented in §63.115(d)(2)(v).

Halogen atoms mean chlorine and fluorine.

HAP metals means the metal portion of antimony compounds, arsenic compounds, beryllium compounds, cadmium compounds, chromium compounds, cobalt compounds, lead compounds, manganese compounds, mercury compounds, nickel compounds, and selenium compounds.

Hydrogen halide and halogen HAP means hydrogen chloride, hydrogen fluoride, and chlorine.

In organic HAP service means that a piece of equipment either contains or contacts a fluid (liquid or gas) that is at least 5 percent by weight of total organic HAP as determined according to the provisions of §63.180(d). The provisions of §63.180(d) also specify how to determine that a piece of equipment is not in organic HAP service.

Isolated intermediate means a product of a process that is stored before subsequent processing. An isolated intermediate is usually a product of a chemical synthesis, fermentation, or biological extraction process. Storage of an isolated intermediate marks the end of a process. Storage occurs at any time the intermediate is placed in equipment used solely for storage. The storage equipment is part of the MCPU that produces the isolated intermediate and is not assigned as specified in §63.2435(d).

Large control device means a control device that controls total HAP emissions of greater than or equal to 10 tpy, before control.

Maintenance wastewater means wastewater generated by the draining of process fluid from components in the MCPU into an individual drain system in preparation for or during maintenance activities. Maintenance wastewater can be generated during planned and unplanned shutdowns and during periods not associated with a shutdown. Examples of activities that can generate maintenance wastewater include descaling of heat exchanger tubing bundles, cleaning of distillation column traps, draining of pumps into an individual drain system, and draining of portions of the MCPU for repair. Wastewater from routine cleaning operations occurring as part of batch operations is not considered maintenance wastewater.

Maximum true vapor pressure has the meaning given in §63.111, except that it applies to all HAP rather than only organic HAP.

Miscellaneous organic chemical manufacturing process means all equipment which collectively function to produce a product or isolated intermediate that are materials described in §63.2435(b). For the purposes of this subpart, process includes any, all or a combination of reaction, recovery, separation, purification, or other activity, operation, manufacture, or treatment which are used to produce a product or isolated intermediate. A process is also defined by the following:

- (1) Routine cleaning operations conducted as part of batch operations are considered part of the process;
- (2) Each nondedicated solvent recovery operation is considered a single process;
- (3) Each nondedicated formulation operation is considered a single process that is used to formulate numerous materials and/or products;
- (4) Quality assurance/quality control laboratories are not considered part of any process; and
- (5) Ancillary activities are not considered a process or part of any process.
- (6) The end of a process that produces a solid material is either up to and including the dryer or extruder, or for a polymer production process without a dryer or extruder, it is up to and including the extruder, die plate, or solid-state reactor, except in two cases. If the dryer, extruder, die plate, or solid-state reactor is followed by an operation that is designed and operated to remove HAP solvent or

residual HAP monomer from the solid, then the solvent removal operation is the last step in the process. If the dried solid is diluted or mixed with a HAP-based solvent, then the solvent removal operation is the last step in the process.

Nondedicated solvent recovery operation means a distillation unit or other purification equipment that receives used solvent from more than one MCPU.

Nonstandard batch means a batch process that is operated outside of the range of operating conditions that are documented in an existing operating scenario but is still a reasonably anticipated event. For example, a nonstandard batch occurs when additional processing or processing at different operating conditions must be conducted to produce a product that is normally produced under the conditions described by the standard batch. A nonstandard batch may be necessary as a result of a malfunction, but it is not itself a malfunction.

On-site or on site means, with respect to records required to be maintained by this subpart or required by another subpart referenced by this subpart, that records are stored at a location within a major source which encompasses the affected source. On-site includes, but is not limited to, storage at the affected source or MCPU to which the records pertain, or storage in central files elsewhere at the major source.

Operating scenario means, for the purposes of reporting and recordkeeping, any specific operation of an MCPU as described by records specified in §63.2525(b).

Organic group means structures that contain primarily carbon, hydrogen, and oxygen atoms.

Organic peroxides means organic compounds containing the bivalent -o-o-structure which may be considered to be a structural derivative of hydrogen peroxide where one or both of the hydrogen atoms has been replaced by an organic radical.

Point of determination means each point where process wastewater exits the MCPU or control device.

Note to definition for point of determination: The regulation allows determination of the characteristics of a wastewater stream: At the point of determination; or downstream of the point of determination if corrections are made for changes in flow rate and annual average concentration of soluble HAP and partially soluble HAP compounds as determined according to procedures in §63.144 of subpart G in this part 63. Such changes include losses by air emissions; reduction of annual average concentration or changes in flow rate by mixing with other water or wastewater streams; and reduction in flow rate or annual average concentration by treating or otherwise handling the wastewater stream to remove or destroy HAP.

Predominant HAP means as used in calibrating an analyzer, the single organic HAP that constitutes the largest percentage of the total organic HAP in the analyzed gas stream, by volume.

Process condenser means a condenser whose primary purpose is to recover material as an integral part of an MCPU. All condensers recovering condensate from an MCPU at or above the boiling point or all condensers in line prior to a vacuum source are considered process condensers. Typically, a primary condenser or condensers in series are considered to be integral to the MCPU if they are capable of and normally used for the purpose of recovering chemicals for fuel value (i.e., net positive heating value), use, reuse or for sale for fuel value, use, or reuse. This definition does not apply to a condenser that is used to remove materials that would hinder performance of a downstream recovery device as follows:

- (1) To remove water vapor that would cause icing in a downstream condenser, or
- (2) To remove water vapor that would negatively affect the adsorption capacity of carbon in a downstream carbon adsorber, or
- (3) To remove high molecular weight organic compounds or other organic compounds that would be difficult to remove during regeneration of a downstream carbon adsorber.

Process tank means a tank or vessel that is used within a process to collect material discharged from a feedstock storage tank or equipment within the process before the material is transferred to other equipment within the process or a product storage tank. A process tank has emissions that are related to

the characteristics of the batch cycle, and it does not accumulate product over multiple batches. Surge control vessels and bottoms receivers are not process tanks.

Production-indexed HAP consumption factor (HAP factor) means the result of dividing the annual consumption of total HAP by the annual production rate, per process.

Production-indexed VOC consumption factor (VOC factor) means the result of dividing the annual consumption of total VOC by the annual production rate, per process.

Quaternary ammonium compounds means a type of organic nitrogen compound in which the molecular structure includes a central nitrogen atom joined to four organic groups as well as an acid radical of some sort.

Recovery device means an individual unit of equipment used for the purpose of recovering chemicals from process vent streams and from wastewater streams for fuel value (i.e., net positive heating value), use, reuse, or for sale for fuel value, use, or reuse. For the purposes of meeting requirements in Table 2 to this subpart, the recovery device must not be a process condenser and must recover chemicals to be reused in a process on site. Examples of equipment that may be recovery devices include absorbers, carbon adsorbers, condensers, oil-water separators or organic-water separators, or organic removal devices such as decanters, strippers, or thin-film evaporation units. To be a recovery device for a wastewater stream, a decanter and any other equipment based on the operating principle of gravity separation must receive only multi-phase liquid streams.

Responsible official means responsible official as defined in 40 CFR 70.2.

Safety device means a closure device such as a pressure relief valve, frangible disc, fusible plug, or any other type of device which functions exclusively to prevent physical damage or permanent deformation to a unit or its air emission control equipment by venting gases or vapors directly to the atmosphere during unsafe conditions resulting from an unplanned, accidental, or emergency event. For the purposes of this subpart, a safety device is not used for routine venting of gases or vapors from the vapor headspace underneath a cover such as during filling of the unit or to adjust the pressure in response to normal daily diurnal ambient temperature fluctuations. A safety device is designed to remain in a closed position during normal operations and open only when the internal pressure, or another relevant parameter, exceeds the device threshold setting applicable to the air emission control equipment as determined by the owner or operator based on manufacturer recommendations, applicable regulations, fire protection and prevention codes and practices, or other requirements for the safe handling of flammable, combustible, explosive, reactive, or hazardous materials.

Shutdown means the cessation of operation of a continuous operation for any purpose. Shutdown also means the cessation of a batch operation, or any related individual piece of equipment required or used to comply with this subpart, if the steps taken to cease operation differ from those described in a standard batch or nonstandard batch. Shutdown also applies to emptying and degassing storage vessels. Shutdown does not apply to cessation of batch operations at the end of a campaign or between batches within a campaign when the steps taken are routine operations.

Small control device means a control device that controls total HAP emissions of less than 10 tpy, before control.

Standard batch means a batch process operated within a range of operating conditions that are documented in an operating scenario. Emissions from a standard batch are based on the operating conditions that result in highest emissions. The standard batch defines the uncontrolled and controlled emissions for each emission episode defined under the operating scenario.

Startup means the setting in operation of a continuous operation for any purpose; the first time a new or reconstructed batch operation begins production; for new equipment added, including equipment required or used to comply with this subpart, the first time the equipment is put into operation; or for the introduction of a new product/process, the first time the product or process is run in equipment. For batch operations, startup applies to the first time the equipment is put into operation at the start of a campaign to produce a product that has been produced in the past if the steps taken to begin production differ from those specified in a standard batch or nonstandard batch. Startup does not apply when the equipment is put into operation as part of a batch within a campaign when the steps taken are routine operations.

Storage tank means a tank or other vessel that is used to store liquids that contain organic HAP and/or hydrogen halide and halogen HAP and that has been assigned to an MCPU according to the procedures in §63.2435(d). The following are not considered storage tanks for the purposes of this subpart:

- (1) Vessels permanently attached to motor vehicles such as trucks, railcars, barges, or ships;
- (2) Pressure vessels designed to operate in excess of 204.9 kilopascals and without emissions to the atmosphere;
- (3) Vessels storing organic liquids that contain HAP only as impurities;
- (4) Wastewater storage tanks;
- (5) Bottoms receivers;
- (6) Surge control vessels; and
- (7) Process tanks.

Supplemental gases means the air that is added to a vent stream after the vent stream leaves the unit operation. Air that is part of the vent stream as a result of the nature of the unit operation is not considered supplemental gases. Air required to operate combustion device burner(s) is not considered supplemental gases.

Surge control vessel means feed drums, recycle drums, and intermediate vessels as part of any continuous operation. Surge control vessels are used within an MCPU when in-process storage, mixing, or management of flowrates or volumes is needed to introduce material into continuous operations.

Total organic compounds or (TOC) means the total gaseous organic compounds (minus methane and ethane) in a vent stream.

Transfer rack means the collection of loading arms and loading hoses, at a single loading rack, that are assigned to an MCPU according to the procedures specified in §63.2435(d) and are used to fill tank trucks and/or rail cars with organic liquids that contain one or more of the organic HAP listed in section 112(b) of the CAA of this subpart. Transfer rack includes the associated pumps, meters, shutoff valves, relief valves, and other piping and valves.

Unit operation means those processing steps that occur within distinct equipment that are used, among other things, to prepare reactants, facilitate reactions, separate and purify products, and recycle materials. Equipment used for these purposes includes, but is not limited to, reactors, distillation columns, extraction columns, absorbers, decanters, dryers, condensers, and filtration equipment.

Waste management unit means the equipment, structure(s), and/or device(s) used to convey, store, treat, or dispose of wastewater streams or residuals. Examples of waste management units include wastewater tanks, air flotation units, surface impoundments, containers, oil-water or organic-water separators, individual drain systems, biological wastewater treatment units, waste incinerators, and organic removal devices such as steam and air stripper units, and thin film evaporation units. If such equipment is being operated as a recovery device, then it is part of a miscellaneous organic chemical manufacturing process and is not a waste management unit.

Wastewater means water that is discarded from an MCPU or control device through a POD and that contains either: an annual average concentration of compounds in Tables 8 and 9 to this subpart of at least 5 ppmw and has an annual average flowrate of 0.02 liters per minute or greater; or an annual average concentration of compounds in Tables 8 and 9 to this subpart of at least 10,000 ppmw at any flowrate. Wastewater means process wastewater or maintenance wastewater. The following are not considered wastewater for the purposes of this subpart:

- (1) Stormwater from segregated sewers;
- (2) Water from fire-fighting and deluge systems, including testing of such systems;

- (3) Spills;
- (4) Water from safety showers;
- (5) Samples of a size not greater than reasonably necessary for the method of analysis that is used;
- (6) Equipment leaks;
- (7) Wastewater drips from procedures such as disconnecting hoses after cleaning lines; and
- (8) Noncontact cooling water.

Wastewater stream means a stream that contains only wastewater as defined in this paragraph (i).

Work practice standard means any design, equipment, work practice, or operational standard, or combination thereof, that is promulgated pursuant to section 112(h) of the CAA.

[68 FR 63888, Nov. 10, 2003, as amended at 70 FR 38560, July 1, 2005; 71 FR 40338, July 14, 2006]

Table 1 to Subpart FFFF of Part 63—Emission Limits and Work Practice Standards for Continuous Process Vents

As required in §63.2455, you must meet each emission limit and work practice standard in the following table that applies to your continuous process vents:

For each . . .	For which . . .	Then you must . . .
1. Group 1 continuous process vent	a. Not applicable	i. Reduce emissions of total organic HAP by ≥ 98 percent by weight or to an outlet process concentration ≤ 20 ppmv as organic HAP or TOC by venting emissions through a closed-vent system to any combination of control devices (except a flare); or
		ii. Reduce emissions of total organic HAP by venting emissions through a closed vent system to a flare; or
		iii. Use a recovery device to maintain the TRE above 1.9 for an existing source or above 5.0 for a new source.
2. Halogenated Group 1 continuous process vent stream	a. You use a combustion control device to control organic HAP emissions	i. Use a halogen reduction device after the combustion device to reduce emissions of hydrogen halide and halogen HAP by ≥ 99 percent by weight, or to ≤ 0.45 kg/hr, or to ≤ 20 ppmv; or ii. Use a halogen reduction device before the combustion device to reduce the halogen atom mass emission rate to ≤ 0.45 kg/hr or to a concentration ≤ 20 ppmv.
3. Group 2	You use a	Comply with the requirements in

continuous process vent at an existing source	recovery device to maintain the TRE level >1.9 but ≤ 5.0	§63.993 and the requirements referenced therein.
4. Group 2 continuous process vent at a new source	You use a recovery device to maintain the TRE level >5.0 but ≤ 8.0	Comply with the requirements in §63.993 and the requirements referenced therein.

Table 2 to Subpart FFFF of Part 63—Emission Limits and Work Practice Standards for Batch Process Vents

As required in §63.2460, you must meet each emission limit and work practice standard in the following table that applies to your batch process vents:

For each . . .	Then you must . . .	And you must . . .
1. Process with Group 1 batch process vents	a. Reduce collective uncontrolled organic HAP emissions from the sum of all batch process vents within the process by ≥98 percent by weight by venting emissions from a sufficient number of the vents through one or more closed-vent systems to any combination of control devices (except a flare); or	Not applicable.
	b. Reduce collective uncontrolled organic HAP emissions from the sum of all batch process vents within the process by ≥95 percent by weight by venting emissions from a sufficient number of the vents through one or more closed-vent systems to any combination of recovery devices or a biofilter, except you may elect to comply with the requirements of subpart WW of this part for any process tank; or	Not applicable.
	c. Reduce uncontrolled organic HAP emissions from one or more batch process vents within the process by venting through a closed-vent system to a flare or by venting through one or more closed-vent systems to any combination of control devices (excluding a flare) that reduce organic HAP to an outlet	For all other batch process vents within the process, reduce collective organic HAP emissions as specified in item 1.a and/or item 1.b of this table.

	concentration ≤ 20 ppmv as TOC or total organic HAP.	
2. Halogenated Group 1 batch process vent for which you use a combustion device to control organic HAP emissions	a. Use a halogen reduction device after the combustion control device; or	i. Reduce overall emissions of hydrogen halide and halogen HAP by ≥ 99 percent; or ii. Reduce overall emissions of hydrogen halide and halogen HAP to ≤ 0.45 kg/hr; or iii. Reduce overall emissions of hydrogen halide and halogen HAP to a concentration ≤ 20 ppmv.
	b. Use a halogen reduction device before the combustion control device	Reduce the halogen atom mass emission rate to ≤ 0.45 kg/hr or to a concentration ≤ 20 ppmv.

[68 FR 63888, Nov. 10, 2003, as amended at 71 FR 40339, July 14, 2006]

Table 3 to Subpart FFFF of Part 63—Emission Limits for Hydrogen Halide and Halogen HAP Emissions or HAP Metals Emissions From Process Vents

As required in §63.2465, you must meet each emission limit in the following table that applies to your process vents that contain hydrogen halide and halogen HAP emissions or PM HAP emissions:

For each . . .	You must . . .
1. Process with uncontrolled hydrogen halide and halogen HAP emissions from process vents $\geq 1,000$ lb/yr	a. Reduce collective hydrogen halide and halogen HAP emissions by ≥ 99 percent by weight or to an outlet concentration ≤ 20 ppmv by venting through one or more closed-vent systems to any combination of control devices, or
	b. Reduce the halogen atom mass emission rate from the sum of all batch process vents and each individual continuous process vent to ≤ 0.45 kg/hr by venting through one or more closed-vent systems to a halogen reduction device.
2. Process at a new source with uncontrolled emissions from process vents ≥ 150	Reduce overall emissions of HAP metals by ≥ 97 percent by weight.

lb/yr of HAP metals	
---------------------	--

[71 FR 40340, July 14, 2006]

Table 4 to Subpart FFFF of Part 63—Emission Limits for Storage Tanks

As required in §63.2470, you must meet each emission limit in the following table that applies to your storage tanks:

For each . . .	For which . . .	Then you must . . .
1. Group 1 storage tank	a. The maximum true vapor pressure of total HAP at the storage temperature is ≥ 76.6 kilopascals	i. Reduce total HAP emissions by ≥ 95 percent by weight or to ≤ 20 ppmv of TOC or organic HAP and ≤ 20 ppmv of hydrogen halide and halogen HAP by venting emissions through a closed vent system to any combination of control devices (excluding a flare); or
		ii. Reduce total organic HAP emissions by venting emissions through a closed vent system to a flare; or
		iii. Reduce total HAP emissions by venting emissions to a fuel gas system or process in accordance with §63.982(d) and the requirements referenced therein.
	b. The maximum true vapor pressure of total HAP at the storage temperature is < 76.6 kilopascals	i. Comply with the requirements of subpart WW of this part, except as specified in §63.2470; or
		ii. Reduce total HAP emissions by ≥ 95 percent by weight or to ≤ 20 ppmv of TOC or organic HAP and ≤ 20 ppmv of hydrogen halide and halogen HAP by venting emissions through a closed vent system to any combination of control devices (excluding a flare); or
		iii. Reduce total organic HAP emissions by venting emissions through a closed vent system to a flare; or
		iv. Reduce total HAP emissions by venting emissions to a fuel gas system or process in accordance with §63.982(d) and the requirements

		referenced therein.
2. Halogenated vent stream from a Group 1 storage tank	You use a combustion control device to control organic HAP emissions	Meet one of the emission limit options specified in Item 2.a.i or ii. in Table 1 to this subpart.

[68 FR 63888, Nov. 10, 2003, as amended at 71 FR 40340, July 14, 2006]

Table 5 to Subpart FFFF of Part 63—Emission Limits and Work Practice Standards for Transfer Racks

As required in §63.2475, you must meet each emission limit and work practice standard in the following table that applies to your transfer racks:

For each . . .	You must . . .
1. Group 1 transfer rack	a. Reduce emissions of total organic HAP by ≥ 98 percent by weight or to an outlet concentration ≤ 20 ppmv as organic HAP or TOC by venting emissions through a closed-vent system to any combination of control devices (except a flare); or
	b. Reduce emissions of total organic HAP by venting emissions through a closed-vent system to a flare; or
	c. Reduce emissions of total organic HAP by venting emissions to a fuel gas system or process in accordance with §63.982(d) and the requirements referenced therein; or
	d. Use a vapor balancing system designed and operated to collect organic HAP vapors displaced from tank trucks and railcars during loading and route the collected HAP vapors to the storage tank from which the liquid being loaded originated or to another storage tank connected by a common header.
2. Halogenated Group 1 transfer rack vent stream for which you use a combustion device to control organic HAP emissions	a. Use a halogen reduction device after the combustion device to reduce emissions of hydrogen halide and halogen HAP by ≥ 99 percent by weight, to ≤ 0.45 kg/hr, or to ≤ 20 ppmv; or b. Use a halogen reduction device before the combustion device to reduce the halogen atom mass emission rate to ≤ 0.45 kg/hr or to a concentration ≤ 20 ppmv.

[68 FR 63888, Nov. 10, 2003, as amended at 71 FR 40341, July 14, 2006]

Table 6 to Subpart FFFF of Part 63—Requirements for Equipment Leaks

As required in §63.2480, you must meet each requirement in the following table that applies to your equipment leaks:

For all . . .	And that is part of . . .	You must . . .
1. Equipment that is in organic HAP service	a. Comply with the requirements of subpart UU of this part 63 and the requirements referenced therein, except as specified in §63.2480(b) and (d); or	
	b. Comply with the requirements of subpart H of this part 63 and the requirements referenced therein, except as specified in §63.2480(b) and (d); or	
	c. Comply with the requirements of 40 CFR part 65, subpart F and the requirements referenced therein, except as specified in §63.2480(c) and (d).	
2. Equipment that is in organic HAP service at a new source	a. Any MCPU	i. Comply with the requirements of subpart UU of this part 63 and the requirements referenced therein; or ii. Comply with the requirements of 40 CFR part 65, subpart F.

[68 FR 63888, Nov. 10, 2003, as amended at 71 FR 40341, July 14, 2006]

Table 7 to Subpart FFFF of Part 63—Requirements for Wastewater Streams and Liquid Streams in Open Systems Within an MCPU

As required in §63.2485, you must meet each requirement in the following table that applies to your wastewater streams and liquid streams in open systems within an MCPU:

For each . . .	You must . . .
1. Process wastewater stream	Comply with the requirements in §§63.132 through 63.148 and the requirements referenced therein, except as specified in §63.2485.
2. Maintenance wastewater stream	Comply with the requirements in §63.105 and the requirements referenced therein, except as specified in §63.2485.
3. Liquid streams in an open system within an MCPU	Comply with the requirements in §63.149 and the requirements referenced therein, except as specified in §63.2485.

Table 8 to Subpart FFFF of Part 63—Partially Soluble Hazardous Air Pollutants

As specified in §63.2485, the partially soluble HAP in wastewater that are subject to management and treatment requirements in this subpart FFFF are listed in the following table:

Chemical name . . .	CAS No.
1. 1,1,1-Trichloroethane (methyl chloroform)	71556
2. 1,1,2,2-Tetrachloroethane	79345
3. 1,1,2-Trichloroethane	79005
4. 1,1-Dichloroethylene (vinylidene chloride)	75354
5. 1,2-Dibromoethane	106934
6. 1,2-Dichloroethane (ethylene dichloride)	107062
7. 1,2-Dichloropropane	78875
8. 1,3-Dichloropropene	542756
9. 2,4,5-Trichlorophenol	95954
10. 1,4-Dichlorobenzene	106467
11. 2-Nitropropane	79469
12. 4-Methyl-2-pentanone (MIBK)	108101
13. Acetaldehyde	75070
14. Acrolein	107028
15. Acrylonitrile	107131
16. Allyl chloride	107051
17. Benzene	71432
18. Benzyl chloride	100447
19. Biphenyl	92524
20. Bromoform (tribromomethane)	75252
21. Bromomethane	74839
22. Butadiene	106990
23. Carbon disulfide	75150
24. Chlorobenzene	108907
25. Chloroethane (ethyl chloride)	75003
26. Chloroform	67663
27. Chloromethane	74873
28. Chloroprene	126998
29. Cumene	98828
30. Dichloroethyl ether	111444
31. Dinitrophenol	51285
32. Epichlorohydrin	106898
33. Ethyl acrylate	140885
34. Ethylbenzene	100414
35. Ethylene oxide	75218
36. Ethylidene dichloride	75343

37. Hexachlorobenzene	118741
38. Hexachlorobutadiene	87683
39. Hexachloroethane	67721
40. Methyl methacrylate	80626
41. Methyl-t-butyl ether	1634044
42. Methylene chloride	75092
43. N-hexane	110543
44. N,N-dimethylaniline	121697
45. Naphthalene	91203
46. Phosgene	75445
47. Propionaldehyde	123386
48. Propylene oxide	75569
49. Styrene	100425
50. Tetrachloroethylene (perchloroethylene)	127184
51. Tetrachloromethane (carbon tetrachloride)	56235
52. Toluene	108883
53. Trichlorobenzene (1,2,4-)	120821
54. Trichloroethylene	79016
55. Trimethylpentane	540841
56. Vinyl acetate	108054
57. Vinyl chloride	75014
58. Xylene (m)	108383
59. Xylene (o)	95476
60. Xylene (p)	106423

[68 FR 63888, Nov. 10, 2003, as amended at 70 FR 38560, July 1, 2005; 71 FR 40341, July 14, 2006]

Table 9 to Subpart FFFF of Part 63—Soluble Hazardous Air Pollutants

As specified in §63.2485, the soluble HAP in wastewater that are subject to management and treatment requirements of this subpart FFFF are listed in the following table:

Chemical name . . .	CAS No.
1. Acetonitrile	75058
2. Acetophenone	98862
3. Diethyl sulfate	64675
4. Dimethyl hydrazine (1,1)	57147
5. Dimethyl sulfate	77781
6. Dinitrotoluene (2,4)	121142
7. Dioxane (1,4)	123911
8. Ethylene glycol dimethyl ether	110714
9. Ethylene glycol monobutyl ether acetate	112072

10. Ethylene glycol monomethyl ether acetate	110496
11. Isophorone	78591
12. Methanol	67561
13. Nitrobenzene	98953
14. Toluidine (o-)	95534
15. Triethylamine	121448

[68 FR 63888, Nov. 10, 2003, as amended at 70 FR 38561, July 1, 2005]

Table 10 to Subpart FFFF of Part 63—Work Practice Standards for Heat Exchange Systems

As required in §63.2490, you must meet each requirement in the following table that applies to your heat exchange systems:

For each . . .	You must . . .
Heat exchange system, as defined in §63.101	Comply with the requirements of §63.104 and the requirements referenced therein, except as specified in §63.2490.

Table 11 to Subpart FFFF of Part 63—Requirements for Reports

As required in §63.2520(a) and (b), you must submit each report that applies to you on the schedule shown in the following table:

You must submit a (n)	The report must contain . . .	You must submit the report . . .
1. Precompliance report	The information specified in §63.2520(c)	At least 6 months prior to the compliance date; or for new sources, with the application for approval of construction or reconstruction.
2. Notification of compliance status report	The information specified in §63.2520(d)	No later than 150 days after the compliance date specified in §63.2445.
3. Compliance report	The information specified in §63.2520(e)	Semiannually according to the requirements in §63.2520(b).

Table 12 to Subpart FFFF of Part 63—Applicability of General Provisions to Subpart FFFF

As specified in §63.2540, the parts of the General Provisions that apply to you are shown in the following table:

Citation	Subject	Explanation
§63.1	Applicability	Yes.

§63.2	Definitions	Yes.
§63.3	Units and Abbreviations	Yes.
§63.4	Prohibited Activities	Yes.
§63.5	Construction/Reconstruction	Yes.
§63.6(a)	Applicability	Yes.
§63.6(b) (1)–(4)	Compliance Dates for New and Reconstructed sources	Yes.
§63.6(b) (5)	Notification	Yes.
§63.6(b) (6)	[Reserved]	
§63.6(b) (7)	Compliance Dates for New and Reconstructed Area Sources That Become Major	Yes.
§63.6(c) (1)–(2)	Compliance Dates for Existing Sources	Yes.
§63.6(c) (3)–(4)	[Reserved]	
§63.6(c) (5)	Compliance Dates for Existing Area Sources That Become Major	Yes
§63.6(d)	[Reserved]	
§63.6(e) (1)–(2)	Operation & Maintenance	Yes.
§63.6(e) (3)(i), (ii), and (v) through (viii)	Startup, Shutdown, Malfunction Plan (SSMP)	Yes, except information regarding Group 2 emission points and equipment leaks is not required in the SSMP, as specified in §63.2525(j).
§63.6(e) (3)(iii) and (iv)	Recordkeeping and Reporting During SSM	No, §63.998(d)(3) and 63.998(c)(1)(ii)(D) through (G) specify the recordkeeping requirement for SSM events, and §63.2520(e)(4) specifies reporting requirements.
§63.6(e) (3)(ix)	SSMP incorporation into title V permit	Yes.
§63.6(f) (1)	Compliance Except During SSM	Yes.
§63.6(f) (2)–(3)	Methods for Determining Compliance	Yes.
§63.6(g) (1)–(3)	Alternative Standard	Yes.
§63.6(h)	Opacity/Visible Emission (VE) Standards	Only for flares for which Method 22 observations are required as part of a flare compliance

		assessment.
§63.6(i) (1)–(14)	Compliance Extension	Yes.
§63.6(j)	Presidential Compliance Exemption	Yes.
§63.7(a) (1)–(2)	Performance Test Dates	Yes, except substitute 150 days for 180 days.
§63.7(a) (3)	Section 114 Authority	Yes, and this paragraph also applies to flare compliance assessments as specified under §63.997(b)(2).
§63.7(b) (1)	Notification of Performance Test	Yes.
§63.7(b) (2)	Notification of Rescheduling	Yes.
§63.7(c)	Quality Assurance/Test Plan	Yes, except the test plan must be submitted with the notification of the performance test if the control device controls batch process vents.
§63.7(d)	Testing Facilities	Yes.
§63.7(e) (1)	Conditions for Conducting Performance Tests	Yes, except that performance tests for batch process vents must be conducted under worst-case conditions as specified in §63.2460.
§63.7(e) (2)	Conditions for Conducting Performance Tests	Yes.
§63.7(e) (3)	Test Run Duration	Yes.
§63.7(f)	Alternative Test Method	Yes.
§63.7(g)	Performance Test Data Analysis	Yes.
§63.7(h)	Waiver of Tests	Yes.
§63.8(a) (1)	Applicability of Monitoring Requirements	Yes.
§63.8(a) (2)	Performance Specifications	Yes.
§63.8(a) (3)	[Reserved]	
§63.8(a) (4)	Monitoring with Flares	Yes.
§63.8(b) (1)	Monitoring	Yes.
§63.8(b)	Multiple Effluents and Multiple	Yes.

(2)–(3)	Monitoring Systems	
§63.8(c)(1)	Monitoring System Operation and Maintenance	Yes.
§63.8(c)(1)(i)	Routine and Predictable SSM	Yes.
§63.8(c)(1)(ii)	SSM not in SSMP	Yes.
§63.8(c)(1)(iii)	Compliance with Operation and Maintenance Requirements	Yes.
§63.8(c)(2)–(3)	Monitoring System Installation	Yes.
§63.8(c)(4)	CMS Requirements	Only for CEMS. Requirements for CPMS are specified in referenced subparts G and SS of part 63. Requirements for COMS do not apply because subpart FFFF does not require continuous opacity monitoring systems (COMS).
§63.8(c)(4)(i)	COMS Measurement and Recording Frequency	No; subpart FFFF does not require COMS.
§63.8(c)(4)(ii)	CEMS Measurement and Recording Frequency	Yes.
§63.8(c)(5)	COMS Minimum Procedures	No. Subpart FFFF does not contain opacity or VE limits.
§63.8(c)(6)	CMS Requirements	Only for CEMS; requirements for CPMS are specified in referenced subparts G and SS of this part 63. Requirements for COMS do not apply because subpart FFFF does not require COMS.
§63.8(c)(7)–(8)	CMS Requirements	Only for CEMS. Requirements for CPMS are specified in referenced subparts G and SS of part 63. Requirements for COMS do not apply because subpart FFFF does not require COMS.
§63.8(d)	CMS Quality Control	Only for CEMS.
§63.8(e)	CMS Performance Evaluation	Only for CEMS. Section 63.8(e)(5)(ii) does not apply because subpart FFFF does not require COMS.
§63.8(f)(1)–(5)	Alternative Monitoring Method	Yes, except you may also request approval using the precompliance report.
§63.8(f)	Alternative to Relative Accuracy	Only applicable when using

(6)	Test	CEMS to demonstrate compliance, including the alternative standard in §63.2505.
§63.8(g)(1)–(4)	Data Reduction	Only when using CEMS, including for the alternative standard in §63.2505, except that the requirements for COMS do not apply because subpart FFFF has no opacity or VE limits, and §63.8(g)(2) does not apply because data reduction requirements for CEMS are specified in §63.2450(j).
§63.8(g)(5)	Data Reduction	No. Requirements for CEMS are specified in §63.2450(j). Requirements for CPMS are specified in referenced subparts G and SS of this part 63.
§63.9(a)	Notification Requirements	Yes.
§63.9(b)(1)–(5)	Initial Notifications	Yes.
§63.9(c)	Request for Compliance Extension	Yes.
§63.9(d)	Notification of Special Compliance Requirements for New Source	Yes.
§63.9(e)	Notification of Performance Test	Yes.
§63.9(f)	Notification of VE/Opacity Test	No. Subpart FFFF does not contain opacity or VE limits.
§63.9(g)	Additional Notifications When Using CMS	Only for CEMS. Section 63.9(g)(2) does not apply because subpart FFFF does not require COMS.
63.9(h)(1)–(6)	Notification of Compliance Status	Yes, except subpart FFFF has no opacity or VE limits, and 63.9(h)(2)(i)(A) through (G) and (ii) do not apply because 63.2520(d) specifies the required contents and due date of the notification of compliance status report.
§63.9(i)	Adjustment of Submittal Deadlines	Yes.
§63.9(j)	Change in Previous Information	No, §63.2520(e) specifies reporting requirements for process changes.

§63.10(a)	Recordkeeping/Reporting	Yes.
§63.10(b)(1)	Recordkeeping/Reporting	Yes.
§63.10(b)(2)(i)–(ii), (iv), (v)	Records related to SSM	No, §§63.998(d)(3) and 63.998(c)(1)(ii)(D) through (G) specify recordkeeping requirements for periods of SSM.
§63.10(b)(2)(iii)	Records related to maintenance of air pollution control equipment	Yes.
§63.10(b)(2)(vi), (x), and (xi)	CMS Records	Only for CEMS; requirements for CPMS are specified in referenced subparts G and SS of this part 63.
§63.10(b)(2)(vii)–(ix)	Records	Yes.
§63.10(b)(2)(xii)	Records	Yes.
§63.10(b)(2)(xiii)	Records	Only for CEMS.
§63.10(b)(2)(xiv)	Records	Yes.
§63.10(b)(3)	Records	Yes.
§63.10(c)(1)–(6), (9)–(15)	Records	Only for CEMS. Recordkeeping requirements for CPMS are specified in referenced subparts G and SS of this part 63.
§63.10(c)(7)–(8)	Records	No. Recordkeeping requirements are specified in §63.2525.
§63.10(d)(1)	General Reporting Requirements	Yes.
§63.10(d)(2)	Report of Performance Test Results	Yes.
§63.10(d)(3)	Reporting Opacity or VE Observations	No. Subpart FFFF does not contain opacity or VE limits.
§63.10(d)(4)	Progress Reports	Yes.
§63.10(d)(5)(i)	Periodic Startup, Shutdown, and Malfunction Reports	No, §63.2520(e)(4) and (5) specify the SSM reporting requirements.
§63.10(d)(5)(ii)	Immediate SSM Reports	No.
§63.10(e)	Additional CEMS Reports	Yes.

(1)		
§63.10(e) (2)(i)	Additional CMS Reports	Only for CEMS.
§63.10(e) (2)(ii)	Additional COMS Reports	No. Subpart FFFF does not require COMS.
§63.10(e) (3)	Reports	No. Reporting requirements are specified in §63.2520.
§63.10(e) (3)(i)–(iii)	Reports	No. Reporting requirements are specified in §63.2520.
§63.10(e) (3)(iv)–(v)	Excess Emissions Reports	No. Reporting requirements are specified in §63.2520.
§63.10(e) (3)(iv)–(v)	Excess Emissions Reports	No. Reporting requirements are specified in §63.2520.
§63.10(e) (3)(vi)– (viii)	Excess Emissions Report and Summary Report	No. Reporting requirements are specified in §63.2520.
§63.10(e) (4)	Reporting COMS data	No. Subpart FFFF does not contain opacity or VE limits.
§63.10(f)	Waiver for Recordkeeping/Reporting	Yes.
§63.11	Flares	Yes.
§63.12	Delegation	Yes.
§63.13	Addresses	Yes.
§63.14	Incorporation by Reference	Yes.
§63.15	Availability of Information	Yes.

[68 FR 63888, Nov. 10, 2003, as amended at 70 FR 38561, July 1, 2005; 71 FR 20463, Apr. 20, 2006; 71 FR 40341, July 14, 2006]

[Browse Previous](#) | [Browse Next](#)

For questions or comments regarding e-CFR editorial content, features, or design, email ecfr@nara.gov.

For questions concerning e-CFR programming and delivery issues, email webteam@gpo.gov.

[Section 508 / Accessibility](#)

[Home Page](#) > [Executive Branch](#) > [Code of Federal Regulations](#) > [Electronic Code of Federal Regulations](#)

Electronic Code of Federal Regulations

e-CFR

TM

e-CFR Data is current as of August 1, 2007

Title 40: Protection of Environment

PART 82—PROTECTION OF STRATOSPHERIC OZONE

[Browse Next](#)

Subpart A—Production and Consumption Controls

Source: 60 FR 24986, May 10, 1995, unless otherwise noted.

§ 82.1 Purpose and scope.

(a) The purpose of the regulations in this subpart is to implement the Montreal Protocol on Substances that Deplete the Ozone Layer and sections 602, 603, 604, 605, 606, 607, 614 and 616 of the Clean Air Act Amendments of 1990, Public Law 101–549. The Protocol and section 604 impose limits on the production and consumption (defined as production plus imports minus exports, excluding transshipments and used controlled substances) of certain ozone-depleting substances, according to specified schedules. The Protocol also requires each nation that becomes a Party to the agreement to impose certain restrictions on trade in ozone-depleting substances with non-Parties.

(b) This subpart applies to any person that produces, transforms, destroys, imports or exports a controlled substance or imports or exports a controlled product.

[63 FR 41642, Aug. 4, 1998]

§ 82.2 [Reserved]

§ 82.3 Definitions for class I and class II controlled substances.

As used in this subpart, the term:

Administrator means the Administrator of the United States Environmental Protection Agency or his authorized representative. For purposes of reports and petitions, the Administrator must be written at the following mailing address: EPA (6205J), Global Programs Division, 1200 Pennsylvania Ave., NW., Washington, DC 20460.

Applicator means the person who applies methyl bromide.

Approved critical use(s) means those uses of methyl bromide listed in Column A of appendix L to this subpart as further clarified in Columns B and C of that appendix.

Approved critical user(s) means a person who:

(1) For the applicable control period, applied to EPA for a critical use exemption or is a member of a consortium that applied to EPA for a critical use exemption for a use and location of use that was

included in the U.S. nomination, authorized by a Decision of the Parties to the Montreal Protocol, and then finally determined by EPA in a notice-and-comment rulemaking to be an approved critical use; and

(2) Has an area in the applicable location of use that requires methyl bromide fumigation because the person reasonably expects that the area will be subject to a limiting critical condition during the applicable control period.

Article 5 allowances means the allowances apportioned under §82.9(a), §82.11(a)(2), and §82.18(a).

Baseline consumption allowances means the consumption allowances apportioned under §82.6 and §82.19.

Baseline production allowances means the production allowances apportioned under §82.5 and §82.17.

Beijing Amendments means the Montreal Protocol, as amended at the Eleventh Meeting of the Parties to the Montreal Protocol in Beijing in 1999.

Calculated level means the weighted amount of a controlled substance determined by multiplying the amount (in kilograms) of the controlled substance by that substance's ozone depletion potential (ODP) weight listed in appendix A or appendix B to this subpart.

Class I refers to the controlled substances listed in appendix A to this subpart.

Class II refers to the controlled substances listed in appendix B to this subpart.

Commodity Owner, Shipper or their Agent means the person requesting that an applicator use methyl bromide for quarantine or preshipment applications.

Completely destroy means to cause the expiration of a controlled substance at a destruction efficiency of 98 percent or greater, using one of the destruction technologies approved by the Parties.

Complying with the Protocol, when referring to a foreign state not Party to the 1987 Montreal Protocol, the London Amendments, or the Copenhagen Amendments, means that the non-Party has been determined as complying with the Protocol, as indicated in appendix C to this subpart, by a meeting of the Parties as noted in the records of the directorate of the United Nations Secretariat.

Confer means to shift the essential-use allowances obtained under §82.8 from the holder of the unexpended essential-use allowances to a person for the production of a specified controlled substance, or to shift the HCFC-141b exemption allowances granted under §82.16(h) from the holder of the unexpended HCFC-141b exemption allowances to a person for the production or import of the controlled substance.

Consortium means an organization representing a group of methyl bromide users that has collectively submitted an application for a critical use exemption on behalf of all members of the group. The members of a consortium shall be determined on the basis of the rules established by the organization. Members may either be required to formally join the consortium (e.g. , by submitting an application or paying dues) or may automatically become members upon meeting particular criteria (e.g. , a grower of a specific crop in a particular region).

Consumption means the production plus imports minus exports of a controlled substance (other than transshipments, or used controlled substances).

Consumption allowances means the privileges granted by this subpart to produce and import controlled substances; however, consumption allowances may be used to produce controlled substances only in conjunction with production allowances. A person's consumption allowances for class I substances are the total of the allowances obtained under §§82.6 and 82.7 and 82.10, as may be modified under §82.12 (transfer of allowances). A person's consumption allowances for class II controlled substances are the total of the allowances obtained under §§82.19 and 82.20, as may be modified under §82.23.

Control period means the period from January 1, 1992 through December 31, 1992, and each twelve-

month period from January 1 through December 31, thereafter.

Controlled product means a product that contains a controlled substance listed as a Class I, Group I or II substance in appendix A to this subpart. Controlled products include, but are not limited to, those products listed in appendix D to this subpart.

Controlled products belong to one or more of the following six categories of products:

- (1) Automobile and truck air conditioning units (whether incorporated in vehicles or not);
- (2) Domestic and commercial refrigeration and air-conditioning/heat pump equipment (whether containing controlled substances as a refrigerant and/or in insulating material of the product), e.g. Refrigerators, Freezers, Dehumidifiers, Water coolers, Ice machines, Air-conditioning and heat pump units;
- (3) Aerosol products, except medical aerosols;
- (4) Portable fire extinguishers;
- (5) Insulation boards, panels and pipe covers;
- (6) Pre-polymers.

Controlled substance means any substance listed in appendix A or appendix B to this subpart, whether existing alone or in a mixture, but excluding any such substance or mixture that is in a manufactured product other than a container used for the transportation or storage of the substance or mixture. Thus, any amount of a listed substance in appendix A or appendix B to this subpart that is not part of a use system containing the substance is a controlled substance. If a listed substance or mixture must first be transferred from a bulk container to another container, vessel, or piece of equipment in order to realize its intended use, the listed substance or mixture is a "controlled substance." The inadvertent or coincidental creation of insignificant quantities of a listed substance in appendix A or appendix B to this subpart; during a chemical manufacturing process, resulting from unreacted feedstock, from the listed substance's use as a process agent present as a trace quantity in the chemical substance being manufactured, or as an unintended byproduct of research and development applications, is not deemed a controlled substance. Controlled substances are divided into two classes, Class I in appendix A to this subpart, and Class II listed in appendix B to this subpart. Class I substances are further divided into eight groups, Group I, Group II, Group III, Group IV, Group V, Group VI, Group VII, and Group VIII, as set forth in appendix A to this subpart.

Copenhagen Amendments means the Montreal Protocol on Substances That Deplete the Ozone Layer, as amended at the Fourth Meeting of the Parties to the Montreal Protocol in Copenhagen in 1992.

Critical stock allowance (CSA) means the right granted by this subpart to sell one (1) kilogram of class I, Group VI controlled substances from inventory produced or imported prior to the January 1, 2005 phaseout date for an approved critical use during the specified control period to the extent permitted by federal and state pesticide statutes and regulations other than the Clean Air Act and regulations in this part. A person's critical stock allowances are the total of the allowances obtained under §82.8(c) as may be modified under §82.12 (transfer of allowances).

Critical stock allowance (CSA) holder means an entity to which EPA allocates a quantity of critical stock allowances as reflected under §82.8(c), or who receives a quantity of critical stock allowances through a transfer under §82.12.

Critical use means a circumstance in which the following two conditions are satisfied:

- (1) There are no technically and economically feasible alternatives or substitutes for methyl bromide available that are acceptable from the standpoint of environment and health and are suitable to the crops and circumstances involved, and
- (2) The lack of availability of methyl bromide for a particular use would result in significant market

disruption.

Critical use allowance (CUA) means the privilege granted by this subpart to produce or import one (1) kilogram of methyl bromide for an approved critical use during the specified control period. A person's critical use allowances are the total of the allowances obtained under §82.8(c) as may be modified under §82.12 (transfer of allowances).

Critical use allowance for pre-plant uses means the privilege granted by this subpart to produce or import one (1) kilogram of methyl bromide solely for an approved critical use in pre-plant categories specified in Appendix L to this subpart during the specified control period. A person's critical use allowances for pre-plant uses are the total of the allowances obtained under §82.8(c) as may be modified under §82.12 (transfer of allowances).

Critical use allowance for post-harvest uses means the privilege granted by this subpart to produce or import one (1) kilogram of methyl bromide solely for an approved critical use in post-harvest categories specified in appendix L to this subpart during the specified control period. A person's critical use allowances for post-harvest uses are the total of the allowances obtained under §82.8(c) as may be modified under §82.12 (transfer of allowances).

Critical use allowance (CUA) holder means an entity to which EPA allocates a quantity of critical use allowances as reflected in §82.8(c) or who receives a quantity of critical use allowances through a transfer under §82.12.

Critical use methyl bromide means the class I, Group VI controlled substance produced or imported through expending a critical use allowance or that portion of inventory produced or imported prior to the January 1, 2005 phaseout date that is sold only for approved critical uses through expending a critical stock allowance.

Destruction means the expiration of a controlled substance to the destruction efficiency actually achieved, unless considered completely destroyed as defined in this section. Such destruction does not result in a commercially useful end product and uses one of the following controlled processes approved by the Parties to the Protocol:

- (1) Liquid injection incineration;
- (2) Reactor cracking;
- (3) Gaseous/fume oxidation;
- (4) Rotary kiln incineration;
- (5) Cement kiln;
- (6) Radio frequency plasma; or
- (7) Municipal waste incinerators only for the destruction of foams.

Distributor of methyl bromide means the person directly selling a class I, Group VI controlled substance to an applicator.

Essential Metered Dose Inhaler (Essential MDI) means metered dose inhalers for the treatment of asthma and chronic obstructive pulmonary disease, approved by the Food and Drug Administration or by another Party's analogous health authority before December 31, 2000, and considered to be essential by the Party where the MDI product will eventually be sold. In addition, if the MDI product is to be sold in the U.S., the active moiety contained in the MDI must be listed as essential at 21 CFR 2.125 (e).

Essential-Use Allowances means the privileges granted by §82.4(n) to produce class I substances, as determined by allocation decisions made by the Parties to the Montreal Protocol and in accordance with the restrictions delineated in the Clean Air Act Amendments of 1990.

Essential-Use Chlorofluorocarbons (Essential-use CFCs) are the CFCs (CFC-11, CFC-12, or CFC-114) produced under the authority of essential-use allowances and not the allowances themselves. Essential-use CFCs include CFCs imported or produced by U.S. entities under the authority of essential-use allowances for use in essential metered dose inhalers, as well as CFCs imported or produced by non-U.S. entities under the authority of privileges granted by the Parties and the national authority of another country for use in essential metered dose inhalers.

Essential-Uses means those uses of controlled substances designated by the Parties to the Protocol to be necessary for the health and safety of, or critical for the functioning of, society; and for which there are no available technically and economically feasible alternatives or substitutes that are acceptable from the standpoint of environment and health. Beginning January 1, 2000 (January 1, 2002 for methyl chloroform) the essential use designations for class I substances must be made in accordance with the provisions of the Clean Air Act Amendments of 1990.

Export means the transport of virgin or used controlled substances from inside the United States or its territories to persons outside the United States or its territories, excluding United States military bases and ships for on-board use.

Export production allowances means the privileges granted by §82.18(b) to produce HCFC-141b for export following the phaseout of HCFC-141b on January 1, 2003.

Exporter means the person who contracts to sell controlled substances for export or transfers controlled substances to his affiliate in another country.

Facility means any process equipment (e.g., reactor, distillation column) used to convert raw materials or feedstock chemicals into controlled substances or consume controlled substances in the production of other chemicals.

Foreign state means an entity which is recognized as a sovereign nation or country other than the United States of America.¹

¹ Taiwan is not considered a foreign state.

Foreign state not Party to or Non-Party means a foreign state that has not deposited instruments of ratification, acceptance, or other form of approval with the Directorate of the United Nations Secretariat, evidencing the foreign state's ratification of the provisions of the 1987 Montreal Protocol, the London Amendments, or of the Copenhagen Amendments, as specified.

Formulator means an entity that distributes a class II controlled substance(s) or blends of a class II controlled substance(s) to persons who use the controlled substance(s) for a specific application identified in the formulator's petition for HCFC-141b exemption allowances.

HCFC-141b exemption allowances means the privileges granted to a HCFC-141b formulator; an agency, department, or instrumentality of the U.S.; or a non-governmental space vehicle entity by this subpart to order production of or to import HCFC-141b, as determined in accordance with §82.16(h).

Heel means the amount of a controlled substance that remains in a container after it is discharged or off-loaded (that is no more than ten percent of the volume of the container).

Import means to land on, bring into, or introduce into, or attempt to land on, bring into, or introduce into any place subject to the jurisdiction of the United States whether or not such landing, bringing, or introduction constitutes an importation within the meaning of the customs laws of the United States, with the following exemptions:

- (1) Off-loading used or excess controlled substances or controlled products from a ship during servicing,
- (2) Bringing controlled substances into the U.S. from Mexico where the controlled substance had been admitted into Mexico in bond and was of U.S. origin, and
- (3) Bringing a controlled product into the U.S. when transported in a consignment of personal or

household effects or in a similar non-commercial situation normally exempted from U.S. Customs attention.

Importer means any person who imports a controlled substance or a controlled product into the United States. "Importer" includes the person primarily liable for the payment of any duties on the merchandise or an authorized agent acting on his or her behalf. The term also includes, as appropriate:

- (1) The consignee;
- (2) The importer of record (listed on U.S. Customs Service forms for imported controlled substances, used controlled substances or controlled products);
- (3) The actual owner; or
- (4) The transferee, if the right to draw merchandise in a bonded warehouse has been transferred.

Individual shipment means the kilograms of a used controlled substance for which a person may make one (1) U.S. Customs entry as, as identified in the non-objection letter from the Administrator under §§82.13(g) and 82.24(c)(4).

Limiting critical condition means the regulatory, technical, and economic circumstances listed in Column C of Appendix L to this subpart that establish conditions of critical use for methyl bromide in a fumigation area.

Location of use means the geographic area (such as a state, region, or the entire United States) covered by an application for a critical use exemption in which the limiting critical condition may occur.

London Amendments means the Montreal Protocol, as amended at the Second Meeting of the Parties to the Montreal Protocol in London in 1990.

Montreal Anniversary amendments means the Montreal Protocol, as amended at the Ninth Meeting of the Parties to the Montreal Protocol in Montreal in 1997.

Montreal Protocol means the Montreal Protocol on Substances that Deplete the Ozone Layer, a protocol to the Vienna Convention for the Protection of the Ozone Layer, including adjustments adopted by the Parties thereto and amendments that have entered into force.

1987 Montreal Protocol means the Montreal Protocol, as originally adopted by the Parties in 1987.

Nations complying with, but not joining, the Protocol means any nation listed in Appendix C, Annex 2, to this subpart.

Non-Objection notice means the privilege granted by the Administrator to import a specific individual shipment of used controlled substance in accordance with §§82.13(g) and 82.24(c)(3) and (4).

Party means any foreign state that is listed in Appendix C to this subpart (pursuant to instruments of ratification, acceptance, or approval deposited with the Depositary of the United Nations Secretariat), as having ratified the specified control measure in effect under the Montreal Protocol. Thus, for purposes of the trade bans specified in §82.4(l)(2) pursuant to the London Amendments, only those foreign states that are listed in Appendix C to this subpart as having ratified both the 1987 Montreal Protocol and the London Amendments shall be deemed to be Parties.

Person means any individual or legal entity, including an individual, corporation, partnership, association, state, municipality, political subdivision of a state, Indian tribe; any agency, department, or instrumentality of the United States; and any officer, agent, or employee thereof.

Plant means one or more facilities at the same location owned by or under common control of the same person.

Preshipment applications, with respect to class I, Group VI controlled substances, are those non-quarantine applications applied within 21 days prior to export to meet the official requirements of the importing country or existing official requirements of the exporting country. Official requirements are those which are performed by, or authorized by, a national plant, animal, environmental, health or stored product authority.

Production means the manufacture of a controlled substance from any raw material or feedstock chemical, but does not include:

- (1) The manufacture of a controlled substance that is subsequently transformed;
- (2) The reuse or recycling of a controlled substance;
- (3) Amounts that are destroyed by the approved technologies; or
- (4) Amounts that are spilled or vented unintentionally.

Production allowances means the privileges granted by this subpart to produce controlled substances; however, production allowances may be used to produce controlled substances only in conjunction with consumption allowances. A person's production allowances for class I substances are the total of the allowances obtained under §§82.5, 82.7 and 82.9, and as may be modified under §82.12 (transfer of allowances). A person's production allowances for class II controlled substances are the total of the allowances obtained under §82.17 and as may be modified under §§82.18 and 82.23.

Quarantine applications, with respect to class I, Group VI controlled substances, are treatments to prevent the introduction, establishment and/or spread of quarantine pests (including diseases), or to ensure their official control, where: (1) Official control is that performed by, or authorized by, a national (including state, tribal or local) plant, animal or environmental protection or health authority; (2) quarantine pests are pests of potential importance to the areas endangered thereby and not yet present there, or present but not widely distributed and being officially controlled. This definition excludes treatments of commodities not entering or leaving the United States or any State (or political subdivision thereof).

Source facility means the location at which a used controlled substance was recovered from a piece of equipment, including the name of the company responsible for, or owning the piece of equipment, a contact person at the location, the mailing address for that specific location, and a phone number and a fax number for the contact person at the location.

Space vehicle means a man-made device, either manned or unmanned, designed for operation beyond earth's atmosphere. This definition includes integral equipment such as models, mock-ups, prototypes, molds, jigs, tooling, hardware jackets, and test coupons. Also included is auxiliary equipment associated with tests, transport, and storage, which through contamination can compromise the space vehicle performance.

Third party applicator means an applicator of critical use methyl bromide who fumigates or treats commodities, structures, crops, or land on behalf of an approved critical user.

Transform means to use and entirely consume (except for trace quantities) a controlled substance in the manufacture of other chemicals for commercial purposes.

Transshipment means the continuous shipment of a controlled substance, from a foreign state of origin through the United States or its territories, to a second foreign state of final destination, as long as the shipment does not enter into United States jurisdiction. A transshipment, as it moves through the United States or its territories, cannot be re-packaged, sorted or otherwise changed in condition.

Unexpended Article 5 allowances means Article 5 allowances that have not been used. At any time in any control period a person's unexpended Article 5 allowances are the total of the level of Article 5 allowances the person has authorization under this subpart to hold at that time for that control period, minus the level of controlled substances that the person has produced in that control period until that time.

Unexpended consumption allowances means consumption allowances that have not been used. At any time in any control period a person's unexpended consumption allowances are the total of the level of consumption allowances the person has authorization under this subpart to hold at that time for that control period, minus the level of controlled substances that the person has produced or imported (not including transshipments and used controlled substances) in that control period until that time.

Unexpended critical stock allowance (CSA) means critical stock allowances against which methyl bromide has not yet been sold for an approved critical use.

Unexpended critical use allowances (CUA) means critical use allowances against which methyl bromide has not yet been produced or imported. At any time in any control period a person's unexpended critical use allowances are the total of the level of critical use allowances the person holds at that time for that control period, minus the level of class I, Group VI controlled substances that the person has produced or has imported solely for approved critical uses in that control period.

Unexpended destruction and transformation credits means destruction and transformation credits that have not been used. At any time in any control period a person's unexpended destruction and transformation credits are the total of the level of destruction and transformation credits the person has authorization under this subpart to hold at that time for that control period, minus the level of controlled substances that the person has produced or imported (not including transshipments and used controlled substances) in that control period until that time.

Unexpended essential-use allowances means essential-use allowances that have not been used. At any time in any control period a person's unexpended essential-use allowances are the total of the level of essential-use allowances the person has authorization under this subpart to hold at that time for that control period, minus the level of controlled substances that the person has imported or had produced in that control period until that time.

Unexpended export production allowances means export production allowances that have not been used. A person's unexpended export production allowances are the total of the quantity of the export production allowances the person has authorization under §82.18(h) to hold for that control period, minus the quantity of class II controlled substances that the person has produced at that time during the same control period.

Unexpended HCFC-141b exemption allowances means HCFC-141b exemption allowances that have not been used. A person's unexpended HCFC-141b exemption allowances are the total of the quantity of the HCFC-141b exemption allowances the person has authorization under §82.16(h) to hold for that control period, minus the quantity of HCFC-141b that the person has had produced or has had imported at that time during the same control period.

Unexpended production allowances means production allowances that have not been used. At any time in any control period a person's unexpended production allowances are the total of the level of production allowances he has authorization under this subpart to hold at that time for that control period, minus the level of controlled substances that the person has produced in that control period until that time.

Used controlled substances means controlled substances that have been recovered from their intended use systems (may include controlled substances that have been, or may be subsequently, recycled or reclaimed).

[60 FR 24986, May 10, 1995, as amended at 63 FR 41642, Aug. 4, 1998; 66 FR 37767, July 19, 2001; 67 FR 6359, Feb. 11, 2002; 67 FR 79872, Dec. 31, 2002; 67 FR 251, Jan. 2, 2003; 68 FR 2847, Jan. 21, 2003; 68 FR 42891, July 18, 2003; 69 FR 4064, Jan. 28, 2004; 69 FR 77001, Dec. 23, 2004; 70 FR 77047, Dec. 29, 2005; 71 FR 41171, July 20, 2006]

§ 82.4 Prohibitions for class I controlled substances.

(a)(1) Prior to January 1, 1996, for all Groups of class I controlled substances, and prior to January 1, 2005, for class I, Group VI controlled substances, no person may produce, at any time in any control period, (except that are transformed or destroyed domestically or by a person of another Party) in excess of the amount of unexpended production allowances or unexpended Article 5 allowances for that substance held by that person under the authority of this subpart at that time for that control period.

Every kilogram of excess production constitutes a separate violation of this subpart.

(2) Effective January 1, 2003, production of class I, Group VI controlled substances is not subject to the prohibitions in paragraph (a)(1) of this section if it is solely for quarantine or preshipment applications as defined in this subpart.

(b)(1) Effective January 1, 1996, for any Class I, Group I, Group II, Group III, Group IV, Group V or Group VII controlled substances, and effective January 1, 2005 for any Class I, Group VI controlled substances, and effective August 18, 2003, for any Class I, Group VIII controlled substance, no person may produce, at any time in any control period (except that are transformed or destroyed domestically or by a person of another Party) in excess of the amount of conferred unexpended essential use allowances or exemptions, or in excess of the amount of unexpended critical use allowances, or in excess of the amount of unexpended Article 5 allowances as allocated under §82.9 and §82.11, as may be modified under §82.12 (transfer of allowances) for that substance held by that person under the authority of this subpart at that time for that control period. Every kilogram of excess production constitutes a separate violation of this subpart.

(2) Effective January 1, 2005, production of class I, Group VI controlled substances is not subject to the prohibitions in paragraph (b)(1) of this section if it is solely for quarantine or preshipment applications as defined in this subpart, or it is solely for export to satisfy critical uses authorized by the Parties for that control period.

(c)(1) Prior to January 1, 1996, for all Groups of class I controlled substances, and prior to January 1, 2005, for class I, Group VI controlled substances, no person may produce or (except for transshipments, heels or used controlled substances) import, at any time in any control period, (except for controlled substances that are transformed or destroyed) in excess of the amount of unexpended consumption allowances held by that person under the authority of this subpart at that time for that control period. Every kilogram of excess production or importation (other than transshipments, heels or used controlled substances) constitutes a separate violation of this subpart.

(2) Effective January 1, 2003, production and import of class I, Group VI controlled substances is not subject to the prohibitions in paragraph(c)(1) of this section if it is solely for quarantine or preshipment applications as defined in this subpart.

(d) Effective January 1, 1996, for any class I, Group I, Group II, Group III, Group IV, Group V, or Group VII controlled substances, and effective January 1, 2005, for any class I, Group VI controlled substance, and effective August 18, 2003, for any class I, Group VIII controlled substance, no person may import (except for transshipments or heels), at any time in any control period, (except for controlled substances that are transformed or destroyed) in excess of the amount of unexpended essential use allowances or exemptions, or in excess of unexpended critical use allowances, for that substance held by that person under the authority of this subpart at that time for that control period. Every kilogram of excess importation (other than transshipments or heels) constitutes a separate violation of this subpart. It is a violation of this subpart to obtain unused class I controlled substances under the general laboratory exemption in excess of actual need and to recycle that material for sale into other markets.

(e) Effective January 1, 1996, no person may place an order by conferring essential-use allowances for the production of the class I controlled substance, at any time in any control period, in excess of the amount of unexpended essential-use allowances, held by that person under the authority of this subpart at that time for that control period. Effective January 1, 1996, no person may import a class I controlled substance with essential-use allowances, at any time in any control period, in excess of the amount of unexpended essential-use allowances, held by that person under the authority of this subpart at that time for that control period. No person may import or place an order for the production of a class I controlled substance with essential-use allowances, at any time in any control period, other than for the class I controlled substance(s) for which they received essential-use allowances under paragraph (u) of this section. Every kilogram of excess production ordered in excess of the unexpended essential-use allowances conferred to the producer constitutes a separate violation of this subpart. Every kilogram of excess import in excess of the unexpended essential-use allowances held at that time constitutes a separate violation of this subpart.

(f) Effective January 1, 1996, no person may place an order by conferring transformation and destruction credits for the production of the class I controlled substance, at any time in any control period, in excess of the amount of transformation and destruction credits, held by that person under the authority of this subpart at that time for that control period. Effective January 1, 1996, no person may import class I

controlled substance, at any time in any control period, in excess of the amount of transformation and destruction credits, held by that person under the authority of this subpart at that time for that control period. No person may import or place an order for the production of a class I controlled substance with transformation and destruction credits, at any time in any control period, other than for the class I controlled substance(s) for which they received transformation and destruction credits as under §82.9(f). Every kilogram of excess production ordered in excess of the unexpended transformation and destruction credits conferred to the producer constitutes a separate violation of this subpart. Every kilogram of excess import in excess of the unexpended transformation and destruction credits held at that time constitutes a separate violation of this subpart.

(g) Effective January 1, 1996, the U.S. total production and importation of a class I controlled substance (except Group VI) as allocated under this section for essential-use allowances and exemptions, and as obtained under §82.9 for destruction and transformation credits, may not, at any time, in any control period until January 1, 2000, exceed the percent limitation of baseline production in appendix H of this subpart, as set forth in the Clean Air Act Amendments of 1990. No person shall cause or contribute to the U.S. exceedance of the national limit for that control period.

(h) No person may sell in the U.S. any Class I controlled substance produced explicitly for export to an Article 5 country.

(i) Effective January 1, 1995, no person may import, at any time in any control period, a heel of any class I controlled substance that is greater than 10 percent of the volume of the container in excess of the amount of unexpended consumption allowances, or unexpended destruction and transformation credits held by that person under the authority of this subpart at that time for that control period. Every kilogram of excess importation constitutes a separate violation of this subpart.

(j) Effective January 1, 1995, no person may import, at any time in any control period, a used class I controlled substance, without having received a non-objection notice from the Administrator in accordance with §82.13(g)(2) and (3). A person who receives a non-objection notice for the import of an individual shipment of used controlled substances may not transfer or confer the right to import, and may not import any more than the exact quantity, in kilograms, of the used controlled substance cited in the non-objection notice. Every kilogram of importation of used controlled substance in excess of the quantity cited in the non-objection notice issued by the Administrator in accordance with §82.13(g)(2) and (3) constitutes a separate violation.

(k)(1) Prior to January 1, 1996, for all Groups of class I controlled substances, and prior to January 1, 2005, for class I, Group VI controlled substances, a person may not use production allowances to produce a quantity of a class I controlled substance unless that person holds under the authority of this subpart at the same time consumption allowances sufficient to cover that quantity of class I controlled substances nor may a person use consumption allowances to produce a quantity of class I controlled substances unless the person holds under authority of this subpart at the same time production allowances sufficient to cover that quantity of class I controlled substances. However, prior to January 1, 1996, for all class I controlled substances, and prior to January 1, 2005, for class I, Group VI controlled substances, only consumption allowances are required to import, with the exception of transshipments, heels, and used controlled substances. Effective January 1, 1996, for all Groups of class I controlled substances, except Group VI, only essential use allowances or exemptions are required to import class I controlled substances, with the exception of transshipments, heels, used controlled substances, and essential use CFCs.

(2) Notwithstanding paragraph (k)(1) of this section, effective January 1, 2003, for class I, Group VI controlled substances, consumption allowances are not required to import quantities solely for quarantine or preshipment applications as defined in this subpart.

(l) Every kilogram of a controlled substance, and every controlled product, imported or exported in contravention of this subpart constitutes a separate violation of this subpart, thus no person may:

(1) Import or export any quantity of a controlled substance listed in Class I, Group I or Group II, in appendix A to this subpart from or to any foreign state not listed as a Party to the 1987 Montreal Protocol unless that foreign state is complying with the 1987 Montreal Protocol (See appendix C, Annex 2 of this subpart);

(2) Import or export any quantity of a controlled substance listed in Class I, Group III, Group IV or Group V, in appendix A to this subpart, from or to any foreign state not Party to the London Amendments (as

noted in appendix C, Annex I, to this subpart), unless that foreign state is complying with the London Amendments (as noted in appendix C, Annex 2, to this subpart); or

(3) Import a controlled product, as noted in appendix D, Annex 1 to this subpart, from any foreign state not Party to the 1987 Montreal Protocol (as noted in appendix C, Annex 1, to this subpart), unless that foreign state is complying with the Protocol (as noted in appendix C, Annex 2, to this subpart).

(4) Import or export any quantity of a controlled substance listed in Class I, Group VII, in Appendix A to this subpart, from or to any foreign state not Party to the Copenhagen Amendments (as noted in Appendix C, Annex I, to this subpart), unless that foreign state is complying with the Copenhagen Amendments (as noted in Appendix C, Annex 2, to this subpart).

(5) Import or export any quantity of a controlled substance listed in Class I, Group VI, in Appendix A to this subpart, from or to any foreign state not Party to the Copenhagen Amendments (as noted in Appendix C, Annex I, to this subpart), unless that foreign state is complying with the Copenhagen Amendments (as noted in Appendix C, Annex 2, to this subpart).

(6) Import or export any quantity of a controlled substance listed in Class I, Group VIII, in appendix A to this subpart, from or to any foreign state not Party to the Beijing Amendments (as noted in appendix C, Annex 1, to this subpart), unless that foreign state is complying with the Beijing Amendments (as noted in appendix C, Annex 2, to this subpart).

(m) Effective October 5, 1998, no person may export a controlled product to a Party listed in Appendix J of this subpart in any control period after the control period in which EPA publishes a notice in the Federal Register listing that Party in Appendix J of this subpart. EPA will publish a notice in the Federal Register that lists a Party in Appendix J if the Party formally presents to the U.S. a government document through its embassy in the United States stating that it has established a ban on the import of controlled products and a ban on the manufacture of those same controlled products.

(n) No person may use class I controlled substances produced or imported under the essential use exemption for any purpose other than those set forth in this paragraph. Effective January 1, 1996, essential-use allowances are apportioned to a person under §82.8(a) and (b) for the exempted production or importation of specified class I controlled substances solely for the purposes listed in paragraphs (n)(1)(i) through (iii) of this section.

(1) Essential-uses for the production or importation of controlled substances as agreed to by the Parties to the Protocol and subject to the periodic revision of the Parties are:

(i) Metered dose inhalers (MDIs) for the treatment of asthma and chronic obstructive pulmonary disease that were approved by the Food and Drug Administration before December 31, 2000.

(ii) Space Shuttle—solvents.

(iii) Essential laboratory and analytical uses (defined in Appendix G of this subpart).

(2) Any person acquiring unused class I controlled substances produced or imported under the authority of essential-use allowances or the essential-use exemption granted in §82.8 to this subpart for use in anything other than an essential-use (i.e., for uses other than those specifically listed in paragraph (n) (1) of this section) is in violation of this subpart. Each kilogram of unused class I controlled substance produced or imported under the authority of essential-use allowances or the essential-use exemption and used for a non-essential use is a separate violation of this subpart. Any person selling unused class I controlled substances produced or imported under authority of essential-use allowances or the essential-use exemption for uses other than an essential-use is in violation of this subpart. Each kilogram of unused class I controlled substances produced or imported under authority of essential-use allowances or the essential-use exemption and sold for a use other than an essential-use is a separate violation of this subpart. It is a violation of this subpart to obtain unused class I controlled substances under the exemption for laboratory and analytical uses in excess of actual need and to recycle that material for sale into other markets.

(o) [Reserved]

(p) Critical Use Exemption: With respect to class I, Group VI substances (methyl bromide):

(1) For critical use allowance holders and critical stock allowance holders:

(i) No person shall sell critical use methyl bromide without first receiving a certification from the purchaser that the quantity purchased will be sold or used solely for an approved critical use. Every kilogram of critical use methyl bromide sold without first obtaining such certification constitutes a separate violation of this subpart.

(ii) No person shall sell a portion of inventory produced or imported prior to the January 1, 2005 phaseout date as critical use methyl bromide in excess of the number of unexpended critical stock allowances held by that person.

(iii) A person who sells methyl bromide produced or imported before the phaseout date of January 1, 2005 for a use identified by the user as a critical use must hold sufficient critical stock allowances (CSA) for the transaction and shall expend one allowance for each kilogram of methyl bromide sold. Every kilogram of critical use methyl bromide produced or imported before the phaseout date of January 1, 2005 that is sold without expending an allowance constitutes a separate violation of this subpart.

(2) For approved critical users, each action associated with each 200 kilograms of critical use methyl bromide for the following subparagraphs constitutes a separate violation of this subpart.

(i) No person shall take possession of quantities of critical use methyl bromide or acquire fumigation services using quantities of critical use methyl bromide without first completing the appropriate certification in accordance with the requirements in §82.13.

(ii) No person who purchases critical use methyl bromide may use such quantities for a use other than the specified critical use listed in Column A and the specified location of use in Column B of Appendix L to this subpart.

(iii) No person who purchases critical use methyl bromide produced or imported with expended critical use allowances for pre-plant uses, may use such quantities for other than the pre-plant uses as specified in Column A and Column B of appendix L to this subpart.

(iv) No person who purchases critical use methyl bromide produced or imported with expended critical use allowances for post-harvest uses, may use such quantities for other than the post-harvest uses as specified in Column A and Column B of appendix L to this subpart.

(v) No person who uses critical use methyl bromide on a specific field or structure may concurrently or subsequently use non-critical use methyl bromide on the same field or structure for the same use (as defined in Column A and Column B of appendix L) in the same control period, excepting methyl bromide used under the quarantine and pre-shipment exemption.

(vi) No person who purchases critical use methyl bromide during the control period shall use that methyl bromide on a field or structure for which that person has used non-critical use methyl bromide for the same use (as defined in Columns A and B of Appendix L) in the same control period, excepting methyl bromide used under the quarantine and pre-shipment exemption, unless, subsequent to that person's use of the non-critical use methyl bromide, that person becomes subject to a prohibition on the use of methyl bromide alternatives due to the reaching of a local township limit described in Appendix L of this part, or becomes an approved critical user as a result of rulemaking.

(q) Emergency use exemption. [Reserved]

[60 FR 24986, May 10, 1995]

Editorial Note: For Federal Register citations affecting §82.4, see the List of CFR Sections Affected, which appears in the Finding Aids section of the printed volume and on GPO Access.

§ 82.5 Apportionment of baseline production allowances for class I controlled substances.

Persons who produced controlled substances in Group I or Group II in 1986 are apportioned baseline production allowances as set forth in paragraphs (a) and (b) of this section. Persons who produced controlled substances in Group III, IV, or V in 1989 are apportioned baseline production allowances as set forth in paragraphs (c), (d), and (e) of this section. Persons who produced controlled substances in Group VI and VII in 1991 are apportioned baseline allowances as set forth in paragraphs (f) and (g) of this section.

Controlled substance	Person	Allowances (kg)
(a) For Group I controlled substances:		
CFC-11	Allied-Signal, Inc	23,082,358
	E.I. DuPont de Nemours & Co	33,830,000
	Elf Atochem, N.A	21,821,500
CFC-12	Laroche Chemicals	12,856,364
	Allied-Signal, Inc	35,699,776
	E.I. DuPont de Nemours & Co	64,849,000
	Elf Atochem, N.A	31,089,807
CFC-113	Laroche Chemicals	15,330,909
	Allied-Signal, Inc	21,788,896
CFC-114	E.I. DuPont de Nemours & Co	58,553,000
	Allied-Signal, Inc	1,488,569
CFC-115	E.I. DuPont de Nemours & Co	4,194,000
	E.I. DuPont de Nemours & Co	4,176,000
(b) For Group II controlled substances:		
Halon-1211	Great Lakes Chemical Corp	826,487
	ICI Americas, Inc	2,135,484
Halon-1301	E.I. DuPont de Nemours & Co	3,220,000
	Great Lakes Chemical Corp	1,766,850
Halon-2402		
(c) For Group III controlled substances:		
CFC-13	Allied-Signal, Inc	127,125
	E.I. DuPont de Nemours & Co	187,831
	Elf Atochem, N.A	3,992
	Great Lakes Chemical Corp	56,381
	Laroche Chemicals	29,025
CFC-111		
CFC-112		
CFC-211	E.I. DuPont de Nemours & Co	11
CFC-212	E.I. DuPont de Nemours & Co	11
CFC-213	E.I. DuPont de Nemours & Co	11
CFC-214	E.I. DuPont de Nemours & Co	11
CFC-215	E.I. DuPont de Nemours & Co	511
	Halocarbon Products Corp	1,270

CFC-216	E.I. DuPont de Nemours & Co	170,574
CFC-217	E.I. DuPont de Nemours & Co	511
(d) For Group IV controlled substances:		
CCl ₄	Akzo Chemicals, Inc	7,873,615
	Degussa Corporation	26,546
	Dow Chemical Company, USA	18,987,747
	E.I. DuPont de Nemours & Co	9,099
	Hanlin Chemicals-WV, Inc	219,616
	ICI Americas, Inc	853,714
	Occidental Chemical Corp	1,059,358
	Vulcan Chemicals	21,931,987
(e) For Group V controlled substances:		
Methyl Chloroform	Dow Chemical Company, USA	168,030,117
	E.I. DuPont de Nemours & Co	2
	PPG Industries, Inc	57,450,719
	Vulcan Chemicals	89,689,064
(f) For Group VI controlled substances:		
Methyl Bromide	Great Lakes Chemical Corporation	19,945,788
	Ethyl Corporation	8,233,894
(g) For Group VII controlled substances:		
HBFC 22B1-1	Great Lakes Chemical Corporation	46,211

[60 FR 24986, May 10, 1995, as amended at 68 FR 2848, Jan. 21, 2003]

§ 82.6 Apportionment of baseline consumption allowances for class I controlled substances.

Persons who produced, imported, or produced and imported controlled substances in Group I or Group II in 1986 are apportioned chemical-specific baseline consumption allowances as set forth in paragraphs (a) and (b) of this section. Persons who produced, imported, or produced and imported controlled substances in Group III, Group IV, or Group V in 1989 are apportioned chemical-specific baseline consumption allowances as set forth in paragraphs (c), (d) and (e) of this section. Persons who produced, imported, or produced and imported controlled substances in Group VI or VII in 1991 are apportioned chemical specific baseline consumption allowances as set forth in paragraphs (f) and (g) of this section.

Controlled substance	Person	Allowances (kg)
(a) For Group I controlled substances:		
CFC-11	Allied-Signal, Inc	22,683,833
	E.I. DuPont de Nemours & Co	32,054,283
	Elf Atochem, N.A	21,740,194
	Hoechst Celanese Corporation	185,396
	ICI Americas, Inc	1,673,436
	Kali-Chemie Corporation	82,500

	Laroche Chemicals	12,695,726
	National Refrigerants, Inc	693,707
	Refricentro, Inc	160,697
	Sumitomo Corporation of America	5,800
CFC-12	Allied-Signal, Inc	35,236,397
	E.I. DuPont de Nemours & Co	61,098,726
	Elf Atochem, N.A	32,403,869
	Hoechst Celanese Corporation	138,865
	ICI Americas, Inc	1,264,980
	Kali-Chemie Corporation	355,440
	Laroche Chemicals	15,281,553
	National Refrigerants, Inc	2,375,384
	Refricentro, Inc	242,526
CFC-113	Allied-Signal, Inc	18,241,928
	E.I. DuPont de Nemours & Co	49,602,858
	Elf Atochem, N.A	244,908
	Holchem	265,199
	ICI Americas, Inc	2,399,700
	Refricentro, Inc	37,385
	Sumitomo Corp. of America	280,163
CFC-114	Allied-Signal, Inc	1,429,582
	E.I. DuPont de Nemours & Co	3,686,103
	Elf Atochem, N.A	22,880
	ICI Americas, Inc	32,930
CFC-115	E.I. DuPont de Nemours & Co	2,764,109
	Elf Atochem, N.A	633,007
	Hoechst Celanese Corporation	8,893
	ICI Americas, Inc	2,366,351
	Laroche Chemicals	135,520
	Refricentro, Inc	27,337
(b) For Group II controlled substances:		
Halon-1211	Elf Atochem, N.A	411,292
	Great Lakes Chemical Corp	772,775
	ICI Americas, Inc	2,116,641
	Kali-Chemie Corporation	330,000
Halon-1301	E.I. DuPont de Nemours & Co	2,772,917
	Elf Atochem, N.A	89,255
	Great Lakes Chemical Corp	1,744,132
	Kali-Chemie Corporation	54,380
Halon-2402	Ausimont	34,400

	Great Lakes Chemical Corp	15,900
(c) For Group III controlled substances:		
CFC-13	Allied-Signal, Inc	127,124
	E.I. DuPont de Nemours & Co	158,508
	Elf Atochem, N.A	3,992
	Great Lakes Chemical Corp	56,239
	ICI Americas, Inc	5,855
	Laroche Chemicals	29,025
	National Refrigerants, Inc	16,665
CFC-111		
CFC-112	Sumitomo Corp of America	5,912
	TG (USA) Corporation	9,253
CFC-211	E.I. DuPont de Nemours & Co	11
CFC-212	E.I. DuPont de Nemours & Co	11
CFC-213	E.I. DuPont de Nemours & Co	11
CFC-214	E.I. DuPont de Nemours & Co	11
CFC-215	E.I. DuPont de Nemours & Co	511
	Halocarbon Products Corp	1,270
CFC-216	E.I. DuPont de Nemours & Co	170,574
CFC-217	E.I. DuPont de Nemours & Co	511
(d) For Group IV controlled substances:		
CCl ₄	Crescent Chemical Co	56
	Degussa Corporation	12,466
	Dow Chemical Company, USA	8,170,561
	E.I. DuPont de Nemours & Co	26,537
	Elf Atochem, N.A	41
	Hanlin Chemicals-WV, Inc	103,133
	Hoechst Celanese Corporation	3
	ICC Chemical Corp	1,173,723
	ICI Americas, Inc	855,466
	Occidental Chemical Corp	497,478
	Sumitomo Corporation of America	9
(e) For Group V controlled substances:		
Methyl Chloroform	3V Chemical Corp	3,528
	Actex, Inc	50,171
	Atochem North America	74,355
	Dow Chemical Company, USA	125,200,200
	E.I. DuPont de Nemours & Co	2
	IBM	2,026
	ICI Americas, Inc	14,179,850

	Laidlaw	420,207
	PPG Industries	45,254,115
	Sumitomo	1,954
	TG (USA) Corporation	7,073
	Unitor Ships Service, Inc	14,746
	Vulcan Chemicals	70,765,072
(f) For Group VI controlled substances:		
Methyl Bromide	Great Lakes Chemical Corporation	15,514,746
	Ethyl Corporation	6,379,906
	AmeriBrom, Inc	3,524,393
	TriCal, Inc	109,225
(g) For Group VII controlled substances:		
HBFC 22B1-1	Great Lakes Chemical Corporation	40,110

[60 FR 24986, May 10, 1995, as amended at 68 FR 2848, Jan. 21, 2003]

§ 82.7 Grant and phase reduction of baseline production and consumption allowances for class I controlled substances.

For each control period specified in the following table, each person is granted the specified percentage of the baseline production and consumption allowances apportioned to him under §82.5 and 82.6 of this subpart.

Control period	Class I substances in groups I and III, (In percent)	Class I substances in group II, (In percent)	Class I substances in group IV (In percent)	Class I substances in group V (In percent)	Class I substances in group VI (In percent)	Class I substances in group VII (In percent)
1994	25	0	50	50	100	100
1995	25	0	15	30	100	100
1996	0	0	0	0	100	0
1997	0	0	0	0	100	0
1998	0	0	0	0	100	0
1999	0	0	0	0	75	0
2000	0	0	0	0	75	0
2001					50	
2002					50	
2003					30	
2004					30	
2005					0	

[65 FR 70803, Nov. 28, 2000]

§ 82.8 Grant of essential use allowances and critical use allowances.

(a) Effective January 1, 1996, persons in the following list are allocated essential-use allowances or exemptions for quantities of a specific class I controlled substance for a specific essential-use (the Administrator reserves the right to revise the allocations based on future decisions of the Parties).

Table I—Essential Use Allowances for Calendar Year 2007

Company	Chemical	2007 Quantity (metric tons)
(i) Metered Dose Inhalers (for oral inhalation) for Treatment of Asthma and Chronic Obstructive Pulmonary Disease		
Armstrong Pharmaceuticals	CFC-114 (production of epinephrine MDIs only)	22.4
Inyx (Aventis)	CFC-11 or CFC-12 or CFC-114	39.6
3M Pharmaceuticals	CFC-11 or CFC-12 or CFC-114	65.0
Wyeth	CFC-11 or CFC-12 or CFC-114	40.0

(b) A global exemption for class I controlled substances for essential laboratory and analytical uses shall be in effect through December 31, 2007, subject to the restrictions in appendix G of this subpart, and subject to the record keeping and reporting requirements at §82.13(u) through (x). There is no amount specified for this exemption.

(c) Effective January 1, 2005, critical use allowances are apportioned as set forth in paragraph (c)(1) of this section for the exempted production and import of class I, Group VI controlled substances specifically for those approved critical uses listed in Appendix L to this subpart for the applicable control period. Every kilogram of production and import in excess of the total number and type of unexpended critical use allowances held for a particular type of use constitutes a separate violation of this subpart. Effective January 1, 2005, critical stock allowances are issued as set forth in paragraph (c)(2) of this section for the sale of class I, Group VI controlled substances from inventory produced or imported before the January 1, 2005 phaseout date specifically for those approved critical uses listed in Appendix L to this subpart for the applicable control period.

(1) Allocated critical use allowances granted for specified control period.

Company	2007 Critical use allowances for pre-plant uses* (kilograms)	2007 Critical use allowances for post-harvest uses* (kilograms)
Great Lakes Chemical Corp	2,401,699	221,167
Albemarle Corp	987,633	90,949
Ameribrom, Inc	545,787	50,260
TriCal, Inc	16,994	1,565
Total	3,952,114	363,941

*For production or import of class I, Group VI controlled substance exclusively for the Pre-Plant or Post-Harvest uses specified in appendix L to this subpart.

(2) Allocated critical stock allowances granted for specified control period. The following companies are allocated critical stock allowances for 2007 on a pro-rata basis in relation to the inventory held by each.

Company	Company
Albemarle	Industrial Fumigation Company.
Ameribrom, Inc	J.C. Ehrlich Co.
Bill Clark Pest Control, Inc	Pacific Ag.
Blair Soil Fumigation	Pest Fog Sales Corp.
Burnside Services, Inc	Prosource One.
Cardinal Professional Products	Reddick Fumigants.
Carolina Eastern, Inc.	Royster-Clark, Inc.
Degesch America, Inc	Southern State Cooperative, Inc.
Dodson Bros	Trical Inc.
Great Lakes Chemical Corp	Trident Agricultural Products.
Harvey Fertilizer & Gas	UAP Southeast (NC).
Helena Chemical Co.	UAP Southeast (SC).
Hendrix & Dail	Univar.
Hy Yield Bromine	Vanguard Fumigation Co.
	Western Fumigation.

Total—1,914,600 kilograms.

[69 FR 77003, Dec. 23, 2004, as amended at 70 FR 49844, Aug. 24, 2005; 70 FR 73614, Dec. 13, 2005; 70 FR 77052, Dec. 29, 2005; 71 FR 6005, Feb. 6, 2006; 71 FR 25078, Apr. 28, 2006; 71 FR 58514, Oct. 4, 2006; 71 FR 75403, Dec. 14, 2006; 72 FR 32222, June 12, 2007]

§ 82.9 Availability of production allowances in addition to baseline production allowances for class I controlled substances.

(a) Every person apportioned baseline production allowances for class I controlled substances under §82.5 (a) through (f) of this subpart is also granted Article 5 allowances equal to:

(1) 10 percent of their baseline production allowances listed for class I, Group I, Group III, Group IV, and Group V controlled substances listed under §82.5 of this subpart for each control period ending before January 1, 1996;

(2) 15 percent of their baseline production allowances for class I, Group VI controlled substances listed under §82.5 of this subpart for each control period ending before January 1, 2005;

(3) 15 percent of their baseline production allowances for class I, Group II controlled substances listed under §82.5 of this subpart for each control period beginning January 1, 1994, until January 1, 2003;

(4) 15 percent of their baseline production allowances for Class I, Group IV and Group V controlled substances listed under §82.5 of this subpart for each control period beginning January 1, 1996 until January 1, 2010;

(b) Effective January 1, 1995, a person allocated Article 5 allowances may produce class I controlled substances for export to Article 5 countries as under §82.11 and transfer Article 5 allowances as under §82.12.

(c) A company may increase or decrease its production allowances, its Article 5 allowances by trading with another Party to the Protocol according to the provision under this paragraph (c). A company may increase or decrease its essential-use allowances for CFCs for use in essential MDIs according to the provisions under this paragraph (c). A nation listed in appendix C to this subpart (Parties to the Montreal

Protocol) must agree either to transfer to the person for the current control period some amount of production or import that the nation is permitted under the Montreal Protocol or to receive from the person for the current control period some amount of production or import that the person is permitted under this subpart. If the controlled substance is produced under the authority of production allowances and is to be returned to the Party from whom production allowances are received, the request for production allowances shall also be considered a request for consumption allowances under §82.10(c). If the controlled substance is produced under the authority of production allowances and is to be sold in the United States or to another Party (not the Party from whom the allowances are received), the U.S. company must expend its consumption allowances allocated under §82.6 and §82.7 in order to produce with the additional production allowances.

(1) For trades from a Party, the person must obtain from the principal diplomatic representative in that nation's embassy in the United States a signed document stating that the appropriate authority within that nation has established or revised production limits or essential-use allowance limits for the nation to equal the lesser of the maximum production that the nation is allowed under the Protocol minus the amount transferred, the maximum production or essential-use allowances that are allowed under the nation's applicable domestic law minus the amount transferred, or the average of the nation's actual national production level for the three years prior to the transfer minus the production transferred. The person must submit to the Administrator a transfer request that includes a true copy of this document and that sets forth the following:

- (i) The identity and address of the person;
- (ii) The identity of the Party;
- (iii) The names and telephone numbers of contact persons for the person and for the Party;
- (iv) The chemical type, type of allowance being transferred, and the level of allowances being transferred;
- (v) The control period(s) to which the transfer applies; and
- (vi) For increased production intended for export to the Party from whom the allowances would be received, a signed statement of intent to export to the Party.
- (vii) In the case of transferring essential-use allowances, the transferor must include a signed document from the transferee identifying the CFC MDI products that will be produced using the essential-use allowances.

(2) For trades to a Party, a person must submit a transfer request that sets forth the following:

- (i) The identity and address of the person;
- (ii) The identity of the Party;
- (iii) The names and telephone numbers of contact persons for the person and for the Party;
- (iv) The chemical type, type of allowance being transferred, and the level of allowances being transferred; and
- (v) The control period(s) to which the transfer applies.

(3) After receiving a transfer request that meets the requirements of paragraph (c)(2) of this section, the Administrator may, at his discretion, consider the following factors in deciding whether to approve such a transfer:

- (i) Possible creation of economic hardship;
- (ii) Possible effects on trade;

(iii) Potential environmental implications; and

(iv) The total amount of unexpended production or essential-use allowances held by a U.S. entity.

(v) In the case of transfer of essential-use allowances the Administrator may consider whether the CFCs will be used for production of essential MDIs.

(4) The Administrator will issue the person a notice either granting or deducting production allowances, Article 5 allowances, or essential-use allowances, and specifying the control period to which the transfer applies, provided that the request meets the requirement of paragraph (c)(1) of this sections for trades from Parties and paragraph (c)(2) of this section for trades to Parties, unless the Administrator has decided to disapprove the trade under paragraph (c)(3) of this section. For a trade from a Party, the Administrator will issue a notice that revises the allowances held by the person to equal the unexpended production, Article 5, or essential-use allowances held by the person under this subpart plus the level of allowable production transferred from the Party. For a trade to a Party, the Administrator will issue a notice that revises the production limit for the person to equal the lesser of:

(i) The unexpended production allowances, essential-use allowances, or Article 5 allowances held by the person under this subpart minus the amount transferred; or

(ii) The unexpended production allowances, essential-use allowances, or Article 5 allowances held by the person under this subpart minus the amount by which the United States average annual production of the controlled substance being traded for the three years prior to the transfer is less than the total production allowable for that substance under this subpart minus the amount transferred. The change in allowances will be effective on the date that the notice is issued.

(5) If after one person obtains approval for a trade of allowable production of a controlled substance to a Party, one or more other persons obtain approval for trades involving the same controlled substance and the same control period, the Administrator will issue notices revising the production limits for each of the other persons trading that controlled substance in that control period to equal the lesser of:

(i) The unexpended production allowances or Article 5 allowances held by the person under this subpart minus the amount transferred; or

(ii) The unexpended production allowances or Article 5 allowances held by the person under this subpart minus the amount by which the United States average annual production of the controlled substance being traded for the three years prior to the transfer is less than the total allowable production for that substance under this subpart multiplied by the amount transferred divided by the total amount transferred by all the other persons trading the same controlled substance in the same control period minus the amount transferred by that person.

(iii) The Administrator will also issue a notice revising the production limit for each person who previously obtained approval of a trade of that substance in that control period to equal the unexpended production allowances or unexpended Article 5 allowances held by the person under this subpart plus the amount by which the United States average annual production of the controlled substance being traded for the three years prior to the transfer is less than the total allowable production under this subpart multiplied by the amount transferred by that person divided by the amount transferred by all of the persons who have traded that controlled substance in that control period. The change in production allowances or Article 5 allowances will be effective on the date that the notice is issued.

(d) Effective January 1, 1996, there will be no trade in production or consumption allowances with other Parties to the Protocol for class I controlled substances, except for class I, Group VI, methyl bromide.

(e) Until January 1, 1996 for all class I controlled substances, except Group VI, and until January 1, 2005 for class I, Group VI, a person may obtain production allowances for that controlled substance equal to the amount of that controlled substance produced in the United States that was transformed or destroyed within the United States, or transformed or destroyed by a person of another Party, in the cases where production allowances were expended to produce such substance in the U.S. in accordance with the provisions of this paragraph. A request for production allowances under this section will be considered a request for consumption allowances under §82.10(b).

(1) Until January 1, 1996, for all class I controlled substances, except Group VI, and until January 1, 2005, for class I, Group VI, a person must submit a request for production allowances that includes the following:

- (i) The name, address, and telephone number of the person requesting the allowances, and the Employer Identification Number if the controlled substance is being exported;
- (ii) The name, quantity, and level of controlled substance transformed or the name, quantity and volume destroyed, and the commodity code if the substance was exported;
- (iii) A copy of the invoice or receipt documenting the sale of the controlled substance, including the name, address, contact person and telephone number of the transformer or destroyer;
- (iv) A certification that production allowances were expended for the production of the controlled substance, and the date of purchase, if applicable;
- (v) If the controlled substance is transformed, the name, quantity, and verification of the commercial use of the resulting chemical and a copy of the IRS certificate of intent to use the controlled substance as a feedstock; and,
- (vi) If the controlled substance is destroyed, the verification of the destruction efficiency.

(2) Until January 1, 1996 for all class I controlled substances, except Group VI, and until January 1, 2005, for class I, Group VI, the Administrator will review the information and documentation submitted under paragraph (e)(1) of this section and will assess the quantity of class I controlled substance that the documentation and information verifies was transformed or destroyed. The Administrator will issue the person production allowances equivalent to the controlled substances that the Administrator determines were transformed or destroyed. For controlled substances completely destroyed under this rule, the Agency will grant allowances equal to 100 percent of volume intended for destruction. For those controlled substances destroyed at less than a 98 percent destruction efficiency, the Agency will grant allowances commensurate with that percentage of destruction efficiency that is actually achieved. The grant of allowances will be effective on the date that the notice is issued.

(3) Until January 1, 1996 for all class I controlled substances, except Group VI, and until January 1, 2005, for class I, Group VI, if the Administrator determines that the request for production allowances does not satisfactorily substantiate that the person transformed or destroyed controlled substances as claimed, or that modified allowances were not expended, the Administrator will issue a notice disallowing the request for additional production allowances. Within ten working days after receipt of notification, the person may file a notice of appeal, with supporting reasons, with the Administrator. The Administrator may affirm the disallowance or grant an allowance, as she/he finds appropriate in light of the available evidence. If no appeal is taken by the tenth day after notification, the disallowance will be final on that day.

(f) Effective January 1, 1996, and until January 1, 2000, a person who was nominated by the United States to the Secretariat of the Montreal Protocol for an essential use exemption may obtain destruction and transformation credits for a class I controlled substance (except class I, Group VI) equal to the amount of that controlled substance produced in the United States that was destroyed or transformed within the United States in cases where the controlled substance was produced for other than destruction or transformation in accordance with the provisions of this subpart, subtracting an offset of 15 percent.

(1) Effective January 1, 1996, and until January 1, 2000, a person must submit a request for destruction and transformation credits that includes the following:

- (i) The identity and address of the person and the essential-use exemption and years for which the person was nominated to the Secretariat of the Montreal Protocol;
- (ii) The name, quantity and volume of controlled substance destroyed or transformed;
- (iii) A copy of the invoice or receipt documenting the sale or transfer of the controlled substance to the person;

- (iv) A certification of the previous use of the controlled substance;
- (v) For destruction credits, a certification that the controlled substance was destroyed and a certification of the efficiency of the destruction process; and
- (vi) For transformation credits, an IRS certificate of feedstock use or transformation of the controlled substance.

(2) Effective January 1, 1996, and until January 1, 2000, the Administrator will issue the person destruction and transformation credits equivalent to the class I controlled substance (except class I, Group VI) recovered from a use system in the United States, that the Administrator determines were destroyed or transformed, subtracting the offset of 15 percent. For controlled substances completely destroyed under this rule, the Agency will grant destruction credits equal to 100 percent of volume destroyed minus the offset. For those controlled substances destroyed at less than a 98 percent destruction efficiency, the Agency will grant destruction credits commensurate with that percentage of destruction efficiency that is actually achieved minus the offset. The grant of credits will be effective on the date that the notice is issued.

(3) Effective January 1, 1996, and until January 1, 2000, if the Administrator determines that the request for destruction and transformation credits does not satisfactorily substantiate that the person was nominated for an essential-use exemption by the United States to the Secretariat for the Montreal Protocol for the control period, or that the person destroyed or transformed a class I controlled substance as claimed, or that the controlled substance was not recovered from a U.S. use system the Administrator will issue a notice disallowing the request for additional destruction and transformation credits. Within ten working days after receipt of notification, the person may file a notice of appeal, with supporting reasons, with the Administrator. The Administrator may affirm the disallowance or grant an allowance, as she/he finds appropriate in light of the available evidence. If no appeal is taken by the tenth day after notification, the disallowance will be final on that day.

(g) *International transfer of essential-use CFCs.* (1) For trades of essential-use CFCs where the transferee or the transferor is a person in another nation (Party), the persons involved in the transfer must submit the information requested in §82.12(d)(2) and (d)(3), along with a signed document from the principal diplomatic representative in the Party's embassy in the United States stating that the appropriate authority within that nation has approved the transfer of the essential-use CFCs.

(2) If the transfer claim is complete, and EPA does not object to the transfer, then EPA will issue letters to the transferor and the transferee indicating that the transfer may proceed. EPA reserves the right to disallow a transfer if the transfer request is incomplete, or if it has reason to believe that the transferee plans to produce MDIs that are not essential MDIs. If EPA objects to the transfer, EPA will issue letters to the transferor and transferee stating the basis for disallowing the transfer. The burden of proof is placed on the transferee to retain sufficient records to prove that the transferred essential-use CFCs are used only for production of essential MDIs. If EPA ultimately finds that the transferee did not use the essential-use CFCs for production of essential MDIs then the transferee is in violation of this subpart.

[60 FR 24986, May 10, 1995, as amended at 63 FR 41643, Aug. 4, 1998; 63 FR 53290, Oct. 5, 1998; 65 FR 70804, Nov. 28, 2000; 67 FR 6360, Feb. 11, 2002; 67 FR 21134, Apr. 29, 2002; 70 FR 77047, Dec. 29, 2005]

§ 82.10 Availability of consumption allowances in addition to baseline consumption allowances for class I controlled substances.

(a) Until January 1, 1996 for all class I controlled substances, except Group VI, and until January 1, 2005, for class I, Group VI, any person may obtain, in accordance with the provisions of this subsection, consumption allowances equivalent to the level of class I controlled substances (other than used controlled substances or transshipments) that the person has exported from the United States and its territories to a Party (as listed in appendix C to this subpart).

(1) Until January 1, 1996 for all class I controlled substances, except Group VI, and until January 1, 2005, for class I, Group VI, to receive consumption allowances in addition to baseline consumption allowances, the exporter of the class I controlled substances must submit to the Administrator a request for consumption allowances setting forth the following:

- (i) The identities and addresses of the exporter and the recipient of the exports;
- (ii) The exporter's Employer Identification Number;
- (iii) The names and telephone numbers of contact persons for the exporter and the recipient;
- (iv) The quantity and type of controlled substances exported;
- (v) The source of the controlled substance and the date purchased;
- (vi) The date on which, and the port from which, the controlled substances were exported from the United States or its territories;
- (vii) The country to which the controlled substances were exported;
- (viii) A copy of the bill of lading and the invoice indicating the net quantity of controlled substances shipped and documenting the sale of the controlled substances to the purchaser.
- (ix) The commodity code of the controlled substance exported; and
- (x) Written statement from the producer that the controlled substance was produced with expended allowances.

(2) The Administrator will review the information and documentation submitted under paragraph (a)(1) of this section and will assess the quantity of controlled substances that the documentation verifies was exported. The Administrator will issue the exporter consumption allowances equivalent to the level of controlled substances that the Administrator determined were exported. The grant of the consumption allowances will be effective on the date the notice is issued. If the Administrator determines that the information and documentation does not satisfactorily substantiate that the person exported controlled substances as claimed the Administrator will issue a notice that the consumption allowances are not granted.

(b) Until January 1, 1996, a person may obtain consumption allowances for a class I controlled substance (and until January 1, 2005 for class I, Group VI) equal to the amount of a controlled substance either produced in, or imported into, the United States that was transformed or destroyed in the case where consumption allowances were expended to produce or import such substance in accordance with the provisions of this paragraph. However, a person producing or importing a controlled substance (except class I, Group VI) that was transformed or destroyed must submit to the Administrator the information described under §82.13 (f)(3) (i) and (ii).

(c) A company may also increase its consumption allowances by receiving production from another Party to the Protocol for class I, Group I through Group V and Group VII controlled substances until January 1, 1996 and for class I, Group VI controlled substances until January 1, 2005. A nation listed in appendix C to this subpart (Parties to the Montreal Protocol) must agree to transfer to the person for the current control period some amount of production that the nation is permitted under the Montreal Protocol. If the controlled substance is to be returned to the Party from whom allowances are received, the request for consumption allowances shall also be considered a request for production allowances under §82.9(c). For trades from a Party, the person must obtain from the principal diplomatic representative in that nation's embassy in the United States a signed document stating that the appropriate authority within that nation has established or revised production limits for the nation to equal the lesser of the maximum production that the nation is allowed under the Protocol minus the amount transferred, the maximum production that is allowed under the nation's applicable domestic law minus the amount transferred, or the average of the nation's actual national production level for the three years prior to the transfer minus the production allowances transferred. The person must submit to the Administrator a transfer request that includes a true copy of this document and that sets forth the following:

- (1) The identity and address of the person;
- (2) The identity of the Party;

- (3) The names and telephone numbers of contact persons for the person and for the Party;
- (4) The chemical type and level of production being transferred;
- (5) The control period(s) to which the transfer applies; and
- (6) For increased production intended for export to the Party from whom allowances would be received, a signed statement of intent to export to this Party.

(d) On the first day of each control period, until January 1, 1996, the Agency will grant consumption allowances to any person that produced and exported a Group IV controlled substance in the baseline year and that was not granted baseline consumption allowances under §82.5.

(1) The number of consumption allowances any such person will be granted for each control period will be equal to the number of production allowances granted to that person under §82.7 for that control period.

(2) Any person granted allowances under this paragraph must hold the same number of unexpended consumption allowances for the control period for which the allowances were granted by February 15 of the following control period. Every kilogram by which the person's unexpended consumption allowances fall short of the amount the person was granted under this paragraph constitutes a separate violation.

[60 FR 24986, May 10, 1995, as amended at 65 FR 70804, Nov. 28, 2000]

§ 82.11 Exports of class I controlled substances to Article 5 Parties.

(a) If apportioned Article 5 allowances under §82.9(a) or §82.11(a)(2), a person may produce Class I controlled substances, in accordance with the prohibitions in §82.4 and the reduction schedule in §82.11(a)(3), to be exported (not including exports resulting in transformation or destruction, or exports of used controlled substances) to foreign states listed in appendix E to this subpart (Article 5 countries).

(1) A person must submit a notice to the Administrator of exports to Article 5 countries (except exports resulting in transformation or destruction, or used controlled substances) at the end of the quarter that includes the following:

- (i) The identities and addresses of the exporter and the Article 5 country recipient of the exports;
- (ii) The exporter's Employee Identification Number;
- (iii) The names and telephone numbers of contact persons for the exporter and for the recipient;
- (iv) The quantity and the type of controlled substances exported, its source and date purchased;
- (v) The date on which, and the port from which, the controlled substances were exported from the United States or its territories;
- (vi) The Article 5 country to which the controlled substances were exported;
- (vii) A copy of the bill of lading and invoice indicating the net quantity shipped and documenting the sale of the controlled substances to the Article 5 purchaser;
- (viii) The commodity code of the controlled substance exported; and
- (ix) A copy of the invoice or sales agreement covering the sale of the controlled substances to the recipient Article 5 country that contains provisions forbidding the reexport of the controlled substance in bulk form and subjecting the recipient or any transferee of the recipient to liquidated damages equal to the resale price of the controlled substances if they are reexported in bulk form.

(2) Persons who reported exports of Class I, Group I controlled substances to Article 5 countries in 2000–2003 are apportioned baseline Article 5 allowances as set forth in §82.11(a)(2)(i). Persons who reported exports of Class I, Group VI controlled substances to Article 5 countries in 1995–1998 are apportioned baseline Article 5 allowances as set forth in §82.11(a)(2)(ii).

(i) For Group I Controlled Substances

Controlled Substance	Person	Allowances (kg)
CFC–11	Honeywell	7,150
	Sigma Aldrich	1
CFC–113	Fisher Scientific	5
	Honeywell	313,686
	Sigma Aldrich	48
CFC–114	Honeywell	24,798
	Sigma Aldrich	1

(ii) For Group VI Controlled Substances

Controlled Substance	Person	Allowances (kg)
Methyl Bromide	Albemarle	1,152,714
	Ameribrom	176,903
	Great Lakes Chemical Corporation	3,825,846

(3) Phased Reduction Schedule for Article 5 Allowances allocated in §82.11. For each control period specified in the following table, each person is granted the specified percentage of the baseline Article 5 allowances apportioned under §82.11.

Control Period	Class I substances in group I (In percent)	Class I substances in group VI (In percent)
2006	50	80
2007	15	80
2008	15	80
2009	15	80
2010	0	80
2011	0	80
2012	0	80
2013	0	80
2014	0	80
2015	0	0

(2) [Reserved]

(b) [Reserved]

[60 FR 24986, May 10, 1995, as amended at 70 FR 77047, Dec. 29, 2005]

§ 82.12 Transfers of allowances for class I controlled substances.

(a) *Inter-company transfers.* (1) Until January 1, 1996, for all class I controlled substances, except for Group VI, and until January 1, 2005, for Group VI, any person ("transferor") may transfer to any other person ("transferee") any amount of the transferor's consumption allowances or production allowances, and effective January 1, 1995, for all class I controlled substances any person ("transferor") may transfer to any other person ("transferee") any amount of the transferor's Article 5 allowances. After January 1, 2002, any essential-use allowance holder (including those persons that hold essential-use allowances issued by a Party other than the United States) ("transferor") may transfer essential-use allowances for CFCs to a metered dose inhaler company solely for the manufacture of essential MDIs. After January 1, 2005, any critical use allowance holder ("transferor") may transfer critical use allowances to any other person ("transferee"). After January 1, 2005, any critical stock allowance holder ("transferor") may transfer critical stock allowances to any critical stock allowance holder or any methyl bromide producer, importer, distributor or third party applicator ("transferee").

(i) The transferor must submit to the Administrator a transfer claim setting forth the following:

(A) The identities and addresses of the transferor and the transferee;

(B) The name and telephone numbers of contact persons for the transferor and the transferee;

(C) The type of allowances being transferred, including the names of the controlled substances for which allowances are to be transferred;

(D) The group of controlled substances to which the allowances being transferred pertains;

(E) The amount of allowances being transferred;

(F) The control period(s) for which the allowances are being transferred;

(G) The amount of unexpended allowances of the type and for the control period being transferred that the transferor holds under authority of this subpart as of the date the claim is submitted to EPA; and

(H) The one percent offset applied to the unweighted amount traded will be deducted from the transferor's production or consumption allowance balance (except for trades from transformers and destroyers to producers or importers for the purpose of allowance reimbursement). In the case of transferring essential use allowances, the amount of one tenth of one percent of the amount traded will be deducted from the transferor's allowance balance. In the case of transferring critical use allowances, the amount of one tenth of one percent of the amount traded will be deducted from the transferor's critical use allowance balance.

(I) The transferor must include a signed document from the transferee identifying the CFC MDI products that will be produced using the essential-use allowances.

(ii) The Administrator will determine whether the records maintained by EPA, taking into account any previous transfers and any production, allowable imports and exports of controlled substances reported by the transferor, indicate that the transferor possesses, as of the date the transfer claim is processed, unexpended allowances sufficient to cover the transfer claim (*i.e.*, the amount to be transferred plus, in the case of transferors of essential use allowances and critical use allowances, one tenth of one percent of the transferred amount). Within three working days of receiving a complete transfer claim, the Administrator will take action to notify the transferor and transferee as follows:

(A) If EPA's records show that the transferor has sufficient unexpended allowances to cover the transfer claim, the Administrator will issue a notice indicating that EPA does not object to the transfer and will reduce the transferor's balance of unexpended allowances by the amount to be transferred plus, in the case of transfers of production or consumption allowances, one percent of that amount, or in the case of transfers of essential use allowances, one tenth of one percent of that amount. When EPA issues a no objection notice, the transferor and the transferee may proceed with the transfer. However, if EPA

ultimately finds that the transferor did not have sufficient unexpended allowances to cover the claim, the transferor and transferee will be held liable for any violations of the regulations of this subpart that occur as a result of, or in conjunction with, the improper transfer.

(B) If EPA's records show that the transferor has insufficient unexpended allowances to cover the transfer claim, or that the transferor has failed to respond to one or more Agency requests to supply information needed to make a determination, the Administrator will issue a notice disallowing the transfer. Within 10 working days after receipt of notification, either party may file a notice of appeal, with supporting reasons, with the Administrator. The Administrator may affirm or vacate the disallowance. If no appeal is taken by the tenth working day after notification, the disallowance shall be final on that day.

(iii) In the event that the Administrator does not respond to a transfer claim within the three working days specified in paragraph (a)(1)(ii) of this section the transferor and transferee may proceed with the transfer. EPA will reduce the transferor's balance of unexpended allowances by the amount to be transferred plus, in the case of transfers of production or consumption allowances, one percent of that amount, and in the case of essential use allowances and critical use allowances, one tenth of one percent of that amount. However if EPA ultimately finds that the transferor did not have sufficient unexpended allowances to cover the claim, the transferor and transferee will be held liable for any violations of the regulations of this subpart that occur as a result of, or in conjunction with, the improper transfer.

(2) Effective January 1, 1996, any person ("transferor") may transfer to an eligible person ("transferee") as defined in §82.9 any amount of the transferor's destruction and transformation credits. The transfer proceeds as follows:

(i) The transferor must submit to the Administrator a transfer claim setting forth the following:

(A) The identities and addresses of the transferor and the transferee;

(B) The name and telephone numbers of contact persons for the transferor and the transferee;

(C) The type of credits being transferred, including the names of the controlled substances for which credits are to be transferred;

(D) The group of controlled substances to which the credits being transferred pertains;

(E) The amount of destruction and transformation credits being transferred;

(F) The control period(s) for which the destruction and transformation credits are being transferred;

(G) The amount of unexpended destruction and transformation credits for the control period being transferred that the transferor holds under authority of this subpart as of the date the claim is submitted to EPA; and

(H) The amount of the one-percent offset applied to the unweighted amount traded that will be deducted from the transferor's balance.

(ii) The Administrator will determine whether the records maintained by EPA, taking into account any previous transfers and any production of controlled substances reported by the transferor, indicate that the transferor possesses, as of the date the transfer claim is processed, unexpended destruction and transformation credits sufficient to cover the transfer claim (i.e., the amount to be transferred plus one percent of that amount). Within three working days of receiving a complete transfer claim, the Administrator will take action to notify the transferor and transferee as follows:

(A) If EPA's records show that the transferor has sufficient unexpended destruction and transformation credits to cover the transfer claim, the Administrator will issue a notice indicating that EPA does not object to the transfer and will reduce the transferor's balance of unexpended or credits by the amount to be transferred plus one percent of that amount. When EPA issues a no objection notice, the transferor and the transferee may proceed with the transfer. However, if EPA ultimately finds that the transferor did not have sufficient unexpended credits to cover the claim, the transferor and transferee will be held liable for any violations of the regulations of this subpart that occur as a result of, or in conjunction with, the

improper transfer.

(B) If EPA's records show that the transferor has insufficient unexpended destruction and transformation credits to cover the transfer claim, or that the transferor has failed to respond to one or more Agency requests to supply information needed to make a determination, the Administrator will issue a notice disallowing the transfer. Within 10 working days after receipt of notification, either party may file a notice of appeal, with supporting reasons, with the Administrator. The Administrator may affirm or vacate the disallowance. If no appeal is taken by the tenth working day after notification, the disallowance shall be final on that day.

(iii) In the event that the Administrator does not respond to a transfer claim within the three working days specified in paragraph (a)(2)(ii) of this section, the transferor and transferee may proceed with the transfer. EPA will reduce the transferor's balance of unexpended destruction and transformation credits by the amount to be transferred plus one percent of that amount. However, if EPA ultimately finds that the transferor did not have sufficient unexpended credits to cover the claim, the transferor and transferee will be held liable for any violations of the regulations of this subpart that occur as a result of, or in conjunction with, the improper transfer.

(b) Inter-pollutant conversions.

(1) Until January 1, 1996, for all class I controlled substances, except Group VI, and until January 1, 2005 for Group VI, any person ("convertor") may convert consumption allowances or production allowances for one class I controlled substance to the same type of allowance for another class I controlled substance within the same Group as the first as listed in appendix A of this subpart, following the procedures described in paragraph (b)(4) of this section.

(2) Effective January 1, 1995, any person ("convertor") may convert Article 5 allowances for one class I controlled substance to the same type of allowance for another class I controlled substance within the same Group of controlled substances as the first as listed in appendix A of this subpart, following the procedures described in paragraph (b)(4) of this section.

(3) Effective January 1, 1996, any person ("convertor") may convert destruction and/or transformation credits for one class I controlled substance to the same type of credits for another class I controlled substance within the same Group of controlled substances as the first as listed in appendix A of this subpart, following the procedures in paragraph (b)(4) of this section.

(4) The convertor must submit to the Administrator a conversion claim.

(i) The conversion claim would include the following:

(A) The identity and address of the convertor;

(B) The name and telephone number of a contact person for the convertor;

(C) The type of allowances or credits being converted, including the names of the controlled substances for which allowances or credits are to be converted;

(D) The group of controlled substances to which the allowances or credits being converted pertains;

(E) The amount and type of allowances or credits to be converted;

(F) The amount of allowances or credits to be subtracted from the convertor's unexpended allowances or credits for the first controlled substance, to be equal to 101 percent of the amount of allowances or credits converted;

(G) The amount of allowances or credits to be added to the convertor's unexpended allowances or credits for the second controlled substance, to be equal to the amount of allowances or credits for the first controlled substance being converted multiplied by the quotient of the ozone depletion factor of the first controlled substance divided by the ozone depletion factor of the second controlled substance, as listed in appendix A to this subpart;

- (i) The identities and addresses of the transferor and the transferee; and
 - (ii) The name and telephone numbers of contact persons for the transferor and the transferee; and
 - (iii) The amount of each controlled substance (CFC-11, CFC-12, or CFC-114) being transferred; and
 - (iv) The specific metered dose inhaler products (i.e. the MDI drug product or active moiety) that the transferee plans to produce with the transferred CFCs; and
 - (v) The country(ies) where the CFC metered dose inhalers produced with the transferred essential-use CFCs will be sold if other than in the United States; and
 - (vi) Certification that the essential-use CFCs will be used in the production of essential MDIs. If the MDIs are to be sold in the United States, the certification must state that MDIs produced with the transferred essential-use CFCs are listed as essential at 21 CFR 2.125, and were approved by the Food and Drug Administration before December 31, 2000. If the MDIs produced with the essential-use CFCs are to be sold outside the United States, the transferee must certify that the metered dose inhalers produced with the essential-use CFCs are considered essential by the importing country.
- (3) The transferor must submit a letter stating that it concurs with the terms of the transfer as requested by the transferee.
- (4) Once the transfer claim is complete, and if EPA does not object to the transfer, then EPA will issue letters to the transferor and the transferee within 10 business days indicating that the transfer may proceed. EPA reserves the right to disallow a transfer if the transfer request is incomplete, or if it has reason to believe that the transferee plans use the essential-use CFCs in anything other than essential MDIs. If EPA objects to the transfer, within EPA will issue letters to the transferor and transferee stating the basis for disallowing the transfer. The burden of proof is placed on the transferee to retain sufficient records to prove that the transferred essential-use CFCs are used only for production of essential MDIs. If EPA ultimately finds that the transferee did not use the essential-use CFCs for production of essential MDIs then the transferee is in violation of this subpart.
- (e) Exchange of Critical Use Allowances for Critical Stock Allowances. (1) Critical use allowance holders may petition the Administrator to exchange a quantity of their unexpended critical use allowances for an equivalent amount of critical stock allowances. A person allocated critical stock allowances may not petition to exchange unexpended critical stock allowances for critical use allowances.

(2) [Reserved]

[60 FR 24986, May 10, 1995, as amended at 65 FR 70804, Nov. 28, 2000; 66 FR 1471, Jan. 8, 2001; 67 FR 6361, Feb. 11, 2002; 69 FR 77004, Dec. 23, 2004]

§ 82.13 Recordkeeping and reporting requirements for class I controlled substances.

- (a) Unless otherwise specified, the recordkeeping and reporting requirements set forth in this section take effect on January 1, 1995. For class I, Group VIII controlled substances, the recordkeeping and reporting requirements set forth in this section take effect on August 18, 2003. For class I, Group VI critical use methyl bromide, the recordkeeping and reporting requirements set forth in this section take effect January 1, 2005.
- (b) Reports and records required by this section may be used for purposes of compliance determinations. These requirements are not intended as a limitation on the use of other evidence admissible under the Federal Rules of Evidence. Failure to provide the reports, petitions and records required by this section, and to certify the accuracy of the information in the reports, petitions and records required by this section, will be considered a violation of this subpart. False statements made in reports, petitions and records will be considered violations of Section 113 of the Clean Air Act.
- (c) Unless otherwise specified, reports required by this section must be mailed to the Administrator within 45 days of the end of the applicable reporting period.

(d) Records and copies of reports required by this section must be retained for three years.

(e) In reports required by this section, quantities of controlled substances must be stated in terms of kilograms.

(f) Every person ("producer") who produces class I controlled substances during a control period must comply with the following recordkeeping and reporting requirements:

(1) Within 120 days of May 10, 1995, or within 120 days of the date that a producer first produces a class I controlled substance, whichever is later, and within 120 days of July 18, 2003 for class I, Group VIII controlled substances, every producer who has not already done so must submit to the Administrator a report describing:

(i) The method by which the producer in practice measures daily quantities of controlled substances produced;

(ii) Conversion factors by which the daily records as currently maintained can be converted into kilograms of controlled substances produced, including any constants or assumptions used in making those calculations (e.g., tank specifications, ambient temperature or pressure, density of the controlled substance);

(iii) Internal accounting procedures for determining plant-wide production;

(iv) The quantity of any fugitive losses accounted for in the production figures; and

(v) The estimated percent efficiency of the production process for the controlled substance. Within 60 days of any change in the measurement procedures or the information specified in the above report, the producer must submit a report specifying the revised data or procedures to the Administrator.

(2) Every producer of a class I controlled substance during a control period must maintain the following records:

(i) Dated records of the quantity of each controlled substance produced at each facility;

(ii) Dated records of the quantity of controlled substances produced for use in processes that result in their transformation or for use in processes that result in their destruction and quantity sold for use in processes that result in their transformation or for use in processes that result in their destruction;

(iii) Dated records of the quantity of controlled substances produced for an essential-use and quantity sold for use in an essential-use process;

(iv) Dated records of the quantity of controlled substances produced with expended destruction and/or transformation credits;

(v) Dated records of the quantity of controlled substances produced with Article 5 allowances;

(vi) Copies of invoices or receipts documenting sale of controlled substance for use in processes resulting in their transformation or for use in processes resulting in destruction;

(vii) Dated records of the quantity of each controlled substance used at each facility as feedstocks or destroyed in the manufacture of a controlled substance or in the manufacture of any other substance, and any controlled substance introduced into the production process of the same controlled substance at each facility;

(viii) Dated records identifying the quantity of each chemical not a controlled substance produced within each facility also producing one or more controlled substances;

(ix) Dated records of the quantity of raw materials and feedstock chemicals used at each facility for the production of controlled substances;

- (x) Dated records of the shipments of each controlled substance produced at each plant;
- (xi) The quantity of controlled substances, the date received, and names and addresses of the source of used materials containing controlled substances which are recycled or reclaimed at each plant;
- (xii) Records of the date, the controlled substance, and the estimated quantity of any spill or release of a controlled substance that equals or exceeds 100 pounds;
- (xiii) Internal Revenue Service Certificates in the case of transformation, or the destruction verification in the case of destruction (as in §82.13(k)), showing that the purchaser or recipient of a controlled substance, in the United States or in another country that is a Party, certifies the intent to either transform or destroy the controlled substance, or sell the controlled substance for transformation or destruction in cases when production and consumption allowances were not expended;
- (xiv) Written verifications that essential-use allowances were conveyed to the producer for the production of specified quantities of a specific controlled substance that will only be used for the named essential-use and not resold or used in any other manufacturing process.
- (xv) Written certifications that quantities of controlled substances, meeting the purity criteria in appendix G of this subpart, were purchased by distributors of laboratory supplies or by laboratory customers to be used only in essential laboratory and analytical uses as defined by appendix G, and not to be resold or used in manufacturing.
- (xvi) Written verifications from a U.S. purchaser that the controlled substance was exported to an Article 5 country in cases when Article 5 allowances were expended during production; and
- (xvii) For class I, Group VI controlled substances, dated records of the quantity of controlled substances produced for quarantine and preshipment applications and quantity sold for quarantine and preshipment applications;
- (xviii) Written certifications that quantities of class I, Group VI controlled substances produced solely for quarantine and preshipment applications were purchased by distributors or applicators to be used only for quarantine and preshipment applications in accordance with the definitions in this subpart; and
- (xix) Written verifications from a U.S. purchaser that class I, Group VI controlled substances produced solely for quarantine and preshipment applications, if exported, will be exported solely for quarantine and preshipment applications upon receipt of a certification in accordance with the definitions of this subpart and requirements in paragraph (h) of this section.
- (xx) For class I, Group VI controlled substances, dated records such as invoices and order forms, and a log of the quantity of controlled substances produced for critical use, specifying quantities dedicated for pre-plant use and quantities dedicated for post-harvest use, and the quantity sold for critical use, specifying quantities dedicated for pre-plant use and quantities dedicated for post-harvest use;
- (xxi) Written certifications that quantities of class I, Group VI controlled substances produced for critical use were purchased by distributors, applicators, or approved critical users to be used or sold only for critical use in accordance with the definitions and prohibitions in this subpart. Certifications must be maintained by the producer for a minimum of three years and;
- (xxii) For class I, Group VI controlled substances, dated records such as invoices and order forms, and a log of the quantity of controlled substances produced solely for export to satisfy critical uses authorized by the Parties for that control period, and the quantity sold solely for export to satisfy critical uses authorized by the Parties for that control period.
- (3) Reporting Requirements—Producers. For each quarter, except as specified below, each producer of a class I controlled substance must provide the Administrator with a report containing the following information:
- (i) The production by company in that quarter of each controlled substance, specifying the quantity of any controlled substance used in processing, resulting in its transformation by the producer;

- (ii) The amount of production for use in processes resulting in destruction of controlled substances by the producer;
- (iii) The levels of production (expended allowances and credits) for each controlled substance;
- (iv) The producer's total of expended and unexpended production allowances, consumption allowances, Article 5 allowances, critical use allowances (pre-plant), critical use allowances (post-harvest), critical stock allowances, and amount of essential-use allowances and destruction and transformation credits conferred at the end of that quarter;
- (v) The amount of controlled substance sold or transferred during the quarter to a person other than the producer for use in processes resulting in its transformation or eventual destruction;
- (vi) A list of the quantities and names of controlled substances exported, by the producer and or by other U.S. companies, to a Party to the Protocol that will be transformed or destroyed and therefore were not produced expending production or consumption allowances;
- (vii) For transformation in the United States or by a person of another Party, one copy of an IRS certification of intent to transform the same controlled substance for a particular transformer and a list of additional quantities shipped to that same transformer for the quarter;
- (viii) For destruction in the United States or by a person of another Party, one copy of a destruction verification (as under §82.13(k)) for a particular destroyer, destroying the same controlled substance, and a list of additional quantities shipped to that same destroyer for the quarter;
- (ix) A list of U.S. purchasers of controlled substances that exported to an Article 5 country in cases when Article 5 allowances were expended during production;
- (x) A list of the essential-use allowance holders, distributors of laboratory supplies and laboratory customers from whom orders were placed and the quantity of specific essential-use controlled substances requested and produced;
- (xi) The certifications from essential-use allowance holders stating that the controlled substances were purchased solely for specified essential uses and will not be resold or used in any other manufacturing process;
- (xii) In the case of laboratory essential-uses, certifications from distributors of laboratory supplies that controlled substances were purchased for sale to laboratory customers who certify that the substances will only be used for essential laboratory and analytical uses as defined by appendix G of this subpart, and will not be resold or used in manufacturing; or, if sales are made directly to laboratories, certification from laboratories that the controlled substances will only be used for essential laboratory and analytical uses (defined at appendix G of this subpart) and will not be resold or used in manufacturing.
- (xiii) The amount of class I, Group VI controlled substances sold or transferred during the quarter to a person other than the producer solely for quarantine and preshipment applications;
- (xiv) A list of the quantities of class I, Group VI controlled substances produced by the producer and exported by the producer and/or by other U.S. companies, to a Party to the Protocol that will be used solely for quarantine and preshipment applications and therefore were not produced expending production or consumption allowances; and
- (xv) For quarantine and preshipment applications of class I, Group VI controlled substances in the United States or by a person of another Party, one copy of a certification that the material will be used only for quarantine and preshipment applications in accordance with the definitions in this subpart from each recipient of the material and a list of additional quantities shipped to that same person for the quarter.
- (xvi) For critical uses of class I, Group VI controlled substances, producers shall report annually the amount of critical use methyl bromide owned by the reporting entity, specifying quantities dedicated for pre-plant use and quantities dedicated for post-harvest use, as well as quantities held by the reporting entity on behalf of another entity, specifying quantities dedicated for pre-plant use and quantities

dedicated for post-harvest use along with the name of the entity on whose behalf the material is held;
and

(xvii) A list of the quantities of class I, Group VI controlled substances produced by the producer and exported by the producer and/or by other U.S. companies in that control period, solely to satisfy the critical uses authorized by the Parties for that control period; and

(xviii) On an annual basis, the amount of methyl bromide produced or imported prior to the January 1, 2005, phaseout date owned by the reporting entity, as well as quantities held by the reporting entity on behalf of another entity, specifying the name of the entity on whose behalf the material is held.

(4) For any person who fails to maintain the records required by this paragraph, or to submit the report required by this paragraph, the Administrator may assume that the person has produced at full capacity during the period for which records were not kept, for purposes of determining whether the person has violated the prohibitions at §82.4.

(g) Importers of class I controlled substances during a control period must comply with record-keeping and reporting requirements specified in this paragraph (g).

(1) Recordkeeping—Importers. Any importer of a class I controlled substance (including used, recycled and reclaimed controlled substances) must maintain the following records:

(i) The quantity of each controlled substance imported, either alone or in mixtures, including the percentage of each mixture which consists of a controlled substance;

(ii) The quantity of those controlled substances imported that are used (including recycled or reclaimed) and the information provided with the petition as under §82.13(g)(2);

(iii) The quantity of controlled substances other than transshipments or used, recycled or reclaimed substances imported for use in processes resulting in their transformation or destruction and quantity sold for use in processes that result in their destruction or transformation;

(iv) The date on which the controlled substances were imported;

(v) The port of entry through which the controlled substances passed;

(vi) The country from which the imported controlled substances were imported;

(vii) The commodity code for the controlled substances shipped, which must be one of those listed in Appendix K to this subpart;

(viii) The importer number for the shipment;

(ix) A copy of the bill of lading for the import;

(x) The invoice for the import;

(xi) The quantity of imports of used, recycled or reclaimed class I controlled substances and class II controlled substances;

(xii) The U.S. Customs entry form;

(xiii) Dated records documenting the sale or transfer of controlled substances for use in processes resulting in transformation or destruction;

(xiv) Copies of IRS certifications that the controlled substance will be transformed or destruction verifications that it will be destroyed (as in §82.13(k));

(xv) Dated records of the quantity of controlled substances imported for an essential-use or imported with destruction and transformation credits; and

(xvi) Copies of certifications that imported controlled substances are being purchased for essential laboratory and analytical uses (defined at appendix G of this subpart) or being purchased for eventual sale to laboratories that certify that controlled substances are for essential laboratory and analytical uses (defined at appendix G of this subpart).

(xvii) For class I, Group VI controlled substances, dated records of the quantity of controlled substances imported for quarantine and preshipment applications and quantity sold for quarantine and preshipment applications;

(xviii) Written certifications that quantities of class I, Group VI controlled substances imported solely for quarantine and preshipment applications were purchased by distributors or applicators to be used only for quarantine and preshipment applications in accordance with the definitions in this subpart; and

(xix) Written verifications from a U.S. purchaser that class I, Group VI controlled substances imported solely for quarantine and preshipment applications, if exported, will be exported solely for quarantine and preshipment applications upon receipt of a certification in accordance with the definitions of this Subpart and requirements in paragraph (h) of this section.

(xx) For class I, Group VI controlled substances, dated records such as invoices and order forms, of the quantity of controlled substances imported for critical use, specifying quantities dedicated for pre-plant use and quantities dedicated for post-harvest use, and the quantity sold for critical use, specifying quantities dedicated for pre-plant use and quantities dedicated for post-harvest use, and;

(xxi) Written certifications that quantities of class I, Group VI controlled substances imported for critical use were purchased by distributors, applicators, or approved critical users to be used or sold only for critical use in accordance with the definitions and prohibitions in this subpart. Certifications must be maintained by an importer for a minimum of three years.

(2) Petitioning—Importers of Used, Recycled or Reclaimed Controlled Substances. For each individual shipment over 5 pounds of a used controlled substance as defined in §82.3, an importer must submit directly to the Administrator, at least 40 working days before the shipment is to leave the foreign port of export, the following information in a petition:

(i) Name and quantity in kilograms of the used controlled substance to be imported;

(ii) Name and address of the importer, the importer ID number, the contact person, and the phone and fax numbers;

(iii) Name, address, contact person, phone number and fax number of all previous source facilities from which the used controlled substance was recovered;

(iv) A detailed description of the previous use of the controlled substance at each source facility and a best estimate of when the specific controlled substance was put into the equipment at each source facility, and, when possible, documents indicating the date the material was put into the equipment;

(v) A list of the name, make and model number of the equipment from which the material was recovered at each source facility;

(vi) Name, address, contact person, phone number and fax number of the exporter and of all persons to whom the material was transferred or sold after it was recovered from the source facility;

(vii) The U.S. port of entry for the import, the expected date of shipment and the vessel transporting the chemical. If at the time of submitting a petition the importer does not know the U.S. port of entry, the expected date of shipment and the vessel transporting the chemical, and the importer receives a non-objection notice for the individual shipment in the petition, the importer is required to notify the Administrator of this information prior to the actual U.S. Customs entry of the individual shipment;

(viii) A description of the intended use of the used controlled substance, and, when possible, the name, address, contact person, phone number and fax number of the ultimate purchaser in the United States;

(ix) Name, address, contact person, phone number and fax number of the U.S. reclamation facility, where applicable;

(x) If someone at the source facility recovered the controlled substance from the equipment, the name and phone and fax numbers of that person;

(xi) If the imported controlled substance was reclaimed in a foreign Party, the name, address, contact person, phone number and fax number of any or all foreign reclamation facility(ies) responsible for reclaiming the cited shipment;

(xii) An export license from the appropriate government agency in the country of export and, if recovered in another country, the export license from the appropriate government agency in that country;

(xiii) If the imported used controlled substance is intended to be sold as a refrigerant in the U.S., the name and address of the U.S. reclaimer who will bring the material to the standard required under section 608 (§82.152(g)) of the CAA, if not already reclaimed to those specifications; and

(xiv) A certification of accuracy of the information submitted in the petition.

(3) Starting on the first working day following receipt by the Administrator of a petition to import a used class I controlled substance, the Administrator will initiate a review of the information submitted under paragraph (g)(2) of this section and take action within 40 working days to issue either an objection-notice or a non-objection notice for the individual shipment to the person who submitted the petition to import the used class I controlled substance.

(i) For the following reasons, the Administrator may issue an objection notice to a petition:

(A) If the Administrator determines that the information is insufficient, that is, if the petition lacks or appears to lack any of the information required under §82.13(g)(2);

(B) If the Administrator determines that any portion of the petition contains false or misleading information, or the Administrator has information from other U.S. or foreign government agencies indicating that the petition contains false or misleading information;

(C) If the importer wishes to import a used class I controlled substance from a country which is, for that particular controlled substance, out of compliance regarding its phaseout obligations under the Protocol or the transaction in the petition is contrary to other provisions in the Vienna Convention or the Montreal Protocol;

(D) If the appropriate government agency in the exporting country has not agreed to issue an export license for the cited individual shipment of used controlled substance;

(E) If allowing the import of the used class I controlled substance would run counter to government restrictions from either the country of recovery or export regarding controlled ozone-depleting substances;

(F) If reclamation capacity is installed or is being installed for that specific controlled substance in the country of recovery or country of export and the capacity is funded in full or in part through the Multilateral Fund.

(ii) Within ten (10) working days after receipt of the objection notice, the importer may re-petition the Administrator, only if the Administrator indicated "insufficient information" as the basis for the objection notice. If no appeal is taken by the tenth working day after the date on the objection notice, the objection shall become final. Only one appeal of re-petition will be accepted for any petition received by EPA.

(iii) Any information contained in the re-petition which is inconsistent with the original petition must be identified and a description of the reason for the inconsistency must accompany the re-petition.

(iv) In cases where the Administrator does not object to the petition based on the criteria listed in paragraph (g)(3)(i) of this section, the Administrator will issue a non-objection notice.

(v) To pass the approved used class I controlled substances through U.S. Customs, the petition and the non-objection notice issued by EPA must accompany the shipment through U.S. Customs.

(vi) If for some reason, following EPA's issuance of a non-objection notice, new information is brought to EPA's attention which shows that the non-objection notice was issued based on false information, then EPA has the right to:

(A) Revoke the non-objection notice;

(B) Pursue all means to ensure that the controlled substance is not imported into the United States; and

(C) Take appropriate enforcement actions.

(vii) Once the Administrator issues a non-objection notice, the person receiving the non-objection notice is required to import the individual shipment of used class I controlled substance within the same control period as the date stamped on the non-objection notice.

(viii) A person receiving a non-objection notice from the Administrator for a petition to import used class I controlled substances must maintain the following records:

(A) a copy of the petition;

(B) the EPA non-objection notice;

(C) the bill of lading for the import; and

(D) U.S. Customs entry documents for the import that must include one of the commodity codes from Appendix K to this subpart.

(4) Reporting Requirements—Importers. For each quarter, except as specified below, every importer of a class I controlled substance (including importers of used, recycled or reclaimed controlled substances) must submit to the Administrator a report containing the following information:

(i) Summaries of the records required in paragraphs (g)(1) (i) through (xvi) of this section for the previous quarter;

(ii) The total quantity imported in kilograms of each controlled substance for that quarter;

(iii) The quantity of those controlled substances imported that are used controlled substances.

(iv) The levels of import (expended consumption allowances before January 1, 1996) of controlled substances for that quarter and totaled by chemical for the control-period-to-date;

(vii) The importer's total sum of expended and unexpended consumption allowances by chemical as of the end of that quarter and the total sum of expended and unexpended critical use allowances (pre-plant) and unexpended critical use allowances (post-harvest) and critical stock allowances;

(viii) The amount of controlled substances imported for use in processes resulting in their transformation or destruction;

(ix) The amount of controlled substances sold or transferred during the quarter to each person for use in processes resulting in their transformation or eventual destruction;

(x) The amount of controlled substances sold or transferred during the quarter to each person for an essential use;

- (xi) The amount of controlled substances imported with destruction and transformation credits;
- (xii) Internal Revenue Service Certificates showing that the purchaser or recipient of imported controlled substances intends to transform those substances or destruction verifications (as in §82.13(k)) showing that purchaser or recipient intends to destroy the controlled substances; and
- (xiii) The certifications from essential-use allowance holders stating that the controlled substances were purchased solely for specified essential-uses and will not be resold or used in manufacturing; and the certifications from distributors of laboratory supplies that the controlled substances were purchased solely for eventual sale to laboratories that certify the controlled substances are for essential laboratory and analytical uses (defined at appendix G of this subpart), or if sales are made directly to laboratories, certifications from laboratories that the controlled substances will only be used for essential laboratory and analytical uses (defined at appendix G of this subpart) and will not be resold or used in manufacturing.
- (xiv) In the case of laboratory essential uses, a certification from distributors of laboratory supplies that controlled substances were purchased for sale to laboratory customers who certify that the substances will only be used for laboratory applications and will not be resold or used in manufacturing; and
- (xv) The amount of class I, Group VI controlled substance sold or transferred during the quarter to a person other than the importer solely for quarantine and preshipment applications;
- (xvi) A list of the quantities of class I, Group VI controlled substances exported by the importer and or by other U.S. companies, to a Party to the Protocol that will be used solely for quarantine and preshipment applications and therefore were not imported expending consumption allowances; and
- (xvii) For quarantine and preshipment applications of class I, Group VI controlled substances in the United States or by a person of another Party, one copy of a certification that the material will be used only for quarantine and preshipment applications in accordance with the definitions in this subpart from each recipient of the material and a list of additional quantities shipped to that same person for the quarter.
- (xviii) For critical uses of class I, Group VI controlled substances, importers shall report annually the amount of critical use methyl bromide owned by the reporting entity, specifying quantities dedicated for pre-plant use and quantities dedicated for post-harvest use, as well as quantities held by the reporting entity on behalf of another entity, specifying quantities dedicated for pre-plant use and quantities dedicated for post-harvest use along with the name of the entity on whose behalf the material is held.
- (xix) Importers shall report annually the amount of methyl bromide produced or imported prior to the January 1, 2005, phaseout date owned by the reporting entity, as well as quantities held by the reporting entity on behalf of another entity, specifying the name of the entity on whose behalf the material is held.
- (h) *Reporting Requirements—Exporters.* (1) For any exports of class I controlled substances (except Group VI) not reported under §82.10 of this subpart (additional consumption allowances), or under paragraph (f)(3) of this section (reporting for producers of controlled substances), the exporter who exported a class I controlled substance (except Group VI) must submit to the Administrator the following information within 45 days after the end of the control period in which the unreported exports left the United States:
- (i) The names and addresses of the exporter and the recipient of the exports;
- (ii) The exporter's Employee Identification Number;
- (iii) The type and quantity of each controlled substance exported and what percentage, if any, of the controlled substance is used, recycled or reclaimed;
- (iv) The date on which, and the port from which, the controlled substances were exported from the United States or its territories;
- (v) The country to which the controlled substances were exported;

(vi) The amount exported to each Article 5 country;

(vii) The commodity code of the controlled substance shipped; and

(viii) The invoice or sales agreement containing language similar to the Internal Revenue Service Certificate that the purchaser or recipient of imported controlled substances intends to transform those substances, or destruction verifications (as in paragraph(k) of this section) showing that the purchaser or recipient intends to destroy the controlled substances.

(2) For any exports of class I, Group VI controlled substances not reported under §82.10 of this subpart (additional consumption allowances), or under paragraph (f)(3) of this section (reporting for producers of controlled substances), the exporter who exported a class I, Group VI controlled substance must submit to the Administrator the following information within 45 days after the end of each quarter in which the unreported exports left the United States:

(i) The names and addresses of the exporter and the recipient of the exports;

(ii) The exporter's Employee Identification Number;

(iii) The type and quantity of each controlled substance exported and what percentage, if any, of the controlled substance is used, recycled or reclaimed;

(iv) The date on which, and the port from which, the controlled substances were exported from the United States or its territories;

(v) The country to which the controlled substances were exported;

(vi) The amount exported to each Article 5 country;

(vii) The commodity code of the controlled substance shipped; and

(viii) The invoice or sales agreement containing language similar to the Internal Revenue Service Certificate that the purchaser or recipient of imported controlled substances intends to transform those substances, the destruction verifications (as in paragraph (k) of this section) showing that the purchaser or recipient intends to destroy the controlled substances, or the certification that the purchaser or recipient and the eventual applicator will only use the material for quarantine and preshipment applications in accordance with the definitions in this subpart.

(i) Every person who has requested additional production allowances under §82.9(e) of this subpart or destruction and transformation credits under §82.9(f) of this subpart or consumption allowances under §82.10(b) of this subpart or who transforms or destroys class I controlled substances not produced or imported by that person must maintain the following:

(1) Dated records of the quantity and level of each controlled substance transformed or destroyed;

(2) Copies of the invoices or receipts documenting the sale or transfer of the controlled substance to the person;

(3) In the case where those controlled substances are transformed, dated records of the names, commercial use, and quantities of the resulting chemical(s);

(4) In the case where those controlled substances are transformed, dated records of shipments to purchasers of the resulting chemical(s);

(5) Dated records of all shipments of controlled substances received by the person, and the identity of the producer or importer of the controlled substances;

(6) Dated records of inventories of controlled substances at each plant on the first day of each quarter; and

(7) A copy of the person's IRS certification of intent to transform or the purchaser's or recipient's destruction verification of intent to destroy (as under §82.13(k)), in the case where substances were purchased or transferred for transformation or destruction purposes.

(j) Persons who destroy class I controlled substances shall, following promulgation of this rule, provide EPA with a one-time report stating the destruction unit's destruction efficiency and the methods used to record the volume destroyed and those used to determine destruction efficiency and the name of other relevant federal or state regulations that may apply to the destruction process. Any changes to the unit's destruction efficiency or methods used to record volume destroyed and to determine destruction efficiency must be reflected in a revision to this report to be submitted to EPA within 60 days of the change.

(k) Persons who purchase or receive and subsequently destroy controlled class I substances that were originally produced without expending allowances shall provide the producer or importer from whom they purchased or received the controlled substances with a verification that controlled substances will be used in processes that result in their destruction.

(1) The destruction verification shall include the following:

(i) Identity and address of the person intending to destroy controlled substances;

(ii) Indication of whether those controlled substances will be completely destroyed, as defined in §82.3 of this rule, or less than completely destroyed, in which case the destruction efficiency at which such substances will be destroyed must be included;

(iii) Period of time over which the person intends to destroy controlled substances; and

(iv) Signature of the verifying person.

(2) If, at any time, any aspects of this verification change, the person must submit a revised verification reflecting such changes to the producer from whom that person purchases controlled substances intended for destruction.

(l) Persons who purchase class I controlled substances and who subsequently transform such controlled substances shall provide the producer or importer with the IRS certification that the controlled substances are to be used in processes resulting in their transformation.

(m) Any person who transforms or destroys class I controlled substances who has submitted an IRS certificate of intent to transform or a destruction verification (as under paragraph (k) of this section) to the producer or importer of the controlled substance, must report the names and quantities of class I controlled substances transformed and destroyed for each control period within 45 days of the end of such control period.

(n) Persons who import or export used controlled substances (including recycled or reclaimed) must label their bill of lading or invoice indicating that the controlled substance is used, recycled or reclaimed.

(o) Persons who import heels of controlled substances must label their bill of lading or invoice indicating that the controlled substance in the container is a heel.

(p) Every person who brings back a container with a heel to the United States, as defined in §82.3, must report quarterly the amount brought into the United States certifying that the residual amount in each shipment is less than 10 percent of the volume of the container and will either:

(1) Remain in the container and be included in a future shipment;

(2) Be recovered and transformed;

(3) Be recovered and destroyed; or

(4) Be recovered for a non-emissive use.

(q) Every person who brings a container with a heel into the United States must report on the final disposition of each shipment within 45 days of the end of the control period.

(r) Every person who transships a controlled substance must maintain records that indicate that the controlled substance shipment originated in a foreign country destined for another foreign country, and does not enter interstate commerce with the United States.

(s) Any person allocated essential-use allowances who submits an order to a producer or importer for a controlled substance must report the quarterly quantity received from each producer or importer.

(t) Any distributor of laboratory supplies receiving controlled substances under the global laboratory essential-use exemption for sale to laboratory customers must report quarterly the quantity received of each controlled substance from each producer or importer.

(u) Holders of Essential-Use Allowances—Reporting.

(1) Within 30 days of the end of every quarter, any person allocated essential-use allowances must submit to the Administrator a report containing the quantity of each controlled substance, in kilograms, purchased and received from each producer and each importer during that quarter as well as from which country the controlled substance was imported.

(2) Any person allocated essential-use allowances must submit to the Administrator a report containing the following information within 30 days of the end of the control period, and, if possible, within 20 days of the end of the control period:

(i) The gross quantity of each controlled substance, in kilograms, that was used for the essential use during the control period; and

(ii) The quantity of each controlled substance, in kilograms, contained in exported products during the control period; and

(iii) The quantity of each controlled substance, in kilograms, that was destroyed or recycled during the control period; and

(iv) The quantity of each controlled substance, in kilograms, held in inventory as of the last day of the control period, that was acquired with essential use allowances in all control periods (*i.e.* quantity on hand at the end of the year); and

(v) The quantity of each controlled substance, in kilograms, in a stockpile that is owned by the company or is being held on behalf of the company under contract, and was produced or imported through the use of production allowances and consumption allowances prior to the phaseout (*i.e.* class I ODSs produced before their phaseout dates); and

(vi) For essential use allowances for metered-dose inhalers only, the allowance holder must report the total number of marketable units of each specific metered-dose inhaler product manufactured in the control period.

(v) Any distributor of laboratory supplies who purchased controlled substances under the global laboratory essential-use exemption must submit quarterly (except distributors following procedures in §82.4(z)) the quantity of each controlled substance purchased by each laboratory customer whose certification was previously provided to the distributor pursuant to paragraph (y) of this section.

(w) A laboratory customer purchasing a controlled substance under the global laboratory essential-use exemption must provide the producer, importer or distributor with a one-time-per-year certification for each controlled substance that the substance will only be used for essential laboratory and analytical uses (defined at appendix G of this subpart) and not be resold or used in manufacturing. The certification must also include:

(1) The identity and address of the laboratory customer;

(2) The name and phone number of a contact person for the laboratory customer;

(3) The name and quantity of each controlled substance purchased, and the estimated percent of the controlled substance that will be used for each listed type of laboratory application.

(x) Any distributor of laboratory supplies, who purchased class I controlled substances under the global laboratory essential-use exemption, and who only sells the class I controlled substances as reference standards for calibrating laboratory analytical equipment, may write a letter to the Administrator requesting permission to submit the reports required under paragraph (x) of this section annually rather than quarterly. The Administrator will review the request and issue a notification of permission to file annual reports if, in the Administrator's judgment, the distributor meets the requirements of this paragraph. Upon receipt of a notification of extension from the Administrator, the distributor must submit annually the quantity of each controlled substance purchased by each laboratory customer whose certification was previously provided to the distributor pursuant to paragraph (y) of this section.

(y) Every distributor of methyl bromide (class I, Group VI controlled substances) who purchases or receives a quantity produced or imported solely for quarantine or preshipment applications under the exemptions in this subpart must comply with recordkeeping and reporting requirements specified in this paragraph (aa) of this section.

(1) Every distributor of methyl bromide must certify to the producer or importer that quantities received that were produced or imported solely for quarantine and preshipment applications under the exemptions in this subpart will be used only for quarantine applications or preshipment applications in accordance with the definitions in this subpart.

(2) Every distributor of a quantity of methyl bromide that was produced or imported solely for quarantine or preshipment applications under the exemptions in this subpart must receive from an applicator a certification of the quantity of class I, Group VI controlled substances ordered, prior to delivery of the quantity, stating that the quantity will be used solely for quarantine or preshipment applications in accordance with definitions in this subpart.

(3) Every distributor of methyl bromide who receives a certification from an applicator that the quantity ordered and delivered will be used solely for quarantine and preshipment applications in accordance with definitions in this subpart must maintain the certifications as records for 3 years.

(4) Every distributor of methyl bromide who receives a certification from an applicator that the quantity ordered and delivered will be used solely for quarantine and preshipment applications in accordance with definitions in this subpart must report to the Administrator within 45 days after the end of each quarter, the total quantity delivered for which certifications were received that stated the class I, Group VI controlled substance would be used solely for quarantine and preshipment applications in accordance with definitions in this Subpart.

(z) Every applicator of class I, Group VI controlled substances who purchases or receives a quantity produced or imported solely for quarantine and preshipment applications under the exemptions in this subpart must comply with recordkeeping and reporting requirements specified in this paragraph (bb) of this section.

(1) Recordkeeping—Applicators. Every applicator of class I, Group VI controlled substances produced or imported solely for quarantine and preshipment applications under the exemptions of this subpart must maintain, for every application, a document from the commodity owner, shipper or their agent requesting the use of class I, Group VI controlled substances citing the regulatory requirement that justifies its use in accordance with definitions in this subpart. These documents shall be retained for 3 years.

(2) Reporting—Applicators. Every applicator of class I, Group VI controlled substances who purchases or receives a quantity of class I, Group VI controlled substance that was produced or imported solely for quarantine and preshipment applications under the exemptions in this subpart shall provide the distributor of the methyl bromide, prior to shipment of the class I, Group VI controlled substance, with a certification that the quantity of controlled substances will be used only for quarantine and preshipment applications as defined in this subpart.

(aa) Every commodity owner, shipper or their agent requesting an applicator to use a quantity of class I, Group VI controlled substance that was produced or imported solely for quarantine and preshipment applications under the exemptions of this subpart must maintain a record for 3 years, for each request, certifying knowledge of the requirements associated with the exemption for quarantine and preshipment applications in this subpart and citing the regulatory requirement that justifies the use of the class I, Group VI controlled substance in accordance with definitions in this subpart. The record must include the following statement: "I certify knowledge of the requirements associated with the exempted quarantine and preshipment applications published in 40 CFR part 82, including the requirement that this letter cite the treatments or official controls for quarantine applications or the official requirements for preshipment requirements."

(bb) Every distributor of methyl bromide (class I, Group VI controlled substances) who purchases or receives a quantity of critical use methyl bromide must comply with recordkeeping and reporting requirements specified in this paragraph (bb).

(1) Recordkeeping—Every distributor of critical use methyl bromide must certify to the producer or importer or other entity from which they are acquiring quantities of critical use methyl bromide that such quantities received will be sold or used only for approved critical use(s) in accordance with the definitions and prohibitions in this subpart.

(i) Every distributor of a quantity of critical use methyl bromide must receive from an applicator, or any other entity to whom they sell critical use methyl bromide, a certification of the quantity of critical use methyl bromide ordered, prior to delivery of the quantity, stating that the quantity will be sold or used only for approved critical uses in accordance with definitions and prohibitions in this subpart.

(ii) Every distributor of methyl bromide who receives a certification from an applicator or any other entity to which they sell critical use methyl bromide must maintain the certifications as records for 3 years.

(iii) Every distributor of a quantity of critical use methyl bromide must maintain invoice and order records related to the sale of such material for 3 years.

(2) Reporting—Every distributor of critical use methyl bromide must report to the Administrator annually, the following items:

(i) For critical uses of class I, Group VI controlled substances, an annual list of the amount of critical use methyl bromide bought;

(ii) For critical uses of class I, Group VI controlled substances, an annual list of the amount of critical use methyl bromide sold for each specified critical use in Appendix L of this subpart;

(iii) For critical uses of class I, Group VI controlled substances, report the amount of critical use methyl bromide owned by the reporting entity, specifying quantities dedicated for pre-plant use and quantities dedicated for post-harvest use, as well as quantities held by the reporting entity on behalf of another entity, specifying quantities dedicated for pre-plant use and quantities dedicated for post-harvest use, along with the name of the entity on whose behalf the material is held;

(iv) The number of unexpended and expended critical stock allowances;

(v) The amount of methyl bromide produced or imported prior to the January 1, 2005, phaseout date owned by the reporting entity, as well as quantities held by the reporting entity on behalf of another entity, specifying the name of the entity on whose behalf the material is held.

(cc) Every third party applicator of methyl bromide (class I, Group VI controlled substances) that purchases or receives critical use methyl bromide must comply with recordkeeping and reporting requirements specified in this paragraph (cc).

(1) Recordkeeping—Every third party applicator of critical use methyl bromide must certify to the producer or importer or other entity from which they are acquiring quantities of critical use methyl bromide that such quantities received will be sold or used only for approved critical use(s) in accordance with the definitions and prohibitions in this subpart.

(i) Every third party applicator of a quantity of critical use methyl bromide must receive from any entity to whom they sell critical use methyl bromide, a certification of the quantity of critical use methyl bromide ordered, prior to delivery of the quantity, stating that the quantity will be sold or used only for approved critical uses in accordance with definitions and prohibitions in this subpart.

(ii) Every third party applicator of methyl bromide who receives a certification from an entity to which they sell critical use methyl bromide must maintain the certifications as records for 3 years.

(iii) Every third party applicator of a quantity of critical use methyl bromide must maintain invoice and order records related to the sale of such material for 3 years.

(2) Reporting—Every third party applicator of critical use methyl bromide must report to the Administrator annually, the following items:

(i) For critical uses of class I, Group VI controlled substances, an annual list of the amount of critical use methyl bromide bought;

(ii) For critical uses of class I, Group VI controlled substances, an annual list of the amount of critical use methyl bromide sold for each specified critical use in Appendix L of this subpart;

(iii) For critical uses of class I, Group VI controlled substances, report annually the amount of critical use methyl bromide owned by the reporting entity, specifying quantities dedicated for pre-plant use and quantities dedicated for post-harvest use, as well as quantities held by the reporting entity on behalf of another entity, specifying quantities dedicated for pre-plant use and quantities dedicated for post-harvest use, along with the name of the entity on whose behalf the material is held;

(iv) The number of unexpended and expended critical stock allowances;

(v) The amount of methyl bromide produced or imported prior to the January 1, 2005 phaseout date owned by the reporting entity, as well as quantities held by the reporting entity on behalf of another entity, specifying the name of the entity on whose behalf the material is held.

(dd) Every approved critical user purchasing an amount of critical use methyl bromide or purchasing fumigation services with critical use methyl bromide must, for each request, identify the use as a critical use and certify being an approved critical user. The approved critical user certification will state, in part: "I certify, under penalty of law, I am an approved critical user and I will use this quantity of methyl bromide for an approved critical use. My action conforms to the requirements associated with the critical use exemption published in 40 CFR part 82. I am aware that any agricultural commodity within a treatment chamber, facility or field I fumigate with critical use methyl bromide cannot subsequently or concurrently be fumigated with non-critical use methyl bromide during the same control period, excepting a QPS treatment or a treatment for a different use (e.g. , a different crop or commodity). I will not use this quantity of methyl bromide for a treatment chamber, facility, or field that I previously fumigated with non-critical use methyl bromide during the same control period, excepting a QPS treatment or a treatment for a different use (e.g. , a different crop or commodity), unless a local township limit now prevents me from using methyl bromide alternatives or I have now become an approved critical user as a result of rulemaking." The certification will also identify the type of critical use methyl bromide purchased, the location of the treatment, the crop or commodity treated, the quantity of critical use methyl bromide purchased, and the acreage/square footage treated, and will be signed and dated by the approved critical user.

[60 FR 24986, May 10, 1995, as amended at 61 FR 3318, Jan. 31, 1996; 61 FR 29486, June 11, 1996; 63 FR 41646, Aug. 4, 1998; 66 FR 37767, July 19, 2001; 67 FR 6362, Feb. 11, 2002; 67 FR 79872, Dec. 31, 2002; 67 FR 252, Jan. 2, 2003; 68 FR 2848, Jan. 21, 2003; 68 FR 42891, July 18, 2003; 69 FR 77005, Dec. 23, 2004; 70 FR 73614, Dec. 13, 2005; 71 FR 6006, Feb. 6, 2006; 71 FR 41171, July 20, 2006]

§ 82.15 Prohibitions for class II controlled substances.

(a) *Production.* (1) Effective January 21, 2003, no person may produce class II controlled substances for which EPA has apportioned baseline production and consumption allowances, in excess of the quantity of unexpended production allowances, unexpended Article 5 allowances, unexpended export production

allowances, or conferred unexpended HCFC-141b exemption allowances held by that person for that substance under the authority of this subpart at that time in that control period, unless the substances are transformed or destroyed domestically or by a person of another Party, or unless they are produced using an exemption granted in paragraph (f) of this section. Every kilogram of excess production constitutes a separate violation of this subpart.

(2) Effective January 21, 2003, no person may use production allowances to produce a quantity of class II controlled substance unless that person holds under the authority of this subpart at the same time consumption allowances sufficient to cover that quantity of class II controlled substances. No person may use consumption allowances to produce a quantity of class II controlled substances unless the person holds under authority of this subpart at the same time production allowances sufficient to cover that quantity of class II controlled substances.

(b) *Import.* (1) Effective January 21, 2003, no person may import class II controlled substances (other than transshipments, heels or used class II controlled substances) for which EPA has apportioned baseline production and consumption allowances, in excess of the quantity of unexpended consumption allowances, or conferred unexpended HCFC-141b exemption allowances held by that person under the authority of this subpart at that time in that control period, unless the substances are for use in a process resulting in their transformation or their destruction, or unless they are produced using an exemption granted in paragraph (f) of this section. Every kilogram of excess import constitutes a separate violation of this subpart.

(2) Effective January 21, 2003, no person may import, at any time in any control period, a used class II controlled substance for which EPA has apportioned baseline production and consumption allowances, without having submitted a petition to the Administrator and received a non-objection notice in accordance with §82.24(c)(3) and (4). A person issued a non-objection notice for the import of an individual shipment of used class II controlled substances may not transfer or confer the right to import, and may not import any more than the exact quantity (in kilograms) of the used class II controlled substance stated in the non-objection notice. Every kilogram of import of used class II controlled substance in excess of the quantity stated in the non-objection notice issued by the Administrator in accordance with §82.24(c)(3) and (4) constitutes a separate violation of this subpart.

(c) Production with Article 5 allowances. No person may introduce into U.S. interstate commerce any class II controlled substance produced with Article 5 allowances. Every kilogram of a class II controlled substance that was produced with Article 5 allowances that is introduced into U.S. interstate commerce constitutes a separate violation under this subpart. No person may export any class II controlled substance produced with Article 5 allowances to a non-Article 5 Party to the Protocol as listed in Appendix E to this subpart. Every kilogram of a class II controlled substance that was produced with Article 5 allowances that is exported to a non-Article 5 Party to the Protocol as listed in Appendix E of this subpart constitutes a separate violation under this subpart.

(d) Production with export production allowances. No person may introduce into U.S. interstate commerce any class II controlled substance produced with export production allowances. Every kilogram of a class II controlled substance that was produced with export production allowances that is introduced into U.S. interstate commerce constitutes a separate violation under this subpart.

(e) Trade with Parties. No person may import or export any quantity of a class II controlled substance listed in Appendix A to this subpart, from or to any foreign state that is not either:

(1) A Party to the Montreal Protocol that has ratified the Beijing Amendments. Parties that have ratified the Beijing Amendments as of June 17, 2004 are listed in Annex 1 to Appendix C of this subpart. Or,

(2) A Party to the Montreal Protocol that has provided notice, certification, and data in accordance with Decision XV/3(c)(i), (ii), and (iii) respectively, to the Ozone Secretariat. A list of Parties that have provided notice, certification and data in accordance with Decision XV/3(c)(i), (ii), and (iii) respectively, by June 17, 2004 can be found in Annex 3 to Appendix C of this subpart and on a list maintained by the Ozone Secretariat. Or,

(3) A Party to the Montreal Protocol operating under Article 5(1) to the Montreal Protocol. A list of Parties operating under Article 5(1) to the Montreal Protocol as of June 17, 2004 can be found in Annex 4 to Appendix C of this subpart.

(f) Exemptions. (1) Medical Devices [Reserved]

[68 FR 2848, Jan. 21, 2003, as amended at 69 FR 34031, June 17, 2004; 71 FR 41171, July 20, 2006]

§ 82.16 Phaseout schedule of class II controlled substances.

(a) In each control period as indicated in the following table, each person is granted the specified percentage of baseline production allowances and baseline consumption allowances for the specified class II controlled substances apportioned under §§82.17 and 82.19:

Control period	Percent of HCFC-141b	Percent of HCFC-22 & HCFC-142b
2003	0	100
2004	0	100
2005	0	100
2006	0	100
2007	0	100
2008	0	100
2009	0	100

(b) Effective January 1, 2003, no person may produce HCFC-141b except for use in a process resulting in its transformation or its destruction, for export under §82.18(a) using unexpended Article 5 allowances, for export under §82.18(b) using unexpended export production allowances, for HCFC-141b exemption needs using unexpended HCFC-141b exemption allowances, or for exemptions permitted in §82.15(f). Effective January 1, 2003, no person may import HCFC-141b (other than transshipments, heels or used class II controlled substances) in excess of the quantity of unexpended HCFC-141b exemption allowances held by that person except for use in a process resulting in its transformation or its destruction, or for exemptions permitted in §82.15(f).

(c) Effective January 1, 2010, no person may produce HCFC-22 or HCFC-142b for any purpose other than for use in a process resulting in their transformation or their destruction, for use in equipment manufactured before January 1, 2010, for export under §82.18(a) using unexpended Article 5 allowances, or for export under §82.18(b) using unexpended export production allowances, or for exemptions permitted in §82.15(f). Effective January 1, 2010, no person may import HCFC-22 or HCFC-142b (other than transshipments, heels or used class II controlled substances) for any purpose other than for use in a process resulting in their transformation or their destruction, for exemptions permitted in §82.15(f), or for use in equipment manufactured prior to January 1, 2010.

(d) Effective January 1, 2015, no person may produce class II controlled substances not previously controlled, for any purpose other than for use in a process resulting in their transformation or their destruction, for use as a refrigerant in equipment manufactured before January 1, 2020, for export under §82.18(a) using unexpended Article 5 allowances, or for export under §82.18(b) using unexpended export production allowances, or for exemptions permitted in §82.15(f). Effective January 1, 2015, no person may import class II controlled substances not subject to the requirements of paragraph (b) or (c) of this section (other than transshipments, heels or used class II controlled substances) for any purpose other than for use in a process resulting in their transformation or their destruction, for exemptions permitted in §82.15(f), or for use as a refrigerant in equipment manufactured prior to January 1, 2020.

(e) Effective January 1, 2020, no person may produce HCFC-22 or HCFC-142b for any purpose other than for use in a process resulting in their transformation or their destruction, for export under §82.18(a) using unexpended Article 5 allowances, or for export under §82.18(b) using unexpended export production allowances, or for exemptions permitted in §82.15(f). Effective January 1, 2020, no person may import HCFC-22 or HCFC-142b for any purpose other than for use in a process resulting in their transformation or their destruction, or for exemptions permitted in §82.15(f).

(f) Effective January 1, 2030, no person may produce class II controlled substances, for any purpose other than for use in a process resulting in their transformation or their destruction, for export under §82.18(a) using unexpended Article 5 allowances, or for exemptions permitted in §82.15(f). Effective

January 1, 2030, no person may import class II controlled substances for any purpose other than for use in a process resulting in their transformation or their destruction, or for exemptions permitted in §82.15 (f).

(g) Effective January 1, 2040, no person may produce class II controlled substances for any purpose other than for use in a process resulting in their transformation or their destruction, or for exemptions permitted in §82.15(f).

(h) Petition for HCFC-141b exemption allowances.

(1) Effective January 21, 2003, a formulator of HCFC-141b, an agency, department, or instrumentality of the U.S., or a non-governmental space vehicle entity, may petition EPA for HCFC-141b exemption allowances for the production or import of HCFC-141b after the phaseout date, in accordance with this section. Except as provided in paragraphs (h)(4) and (7) of this section, a petitioner must submit the following information to the Director of EPA's Office of Atmospheric Programs no later than April 21, 2003, for the 2003 control period; and, for any subsequent control period, no later than October 31st of the year preceding the control period for which the HCFC-141b exemption allowances are requested:

(i) Name and address of the HCFC-141b formulator, U.S. government entity or non-governmental space vehicle entity;

(ii) Name of contact person, phone number, fax number and e-mail address;

(iii) Quantity (in kilograms) of HCFC-141b needed for each relevant calendar year, supported by documentation about past use for at least the previous three years;

(iv) Quantities of HCFC-141b, if any, contained in systems that were sold to other systems houses for at least the previous three years;

(v) Description of the markets and applications served by the use of HCFC-141b or systems based on HCFC-141b;

(vi) Technical description of processes in which HCFC-141b is being used;

(vii) Technical description of the specific conditions under which the product will be applied;

(viii) Technical description of why alternatives and substitutes are not sufficient to eliminate the use of HCFC-141b;

(ix) Amount of stockpiled HCFC-141b (on-hand, taken title to, or available from a supplier) along with a detailed analysis showing why stockpiled, recovered or recycled quantities are deemed to be unavailable, or technically or commercially infeasible for use (for example, taking into consideration undue costs for storage and transportation);

(x) An estimate of the number of control periods over which such an exemption would be necessary;

(xi) A detailed description of continuing investigations into and progress on possible alternatives and substitutes;

(xii) A list of alternatives considered, purchased or sampled, including dates and copies of receipts for verification;

(xiii) A summary of the petitioner's in-house development program including summaries of all relevant test results and their significance to subsequent decision-making and technology selection. Full supporting test data must be available on request including alternative tested and date on which it was tested;

(xiv) A clear statement of the preferred technical option(s) being pursued at the time of the petition and the reasoning for this selection;

(xv) A summary of product test results conducted on the preferred technical option(s) by accredited organizations in order to determine whether products meet applicable codes. Relevant test reports and certifications must be made available on request; and

(xvi) A description of the further development testing to be carried out over the number of control periods identified under paragraph (h)(1)(x) of this section.

(2) Within 21 business days of receipt of the petition, the Director of EPA's Office of Atmospheric Programs will issue to a HCFC-141b formulator, agency, department, or instrumentality of the U.S., or non-governmental space vehicle entity that has petitioned for HCFC-141b exemption allowances, based on information received in accordance with paragraph (h)(1) of this section, a notice indicating one of the following:

(i) A determination by the Director of EPA's Office of Atmospheric Programs to grant a specific quantity of HCFC-141b exemption allowances (in kilograms) for the production or import of HCFC-141b in a specified control period based on an assessment that HCFC-141b is necessary to maintain either safety, or operational or technical viability;

(ii) A determination by the Director of EPA's Office of Atmospheric Programs to request additional information because the information received in accordance with paragraph (h)(1) of this section is not sufficient to decide whether to grant or deny HCFC-141b exemption allowances. The Director of EPA's Office of Atmospheric Programs will decide whether to grant or deny HCFC-141b exemption allowances within 30 days of receipt of the additional information. However, if the petitioner fails to submit the additional information within 20 days of the request, such failure constitutes a basis for denying the petition for HCFC-141b exemption allowances.

(iii) A determination by the Director of EPA's Office of Atmospheric Programs to deny a grant of HCFC-141b exemption allowances due to one or more of the following reasons:

(A) The needs can be met by the use of a substance other than HCFC-141b;

(B) The needs can be met by the use of existing supplies of HCFC-141b;

(C) There is evidence of fraud or misrepresentation;

(D) Approval of the HCFC-141b exemption allowances would be inconsistent with U.S. obligations under the provisions of the Montreal Protocol (including Decisions agreed by the Parties);

(E) Approval of the HCFC-141b exemption allowances would be inconsistent with the Clean Air Act;

(F) There is an inadequate demonstration of efforts undertaken to research and implement alternatives; or

(G) Granting the HCFC-141b exemption allowances may reasonably be expected to endanger human health or the environment.

(3) Within ten working days after receipt of a notice outlining a determination by the Director of EPA's Office of Atmospheric Programs to deny a grant of HCFC-141b exemption allowances due to one or more of the reasons in paragraph (h)(2)(iii) of this section, the petitioner may file with the Director of EPA's Office of Atmospheric Programs a one-time appeal with elaborated information. The Director of EPA's Office of Atmospheric Programs may affirm the determination to deny a grant of HCFC-141b exemption allowances or make a determination to grant HCFC-141b exemption allowance, in light of the available evidence submitted with the appeal. If no appeal is submitted by the tenth day after receipt of the notice outlining a determination by the Director of EPA's Office of Atmospheric Programs to deny a grant of HCFC-141b exemption allowances, the denial will be final on that day.

(4) Any entity that has previously petitioned for HCFC-141b exemption allowances under paragraph (h)(1) of this section may file a petition for renewal for a subsequent control period by October 31st of the year preceding that control period. The petition for renewal must contain the following information:

- (i) Name and address of the HCFC-141b formulator, U.S. government entity or non-governmental space vehicle entity;
- (ii) Name of contact person, phone number, fax number and e-mail address;
- (iii) Quantity (in kilograms) of HCFC-141b needed for the control period;
- (iv) Description of markets and applications being served by the use of HCFC-141b;
- (v) A technical description of the process in which HCFC-141b is still being used;
- (vi) A technical description of the specific conditions under which the product is still being applied;
- (vii) Technical description of why alternatives and substitutes are still not sufficient to eliminate the use of HCFC-141b;
- (viii) Amount of stockpiled HCFC-141b (on-hand, taken title to, or available from a supplier) along with a detailed analysis showing why stockpiled, recovered or recycled quantities are deemed to be technically or economically infeasible for use; and
- (ix) A detailed description of continuing investigations into and progress on possible alternatives and substitutes and how this activity differs from information given in the previous request.

(5) A person granted HCFC-141b exemption allowances by the Director of EPA's Office of Atmospheric Programs under paragraph (h)(2)(i) or (h)(3) of this section may request a quantity of HCFC-141b be produced or imported in the specified control period listed in the notice by conferring the rights to produce or import to a producer or importer.

(6) The HCFC-141b exemption allowances held by one entity do not automatically transfer to an acquiring entity. Any entity acquiring another company holding HCFC-141b exemption allowances must submit a renewal application in accordance with paragraph (h)(4) of this section at the time of the acquisition in order to qualify for the HCFC-141b exemption allowances.

(7) A formulator for, or an agency, department, or instrumentality of the U.S., or a non-governmental space vehicle entity that has previously petitioned for and been granted HCFC-141b exemption allowances under paragraphs (h)(1) through (4) of this section is granted, on January 1 of each control period beginning January 1, 2007, HCFC-141b exemption allowances equivalent to 10% more than the highest amount previously granted under paragraphs (h)(1) through (4) of this section to that petitioner for space vehicle uses or defense applications.

(8) A formulator for, or an agency, department, or instrumentality of the U.S.; or a non-governmental space vehicle entity that has previously petitioned for and been granted HCFC-141b exemption allowances under paragraphs (h)(1) through (4) of this section but now seeks to obtain allowances in addition to those granted under paragraph (h)(7) of this section must submit a new petition in accordance with paragraph (h)(1) of this section.

[68 FR 2848, Jan. 21, 2003, as amended at 71 FR 41171, July 20, 2006]

§ 82.17 Apportionment of baseline production allowances for class II controlled substances.

Effective January 1, 2003, the following persons are apportioned baseline production allowances for HCFC-141b, HCFC-22, or HCFC-142b as set forth in the following table:

Person	Controlled substance	Allowances(kg.)
AlliedSignal (Honeywell)	HCFC-22	37,378,252
	HCFC-141b	28,705,200

	HCFC-142b	2,417,534
Ausimont USA	HCFC-142b	6,541,764
DuPont Company	HCFC-22	42,638,049
Elf Atochem (ATOFINA)	HCFC-22	28,219,223
	HCFC-141b	24,647,925
	HCFC-142b	16,131,096
LaRoche Industries	HCFC-141b	17,756,508
MDA Manufacturing	HCFC-22	2,383,835

[68 FR 2848, Jan. 21, 2003]

§ 82.18 Availability of production in addition to baseline production allowances for class II controlled substances.

(a) *Article 5 allowances.* (1) Effective January 1, 2003, a person apportioned baseline production allowances under §82.17 is also apportioned Article 5 allowances, equal to 15 percent of their baseline production allowances for the specified HCFC for each control period up until December 31, 2014, to be used for the production of the specified HCFC for export only to foreign states listed in Appendix E to this subpart.

(2) Effective January 1, 2015, for all HCFCs, a person apportioned baseline production allowances under §82.17 is also apportioned Article 5 allowances, equal to 10 percent of their baseline production allowances for the specified HCFC for each control period up until December 31, 2029, to be used for the production of the specified HCFC for export only to foreign states listed in Appendix E to this subpart.

(3) Effective January 1, 2030, for all HCFCs, a person apportioned baseline production allowances under §82.17 is also apportioned Article 5 allowances, equal to 15 percent of their baseline production allowances for the specified HCFC for each control period up until December 31, 2039, to be used for the production of the specified HCFC for export only to foreign states listed in Appendix E to this subpart.

(b) *Export production allowances.* (1) Effective January 1, 2003, a person apportioned baseline production allowances for HCFC-141b under §82.17 is also apportioned export production allowances equal to 100 percent of their baseline production allowances for HCFC-141b for each control period up until December 31, 2029, to be used for the production of HCFC-141b for export only, in accordance with this section.

(2) [Reserved]

(c) *International trades of production allowances, export production allowances and Article 5 allowances.*

(1) A person may increase or decrease its production allowances, export production allowances, or Article 5 allowances, for a specified control period through trades with another Party to the Protocol as set forth in this paragraph (c). Effective January 1, 2004, a nation listed either: in Appendix L of this subpart that is also listed in Appendix C, Annex 1 of the Protocol as having ratified the Beijing Amendments, or in Appendix C, Annex 1 of the Protocol as having ratified the Copenhagen Amendments but not listed in Appendix L of this subpart, or in Appendix C, Annex 2 of the Protocol, as being a foreign state complying with the Beijing Amendments if the foreign state is listed in Appendix L of this subpart, or as being a foreign state complying with the Copenhagen Amendments if the foreign state is not listed in Appendix L of this subpart must agree either to trade to the person for the current control period some quantity of production that the nation is permitted under the Montreal Protocol or to receive from the person for the current control period some quantity of production that the person is permitted under this subpart. The person must expend its consumption allowances allocated under §82.19, or obtained under §82.20 in order to produce with the additional production allowances.

(2) *Trade from a Party—Information requirements.* (i) A person requesting a trade from a Party must submit to the Administrator a signed document from the principal diplomatic representative in that

nation's embassy in the U.S. stating that the appropriate authority within that nation will establish or revise production limits for the nation to equal the lowest of the following three production quantities:

(A) The maximum production that the nation is allowed under the Protocol minus the quantity (in kilograms) to be traded;

(B) The maximum production that is allowed under the nation's applicable domestic law minus the quantity (in kilograms) to be traded; or

(C) The average of the nation's actual national production level for the three years prior to the trade minus the production to be traded.

(ii) A person requesting a trade from a Party must also submit to the Administrator a true copy of the document that sets forth the following:

(A) The identity and address of the person;

(B) The identity of the Party;

(C) The names and telephone numbers of contact persons for the person and for the Party;

(D) The chemical type and quantity (in kilograms) of production being traded;

(E) Documentation that the Party possesses the necessary quantity of unexpended production rights;

(F) The control period(s) to which the trade applies; and

(G) For increased production intended for export to the Party from whom the allowances would be received, a signed statement of intent to export to the Party.

(3) *Trade to a Party—Information requirements.* A person requesting a trade to a Party must submit a request that sets forth the following information to the Administrator:

(i) The identity and address of the person;

(ii) The identity of the Party;

(iii) The names and telephone numbers of contact persons for the person and for the Party;

(iv) The chemical type and quantity (in kilograms) of allowable production being traded; and

(v) The control period(s) to which the trade applies.

(4) *Review of international trade request to a Party.* After receiving a trade request that meets the requirements of paragraph (c)(3) of this section, the Administrator may, at his/her discretion, consider the following factors by seeking concurrence from the Department of Commerce, the United States Trade Representative, and the Department of State, where appropriate, in deciding whether to approve such a trade:

(i) Possible creation of domestic economic hardship;

(ii) Possible effects on trade;

(iii) Potential environmental implications; and

(iv) The total quantity of unexpended production allowances held by U.S. entities.

(5) *Notice of trade.* If the request meets the requirement of paragraph (c)(2) of this section for trades from Parties and paragraphs (c)(3) and (4) of this section for trades to Parties, the Administrator will issue the person a notice. The notice will either grant or deduct production allowances or export production allowances or Article 5 allowances and specify the control period to which the trade applies. The Administrator may disapprove the trade request contingent on the consideration of factors listed in paragraph (c)(4) of this section for trades to Parties.

(i) For trades from a Party, the Administrator will issue a notice revising the allowances held by the recipient of the trade to equal the unexpended production allowances, unexpended export production allowances, or unexpended Article 5 allowances held by the recipient of the trade under this subpart plus the quantity of allowable production traded from the Party.

(ii) For trades to a Party, the Administrator will issue a notice revising the production limit for the trader to equal the lesser of:

(A) The unexpended production allowances, unexpended export production allowances or unexpended Article 5 allowances held by the trade or minus the quantity traded; or

(B) The unexpended production allowances held by the trader minus the amount by which the U.S. average annual production of the class II controlled substance being traded for the three years prior to the trade is less than the total allowable production of that class II controlled substance under this subpart minus the amount traded; or

(C) The total U.S. allowable production of the class II controlled substance being traded minus the three-year average of the actual annual U.S. production of the class II controlled substance prior to the control period of the trade.

(6) Revised notices of production limits for subsequent traders. If after one person obtains approval of a trade of allowable production of a class II controlled substance to a Party and other persons obtain approval for trades of the same class II controlled substance during the same control period, the Administrator will issue revised notices. The notices will revise the production limits for each of the other persons trading to equal the lesser of:

(i) The unexpended production allowances, unexpended export production allowances or unexpended Article 5 allowances held by the trader under this subpart minus the quantity traded; or

(ii) The result of the following set of calculations:

(A) The total U.S. allowable production of the class II controlled substance minus the three-year average of the actual annual U.S. production of the class II controlled substance prior to the control period of the trade;

(B) The quantity traded divided by the total quantity traded by all the other persons trading the same class II controlled substance in the same control period;

(C) The result of paragraph (c)(6)(ii)(A) of this section multiplied by the result of paragraph (c)(6)(ii)(B) of this section;

(D) The quantity derived in paragraph (c)(6)(i) of this section, minus the result of paragraph (c)(6)(ii)(C) of this section;

(7) Production limit for previous traders. The Administrator will also issue a notice revising the production limit for each trader who previously obtained approval of a trade of the class II controlled substance to a Party in the same control period to equal the result of the following set of calculations:

(i) The total U.S. allowable production of the class II controlled substance minus the three-year average of the actual annual U.S. production of the class II controlled substance prior to the control period of the trade;

(ii) The quantity traded by the person divided by the quantity traded by all the persons who have traded

that class II controlled substance in that control period;

(iii) The result of paragraph (c)(7)(i) of this section multiplied by the result of paragraph (c)(7)(ii) of this section.

(iv) The unexpended production allowances, unexpended export production allowances or unexpended Article 5 allowances held by the person plus the result of paragraph (c)(7)(iii) of this section;

(8) Effective date of revised production limits. The change in production allowances, export production allowances or Article 5 allowances will be effective on the date that the notice is issued.

[68 FR 2848, Jan. 21, 2003]

§ 82.19 Apportionment of baseline consumption allowances for class II controlled substances.

(a) Effective January 1, 2003, the following persons are apportioned baseline consumption allowances for HCFC-141b, HCFC-22, or HCFC-142b as set forth in the following table:

Person	Controlled substance	Allowances (kg)
ABCO Refrigeration Supply	HCFC-22	279,366
Air Systems	HCFC-22	13,514
Allied (Honeywell)	HCFC-22	35,392,492
	HCFC-141b	20,749,489
	HCFC-142b	1,315,819
Altair Industries	HCFC-22	279,935
Ausimont USA	HCFC-22	99,643
	HCFC-142b	3,047,386
Automatic Equipment Sales of VA	HCFC-22	54,088
Condor Products	HCFC-22	666,171
Continental	HCFC-141b	20,315
Discount Refrigerants	HCFC-22	375,328
	HCFC-141b	994
DuPont Company	HCFC-22	38,814,862
	HCFC-141b	9,049
	HCFC-142b	52,797
Elf Atochem (ATOFINA)	HCFC-22	29,524,481
	HCFC-141b	25,405,570
	HCFC-142b	16,672,675
Full Circle	HCFC-22	14,865
HG Refrigeration Supply	HCFC-22	40,068
ICC Chemical Corp.	HCFC-141b	81,225
ICI Americas (INEOS)	HCFC-22	2,546,305
Kivlan & Co. (Dynatemp)	HCFC-22	2,028,980
Klomar Ship Supply	HCFC-22	8,585
LaRoche Industries	HCFC-141b	16,097,869

MDA Manufacturing	HCFC-22	2,541,545
Mondy-Global	HCFC-22	281,824
National Refrigerants	HCFC-22	5,480,315
Refricenter of Miami	HCFC-22	381,293
Refricentro	HCFC-22	45,979
Rhone-Poulenc	HCFC-22	52,090
R-Lines	HCFC-22	63,172
Saez	HCFC-22	37,936
Solvay Fluorides	HCFC-22	313,966
	HCFC-141b	3,940,115
TESCO Distributors	HCFC-22	48,049
Tulstar Products	HCFC-141b	89,913

[68 FR 2848, Jan. 21, 2003]

§ 82.20 Availability of consumption allowances in addition to baseline consumption allowances for class II controlled substances.

(a) A person may obtain at any time during the control period, in accordance with the provisions of this section, consumption allowances equivalent to the quantity of class II controlled substances that the person exported from the U.S. and its territories to a foreign state, in accordance with this section, when that quantity of class II controlled substance was produced in the U.S. or imported into the U.S. with expended consumption allowances.

(1) The exporter must submit to the Administrator a request for consumption allowances setting forth the following:

(i) The identities and addresses of the exporter and the recipient of the exports;

(ii) The exporter's Employer Identification Number;

(iii) The names and telephone numbers of contact persons for the exporter and the recipient;

(iv) The quantity (in kilograms) and type of class II controlled substances reported;

(v) The source of the class II controlled substances and the date purchased;

(vi) The date on which, and the port from which, the class II controlled substances were exported from the U.S. or its territories;

(vii) The country to which the class II controlled substances were exported;

(viii) A copy of the bill of lading and the invoice indicating the net quantity (in kilograms) of class II controlled substances shipped and documenting the sale of the class II controlled substances to the purchaser;

(ix) The commodity codes of the class II controlled substances reported; and

(x) A written statement from the producer that the class II controlled substances were produced with expended allowances or a written statement from the importer that the class II controlled substances were imported with expended allowances.

(2) The Administrator will review the information and documentation submitted under paragraph (a)(1) of this section and will issue a notice.

(i) The Administrator will determine the quantity of class II controlled substances that the documentation verifies was exported and issue consumption allowances equivalent to the quantity of class II controlled substances that were exported.

(A) The grant of the consumption allowances will be effective on the date the notice is issued.

(B) The consumption allowances will be granted to the person the exporter indicates, whether it is the producer, the importer, or the exporter.

(ii) The Administrator will issue a notice that the consumption allowances are not granted if the Administrator determines that the information and documentation do not satisfactorily substantiate the exporter's claims.

(b) *International trades of consumption allowances.* (1) A person may increase its consumption allowances for a specified control period through trades with another Party to the Protocol as set forth in this paragraph (b). A person may only receive consumption from Poland or Norway, or both, and only if the nation agrees to trade to the person for the current control period some quantity of consumption that the nation is permitted under the Montreal Protocol.

(2) Trade from a Party—Information requirements. A person must submit the following information to the Administrator:

(i) A signed document from the principal diplomatic representative in the Polish or Norwegian embassy in the U.S. stating that the appropriate authority within that nation will establish or revise consumption limits for the nation to equal the lowest of the following three consumption quantities:

(A) The maximum consumption that the nation is allowed under the Protocol minus the quantity (in kilograms) traded;

(B) The maximum consumption that is allowed under the nation's applicable domestic law minus the quantity (in kilograms) traded; or

(C) The average of the nation's actual consumption level for the three years prior to the trade minus the consumption traded.

(ii) A person requesting a consumption trade from Poland or Norway must also submit to the Administrator a true copy of the document that sets forth the following:

(A) The identity and address of the person;

(B) The identity of the Party;

(C) The names and telephone numbers of contact persons for the person and for the Party;

(D) The chemical type and quantity (in kilograms) of consumption being traded;

(E) Documentation that the Party possesses the necessary quantity of unexpended consumption rights;

(F) The control period(s) to which the trade applies; and

(3) *Notice of trade.* If the request meets the requirement of paragraph (b)(2) of this section for trades from Parties, the Administrator will issue the person a notice. The notice will grant consumption allowances and specify the control period to which the trade applies. The Administrator may disapprove the trade request if it does not meet the requirements of paragraph (b)(2) of this section.

(4) *Trade from a Party.* The Administrator will issue a notice revising the allowances held by the recipient of the trade to equal the unexpended consumption allowances held by the recipient of the trade under this subpart plus the quantity of allowable consumption traded from the Party.

(5) *Effective date of revised consumption limits.* The change in consumption allowances will be effective on the date that the notice is issued.

[68 FR 2848, Jan. 21, 2003, as amended at 71 FR 41172, July 20, 2006]

§§ 82.21-82.22 [Reserved]

§ 82.23 Transfers of allowances of class II controlled substances.

(a) *Inter-company transfers.* Effective January 1, 2003, a person ("transferor") may transfer to any other person ("transferee") any quantity of the transferor's class II consumption allowances, production allowances, export production allowances, or Article 5 allowances for the same type of allowance as follows:

(i) The transferor must submit to the Administrator a transfer claim setting forth the following:

(A) The identities and addresses of the transferor and the transferee;

(B) The name and telephone numbers of contact persons for the transferor and the transferee;

(C) The type of allowances being transferred, including the names of the class II controlled substances for which allowances are to be transferred;

(D) The quantity (in kilograms) of allowances being transferred;

(E) The control period(s) for which the allowances are being transferred;

(F) The quantity of unexpended allowances of the type and for the control period being transferred that the transferor holds under authority of this subpart on the date the claim is submitted to EPA; and

(G) For trades of consumption allowances, production allowances, export production allowances, or Article 5 allowances, the quantity of the 0.1 percent offset applied to the unweighted quantity traded that will be deducted from the transferor's allowance balance.

(ii) The Administrator will determine whether the records maintained by EPA indicate that the transferor possesses unexpended allowances sufficient to cover the transfer claim on the date the transfer claim is processed. The transfer claim is the quantity (in kilograms) to be transferred plus, in the case of transfers of production or consumption allowances, 0.1 percent of that quantity. The Administrator will take into account any previous transfers, any production, and allowable imports and exports of class II controlled substances reported by the transferor. Within three working days of receiving a complete transfer claim, the Administrator will take action to notify the transferor and transferee as follows:

(A) The Administrator will issue a notice indicating that EPA does not object to the transfer if EPA's records show that the transferor has sufficient unexpended allowances to cover the transfer claim. In the case of transfers of production or consumption allowances, EPA will reduce the transferor's balance of unexpended allowances by the quantity to be transferred plus 0.1 percent of that quantity. In the case of transfers of export production or Article 5 allowances, EPA will reduce the transferor's balance of unexpended allowances, respectively, by the quantity to be transferred. The transferor and the transferee may proceed with the transfer when EPA issues a no objection notice. However, if EPA ultimately finds that the transferor did not have sufficient unexpended allowances to cover the claim, the transferor and transferee, where applicable, will be held liable for any knowing violations of the regulations of this subpart that occur as a result of, or in conjunction with, the improper transfer.

(B) The Administrator will issue a notice disallowing the transfer if EPA's records show that the transferor has insufficient unexpended allowances to cover the transfer claim, or that the transferor has failed to respond to one or more Agency requests to supply information needed to make a determination. Either

party may file a notice of appeal, with supporting reasons, with the Administrator within 10 working days after receipt of notification. The Administrator may affirm or vacate the disallowance. If no appeal is taken by the tenth working day after notification, the disallowance shall be final on that day.

(iii) The transferor and transferee may proceed with the transfer if the Administrator does not respond to a transfer claim within the three working days specified in paragraph (a)(1)(ii) of this section. In the case of transfers of production or consumption allowances, EPA will reduce the transferor's balance of unexpended allowances by the quantity to be transferred plus 0.1 percent of that quantity. In the case of transfers of export production allowances or Article 5 allowances, EPA will reduce the transferor's balance of unexpended allowances by the quantity to be transferred plus 0.1 percent of that quantity. If EPA ultimately finds that the transferor did not have sufficient unexpended allowances to cover the claim, the transferor and/or the transferee, where applicable, will be held liable for any knowing violations of the regulations of this subpart that occur as a result of, or in conjunction with, the improper transfer.

(b) *Inter-pollutant transfers.* (1) Effective January 1, 2003, a person (transferor) may convert consumption allowances or production allowances for one class II controlled substance to the same type of allowance for another class II controlled substance listed in Appendix B of this subpart, following the procedures described in paragraph (b)(3) of this section.

(2) Inter-pollutant transfers will be permitted at any time during the control period and during the 30 days after the end of a control period.

(3) The transferor must submit to the Administrator a transfer claim that includes the following:

(i) The identity and address of the transferor;

(ii) The name and telephone number of a contact person for the transferor;

(iii) The type of allowances being converted, including the names of the class II controlled substances for which allowances are to be converted;

(iv) The quantity (in kilograms) and type of allowances to be converted;

(v) The quantity (in kilograms) of allowances to be subtracted from the transferor's unexpended allowances for the first class II controlled substance, to be equal to 100.1 percent of the quantity of allowances converted;

(vi) The quantity (in kilograms) of allowances to be added to the transferee's unexpended allowances for the second class II controlled substance, to be equal to the quantity (in kilograms) of allowances for the first class II controlled substance being converted multiplied by the quotient of the ozone depletion potential of the first class II controlled substance divided by the ozone depletion potential of the second class II controlled substance, as listed in Appendix B to this subpart;

(vii) The control period(s) for which the allowances are being converted; and

(viii) The quantity (in kilograms) of unexpended allowances of the type and for the control period being converted that the transferor holds under authority of this subpart as of the date the claim is submitted to EPA.

(4) The Administrator will determine whether the records maintained by EPA indicate that the convertor possesses unexpended allowances sufficient to cover the transfer claim on the date the transfer claim is processed (*i.e.*, the quantity (in kilograms) to be converted plus 0.1 percent of that quantity (in kilograms)). EPA will take into account any previous transfers, and any production, imports (not including transshipments or used class II controlled substances), or exports (not including transshipments or used class II controlled substances) of class II controlled substances reported by the convertor. Within three working days of receiving a complete transfer claim, the Administrator will take action to notify the convertor as follows:

(i) The Administrator will issue a notice indicating that EPA does not object to the transfer if EPA's records show that the convertor has sufficient unexpended allowances to cover the transfer claim. EPA

will reduce the transferor's balance of unexpended allowances by the quantity to be converted plus 0.1 percent of that quantity (in kilograms). When EPA issues a no objection notice, the transferor may proceed with the transfer. However, if EPA ultimately finds that the transferor did not have sufficient unexpended allowances to cover the claim, the transferor will be held liable for any violations of the regulations of this subpart that occur as a result of, or in conjunction with, the improper transfer.

(ii) The Administrator will issue a notice disallowing the transfer if EPA's records show that the transferor has insufficient unexpended allowances to cover the transfer claim, or that the transferor has failed to respond to one or more Agency requests to supply information needed to make a determination. The transferor may file a notice of appeal, with supporting reasons, with the Administrator within 10 working days after receipt of notification. The Administrator may affirm or vacate the disallowance. If no appeal is taken by the tenth working day after notification, the disallowance shall be final on that day.

(iii) The transferor may proceed with the transfer if the Administrator does not respond to a transfer claim within the three working days specified in paragraph (b)(4) of this section. EPA will reduce the transferor's balance of unexpended allowances by the quantity (in kilograms) to be converted plus 0.1 percent of that quantity (in kilograms). The transferor will be held liable for any violations of the regulations of this subpart that occur as a result of, or in conjunction with, the improper transfer if EPA ultimately finds that the transferor did not have sufficient unexpended allowances or credits to cover the claim.

(c) *Inter-company transfers and Inter-pollutant transfers.* If a person requests an inter-company transfer and an inter-pollutant transfer simultaneously, the quantity (in kilograms) subtracted from the transferor's unexpended production or consumption allowances for the first class II controlled substance will be equal to 100.1 percent of the quantity (in kilograms) of allowances that are being converted and transferred.

(d) A person receiving a permanent transfer of baseline production allowances or baseline consumption allowances (the transferee) for a specific class II controlled substance will be the person who has their baseline allowances adjusted in accordance with phaseout schedules in this section.

[68 FR 2848, Jan. 21, 2003]

§ 82.24 Recordkeeping and reporting requirements for class II controlled substances.

(a) *Recordkeeping and reporting.* Any person who produces, imports, exports, transforms, or destroys class II controlled substances must comply with the following recordkeeping and reporting requirements:

(1) Reports required by this section must be mailed to the Administrator within 30 days of the end of the applicable reporting period, unless otherwise specified.

(2) Revisions of reports that are required by this section must be mailed to the Administrator within 180 days of the end of the applicable reporting period, unless otherwise specified.

(3) Records and copies of reports required by this section must be retained for three years.

(4) Quantities of class II controlled substances must be stated in terms of kilograms in reports required by this section.

(5) Reports and records required by this section may be used for purposes of compliance determinations. These requirements are not intended as a limitation on the use of other evidence admissible under the Federal Rules of Evidence. Failure to provide the reports, petitions and records required by this section and to certify the accuracy of the information in the reports, petitions and records required by this section, will be considered a violation of this subpart. False statements made in reports, petitions and records will be considered violations of Section 113 of the Clean Air Act and under 18 U.S.C. 1001.

(b) *Producers.* Persons ("producers") who produce class II controlled substances during a control period must comply with the following recordkeeping and reporting requirements:

(1) *Reporting—Producers.* For each quarter, each producer of a class II controlled substance must provide the Administrator with a report containing the following information:

(i) The quantity (in kilograms) of production of each class II controlled substance used in processes resulting in their transformation by the producer and the quantity (in kilograms) intended for transformation by a second party;

(ii) The quantity (in kilograms) of production of each class II controlled substance used in processes resulting in their destruction by the producer and the quantity (in kilograms) intended for destruction by a second party;

(iii) The expended allowances for each class II controlled substance;

(iv) The producer's total of expended and unexpended production allowances, consumption allowances, export production allowances, and Article 5 allowances at the end of that quarter;

(v) The quantity (in kilograms) of class II controlled substances sold or transferred during the quarter to a person other than the producer for use in processes resulting in their transformation or eventual destruction;

(vi) A list of the quantities and names of class II controlled substances, exported by the producer to a Party to the Protocol, that will be transformed or destroyed and therefore were not produced expending production or consumption allowances;

(vii) For transformation in the U.S. or by a person of another Party, one copy of a transformation verification from the transformer for a specific class II controlled substance and a list of additional quantities shipped to that same transformer for the quarter;

(viii) For destruction in the U.S. or by a person of another Party, one copy of a destruction verification as required in paragraph (e) of this section for a particular destroyer, destroying the same class II controlled substance, and a list of additional quantities shipped to that same destroyer for the quarter;

(ix) In cases where the producer produced class II controlled substances using export production allowances, a list of U.S. entities that purchased those class II controlled substances and exported them to a Party to the Protocol;

(x) In cases where the producer produced class II controlled substances using Article 5 allowances, a list of U.S. entities that purchased those class II controlled substances and exported them to Article 5 countries; and

(xi) A list of the HCFC 141b-exemption allowance holders from whom orders were received and the quantity (in kilograms) of HCFC-141b requested and produced.

(2) *Recordkeeping—Producers.* Every producer of a class II controlled substance during a control period must maintain the following records:

(i) Dated records of the quantity (in kilograms) of each class II controlled substance produced at each facility;

(ii) Dated records of the quantity (in kilograms) of class II controlled substances produced for use in processes that result in their transformation or for use in processes that result in their destruction;

(iii) Dated records of the quantity (in kilograms) of class II controlled substances sold for use in processes that result in their transformation or for use in processes that result in their destruction;

(iv) Dated records of the quantity (in kilograms) of class II controlled substances produced with export production allowances or Article 5 allowances;

(v) Copies of invoices or receipts documenting sale of class II controlled substances for use in

processes that result in their transformation or for use in processes that result in their destruction;

(vi) Dated records of the quantity (in kilograms) of each class II controlled substance used at each facility as feedstocks or destroyed in the manufacture of a class II controlled substance or in the manufacture of any other substance, and any class II controlled substance introduced into the production process of the same class II controlled substance at each facility;

(vii) Dated records of the quantity (in kilograms) of raw materials and feedstock chemicals used at each facility for the production of class II controlled substances;

(viii) Dated records of the shipments of each class II controlled substance produced at each plant;

(ix) The quantity (in kilograms) of class II controlled substances, the date received, and names and addresses of the source of used materials containing class II controlled substances which are recycled or reclaimed at each plant;

(x) Records of the date, the class II controlled substance, and the estimated quantity of any spill or release of a class II controlled substance that equals or exceeds 100 pounds;

(xi) Transformation verification in the case of transformation, or the destruction verification in the case of destruction as required in paragraph (e) of this section showing that the purchaser or recipient of a class II controlled substance, in the U.S. or in another country that is a Party, certifies the intent to either transform or destroy the class II controlled substance, or sell the class II controlled substance for transformation or destruction in cases when allowances were not expended;

(xii) Written verifications from a U.S. purchaser that the class II controlled substance was exported to a Party in accordance with the requirements in this section, in cases where export production allowances were expended to produce the class II controlled substance;

(xiii) Written verifications from a U.S. purchaser that the class II controlled substance was exported to an Article 5 country in cases where Article 5 allowances were expended to produce the class II controlled substance;

(xiv) Written verifications from a U.S. purchaser that HCFC-141b was manufactured for the express purpose of meeting HCFC-141b exemption needs in accordance with information submitted under §82.16(h), in cases where HCFC-141b exemption allowances were expended to produce the HCFC-141b.

(3) For any person who fails to maintain the records required by this paragraph, or to submit the report required by this paragraph, the Administrator may assume that the person has produced at full capacity during the period for which records were not kept, for purposes of determining whether the person has violated the prohibitions at §82.15.

(c) *Importers.* Persons ("importers") who import class II controlled substances during a control period must comply with the following recordkeeping and reporting requirements:

(1) *Reporting—Importers.* For each quarter, an importer of a class II controlled substance (including importers of used class II controlled substances) must submit to the Administrator a report containing the following information:

(i) Summaries of the records required in paragraphs (c)(2)(i) through (xvi) of this section for the previous quarter;

(ii) The total quantity (in kilograms) imported of each class II controlled substance for that quarter;

(iii) The commodity code for the class II controlled substances imported, which must be one of those listed in Appendix K to this subpart;

(iv) The quantity (in kilograms) of those class II controlled substances imported that are used class II controlled substances;

- (v) The quantity (in kilograms) of class II controlled substances imported for that quarter and totaled by chemical for the control period to date;
- (vi) For substances for which EPA has apportioned baseline production and consumption allowances, the importer's total sum of expended and unexpended consumption allowances by chemical as of the end of that quarter;
- (vii) The quantity (in kilograms) of class II controlled substances imported for use in processes resulting in their transformation or destruction;
- (viii) The quantity (in kilograms) of class II controlled substances sold or transferred during that quarter to each person for use in processes resulting in their transformation or eventual destruction; and
- (ix) Transformation verifications showing that the purchaser or recipient of imported class II controlled substances intends to transform those substances or destruction verifications showing that the purchaser or recipient intends to destroy the class II controlled substances (as provided in paragraph (e) of this section).
- (x) [Reserved]
- (xi) A list of the HCFC 141b-exemption allowance holders from whom orders were received and the quantity (in kilograms) of HCFC-141b requested and imported.

(2) *Recordkeeping—Importers.* An importer of a class II controlled substance (including used class II controlled substances) must maintain the following records:

- (i) The quantity (in kilograms) of each class II controlled substance imported, either alone or in mixtures, including the percentage of each mixture which consists of a class II controlled substance;
- (ii) The quantity (in kilograms) of those class II controlled substances imported that are used and the information provided with the petition where a petition is required under paragraph (c)(3) of this section;
- (iii) The quantity (in kilograms) of class II controlled substances other than transshipments or used substances imported for use in processes resulting in their transformation or destruction;
- (iv) The quantity (in kilograms) of class II controlled substances other than transshipments or used substances imported and sold for use in processes that result in their destruction or transformation;
- (v) The date on which the class II controlled substances were imported;
- (vi) The port of entry through which the class II controlled substances passed;
- (vii) The country from which the imported class II controlled substances were imported;
- (viii) The commodity code for the class II controlled substances shipped, which must be one of those listed in Appendix K to this subpart;
- (ix) The importer number for the shipment;
- (x) A copy of the bill of lading for the import;
- (xi) The invoice for the import;
- (xii) The quantity (in kilograms) of imports of used class II controlled substances;
- (xiii) The U.S. Customs entry form;
- (xiv) Dated records documenting the sale or transfer of class II controlled substances for use in

processes resulting in their transformation or destruction;

(xv) Copies of transformation verifications or destruction verifications indicating that the class II controlled substances will be transformed or destroyed (as provided in paragraph (e) of this section).

(xvi) Written verifications from a U.S. purchaser that HCFC-141b was imported for the express purpose of meeting HCFC-141b exemption needs in accordance with information submitted under §82.16(h), and that the quantity will not be resold, in cases where HCFC-141b exemption allowances were expended to import the HCFC-141b.

(3) *Petition to import used class II controlled substances and transshipment-Importers.* For each individual shipment over 5 pounds of a used class II controlled substance as defined in §82.3 for which EPA has apportioned baseline production and consumption allowances, an importer must submit directly to the Administrator, at least 40 working days before the shipment is to leave the foreign port of export, the following information in a petition:

(i) The name and quantity (in kilograms) of the used class II controlled substance to be imported;

(ii) The name and address of the importer, the importer ID number, the contact person, and the phone and fax numbers;

(iii) Name, address, contact person, phone number and fax number of all previous source facilities from which the used class II controlled substance was recovered;

(iv) A detailed description of the previous use of the class II controlled substance at each source facility and a best estimate of when the specific controlled substance was put into the equipment at each source facility, and, when possible, documents indicating the date the material was put into the equipment;

(v) A list of the name, make and model number of the equipment from which the material was recovered at each source facility;

(vi) Name, address, contact person, phone number and fax number of the exporter and of all persons to whom the material was transferred or sold after it was recovered from the source facility;

(vii) The U.S. port of entry for the import, the expected date of shipment and the vessel transporting the chemical. If at the time of submitting a petition the importer does not know the U.S. port of entry, the expected date of shipment and the vessel transporting the chemical, and the importer receives a non-objection notice for the individual shipment in the petition, the importer is required to notify the Administrator of this information prior to the actual U.S. Customs entry of the individual shipment;

(viii) A description of the intended use of the used class II controlled substance, and, when possible, the name, address, contact person, phone number and fax number of the ultimate purchaser in the United States;

(ix) The name, address, contact person, phone number and fax number of the U.S. reclamation facility, where applicable;

(x) If someone at the source facility recovered the class II controlled substance from the equipment, the name and phone and fax numbers of that person;

(xi) If the imported class II controlled substance was reclaimed in a foreign Party, the name, address, contact person, phone number and fax number of any or all foreign reclamation facility(ies) responsible for reclaiming the cited shipment;

(xii) An export license from the appropriate government agency in the country of export and, if recovered in another country, the export license from the appropriate government agency in that country;

(xiii) If the imported used class II controlled substance is intended to be sold as a refrigerant in the U.S., the name and address of the U.S. reclaimer who will bring the material to the standard required under

subpart F of this part, if not already reclaimed to those specifications; and

(xiv) A certification of accuracy of the information submitted in the petition.

(4) Review of petition to import used class II controlled substances and transshipments—Importers.

Starting on the first working day following receipt by the Administrator of a petition to import a used class II controlled substance, the Administrator will initiate a review of the information submitted under paragraph(c)(3) of this section and take action within 40 working days to issue either an objection-notice or a non-objection notice for the individual shipment to the person who submitted the petition to import the used class II controlled substance.

(i) The Administrator may issue an objection notice to a petition for the following reasons:

(A) If the Administrator determines that the information is insufficient, that is, if the petition lacks or appears to lack any of the information required under paragraph (c)(3) of this section;

(B) If the Administrator determines that any portion of the petition contains false or misleading information, or the Administrator has information from other U.S. or foreign government agencies indicating that the petition contains false or misleading information;

(C) If the transaction appears to be contrary to provisions of the Vienna Convention on Substances that Deplete the Ozone Layer, the Montreal Protocol and Decisions by the Parties, or the non-compliance procedures outlined and instituted by the Implementation Committee of the Montreal Protocol;

(D) If the appropriate government agency in the exporting country has not agreed to issue an export license for the cited individual shipment of used class II controlled substance;

(E) If reclamation capacity is installed or is being installed for that specific class II controlled substance in the country of recovery or country of export and the capacity is funded in full or in part through the Multilateral Fund.

(ii) Within ten (10) working days after receipt of the objection notice, the importer may re-petition the Administrator, only if the Administrator indicated "insufficient information" as the basis for the objection notice. If no appeal is taken by the tenth working day after the date on the objection notice, the objection shall become final. Only one re-petition will be accepted for any original petition received by EPA.

(iii) Any information contained in the re-petition which is inconsistent with the original petition must be identified and a description of the reason for the inconsistency must accompany the re-petition.

(iv) In cases where the Administrator does not object to the petition based on the criteria listed in paragraph (c)(4)(i) of this section, the Administrator will issue a non-objection notice.

(v) To pass the approved used class II controlled substances through U.S. Customs, the petition and the non-objection notice issued by EPA must accompany the shipment through U.S. Customs.

(vi) If for some reason, following EPA's issuance of a non-objection notice, new information is brought to EPA's attention which shows that the non-objection notice was issued based on false information, then EPA has the right to:

(A) Revoke the non-objection notice;

(B) Pursue all means to ensure that the class II controlled substance is not imported into the U.S.; and

(C) Take appropriate enforcement actions.

(vii) Once the Administrator issues a non-objection notice, the person receiving the non-objection notice is permitted to import the individual shipment of used class II controlled substance only within the same control period as the date stamped on the non-objection notice.

(viii) A person receiving a non-objection notice from the Administrator for a petition to import used class II controlled substances must maintain the following records:

(A) A copy of the petition;

(B) The EPA non-objection notice;

(C) The bill of lading for the import; and

(D) U.S. Customs entry documents for the import that must include one of the commodity codes from Appendix K to this subpart.

(5) Recordkeeping for transshipments—Importers. Any person who tranships a class II controlled substance must maintain records that indicate:

(i) That the class II controlled substance shipment originated in a foreign country;

(ii) That the class II controlled substance shipment is destined for another foreign country; and

(iii) That the class II controlled substance shipment will not enter interstate commerce within the U.S.

(d) *Exporters*. Persons (“exporters”) who export class II controlled substances during a control period must comply with the following reporting requirements:

(1) *Reporting—Exporters*. For any exports of class II controlled substances not reported under §82.20 (additional consumption allowances), or under paragraph (b)(2) of this section (reporting for producers of class II controlled substances), each exporter who exported a class II controlled substance must submit to the Administrator the following information within 30 days after the end of each quarter in which the unreported exports left the U.S.:

(i) The names and addresses of the exporter and the recipient of the exports;

(ii) The exporter’s Employer Identification Number;

(iii) The type and quantity (in kilograms) of each class II controlled substance exported and what percentage, if any of the class II controlled substance is used;

(iv) The date on which, and the port from which, the class II controlled substances were exported from the U.S. or its territories;

(v) The country to which the class II controlled substances were exported;

(vi) The quantity (in kilograms) exported to each Article 5 country;

(vii) The commodity code for the class II controlled substances shipped, which must be one of those listed in Appendix K to this subpart;

(viii) For persons reporting transformation or destruction, the invoice or sales agreement containing language similar to the transformation verifications that the purchaser or recipient of imported class II controlled substances intends to transform those substances, or destruction verifications showing that the purchaser or recipient intends to destroy the class II controlled substances (as provided in paragraph (e) of this section).

(2) *Reporting export production allowances—Exporters*. In addition to the information required in paragraph (d)(1) of this section, any exporter using export production allowances must also provide the following to the Administrator:

(i) The Employer Identification Number on the Shipper’s Export Declaration Form or Employer

Identification Number of the shipping agent shown on the U.S. Customs Form 7525;

(ii) The exporting vessel on which the class II controlled substances were shipped; and

(iii) The quantity (in kilograms) exported to each Party.

(3) *Reporting Article 5 allowances—Exporters.* In addition to the information required in paragraph (d)(1) of this section, any exporter using Article 5 allowances must also provide the following to the Administrator:

(i) The Employer Identification Number on the Shipper's Export Declaration Form or Employer Identification Number of the shipping agent shown on the U.S. Customs Form 7525; and

(ii) The exporting vessel on which the class II controlled substances were shipped.

(4) *Reporting used class II controlled substances—Exporters.* Any exporter of used class II controlled substances must indicate on the bill of lading or invoice that the class II controlled substance is used, as defined in §82.3.

(e) *Transformation and destruction.* Any person who transforms or destroys class II controlled substances must comply with the following recordkeeping and reporting requirements:

(1) *Recordkeeping—Transformation and destruction.* Any person who transforms or destroys class II controlled substances produced or imported by another person must maintain the following:

(i) Copies of the invoices or receipts documenting the sale or transfer of the class II controlled substances to the person;

(ii) Records identifying the producer or importer of the class II controlled substances received by the person;

(iii) Dated records of inventories of class II controlled substances at each plant on the first day of each quarter;

(iv) Dated records of the quantity (in kilograms) of each class II controlled substance transformed or destroyed;

(v) In the case where class II controlled substances were purchased or transferred for transformation purposes, a copy of the person's transformation verification as provided under paragraph (e)(3) of this section.

(vi) Dated records of the names, commercial use, and quantities (in kilograms) of the resulting chemical(s) when the class II controlled substances are transformed; and

(vii) Dated records of shipments to purchasers of the resulting chemical(s) when the class II controlled substances are transformed.

(viii) In the case where class II controlled substances were purchased or transferred for destruction purposes, a copy of the person's destruction verification, as provided under paragraph (e)(5) of this section.

(2) *Reporting—Transformation and destruction.* Any person who transforms or destroys class II controlled substances and who has submitted a transformation verification ((paragraph (e)(3) of this section) or a destruction verification (paragraph (e)(5) of this section) to the producer or importer of the class II controlled substances, must report the following:

(i) The names and quantities (in kilograms) of the class II controlled substances transformed for each control period within 45 days of the end of such control period; and

(ii) The names and quantities (in kilograms) of the class II controlled substances destroyed for each control period within 45 days of the end of such control period.

(3) *Reporting—Transformation.* Any person who purchases class II controlled substances for purposes of transformation must provide the producer or importer with a transformation verification that the class II controlled substances are to be used in processes that result in their transformation.

(i) The transformation verification shall include the following:

(A) Identity and address of the person intending to transform the class II controlled substances;

(B) The quantity (in kilograms) of class II controlled substances intended for transformation;

(C) Identity of shipments by purchase order number(s), purchaser account number(s), by location(s), or other means of identification;

(D) Period of time over which the person intends to transform the class II controlled substances; and

(E) Signature of the verifying person.

(ii) [Reserved]

(4) *Reporting—Destruction.* Any person who destroys class II controlled substances shall provide EPA with a one-time report containing the following information:

(i) The destruction unit's destruction efficiency;

(ii) The methods used to record the volume destroyed;

(iii) The methods used to determine destruction efficiency;

(iv) The name of other relevant federal or state regulations that may apply to the destruction process;

(v) Any changes to the information in paragraphs (e)(4)(i), (ii), and (iii) of this section must be reflected in a revision to be submitted to EPA within 60 days of the change(s).

(5) *Reporting—Destruction.* Any person who purchases or receives and subsequently destroys class II controlled substances that were originally produced without expending allowances shall provide the producer or importer from whom it purchased or received the class II controlled substances with a verification that the class II controlled substances will be used in processes that result in their destruction.

(i) The destruction verification shall include the following:

(A) Identity and address of the person intending to destroy class II controlled substances;

(B) Indication of whether those class II controlled substances will be completely destroyed, as defined in §82.3, or less than completely destroyed, in which case the destruction efficiency at which such substances will be destroyed must be included;

(C) Period of time over which the person intends to destroy class II controlled substances; and

(D) Signature of the verifying person.

(ii) [Reserved]

(f) *Heels-Recordkeeping and reporting.* Any person who brings into the U.S. a rail car, tank truck, or ISO

tank containing a heel, as defined in §82.3, of class II controlled substances, must take the following actions:

- (1) Indicate on the bill of lading or invoice that the class II controlled substance in the container is a heel.
- (2) Report within 30 days of the end of the control period the quantity (in kilograms) brought into the U.S. and certify:
 - (i) That the residual quantity (in kilograms) in each shipment is no more than 10 percent of the volume of the container;
 - (ii) That the residual quantity (in kilograms) in each shipment will either:
 - (A) Remain in the container and be included in a future shipment;
 - (B) Be recovered and transformed;
 - (C) Be recovered and destroyed; or
 - (D) Be recovered for a non-emissive use.
- (3) Report on the final disposition of each shipment within 30 days of the end of the control period.

(g) *HCFC 141b exemption allowances—Reporting and recordkeeping.* (1) Any person allocated HCFC-141b exemption allowances who confers a quantity of the HCFC-141b exemption allowances to a producer or import and places an order for the production or import of HCFC-141b with a verification that the HCFC-141b will only be used for the exempted purpose and not be resold must submit semi-annual reports, due 30 days after the end of the second and fourth respectively, to the Administrator containing the following information:

- (i) Total quantity (in kilograms) HCFC-141b received during the 6 month period; and
- (ii) The identity of the supplier of HCFC-141b on a shipment-by-shipment basis during the 6 month period.

(2) Any person allocated HCFC-141b exemption allowances must keep records of letters to producers and importers conferring unexpended HCFC-141b exemption allowances for the specified control period in the notice, orders for the production or import of HCFC-141b under those letters and written verifications that the HCFC-141b was produced or imported for the express purpose of meeting HCFC-141b exemption needs in accordance with information submitted under §82.16(h), and that the quantity will not be resold.

[68 FR 2848, Jan. 21, 2003, as amended at 71 FR 41172, July 20, 2006]

Appendix A to Subpart A of Part 82—Class I Controlled Substances

Class 1 controlled substances	ODP
A. Group I:	
CFC1 ₃ -Trichlorofluoromethane (CFC-II)	1.0
CF ₂ Cl ₂ -Dichlorofluoromethane (CFC-12)	1.0
C ₂ F ₃ Cl ₃ -Trichlorotrifluoroethane (CFC-113)	0.8
C ₂ F ₄ Cl ₂ -Dichlorotetrafluoroethane (CFC-114)	1.0
C ₂ F ₅ Cl-Monochloropentafluoroethane (CFC-115)	0.6

All isomers of the above chemicals	
B. Group II:	
CF ₂ ClBr-Bromochlorodifluoromethane (Halon-1211)	3.0
CF ₃ Br-Bromotrifluoromethane (Halon-1301)	10.0
C ₂ F ₄ Br ₂ -Dibromotetrafluoroethane (Halon-2402)	6.0
All isomers of the above chemicals	
C. Group III:	
CF ₃ Cl-Chlorotrifluoromethane (CFC-13)	1.0
C ₂ FCl ₅ -(CFC-111)	1.0
C ₂ F ₂ Cl ₄ -(CFC-112)	1.0
C ₃ FCl ₇ -(CFC-211)	1.0
C ₃ F ₂ Cl ₆ -(CFC-212)	1.0
C ₃ F ₃ Cl ₅ -(CFC-213)	1.0
C ₃ F ₄ Cl ₄ -(CFC-214)	1.0
C ₃ F ₅ Cl ₃ -(CFC-215)	1.0
C ₃ F ₆ Cl ₂ -(CFC-216)	1.0
C ₃ F ₇ Cl-(CFC-217)	1.0
All isomers of the above chemicals	
D. Group IV: CCl₄-Carbon Tetrachloride	1.1
E. Group V:	
C ₂ H ₃ Cl ₃ -1,1,1 Trichloroethane (Methyl chloroform)	0.1
All isomers of the above chemical except 1,1,2-trichloroethane	
F. Group VI: CH₃Br—Bromomethane (Methyl Bromide)	0.7
G. Group VII:	
CHFBR ₂	1.00
CHF ₂ Br (HBFC-2201)	0.74
CH ₂ FBr	0.73
C ₂ HFBr ₄	0.3–0.8
C ₂ HF ₂ Br ₃	0.5–1.8
C ₂ HF ₃ Br ₂	0.4–1.6
C ₂ HF ₄ Br	0.7–1.2
C ₂ H ₂ FBr ₃	0.1–1.1
C ₂ H ₂ F ₂ Br ₂	0.2–1.5
C ₂ H ₂ F ₃ Br	0.7–1.6

$C_2H_2FBr_2$	0.1–1.7
$C_2H_3F_2Br$	0.2–1.1
C_2H_4FBr	0.07–0.1
C_3HFBr_6	0.3–1.5
$C_3HF_2Br_5$	0.2–1.9
$C_3HF_3Br_4$	0.3–1.8
$C_3HF_4Br_3$	0.5–2.2
$C_3HF_5Br_2$	0.9–2.0
C_3HF_6Br	0.7–3.3
$C_3H_2FBR_5$	0.1–1.9
$C_3H_2F_2BR_4$	0.2–2.1
$C_3H_2F_3Br_3$	0.2–5.6
$C_3H_2F_4Br_2$	0.3–7.5
$C_3H_2F_5BR$	0.9–14
$C_3H_3FBR_4$	0.08–1.9
$C_3H_3F_2Br_3$	0.1–3.1
$C_3H_3F_3Br_2$	0.1–2.5
$C_3H_3F_4Br$	0.3–4.4
$C_3H_4FBr_3$	0.03–0.3
$C_3H_4F_2Br_2$	0.1–1.0
$C_3H_4F_3Br$	0.07–0.8
$C_3H_5FBr_2$	0.04–0.4
$C_3H_5F_2Br$	0.07–0.8
C_3H_6FB	0.02–0.7
H. Group VIII:	
CH ₂ BrCl (Chlorobromomethane 0.12	

[60 FR 24986, May 10, 1995, as amended at 68 FR 42892, July 18, 2003]

Appendix B to Subpart A of Part 82—Class II Controlled Substances^a

Controlled Substance	ODP
1. Dichlorofluoromethane (HCFC-21)	0.04
2. Monochlorodifluoromethane (HCFC-22)	0.055
3. Monochlorofluoromethane (HCFC-31)	0.02

4. Tetrachlorofluoroethane (HCFC-121)	0.01–0.04
5. Trichlorodifluoroethane (HCFC-122)	0.02–0.08
6. Dichlorotrifluoroethane (HCFC-123)	0.02
7. Monochlorotetrafluoroethane (HCFC-124)	0.022
8. Trichlorofluoroethane (HCFC-131)	0.007–0.05
9. Dichlorodifluoroethane (HCFC-132)	0.008–0.05
10. Monochlorotrifluoroethane (HCFC-133)	0.02–0.06
11. Dichlorofluoroethane (HCFC-141b)	0.11
12. Monochlorodifluoroethane (HCFC-142b)	0.065
13. Chlorofluoroethane (HCFC-151)	0.003–0.005
14. Hexachlorofluoropropane (HCFC-221)	0.015–0.07
15. Pentachlorodifluoropropane (HCFC-222)	0.01–0.09
16. Tetrachlorotrifluoropropane (HCFC-223)	0.01–0.08
17. Trichlorotetrafluoropropane (HCFC-224)	0.01–0.09
18. Dichloropentafluoropropane (HCFC-225ca)	0.025
19. Dichloropentafluoropropane (HCFC-225cb)	0.033
20. Monochlorohexafluoropropane (HCFC-226)	0.02–0.10
21. Pentachlorofluoropropane (HCFC-231)	0.05–0.09
22. Tetrachlorodifluoropropane (HCFC-232)	0.008–0.10
23. Trichlorotrifluoropropane (HCFC-233)	0.007–0.23
24. Dichlorotetrafluoropropane (HCFC-234)	0.01–0.28
25. Monochloropentafluoropropane (HCFC-235)	0.03–0.52
26. Tetrachlorofluoropropane (HCFC-241)	0.004–0.09
27. Trichlorodifluoropropane (HCFC-242)	0.005–0.13
28. Dichlorotrifluoropropane (HCFC-243)	0.007–0.12
29. Monochlorotetrafluoropropane (HCFC-244)	0.009–0.14
30. Trichlorofluoropropane (HCFC-251)	0.001–0.01
31. Dichlorodifluoropropane (HCFC-252)	0.005–0.04
32. Monochlorotrifluoropropane (HCFC-253)	0.003–0.03
33. Dichlorofluoropropane (HCFC-261)	0.002–0.02
34. Monochlorodifluoropropane (HCFC-262)	0.002–0.02
35. Monochlorofluoropropane (HCFC-271)	0.001–0.03

^aAccording to Annex C of the Montreal Protocol, "Where a range of ODPs is indicated, the highest value in that range shall be used for the purposes of the Protocol. The ODPs listed as a single value have been determined from calculations based on laboratory measurements. Those listed as a range are based on estimates and are less certain. The range pertains to an isomeric group. The upper value is the estimate of the ODP of the isomer with the highest ODP, and the lower value is the estimate of the ODP of the isomer with the lowest ODP."

[68 FR 2859, Jan. 21, 2003]

Appendix C to Subpart A of Part 82—Parties to the Montreal Protocol, and Nations Complying With, But Not Parties To, The Protocol

Annex 1 to Appendix C of Subpart A—Parties to the Montreal Protocol (as of January 29, 2003)

The check mark [✓] means the particular country ratified the Protocol or the specific Amendment package. Amendment packages are identified by the name of the city where the amendment package was negotiated and agreed. Updated lists of Parties to the Protocol and the Amendments can be located at: <http://www.unep.org/ozone/ratif.shtml>.

Foreign state	Montreal protocol	London amendments	Copenhagen amendments	Montreal amendments	Beijing amendments
Albania	✓				
Algeria	✓	✓	✓		
Angola	✓				
Antigua and Barbuda	✓	✓	✓	✓	
Argentina	✓	✓	✓	✓	
Armenia	✓				
Australia	✓	✓	✓	✓	
Austria	✓	✓	✓	✓	
Azerbaijan	✓	✓	✓	✓	
Bahamas	✓	✓	✓		
Bahrain	✓	✓	✓	✓	
Bangladesh	✓	✓	✓	✓	
Barbados	✓	✓	✓	✓	✓
Belarus	✓	✓			
Belgium	✓	✓	✓		
Belize	✓	✓	✓		
Benin	✓	✓	✓		
Bolivia	✓	✓	✓	✓	
Bosnia and Herzegovina	✓				
Botswana	✓	✓	✓		
Brazil	✓	✓	✓		
Brunei Darussalam	✓				
Bulgaria	✓	✓	✓	✓	✓
Burkina Faso	✓	✓	✓	✓	✓
Burundi	✓	✓	✓	✓	✓
Cambodia	✓				
Cameroon	✓	✓	✓		
Canada	✓	✓	✓	✓	✓
Cape Verde	✓	✓	✓	✓	
Central African Republic	✓				

Chad	✓	✓	✓	✓	
Chile	✓	✓	✓	✓	✓
China	✓	✓			
Colombia	✓	✓	✓		
Comoros	✓	✓	✓	✓	✓
Congo	✓	✓	✓	✓	✓
Congo, Democratic Republic of	✓	✓	✓		
Costa Rica	✓	✓	✓		
Cote d'Ivoire	✓	✓			
Croatia	✓	✓	✓	✓	✓
Cuba	✓	✓	✓		
Cyprus	✓	✓			
Czech Republic	✓	✓	✓	✓	✓
Denmark	✓	✓	✓		
Djibouti	✓	✓	✓	✓	
Dominica	✓	✓			
Dominican Republic	✓	✓	✓		
Ecuador	✓	✓	✓		
Egypt	✓	✓	✓	✓	
El Salvador	✓	✓	✓	✓	
Estonia	✓	✓	✓		
Ethiopia	✓				
European Community	✓	✓	✓	✓	✓
Federated States of Micronesia	✓	✓	✓	✓	✓
Fiji	✓	✓	✓		
Finland	✓	✓	✓	✓	✓
France	✓	✓	✓		
Gabon	✓	✓	✓	✓	✓
Gambia	✓	✓			
Georgia	✓	✓	✓	✓	
Germany	✓	✓	✓	✓	✓
Ghana	✓	✓	✓		
Greece	✓	✓	✓		
Grenada	✓	✓	✓	✓	
Guatemala	✓	✓	✓	✓	✓

Guinea	✓	✓			
Guinea Bissau	✓	✓	✓	✓	✓
Guyana	✓	✓	✓	✓	
Haiti	✓	✓	✓	✓	
Honduras	✓	✓	✓		
Hungary	✓	✓	✓	✓	✓
Iceland	✓	✓	✓	✓	
India	✓	✓			
Indonesia	✓	✓	✓		
Iran, Islamic	✓	✓	✓	✓	
Ireland	✓	✓	✓		
Israel	✓	✓	✓		
Italy	✓	✓	✓	✓	
Jamaica	✓	✓	✓		
Japan	✓	✓	✓	✓	✓
Jordan	✓	✓	✓	✓	✓
Kazakhstan	✓	✓			
Kenya	✓	✓	✓	✓	
Kiribati	✓				
Korea, Democratic People's Republic of	✓	✓	✓	✓	✓
Korea, Republic of	✓	✓	✓	✓	
Kuwait	✓	✓	✓		
Kyrgyzstan	✓				
Lao, People's Democratic Republic	✓				
Latvia	✓	✓	✓	✓	
Lebanon	✓	✓	✓	✓	
Lesotho	✓				
Liberia	✓	✓	✓		
Libyan Arab Jamahiriya	✓	✓			
Liechtenstein	✓	✓	✓		
Lithuania	✓	✓	✓		
Luxembourg	✓	✓	✓	✓	✓
Madagascar	✓	✓	✓	✓	✓
Malawi	✓	✓	✓		

Malaysia	✓	✓	✓	✓	✓
Maldives	✓	✓	✓	✓	✓
Mali	✓	✓			
Malta	✓	✓			
Marshall Islands	✓	✓	✓		
Mauritania	✓				
Mauritius	✓	✓	✓		
Mexico	✓	✓	✓		
Moldova	✓	✓	✓		
Monaco	✓	✓	✓	✓	
Mongolia	✓	✓	✓	✓	
Morocco	✓	✓	✓		
Mozambique	✓	✓	✓		
Myanmar	✓	✓			
Namibia	✓	✓			
Nauru	✓				
Nepal	✓	✓			
Netherlands	✓	✓	✓	✓	✓
New Zealand	✓	✓	✓	✓	✓
Nicaragua	✓	✓	✓		
Niger	✓	✓	✓	✓	
Nigeria	✓	✓	✓	✓	
Norway	✓	✓	✓	✓	✓
Oman	✓	✓	✓		
Pakistan	✓	✓	✓		
Palau	✓	✓	✓	✓	✓
Panama	✓	✓	✓	✓	✓
Papua New Guinea	✓	✓			
Paraguay	✓	✓	✓	✓	
Peru	✓	✓	✓		
Philippines	✓	✓	✓		
Poland	✓	✓	✓	✓	
Portugal	✓	✓	✓		
Qatar	✓	✓	✓		
Romania	✓	✓	✓	✓	
Russian Federation	✓	✓			
Rwanda	✓				
Saint Kitts &	✓	✓	✓	✓	

Nevis					
Saint Lucia	✓	✓	✓	✓	✓
Saint Vincent and the Grenadines	✓	✓	✓		
Samoa	✓	✓	✓	✓	✓
Sao Tome and Principe	✓	✓	✓	✓	✓
Saudi Arabia	✓	✓	✓		
Senegal	✓	✓	✓	✓	
Seychelles	✓	✓	✓	✓	✓
Sierra Leone	✓	✓	✓	✓	✓
Singapore	✓	✓	✓	✓	
Slovakia	✓	✓	✓	✓	✓
Slovenia	✓	✓	✓	✓	✓
Solomon Island	✓	✓	✓	✓	
Somalia	✓	✓	✓	✓	✓
South Africa	✓	✓	✓		
Spain	✓	✓	✓	✓	✓
Sri Lanka	✓	✓	✓	✓	✓
Sudan	✓	✓	✓		
Suriname	✓				
Swaziland	✓				
Sweden	✓	✓	✓	✓	✓
Switzerland	✓	✓	✓	✓	✓
Syrian Arab Republic	✓	✓	✓	✓	
Tajikistan	✓	✓			
Tanzania, United Republic of	✓	✓	✓	✓	✓
Thailand	✓	✓	✓		
The Former Yugoslav Republic of Macedonia	✓	✓	✓	✓	✓
Togo	✓	✓	✓	✓	✓
Tonga	✓				
Trinidad and Tobago	✓	✓	✓	✓	
Tunisia	✓	✓	✓	✓	
	✓	✓	✓		

Turkey					
Turkmenistan	✓	✓			
Tuvalu	✓	✓	✓	✓	
Uganda	✓	✓	✓	✓	
Ukraine	✓	✓	✓		
United Arab Emirates	✓				
United Kingdom	✓	✓	✓	✓	✓
United States of America	✓	✓	✓		
Uruguay	✓	✓	✓	✓	
Uzbekistan	✓	✓	✓		
Vanuatu	✓	✓	✓		
Venezuela	✓	✓	✓	✓	
Viet Nam	✓	✓	✓		
Yemen	✓	✓	✓	✓	
Yugoslavia	✓				
Zambia	✓	✓			

Annex 2 to Appendix C of Subpart A—Nations Complying with, But Not Parties to, the Protocol [Reserved]

Annex 3 to Appendix C of Subpart A: Nations that are Parties to the Montreal Protocol that have not yet Ratified all applicable Amendments to the Protocol but have Notified the Ozone Secretariat and Properly Submitted Supporting Documentation in Accordance with the Requirements of Decision XV/3.

Non-article 5 parties	Party to the Copenhagen amendment	Party to the Beijing Amendment	Parties that have submitted data in accordance with Dec. XV/3, para 1 (c)(iii)		
			1(c)(ii)	1(c)(ii), Article 2, 2A–2G	1(c)(ii), Article 4
Australia	Yes	No	Yes	Yes	Yes
Austria	Yes	No			
Azerbaijan	Yes	No			
Belarus	No	No			
Belgium	Yes	No			
Bulgaria	Yes	Yes			
Canada	Yes	Yes			
Czech Republic	Yes	Yes			
Denmark	Yes	Yes			

Estonia	Yes	No			
European Community	Yes	Yes			
Finland	Yes	Yes			
France	Yes	Yes			
Germany	Yes	Yes			
Greece	Yes	No	Yes	Yes	Yes
Hungary	Yes	Yes			
Iceland	Yes	Yes			
Ireland	Yes	No			
Israel	Yes	No			
Italy	Yes	No	Yes	Yes	Yes
Japan	Yes	Yes			
Kazakhstan	No	No	Yes	Yes	Yes
Latvia	Yes	No			
Liechtenstein	Yes	Yes			
Lithuania	Yes	No	Yes		
Luxembourg	Yes	Yes			
Monaco	Yes	Yes			
Netherlands	Yes	Yes			
New Zealand	Yes	Yes			
Norway	Yes	Yes			
Poland	Yes	No	Yes	Yes	Yes
Portugal	Yes	No	Yes	Yes	Yes
Russian Federation	No	No			
Slovakia	Yes	Yes			
Slovenia	Yes	Yes			
Spain	Yes	Yes			
Sweden	Yes	Yes			
Switzerland	Yes	Yes			
Tajikistan	No	No			
Turkmenistan	No	No			
Ukraine	Yes	No			
United Kingdom	Yes	Yes			
United States of America	Yes	Yes			
Uzbekistan	Yes	No			

Annex 4 to Appendix C of Subpart A: Nations That Are Parties to the Montreal Protocol and Are Operating Under Article 5(1)

List of Article 5 Parties

List of Parties Classified as Operating Under Article 5 of the Montreal Protocol

1. Albania
2. Algeria
3. Angola
4. Antigua and Barbuda
5. Argentina
6. Armenia
7. Bahamas
8. Bahrain
9. Bangladesh
10. Barbados
11. Belize
12. Benin
13. Bolivia
14. Bosnia and Herzegovina
15. Botswana
16. Brazil
17. Brunei Darussalam
18. Burkina Faso
19. Burundi
20. Cambodia
21. Cameroon
22. Central African Republic
23. Chad
24. Chile
25. China
26. Colombia

27. Comoros
28. Congo
29. Congo, Democratic Republic of
30. Costa Rica
31. Côte d'Ivoire
32. Croatia
33. Cuba
34. Cyprus
35. Djibouti
36. Dominica
37. Dominican Republic
38. Ecuador
39. Egypt
40. El Salvador
41. Ethiopia
42. Federated States of Micronesia
43. Fiji
44. Gabon
45. Gambia
47. Ghana
48. Grenada
49. Guatemala
50. Guinea
51. Guyana
52. Haiti
53. Honduras
54. India
55. Indonesia

56. Iran, Islamic Republic of
57. Jamaica
58. Jordan
59. Kenya
60. Kiribati
61. Korea, Democratic People's Republic of
63. Kuwait
64. Kyrgyzstan
65. Lao People's Democratic Republic
66. Lebanon
67. Lesotho
68. Liberia
69. Libyan Arab Jamahiriya
70. Madagascar
71. Malawi
72. Malaysia
73. Maldives
74. Mali
75. Malta
76. Marshall Islands
77. Mauritania
78. Mauritius
79. Mexico
80. Moldova
81. Mongolia
82. Morocco
83. Mozambique
84. Myanmar

85. Namibia
86. Nauru
87. Nepal
88. Nicaragua
89. Niger
90. Nigeria
91. Oman
92. Pakistan
93. Palau
94. Panama
95. Papua New Guinea
96. Paraguay
97. Peru
98. Philippines
99. Qatar
100. Romania
101. Rwanda
102. Saint Kitts and Nevis
103. Saint Lucia
104. Saint Vincent and the Grenadines
105. Samoa
106. Saudi Arabia
107. Senegal
108. Serbia and Montenegro
109. Seychelles
110. Sierra Leone
111. Singapore
112. Solomon Islands

113. Somalia
114. South Africa
115. Sri Lanka
116. Sudan
117. Suriname
118. Swaziland
119. Syrian Arab Republic
120. Tanzania, United Republic of
121. Thailand
122. The Former Yugoslav Republic of Macedonia
123. Togo
124. Tonga
125. Trinidad and Tobago
126. Tunisia
127. Turkey
128. Tuvalu
129. Uganda
130. United Arab Emirates
131. Uruguay
132. Vanuatu
133. Venezuela
134. Viet Nam
135. Yemen
136. Zambia
137. Zimbabwe

List of Parties Temporarily Classified as Operating Under Article 5 of the Montreal Protocol

1. Cape Verde
2. Cook Islands

- 3. Guinea Bissau
- 4. Niue
- 5. Sao Tome and Principe

[68 FR 43936, July 25, 2003, as amended at 69 FR 34031, June 17, 2004]

Appendix D to Subpart A of Part 82—Harmonized Tariff Schedule Description of Products That May Contain Controlled Substances in Appendix A, Class I, Groups I and II

This Appendix is based on information provided by the Ozone Secretariat of the United Nations Ozone Environment Programme.**The Appendix lists available U.S. harmonized tariff schedule codes identifying headings and subheadings for Annex D products that may contain controlled substances.

***“A Note Regarding the Harmonized System Code Numbers for the Products Listed in Annex D.” Adopted by Decision IV/15 paragraph 3, of the Fourth Meeting of the Parties in Copenhagen, 23–25 November, 1992.

The Harmonized Tariff Schedule of the United States uses an enumeration system to identify products imported and exported to and from the U.S. This system relies on a four digit heading, a four digit subheading and additional two digit statistical suffix to characterize products. The United States uses the suffix for its own statistical records and analyses. This Appendix lists only headings and subheadings.

While some can be readily associated with harmonized system codes, many products cannot be tied to HS classifications unless their exact composition and the presentation are known. It should be noted that the specified HS classifications represent the most likely headings and subheadings which may contain substances controlled by the Montreal Protocol. The codes given should only be used as a starting point; further verification is needed to ascertain whether or not the products actually contain controlled substances.

Category 1. Automobile and Truck Air Conditioning Units (whether incorporated in vehicles or not)

There are no separate code numbers for air conditioning units specially used in automobiles and trucks. Although a code has been proposed for car air conditioners, it is not yet officially listed in the Harmonized Tariff Schedule (see category 2). The following codes apply to the vehicles potentially containing air conditioning units.

Heading/Subheading	Article Description
8701.(10, 20, 30, 90) ***	Tractors.
8702	Public-transport type passenger motor vehicles.
8702.10	With compression-ignition internal-combustion piston engine (diesel or semi-diesel).
8702.90	Other.
8703	Motor cars and other motor vehicles principally designed for the transport of persons (other than those of heading 8702), including station wagons and racing cars.
8703.10	Vehicles specially designed for traveling on snow; golf carts and similar vehicles; includes subheading 10.10 and 10.50.
8703.(21, 22, 23, 24)	Other vehicles, with spark-ignition internal combustion

	reciprocating engines.
8703.(31, 32, 33, 90)	Other vehicles, with compression-ignition internal combustion piston engine (diesel or semi-diesel).
8704	Motor vehicles for the transport of goods.
8704.10.(10, 50)	Dumpers designed for off-highway use.
8704.(21, 22, 23)	Other, with compression-ignition internal combustion piston engine (diesel or semi-diesel).
8704.(31, 32, 90)	Other, with compression-ignition internal combustion piston engine.
8705	Special purpose motor vehicles, other than those principally designed for the transport of persons or goods (for example, wreckers, mobile cranes, fire fighting vehicles, concrete mixers, road sweepers, spraying vehicles, mobile workshops, mobile radiological units).
8705.10	Crane lorries.
8705.20	Mobile drilling derricks.
8705.30	Fire fighting vehicles.
8705.90	Other.

***At this time vehicle air conditioning units are considered components of vehicles or are classified under the general category for air conditioning and refrigeration equipment. Vehicles containing air conditioners are therefore considered products containing controlled substances.

Category 2. Domestic and Commercial Refrigeration and Air Conditioning/Heat Pump Equipment

Domestic and commercial air conditioning and refrigeration equipment fall primarily under headings 8415 and 8418.

Heading/Subheading	Article Description
8415	Air conditioning machines, comprising a motor-driven fan and elements for changing the temperature and humidity, including those machines in which the humidity cannot be separately regulated.
8415.20	Proposed code for air conditioning of a kind used for persons, in motor vehicles.
8415.10.00	A/C window or wall types, self-contained.
8415.81.00	Other, except parts, incorporating a refrigerating unit and a valve for reversal of the cooling/heat cycle.
8415.82.00	Other, incorporating a refrigerating unit—
	Self-contained machines and remote condenser type air conditioners (not for year-round use).
	Year-round units (for heating and cooling).
	Air Conditioning evaporator coils.
	Dehumidifiers.
	Other air conditioning machines incorporating a

	refrigerating unit.
8415.83	Automotive air conditioners.
8418	Refrigerators, freezers and other refrigerating or freezing equipment, electric or other; heat pumps, other than air conditioning machines of heading 8415; parts thereof.
8418.10.00	Combined refrigerator-freezers, fitted with separate external doors.
8418.21.00	Refrigerators, household type, Compression type.
8418.22.00	Absorption type, electrical.
8418.29.00	Other.
8418.30.00	Freezers of the chest type.
8418.40	Freezers of the upright type.
8418.50.0040	Other refrigerating or freezing chests, cabinets, display counters, showcases and similar refrigerating or freezing furniture.
8418.61.00	Other refrigerating or freezing equipment; heat pumps.
8418.69	Other—
	Icemaking machines.
	Drinking water coolers, self-contained.
	Soda fountain and beer dispensing equipment.
	Centrifugal liquid chilling refrigerating units.
	Absorption liquid chilling units.
	Reciprocating liquid chilling units.
	Other refrigerating or freezing equipment (household or other).
8479.89.10	Dehumidifiers (other than those under 8415 or 8424 classified as "machines and mechanical appliances having individual functions, not specified or included elsewhere").

Category 3. Aerosol Products

An array of different products use controlled substances as aerosols and in aerosol applications. Not all aerosol applications use controlled substances, however. The codes given below represent the most likely classifications for products containing controlled substances. The product codes listed include****:

****Other categories of products that may contain controlled substances are listed below. EPA is currently working to match them with appropriate codes. They include: coatings and electronic equipment (e.g., electrical motors), coatings or cleaning fluids for aircraft maintenance, mold release agents (e.g. for production of plastic or elastomeric materials), water and oil repellent (potentially under HS 3402), spray undercoats (potentially under "paints and varnishes"), spot removers, brake cleaners, safety sprays (e.g., mace cans), animal repellent, noise horns (e.g., for use on boats), weld inspection developers, freezants, gum removers, intruder alarms, tire inflators, dusters (for electronic and non-electronic applications), spray shoe polish, and suede protectors.

- varnishes
- perfumes
- preparations for use on hair
- preparations for oral and dental hygiene
- shaving preparations
- personal deodorants, bath preparations
- prepared room deodorizers
- soaps
- lubricants
- polishes and creams
- explosives
- insecticides, fungicides, herbicides, disinfectants
- arms and ammunition
- household products such as footwear or leather polishes
- other miscellaneous products

Heading/Subheading	Article Description
3208	Paints and varnishes***** (including enamels and lacquers) based on synthetic polymers of chemically modified natural polymers, dispersed or dissolved in a non-aqueous medium.
3208.10	Based on polyesters.
3208.20	Based on acrylic or vinyl polymers.
3208.90	Other.
3209	Paints and varnishes (including enamels and lacquers) based on synthetic polymers or chemically modified natural polymers, dispersed or dissolved in an aqueous medium.
3209.10	Based on acrylic or vinyl polymers.
3209.90	Other.
3210.00	Other paints and varnishes (including enamels, lacquers and distempers) and prepared water pigments of a kind used for finishing leather.
3212.90	Dyes and other coloring matter put up in forms or packings for retail sale.
3303.00	Perfumes and toilet waters.

3304.30	Manicure or pedicure preparations.
3305.10	Shampoos.
3305.20	Preparations for permanent waving or straightening.
3305.30	Hair lacquers.
3305.90	Other hair preparations.
3306.10	Dentrifices.
3306.90	Other dental (this may include breath sprays).
3307.10	Pre-shave, shaving or after-shave preparations.
3307.20	Personal deodorants and antiperspirants.
3307.30	Perfumed bath salts and other bath preparations.
3307.49	Other (this may include preparations for perfuming or deodorizing rooms, including odoriferous preparations used during religious rites, whether or not perfumed or having disinfectant properties).
3307.90	Other (this may include depilatory products and other perfumery, cosmetic or toilet preparations, not elsewhere specified or included)
3403	Lubricating preparations (including cutting-oil preparations, bolt or nut release preparations, anti-rust or anti-corrosion preparations and mould release preparations, based on lubricants), and preparations of a kind used for the oil or grease treatment of textile materials, leather, fur skins or other materials, but excluding preparations containing, as basic constituents, 70 percent or more by weight of petroleum oils or of oils obtained from bituminous minerals.
3402	Organic surface-active agents (other than soap); surface-active preparations, washing preparations and cleaning operations, whether or not containing soap, other than those of 3401.
3402.20	Preparations put up for retail sale.
3402.19	Other preparations containing petroleum oils or oils obtained from bituminous minerals.
3403	Lubricating preparations consisting of mixtures containing silicone greases or oils, as the case may be.
2710.00	Preparations not elsewhere specified or included, containing by weight 70 percent or more of petroleum oils or of oils obtained from bituminous minerals, these oils being the basic constituents of the preparations.
3403.11	Lubricants containing petroleum oils or oils obtained from bituminous minerals used for preparations from the treatment of textile materials, leather, fur skins or

	other materials.
3403.19	Other preparations containing petroleum oils or oils obtained from bituminous minerals.
3405	Polishes and creams, for footwear, furniture, floors, coachwork, glass or metal, scouring pastes and powders and similar preparations excluding waxes of heading 3404.
3405.10	Polishes and creams for footwear or leather.
3405.20	Polishes for wooden furniture, floors or other woodwork.
36	Explosives.
3808	Insecticides, rodenticides, fungicides, herbicides, anti-sprouting products and plant-growth regulators, disinfectants and similar products, put up in forms or packings for retail sale or as preparations or articles (for example, sulphur-treated bands, wicks and candles, and fly papers).
3808.10	Insecticides.
3808.20	Fungicides.
3808.30	Herbicides, anti-sprouting products and plant growth regulators.
3808.40	Disinfectants.
3808.90	Other insecticides, fungicides.
3809.10	Finishing agents, dye carriers to accelerate the dyeing or fixing of dye-stuffs and other products and preparations (for example, dressings and mordants) of a kind used in the textile, paper, leather or like industries, not elsewhere specified or included, with a basis of amylic substances.
3814	Organic composite solvents and thinners (not elsewhere specified or included) and the prepared paint or varnish removers.
3910	Silicones in primary forms.
9304	Other arms (for example, spring, air or gas guns and pistols, truncheons), excluding those of heading No. 93.07. Thus, aerosol spray cans containing tear gas may be classified under this subheading.
0404.90	Products consisting of natural milk constituents, whether or not containing added sugar or other sweetening matter, not elsewhere specified or included.
1517.90	Edible mixtures or preparations of animal or vegetable fats or oils or of fractions of different fats or oils of this chapter, other than edible fats or oils or their fractions of heading No. 15.16.

2106.90	Food preparations not elsewhere specified or included.
---------	--

****Although paints do not generally use contain controlled substances, some varnishes use CFC 113 and 1,1,1, trichlorethane as solvents.

Category 4. Portable Fire Extinguishers

Heading/Subheading	Article Description
8424	Mechanical appliances (whether or not hand operated) for projecting, dispersing, or spraying liquids or powders; fire extinguishers whether or not charged, spray guns and similar appliances; steam or sand blasting machines and similar jet projecting machines.
8424.10	Fire extinguishers, whether or not charged.

Category 5. Insulation Boards, Panels and Pipe Covers

These goods have to be classified according to their composition and presentation. For example, if the insulation materials are made of polyurethane, polystyrene, polyolefin and phenolic plastics, then they may be classified Chapter 39, for "Plastics and articles thereof". The exact description of the products at issue is necessary before a classification can be given.*****

*****This category may include insulating board for building panels and windows and doors. It also includes rigid appliance insulation for pipes, tanks, trucks, trailers, containers, train cars & ships, refrigerators, freezers, beverage vending machines, bulk beverage dispensers, water coolers and heaters and ice machines.

Heading/Subheading	Article Description
3917.21 to 3917.39	Tubes, pipes and hoses of plastics.
3920.10 to 3920.99	Plates, sheets, film, foil and strip made of plastics, non-cellular and not reinforced, laminated, supported or similarly combined with other materials.
3921.11 to 3921.90	Other plates, sheets, film, foil and strip, made of plastics.
3925.90	Builders' ware made of plastics, not elsewhere specified or included.
3926.90	Articles made of plastics, not elsewhere specified or included.

Category 6. Pre-Polymers

According to the Explanatory Notes to the Harmonized Commodity Description and Coding System, "prepolymers are products which are characterized by some repetition of monomer units although they may contain unreacted monomers. Prepolymers are not normally used as such but are intended to be transformed into higher molecular weight polymers by further polymerization. Therefore the term does not cover finished products, such as di-isobutylenes or mixed polyethylene glycols with very low molecular weight. Examples are epoxides based with epichlorohydrin, and polymeric isocyanates."

Heading/Subheading	Article Description
---------------------------	----------------------------

3901	Pre-polymers based on ethylene (in primary forms).
3902	Pre-polymers based on propylene or other olefins (in primary forms).
3903, 3907, 3909	Pre-polymers based on styrene (in primary forms), epoxide and phenols.

Appendix E to Subpart A of Part 82—Article 5 Parties

Algeria, Antigua and Barbuda, Argentina, Bahamas, Bahrain, Bangladesh, Barbados, Benin, Bolivia, Bosnia and Hersegovina, Botswana, Brazil, Brunei Darussalam, Burkina Faso, Cameroon, Central African Republic, Chad, Chile, China, Colombia, Comoros, Congo, Costa Rica, Cote d'Ivoire, Croatia, Cuba, Dominica, Dominican Republic, Ecuador, Egypt, El Salvador, Ethiopia, Fiji, Gabon, Gambia, Ghana, Grenada, Guatemala, Guinea, Guyana, Honduras, India, Indonesia, Iran, Jamaica, Jordan, Kenya, Kiribati, Lebanon, Lesotho, Libyan Arab Jamahiriya, Macadonia, Malawi, Malaysia, Maldives, Mali, Malta, Mauritania, Mauritius, Mexico, Mozambique, Myranmar, Namibia, Nepal, Nicaragua, Niger, Nigeria, Pakistan, Panama, Papua New Guinea, Paraguay, Peru, Philippines, Republic of Korea, Romania, Saint Kitts and Nevis, Saint Lucia, Saudi Arabia, Senegal, Seychelles, Singapore, Solomon Islands, Somoa, Sri Lanka, Sudan, Swaziland, Syrian Arab Republic, Tanzania, Thailand, Togo, Trinidad and Tobago, Tunisia, Turkey, Uganda, Uruguay, Vanuatu, Venezuela, Viet Nam, Yugoslavia, Zaire, Zambia, Zimbabwe.

Appendix F to Subpart A of Part 82—Listing of Ozone-Depleting Chemicals

Controlled substance	ODP	AT L	CLP	BLP
A. Class I:				
1. Group I:				
CFCl ₃ -Trichlorofluoromethane (CFC-11)	1.0	60.0	1.0	0.00
CF ₂ Cl ₂ -Dichlorodifluoromethane (CFC-12)	1.0	120.0	1.5	0.00
C ₂ F ₃ Cl ₃ -Trichlorotrifluoroethane (CFC-113)	0.8	90.0	1.11	0.00
C ₂ F ₄ Cl ₂ -Dichlorotetrafluoroethane (CFC-114)	1.0	200.00	1.8	0.00
C ₂ F ₅ Cl-Monochloropentafluoroethane (CFC-115)	0.6	400.0	2.0	0.00
All isomers of the above chemicals	[Reserved]			
2. Group II:				
CF ₂ ClBr-Bromochlorodifluoromethane (Halon-1211)	3.0	12	0.06	0.13
		-18	-.08	-.03
CF ₃ Br-Bromotrifluoromethane (Halon-1301)	10.0	72	0.00	1.00

		-107		
C ₂ F ₄ Br ₂ - Dibromotetrafluoroethane (Halon-2402)	6.0	23	0.00	0.30
		-28		-.37
All isomers of the above chemicals	[Reserved]			
3. Group III:				
CF ₃ Cl-Chlorotrifluoromethane (CFC-13)	1.0	120	0.88	0.00
	-250	-1.83		
C ₂ FCl ₅ - (CFC-111)	1.0	60	1.04	0.00
	-90	-1.56		
C ₂ F ₂ Cl ₄ - (CFC-112)	1.0	60	0.90	0.00
	-90	-1.35		
C ₃ FCl ₇ - (CFC-211)	1.0	100	1.76	0.00
	-500	-8.81		
C ₃ F ₂ Cl ₆ - (CFC-212)	1.0	100	1.60	0.00
	-500	-7.98		
C ₃ F ₃ Cl ₅ - (CFC-213)	1.0	100	1.41	0.00
	-500	-7.06		
C ₃ F ₄ Cl ₄ - (CFC-214)	1.0	100	1.20	0.00
	-500	-6.01		
C ₃ F ₅ Cl ₃ - (CFC-215)	1.0	100	0.96	0.00
	-500	-4.82		
C ₃ F ₆ Cl ₂ - (CFC-216)	1.0	100	0.69	0.00
	-500	-3.45		
C ₃ F ₇ Cl- (CFC-217)	1.0	100	0.37	0.00
	-500	-1.87		
All isomers of the above chemicals	[Reserved]			
4. Group IV:				
CCl ₄ -Carbon Tetrachloride	1.1	50.0	1.0	0.00
5. Group V:				
C ₂ H ₃ Cl ₃ -1,1,1 Trichloroethane (Methyl chloroform)	0.1	6.3	0.11	0.00
All isomers of the above chemical except 1,1,2- trichloroethane	[Reserved]			

6. Group VI:			
CH ₃ Br-Bromomethane (Methyl Bromide)	0.7		[Reserved]
7. Group VII:			
CH ₂ FBr ₂	1.00		[Reserved]
CHF ₂ Br-(HBFC-22B1)	0.74		[Reserved]
CH ₂ FBr	0.73		[Reserved]
C ₂ HFBr ₄	0.3-0.8		[Reserved]
C ₂ HF ₂ Br ₃	0.5-1.8		[Reserved]
C ₂ HF ₃ Br ₂	0.4-16		[Reserved]
C ₂ HF ₄ Br	0.7-1.2		[Reserved]
C ₂ H ₂ FBr ₃	0.1-1.1		[Reserved]
C ₂ H ₂ F ₂ Br ₂	0.2-1.5		[Reserved]
C ₂ H ₂ F ₃ Br	0.7-1.6		[Reserved]
C ₂ H ₃ FBr ₂	0.1-1.7		[Reserved]
C ₂ H ₃ F ₂ Br	0.2-1.1		[Reserved]
C ₂ H ₄ FBr	0.07-0.1		[Reserved]
C ₃ HFBr ₆	0.3-1.5		[Reserved]
C ₃ HF ₂ Br ₅	0.2-1.9		[Reserved]
C ₃ HF ₃ Br ₄	0.3-1.8		[Reserved]
C ₃ HF ₄ Br ₃	0.5-2.2		[Reserved]
C ₃ HF ₅ Br ₂	0.9-2.0		[Reserved]
C ₃ HF ₆ Br	0.7-3.3		[Reserved]
C ₃ H ₂ FBr ₅	0.1-1.9		[Reserved]
C ₃ H ₂ F ₂ Br ₄	0.2-2.1		[Reserved]
C ₃ H ₂ F ₃ Br ₃	0.2-5.6		[Reserved]
C ₃ H ₂ F ₄ Br ₂	0.3-7.5		[Reserved]
C ₃ H ₂ F ₅ Br	0.9-1.4		[Reserved]
C ₃ H ₃ FBr ₄	0.08-1.9		[Reserved]
C ₃ H ₃ F ₂ Br ₃	0.1-3.1		[Reserved]
C ₃ H ₃ F ₃ Br ₂	0.1-2.5		[Reserved]
C ₃ H ₃ F ₄ Br	0.3-4.4		[Reserved]
C ₃ H ₄ FBr ₃	0.03-0.3		[Reserved]

$C_3H_4F_2Br_2$	0.1-1.0		[Reserved]	
$C_3H_4F_3Br$	0.07-0.8		[Reserved]	
$C_3H_5FBr_2$	0.04-0.4		[Reserved]	
$C_3H_5F_2Br$	0.07-0.8		[Reserved]	
C_3H_6FB	0.02-0.7		[Reserved]	
8. Group VIII:				
CH_2BrCl (Chlorobromomethane)	0.12		[Reserved]	
B. Class II:				
$CHFCl_2$ -Dichlorofluoromethane (HCFC-21)	[Reserved]	2.1	0.03	0.00
CHF_2Cl -Chlorodifluoromethane (HCFC-22)	0.05	15.3	0.14	0.00
CH_2FCl -Chlorofluoromethane (HCFC-31)	[Reserved]	1.44	0.02	0.00
C_2HFCl_4 - (HCFC-121)	[Reserved]	0.6	0.01	0.00
$C_2HF_2Cl_3$ - (HCFC-122)	[Reserved]	1.4	0.02	0.00
$C_2HF_3Cl_2$ - (HCFC-123)	0.02	1.6	0.016	0.00
C_2HF_4Cl - (HCFC-124)	0.02	6.6	0.04	0.00
$C_2H_2FCl_3$ - (HCFC-131)	[Reserved]	4.0	0.06	0.00
$C_2H_2F_2Cl_2$ - (HCFC-132b)	[Reserved]	4.2	0.05	0.00
$C_2H_2F_3Cl$ - (HCFC-133a)	[Reserved]	4.8	0.03	0.00
$C_2H_3FCl_2$ - (HCFC-141b)	0.12	7.8	0.10	0.00
$C_2H_3F_2Cl$ - (HCFC-142b)	0.06	19.1	0.14	0.00
C_3HFCl_6 - (HCFC-221)	[Reserved]			0.00
$C_3HF_2Cl_5$ - (HCFC-222)	[Reserved]			0.00
$C_3HF_3Cl_4$ - (HCFC-223)	[Reserved]			0.00
$C_3HF_4Cl_3$ - (HCFC-224)	[Reserved]			0.00
$C_3HF_5Cl_2$ - (HCFC-225ca)	[Reserved]	1.5	0.01	0.00
		-1.7		
(HCFC-225cb)	[Reserved]	5.1	0.04	0.00
C_3HF_6Cl - (HCFC-226)	[Reserved]			0.00
$C_3H_2FCl_5$ - (HCFC-231)	[Reserved]			0.00
$C_3H_2F_2Cl_4$ - (HCFC-232)	[Reserved]			0.00
$C_3H_2F_3Cl_3$ - (HCFC-233)	[Reserved]			0.00

C ₃ H ₂ F ₄ Cl ₂ - (HCFC-234)	[Reserved]		0.00
C ₃ H ₂ F ₅ Cl- (HCFC-235)	[Reserved]		0.00
C ₃ H ₃ FCI ₄ - (HCFC-241)	[Reserved]		0.00
C ₃ H ₃ F ₂ Cl ₃ - (HCFC-242)	[Reserved]		0.00
C ₃ H ₃ F ₃ Cl ₂ - (HCFC-243)	[Reserved]		0.00
C ₃ H ₃ F ₄ Cl- (HCFC-244)	[Reserved]		0.00
C ₃ H ₄ FCI ₃ - (HCFC-251)	[Reserved]		0.00
C ₃ H ₄ F ₂ Cl ₂ - (HCFC-252)	[Reserved]		0.00
C ₃ H ₄ F ₃ Cl- (HCFC-253)	[Reserved]		0.00
C ₃ H ₅ FCI ₂ - (HCFC-261)	[Reserved]		0.00
C ₂ H ₅ F ₂ Cl- (HCFC-262)	[Reserved]		0.00
C ₃ H ₆ FCI- (HCFC-271)	[Reserved]		0.00
All isomers of the above chemicals	[Reserved]		

[60 FR 24986, May 10, 1995, as amended at 68 FR 42894, July 18, 2003]

Appendix G to Subpart A of Part 82—UNEP Recommendations for Conditions Applied to Exemption for Essential Laboratory and Analytical Uses

1. Essential laboratory and analytical uses are identified at this time to include equipment calibration; use as extraction solvents, diluents, or carriers for chemical analysis; biochemical research; inert solvents for chemical reactions, as a carrier or laboratory chemical and other critical analytical and laboratory purposes. Pursuant to Decision XI/15 of the Parties to the Montreal Protocol, effective January 1, 2002 the following uses of class I controlled substances are not considered essential under the global laboratory exemption:

- a. Testing of oil and grease and total petroleum hydrocarbons in water;
- b. Testing of tar in road-paving materials; and
- c. Forensic finger printing.

Production for essential laboratory and analytical purposes is authorized provided that these laboratory and analytical chemicals shall contain only controlled substances manufactured to the following purities:

CTC (reagent grade)—99.5

1,1,1,-trichloroethane—99.5

CFC-11—99.5

CFC-13—99.5

CFC-12—99.5

CFC-113—99.5

CFC-114—99.5

Other w/ Boiling P>20 degrees C—99.5

Other w/ Boiling P<20 degrees C—99.0

2. These pure, controlled substances can be subsequently mixed by manufacturers, agents or distributors with other chemicals controlled or not controlled by the Montreal Protocol as is customary for laboratory and analytical uses.

3. These high purity substances and mixtures containing controlled substances shall be supplied only in re-closable containers or high pressure cylinders smaller than three litres or in 10 millilitre or smaller glass ampoules, marked clearly as substances that deplete the ozone layer, restricted to laboratory use and analytical purposes and specifying that used or surplus substances should be collected and recycled, if practical. The material should be destroyed if recycling is not practical.

4. Parties shall annually report for each controlled substance produced: the purity; the quantity; the application, specific test standard, or procedure requiring its uses; and the status of efforts to eliminate its use in each application. Parties shall also submit copies of published instructions, standards, specifications, and regulations requiring the use of the controlled substance.

[60 FR 24986, May 10, 1995, as amended at 67 FR 6362, Feb. 11, 2002]

Appendix H to Subpart A of Part 82—Clean Air Act Amendments of 1990 Phaseout Schedule for Production of Ozone-Depleting Substances

Date	Carbon tetrachloride (percent)	Methyl chloroform (percent)	Other class substances (percent)
1994	70	85	65
1995	15	70	50
1996	15	50	40
1997	15	50	15
1998	15	50	15
1999	15	50	15
2000		20	
2001		20	

Appendix I to Subpart A of Part 82—Global Warming Potentials (Mass Basis), Referenced to the Absolute GWP for the Adopted Carbon Cycle Model CO₂Decay Response and Future CO₂Atmospheric Concentrations Held Constant at Current Levels. (Only Direct Effects are Considered.)

Species (chemical)	Chemical formula	Global warming potential (time horizon)		
		20 years	100 years	500 years
CFC-11	CFCl ₃	5000	4000	1400
CFC-12	CF ₂ Cl ₂	7900	8500	4200
CFC-13	CClF ₃	8100	11700	13600
CFC-113	C ₂ F ₃ Cl ₃	5000	5000	2300

CFC-114	C ₂ F ₄ Cl ₂	6900	9300	8300
CFC-115	C ₂ F ₅ Cl	6200	9300	13000
H-1301	CF ₃ Br	6200	5600	2200
Carbon Tet	CCl ₄	2000	1400	500
Methyl Chl	CH ₃ CCl ₃	360	110	35
HCFC-22	CF ₂ HCl	4300	1700	520
HCFC-141b	C ₂ FH ₃ Cl ₂	1800	630	200
HCFC-142b	C ₂ F ₂ H ₃ Cl	4200	2000	630
HCFC-123	C ₂ F ₃ HCl ₂	300	93	29
HCFC-124	C ₂ F ₄ HCl	1500	480	150
HCFC-225ca	C ₃ F ₅ HCl ₂	550	170	52
HCFC-225cb	C ₃ F ₅ HCl ₂	1700	530	170

A United Nations Environment Programme (UNEP), February 1995, Scientific Assessment of Ozone Depletion: 1994, Chapter 13, "Ozone Depleting Potentials, Global Warming Potentials and Future Chlorine/Bromine Loading," and do not reflect review of scientific documents published after that date.

[61 FR 1285, Jan. 19, 1996]

Appendix J to Subpart A of Part 82—Parties to the Montreal Protocol Classified Under Article 5(1) That Have Banned the Import of Controlled Products That Rely on Class I Controlled Substances for Their Continuing Functioning [Reserved]

Appendix K to Subpart A of Part 82—Commodity Codes From the Harmonized Tariff Schedule for Controlled Substances and Used Controlled Substances

Description of commodity or chemical	Commodity code from harmonized tariff schedule
CFC-11	2903.41.0000
CFC-12	2903.42.0000
CFC-113	2903.43.0000
CFC-114	2903.44.0010
CFC-115	2903.44.0020
HALONS	2903.46.0000
CFC-13, CFC-111, CFC-112, CFC-211, CFC-212, CFC-213, CFC-214, CFC-215, CFC-216, CFC-217	2903.45.0000
HCFC-22	2903.49.9010
HCFC-21, HCFC-31, HCFC-123, HCFC-124, HCFC-133, HCFC-141b, HCFC-142b, HCFC-225	2903.49.0000

OTHER, HALOGENATED	2903.49.9060
MIXTURES (R-500, R-502, ETC.)	3824.71.0000
MIXTURES, OTHER	3824.79.0000
CARBON TETRACHLORIDE	2903.14.0000
METHYL CHLOROFORM	2903.19.6010
METHYL BROMIDE	2903.30.1520

[63 FR 41651, Aug. 4, 1998]

Appendix L to Part 82 Subpart A—Approved Critical Uses and Limiting Critical Conditions for Those Uses for the 2007 Control Period

Column A	Column B	Column C
Approved Critical Uses	Approved Critical User and Location of Use	Limiting Critical Conditions that either exist, or that the approved critical user reasonably expects could arise without methyl bromide fumigation:
PRE-PLANT USES		
Cucurbits	(a) Michigan growers	Moderate to severe soilborne fungal disease infestation. Moderate to severe disease infestation. A need for methyl bromide for research purposes.
	(b) Southeastern U.S. limited to growing locations in Alabama, Arkansas, Kentucky, Louisiana, North Carolina, South Carolina, Tennessee, and Virginia	Moderate to severe yellow or purple nutsedge infestation. Moderate to severe fungal disease infestation. Moderate to severe root knot nematodes. A need for methyl bromide for research purposes.
	(c) Georgia growers	Moderate to severe yellow or purple nutsedge infestation. Moderate to severe fungal disease infestation. Moderate to severe root knot nematodes. A need for methyl bromide for research purposes.
Eggplant	(a) Florida growers	Moderate to severe yellow or purple nutsedge infestation. Moderate to severe nematodes. Moderate to severe disease infestation. Restrictions on alternatives due to

		karst geology. A need for methyl bromide for research purposes.
	(b) Georgia growers	Moderate to severe yellow or purple nutsedge infestation. Moderate to severe nematodes. Moderate to severe pythium root, collar, crown and root rot. Moderate to severe disease infestation. Moderate to severe southern blight infestation. Restrictions on alternatives due to karst geology. A need for methyl bromide for research purposes.
	(c) Michigan growers	Moderate to severe soilborne fungal disease infestation. A need for methyl bromide for research purposes.
Forest Nursery Seedlings	(a) Members of the Southern Forest Nursery Management Cooperative limited to growing locations in Alabama, Arkansas, Florida, Georgia, Louisiana, Mississippi, North Carolina, Oklahoma, South Carolina, Tennessee, Texas, and Virginia	Moderate to severe yellow or purple nutsedge infestation. Moderate to severe disease infestation.
	(b) International Paper and its subsidiaries limited to growing locations in Alabama, Arkansas, Georgia, South Carolina, and Texas	Moderate to severe yellow or purple nutsedge infestation. Moderate to severe disease infestation.
	(c) Public (government-owned) seedling nurseries in Illinois, Indiana, Kentucky, Maryland, Missouri, New Jersey, Ohio, Pennsylvania, West Virginia, and Wisconsin	Moderate to severe weed infestation including purple and yellow nutsedge infestation. Moderate to severe Canada thistle infestation. Moderate to severe nematodes. Moderate to severe fungal disease infestation.
	(d) Weyerhaeuser Company and its subsidiaries limited to growing locations in Alabama, Arkansas, North	Moderate to severe yellow or purple nutsedge infestation. Moderate to severe disease infestation.

	Carolina, and South Carolina	Moderate to severe nematodes and worms.
	(e) Weyerhaeuser Company and its subsidiaries limited to growing locations in Oregon and Washington	Moderate to severe yellow nutsedge infestation. Moderate to severe fungal disease infestation.
	(f) Michigan growers	Moderate to severe disease infestation. Moderate to severe Canada thistle infestation. Moderate to severe nutsedge infestation. Moderate to severe nematodes.
	(g) Michigan herbaceous perennials growers	Moderate to severe nematodes. Moderate to severe fungal disease infestation. Moderate to severe yellow nutsedge and other weed infestation.
Orchard Nursery Seedlings	(a) Members of the Western Raspberry Nursery Consortium limited to growing locations in California and Washington (Driscoll's Raspberries and their contract growers in California and Washington)	Moderate to severe nematode infestation Presence of medium to heavy clay soils. Prohibition on use of 1,3-dichloropropene products because local township limits on use of this alternative have been reached. A need for methyl bromide for research purposes.
	(b) Members of the California Association of Nurserymen—Deciduous Fruit and Nut Tree Growers	Moderate to severe nematode infestation. Presence of medium to heavy clay soils. Prohibition on use of 1,3-dichloropropene products because local township limits on use of this alternative have been reached. A need for methyl bromide for research purposes.
	(c) California rose nurseries	Moderate to severe nematode infestation. Prohibition on use of 1,3-dichloropropene products because local township limits on use of this alternative have been reached.

		A need for methyl bromide for research purposes.
Strawberry Nurseries	(a) California growers	Moderate to severe disease infestation. Moderate to severe yellow or purple nutsedge infestation. Moderate to severe nematodes. A need for methyl bromide for research purposes.
	(b) Maryland, North Carolina, and Tennessee growers	Moderate to severe black root rot. Moderate to severe root-knot nematodes. Moderate to severe yellow and purple nutsedge infestation. A need for methyl bromide for research purposes.
Orchard Replant	(a) California stone fruit growers	Moderate to severe nematodes. Moderate to severe fungal disease infestation. Replanted (non-virgin) orchard soils to prevent orchard replant disease. Presence of medium to heavy soils. Prohibition on use of 1,3-dichloropropene products because local township limits for this alternative have been reached. A need for methyl bromide for research purposes.
	(b) California table and raisin grape growers	Moderate to severe nematodes. Moderate to severe fungal disease infestation. Replanted (non-virgin) orchard soils to prevent orchard replant disease. Medium to heavy soils. Prohibition on use of 1,3-dichloropropene products because local township limits for this alternative have been reached. A need for methyl bromide for research purposes.
	(c) California wine grape growers	Moderate to severe nematodes. Moderate to severe fungal disease infestation.

		<p>Replanted (non-virgin) orchard soils to prevent orchard replant disease.</p> <p>Medium to heavy soils.</p> <p>Prohibition on use of 1,3-dichloropropene products because local township limits for this alternative have been reached.</p> <p>A need for methyl bromide for research purposes.</p>
	(d) California walnut growers	<p>Moderate to severe nematodes.</p> <p>Moderate to severe fungal disease infestation.</p> <p>Replanted (non-virgin) orchard soils to prevent orchard replant disease.</p> <p>Medium to heavy soils.</p> <p>Prohibition on use of 1,3-dichloropropene products because local township limits for this alternative have been reached.</p> <p>A need for methyl bromide for research purposes.</p>
	(e) California almond growers	<p>Moderate to severe nematodes.</p> <p>Moderate to severe fungal disease infestation.</p> <p>Replanted (non-virgin) orchard soils to prevent orchard replant disease.</p> <p>Medium to heavy soils.</p> <p>Prohibition on use of 1,3-dichloropropene products because local township limits for this alternative have been reached.</p> <p>A need for methyl bromide for research purposes.</p>
Ornamentals	(a) California growers	<p>Moderate to severe disease infestation.</p> <p>Moderate to severe nematodes.</p> <p>Prohibition on use of 1,3-dichloropropene products because local township limits for this alternative have been reached.</p> <p>A need for methyl bromide for research purposes.</p>

	(b) Florida growers	Moderate to severe weed infestation. Moderate to severe disease infestation. Moderate to severe nematodes. Karst topography. A need for methyl bromide for research purposes.
Peppers	(a) California growers	Moderate to severe disease infestation. Moderate to severe nematodes. A prohibition on the use of 1,3-dichloropropene products because local township limits for this alternative have been reached. A need for methyl bromide for research purposes.
	(b) Alabama, Arkansas, Kentucky, Louisiana, North Carolina, South Carolina, Tennessee, and Virginia growers	Moderate to severe yellow or purple nutsedge infestation. Moderate to severe nematodes. Moderate to severe pythium root, collar, crown and root rots. Presence of an occupied structure within 100 feet of a grower's field the size of 100 acres or less. A need for methyl bromide for research purposes.
	(c) Florida growers	Moderate to severe yellow or purple nutsedge infestation. Moderate to severe disease infestation. Moderate to severe nematodes. Karst topography. A need for methyl bromide for research purposes.
	(d) Georgia growers	Moderate to severe yellow or purple nutsedge infestation. Moderate to severe nematodes, or moderate to severe pythium root and collar rots. Moderate to severe southern blight infestation, crown or root rot. A need for methyl bromide for research purposes.
	(e) Michigan growers	Moderate to severe fungal

		disease infestation. A need for methyl bromide for research purposes.
Strawberry Fruit	(a) California growers	Moderate to severe black root rot or crown rot. Moderate to severe yellow or purple nutsedge infestation. Moderate to severe nematodes. Prohibition on use of 1,3-dichloropropene products because local township limits for this alternative have been reached. Time to transition to an alternative. A need for methyl bromide for research purposes.
	(b) Florida growers	Moderate to severe yellow or purple nutsedge. Moderate to severe nematodes. Moderate to severe disease infestation. Carolina geranium or cut-leaf evening primrose infestation. Karst topography and to a lesser extent a need for methyl bromide for research purposes.
	(c) Alabama, Arkansas, Georgia, Illinois, Kentucky, Louisiana, Maryland, New Jersey, North Carolina, Ohio, South Carolina, Tennessee, and Virginia growers	Moderate to severe yellow or purple nutsedge. Moderate to severe nematodes. Moderate to severe black root and crown rot. Presence of an occupied structure within 100 feet of a grower's field the size of 100 acres or less. A need for methyl bromide for research purposes.
Tomatoes	(a) Michigan growers	Moderate to severe disease infestation. Moderate to severe fungal pathogen infestation. A need for methyl bromide for research purposes.
	(b) Alabama, Arkansas, Florida, Georgia, Kentucky, Louisiana, North Carolina, South Carolina, Tennessee,	Moderate to severe yellow or purple nutsedge infestation. Moderate to severe disease infestation.

	and Virginia growers	Moderate to severe nematodes. Presence of an occupied structure within 100 feet of a grower's field the size of 100 acres or less. Karst topography. A need for methyl bromide for research purposes.
Turfgrass	(a) U.S. turfgrass sod nursery producers who are members of Turfgrass Producers International (TPI)	Production of industry certified pure sod. Moderate to severe bermudagrass. Moderate to severe nutsedge. Moderate to severe white grub infestation. Control of off-type perennial grass infestation. A need for methyl bromide for research purposes.
POST-HARVEST USES		
Food Processing	(a) Rice millers in all locations in the U.S. who are members of the USA Rice Millers Association	Moderate to severe infestation of beetles, weevils, or moths. Older structures that can not be properly sealed to use an alternative to methyl bromide. Presence of sensitive electronic equipment subject to corrosivity. Time to transition to an alternative.
	(b) Pet food manufacturing facilities in the U.S. who are active members of the Pet Food Institute (For this final rule, "pet food" refers to domestic dog and cat food)	Moderate to severe infestation of beetles, moths, or cockroaches. Older structures that can not be properly sealed to use an alternative to methyl bromide. Presence of sensitive electronic equipment subject to corrosivity. Time to transition to an alternative.
	(c) Kraft Foods in the U.S	Older structures that can not be properly sealed to use an alternative to methyl bromide. Presence of sensitive electronic equipment subject to corrosivity. Time to transition to an alternative.
	(d) Members of the North American Millers' Association in the U.S	Moderate to severe beetle infestation. Older structures that can not be

		properly sealed to use an alternative to methyl bromide. Presence of sensitive electronic equipment subject to corrosivity. Time to transition to an alternative.
	(e) Members of the National Pest Management Association treating cocoa beans in storage and associated spaces and equipment and processed food, cheese, dried milk, herbs, and spices and spaces and equipment in associated processing facilities	Moderate to severe beetle or moth infestation. Older structures that can not be properly sealed to use an alternative to methyl bromide. Presence of sensitive electronic equipment subject to corrosivity. Time to transition to an alternative.
Commodity Storage	(a) California entities storing walnuts, beans, dried plums, figs, raisins, dates (in Riverside county only), and pistachios in California	Rapid fumigation is required to meet a critical market window, such as during the holiday season, rapid fumigation is required when a buyer provides short (2 working days or less) notification for a purchase or there is a short period after harvest in which to fumigate and there is limited silo availability for using alternatives. A need for methyl bromide for research purposes.
Dry Cured Pork Products	(a) Members of the National Country Ham Association	Moderate to severe red legged ham beetle infestation. Moderate to severe cheese/ham skipper infestation. Moderate to severe dermested beetle infestation. Ham mite infestation.
	(b) Members of the American Association of Meat Processors	Moderate to severe red legged ham beetle infestation. Moderate to severe cheese/ham skipper infestation. Moderate to severe dermested beetle infestation. Ham mite infestation.
	(c) Nahunta Pork Center (North Carolina)	Moderate to severe red legged ham beetle infestation. Moderate to severe cheese/ham skipper infestation.

		Moderate to severe dermestid beetle infestation. Ham mite infestation.
--	--	---

[71 FR 75403, Dec. 14, 2006]

[Browse Next](#)

For questions or comments regarding e-CFR editorial content, features, or design, email ecfr@nara.gov.

For questions concerning e-CFR programming and delivery issues, email webteam@gpo.gov.

[Section 508 / Accessibility](#)

Electronic Code of Federal Regulations

e-CFR™**e-CFR Data is current as of August 1, 2007****Title 40: Protection of Environment****PART 82—PROTECTION OF STRATOSPHERIC OZONE**[Browse Previous](#) | [Browse Next](#)**Subpart E—The Labeling of Products Using Ozone-Depleting Substances****Source:** 60 FR 4020, Jan. 19, 1995, unless otherwise noted.**§ 82.100 Purpose.**

The purpose of this subpart is to require warning statements on containers of, and products containing or manufactured with, certain ozone-depleting substances, pursuant to section 611 of the Clean Air Act, as amended.

§ 82.102 Applicability.

(a) In the case of substances designated as class I or class II substances as of February 11, 1993, the applicable date of the requirements in this paragraph (a) is May 15, 1993. In the case of any substance designated as a class I or class II substance after February 11, 1993, the applicable date of the requirements in this paragraph (a) is one year after the designation of such substance as a class I or class II substance unless otherwise specified in the designation. On the applicable date indicated in this paragraph (a), the requirements of this subpart shall apply to the following containers and products except as exempted under paragraph (c) of this section:

(1) All containers in which a class I or class II substance is stored or transported.

(2) All products containing a class I substance.

(3) All products directly manufactured with a process that uses a class I substance, unless otherwise exempted by this subpart or, unless the Administrator determines for a particular product that there are no substitute products or manufacturing processes for such product that do not rely on the use of a class I substance, that reduce overall risk to human health and the environment, and that are currently or potentially available. If the Administrator makes such a determination for a particular product, then the requirements of this subpart are effective for such product no later than January 1, 2015.

(b) Applicable January 1, 2015 in any case, or one year after any determination between May 15, 1993 and January 1, 2015, by the Administrator for a particular product that there are substitute products or manufacturing processes for such product that do not rely on the use of a class I or class II substance, that reduce the overall risk to human health and the environment, and that are currently or potentially available, the requirements of this subpart shall apply to the following:

(1) All products containing a class II substance.

(2) All products manufactured with a process that uses a class II substance.

(c) The requirements of this subpart shall not apply to products manufactured prior to May 15, 1993, provided that the manufacturer submits documentation to EPA upon request showing that the product was manufactured prior to that date.

§ 82.104 Definitions.

(a) *Class I substance* means any substance designated as class I in 40 CFR part 82, appendix A to subpart A, including chlorofluorocarbons, halons, carbon tetrachloride and methyl chloroform and any other substance so designated by the Agency at a later date.

(b) *Class II substance* means any substance designated as class II in 40 CFR part 82, appendix A to subpart A, including hydrochlorofluorocarbons and any other substance so designated by the Agency at a later date.

(c) *Completely destroy* means to cause the destruction of a controlled substance by one of the five destruction processes approved by the Parties at a demonstrable destruction efficiency of 98 percent or more or a greater destruction efficiency if required under other applicable federal regulations.

(d) *Consumer* means a commercial or non-commercial purchaser of a product or container that has been introduced into interstate commerce.

(e) *Container* means the immediate vessel in which a controlled substance is stored or transported.

(f) *Container containing* means a container that physically holds a controlled substance within its structure that is intended to be transferred to another container, vessel or piece of equipment in order to realize its intended use.

(g) *Controlled substance* means a class I or class II ozone-depleting substance.

(h) *Destruction means* the expiration of a controlled substance, that does not result in a commercially useful end product using one of the following controlled processes in a manner that complies at a minimum with the "Code of Good Housekeeping" of Chapter 5.5 of the United Nations Environment Programme (UNEP) report entitled, *Ad-Hoc Technical Advisory Committee on ODS Destruction Technologies*, as well as the whole of Chapter 5 from that report, or with more stringent requirements as applicable. The report is available from the Environmental Protection Agency, Public Docket A-91-60, 401 M Street, SW., Washington, DC 20460 The controlled processes are:

(1) Liquid injection incineration;

(2) Reactor cracking;

(3) Gaseous/fume oxidation;

(4) Rotary kiln incineration; or

(5) Cement kiln.

(i) *Distributor* means a person to whom a product is delivered or sold for purposes of subsequent resale, delivery or export.

(j) *Export* means the transport of virgin, used, or recycled class I or class II substances or products manufactured or containing class I or class II substances from inside the United States or its territories to persons outside the United States or its territories, excluding United States military bases and ships for on-board use.

(k) *Exporter* means the person who contracts to sell class I or class II substances or products manufactured with or containing class I or class II substances for export or transfers such substances or products to his affiliate in another country.

(l) *Import* means to land on, bring into, or introduce into, or attempt to land on, bring into, or introduce into any place subject to the jurisdiction of the United States whether or not such landing, bringing, or introduction constitutes an importation within the meaning of the customs laws of the United States, with the exception of temporary off-loading of products manufactured with or containers containing class I or class II substances from a ship are used for servicing of that ship.

(m) *Importer* means any person who imports a controlled substance, a product containing a controlled substance, a product manufactured with a controlled substance, or any other chemical substance (including a chemical substance shipped as part of a mixture or article), into the United States. "Importer" includes the person primarily liable for the payment of any duties on the merchandise or an authorized agent acting on his or her behalf. The term also includes, as appropriate:

- (1) The consignee;
- (2) The importer of record listed on U.S. Customs Service forms for the import;
- (3) The actual owner if an actual owner's declaration and superseding bond has been filed; or
- (4) The transferee, if the right to draw merchandise in a bonded warehouse has been transferred.

(n) *Interstate commerce* means the distribution or transportation of any product between one state, territory, possession or the District of Columbia, and another state, territory, possession or the District of Columbia, or the sale, use or manufacture of any product in more than one state, territory, possession or District of Columbia. The entry points for which a product is introduced into interstate commerce are the release of a product from the facility in which the product was manufactured, the entry into a warehouse from which the domestic manufacturer releases the product for sale or distribution, and at the site of United States Customs clearance.

(o) *Manufactured with a controlled substance* means that the manufacturer of the product itself used a controlled substance directly in the product's manufacturing, but the product itself does not contain more than trace quantities of the controlled substance at the point of introduction into interstate commerce. The following situations are excluded from the meaning of the phrase "manufactured with" a controlled substance:

- (1) Where a product has not had physical contact with the controlled substance;
- (2) Where the manufacturing equipment or the product has had physical contact with a controlled substance in an intermittent manner, not as a routine part of the direct manufacturing process;
- (3) Where the controlled substance has been transformed, except for trace quantities; or
- (4) Where the controlled substance has been completely destroyed.

(p) *Potentially available* means that adequate information exists to make a determination that the substitute is technologically feasible, environmentally acceptable and economically viable.

(q) *Principal display panel (PDP)* means the entire portion of the surface of a product, container or its outer packaging that is most likely to be displayed, shown, presented, or examined under customary conditions of retail sale. The area of the PDP is not limited to the portion of the surface covered with existing labeling; rather it includes the entire surface, excluding flanges, shoulders, handles, or necks.

(r) *Product* means an item or category of items manufactured from raw or recycled materials, or other products, which is used to perform a function or task.

(s) *Product containing* means a product including, but not limited to, containers, vessels, or pieces of equipment, that physically holds a controlled substance at the point of sale to the ultimate consumer which remains within the product.

(t) *Promotional printed material* means any informational or advertising material (including, but not limited to, written advertisements, brochures, circulars, desk references and fact sheets) that is prepared

by the manufacturer for display or promotion concerning a product or container, and that does not accompany the product to the consumer.

(u) *Retailer* means a person to whom a product is delivered or sold, if such delivery or sale is for purposes of sale or distribution in commerce to consumers who buy such product for purposes other than resale.

(v) *Spare parts* means those parts that are supplied by a manufacturer to another manufacturer, distributor, or retailer, for purposes of replacing similar parts with such parts in the repair of a product.

(w) *Supplemental printed material* means any informational material (including, but not limited to, package inserts, fact sheets, invoices, material safety data sheets, procurement and specification sheets, or other material) which accompanies a product or container to the consumer at the time of purchase.

(x) *Transform* means to use and entirely consume a class I or class II substance, except for trace quantities, by changing it into one or more substances not subject to this subpart in the manufacturing process of a product or chemical.

(y) *Type size* means the actual height of the printed image of each capital letter as it appears on a label.

(z) *Ultimate consumer* means the first commercial or non-commercial purchaser of a container or product that is not intended for re-introduction into interstate commerce as a final product or as part of another product.

(aa) *Warning label* means the warning statement required by section 611 of the Act. The term warning statement shall be synonymous with warning label for purposes of this subpart.

(bb) *Waste* means, for purposes of this subpart, items or substances that are discarded with the intent that such items or substances will serve no further useful purpose.

(cc) *Wholesaler* means a person to whom a product is delivered or sold, if such delivery or sale is for purposes of sale or distribution to retailers who buy such product for purposes of resale.

§ 82.106 Warning statement requirements.

(a) *Required warning statements.* Unless otherwise exempted by this subpart, each container or product identified in §82.102 (a) or (b) shall bear the following warning statement, meeting the requirements of this subpart for placement and form:

WARNING: Contains [or Manufactured with, if applicable] [*insert name of substance*], a substance which harms public health and environment by destroying ozone in the upper atmosphere.

(b) *Exemptions from warning label requirement.* The following products need not bear a warning label:

(1) Products containing trace quantities of a controlled substance remaining as a residue or impurity due to a chemical reaction, and where the controlled substance serves no useful purpose in or for the product itself. However, if such product was manufactured using the controlled substance, the product is required to be labeled as a "product manufactured with" the controlled substance, unless otherwise exempted;

(2) Containers containing a controlled substance in which trace quantities of that controlled substance remain as a residue or impurity;

(3) Waste containing controlled substances or blends of controlled substances bound for discard;

(4) Products manufactured using methyl chloroform or CFC-113 by persons who can demonstrate and certify a 95% reduction in overall usage from their 1990 calendar year usage of methyl chloroform or

CFC-113 as solvents during a twelve (12) month period ending within sixty (60) days of such certification or during the most recently completed calendar year. In calculating such reduction, persons may subtract from quantities used those quantities for which they possess accessible data that establishes the amount of methyl chloroform or CFC-113 transformed. Such subtraction must be performed for both the applicable twelve month period and the 1990 calendar year. If at any time future usage exceeds the 95% reduction, all products manufactured with methyl chloroform or CFC-113 as solvents by that person must be labeled immediately. No person may qualify for this exemption after May 15, 1994;

(5) Products intended only for export outside of the United States shall not be considered "products introduced into interstate commerce" provided such products are clearly designated as intended for export only;

(6) Products that are otherwise not subject to the requirements of this subpart that are being repaired, using a process that uses a controlled substance.

(7) Products, processes, or substitute chemicals undergoing research and development, by which a controlled substance is used. Such products must be labeled when they are introduced into interstate commerce.

(c) *Interference with other required labeling information.* The warning statement shall not interfere with, detract from, or mar any labeling information required on the labeling by federal or state law.

§ 82.108 Placement of warning statement.

The warning statement shall be placed so as to satisfy the requirement of the Act that the warning statement be "clearly legible and conspicuous." The warning statement is clearly legible and conspicuous if it appears with such prominence and conspicuousness as to render it likely to be read and understood by consumers under normal conditions of purchase. Such placement includes, but is not limited to, the following:

(a) *Display panel placement.* For any affected product or container that has a display panel that is normally viewed by the purchaser at the time of the purchase, the warning statement described in §82.106 may appear on any such display panel of the affected product or container such that it is "clearly legible and conspicuous" at the time of the purchase. If the warning statement appears on the principal display panel or outer packaging of any such affected product or container, the warning statement shall qualify as "clearly legible and conspicuous," as long as the label also fulfills all other requirements of this subpart and is not obscured by any outer packaging, as required by paragraph (b) of this section. The warning statement need not appear on such display panel if either:

(1) The warning statement appears on the outer packaging of the product or container, consistent with paragraph (b) of this section, and is clearly legible and conspicuous; or

(2) The warning statement is placed in a manner consistent with paragraph (c) of this section.

(b) *Outer packaging.* If the product or container is normally packaged, wrapped, or otherwise covered when viewed by the purchaser at the time of the purchase the warning statement described in §82.106 shall appear on any outer packaging, wrapping or other covering used in the retail display of the product or container, such that the warning statement is clearly legible and conspicuous at the time of the purchase. If the outer packaging has a display panel that is normally viewed by the purchaser at the time of the purchase, the warning statement shall appear on such display panel. If the warning statement so appears on such product's or container's outer packaging, it need not appear on the surface of the product or container, as long as the statement also fulfills all other requirements of this subpart. The warning statement need not appear on such outer packaging if either:

(1) The warning statement appears on the surface of the product or container, consistent with paragraph (a) of this section, and is clearly legible and conspicuous through any outer packaging, wrapping or other covering used in display; or

(2) The warning statement is placed in a manner consistent with paragraph (c) of this section.

(c) *Alternative placement.* The warning statement may be placed on a hang tag, tape, card, sticker,

invoice, bill of lading, supplemental printed material, or similar overlabeled that is securely attached to the container, product, outer packaging or display case, or accompanies the product containing or manufactured with a controlled substance or a container containing class I or class II substances through its sale to the consumer or ultimate consumer. For prescription medical products that have been found to be essential for patient health by the Food and Drug Administration, the warning statement may be placed in supplemental printed material intended to be read by the prescribing physician, as long as the following statement is placed on the product, its packaging, or supplemental printed material intended to be read by the patient: "This product contains [insert name of substance], a substance which harms the environment by depleting ozone in the upper atmosphere." In any case, the warning statement must be clearly legible and conspicuous at the time of the purchase.

(d) *Products not viewed by the purchaser at the time of purchase.* Where the purchaser of a product cannot view a product, its packaging or alternative labeling such that the warning statement is clearly legible and conspicuous at the time of purchase, as specified under paragraphs (a), (b), or (c) of this section, the warning statement may be placed in the following manner:

(1) Where promotional printed material is prepared for display or distribution, the warning statement may be placed on such promotional printed material such that it is clearly legible and conspicuous at the time of purchase; or

(2) The warning statement may be placed on the product, on its outer packaging, or on alternative labeling, consistent with paragraphs (a), (b), or (c) of this section, such that the warning statement is clearly legible and conspicuous at the time of product delivery, if the product may be returned by the purchaser at or after the time of delivery or if the purchase is not complete until the time of delivery (e.g., products delivered C.O.D.).

§ 82.110 Form of label bearing warning statement.

(a) *Conspicuousness and contrast.* The warning statement shall appear in conspicuous and legible type by typography, layout, and color with other printed matter on the label. The warning statement shall appear in sharp contrast to any background upon which it appears. Examples of combinations of colors which may not satisfy the proposed requirement for sharp contrast are: black letters on a dark blue or dark green background, dark red letters on a light red background, light red letters on a reflective silver background, and white letters on a light gray or tan background.

(b) *Name of substance.* The name of the class I or class II substance to be inserted into the warning statement shall be the standard chemical name of the substance as listed in 40 CFR part 82, appendix A to subpart A, except that:

(1) The acronym "CFC" may be substituted for "chlorofluorocarbon."

(2) The acronym "HCFC" may be substituted for "hydrochlorofluorocarbon."

(3) The term "1,1,1-trichloroethane" may be substituted for "methyl chloroform."

(c) *Combined statement for multiple class I substances.* If a container containing or a product contains or is manufactured with, more than one class I or class II substance, the warning statement may include the names of all of the substances in a single warning statement, provided that the combined statement clearly distinguishes which substances the container or product contains and which were used in the manufacturing process.

(d) *Format.* (1) The warning statement shall be blocked within a square or rectangular area, with or without a border. (2) The warning statement shall appear in lines that are parallel to the surrounding text on the product's PDP, display panel, supplemental printed material or promotional printed material.

(e) *Type style.* The ratio of the height of a capital letter to its width shall be such that the height of the letter is no more than 3 times its width; the signal word "WARNING" shall appear in all capital letters.

(f) *Type size.* The warning statement shall appear at least as large as the type sizes prescribed by this paragraph. The type size refers to the height of the capital letters. A larger type size materially enhances the legibility of the statement and is desirable.

(1) *Display panel or outer packaging.* Minimum type size requirements for the warning statement are given in Table 1 to this paragraph and are based upon the area of the display panel of the product or container. Where the statement is on outer packaging, as well as the display panel area, the statement shall appear in the same minimum type size as on the display panel.

Table 1 to §82.110(f)(1)

	Area of display panel (sq. in.)					
	0-2	>2-5	>5-10	>10-15	>15-30	>30
Type size (in.) ¹						
Signal word	3/64	1/16	3/32	7/64	1/8	5/32
Statement	3/64	3/64	1/16	3/32	3/32	7/64

> Means greater than.

¹Minimum height of printed image of letters.

(2) *Alternative placement.* The minimum type size for the warning statement on any alternative placement which meets the requirements of §82.108(c) is 3/32 inches for the signal word and 1/16 of an inch for the statement.

(3) *Promotional printed material.* The minimum type size for the warning statement on promotional printed material is 3/32 inches for the signal word and 1/16 of an inch for the statement, or the type size of any surrounding text, whichever is larger.

§ 82.112 Removal of label bearing warning statement.

(a) *Prohibition on removal.* Except as described in paragraph (b) or (c) of this section, any warning statement that accompanies a product or container introduced into interstate commerce, as required by this subpart, must remain with the product or container and any product incorporating such product or container, up to and including the point of sale to the ultimate consumer.

(b) *Incorporation of warning statement by subsequent manufacturers.* A manufacturer of a product that incorporates a product that is accompanied by a label bearing the warning statement may remove such label from the incorporated product if the information on such label is incorporated into a warning statement accompanying the manufacturer's product, or if, pursuant to paragraph (c) of this section, the manufacturer of the product is not required to pass through the information contained on or incorporated in the product's label.

(c) *Manufacturers that incorporate products manufactured with controlled substances.* A manufacturer that incorporates into its own product a component product that was purchased from another manufacturer, was manufactured with a process that uses a controlled substance(s), but does not contain such substance(s), may remove such label from the incorporated product and need not apply a warning statement to its own product, if the manufacturer does not use a controlled substance in its own manufacturing process. A manufacturer that uses controlled substances in its own manufacturing process, and is otherwise subject to the regulations of this subpart, must label pursuant to §82.106, but need not include information regarding the incorporated product on the required label.

(d) *Manufacturers, distributors, wholesalers, retailers that sell spare parts manufactured with controlled substances solely for repair.* Manufacturers, distributors, wholesalers, and retailers that purchase spare parts manufactured with a class I substance from another manufacturer or supplier, and sell such spare parts for the sole purpose of repair, are not required to pass through an applicable warning label if such products are removed from the original packaging provided by the manufacturer from whom the products are purchased. Manufacturers of the spare parts manufactured with controlled substances must still label their products; furthermore, manufacturers, importers, and distributors of such products must pass through the labeling information as long as products remain assembled and packaged in the manner assembled and packaged by the original manufacturer. This exemption shall not apply if a spare

part is later used for manufacture and/or for purposes other than repair.

§ 82.114 Compliance by manufacturers and importers with requirements for labeling of containers of controlled substances, or products containing controlled substances.

(a) *Compliance by manufacturers and importers with requirements for labeling of containers of controlled substances, or products containing controlled substances.* Each manufacturer of a product incorporating another product or container containing a controlled substance, to which §82.102 (a)(1), or, (a)(2) or (b) (1) applies, that is purchased or obtained from another manufacturer or supplier, is required to pass through and incorporate the labeling information that accompanies such incorporated product in a warning statement accompanying the manufacturer's finished product. Each importer of a product, or container containing a controlled substance, to which §82.102 (a)(1), (a)(2), or (b)(1) applies, including a component product or container incorporated into the product, that is purchased from a foreign manufacturer or supplier, is required to apply a label, or to ensure that a label has been properly applied, at the site of U.S. Customs clearance.

(b) *Reliance on reasonable belief.* The manufacturer or importer of a product that incorporates another product container from another manufacturer or supplier may rely on the labeling information (or lack thereof) that it receives with the product, and is not required to independently investigate whether the requirements of this subpart are applicable to such purchased product or container, as long as the manufacturer reasonably believes that the supplier or foreign manufacturer is reliably and accurately complying with the requirements of this subpart.

(c) *Contractual obligations.* A manufacturer's or importer's contractual relationship with its supplier under which the supplier is required to accurately label, consistent with the requirements of this subpart, any products containing a controlled substance or containers of a controlled substance that are supplied to the manufacturer or importer, is evidence of reasonable belief.

§ 82.116 Compliance by manufacturers or importers incorporating products manufactured with controlled substances.

(a) *Compliance by manufacturers or importers incorporating products manufactured with controlled substances, or importing products manufactured with controlled substances.* Each manufacturer or importer of a product incorporating another product to which §82.102 (a)(3) or (b)(2) applies, that is purchased from another manufacturer or supplier, is not required to pass through and incorporate the labeling information that accompanies such incorporated product in a warning statement accompanying the manufacturer's or importer's finished product. Importers of products to which §82.102 (a)(3) or (b)(2) applies are required to apply a label, or to ensure that a label has been properly applied at the site of U.S. Customs clearance.

(b) *Reliance on reasonable belief.* The importer of a product purchased or obtained from a foreign manufacturer or supplier, which product may have been manufactured with a controlled substance, may rely on the information that it receives with the purchased product, and is not required to independently investigate whether the requirements of this subpart are applicable to the purchased or obtained product, as long as the importer reasonably believes that there was no use of controlled substances by the final manufacturer of the product being imported.

(c) *Contractual obligations.* An importer's contractual relationship with its supplier under which the supplier is required to accurately label, consistent with the requirements of this subpart, any products manufactured with a controlled substance that are supplied to the importer, or to certify to the importer whether a product was or was not manufactured with a controlled substance is evidence of reasonable belief.

§ 82.118 Compliance by wholesalers, distributors and retailers.

(a) *Requirement of compliance by wholesalers, distributors and retailers.* All wholesalers, distributors and retailers of products or containers to which this subpart applies are required to pass through the labeling information that accompanies the product, except those purchasing from other manufacturers or suppliers spare parts manufactured with controlled substances and selling those parts for the demonstrable sole purpose of repair.

(b) *Reliance on reasonable belief.* The wholesaler, distributor or retailer of a product may rely on the labeling information that it receives with the product or container, and is not required to independently investigate whether the requirements of this subpart are applicable to the product or container, as long as the wholesaler, distributor or retailer reasonably believes that the supplier of the product or container is reliably and accurately complying with the requirements of this subpart.

(c) *Contractual obligations.* A wholesaler, distributor or retailer's contractual relationship with its supplier under which the supplier is required to accurately label, consistent with the requirements of this subpart, any products manufactured with a controlled substance that are supplied to the wholesaler, distributor or retailer is evidence of reasonable belief.

§ 82.120 Petitions.

(a) *Requirements for procedure and timing.* Persons seeking to apply the requirements of this regulation to a product containing a class II substance or a product manufactured with a class I or a class II substance which is not otherwise subject to the requirements, or to temporarily exempt a product manufactured with a class I substance, based on a showing of a lack of currently or potentially available alternatives, from the requirements of this regulation may submit petitions to: Labeling Program Manager, Stratospheric Protection Division, Office of Atmospheric Programs, U.S. Environmental Protection Agency, 6202-J, 1200 Pennsylvania Ave., NW., Washington, DC 20460. Such persons must label their products while such petitions are under review by the Agency.

(b) *Requirement for adequate data.* Any petition submitted under paragraph (a) of this section shall be accompanied by adequate data, as defined in §82.120(c). If adequate data are not included by the petitioner, the Agency may return the petition and request specific additional information.

(c) *Adequate data.* A petition shall be considered by the Agency to be supported by adequate data if it includes all of the following:

(1) A part clearly labeled "Section I.A." which contains the petitioner's full name, company or organization name, address and telephone number, the product that is the subject of the petition, and, in the case of a petition to temporarily exempt a product manufactured with a class I substance from the labeling requirement, the manufacturer or manufacturers of that product.

(2) For petitions to temporarily exempt a product manufactured with a class I substance only, a part clearly labeled "Section I.A.T." which states the length of time for which an exemption is requested.

(3) A part clearly labeled "Section I.B." which includes the following statement, signed by the petitioner or an authorized representative:

"I certify under penalty of law that I have personally examined and am familiar with the information submitted in this petition and all attached documents, and that, based on my inquiry of those individuals immediately responsible for obtaining the information, I believe that the submitted information is true, accurate, and complete. I am aware that there are significant penalties for submitting false information."

(4) A part clearly labeled "Section I.C." which fully explains the basis for the petitioner's request that EPA add the labeling requirements to or remove them from the product which is the subject of the petition, based specifically upon the technical facility or laboratory tests, literature, or economic analysis described in paragraphs (c) (5), (6) and (7) of this section.

(5) A part clearly labeled "Section II.A." which fully describes any technical facility or laboratory tests used to support the petitioner's claim.

(6) A part clearly labeled "Section II.B." which fully explains any values taken from literature or estimated on the basis of known information that are used to support the petitioner's claim.

(7) A part clearly labeled "Section II.C." which fully explains any economic analysis used to support the petitioner's claim.

(d) *Criteria for evaluating petitions.* Adequate data in support of any petition to the Agency to add a

product to the labeling requirement or temporarily remove a product from the labeling requirement will be evaluated based upon a showing of sufficient quality and scope by the petitioner of whether there are or are not substitute products or manufacturing processes for such product:

- (1) That do not rely on the use of such class I or class II substance;
- (2) That reduce the overall risk to human health and the environment; and
- (3) That are currently or potentially available.

(e) *Procedure for acceptance or denial of petition.* (1) If a petition submitted under this section contains adequate data, as defined under paragraph (c) of this section, the Agency shall within 180 days after receiving the complete petition either accept the petition or deny the petition.

(2) If the Agency makes a decision to accept a petition to apply the requirements of this regulation to a product containing or manufactured with a class II substance, the Agency will notify the petitioner and publish a proposed rule in the Federal Register to apply the labeling requirements to the product.

(3) If the Agency makes a decision to deny a petition to apply the requirements of this regulation to a product containing or manufactured with a class II substance, the Agency will notify the petitioner and publish an explanation of the petition denial in the Federal Register.

(4) If the Agency makes a decision to accept a petition to temporarily exempt a product manufactured with a class I substance from the requirements of this regulation, the Agency will notify the petitioner and publish a proposed rule in the Federal Register to temporarily exempt the product from the labeling requirements. Upon notification by the Agency, such manufacturer may immediately cease its labeling process for such exempted products.

(5) If the Agency makes a decision to deny a petition to temporarily exempt a product manufactured with a class I substance from the requirements of this regulation, the Agency will notify the petitioner and may, in appropriate circumstances, publish an explanation of the petition denial in the Federal Register.

§ 82.122 Certification, recordkeeping, and notice requirements.

(a) *Certification.* (1) Persons claiming the exemption provided in §82.106(b)(2) must submit a written certification to the following address: Labeling Program Manager, Stratospheric Protection Division, Office of Atmospheric Programs, 6205-J, 1200 Pennsylvania Ave., NW., Washington, DC 20460.

(2) The certification must contain the following information:

(i) The exact location of documents verifying calendar year 1990 usage and the 95% reduced usage during a twelve month period;

(ii) A description of the records maintained at that location;

(iii) A description of the type of system used to track usage;

(iv) An indication of which 12 month period reflects the 95% reduced usage, and;

(v) Name, address, and telephone number of a contact person.

(3) Persons who submit certifications postmarked on or before May 15, 1993, need not place warning labels on their products manufactured using CFC-113 or methyl chloroform as a solvent. Persons who submit certifications postmarked after May 15, 1993, must label their products manufactured using CFC-113 or methyl chloroform as a solvent for 14 days following such submittal of the certification.

(4) Persons certifying must also include a statement that indicates their future annual use will at no time exceed 5% of their 1990 usage.

(5) Certifications must be signed by the owner or a responsible corporate officer.

(6) If the Administrator determines that a person's certification is incomplete or that information supporting the exemption is inadequate, then products manufactured using CFC-113 or methyl chloroform as a solvent by such person must be labeled pursuant to §82.106(a).

(b) *Recordkeeping.* Persons claiming the exemption under section 82.106(b)(2) must retain supporting documentation at one of their facilities.

(c) *Notice Requirements.* Persons who claim an exemption under §82.106(b)(2) must submit a notice to the address in paragraph (a)(1) of this section within 30 days of the end of any 12 month period in which their usage of CFC-113 or methyl chloroform used as a solvent exceeds the 95% reduction from calendar year 1990.

§ 82.124 Prohibitions.

(a) *Warning statement* —(1) *Absence or presence of warning statement.* (i) Applicable May 15, 1993, except as indicated in paragraph (a)(5) of this section, no container or product identified in §82.102(a) may be introduced into interstate commerce unless it bears a warning statement that complies with the requirements of §82.106(a) of this subpart, unless such labeling is not required under §82.102(c), §82.106(b), §82.112 (c) or (d), §82.116(a), §82.118(a), or temporarily exempted pursuant to §82.120.

(ii) On January 1, 2015, or any time between May 15, 1993 and January 1, 2015 that the Administrator determines for a particular product manufactured with or containing a class II substance that there are substitute products or manufacturing processes for such product that do not rely on the use of a class I or class II substance, that reduce the overall risk to human health and the environment, and that are currently or potentially available, no product identified in §82.102(b) may be introduced into interstate commerce unless it bears a warning statement that complies with the requirements of §82.106, unless such labeling is not required under §82.106(b), §82.112 (c) or (d), §82.116(a) or §82.118(a).

(2) *Placement of warning statement.* (i) On May 15, 1993, except as indicated in paragraph (a)(5) of this section, no container or product identified in §82.102(a) may be introduced into interstate commerce unless it bears a warning statement that complies with the requirements of §82.108 of this subpart, unless such labeling is not required under §82.102(c), §82.106(b), §82.112 (c) or (d), §82.116(a), §82.118(a), or temporarily exempted pursuant to §82.120.

(ii) On January 1, 2015, or any time between May 15, 1993 and January 1, 2015 that the Administrator determines for a particular product manufactured with or containing a class II substance that there are substitute products or manufacturing processes for such product that do not rely on the use of a class I or class II substance, that reduce the overall risk to human health and the environment, and that are currently or potentially available, no product identified in §82.102(b) may be introduced into interstate commerce unless it bears a warning statement that complies with the requirements of §82.108 of this subpart, unless such labeling is not required under §82.106(b), §82.112 (c) or (d), §82.116(a) or §82.118 (a).

(3) *Form of label bearing warning statement.* (i) Applicable May 15, 1993, except as indicated in paragraph (a)(5) of this section, no container or product identified in §82.102(a) may be introduced into interstate commerce unless it bears a warning statement that complies with the requirements of §82.110, unless such labeling is not required pursuant to §82.102(c), §82.106(b), §82.112 (c) or (d), §82.116(a), §82.118(a), or temporarily exempted pursuant to §82.120.

(ii) On January 1, 2015, or any time between May 15, 1993 and January 1, 2015 that the Agency determines for a particular product manufactured with or containing a class II substance, that there are substitute products or manufacturing processes that do not rely on the use of a class I or class II substance, that reduce the overall risk to human health and the environment, and that are currently or potentially available, no product identified in §82.102(b) may be introduced into interstate commerce unless it bears a warning statement that complies with the requirements of §82.110, unless such labeling is not required pursuant to §82.106(b), §82.112 (c) or (d), §82.116(a), or §82.118(a).

(4) On or after May 15, 1993, no person may modify, remove or interfere with any warning statement required by this subpart, except as described in §82.112.

(5) In the case of any substance designated as a class I or class II substance after February 11, 1993, the prohibitions in paragraphs (a)(1)(i), (a)(2)(i), and (a)(3)(i) of this section shall be applicable one year after the designation of such substance as a class I or class II substance unless otherwise specified in the designation.

[Browse Previous](#) | [Browse Next](#)

For questions or comments regarding e-CFR editorial content, features, or design, email ecfr@nara.gov.

For questions concerning e-CFR programming and delivery issues, email webteam@gpo.gov.

[Section 508 / Accessibility](#)

APPENDIX B

Storage Vessel Parameter Summary Form

11
Storage Vessel Parameter Summary Form

*Some vessels will be limited by molecular weight in lieu of material type.

SN	Description	Maximum Pump Capacity (gal/min)	Allowable Material*	Minimum Allowable Molecular Weight* (lb/lbmol)
BR-08	Recycle HCl Storage Tank	75	Water/HCl	-
CB-04	MeOH Storage Tank	200	MeOH	-
DE-01	Ethanol Storage Tank	150	Ethanol	-
DE-02	Toluene Storage Tank	150	Toluene	-
DE-03	Chaser Storage Tank	120	-	143.00
DE-04	Crude Product Storage Tank	120	Crude DECTP Product	-
DE-06	Product Rundown Storage Tank	160	DECTP Product	-
DE-07	Product Rundown Storage Tank	160	DECTP Product	-
DE-08	Product Rundown Storage Tank	160	DECTP Product	-
DE-09	Product Bulk Storage Tank	160	DECTP Product	-
DE-10	Product Rundown Storage Tank	160	DECTP Product	-
DE-11	Bulk Chaser Storage Tank	160	-	143.00
DE-12	Recovered Oil Storage Tank	125	-	143.00 (excluding water, mw=18; and toluene, mw=92.1)
DE-20	Isopropanol Storage Tank	120	Isopropanol	-
DE-25	Product Storage Tank	160	DECTP Product	-
AD-01	Olefins Storage Tank	100	-	168.30
AD-02	Olefins Storage Tank	100	-	168.30
AD-03	Alkyl Amines Storage Tank	100	-	157.30
AD-07	Alkyl Amine Rundown Tank	20	-	157.30
AD-08	Alkyl Amine Rundown Tank	20	-	157.30
AD-09	Alkyl Amine Rundown Tank	20	-	157.30
AD-10	Alkyl Amine Storage Tank	100	-	157.30
AD-11	Alkyl Amine Storage Tank	100	-	157.30
AD-12	Alkyl Amine Storage Tank	100	-	157.30
AD-13	Alkyl Amine Storage Tank	100	-	157.30

SN	Description	Maximum Pump Capacity (gal/min)	Allowable Material*	Minimum Allowable Molecular Weight* (lb/lbmol)
AD-14	Alkyl Amine Storage Tank	100	-	157.30
AD-15	Alkyl Amine Storage Tank	100	-	157.30
AD-17	Alkyl Amine Storage Tank	100	-	157.30
AD-18	NaBr Recycle Tank	100	-	157.30
AD-20	Olefins Storage Tank	100	-	168.30
AD-21	Olefins Storage Tank	100	-	112.30
AD-23	Alkyl Amine Storage Tank	10	-	157.30
AD-24	Alkyl Amine Storage Tank	100	-	157.30
AD-25	Alkyl Amine Storage Tank	100	-	157.30
AD-27	Recycle Storage Tank	100	-	157.30
AD-28	Recycle Storage Tank	30	-	157.30
AD-29	Recycle Storage Tank	30	-	157.30
AD-37	ADMA Condensate Collection Tank	20	-	157.3
07	Raw Material Storage Tank	100	-	170.20
DB-10	Ethylene Glycol Storage Tank	60	Ethylene Glycol	-
TB-01	MeOH Storage Tank	150	MeOH ADMA Product	157.3 for ADMA
TB-11	MeOH Column Feed Tank	200	MeOH	-
TB-12	Sulfuric Acid Storage Tank	70	Sulfuric Acid/Water	-
TB-15	Hot Water Tank	75	Water/MeOH	-
TB-18	Column Bottoms Tank	75	Water/MeOH	-
TB-30	MeOH Storage Tank	114	MeOH	-
15-09	Refrigerated Coolant Storage	15	Ethylene Glycol	-
15.13	Weigh Tanks	25	-	262
16-15	Propionic Acid Storage Tank	148.7	Propionic Acid	-
16-16	TBPA Neutralization Tank	275	Sulfuric Acid	-
16-17	Ethylene Glycol Tank	900	Ethylene Glycol/Water	-
16-28	TBPA Neutralization Tank	275	Sulfuric Acid	-
02	Slurry Tank	150	Water Slurry of Product	-

SN	Description	Maximum Pump Capacity (gal/min)	Allowable Material*	Minimum Allowable Molecular Weight* (lb/lbmol)
22-06	Extraneous Water Tank	150	Process Wastewater	-
22-07	Ethylene Glycol Storage Tank	50	Ethylene Glycol	-
22-09	Scrubber Tank	100	Aqueous Caustic	-
22-11	HBr Storage Tank	50	Hydrobromic Acid	-
22-12	HBr Storage Tank	50	Hydrobromic Acid	-
BT-01	Feed Brine Oil Separator/Surge Tank	10,200	Feed Brine	-
BT-11	Neutralization Tank	10,600	Tail Brine	-
BT-13	Tail Brine Tank	10,600	Tail Brine	-
BT-17	Brinefield Oil Storage Tank	16.7	Crude Oil	-
DM-01	Ethylene Glycol Tank	30	Ethylene Glycol/Water	-
DM-03	Hydrogen Peroxide Tank 1	300	Hydrogen Peroxide/Water	-
DM-06	Hydrogen Peroxide Tank 2	300	Hydrogen Peroxide/Water	-

CERTIFICATE OF SERVICE

I, Pam Owen, hereby certify that a copy of this permit has been mailed by first class mail to Albemarle Corporation, P.O. Box 729, Magnolia, AR, 71754-0729, on this 25th day of September, 2009.

Pam Owen

Pam Owen, AAIL, Air Division

