

ADEQ

ARKANSAS
Department of Environmental Quality

FEB 13 2018

Kathy Shoemaker, Senior Compliance Manager
Clean Harbors El Dorado, LLC
309 American Circle
El Dorado, AR 71730

Dear Ms. Shoemaker:

The enclosed Permit No. 1009-AOP-R16 is your authority to construct, operate, and maintain the equipment and/or control apparatus as set forth in your application initially received on 10/5/2017.

After considering the facts and requirements of A.C.A. §8-4-101 et seq. as referenced by §8-4-304, and implementing regulations, I have determined that Permit No. 1009-AOP-R16 for the construction and operation of equipment at Clean Harbors El Dorado, LLC shall be issued and effective on the date specified in the permit, unless a Commission review has been properly requested under Arkansas Department of Pollution Control & Ecology Commission's Administrative Procedures, Regulation 8, within thirty (30) days after service of this decision.

The applicant or permittee and any other person submitting public comments on the record may request an adjudicatory hearing and Commission review of the final permitting decisions as provided under Chapter Six of Regulation No. 8, Administrative Procedures, Arkansas Pollution Control and Ecology Commission. Such a request shall be in the form and manner required by Regulation 8.603, including filing a written Request for Hearing with the APC&E Commission Secretary at 101 E. Capitol Ave., Suite 205, Little Rock, Arkansas 72201. If you have any questions about filing the request, please call the Commission at 501-682-7890.

Sincerely,

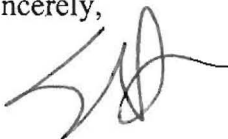

Stuart Spencer
Associate Director, Office of Air Quality

Enclosure: Final Permit

ADEQ OPERATING AIR PERMIT

Pursuant to the Regulations of the Arkansas Operating Air Permit Program, Regulation 26:

Permit No. : 1009-AOP-R16

IS ISSUED TO:

Clean Harbors El Dorado, LLC
309 American Circle
El Dorado, AR 71730
Union County
AFIN: 70-00098

THIS PERMIT AUTHORIZES THE ABOVE REFERENCED PERMITTEE TO INSTALL, OPERATE, AND MAINTAIN THE EQUIPMENT AND EMISSION UNITS DESCRIBED IN THE PERMIT APPLICATION AND ON THE FOLLOWING PAGES. THIS PERMIT IS VALID BETWEEN:

December 26, 2013 AND December 25, 2018

THE PERMITTEE IS SUBJECT TO ALL LIMITS AND CONDITIONS CONTAINED HEREIN.

Signed:



Stuart Spencer
Associate Director, Office of Air Quality

FEB 13 2018

Date

Clean Harbors El Dorado, LLC
 Permit #: 1009-AOP-R16
 AFIN: 70-00098

Table of Contents

SECTION I: FACILITY INFORMATION 5

SECTION II: INTRODUCTION 6

Summary of Permit Activity 6

Process Description 6

Regulations 12

Emission Summary 13

SECTION III: PERMIT HISTORY 21

SECTION IV: SPECIFIC CONDITIONS 26

 SN-01 26

 SN-07 30

 SN-08 33

 SN-09A & SN-09B 35

 SN-11 37

 SN-12 38

 SN-16 39

 SN-18 & SN-47 40

 SN-20 42

 SN-21 44

 SN-24 48

 SN-25 59

 SN-31, SN-35, SN-36, SN-37, SN-38, SN-39, SN-40, and SN-41 63

 SN-32 83

 SN-33 85

 SN-34 87

 SN-42 and SN-43 92

 SN-44 94

 SN-45 99

 SN-46 100

SECTION V: COMPLIANCE PLAN AND SCHEDULE 101

SECTION VI: PLANTWIDE CONDITIONS 102

Divert Stack Events 103

 40 C.F.R. § 61, Subpart C 104

 40 C.F.R. § 61, Subpart E 104

 40 C.F.R. § 61, Subpart FF 105

 40 C.F.R. § 63, Subpart DD 105

 40 C.F.R. § 63, Subpart EEE 134

Risk Assessment Requirements 155

Acid Rain (Title IV) 155

Title VI Provisions 155

SECTION VII: INSIGNIFICANT ACTIVITIES 158

SECTION VIII: GENERAL PROVISIONS 159

Appendix A – 40 CFR Part 60, Subpart Dc

Appendix B – 40 CFR Part 60, Subpart Kb

Clean Harbors El Dorado, LLC
Permit #: 1009-AOP-R16
AFIN: 70-00098

Appendix C – 40 CFR Part 60, Subpart VVa
Appendix D – 40 CFR Part 61, Subpart C
Appendix E – 40 CFR Part 61, Subpart E
Appendix F – 40 CFR Part 61, Subpart V
Appendix G – 40 CFR Part 61, Subpart FF
Appendix H – 40 CFR Part 63, Subpart DD
Appendix I – 40 CFR Part 63, Subpart OO
Appendix J – 40 CFR Part 63, Subpart PP
Appendix K – 40 CFR Part 63, Subpart EEE
Appendix L – Continuous Emission Monitoring Systems Conditions
Appendix M – Waste Fired Boiler Recovered Energy Calculation Plan
Appendix N - 40 CFR Part 63, Subpart ZZZZ
Appendix O - 40 CFR Part 60, Subpart IIII
Appendix P - Notification of Compliance for SN-01
**Appendix Q – Monitoring and Maintaining Carbon Canister for Fugitive Emissions at
Tank Farms**
Appendix R – Lamp Recycling/Bulb Crushing System Standard Operating Procedure

Clean Harbors El Dorado, LLC
Permit #: 1009-AOP-R16
AFIN: 70-00098

List of Acronyms and Abbreviations

Ark. Code Ann.	Arkansas Code Annotated
AFIN	ADEQ Facility Identification Number
C.F.R.	Code of Federal Regulations
CO	Carbon Monoxide
HAP	Hazardous Air Pollutant
lb/hr	Pound Per Hour
MVAC	Motor Vehicle Air Conditioner
No.	Number
NO _x	Nitrogen Oxide
PM	Particulate Matter
PM ₁₀	Particulate Matter Smaller Than Ten Microns
SNAP	Significant New Alternatives Program (SNAP)
SO ₂	Sulfur Dioxide
SSM	Startup, Shutdown, and Malfunction Plan
Tpy	Tons Per Year
UTM	Universal Transverse Mercator
VOC	Volatile Organic Compound

Clean Harbors El Dorado, LLC
Permit #: 1009-AOP-R16
AFIN: 70-00098

SECTION I: FACILITY INFORMATION

PERMITTEE: Clean Harbors El Dorado, LLC

AFIN: 70-00098

PERMIT NUMBER: 1009-AOP-R16

FACILITY ADDRESS: 309 American Circle
El Dorado, AR 71730

MAILING ADDRESS: 309 American Circle
El Dorado, AR 71730

COUNTY: Union County

CONTACT NAME: Kathy Shoemaker

CONTACT POSITION: Senior Compliance Manager

TELEPHONE NUMBER: (870) 864-3711

REVIEWING ENGINEER: Andrea Sandage

UTM North South (Y): Zone 15: 3674169.25 m

UTM East West (X): Zone 15: 534387.21 m

SECTION II: INTRODUCTION

Summary of Permit Activity

Clean Harbors operates a hazardous waste treatment and storage facility located in El Dorado. The primary treatment process consists of incineration and some recycling activities. In accordance with Specific Condition 155 of permit 1009-AOP-R15, the facility submitted 6 months of hourly NO_x monitoring data and an evaluation of the NO_x permit limit for SN-44. The unit was in compliance with the permitted emission rates and did not request a revision to the limits. In addition, operational limits for SN-01 have been revised as a result of the Comprehensive Performance Test (CPT) that was performed in 2016. The total permitted emissions remained unchanged.

Process Description

Fixed Incinerator Unit

Clean Harbors owns and operates an incineration system at their facility in El Dorado, Arkansas, to thermally treat hazardous, medical, and non-regulated wastes generated by other facilities. The incineration system (SN-01) consists of two rotary kilns, a Waste Fired Boiler (WFB), a Secondary Combustion Chamber (SCC), a gas conditioning system, and an air pollution control train. The second incineration system, Unit 44 (SN-44), consists of one rotary kiln, an SCC, a gas conditioning system and air pollution control train.

SN-01 - Wastes are fed to one of four primary feed locations: the two rotary kilns, the WFB, and the SCC. The purpose of the rotary kilns is to pre-process wastes before they are fed to the combustion system. The gases generated in the kilns are fed along with liquid and gaseous wastes to the SCC for thermal treatment. The WFB also receives liquid wastes for thermal treatment.

Combustion gases from the WFB and SCC are combined and routed through a saturator and two-parallel condensing towers for gas conditioning. The saturator rapidly cools the combustion gases as they exit the thermal treatment devices. The gas stream is then split and passes into the condensing towers where it is further cooled, condensing some of the moisture carried with the gases.

Once gas conditioning is complete, the gases from the two towers are combined and are routed to the air pollution control system, which consists of a High Energy Scrubber (HES) and a baghouse. After passing through the condensing towers, the gases are routed to the HES for removal of acid gases. The combustion gases are then reheated with a direct fired natural gas burner to prevent condensation of moisture on the filter bags. Once the temperature of the combustion gases is elevated above the dew point temperature, the combustion gases enter a fabric-filter baghouse for removal of PM, semi-volatile metals (SVM), and low volatile metals (LVM). Activated carbon is introduced into the baghouse for control of dioxins/furans (D/F) and

Clean Harbors El Dorado, LLC
Permit #: 1009-AOP-R16
AFIN: 70-00098

mercury. The treated combustion gases then pass through the induced draft fan and exit through the stack (SN-01). Cooling Tower SN-42 is for Incinerator SN-01.

SN-44 - Wastes are fed to one of two primary feed locations: the rotary kiln or the SCC. The gases generated in the kiln are fed along with liquid and gaseous wastes to the SCC for thermal treatment.

Combustion gases from the SCC are routed through a spray dryer for gas conditioning. The spray dryer rapidly cools the combustion gases using lime, fresh water and scrubber blow down from both the existing incineration unit and the proposed unit. The spray dryer produces dry salt and solids generated from acid gas scrubbing in both the existing and new wet scrubbing units. The gas stream then passes into baghouse #1 for removal of the spray dried salt and solids. Carbon may be added to baghouse #1 to improve control of D/F and mercury.

The gases from baghouse #1 are routed through a saturator column and two parallel condenser towers for gas conditioning. The condensing towers act as the primary acid gas removal device. Lime and or caustic are added to the scrubbing solution to partially neutralize the acid gases as they are scrubbed from the gas stream. After passing through the condensing towers, the gases are routed through a demister to remove entrained droplets. The combustion gases are then reheated with a direct fired natural gas burner to raise the combustion gas temperature several degrees above its dew point. Once the temperature of the combustion gases is elevated above the dew point temperature, the combustion gases enter baghouse #2 for removal of PM, SVM, and LVM. Activated carbon is introduced into baghouse #2 for control of D/F and mercury. The treated combustion gases are then routed through an induced draft fan. Exiting the fan the gases are routed through a SCR DeNO_x unit, where 19% aqueous ammonia solution is introduced to control NO_x emissions. The treated combustion gases then exit through the stack (SN-44). Cooling tower SN-43 is for Incinerator SN-44.

As a precaution to thermal damage of scrubbing chambers and duct work due to unexpected loss of scrubbing solution, it is necessary to have emergency vents known as divert stacks. These stacks are normally closed, and the gases do not normally exit from them to the atmosphere. However, during times of excessive thermal build up in the scrubber (for purposes of this permit to be known as an operational divert stack event), it may be necessary for safety purposes to bypass the normal gas routing, and vent the gases to the atmosphere through the divert stacks. During such events, waste feed is ceased automatically while temperature is maintained to destroy residual organics.

For routine maintenance operations, it is sometimes necessary to route gases to the atmosphere using the divert stacks (for purposes of this permit to be known as a maintenance divert stack event). No waste is fed during these maintenance operations. Procedures for operating the facility during these events are outlined by Plantwide Conditions #6 through #16.

Clean Harbors El Dorado, LLC
Permit #: 1009-AOP-R16
AFIN: 70-00098

Organic Liquid Storage Tanks

Waste organic liquids received at the facility are generally stored in above ground tanks. All tanks have fixed roofs with are connected to piping that routes emissions to incinerator (SN-01) and a new carbon filtration system. The carbon filtration system controls VOC/HAP emissions while the incinerator is not online. Tank 1 has been closed and removed. Tanks emissions are accounted for in SN-21.

On-Site Boilers

Clean Harbors uses a boiler (SN-34) which can be fired with natural gas fuel and a waste-fired boiler (SN-08) to produce steam for use throughout the plant. Only SN-34 normally vents emissions directly to the atmosphere. The waste-fired boiler exhaust is normally vented into the fixed incinerator scrubbing system, but can vent to the atmosphere if the conditions of the air permit are met. When the waste-fired boiler does not burn natural gas and can exhaust directly to the atmosphere, its emissions are regulated under SN-01 of this permit.

Ground Water Recovery System

The site Clean Harbors currently occupies was previously the site of an oil refinery. Various operations at this site have contributed in ground water contamination. To recover and clean the contaminated ground water, Clean Harbors operates a ground water recovery system. The recovery system used to collect two (2) types of groundwater, high chloride and low chloride. Recovered ground water, which is high in chlorides removed as part of the cleanup process, is routed by piping to the quench and scrubber at the fixed incinerator unit (SN-01). All emissions associated with high chloride groundwater are accounted for SN-01. In addition, nine (9) solar sipper LNAPL recovery systems (Insignificant Activity) are used to remove LNAPL from low chloride groundwater areas. Clean Harbors no longer collects low chloride groundwater, however collects surface water from process areas and treats it with carbon at the wastewater treatment plant prior to discharge.

Ash Treatment Process and Metal Recovery Process

Ash generated by the two rotary kilns in the fixed incinerator unit (SN-01) and the new incineration system, Unit 44 (SN-44) discharges from the kilns into a water quench. It is removed from the water quench via ash drag systems, and then transported to an on-site treatment area (the ash solidification building). The ash solidification building is enclosed and controlled by a baghouse (SN-07). A metal recovery system is used to recycle the metal that has been processed through the kilns. The ash will still be transferred to the ash solidification building (Tank 111TNK566), the metal pieces will be sorted out of the tank and placed into a metal shredding unit. The metal shards are then removed from the shredder discharge with a magnetic separator and any residual ash generated from the shredding process is routed back into 111TNK566. The magnetically separated metal shards are conveyed to a trommel screen located in the metal recovery building. The trommel screen is equipped with water sprays to clean the remaining ash and debris from the surface of the metal shards. The clean metal shards are then

Clean Harbors El Dorado, LLC
Permit #: 1009-AOP-R16
AFIN: 70-00098

loaded into bin trucks for recycle. The residual ash in the trommel screen rinse water is removed by settlement and filtration steps. The removed ash is then returned to 111TNK566 for processing. Any mist generated from the water sprays in the trommel screen is exhausted through a demister and then ducted to the solidification building where they will exhaust through a baghouse (SN-07).

The wet ash will have hydrated lime added to absorb excess moisture. Lime/cement kiln dust is added as absorbent. Emissions will be generated when the solidification agent is pneumatically delivered to the silo. These emissions will be controlled with bin vents (SN-18 and SN-47) on the silos. Emissions will also be generated during the solidification activities and the transfer from the solidification pit to the gondola (SN-48). Emissions associated with gondola transferring operations are controlled with a baghouse.

Brine Unit

Wastes containing chlorinated hydrocarbon compounds which are incinerated at this facility are broken into carbon dioxide (CO₂), water vapor, and acid gases such as hydrochloric acid (HCl). The incinerator air pollution control equipment removes the majority of the HCl. This process results in the production of calcium chloride (CaCl₂) in a liquid form referred to as “scrubber brine.” The calcium chloride and entrained particulates are recirculated in the control system until a predetermined specific gravity is achieved.

A portion of this solution is routed to the Brine Unit for recovery as 40% calcium chloride fluid via vacuum evaporation. Lime or NaSH, Na₂S, or similar sulfide compounds are used to treat the scrubber brine used to produce this product. The lime or NaSH react with any metals that may be in the scrubber brine. The resulting insoluble metal hydroxides or sulfides are removed by filtration. A small amount of hydrogen sulfide (H₂S) may be produced in this process. The hydrogen sulfide is removed by a wet scrubber (SN-16) located on the batch tank vent. Other process equipment at the Brine Plant is addressed in SN-14, SN-15, and SN-22.

Stationary Internal Combustion Sources

Clean Harbors maintains four emergency generators and one firewater pump. Each is a diesel-fueled internal combustion engine. They are addressed in SN-24.

Miscellaneous Sources

In addition to the above listed sources, Clean Harbors has several other emission points.

Clean Harbors has a 1,000 gallon diesel tank and a 500 gallon diesel tank (SN-12) and a 1,000 gallon gasoline tank (SN-11). These are all aboveground tanks.

Lime is received in bulk shipments by tank truck for use in the incinerator scrubber systems. The only time there are emissions is during the off loading of the lime into the batch tank.

Clean Harbors El Dorado, LLC
Permit #: 1009-AOP-R16
AFIN: 70-00098

Emissions from the loading operation are controlled by baghouses (SN-09A, SN-09B and SN-20). From the lime batch tank, the lime slurry is pumped to a day tank from which the lime is fed to the scrubber.

Other miscellaneous sources include: drum sampling; waste repackaging; fugitive emissions from pumps, flanges and valves; tanker and railcar cleaning; railcar unloading; tanker loading and unloading; roll-off loading and unloading; vacuum truck loading; equipment and truck wash/decontamination; barrel crushing; empty drum storage; fugitive dust from unpaved and paved roads; and railcar loading. These are addressed in SN-25.

A non-hazardous waste shredder (SN-33) is used to reduce the volume of non-hazardous debris and other solid wastes.

Solvent Recovery System

Phase I was installed and operated to process n-methylpyrrolidone (NMP), a non-HAP organic solvent with low vapor pressure. Phase II will be installed and operated to process organic solvents for recycle with a maximum vapor pressure of 6.159 psia at 65°F and includes HAP-containing solvents. The Phase I equipment included a vacuum pot-type solvent recovery system, a heat exchanger, and storage tanks. Phase I included two cooling towers (SN-35 and SN-36), Tanks 201 through 204 and Tanks 600-TNK-505 through 600-TNK-508 (SN-31). Phase II equipment will include a thin film evaporator and two distillation columns (SN-37), three new waste solvent storage tanks at SN-31 (600-TNK-502 through 504), 23 new intermediate and product storage tanks at SN-31 (600-TNK-505 through 527), two cooling towers (SN-35 and SN-36), railcar loading (SN-38), drum filling (SN-39), tanker loading (SN-40), and fugitives emissions (SN-41).

Waste solvents will be received in drums, totes, bulk tanker trucks or bulk rail and stored in Tanks 144-TNK-201 through 204 and 600-TNK-502 through 504. These tanks will normally vent to the secondary combustion chamber (SCC) but may be vented through dual carbon canisters in series when the SCC is not available. Up to 58,600 gallons of waste solvent are processed per day by transfer from the waste storage tanks to the vacuum pot, the thin film evaporator, or the distillation columns. The process emissions will normally be vented through the SCC but may be vented through the dual carbon canisters in series when the SCC is not operating. Intermediate and product solvent will be stored in Tanks 600-TNK-505 through 527. These tanks will vent directly to the SCC with carbon units used as backup when the SCC is not operating. The final product is either bulk loaded into a tank truck or railcar or pumped into drums for shipment to customers. Railcar loading is controlled with carbon canisters in series and tanker loading emissions are captured through a vapor balance system and sent back to the tanks being unloaded.

Lamp Recycling System

The lamp recycling system (SN-32) processes fluorescent lamps. The bulbs are crushed and separated into glass, end caps, and phosphor powder. Emissions from the bulb crusher are

Clean Harbors El Dorado, LLC

Permit #: 1009-AOP-R16

AFIN: 70-00098

exhausted into a baghouse for particulate removal followed by a carbon absorber for mercury removal.

Regulations

The following table contains the regulations applicable to this permit.

Regulations
Arkansas Air Pollution Control Code, Regulation 18, effective March 14, 2016
Regulations of the Arkansas Plan of Implementation for Air Pollution Control, Regulation 19, effective March 14, 2016
Regulations of the Arkansas Operating Air Permit Program, Regulation 26, effective March 14, 2016
40 C.F.R. § 60 Subpart Dc - Standards of Performance for Small Industrial-Commercial-Institutional Steam Generating Units
40 C.F.R. § 60 Subpart Kb – National Emission Standards for Volatile Organic Liquids Storage Vessels (Including Petroleum Liquid Storage Vessels) for which Construction, Reconstruction, or Modification Commenced After July 23, 1984
40 C.F.R. § 60 Subpart VVa – Standards of Performance for Equipment Leaks of VOC in the Synthetic Organic Chemicals Manufacturing Industry for Which Construction, Reconstruction, or Modification Commenced After November 7, 2006
40 C.F.R. § 61 Subpart C – National Emission Standard for Beryllium
40 C.F.R. § 61 Subpart E – National Emission Standard for Mercury
40 C.F.R. § 61 Subpart V – National Emission Standard for Equipment Leaks (Fugitive Emission Sources)
40 C.F.R. § 61 Subpart FF – National Emission Standard for Benzene Waste Operations
40 C.F.R. § 63 Subpart DD – National Emission Standards for Hazardous Air Pollutants from Off-Site Waste and Recovery Operations
40 C.F.R. § 63 Subpart OO – National Emission Standards for Tanks—Level 1
40 C.F.R. § 63 Subpart PP – National Emission Standards for Containers
40 C.F.R. § 63 Subpart EEE – National Emission Standards for Hazardous Air Pollutants from Hazardous Waste Combustors
40 C.F.R. § 64 – Compliance Assurance Monitoring
40 C.F.R. § 82 Subpart F – Protection of Stratospheric Ozone, Subpart F, Recycling and Emissions Reduction

Emission Summary

The following table is a summary of emissions from the facility. This table, in itself, is not an enforceable condition of the permit.

Source Number	Description	Pollutant	Emission Rates	
			lb/hr	tpy
Total Allowable Emissions		PM	31.7	83.5
		PM ₁₀	19.6	58.7
		PM _{2.5}	-	See Note****
		SO ₂	91.9	94.8
		VOC	64.2	43.9
		CO	66.1	233.7
		NO _x	266.4	534.3
HAPs		Lead Compounds*	0.08	0.26
		Antimony Compounds*	0.68	2.97
		Arsenic Compounds*	0.05	0.14
		Beryllium Compounds*	0.03	0.14
		Cadmium Compounds*	0.06	0.26
		Calcium cyanimide*	3.07	13.37
		Chlorine***	15.43	67.51
		Chromium Compounds*	0.03	0.12
		Cobalt Compounds*	1.09	4.69
		Cyanide Compounds*	3.07	13.37
		Dioxins/Furans*	1.07E-7	4.69E-7
		Fluorene*	0.02	0.02
		Hydrazine	2.07	9.04
		Hydrochloric acid	15.88	69.50
		Hydrogen fluoride	6.85	30.03
		Manganese Compounds*	10.59	46.30
		Mercury Compounds*	0.06	0.16
		Methyl chloroform	16.44	19.86
		Methylene chloride	31.39	27.08
		Nickel Compounds*	2.59	11.26
		Phenanthrene*	0.02	0.02
		Phosphine	3.10	13.45
		Phosphorus*	3.07	13.37
	Selenium Compounds*	5.60	24.40	
	Tetrachloroethylene	5.33	14.53	
	Titanium tetrachloride	3.10	13.45	
	Single Organic HAP*	53.58	36.99	
	Total Organic HAP*	53.60	37.08	
Air Contaminants **		H ₂ S	0.1	0.1
		Ammonia	2.3	9.8

Clean Harbors El Dorado, LLC
 Permit #: 1009-AOP-R16
 AFIN: 70-00098

Source Number	Description	Pollutant	Emission Rates	
			lb/hr	tpy
SN-01	Fixed Incinerator Unit	PM	6.7	29.3
		PM ₁₀	6.7	29.3
		SO ₂	45.0	59.0
		VOC	1.2	5.3
		CO	26.6	116.5
		NO _x	158.2	451.0
		Lead Compounds	0.0516a	0.23a
		Antimony Compounds	0.11	0.49
		Arsenic Compounds	0.0206b	0.10b
		Beryllium Compounds	0.0206b	0.10b
		Cadmium Compounds	0.0516a	0.23a
		Calcium cyanimide	1.221	5.35
		Chlorine	10.605c	46.46c
		Chromium Compounds	0.0206b	0.10b
		Cobalt Compounds	0.50	2.19
		Cyanide Compounds	1.221	5.35
		Dioxins/Furans	8.99E-8	3.94E-7
		Hydrazine	1.02	4.48
		Hydrochloric acid	10.918c	47.83c
		Hydrogen fluoride	6.22	27.25
		Manganese Compounds	10.00	43.80
		Mercury Compounds	0.029	0.13
		Methyl chloroform	1.221	5.35
		Methylene chloride	1.221	5.35
		Nickel Compounds	2.00	8.76
		Phosphine	1.221	5.35
Phosphorus	1.221	5.35		
Selenium Compounds	5.00	21.90		
Tetrachloroethylene	1.221	5.35		
Titanium tetrachloride	1.221	5.35		
Single Organic HAP	1.221	5.35		
Total Organic HAP	1.221	5.35		
SN-07	Solidification Building	PM	1.9	8.0
		PM ₁₀	1.9	8.0

Source Number	Description	Pollutant	Emission Rates	
			lb/hr	tpy
SN-08	Waste Fired Boiler (Natural Gas Only)	PM	0.5	2.2
		PM ₁₀	0.5	2.2
		SO ₂	0.1	0.2
		VOC	0.4	1.6
		CO	5.5	23.9
		NO _x	6.5	28.4
		Lead Compounds	0.01	0.01
		Arsenic	0.01	0.01
		Beryllium	0.0001	0.01
		Cadmium	0.001	0.01
		Cobalt	0.01	0.01
		Fluorene	0.01	0.01
		Manganese	0.01	0.01
		Mercury	0.01	0.01
		Nickel	0.01	0.01
		Phenanthrene	0.01	0.01
Selenium	0.01	0.01		
Single Organic HAP	0.12	0.51		
Total Organic HAP	0.13	0.54		
SN-09A	Lime Silo Bin Vent	PM	1.5	0.7d
		PM ₁₀	1.0	0.5d
SN-09B	Lime Silo Bin Vent	PM	1.5	0.7d
		PM ₁₀	1.0	0.5d
SN-11	Gasoline Storage Tank	VOC	6.6	0.4
SN-12	Diesel Storage Tank	VOC	0.1	0.1
SN-16	Brine Reactor Vessel	H ₂ S	0.1	0.1
SN-18 & SN-47	Solidification Silo Bin Vent	PM	0.8	0.3
		PM ₁₀	0.5	0.2
SN-20	Lime Perma Batch Tank	PM	0.2	0.7
		PM ₁₀	0.2	0.7
SN-21	Organic Liquid Waste Tanks	VOC	1.0	2.0
		Methyl chloroform	0.46	0.89
		Methylene chloride	0.97	1.90
		Tetrachloroethylene	0.09	0.18
		Single Organic HAP	0.97	1.90
Total Organic HAP	0.97	1.90		
SN-22	Brine Plant Sources	Moved to IA		

Clean Harbors El Dorado, LLC
 Permit #: 1009-AOP-R16
 AFIN: 70-00098

Source Number	Description	Pollutant	Emission Rates	
			lb/hr	tpy
SN-24A	Fire Pump Generator Lister (44.25 HP)	PM	0.1	0.1
		PM ₁₀	0.1	0.1
		SO ₂	0.1	0.1
		VOC	0.2	0.1
		CO	0.4	0.1
		NO _x	1.4	0.1
		Fluorene	0.01	0.01
		Phenanthrene	0.01	0.01
		Single Organic HAP	0.01	0.01
		Total Organic HAP	0.01	0.01
SN-24B	Fire Pump CAT 3208 (196HP)	PM	0.5	0.1
		PM ₁₀	0.5	0.1
		SO ₂	0.4	0.1
		VOC	0.5	0.1
		CO	1.4	0.1
		NO _x	6.1	0.4
		Fluorene	0.01	0.01
		Phenanthrene	0.01	0.01
		Single Organic HAP	0.01	0.01
		Total Organic HAP	0.01	0.01
SN-24C	Generator Kohler 200ROZ (275 HP)	PM	0.6	0.1
		PM ₁₀	0.6	0.1
		SO ₂	0.6	0.1
		VOC	0.7	0.1
		CO	1.9	0.1
		NO _x	8.5	0.5
		Fluorene	0.01	0.01
		Phenanthrene	0.01	0.01
		Single Organic HAP	0.01	0.01
		Total Organic HAP	0.01	0.01
SN-24D	Generator CAT 3412-SR4 (805 HP)	PM	0.6	0.1
		PM ₁₀	0.6	0.1
		SO ₂	0.3	0.1
		VOC	0.6	0.1
		CO	4.8	0.3
		NO _x	18.1	1.0
		Fluorene	0.01	0.01
		Phenanthrene	0.01	0.01
		Single Organic HAP	0.01	0.01
		Total Organic HAP	0.01	0.01

Clean Harbors El Dorado, LLC
 Permit #: 1009-AOP-R16
 AFIN: 70-00098

Source Number	Description	Pollutant	Emission Rates	
			lb/hr	tpy
SN-24E	Unit 44 Generator (275 755 HP)	PM	0.3	0.1
		PM ₁₀	0.3	0.1
		SO ₂	0.3	0.1
		VOC	0.5	0.1
		CO	4.4	0.3
		NO _x	8.0	0.4
		Fluorene	0.01	0.01
		Phenanthrene	0.01	0.01
		Single Organic HAP	0.01	0.01
		Total Organic HAP	0.01	0.01
SN-25	Plant Fugitives	PM	8.4	7.6
		PM ₁₀	1.7	1.6
		VOC	23.2	15.7
		Chlorine	0.03	0.08
		Hydrazine	0.03	0.08
		Hydrochloric acid	0.03	0.08
		Hydrogen fluoride	0.03	0.08
		Methyl chloroform	0.33	1.40
		Methylene chloride	0.67	2.91
		Phosphine	0.03	0.08
		Tetrachloroethylene	0.07	0.28
		Titanium tetrachloride	0.03	0.08
		Single Organic HAP	22.62	11.89
Total Organic HAP	22.62	11.89		
SN-31	Solvent Recovery System Storage Tanks	VOC	5.2	0.7
		Methyl chloroform	2.42	0.31
		Methylene chloride	5.14	0.66
		Tetrachloroethylene	0.40	0.05
		Single Organic HAP	5.14	0.66
Total Organic HAP	5.14	0.66		
SN-32	Lamp Recycling System	PM	0.1	0.1
		PM ₁₀	0.1	0.1
		Mercury	0.000013	0.000057
SN-33	Non-Hazardous Waste Shredder	PM	0.2	0.5
		PM ₁₀	0.2	0.5

Clean Harbors El Dorado, LLC
 Permit #: 1009-AOP-R16
 AFIN: 70-00098

Source Number	Description	Pollutant	Emission Rates	
			lb/hr	tpy
SN-34	No. 1 Package Boiler (33.75 MMBtu/hr Natural Gas Fired)	PM	0.3	1.2
		PM ₁₀	0.3	1.2
		SO ₂	0.1	0.1
		VOC	0.2	0.9
		CO	2.8	12.2
		NO _x	3.4	14.5
		Lead Compounds	0.01	0.01
		Arsenic Compounds	0.01	0.01
		Beryllium Compounds	0.0001	0.01
		Cadmium Compounds	0.001	0.01
		Fluorine	0.01	0.01
		Cobalt Compounds	0.01	0.01
		Manganese Compounds	0.01	0.01
		Mercury Compounds	0.01	0.01
		Nickel Compounds	0.01	0.01
		Phenanthrene	0.01	0.01
Selenium Compounds	0.01	0.01		
Single Organic HAP	0.06	0.27		
Total Organic HAP	0.07	0.28		
SN-35	Solvent Recovery System Cooling Tower	PM	0.3	1.3
		PM ₁₀	0.3	1.3
SN-36	Solvent Recovery System Cooling Tower	PM	0.3	1.3
		PM ₁₀	0.3	1.3
SN-37	Solvent Recovery System Process Emissions	VOC	5.9	2.2
		Methyl chloroform	2.77	1.00
		Methylene chloride	5.88	2.12
		Tetrachloroethylene	0.46	0.16
		Single Organic HAP	5.88	2.12
Total Organic HAP	5.88	2.12		
SN-38	Solvent Recovery System Railcar Loading	VOC	0.9	0.2
		Methyl chloroform	0.41	0.08
		Methylene chloride	0.87	0.16
		Tetrachloroethylene	0.07	0.02
		Single Organic HAP	0.87	0.16
Total Organic HAP	0.87	0.16		

Source Number	Description	Pollutant	Emission Rates	
			lb/hr	tpy
SN-39	Solvent Recovery System Drum Filling	VOC	4.0	0.4
		Methyl chloroform	1.88	0.19
		Methylene chloride	3.97	0.40
		Tetrachloroethylene	0.31	0.04
		Single Organic HAP	3.97	0.40
		Total Organic HAP	3.97	0.40
SN-40	Solvent Recovery System Tanker Loading	VOC	10.9	5.6
		Methyl chloroform	5.09	2.61
		Methylene chloride	10.81	5.54
		Tetrachloroethylene	0.85	0.42
		Single Organic HAP	10.81	5.54
		Total Organic HAP	10.81	5.54
SN-41	Solvent Recovery System Fugitive	VOC	0.1	0.1
		Methyl chloroform	0.01	0.01
		Methylene chloride	0.01	0.02
		Tetrachloroethylene	0.01	0.01
		Single Organic HAP	0.01	0.02
		Total Organic HAP	0.01	0.02
SN-42	Cooling Tower for SN-01	PM	3.4	14.8
		PM ₁₀	0.6	2.3
SN-43	Cooling Tower for SN-44	PM	0.3	1.2
		PM ₁₀	0.1	0.2
SN-44	Fixed Incinerator Unit 44	PM	0.6	2.5
		PM ₁₀	0.6	2.5
		SO ₂	45.0	35.0
		VOC	1.9	8.1
		CO	18.3	80.2
		NO _x	56.2	38.0
		Lead Compounds	0.0016a	0.007a
		Antimony Compounds	0.57	2.48
		Arsenic Compounds	0.0036b	0.016b
		Beryllium Compounds	0.0036b	0.016b
		Cadmium Compounds	0.0016a	0.007a
		Calcium cyanimide	1.84	8.02
		Chlorine	4.79c	20.97c
		Chromium Compounds	0.0036b	0.016b
		Cobalt Compounds	0.57	2.48
		Cyanide Compounds	1.84	8.02
		Dioxins/Furans	1.701E-8	7.451E-8
Hydrazine	1.02	4.48		
Hydrochloric acid	4.93c	21.59c		
Hydrogen fluoride	0.60	2.70		

Source Number	Description	Pollutant	Emission Rates	
			lb/hr	tpy
		Manganese Compounds	0.57	2.48
		Mercury Compounds	0.002e	0.009
		Methyl chloroform	1.84	8.02
		Methylene chloride	1.84	8.02
		Nickel Compounds	0.57	2.48
		Phosphine	1.84	8.02
		Phosphorus	1.84	8.02
		Selenium Compounds	0.57	2.48
		Tetrachloroethylene	1.84	8.02
		Titanium tetrachloride	1.84	8.02
		Single Organic HAP	1.84	8.02
		Total Organic HAP	1.84	8.02
		Ammonia**	2.3	9.8
SN-45	Fuel Storage Tank	VOC	0.1	0.1
		Single HAP	0.01	0.01
		Total HAPs	0.01	0.01
SN-46	Gondola Transferring Operations	PM	2.6	11.3
		PM ₁₀	1.5	6.2

*HAPs included in the VOC or PM totals. Other HAPs are not included in any other totals unless specifically stated.

**Air Contaminants such as ammonia, acetone, and certain halogenated solvents are not VOCs or HAPs.

***Included in HCl total.

****PM_{2.5} limits are source specific, if required. Not all sources have PM_{2.5} limits.

- a. Combined limits for lead and cadmium at SN-01 and SN-44.
- b. Combined limits for arsenic, beryllium, and chromium at SN-01 and SN-44.
- c. Combined limit of 32 ppm for chlorine and hydrogen chloride emissions at SN-01 and 21 ppm for SN-44, expressed as chloride equivalent.
- d. Combined yearly limits for PM and PM₁₀ at SN-09A and SN-09B

Clean Harbors El Dorado, LLC
Permit #: 1009-AOP-R16
AFIN: 70-00098

SECTION III: PERMIT HISTORY

Permit 249-A was issued to Pollution Controls, Inc. on June 19, 1974. This is the initial permit for construction of this facility.

Permit 249-A(Modification) was issued on September 13, 1976 to update scrubber operation at the facility.

Permit 461-A was issued to ENSCO on December 1, 1977. This permit allowed for the installation and operation of equipment designed for the incineration of drummed solids, semi-solids, and liquids such as PCB impregnated capacitors.

Permit 509-A was issued to ENSCO on August 1, 1978. This allowed for construction of a waste destruction system to handle NaK by reacting it with steam.

Permit 249-A(Modification) was issued to Ensco on July 24, 1981. This permit revised the design of the system to update the existing control equipment at the facility.

Permit 249-AR-3 was issued to Ensco, Inc. on March 25, 1983. This allowed for installation of a waste fuel fired boiler.

Permit 754-A was issued to ENSCO, Inc. on May 8, 1985. It allowed for construction and operation of a mobile incinerator, the MWP-2000 (SN-02).

Permit 1009-A was issued to ENSCO, Inc., on August 15, 1990. This permit consolidated permits 249-AR-3, 461-A, 509-A, and 754-A.

Permit 1009-AR-1 was issued to ENSCO, Inc., on June 9, 1992. This permit added a residue treatment facility which removed ferrous metals from the incinerator ash and also added the lime silo. Also, this permit removed a CEM requirement for SO₂ because the moisture content of the stack gases was greater than existing CEMs were able to overcome.

Permit 1009-AR-2 was issued to ENSCO, Inc., on May 5, 1993. This permit adjusted the emission values for NO_x. Because of this increase, CEMs were added to measure NO_x in the incinerator stacks.

Permit 1009-AR-3 was issued to ENSCO, Inc., on October 8, 1993. This permit allowed addition of a storage silo and changes to the ferrous metal recovery system. ENSCO also permitted previously unpermitted storage tanks.

Permit 1009-AR-4 was issued to Ensco, Inc., on November 16, 1993. This permit allowed for installation of the lime batch tank.

Permit 1009-AR-5 was issued to Ensco, Inc., on May 25, 1994. This permit allowed the installation of a baghouse to replace a wet scrubber on the lime handling system.

Clean Harbors El Dorado, LLC
Permit #: 1009-AOP-R16
AFIN: 70-00098

Permit 1009-AR-5 was transferred to Teris, L.L.C., on July 25, 2001.

Permit 1009-AOP-R0 was issued to Teris, L.L.C. on May 1, 2002. This was the initial Title V permit for this facility.

Permit 1009-AOP-R0 was administratively amended on October 9, 2002. This amendment added a 5,000 gallon Sulfuric Acid Storage Tank to the Insignificant Activities List.

Permit 1009-AOP-R1 was issued to Teris, L.L.C. on September 10, 2003. This permit allowed for replacement of a heat exchanger on SN-01 with a direct-fired natural gas heater. Emissions from the combustion of natural gas were routed through the existing SN-01 stack. This resulted in the addition of 0.4 tpy of PM/PM₁₀, 0.1 tpy of SO₂, 0.3 tpy of VOC, 3.7 tpy of CO, and 4.4 tpy of NO_x.

Permit 1009-AOP-R2 was issued on September 23, 2005. This minor modification allowed for installation of an Aerosol Processing Machine (APM), a Solvent Recovery Process (with package units) (SRP), a Refrigerant Reclaim Process, and a Refrigerant Reclaim Process Boiler. The APM (SN-27) is used to recover metals for recycling from aerosol cans and paint cans. The off-gasses of the APM are normally routed to the existing Secondary Combustion Chamber to destroy any combustibles. Under special operation conditions where paint cans are being crushed and off-gas flows are minuscule, the off-gasses were routed through an Activated Carbon Unit included with the APM. VOC emissions were 0.2 tons per year. The SRP (SN-28) was a distillation process which was used to reclaim halogenated type solvents. The non-condensable off-gasses of the SRP were routed to the existing Secondary Combustion Chamber to destroy any combustibles. When gases cannot be routed to the SCC, the condenser overhead gases will be routed to an Activated Carbon Unit included with the SRP. Emissions for this Unit were 0.21 tons per year of Non-VOC Refrigerant and 0.21 tons per year of Methylene Chloride (which is a HAP, but not a VOC). The Refrigerant Reclaim Process (SN-29) and a Refrigerant Reclaim Process Boiler (SN-30) were limited to non-VOC and non-HAP refrigerants, but were subject to 40 C.F.R. § 82, Subpart F. The permit included VOC and HAP emissions to account for trace contaminants in the refrigerants.

Permit 1009-AOP-R3 was issued on August 15, 2008. This permitting action was necessary to renew the facility's Title V air permit; update the MACT EEE requirements; add the operational limits established during the comprehensive performance test; increase the feed capacity from 42,410 lb/hr to 53,320 lb/hr; decrease the destruction and removal efficiency at SN-01 for organic HAPs (excluding dioxins and furans) from 99.999% to 99.998% based on testing; update the Cl₂ and HCl rates at SN-01 to coincide with MACT EEE; remove the following sources: SN-02, SN-05, SN-06, SN-10, SN-14, SN-28, SN-29, and SN-30, a 1.0 MMBtu/hr natural gas fired boiler at SN-22, Tanks 98, 99, 100, 510, and 543 at SN-21, Kiln #3 from the permit since this source was removed from the site, sulfuric acid tank from the insignificant activities list, and the lime storage silo from the insignificant activities list since this source vents to SN-01; remove the hazardous waste derived fuel burning operating scenario for SN-04; increase gasoline throughput at SN-11; increase diesel throughput at SN-12; add a new 500 gallon diesel storage tank to SN-12; transfer SN-13 and SN-15 to the insignificant activities list; increase the control

Clean Harbors El Dorado, LLC
Permit #: 1009-AOP-R16
AFIN: 70-00098

efficiency of the carbon canisters at SN-21 based on a verbal statement from the carbon manufacturer; specify the use of carbon canisters at SN-25 Tanker Loading/Unloading (Tank Transfer); specify the use of carbon tank at SN-25 Drum Pumping; replace the HAP content limits with a TLV table; add and update various compliance mechanisms in the permit; and permit Phase I of a Solvent Recovery Plant which will include a vacuum pot-type solvent recovery system, a heat exchanger, and four storage tanks (SN-31, 600-TNK-501 through 600-TNK-504). The total permitted annual emission rate limit increases associated with this modification included: 0.067 tons per year (tpy) beryllium compounds, 3.01 tpy calcium cyanamide, 94.51 tpy chlorine, 2.24 tpy cyanide compounds, 2.24 tpy hydrazine, 2.24 tpy phosphine, 2.18 tpy phosphorus, 1.41 tpy tetrachloroethylene, 2.24 tpy titanium tetrachloride, and 4.26 to 19.98 tpy single organic HAP. The total permitted annual emission rate limit decreases associated with this modification include: 109.0 tpy PM, 123.2 tpy PM₁₀, 57.3 tpy SO₂, 18.1 tpy VOC, 4.1 tpy CO, 197.9 tpy NO_x, 0.13 tpy antimony compounds, 5.95 tpy arsenic compounds, 2.94 tpy cadmium compounds, 2.49 tpy caprolactam dust, 2.49 tpy caprolactam vapor, 25.16 tpy chromium compounds, 0.67 tpy cobalt compounds, 59.59 tpy hydrochloric acid, 7.26 tpy hydrogen fluoride, 85.81 tpy lead compounds, 4.38 tpy manganese compounds, 5.04 tpy mercury compounds, 2.92 tpy methyl chloroform, 1.19 tpy methylene chloride, 43.41 tpy nickel compounds, 8.67 tpy selenium compounds, 0.1 tpy NaOH, 0.1 tpy NaSH, 22.71 tpy refrigerant (non-VOC), and 578.7 tpy total organic HAP.

Permit 1009-AOP-R4 was issued on January 7, 2009. This permitting action was necessary to install a Lamp Recycling System (SN-32) to process fluorescent lamps. The total permitted annual emission rate limit increases associated with this modification included: 0.1 tons per year (tpy) PM/PM₁₀ and 0.000057 tpy mercury.

Permit 1009-AOP-R5 was issued on April 6, 2009. This permitting action was necessary to address the applicable requirements of 40 C.F.R. §63.1219; limit the liquid boiler (SN-01) recovered energy utilization rate; update the description of the Organic Liquid Waste Tanks (SN-21); and correct the NSPS applicability of the Organic Liquid Waste Tanks (SN-21) to 40 C.F.R. § 60, Subpart Kb. The total permitted annual emission rate limit decreases associated with this modification included: 4.5 tons per year (tpy) PM/PM₁₀, 0.01 tpy lead compounds, 0.01 tpy cadmium compounds, 65.31 tpy chlorine, and 67.27 tpy hydrogen chloride.

Permit 1009-AOP-R6 was issued on July 6, 2009. This permitting action was necessary to increase the permitted throughput of the Organic Liquid Waste Tanks (SN-21) from 5,164,590 gallons per year to 10,000,000 gallons per year. The total permitted annual emission rate limit increases associated with this modification included: 0.3 tons per year (tpy) VOC, 0.3 tpy methylene chloride, 0.3 tpy single organic HAP, and 0.3 tpy total organic HAP.

Permit 1009-AOP-R7 was issued on July 16, 2010. This permitting action was necessary to: install a non-hazardous waste shredder (SN-33); increase the throughput at SN-25 of the tanker and railcar cleaning from 400 tanker trucks/yr to 750 tanker trucks/yr, the amount of loading tankers pumped from 600 tankers/yr to 1,200 tankers/yr, the gallons of vacuum truck loading from 156,000 gal/yr to 500,000 gal/yr, and the miles of 18-wheeler traffic on paved roads from 1,660 miles/yr to 2,100 miles/yr; update the road emission calculations based on an adjusted

Clean Harbors El Dorado, LLC
Permit #: 1009-AOP-R16
AFIN: 70-00098

vehicle weight at SN-25; permit railcar loading operations at SN-25; replace the 84 MMBtu/hr natural gas fired boiler (SN-04) with a 33.75 MMBtu/hr natural gas/diesel fired boiler (SN-34); correct the vapor pressure limit at SN-21; and permit Phase 2 of the Solvent Recovery System: install 3 new waste solvent storage tanks at SN-31 (600-TNK-502 through 504); install 23 new intermediate and product storage tanks at SN-31 (600-TNK-505 through 527); permit existing tanks 144-TNK-201 through 204 under SN-31 instead of SN-21; install a thin film evaporator and two distillation columns (SN-37); install two cooling towers (SN-35 and SN-36); install railcar loading (SN-38), drum filling (SN-39), and tanker loading (SN-40); permit fugitive emissions (SN-41); increase the vapor pressure limit for materials processed; and permit the processing of HAP-containing materials. The total permitted annual emission rate limit changes associated with this modification included: 2.6 tons per year (tpy) PM, 7.4 tpy PM₁₀, 39.0 tpy SO₂, 9.0 tpy VOC, -18.5 tpy CO, -41.8 tpy NO_x, 0.01 tpy lead compounds, 0.01 tpy arsenic compounds, 0.01 tpy beryllium compounds, 0.01 tpy cadmium compounds, 0.01 tpy chromium compounds, 0.01 tpy cobalt compounds, 0.01 tpy manganese compounds, 0.01 tpy mercury compounds, 5.6 tpy methyl chloroform, 8.11 tpy methylene chloride, 0.01 tpy nickel compounds, 0.01 tpy selenium compounds, 2.77 tpy tetrachloroethylene, 10.28 tpy single organic HAP, and 10.36 tpy total organic HAP.

Permit 1009-AOP-R8 was issued on March 17, 2011. This permitting action was necessary to remove Cyclone #1 from Kiln #1 at SN-01 and reduce the semivolatile and low volatile metals feed rate limits to correspond with the data in lieu of the initial comprehensive performance test submitted in October 2008. The total permitted annual emission rate limits did not change with this modification.

Permit 1009-AOP-R9 was issued on November 15, 2011. This permitting action was necessary to permit a metal recovery system at SN-07 to recycle the metal that has been processed through the kilns. The emissions exhaust through the existing baghouse at SN-07. The total permitted annual emission rate limits did not change with this minor modification.

Permit 1009-AOP-R10 was issued on November 1, 2012. This permitting action was necessary to increase the SO₂ and NO_x emission limits for the incineration system at SN-01, permit the waste-fired boiler (SN-08) for 8,760 hours per year of operation, remove the waste oil tank SN-19, add a 10,000 gal diesel storage tank and dispenser unit as a Group A-3 Insignificant Activity, remove diesel as a fuel for SN-34, revise the operational limits for SN-01 based on the Comprehensive Performance Test (maximum temperatures, scrubber parameters, federate content limits, etc.), remove SN-03 and SN-23 water treatment processes, and add surface water treatment to insignificant activities. The total permitted annual emission rate associated with this modification increased by 0.2 tpy PM/PM₁₀, 324.6 tpy NO_x, 23.6 tpy CO, and 1.4 tpy VOC. The permitted emissions are also being decreased by 1.2 tpy SO₂.

Permit 1009-AOP-R11 was issued December 26, 2013. This permitting action renewed the facility's Title V air permit, added fixed incinerator Unit 44 (SN-44), added cooling towers for incinerators (SN-42 (existing) and SN-43), updated organic HAP emissions based on 61,025 lb/hr waste feed for SN-01, modified SN-09 to SN-09A and SN-09B (previously SN-17) and increased throughput, moved emergency generator (SN-24 A, B, C and D) from Insignificant

Clean Harbors El Dorado, LLC
Permit #: 1009-AOP-R16
AFIN: 70-00098

Activities and added new emergency generator (SN-24E), updated the number of tanks, modified the throughput for SN-21 due to expansion and removed SN-501, SN-545, and SN-607, updated emission calculations and modified the throughput for SN-25 due to expansion, added bulk solid mixing backup carbon filter and filter aid loading operation as Group A-13 Insignificant Activities, moved SN-22 Brine Plant Sources to an Insignificant Activity and added carbon canisters to SN-39 Solvent Recovery System Drum Filling to reduce VOC and HAP emissions. The total permitted annual emission rate associated with this modification increased by 9.2 tpy PM, 35.4 tpy SO₂, 15.5 tpy VOC, 80.2 tpy CO, 39.6 tpy NO_x, and 0.02 tpy Lead. All permitted HAPs increased with the addition of 0.02 tpy Fluorene and 0.02 tpy Phenanthrene. The Single Organic HAP increased by 13.15 tpy and Total Organic HAP increased by 13.16 tpy. The permitted emissions are also being decreased by 1.3 tpy PM₁₀.

Permit 1009-AOP-R12 was issued December 10, 2014 – This permit routed emissions from SN-21 Organic Liquid Waste Tanks to SN-01 Fixed Incinerator Unit and installed a new carbon filtration system on SN-21 for when emissions are not routed to SN-01. SN-21, Tank 1, was removed from the permit. The total permitted annual emission rate associated with this modification decreased by 0.04 tons per year (tpy) Methyl Chloroform, 0.10 tpy Methylene Chloride, 0.02 tpy Tetrachloroethylene, 0.01 tpy Single Organic HAP, and 0.01 tpy Total Organic HAP.

Permit 1009-AOP-R13 was issued May 5, 2016. This permitting action increased the size of the engine at SN-24, increased the hourly rate of NO_x for SN-44 and revised the annual emission rates at SN-09A and SN-09B, removed SN-17, changed opacity limit of SN-24, added two insignificant activities, changed throughput limit of SN-25, and added 40 C.F.R. Part 63 Subpart DDDDD conditions for SN-34. The total permitted annual emission rate associated with this modification changed as follows: -0.7 tons per year (tpy) PM, -0.5 tpy PM₁₀, +0.2 tpy VOC, +0.2 tpy CO, and -0.1 tpy NO_x.

Permit 1009-AOP-R14 was issued November 14, 2016. This permitting action added a fuel storage tank for SN-44 start up (SN-45), a gondola transferring operation (SN-46), and a solidification silo bin vent (SN-47). The process description was updated to specify medical waste incineration, as the facility is considered an existing medical waste incineration facility. Permitted PM emissions increased by 11.4 tpy, PM₁₀ emissions increased by 6.3 tpy, and permitted VOC emissions increased by 0.1 tpy.

Permit 1009-AOP-R15 was issued August 3, 2107. This permitting action added an alternate demonstration of compliance with the opacity limits for SN-01 and SN-44. The facility will demonstrate opacity compliance using either the continuous opacity monitoring system (COMS) or the continuous parameter monitoring system (CPMS). The total permitted emissions remained unchanged.

SECTION IV: SPECIFIC CONDITIONS

SN-01

Fixed Incinerator Unit

Source Description

The Fixed Incinerator Unit is comprised of two rotary kilns, a secondary combustion chamber referred to as the Secondary Combustion Chamber (SCC), and the Waste Fired Boiler (WFB). All of these combustion units have a combined capacity of 61,025 pounds/hour of waste feed. The kilns vent exhaust gases into the SCC which serves as the common afterburner. Kiln #2 vents its exhaust gases through a cyclone prior to the SCC. The WFB exhaust gases are not vented to the SCC, but are vented directly to the pollution control equipment. A lime storage silo also vents to SN-01.

Specific Conditions

1. The permittee shall not exceed the emission rates set forth in the following table. The permittee shall demonstrate compliance with this condition by Specific Conditions #5, #6, #7, #9, and #11, Plantwide Condition #191, and equipment limitations. [Reg.19.501 *et seq.* and 40 C.F.R. § 52 Subpart E]

Pollutant	lb/hr	tpy
PM ₁₀	6.7	29.3
SO ₂	45.0	59.0
VOC	1.2	5.3
CO	26.59	116.5
NO _x	158.2	451.0
Lead Compounds	0.0516 ^a	0.23 ^a

a. Combined limits for lead and cadmium.

2. The permittee shall not exceed the emission rates set forth in the following table. The permittee shall demonstrate compliance with this condition by Specific Conditions #3, #6, #11, and #12, Plantwide Condition #191, and equipment limitations. [Reg.18.801 and Ark. Code Ann. § 8-4-203 as referenced by Ark. Code Ann. §§ 8-4-304 and 8-4-311]

Pollutant	lb/hr	tpy
PM	6.7	29.3
Antimony Compounds	0.11	0.49

Pollutant	lb/hr	tpy
Arsenic Compounds	0.0206 ^b	0.10 ^b
Beryllium Compounds	0.0206 ^{b, c}	0.10 ^b
Cadmium Compounds	0.0516 ^a	0.23 ^a
Calcium cyanimide	1.221	5.35
Chlorine	10.605 ^d	46.46 ^d
Chromium Compounds	0.0206 ^b	0.10 ^b
Cobalt Compounds	0.50	2.19
Cyanide Compounds	1.221	5.35
Dioxins/Furans	8.99E-8	3.94E-7
Hydrazine	1.02	4.48
Hydrochloric acid	10.918 ^d	47.83 ^d
Hydrogen fluoride	6.22	27.25
Manganese Compounds	10.00	43.80
Mercury Compounds	0.029 ^e	0.13
Methyl chloroform	1.221	5.35
Methylene chloride	1.221	5.35
Nickel Compounds	2.00	8.76
Phosphine	1.221	5.35
Phosphorus	1.221	5.35
Selenium Compounds	5.00	21.90
Tetrachloroethylene	1.221	5.35
Titanium Tetrachloride	1.221	5.35
Single Organic HAP	1.221	5.35
Total Organic HAP	1.221	5.35

- a. Combined limits for lead and cadmium.
- b. Combined limits for arsenic, beryllium, and chromium.
- c. Beryllium emissions are also limited by 40 C.F.R. 61, Subpart C.
- d. Combined limit for chlorine and hydrogen chloride of 32 ppm, expressed as chloride equivalent.

e. Mercury emissions are also limited by 40 C.F.R. § 61, Subpart E.

3. Visible emissions may not exceed the limits specified in the following table of this permit as measured by EPA Reference Method 9. [Ark. Code Ann. § 8-4-203 as referenced by Ark. Code Ann. §§ 8-4-304 and 8-4-311]

SN	Limit	Regulatory Citation
01	20%	Reg.19.503 and 40 C.F.R. § 52 Subpart E

4. The permittee shall maintain a Continuous Opacity Monitoring System (COMS) or a Continuous Parameter Monitoring System (CPMS) (as required by 40 C.F.R. § 63 Subpart EEE) to demonstrate compliance with Specific Condition #3. The monitoring system shall comply with the Air Division’s “Continuous Emission Monitoring Systems Conditions.” The facility will develop a particulate matter correlation curve with the COMS and CPMS outputs within 60 days of issuance of the permit and use the curve to predict opacity when using the CPMS to demonstrate compliance with Specific Condition #3. The documentation on how the correlation curve was established shall be maintained on-site and made available to the Department personnel upon request. [Reg.19.705 and 40 C.F.R. § 52 Subpart E]
5. The permittee shall install and maintain Continuous Emission Monitoring Systems (CEMS) to demonstrate compliance with the hourly and annual NO_x emission limits in Specific Condition #1. These CEMS shall comply with the Air Division’s “Continuous Emission Monitoring Systems Conditions.” These CEMS shall be installed and operating within 180 days of issuance of Permit #1009-AOP-R10. [Reg.19.705 and 40 C.F.R. § 52 Subpart E]
6. The permittee shall maintain a destruction and removal efficiency of 99.998% for organic HAPs (excluding dioxins and furans). Compliance with this condition shall be demonstrated during the comprehensive performance test as required by 40 C.F.R. § 63, Subpart EEE. [Reg.19.705, Ark. Code Ann. § 8-4-203 as referenced by Ark. Code Ann. §§ 8-4-304 and 8-4-311, and 40 C.F.R. § 70.6]
7. The facility shall limit the sulfur feed rate to 2045 lb/hr and 2681.8 tons/yr at SN-01. [Reg.19.501 *et seq.* and 40 C.F.R. § 52 Subpart E]
8. The permittee shall maintain monthly records to demonstrate compliance with Specific Condition #7. The permittee shall update these records by the fifteenth day of the month following the month to which the records pertain. These records shall be maintained on-site, made available to Department personnel upon request and submitted in accordance with General Provision #7. [Reg.19.705 and 40 C.F.R. § 52 Subpart E]

9. The control efficiency of the scrubber shall be maintained at a minimum of 98.9% for SO₂ removal. [Reg.19.705 , Ark. Code Ann. § 8-4-203 as referenced by Ark. Code Ann. §§ 8-4-304 and 8-4-311, and 40 C.F.R. § 70.6]
10. The permittee shall conduct testing to determine the control efficiency of the scrubber for SO₂ at SN-01. This testing shall be conducted in accordance with EPA Reference Method 6C and Plantwide Condition #3. The initial test was conducted during the October and November 2011 comprehensive performance test (CPT) which was conducted as required by 40 C.F.R. § 63 Subpart EEE. This testing shall be performed a minimum of once every 5 years. The result of this testing shall be maintained on-site, made available to Department personnel upon request and submitted in accordance with General Provision #7. [Reg.19.702 and 40 C.F.R. § 52 Subpart E]
11. The permittee shall conduct all particulate testing with the inclusion of EPA Method 202. The initial testing shall be performed at the same time as the CPT required by 40 C.F.R. § 63 Subpart EEE. This testing shall be performed a minimum of once every five years. EPA Method 202 is not to be utilized as part of the demonstration of compliance with 40 C.F.R. § 63 Subpart EEE particulate limits. A copy of these test results shall be submitted in accordance with General Provision #7. CPT conducted October and November 2011. [Reg.19.702 and 40 C.F.R. § 52 Subpart E]
12. The permittee shall test SN-01 for cyanide compounds, hydrazine, hydrogen fluoride, phosphine, and titanium tetrachloride while operating at 90% or greater capacity. Emission results shall be extrapolated to correlate with 100% of the permitted capacity to determine compliance. These tests shall be performed using test methods as approved by ADEQ, and shall be conducted in accordance with Plantwide Condition #3. This testing was conducted during the October and November 2011 CPT which was conducted as required by 40 C.F.R. § 63 Subpart EEE. [Reg.18.1002 and Ark. Code Ann. § 8-4-203 as referenced by Ark. Code Ann. §§ 8-4-304 and 8-4-311]
13. The permittee shall not utilize more than 74% of the recovered energy, calculated on an annual basis, from the liquid waste fired boiler at SN-01. The permittee shall maintain monthly records to demonstrate compliance with this specific condition. These records shall be updated by the fifteenth day of the month following the month to which the records pertain, shall be kept on site, and shall be provided to Department personnel upon request. A 12-month rolling average and each individual month's data shall be submitted in accordance with General Provision #7. An approved plan for calculating the energy utilization rate of the liquid waste fired boiler at SN-01 is included in appendix M. [Reg.18.1004 and Ark. Code Ann. § 8-4-203 as referenced by Ark. Code Ann. §§ 8-4-304 and 8-4-311]

**SN-07
 Solidification Building**

Source Description

Ash solidification occurs within an enclosed structure equipped with a baghouse. Ash from the incinerators is moved via truck to the Solidification Building where it is placed in a mixing container and mixed with an absorbent to remove all free moisture. The mixing process results in the emission of absorbent dust which is collected by an Aeropulse Baghouse. In addition, any mist generated from the water sprays in the trommel screen at the metal recovery process is exhausted through a demister, and then ducted to the solidification building where they will exhaust through the Aeropulse Baghouse.

Specific Conditions

14. The permittee shall not exceed the emission rates set forth in the following table. The permittee shall demonstrate compliance with this condition by Specific Condition #16 and equipment limitations. [Reg.19.501 *et seq.* and 40 C.F.R. § 52 Subpart E]

Pollutant	lb/hr	tpy
PM ₁₀	1.9	8.0

15. The permittee shall not exceed the emission rates set forth in the following table. The permittee shall demonstrate compliance with this condition by Specific Condition #16 and equipment limitations. [Reg.18.801 and Ark. Code Ann. § 8-4-203 as referenced by Ark. Code Ann. §§ 8-4-304 and 8-4-311]

Pollutant	lb/hr	tpy
PM	1.9	8.0

16. Visible emissions may not exceed the limits specified in the following table of this permit as measured by EPA Reference Method 9. [Ark. Code Ann. § 8-4-203 as referenced by Ark. Code Ann. §§ 8-4-304 and 8-4-311]

SN	Limit	Regulatory Citation
07	5%	Reg.18.501

17. The permittee shall conduct weekly observations of the opacity from source SN-07 and keep a record of these observations. If the permittee detects visible emissions that exceed the limit, the permittee must immediately take action to identify and correct the cause of the visible emissions. After implementing the corrective action, the permittee must

document that the source complies with the visible emissions requirements. The permittee shall maintain records of the cause of any visible emissions and the corrective action taken. The permittee must keep these records onsite and make them available to Department personnel upon request. [40 C.F.R. § 64, Reg.19.304, Reg.18.1004, and Ark. Code Ann. § 8-4-203 as referenced by Ark. Code Ann. §§ 8-4-304 and 8-4-311]

18. SN-07 is subject to Compliance Assurance Monitoring and shall comply with all applicable provisions, including but not limited to: [Reg.19.304 and 40 C.F.R. § 64]
 - a. Indicator: The permittee shall monitor the opacity and document daily inspections of the bag filters. [40 C.F.R. § 64.6(c)(1)(i)]
 - b. Indicator Range and Averaging Period: The permittee shall maintain the opacity below the limit specified in Specific Condition #16; and the permittee shall perform daily inspections of the bag filters to document undamaged condition. [40 C.F.R. § 64.6(c)(2)]
 - c. Measurement Approach: The permittee shall use EPA Reference Method 9 to determine the opacity and perform daily inspections of the bag filters. [40 C.F.R. § 64.6(c)(1)(ii)]
 - d. Data Representativeness: The permittee shall test for the opacity at SN-07 using EPA Reference Method 9. The daily inspections shall be performed by trained personnel using documented inspection procedures. [40 C.F.R. § 64.6(c)(1)(iii)]
 - e. QA/QC and Frequency of Monitoring: The permittee shall follow the manufacturer's recommendations for maintenance of the baghouse. Personnel shall be trained on the inspection procedures. The bag filters shall be inspected daily. The opacity measurements shall follow the procedures of EPA Reference Method 9 and shall be conducted weekly. [40 C.F.R. §§ 64.6(c)(1)(iii) and 64.3(b)(4)]
 - f. A monitoring report shall be submitted to the Department in accordance with General Provision #7 and shall include the following per 40 C.F.R. § 64.9(a)(2):
 - i. The information required under 40 C.F.R. § 70.6(a)(3)(iii);
 - ii. Summary information on the number, duration and cause (including unknown cause, if applicable) of excursions or exceedances, as applicable, and the corrective actions taken; and
 - iii. A description of the actions taken to implement a QIP, if required, during the reporting period as specified in § 64.8. Upon completion of a QIP, the owner or operator shall include in the next summary report documentation that the implementation of the plan has been completed and reduced the likelihood of similar levels of excursions or exceedances occurring. A QIP shall be required if the excess emissions exceeds 5% of the unit operating time.

Clean Harbors El Dorado, LLC

Permit #: 1009-AOP-R16

AFIN: 70-00098

- g. The permittee shall comply with the recordkeeping requirements specified in § 70.6(a)(3)(ii). The permittee shall maintain records of monitoring data, monitor performance data, corrective actions taken, any written quality improvement plan required pursuant to § 64.8 and any activities undertaken to implement a quality improvement plan, and other supporting information required to be maintained under 40 C.F.R. § 64 (such as data used to document the adequacy of monitoring, or records of monitoring maintenance or corrective actions). [40 C.F.R. § 64.9(b)(1)]

**SN-08
 Waste Fired Boiler (Natural Gas Only)**

Source Description

The Waste Fired Boiler is exhausted through the air pollution control train for the Fixed Incineration Unit (SN-01) when burning waste liquids, and emissions are accounted for in SN-01 during such operations. However, the WFB may exhaust directly to the atmosphere when burning natural gas. During this time, the WFB is considered SN-08. SN-08 is not subject to 40 C.F.R. § 60 Subpart Dc since the boiler was installed before the June 9, 1989 applicability date.

Specific Conditions

19. The permittee shall not exceed the emission rates set forth in the following table. The permittee shall demonstrate compliance with this condition by equipment limitations. These emissions are for natural gas combustion only. [Reg.19.501 *et seq.* and 40 C.F.R. § 52 Subpart E]

Pollutant	lb/hr	tpy
PM ₁₀	0.5	2.2
SO ₂	0.1	0.2
VOC	0.4	1.6
CO	5.5	23.9
NO _x	6.5	28.4
Lead	0.01	0.01

20. The permittee shall not exceed the emission rates set forth in the following table. The permittee shall demonstrate compliance with this condition by equipment limitations. These emissions are for natural gas combustion only. [Reg.18.801 and Ark. Code Ann. § 8-4-203 as referenced by Ark. Code Ann. §§ 8-4-304 and 8-4-311]

Pollutant	lb/hr	tpy
PM	0.5	2.2
Arsenic Compounds	0.01	0.01
Beryllium Compounds	0.0001	0.01
Cadmium Compounds	0.001	0.01
Cobalt Compounds	0.01	0.01

Clean Harbors El Dorado, LLC

Permit #: 1009-AOP-R16

AFIN: 70-00098

Pollutant	lb/hr	tpy
Fluorene	0.01	0.01
Manganese Compounds	0.01	0.01
Mercury Compounds	0.01	0.01
Nickel Compounds	0.01	0.01
Phenanthrene	0.01	0.01
Selenium Compounds	0.01	0.01
Single Organic HAP	0.12	0.51
Total Organic HAP	0.13	0.54

21. Visible emissions may not exceed the limits specified in the following table of this permit as measured by EPA Reference Method 9. Compliance will be demonstrated by burning only natural gas. [Ark. Code Ann. § 8-4-203 as referenced by Ark. Code Ann. §§ 8-4-304 and 8-4-311]

SN	Limit	Regulatory Citation
08	5%	Reg.18.501

**SN-09A & SN-09B
 Lime Silo Bin Vent**

Source Description

Lime is used in the incinerator air pollution control train. Lime may be stored on-site in two lime silos. Emissions occur when lime is transferred from trucks into the silo. Emissions are controlled by a silo vent baghouse on each silo.

Specific Conditions

22. The permittee shall not exceed the emission rates set forth in the following table. The permittee shall demonstrate compliance with this condition by Specific Conditions #24, #26, and equipment limitations. [Reg.19.501 *et seq.* and 40 C.F.R. § 52, Subpart E]

Source	Pollutant	lb/hr	tpy
SN-09A	PM ₁₀	1.0	0.5*
SN-09B	PM ₁₀	1.0	0.5*

*Bubbled Emission Rates.

23. The permittee shall not exceed the emission rates set forth in the following table. The permittee shall demonstrate compliance with this condition by Specific Conditions #24, #26, and equipment limitations. [Reg.18.801 and Ark. Code Ann. § 8-4-203 as referenced by §§ 8-4-304 and 8-4-311]

Source	Pollutant	lb/hr	tpy
SN-09A	PM	1.5	0.7*
SN-09B	PM	1.5	0.7*

*Bubbled Emission Rates

24. Visible emissions may not exceed the limits specified in the following table of this permit as measured by EPA Reference Method 9. [Ark. Code Ann. § 8-4-203 as referenced by Ark. Code Ann. §§ 8-4-304 and 8-4-311]

SN	Limit	Regulatory Citation
09A&B	5%	Reg.18.501

25. The permittee shall conduct weekly observations of the opacity from source SN-09A&B and keep a record of these observations. If the permittee detects visible emissions that exceed the limit, the permittee must immediately take action to identify and correct the

Clean Harbors El Dorado, LLC
Permit #: 1009-AOP-R16
AFIN: 70-00098

cause of the visible emissions. After implementing the corrective action, the permittee must document that the source complies with the visible emissions requirements. The permittee shall maintain records of the cause of any visible emissions and the corrective action taken. The permittee must keep these records onsite and make them available to Department personnel upon request. [Reg.18.1004 and Ark. Code Ann. § 8-4-203 as referenced by Ark. Code Ann. §§ 8-4-304 and 8-4-311]

26. The permittee shall not receive more than 1,794 trucks (combined) of lime per consecutive 12-month period at SN-09A & B. [Reg.19.705, Ark. Code Ann. § 8-4-203 as referenced by Ark. Code Ann. §§ 8-4-304 and 8-4-311, and 40 C.F.R. § 70.6]
27. The permittee shall maintain monthly records which demonstrate compliance with the throughput limit set in Specific Condition #26. These records may be used by the Department for enforcement purposes. These records shall be updated by the fifteenth day of the month following the month to which the records pertain, shall be kept on site, and shall be provided to Department personnel upon request. A 12-month rolling total and each individual month's data shall be submitted in accordance with General Provision #7. [Reg.19.705 and 40 C.F.R. § 52 Subpart E]

**SN-11
Gasoline Storage Tank**

Source Description

The Gasoline Storage tank has a capacity of 1,000 gallons of unleaded gasoline. The tank is located in the concrete containment area behind the Fire Station/Safety Office. The tank is used to fuel Clean Harbors owned vehicles within the plant.

Specific Conditions

28. The permittee shall not exceed the emission rates set forth in the following table. The permittee shall demonstrate compliance with this condition by Specific Condition #29 and equipment limitations. [Reg.19.501 *et seq.* and 40 C.F.R. § 52 Subpart E]

Pollutant	lb/hr	tpy
VOC	6.6	0.4

29. The permittee shall not have a throughput in excess of 55,496 gallons of gasoline at SN-11 during any consecutive twelve month period. [Reg.19.705, Ark. Code Ann. § 8-4-203 as referenced by Ark. Code Ann. §§ 8-4-304 and 8-4-311, and 40 C.F.R. § 70.6]
30. The permittee shall maintain monthly records which demonstrate compliance with the throughput limit set in Specific Condition #29. These records may be used by the Department for enforcement purposes. These records shall be updated by the fifteenth day of the month following the month to which the records pertain, shall be kept on site, and shall be provided to Department personnel upon request. A 12-month rolling total and each individual month's data shall be submitted in accordance with General Provision #7. [Reg.19.705 and 40 C.F.R. § 52 Subpart E]

**SN-12
Diesel Storage Tank**

Source Description

This source consists of two diesel storage tanks one with a capacity of 1,000 gallons and one with a capacity of 500 gallons of diesel fuel. These tanks are located in the concrete containment area behind the Fire Station/Safety Office. These tanks are used to fuel Clean Harbors owned vehicles within the plant.

Specific Conditions

31. The permittee shall not exceed the emission rates set forth in the following table. The permittee shall demonstrate compliance with this condition by Specific Condition #32 and equipment limitations. [Reg.19.501 *et seq.* and 40 C.F.R. § 52 Subpart E]

Pollutant	lb/hr	tpy
VOC	0.1	0.1

32. The permittee shall not have a throughput in excess of 109,716 gallons of diesel fuel in SN-12 during any consecutive twelve month period. [Reg.19.705, Ark. Code Ann. § 8-4-203 as referenced by Ark. Code Ann. §§ 8-4-304 and 8-4-311, and 40 C.F.R. § 70.6]
33. The permittee shall maintain monthly records which demonstrate compliance with the throughput limit set in Specific Condition #32. These records may be used by the Department for enforcement purposes. These records shall be updated by the fifteenth day of the month following the month to which the records pertain, shall be kept on site, and shall be provided to Department personnel upon request. A 12-month rolling total and each individual month's data shall be submitted in accordance with General Provision #7. [Reg.19.705 and 40 C.F.R. § 52 Subpart E]

SN-16
Brine Reactor Vessel

Source Description

Sodium Hydroxide (NaOH) or lime and Sodium Hydrogen Sulfide (NaSH) are used during the treatment of scrubber brine at the brine unit. The NaOH adjusts the brine to a pH range in which the NaSH can react with any metals that may be in the scrubber brine. A small amount of H₂S gas may be produced in the brine batch reactor. This gas is vented through a NaOH scrubber to the atmosphere.

Specific Conditions

34. The permittee shall not exceed the emission rates set forth in the following table. The permittee shall demonstrate compliance with this condition by Specific Condition #35 and equipment limitations. [Reg.18.801 and Ark. Code Ann. § 8-4-203 as referenced by Ark. Code Ann. §§ 8-4-304 and 8-4-311]

Pollutant	lb/hr	tpy
H ₂ S	0.1	0.1

35. The permittee shall operate the scrubber per manufacturers specifications at all times that SN-16 is in operation. [Reg.18.1104 and Ark. Code Ann. § 8-4-203 as referenced by Ark. Code Ann. §§ 8-4-304 and 8-4-311]

**SN-18 & SN-47
 Solidification Silo Bin Vent**

Source Description

Ash solidification occurs within an enclosed structure equipped with a baghouse. Ash from the incinerators is moved via truck to the Solidification Building where it is placed in a mixing container and mixed with an absorbent to remove all free moisture. The mixing process results in the emission of absorbent dust which is collected by an Aeropulse Baghouse.

Specific Conditions

36. The permittee shall not exceed the emission rates set forth in the following table. The permittee shall demonstrate compliance with this condition by Specific Conditions #38, #40, and equipment limitations. [Reg.19.501 *et seq.* and 40 C.F.R. § 52 Subpart E]

Source	Pollutant	lb/hr	tpy
SN-18*	PM ₁₀	0.5	0.2
SN-47*			

*Emissions bubbled for SN-18 and SN-47

37. The permittee shall not exceed the emission rates set forth in the following table. The permittee shall demonstrate compliance with this condition by Specific Conditions #38, #40, and equipment limitations. [Reg.18.801 and Ark. Code Ann. § 8-4-203 as referenced by Ark. Code Ann. §§ 8-4-304 and 8-4-311]

Source	Pollutant	lb/hr	tpy
SN-18*	PM	0.8	0.3
SN-47*			

*Emissions bubbled for SN-18 and SN-47

38. Visible emissions may not exceed the limits specified in the following table of this permit as measured by EPA Reference Method 9. [Ark. Code Ann. § 8-4-203 as referenced by Ark. Code Ann. §§ 8-4-304 and 8-4-311]

SN	Limit	Regulatory Citation
18 and 47	5%	Reg.18.501

39. The permittee shall conduct weekly observations of the opacity from sources SN-18 and SN-47 and keep a record of these observations. If the permittee detects visible emissions

Clean Harbors El Dorado, LLC

Permit #: 1009-AOP-R16

AFIN: 70-00098

that exceed the limit, the permittee must immediately take action to identify and correct the cause of the visible emissions. After implementing the corrective action, the permittee must document that the source complies with the visible emissions requirements. The permittee shall maintain records of the cause of any visible emissions and the corrective action taken. The permittee must keep these records onsite and make them available to Department personnel upon request. [Reg.18.1004 and Ark. Code Ann. § 8-4-203 as referenced by Ark. Code Ann. §§ 8-4-304 and 8-4-311]

40. The permittee shall not unload more than a total of 600 trucks of fly ash and/or lime per consecutive 12-month period at SN-18 and SN-47 combined. [Reg.19.705, Ark. Code Ann. § 8-4-203 as referenced by Ark. Code Ann. §§ 8-4-304 and 8-4-311, and 40 C.F.R. § 70.6]
41. The permittee shall maintain monthly records which demonstrate compliance with the throughput limit set in Specific Condition #40. These records may be used by the Department for enforcement purposes. These records shall be updated by the fifteenth day of the month following the month to which the records pertain, shall be kept on site, and shall be provided to Department personnel upon request. A 12-month rolling total and each individual month's data shall be submitted in accordance with General Provision #7. [Reg.19.705 and 40 C.F.R. § 52 Subpart E]

**SN-20
 Lime Perma Batch Tank**

Source Description

The Clean Harbors lime slurry preparation is a batch system. A predetermined volume of water is added to the lime batch tank. A ribbon blender is installed inside the tank. This blender mixes the dry hydrated and/or pebble lime to form a lime-water slurry. The dry hydrated lime and/or pebble lime is delivered via truck and is pneumatically conveyed from the truck to the batch tank. The batch tank is equipped with a baghouse (SN-20).

Specific Conditions

42. The permittee shall not exceed the emission rates set forth in the following table. The permittee shall demonstrate compliance with this condition by Specific Condition #44 and equipment limitations. [Reg.19.501 *et seq.* and 40 C.F.R. § 52 Subpart E]

Pollutant	lb/hr	tpy
PM ₁₀	0.2	0.7

43. The permittee shall not exceed the emission rates set forth in the following table. The permittee shall demonstrate compliance with this condition by Specific Condition #44 and equipment limitations. [Reg.18.801 and Ark. Code Ann. § 8-4-203 as referenced by Ark. Code Ann. §§ 8-4-304 and 8-4-311]

Pollutant	lb/hr	tpy
PM	0.2	0.7

44. Visible emissions may not exceed the limits specified in the following table of this permit as measured by EPA Reference Method 9. [Ark. Code Ann. § 8-4-203 as referenced by Ark. Code Ann. §§ 8-4-304 and 8-4-311]

SN	Limit	Regulatory Citation
20	5%	Reg.18.501

45. The permittee shall conduct weekly observations of the opacity from source SN-20 and keep a record of these observations. If the permittee detects visible emissions, the permittee must immediately take action to identify and correct the cause of the visible emissions. After implementing the corrective action, the permittee must document that the source complies with the visible emissions requirements. The permittee shall maintain records of the cause of any visible emissions and the corrective action taken.

Clean Harbors El Dorado, LLC

Permit #: 1009-AOP-R16

AFIN: 70-00098

The permittee must keep these records onsite and make them available to Department personnel upon request. [Reg.18.1004 and Ark. Code Ann. § 8-4-203 as referenced by Ark. Code Ann. §§ 8-4-304 and 8-4-311]

**SN-21
Organic Liquid Waste Tanks**

Source Description

Clean Harbors operates 24 tanks in organic liquid wastes services. Each tank is vented through a series of piping that routes emissions to incinerator (SN-01) and a carbon filtration system. The carbon filtration system controls VOC/HAP emissions while the incinerator is not online.

Specific Conditions

46. The permittee shall not exceed the emission rates set forth in the following table. The permittee shall demonstrate compliance with this condition by Specific Conditions #49, #50, #51, #52, #54, and equipment limitations. [Reg.19.501 *et seq.* and 40 C.F.R. § 52 Subpart E]

Pollutant	lb/hr	tpy
VOC	1.0	2.0

47. The permittee shall not exceed the emission rates set forth in the following table. The permittee shall demonstrate compliance with this condition by Specific Conditions #49, #50, #51, #52, #54, and equipment limitations. [Reg.18.801 and Ark. Code Ann. § 8-4-203 as referenced by Ark. Code Ann. §§ 8-4-304 and 8-4-311]

Pollutant	lb/hr	tpy
Methyl chloroform	0.46	0.89
Methylene chloride	0.97	1.90
Tetrachloroethylene	0.09	0.18
Single Organic HAP	0.97	1.90
Total Organic HAP	0.97	1.90

48. All tanks at SN-21 are subject to regulation under NSPS Kb – Standards of Performance for Volatile Organic Storage Vessels for Which Construction, Reconstruction, or Modification Commenced After July 23, 1984. [Reg.19.304 and 40 C.F.R. § 60.110b(a)]
49. The permittee shall keep records of the operating plan for the use of carbon canisters and the maintenance performed on the canisters at SN-21. The plan is attached as Appendix Q. [Reg.19.304 and 40 C.F.R. § 60.115b(c)]

Clean Harbors El Dorado, LLC
Permit #: 1009-AOP-R16
AFIN: 70-00098

50. The permittee shall keep records showing the dimension of and an analysis showing the capacity of each storage vessel at SN-21. Records shall be kept on site and be provided to Department personnel upon request. [Reg.19.304 and 40 C.F.R. § 60.116b(b)]
51. The permittee shall maintain the carbon canisters per manufacturer's specifications on each tank while any waste is being stored in it. [Reg.19.303 and Ark. Code Ann. § 8-4-203 as referenced by Ark. Code Ann. §§ 8-4-304 and 8-4-311]
52. The permittee shall not load in excess of 18,000,000 gallons of organic liquids into all tanks combined at SN-21 during any rolling 12 month period. [Reg.19.705, Ark. Code Ann. § 8-4-203 as referenced by Ark. Code Ann. §§ 8-4-304 and 8-4-311, and 40 C.F.R. § 70.6]
53. The permittee shall maintain monthly records which demonstrate compliance with the throughput limit set in Specific Condition #52. These records may be used by the Department for enforcement purposes. These records shall be updated by the fifteenth day of the month following the month to which the records pertain, shall be kept on site, and shall be provided to Department personnel upon request. A 12-month rolling total and each individual month's data shall be submitted in accordance with General Provision #7. [Reg.19.705 and 40 C.F.R. § 52 Subpart E]
54. The permittee shall not exceed a vapor pressure of 6.159 psia at 65°F for the contents of the storage tanks at SN-21. Supporting documentation shall be maintained on site to demonstrate compliance with this specific condition. [Reg.19.705, Ark. Code Ann. § 8-4-203 as referenced by Ark. Code Ann. §§ 8-4-304 and 8-4-311, and 40 C.F.R. § 70.6]
55. SN-21 is subject to Compliance Assurance Monitoring when emissions are not routed to SN-01 and shall comply with all applicable provisions, including but not limited to: [Reg.19.304 and 40 C.F.R. § 64]
 - a. Indicator: The permittee shall monitor the organic liquid throughput, monitor the VOC concentration, and document daily inspections of the carbon canisters. [40 C.F.R. § 64.6(c)(1)(i)]
 - b. Indicator Range and Averaging Period: The permittee shall maintain the organic liquid throughput below the limit specified in Specific Condition #52 on a rolling 12-month basis; a VOC concentration of 500 ppmv or greater requires replacement of one or both carbon canisters; and the permittee shall perform daily inspections of the carbon canisters to document undamaged condition. [40 C.F.R. § 64.6(c)(2)]
 - c. Measurement Approach: The permittee shall maintain receiving records for the throughput of SN-21; use EPA Reference Method 21 to determine the VOC concentration; and perform daily inspections of the carbon canisters. [40 C.F.R. § 64.6(c)(1)(ii)]

- d. Data Representativeness: The permittee shall test for the VOC concentration between the primary and secondary carbon canisters using EPA Reference Method 21. The daily inspections shall be performed by trained personnel using documented inspection procedures. [40 C.F.R. § 64.6(c)(1)(iii)]
- e. QA/QC and Frequency of Monitoring: The permittee shall follow the manufacturer’s recommendations for maintenance of the carbon canisters. Personnel shall be trained on the inspection procedures. The carbon canisters shall be inspected daily. The throughput shall be updated monthly in accordance with Specific Condition #53. The VOC concentration measurements shall follow the procedures of EPA Reference Method 21, and the VOC concentration shall be monitored according to the following schedule: [40 C.F.R. §§ 64.6(c)(1)(iii) and 64.3(b)(4)]

Tank	VOC Concentration Monitoring Frequency (Weeks)
2	1
3	1
4	1
8	2
9	2
10	2
11	2
12	1
13	1
14	1
15	1
602	1
603	1
604	1
605	1
606	1
608	1
609	1
610	1
611	1
612	1
613	1
614	1
615	1

- f. A monitoring report shall be submitted to the Department in accordance with General Provision #7 and shall include the following per 40 C.F.R. § 64.9(a)(2):
 - i. The information required under 40 C.F.R. § 70.6(a)(3)(iii);

Clean Harbors El Dorado, LLC

Permit #: 1009-AOP-R16

AFIN: 70-00098

- ii. Summary information on the number, duration and cause (including unknown cause, if applicable) of excursions or exceedances, as applicable, and the corrective actions taken; and
 - iii. A description of the actions taken to implement a QIP, if required, during the reporting period as specified in §64.8. Upon completion of a QIP, the owner or operator shall include in the next summary report documentation that the implementation of the plan has been completed and reduced the likelihood of similar levels of excursions or exceedances occurring. A QIP shall be required if the excess emissions exceeds 5% of the unit operating time.
- g. The permittee shall comply with the recordkeeping requirements specified in § 70.6(a)(3)(ii). The permittee shall maintain records of monitoring data, monitor performance data, corrective actions taken, any written quality improvement plan required pursuant to § 64.8 and any activities undertaken to implement a quality improvement plan, and other supporting information required to be maintained under 40 C.F.R. § 64 (such as data used to document the adequacy of monitoring, or records of monitoring maintenance or corrective actions). [40 C.F.R. § 64.9(b)(1)]

**SN-24
 Emergency Generators and Firewater Pump**

Source Description

Clean Harbors maintains four emergency generators and one firewater pump. All are diesel internal combustion engines. Emissions are estimated using factors from AP-42.

Specific Conditions

56. The permittee shall not exceed the emission rates set forth in the following table. The permittee shall demonstrate compliance with this condition by Specific Condition #60 and equipment limitations. [Reg.19.501 *et seq.* and 40 C.F.R. § 52 Subpart E]

Source	Description	Pollutant	lb/hr	tpy
SN-24A	Fire Pump Generator Lister (44.25 HP)	PM ₁₀	0.1	0.1
		SO ₂	0.1	0.1
		VOC	0.2	0.1
		CO	0.4	0.1
		NO _x	1.4	0.1
SN-24B	Fire Pump CAT 3208 (196HP)	PM ₁₀	0.5	0.1
		SO ₂	0.4	0.1
		VOC	0.5	0.1
		CO	1.4	0.1
		NO _x	6.1	0.4
SN-24C	Generator Kohler 200ROZ (275 HP)	PM ₁₀	0.6	0.1
		SO ₂	0.6	0.1
		VOC	0.7	0.1
		CO	1.9	0.1
		NO _x	8.5	0.5
SN-24D	Generator CAT 3412-SR4 (805 HP)	PM ₁₀	0.6	0.1
		SO ₂	0.3	0.1
		VOC	0.6	0.1
		CO	4.8	0.3
		NO _x	18.1	1.0
SN-24E	Unit 44 Generator (755 HP)	PM ₁₀	0.3	0.1
		SO ₂	0.3	0.1
		VOC	0.5	0.1
		CO	4.4	0.3
		NO _x	8.0	0.4

57. The permittee shall not exceed the emission rates set forth in the following table. The permittee shall demonstrate compliance with this condition by Specific Condition #60

and equipment limitations. [Reg.18.801 and Ark. Code Ann. § 8-4-203 as referenced by §§ 8-4-304 and 8-4-311]

Source	Description	Pollutant	lb/hr	tpy
SN-24A	Fire Pump Generator Lister (44.25 HP)	PM	0.1	0.1
		Fluorene	0.01	0.01
		Phenanthrene	0.01	0.01
		Single Organic HAP	0.01	0.01
		Total Organic HAP	0.01	0.01
SN-24B	Fire Pump CAT 3208 (196HP)	PM	0.5	0.1
		Fluorene	0.01	0.01
		Phenanthrene	0.01	0.01
		Single Organic HAP	0.01	0.01
		Total Organic HAP	0.01	0.01
SN-24C	Generator Kohler 200ROZ (275 HP)	PM	0.6	0.1
		Fluorene	0.01	0.01
		Phenanthrene	0.01	0.01
		Single Organic HAP	0.01	0.01
		Total Organic HAP	0.01	0.01
SN-24D	Generator CAT 3412-SR4 (805 HP)	PM	0.6	0.1
		Fluorene	0.01	0.01
		Phenanthrene	0.01	0.01
		Single Organic HAP	0.01	0.01
		Total Organic HAP	0.01	0.01
SN-24E	Unit 44 Generator (755 HP)	PM	0.3	0.1
		Fluorene	0.01	0.01
		Phenanthrene	0.01	0.01
		Single Organic HAP	0.01	0.01
		Total Organic HAP	0.01	0.01

58. Visible emissions may not exceed the limits specified in the following table of this permit as measured by EPA Reference Method 9. [Ark. Code Ann. § 8-4-203 as referenced by §§ 8-4-304 and 8-4-311]

SN	Limit	Regulatory Citation
24	20%	Reg.18.501

59. The permittee shall conduct daily observations of the opacity from sources SN-24 during periods of operation and keep a record of these observations. If the permittee detects visible emissions that exceed the limit, the permittee must immediately take action to identify and correct the cause of the visible emissions. After implementing the corrective action, the permittee must document that the source complies with the visible emissions requirements. The permittee shall maintain records of the cause of any visible emissions

Clean Harbors El Dorado, LLC
Permit #: 1009-AOP-R16
AFIN: 70-00098

and the corrective action taken. The permittee must keep these records onsite and make them available to Department personnel upon request. [Reg.18.1004 and Ark. Code Ann. § 8-4-203 as referenced by Ark. Code Ann. §§ 8-4-304 and 8-4-311]

60. The permittee shall not operate the emergency generators and fire pump in excess of 100 total hours (emergency and non-emergency) per engine per calendar year in order to demonstrate compliance with the annual emission rate limits. Emergency operation in excess of these hours may be allowable but shall be reported and will be evaluated in accordance with Reg.19.602 and other applicable regulations. [Reg.19.705, Ark. Code Ann. § 8-4-203 as referenced by Ark. Code Ann. §§ 8-4-304 and 8-4-311, and 40 C.F.R. § 70.6]
61. The permittee shall maintain monthly records to demonstrate compliance with Specific Condition #60. The permittee shall update these records by the fifteenth day of the month following the month to which the records pertain. The calendar year totals and each individual month's data shall be maintained on-site, made available to Department personnel upon request, and submitted in accordance with General Provision #7. [Reg.19.705 and 40 C.F.R. § 52 Subpart E]

NESHAP Subpart ZZZZ Conditions

62. Sources SN-24A, SN-24B, and SN-24D are potentially subject to 40 C.F.R. § 63 Subpart ZZZZ - National Emission Standard for Hazardous Air Pollutants for Stationary Reciprocating Internal Combustion Engines. The applicable provisions of this subpart include, but are not limited to, the items found in Specific Conditions #63 through # 77. [Reg.19.304 and 40 C.F.R. § 63.6595(a)(1)]
63. The permittee shall comply with the following requirements for existing stationary RICE with a site rating of equal to or less than 500 brake HP located at a major source of HAP emissions: [Reg.19.304, 40 C.F.R. § 63.6602, and Table 2c of 40 C.F.R. § 63 Subpart ZZZZ]

For each	The permittee shall meet the following requirement, except during periods of startup	During periods of startup the permittee must
SN-24A and SN-24B ¹	a. Change oil and filter every 500 hours of operation or annually, whichever comes first. ² b. Inspect air cleaner every 1,000 hours of operation or annually, whichever comes first and replace as necessary; and c. Inspect all hoses and belts every 500 hours of operation or annually, whichever comes first, and replace as necessary. ³	Minimize the engine's time spent at idle and minimize the engine's startup time at startup to a period needed for appropriate and safe loading of the engine, not to exceed 30 minutes, after which time the non-startup emission limitations apply. ³

¹ If an emergency engine is operating during an emergency and it is not possible to shut down the engine in order to perform the work practice requirements on the schedule required, or if performing the work practice on the required schedule would otherwise pose an unacceptable risk under federal, state, or local law, the work practice can be delayed until the emergency is over or the unacceptable risk under federal, state, or local law has abated. The work practice should be performed as soon as practicable after the emergency has ended or the unacceptable risk under federal, state, or local law has abated. Sources must report any failure to perform the work practice on the schedule required and the federal, state or local law under which the risk was deemed unacceptable.

² Sources have the option to utilize an oil analysis program as described in Specific Condition # 68 in order to extend the specified oil change requirement in Table 2c of Subpart ZZZZ.

³ Sources can petition the Administrator pursuant to the requirements of 40 C.F.R. § 63.6(g) for alternative work practices.

64. Beginning January 1, 2015, if the permittee owns or operates an existing emergency CI stationary RICE with a site rating of more than 100 brake HP and a displacement of less than 30 liters per cylinder that uses diesel fuel and operates or is contractually obligated to be available for more than 15 hours per calendar year for the purposes specified in Specific Condition # 74.b.ii) and 74.b.iii), you must use diesel fuel that meets the requirements in 40 C.F.R. § 80.510(b) for nonroad diesel fuel, except that any existing diesel fuel purchased (or otherwise obtained) prior to January 1, 2015, may be used until depleted. [Reg.19.304 and 40 C.F.R. § 63.6604 (b)]
65. The permittee must operate and maintain SN-24A and SN-24B RICE and after-treatment control device (if any) according to the manufacturer's emission-related written instructions or develop your own maintenance plan which must provide to the extent practicable for the maintenance and operation of the engine in a manner consistent with good air pollution control practice for minimizing emissions. [Reg.19.304 and 40 C.F.R. § 63.6625(e)]

66. The permittee must install a non-resettable hour meter if one is not already installed for SN-24A and SN-24B. [Reg.19.304 and 40 C.F.R. § 63.6625(f)]
67. The permittee must minimize the engine's time spent at idle during startup and minimize the engine's startup time to a period needed for appropriate and safe loading of the engine, not to exceed 30 minutes, after which time the emission standards applicable to all times other than startup in Table 2c to 40 C.F.R. § 63 Subpart ZZZZ apply. [Reg.19.304 and 40 C.F.R. § 63.6625(h)]
68. The permittee has the option of utilizing an oil analysis program in order to extend the specified oil change requirement in Table 2c. The oil analysis must be performed at the same frequency specified for changing the oil in Table 2c. The analysis program must at a minimum analyze the following three parameters: Total Base Number, viscosity, and percent water content. The condemning limits for these parameters are as follows: Total Base Number is less than 30 percent of the Total Base Number of the oil when new; viscosity of the oil has changed by more than 20 percent from the viscosity of the oil when new; or percent water content (by volume) is greater than 0.5. If all of these condemning limits are not exceeded, the engine owner or operator is not required to change the oil. If any of the limits are exceeded, the engine owner or operator must change the oil within 2 business days of receiving the results of the analysis; if the engine is not in operation when the results of the analysis are received, the engine owner or operator must change the oil within 2 business days or before commencing operation, whichever is later. The owner or operator must keep records of the parameters that are analyzed as part of the program, the results of the analysis, and the oil changes for the engine. The analysis program must be part of the maintenance plan for the engine. [Reg.19.304 and 40 C.F.R. § 63.6625(i)]
69. The permittee must be in compliance with the emission limitations, operating limitations, and other requirements in this subpart that apply to the permittee at all times. [Reg.19.304 and 40 C.F.R. § 63.6605(a)]
70. At all times the permittee must operate and maintain any affected source, including associated air pollution control equipment and monitoring equipment, in a manner consistent with safety and good air pollution control practices for minimizing emissions. The general duty to minimize emissions does not require the permittee to make any further efforts to reduce emissions if levels required by this standard have been achieved. Determination of whether such operation and maintenance procedures are being used will be based on information available to the Administrator which may include, but is not limited to, monitoring results, review of operation and maintenance procedures, review of operation and maintenance records, and inspection of the source. [Reg.19.304 and 40 C.F.R. § 63.6605(b)]
71. The permittee shall continuously comply with each emission limitation, operating limitation, and other requirements as required by the following: [Reg.19.304, 40 C.F.R. § 63.6640(a), and Table 6 of 40 C.F.R. Part §63 Subpart ZZZZ]

For each	Complying with the requirement to	The permittee shall demonstrate continuous compliance by
----------	-----------------------------------	--

SN-24A & SN-24B	Work or Management practices	i. Operating and maintaining the stationary RICE according to the manufacturer’s emission-related operation and maintenance instructions; or ii. Develop and follow your own maintenance plan which must provide to the extent practicable for the maintenance and operation of the engine in a manner consistent with good air pollution control practice for minimizing emissions.
--------------------	------------------------------	---

72. The permittee must report each instance in which the engine did not meet each emission limitation or operating limitation in Table 2c that apply. These instances are deviations from the emission and operating limitations in this subpart. These deviations must be reported according to the requirements in Specific Condition # 79. If you change your catalyst, you must reestablish the values of the operating parameters measured during the initial performance test. When you reestablish the values of your operating parameters, you must also conduct a performance test to demonstrate that you are meeting the required emission limitation applicable to your stationary RICE. [Reg.19.304 and 40 C.F.R. § 63.6640(b)]
73. The permittee shall also report each instance in which you did not meet the applicable requirements in Table 8 to 40 C.F.R. § 63 Subpart ZZZZ. [Reg.19.304 and 40 C.F.R. § 63.6640(e)]
74. The permittee must operate the emergency stationary RICE according to the following requirements. In order for the engine to be considered an emergency stationary RICE under this subpart, any operation other than emergency operation, maintenance and testing, emergency demand response, and operation in non-emergency situations for 50 hours per year is prohibited. If the engine is not operated according to the following requirements, the engine will not be considered an emergency engine and must meet all requirements for non-emergency engines. [Reg.19.304 and 40 C.F.R. § 63.6640(f)]
- a. There is no time limit on the use of emergency stationary RICE in emergency situations.
 - b. The emergency stationary RICE may be operated for any combination of the following for a maximum of 100 hours per calendar year. Any operation for non-emergency situations as allowed by paragraph c of this section counts as part of the 100 hours per calendar year allowed by this paragraph (f)(2).
 - i. Emergency stationary RICE may be operated for maintenance checks and readiness testing, provided that the tests are recommended by federal, state or local government, the manufacturer, the vendor, the regional transmission organization or equivalent balancing authority and transmission operator, or the insurance company associated with the engine. The owner or operator may petition the Administrator for approval of additional hours to be used for maintenance checks and readiness testing, but a petition is not required if the owner or operator maintains records indicating that federal, state, or local standards require maintenance and testing of emergency RICE beyond 100 hours per calendar year.

- ii. Emergency stationary RICE may be operated for emergency demand response for periods in which the Reliability Coordinator under the North American Electric Reliability Corporation (NERC) Reliability Standard EOP-002-3, Capacity and Energy Emergencies (incorporated by reference, see § 63.14), or other authorized entity as determined by the Reliability Coordinator, has declared an Energy Emergency Alert Level 2 as defined in the NERC Reliability Standard EOP-002-3
 - iii. Emergency stationary RICE may be operated for periods where there is a deviation of voltage or frequency of 5 percent or greater below standard voltage or frequency.
- c. Emergency stationary RICE may be operated for up to 50 hours per calendar year in non-emergency situations. The 50 hours of operation in non-emergency situations are counted as part of the 100 hours per calendar year for maintenance and testing and emergency demand response provided in Specific Condition #74(b) of this section. The 50 hours per year for non-emergency situations cannot be used for peak shaving or non-emergency demand response, or to generate income for a facility to supply power to an electric grid or otherwise supply power as part of a financial arrangement with another entity.
75. The permittee must keep the records described in the following: [Reg.19.304 and 40 C.F.R. § 63.6655(a)]
- a. A copy of each notification and report that you submitted to comply with this subpart, including all documentation supporting any Initial Notification or Notification of Compliance Status that you submitted, according to the requirement in § 63.10(b)(2)(xiv).
 - b. Records of the occurrence and duration of each malfunction of operation (*i.e.*, process equipment) or the air pollution control and monitoring equipment.
 - c. Records of performance tests and performance evaluations as required in § 63.10(b)(2)(viii).
 - d. Records of all required maintenance performed on the air pollution control and monitoring equipment.
 - e. Records of actions taken during periods of malfunction to minimize emissions in accordance with Specific Condition # 70, including corrective actions to restore malfunctioning process and air pollution control and monitoring equipment to its normal or usual manner of operation.
76. The permittee shall keep the records required in Table 6 of 40 C.F.R. § 63 Subpart ZZZZ to show continuous compliance with each applicable emission or operating limitation. [Reg.19.304 and 40 C.F.R. § 63.6655(d)]
77. The permittee shall keep records of the maintenance conducted on SN-24A, SN-24B, and SN-24D in order to demonstrate that you operated and maintained the stationary RICE and after-treatment control device (if any) according to your own maintenance plan. [Reg.19.304 and 40 C.F.R. § 63.6655(e)]

78. If SN-24A or SN-24B does not meet the standards applicable to non-emergency engines, then you must keep records of the hours of operation of the engine that is recorded through the non-resettable hour meter. The owner or operator must document how many hours are spent for emergency operation, including what classified the operation as emergency and how many hours are spent for non-emergency operation. If the engine is used for the purposes specified in Specific Condition # 74.b.ii) or 74.b.iii), the owner or operator must keep records of the notification of the emergency situation, and the date, start time, and end time of engine operation for these purposes. [Reg. 19.304 and 40 C.F.R. § 63.6655(f)]
79. If SN-24B or SN-24D operates for more than 15 hours per calendar year for the purposes specified in Specific Condition # 74.b.ii) or 74.b.iii), the permittee must submit an annual report according to the following requirements. [Reg. 19.304 and 40 C.F.R. § 63.6650(h)]
- a. The report must contain the following information:
 - i. Company name and address where the engine is located.
 - ii. Date of the report and beginning and ending dates of the reporting period.
 - iii. Engine site rating and model year.
 - iv. Latitude and longitude of the engine in decimal degrees reported to the fifth decimal place.
 - v. Hours operated for the purposes specified in Specific Condition 74.b.ii) or 74.b.iii), including the date, start time, and end time for engine operation.
 - vi. Number of hours the engine is contractually obligated to be available for the purposes specified in Specific Condition # 74.b.ii) or 74.b.iii).
 - vii. If there were no deviations from the fuel requirements in Specific Condition # 64 that apply to the engine (if any), a statement that there were no deviations from the fuel requirements during the reporting period.
 - viii. If there were deviations from the fuel requirements in Specific Condition # 64 that apply to the engine (if any), information on the number, duration, and cause of deviations, and the corrective action taken.
 - b. The first annual report must cover the calendar year 2015 and must be submitted no later than March 31, 2016. Subsequent annual reports for each calendar year must be submitted no later than March 31 of the following calendar year.
 - c. The annual report must be submitted electronically using the subpart specific reporting form in the Compliance and Emissions Data Reporting Interface (CEDRI) that is accessed through EPA's Central Data Exchange (CDX) (www.epa.gov/cdx). However, if the reporting form specific to this subpart is not available in CEDRI at the time that the report is due, the written report must be submitted to the Administrator at the appropriate address listed in § 63.13.

NSPS Subpart IIII Conditions

80. Source SN-24C and SN-24E are subject to the provisions of 40 C.F.R. § 63 Subpart ZZZZ – National Emissions Standards for Stationary Reciprocating Internal Combustion

Engines. Compliance with Subpart ZZZZ shall be demonstrated through compliance with requirements of 40 C.F.R. § 60 Subpart IIII - Standards of Performance for Stationary Compression Ignition Internal Combustion Engines. The applicable provisions of this subpart include, but are not limited to, the items found in Specific Conditions #81 through #88. [Reg.19.304 and 40 C.F.R. § 60.4200]

81. The permittee must certify SN-24C and SN-24E to the certification emission standards for new nonroad CI engines for the same model year and maximum engine power in 40 C.F.R. § 89.112 and 40 C.F.R. § 89.113 for all pollutants beginning in model year 2007. [Reg.19.304 and 40 C.F.R. § 60.4202 (a)(2)]
82. The permittee shall only use diesel fuel in SN-24C and SN-24E that meets the requirements of 40 C.F.R. § 80.510(b) for nonroad diesel fuel. The permittee shall maintain records to demonstrate this condition on site and make these records available to Department personnel upon request. [Reg.19.304 and 40 C.F.R. § 60.4207 (b)]
83. The permittee shall install a non-resettable hour meter for SN-24C and SN-24E prior to startup of each engine if the engine does not meet the standards applicable to non-emergency engines. [Reg.19.304 and 40 C.F.R. § 60.4209 (a)]
84. The permittee must comply with the emission standards specified in this subpart and comply with the following, except as permitted under paragraph (g) of this section: [Reg.19.304 and 40 C.F.R. § 60.4211 (a)]
 - a. Operate and maintain the stationary CI internal combustion engine and control device according to the manufacturer's emission-related written instructions
 - b. Change only those emission-related settings that are permitted by the manufacturer
 - c. Meet the requirements of 40 C.F.R. parts 89, 94 and/or 1068.
85. The permittee shall comply with the emission standards specified in § 60.4205(b) by purchasing an engine certified to the emission standards in § 60.4205(b) for the same model year and maximum engine power. The engine must be installed and configured according to the manufacturer's emission-related specifications, except as permitted in paragraph § 60.4211(g). [Reg.19.304 and 40 C.F.R. § 60.4211 (c)]
86. The permittee shall operate the emergency stationary engines (SN-24C and SN-24E) according to the following requirements. The engine will not be considered an emergency engine and must meet all requirement for non-emergency engines if any operation other than emergency operation, maintenance and testing, emergency demand response, and operation in non-emergency situations for 50 hours per year is performed. [Reg.19.304 and 40 C.F.R. § 60.4211 (f)]
 - a. There is no time limit on the use of emergency stationary ICE in emergency situations.

- b. The permittee may operate the emergency stationary ICE for any combination of the purposes specified in the following for a maximum of 100 hours per calendar year. Any operation for non-emergency situations as allowed by paragraph(c) counts as part of the 100 hours per calendar year allowed.
 - i. Emergency stationary ICE may be operated for maintenance checks and readiness testing, provided that the tests are recommended by federal, state or local government, the manufacturer, the vendor, the regional transmission organization or equivalent balancing authority and transmission operator, or the insurance company associated with the engine. The Permittee may petition the Administrator for approval of additional hours to be used for maintenance checks and readiness testing, but a petition is not required if the owner or operator maintains records indicating that federal, state, or local standards require maintenance and testing of emergency ICE beyond 100 hours per calendar year.
 - ii. Emergency stationary ICE may be operated for emergency demand response for periods in which the Reliability Coordinator under the North American Electric Reliability Corporation (NERC) Reliability Standard EOP-002-3, Capacity and Energy Emergencies (incorporated by reference, see § 60.17), or other authorized entity as determined by the Reliability Coordinator, has declared an Energy Emergency Alert Level 2 as defined in the NERC Reliability Standard EOP-002-3.
 - iii. Emergency stationary ICE may be operated for periods where there is a deviation of voltage or frequency of 5 percent or greater below standard voltage or frequency.
- c. Emergency stationary ICE may be operated for up to 50 hours per calendar year in non-emergency situations. The 50 hours of operation in non-emergency situations are counted as part of the 100 hours per calendar year for maintenance and testing and emergency demand response provided in paragraph (b). Except as provided in the following, the 50 hours per calendar year for non-emergency situations cannot be used for peak shaving or non-emergency demand response, or to generate income for a facility to an electric grid or otherwise supply power as part of a financial arrangement with another entity.
 - i. The 50 hours per year for non-emergency situations can be used to supply power as part of a financial arrangement with another entity if all of the following conditions are met:
 - A. The engine is dispatched by the local balancing authority or local transmission and distribution system operator;
 - B. The dispatch is intended to mitigate local transmission and/or distribution limitations so as to avert potential voltage collapse or line overloads that could lead to the interruption of power supply in a local area or region.
 - C. The dispatch follows reliability, emergency operation or similar protocols that follow specific NERC, regional, state, public utility commission or local standards or guidelines.
 - D. The power is provided only to the facility itself or to support the local transmission and distribution system.

- E. The owner or operator identifies and records the entity that dispatches the engine and the specific NERC, regional, state, public utility commission or local standards or guidelines that are being followed for dispatching the engine. The local balancing authority or local transmission and distribution system operator may keep these records on behalf of the engine owner or operator.
87. If the permittee does not install, configure, operate, and maintain the engine and control device according to the manufacturer's emission-related written instructions, or the permittee changes emission-related settings in a way that is not permitted by the manufacturer, the permittee must demonstrate compliance by keeping a maintenance plan and records of conducted maintenance. The permittee must, to the extent practicable, maintain and operate the engine in a manner consistent with good air pollution control practice for minimizing emissions. In addition, the permittee must conduct an initial performance test to demonstrate compliance with the applicable emission standards within 1 year of startup, or within 1 year after an engine and control device is no longer installed, configured, operated, and maintained in accordance with the manufacturer's emission-related written instructions, or within 1 year after you change emission-related settings in a way that is not permitted by the manufacturer.[Reg.19.304 and 40 C.F.R. § 60.4211 (g)(2)]
88. The permittee is not required to submit an initial notification. For engine power $KW \geq 130$ ($HP \geq 175$) and starting with the model year 2011, if the emergency engine does not meet the standards applicable to non-emergency engines in the applicable model year, the owner or operator must keep records of the operation of the engine in emergency and non-emergency service that are recorded through the non-resettable hour meter. The owner must record the time of operation of the engine and the reason the engine was in operation during that time.[Reg.19.304 and 40 C.F.R. § 60.4214 (b)]

**SN-25
 Plant Fugitives**

Source Description

Plant fugitives include drum sampling; waste repackaging; pumps, flanges, and valves; tanker and railcar cleaning; tanker loading and unloading; vacuum truck loading and unloading; equipment and truck washing and decontamination; empty drum storage; unpaved roads, and paved roads.

Specific Conditions

89. The permittee shall not exceed the emission rates set forth in the following table. The permittee shall demonstrate compliance with this condition by Specific Conditions #91, #92, #94, #95, #96, and #97. [Reg.19.501 *et seq.* and 40 C.F.R. § 52 Subpart E]

Pollutant	lb/hr	tpy
PM ₁₀	1.7	1.6
VOC	23.2	15.7

90. The permittee shall not exceed the emission rates set forth in the following table. The permittee shall demonstrate compliance by Specific Conditions #91, #92, #94, #95, #96, and #97. [Reg.18.801 and Ark. Code Ann. § 8-4-203 as referenced by Ark. Code Ann. §§ 8-4-304 and 8-4-311]

Pollutant	lb/hr	tpy
PM	8.4	7.6
Chlorine	0.03	0.08
Hydrazine	0.03	0.08
Hydrochloric acid	0.03	0.08
Hydrogen fluoride	0.03	0.08
Methyl chloroform	0.33	1.40
Methylene chloride	0.67	2.91
Phosphine	0.03	0.08
Tetrachloroethylene	0.07	0.28
Titanium tetrachloride	0.03	0.08

Pollutant	lb/hr	tpy
Single Organic HAP	22.62	11.89
Total Organic HAP	22.62	11.89

91. The permittee shall not operate in a manner such that emissions from the roads would cause a nuisance off-site. Under normal conditions, off-site opacity less than or equal to 5% shall not be considered a nuisance. [Reg.18.501 and Ark. Code Ann. § 8-4-203 as referenced by Ark. Code Ann. §§ 8-4-304 and 8-4-311]
92. The permittee shall not exceed the following throughput limits at SN-25. [Reg.19.705, Ark. Code Ann. § 8-4-203 as referenced by §§ 8-4-304 and 8-4-311, and 40 C.F.R. § 70.6]

Activity	Limit
Drum Filling	2,400,000 gal/yr
Waste Repackaging	56,000 drums/yr
Tanker and Railcar Cleaning	152 rail tank cars/yr
	1930 tank trucks/yr
Tanker Loading/Unloading	100 tankers/yr
	1,930 tankers pumped/yr
Vacuum Truck Loading	750,000 gal rain water collection/yr
Equipment and Truck Wash/Decontamination	1,260,000 gal wash water/yr
Paved roads	3,100 vehicle miles traveled via 18-wheel traffic/yr
	133,360 vehicle miles traveled via Clean Harbors vehicles/yr
Railcar Loading	1,380,000 gallons/yr

93. The permittee shall maintain monthly records which demonstrate compliance with the throughput limits set in Specific Condition #92. These records may be used by the Department for enforcement purposes. These records shall be updated by the fifteenth day of the month following the month to which the records pertain, shall be kept on site, and shall be provided to Department personnel upon request. A 12-month rolling total and each individual month's data shall be submitted in accordance with General Provision #7. [Reg.19.705 and 40 C.F.R. § 52 Subpart E]
94. No later than 30 days after issuance of Permit #1009-AOP-R3, the permittee shall submit a detailed haul road maintenance plan to the Department. The permittee shall comply with the approved road maintenance plan. A copy of the approved plan and associated recordkeeping shall be kept on site and made available to Department personnel upon

request. The Department approved the road maintenance plan dated November 3, 2008. [Reg.18.1004, Reg.19.705, 40 C.F.R. § 70.6, and Ark. Code Ann. § 8-4-203 as referenced by Ark. Code Ann. §§ 8-4-304 and 8-4-311]

95. The permittee shall maintain the carbon canisters used to control emissions from the tank transfer operations per manufacturer's specifications. [Reg.19.303 and Ark. Code Ann. § 8-4-203 as referenced by Ark. Code Ann. §§ 8-4-304 and 8-4-311]
96. The permittee shall maintain the carbon tank used to control emissions from the drum pumping per manufacturer's specifications. [Reg.19.303 and Ark. Code Ann. § 8-4-203 as referenced by Ark. Code Ann. §§ 8-4-304 and 8-4-311]
97. SN-25, railcar loading, is subject to Compliance Assurance Monitoring and shall comply with all applicable provisions, including but not limited to: [Reg.19.304 and 40 C.F.R. § 64]
 - a. Indicator: The permittee shall monitor the throughput, monitor the VOC concentration, and document daily inspections of the carbon canisters. [40 C.F.R. § 64.6(c)(1)(i)]
 - b. Indicator Range and Averaging Period: The permittee shall maintain the organic liquid throughput below the limit specified in Specific Condition #92 on a rolling 12-month basis; a VOC concentration of 500 ppmv or greater requires replacement of one or both carbon canisters; and the permittee shall perform daily inspections of the carbon canisters to document undamaged condition. [40 C.F.R. § 64.6(c)(2)]
 - c. Measurement Approach: The permittee shall maintain receiving records for the throughput of SN-25, railcar loading; use EPA Reference Method 21 to determine the VOC concentration; and perform daily inspections of the carbon canisters. [40 C.F.R. § 64.6(c)(1)(ii)]
 - d. Data Representativeness: The permittee shall test for the VOC concentration between the primary and secondary carbon canisters using EPA Reference Method 21. The daily inspections shall be performed by trained personnel using documented inspection procedures. [40 C.F.R. § 64.6(c)(1)(iii)]
 - e. QA/QC and Frequency of Monitoring: The permittee shall follow the manufacturer's recommendations for maintenance of the carbon canisters. Personnel shall be trained on the inspection procedures. The carbon canisters shall be inspected daily. The throughput shall be updated monthly in accordance with Specific Condition #93. The VOC concentration measurements shall follow the procedures of EPA Reference Method 21, and the VOC concentration shall be monitored according to 40 C.F.R. § 264.1033(h). [40 C.F.R. §§ 64.6(c)(1)(iii) and 64.3(b)(4)]

- f. A monitoring report shall be submitted to the Department in accordance with General Provision #7 and shall include the following per 40 C.F.R. § 64.9(a)(2):
 - i. The information required under 40 C.F.R. § 70.6(a)(3)(iii);
 - ii. Summary information on the number, duration and cause (including unknown cause, if applicable) of excursions or exceedances, as applicable, and the corrective actions taken; and
 - iii. A description of the actions taken to implement a QIP, if required, during the reporting period as specified in §64.8. Upon completion of a QIP, the owner or operator shall include in the next summary report documentation that the implementation of the plan has been completed and reduced the likelihood of similar levels of excursions or exceedances occurring. A QIP shall be required if the excess emissions exceeds 5% of the unit operating time.

- g. The permittee shall comply with the recordkeeping requirements specified in § 70.6(a)(3)(ii). The permittee shall maintain records of monitoring data, monitor performance data, corrective actions taken, any written quality improvement plan required pursuant to § 64.8 and any activities undertaken to implement a quality improvement plan, and other supporting information required to be maintained under 40 C.F.R. § 64 (such as data used to document the adequacy of monitoring, or records of monitoring maintenance or corrective actions). [40 C.F.R. § 64.9(b)(1)]

**SN-31, SN-35, SN-36, SN-37, SN-38, SN-39, SN-40, and SN-41
 Solvent Recovery System Storage Tanks, Cooling Towers, Process Emissions, Railcar
 Loading, Drum Filling, Tanker Loading, and Fugitive**

Source Description

SN-31 consists of 7 waste solvent storage tanks (144-TNK-201 through 204 and 600-TNK-502 through 504) and 23 intermediate and final product storage tanks (600-TNK-505 through 527). The waste solvent storage tanks are loaded by a 250 gpm pump. The intermediate/final product storage tanks are loaded at a rate of 1,831.25 gallons per hour (physical limit of solvent produced is 43,950 gallons per day).

Material	Tank	Capacity
Waste Solvent	144-TNK-201 through 204	10,000 gallons each
	600-TNK-502	11,655 gallons
	600-TNK-503 and 504	19,400 gallons each
Intermediate/Final Product	600-TNK-505 through 522	8,800 gallons each
	600-TNK-523 through 526	11,160 gallons each
	600-TNK-527	13,000 gallons

SN-37 consists of a vacuum pot distillation unit, thin film evaporator, and two distillation columns. The solvent recovery equipment operates at a maximum of 58,600 gallons per day. The solvent processed through the thin film evaporator may be subject to additional treatment through the distillation columns. The emissions from the process equipment are combined.

SN-31 vents through two carbon canisters in series. SN-37 vents to the secondary combustion chamber (SCC) but may be vented through two carbon canisters in series up to 15% of the year when the SCC is not operating.

SN-38 consists of the loadout of final products into railcars for off-site shipment. Railcars are loaded by pump with a maximum rate of 4,800 gallons per hour. The emissions are controlled with carbon canisters in series.

SN-39 consists of filling 55 gallon drums with final products. The facility can fill a maximum of 80 drums per hour.

SN-40 consists of submerged loading of final product into tankers. The tanker capacity is 6,000 gallons and loaded by pump with a maximum rate of 6,000 gallons per hour. A maximum of one tanker can be loaded at any given time. The emissions from the final product loading operations to tankers are captured through a vapor balance system. The tanker vent is connected to the tank vent and displaced air is sent back to the tank to balance the vapor.

SN-41 consists of solvent recovery system fugitive emissions that occur at pumps, connectors, and valves.

SN-35 and SN-36 consist of two wet cooling towers. The water flow rate of each cooling tower is 820 gallons per minute.

Specific Conditions

98. The permittee shall not exceed the emission rates set forth in the following table. The permittee shall demonstrate compliance with this condition by Specific Conditions #100, #101, #103, #104, #105, #106, and #109. [Reg.19.501 *et seq.* and 40 C.F.R. § 52 Subpart E]

Source	Description	Pollutant	lb/hr	tpy
SN-31	Solvent Recovery System Storage Tanks (Seven Waste Solvent Tanks and 23 Product Solvent Tanks vented to two carbon canisters in series)	VOC	5.2	0.7
SN-35	Solvent Recovery System Cooling Tower	PM ₁₀	0.3	1.3
SN-36	Solvent Recovery System Cooling Tower	PM ₁₀	0.3	1.3
SN-37	Solvent Recovery System Process Emissions (Vacuum Pot Distillation Unit, Thin Film Evaporator, and two Distillation Columns vented to two carbon canisters in series)	VOC	5.9	2.2
SN-38	Solvent Recovery System Railcar Loading (with two carbon canisters in series)	VOC	0.9	0.2
SN-39	Solvent Recovery System Drum Filling (with carbon canisters in series)	VOC	4.0	0.4
SN-40	Solvent Recovery System Tanker Loading (with emissions routed back to the tanks)	VOC	10.9	5.6
SN-41	Solvent Recovery System Fugitive	VOC	0.1	0.1

99. The permittee shall not exceed the emission rates set forth in the following table. The permittee shall demonstrate compliance with this condition by Specific Conditions #100,

Clean Harbors El Dorado, LLC
 Permit #: 1009-AOP-R16
 AFIN: 70-00098

#101, #103, #104, #105, #106, and #109 and Plantwide Condition #33. [Reg.18.801 and Ark. Code Ann. § 8-4-203 as referenced by Ark. Code Ann. §§ 8-4-304 and 8-4-311]

Source	Description	Pollutant	lb/hr	tpy
SN-31	Solvent Recovery System Storage Tanks (Seven Waste Solvent Tanks and 23 Product Solvent Tanks vented to two carbon canisters in series)	Methyl chloroform	2.42	0.31
		Methylene chloride	5.14	0.66
		Tetrachloroethylene	0.40	0.05
		Single Organic HAP	5.14	0.66
		Total Organic HAP	5.14	0.66
SN-35	Solvent Recovery System Cooling Tower	PM	0.3	1.3
SN-36	Solvent Recovery System Cooling Tower	PM	0.3	1.3
SN-37	Solvent Recovery System Process Emissions (Vacuum Pot Distillation Unit, Thin Film Evaporator, and two Distillation Columns vented to two carbon canisters in series)	Methyl chloroform	2.77	1.00
		Methylene chloride	5.88	2.12
		Tetrachloroethylene	0.46	0.16
		Single Organic HAP	5.88	2.12
		Total Organic HAP	5.88	2.12
SN-38	Solvent Recovery System Railcar Loading (with two carbon canisters in series)	Methyl chloroform	0.41	0.08
		Methylene chloride	0.87	0.16
		Tetrachloroethylene	0.07	0.02
		Single Organic HAP	0.87	0.16
		Total Organic HAP	0.87	0.16
SN-39	Solvent Recovery System Drum Filling (with carbon canisters in series)	Methyl chloroform	1.88	0.19
		Methylene chloride	3.97	0.40
		Tetrachloroethylene	0.31	0.04
		Single Organic HAP	3.97	0.40
		Total Organic HAP	3.97	0.40
SN-40	Solvent Recovery System Tanker Loading (with emissions routed back to the tanks)	Methyl chloroform	5.09	2.61
		Methylene chloride	10.81	5.54
		Tetrachloroethylene	0.85	0.42
		Single Organic HAP	10.81	5.54
		Total Organic HAP	10.81	5.54
SN-41	Solvent Recovery System Fugitive	Methyl chloroform	0.01	0.01
		Methylene chloride	0.01	0.02
		Tetrachloroethylene	0.01	0.01
		Single Organic HAP	0.01	0.02
		Total Organic HAP	0.01	0.02

100. The permittee shall not exceed the following throughput limits. [Reg.19.705, Ark. Code Ann. § 8-4-203 as referenced by Ark. Code Ann. §§ 8-4-304 and 8-4-311, and 40 C.F.R. § 70.6]

Source	Activity	Limit
SN-31	Throughput of Waste Solvent Tanks	11,720,000 gallons per year
SN-31	Throughput of Intermediate and Final Products Tanks	8,790,000 gallons per year
SN-37	Throughput of Solvent	67,373 tons per year
SN-38	Load out to Railcars	1,771,000 gallons per year
SN-39	Load out to 55 gallon drums	879,000 gallons per year
SN-40	Load out to Tanker Trucks	6,153,000 gallons per year

101. The permittee shall vent SN-31 and SN-37 to carbon canisters when not being vented to the secondary combustion chamber (SN-01). The permittee shall not exceed the following throughput limits while being vented to the carbon canisters. [Reg.19.705, Ark. Code Ann. § 8-4-203 as referenced by Ark. Code Ann. §§ 8-4-304 and 8-4-311, and 40 C.F.R. § 70.6]

Source	Activity	Limit
SN-31	Throughput of Waste Solvent Tanks	1,758,000 gallons per year
	Throughput of Intermediate and Final Products Tanks	1,318,500 gallons per year
SN-37	Throughput of Solvent	10,106 tons per year

102. The permittee shall maintain monthly records which demonstrate compliance with the throughput limits set in Specific Conditions #100 and #101. These records may be used by the Department for enforcement purposes. These records shall be updated by the fifteenth day of the month following the month to which the records pertain, shall be kept on site, and shall be provided to Department personnel upon request. A 12-month rolling total and each individual month's data shall be submitted in accordance with General Provision #7. [Reg.19.705 and 40 C.F.R. § 52 Subpart E]
103. The permittee shall not exceed a vapor pressure of 6.159 psia at 65°F for the contents of the storage tanks at SN-31. Supporting documentation shall be maintained on site to demonstrate compliance with this specific condition. [Reg.19.705, Ark. Code Ann. § 8-4-203 as referenced by Ark. Code Ann. §§ 8-4-304 and 8-4-311, and 40 C.F.R. § 70.6]
104. The permittee shall not process any material at the Solvent Recovery System such that the product of the vapor pressure and molecular weight exceeds 523.15 psia lb/lbmol. Supporting documentation shall be maintained on site to demonstrate compliance with this specific condition. [Reg.19.705, Ark. Code Ann. § 8-4-203 as referenced by Ark. Code Ann. §§ 8-4-304 and 8-4-311, and 40 C.F.R. § 70.6]

105. The permittee shall maintain the carbon canisters per manufacturer's specifications on the tank farm while any material is being stored in any tank within the tank farm.
[Reg.19.303 and Ark. Code Ann. § 8-4-203 as referenced by Ark. Code Ann. §§ 8-4-304 and 8-4-311]
106. The permittee shall maintain the carbon canisters per manufacturer's specifications at SN-37, SN-38, and SN-39. [Reg.19.303 and Ark. Code Ann. § 8-4-203 as referenced by Ark. Code Ann. §§ 8-4-304 and 8-4-311]
107. SN-31, SN-37, SN-38, SN-39 and SN-40 are subject to Compliance Assurance Monitoring and shall comply with all applicable provisions, including but not limited to:
[Reg.19.304 and 40 C.F.R. § 64]
 - a. Indicator: The permittee shall monitor the organic liquid throughput, monitor the VOC concentration, and document daily inspections of the carbon canisters. [40 C.F.R. § 64.6(c)(1)(i)]
 - b. Indicator Range and Averaging Period: The permittee shall maintain the organic liquid throughput below the limit specified in Specific Condition #100 and #101 on a rolling 12-month basis; a VOC concentration of 500 ppmv or greater requires replacement of one or both carbon canisters; and the permittee shall perform daily inspections of the carbon canisters to document undamaged condition. [40 C.F.R. § 64.6(c)(2)]
 - c. Measurement Approach: The permittee shall maintain receiving records for the throughput of these sources; use EPA Reference Method 21 to determine the VOC concentration; and perform daily inspections of the carbon canisters. [40 C.F.R. § 64.6(c)(1)(ii)]
 - d. Data Representativeness: The permittee shall test for the VOC concentration between the primary and secondary carbon canisters using EPA Reference Method 21. The daily inspections shall be performed by trained personnel using documented inspection procedures. [40 C.F.R. § 64.6(c)(1)(iii)]
 - e. QA/QC and Frequency of Monitoring: The permittee shall follow the manufacturer's recommendations for maintenance of the carbon canisters. Personnel shall be trained on the inspection procedures. The carbon canisters shall be inspected daily. The throughput shall be updated monthly in accordance with Specific Condition #102. The VOC concentration measurements shall follow the procedures of EPA Reference Method 21, and the VOC concentration shall be monitored according to the schedule required by 40 C.F.R. § 264 Subpart CC. [40 C.F.R. §§ 64.6(c)(1)(iii) and 64.3(b)(4)]

- f. A monitoring report shall be submitted to the Department in accordance with General Provision #7 and shall include the following per 40 C.F.R. § 64.9(a)(2):
 - i. The information required under 40 C.F.R. § 70.6(a)(3)(iii);
 - ii. Summary information on the number, duration and cause (including unknown cause, if applicable) of excursions or exceedances, as applicable, and the corrective actions taken; and
 - iii. A description of the actions taken to implement a QIP, if required, during the reporting period as specified in §64.8. Upon completion of a QIP, the owner or operator shall include in the next summary report documentation that the implementation of the plan has been completed and reduced the likelihood of similar levels of excursions or exceedances occurring. A QIP shall be required if the excess emissions exceeds 5% of the unit operating time.
108. The permittee shall comply with the recordkeeping requirements specified in § 70.6(a)(3)(ii). The permittee shall maintain records of monitoring data, monitor performance data, corrective actions taken, any written quality improvement plan required pursuant to § 64.8 and any activities undertaken to implement a quality improvement plan, and other supporting information required to be maintained under 40 C.F.R. § 64 (such as data used to document the adequacy of monitoring, or records of monitoring maintenance or corrective actions). [40 C.F.R. § 64.9(b)(1)]
109. Each pump, pressure relief device, sampling connection system, open-ended valve or line, valve, and flange or other connector in VOC service and any devices or systems required by 40 C.F.R. § 60 Subpart VVa is subject to 40 C.F.R. § 60 Subpart VVa – Standards of Performance for Equipment Leaks of VOC in the Synthetic Organic Chemicals Manufacturing Industry for Which Construction, Reconstruction, or Modification Commenced After November 7, 2006. The permittee shall comply with all applicable requirements under 40 C.F.R. § 60 Subpart VVa. These requirements include, but are not limited to, the following: [Reg.19.304 and 40 C.F.R. § 60 Subpart VVa]
 - a. Each owner or operator subject to the provisions of 40 C.F.R. § 60 Subpart VVa shall demonstrate compliance with the requirements of §§ 60.482–1a through 60.482–10a for all equipment within 180 days of initial startup. [Reg.19.304 and 40 C.F.R. § 60.482-1a(a)]
 - b. Compliance with §§ 60.482–1a to 60.482–10a will be determined by review of records and reports, review of performance test results, and inspection using the methods and procedures specified in § 60.485a. [Reg.19.304 and 40 C.F.R. § 60.482-1a(b)]

- c. If the storage vessel is shared with multiple process units, the process unit with the greatest annual amount of stored materials (predominant use) is the process unit the storage vessel is assigned to. If the storage vessel is shared equally among process units, and one of the process units has equipment subject to 40 C.F.R. § 60 Subpart VVa, the storage vessel is assigned to that process unit. If the storage vessel is shared equally among process units, none of which have equipment subject to 40 C.F.R. § 60 Subpart VVa, the storage vessel is assigned to any process unit subject to subpart VV of this part. If the predominant use of the storage vessel varies from year to year, then the owner or operator must estimate the predominant use initially and reassess every 3 years. The owner or operator must keep records of the information and supporting calculations that show how predominant use is determined. All equipment on the storage vessel must be monitored when in VOC service. [Reg.19.304 and 40 C.F.R. § 60.482-1a(g)] Effective Date Note: At 73 FR 31376, June 2, 2008, in §60.482-1a, paragraph (g) was stayed until further notice.
- d. Each pump in light liquid service shall be monitored monthly to detect leaks by the methods specified in § 60.485a(b). A pump that begins operation in light liquid service after the initial startup date for the process unit must be monitored for the first time within 30 days after the end of its startup period, except for a pump that replaces a leaking pump. [Reg.19.304 and 40 C.F.R. § 60.482-2a(a)(1)]
- e. Each pump in light liquid service shall be checked by visual inspection each calendar week for indications of liquids dripping from the pump seal. [Reg.19.304 and 40 C.F.R. § 60.482-2a(a)(2)]
- f. The instrument reading that defines a leak is specified in paragraphs (b)(1)(i) and (ii) of § 60.482-2a. [Reg.19.304 and 40 C.F.R. § 60.482-2a(b)(1)]
 - i. 5,000 parts per million (ppm) or greater for pumps handling polymerizing monomers;
 - ii. 2,000 ppm or greater for all other pumps.
- g. If there are indications of liquids dripping from the pump seal, the owner or operator shall follow the procedure specified in either paragraph (b)(2)(i) or (ii) of § 60.482-2a. This requirement does not apply to a pump that was monitored after a previous weekly inspection and the instrument reading was less than the concentration specified in paragraph (b)(1)(i) or (ii) of § 60.482-2a, whichever is applicable. [Reg.19.304 and 40 C.F.R. § 60.482-2a(b)(2)]
 - i. Monitor the pump within 5 days as specified in § 60.485a(b). A leak is detected if the instrument reading measured during monitoring indicates a leak as specified in paragraph (b)(1)(i) or (ii) of § 60.482-2a, whichever is applicable. The leak shall be repaired using the procedures in paragraph (c) of § 60.482-2a. [Reg.19.304 and 40 C.F.R. § 60.482-2a(b)(2)(i)]

- ii. Designate the visual indications of liquids dripping as a leak, and repair the leak using either the procedures in paragraph (c) of § 60.482-2a or by eliminating the visual indications of liquids dripping. [Reg.19.304 and 40 C.F.R. § 60.482-2a(b)(2)(ii)]
- h. When a leak is detected, it shall be repaired as soon as practicable, but not later than 15 calendar days after it is detected, except as provided in § 60.482-9a. [Reg.19.304 and 40 C.F.R. § 60.482-2a(c)(1)]
- i. A first attempt at repair shall be made no later than 5 calendar days after each leak is detected. First attempts at repair include, but are not limited to, the practices described in paragraphs (c)(2)(i) and (ii) of § 60.482-2a, where practicable. [Reg.19.304 and 40 C.F.R. § 60.482-2a(c)(2)]
 - i. Tightening the packing gland nuts;
 - ii. Ensuring that the seal flush is operating at design pressure and temperature.
- j. Except during pressure releases, each pressure relief device in gas/vapor service shall be operated with no detectable emissions, as indicated by an instrument reading of less than 500 ppm above background, as determined by the methods specified in § 60.485a(c). [Reg.19.304 and 40 C.F.R. § 60.482-4a(a)]
- k. After each pressure release, the pressure relief device shall be returned to a condition of no detectable emissions, as indicated by an instrument reading of less than 500 ppm above background, as soon as practicable, but no later than 5 calendar days after the pressure release, except as provided in § 60.482-9a. [Reg.19.304 and 40 C.F.R. § 60.482-4a(b)(1)]
- l. No later than 5 calendar days after the pressure release, the pressure relief device shall be monitored to confirm the conditions of no detectable emissions, as indicated by an instrument reading of less than 500 ppm above background, by the methods specified in § 60.485a(c). [Reg.19.304 and 40 C.F.R. § 60.482-4a(b)(2)]
- m. Any pressure relief device that is routed to a process or fuel gas system or equipped with a closed vent system capable of capturing and transporting leakage through the pressure relief device to a control device as described in § 60.482-10a is exempted from the requirements of paragraphs (a) and (b) of § 60.482-4a. [Reg.19.304 and 40 C.F.R. § 60.482-4a(c)]
- n. Any pressure relief device that is equipped with a rupture disk upstream of the pressure relief device is exempt from the requirements of paragraphs (a) and (b) of § 60.482-4a, provided the owner or operator complies with the requirements in paragraph (d)(2) of § 60.482-4a. [Reg.19.304 and 40 C.F.R. § 60.482-4a(d)(1)]

- o. After each pressure release, a new rupture disk shall be installed upstream of the pressure relief device as soon as practicable, but no later than 5 calendar days after each pressure release, except as provided in § 60.482–9a. [Reg.19.304 and 40 C.F.R. § 60.482-4a(d)(2)]
- p. Each sampling connection system shall be equipped with a closed-purge, closed-loop, or closed-vent system, except as provided in § 60.482–1a(c) and paragraph (c) of § 60.482-5a. [Reg.19.304 and 40 C.F.R. § 60.482-5a(a)]
- q. Each closed-purge, closed-loop, or closed-vent system as required in paragraph (a) of § 60.482-5a shall comply with the requirements specified in paragraphs (b)(1) through (4) of § 60.482-5a. [Reg.19.304 and 40 C.F.R. § 60.482-5a(b)]
 - i. Gases displaced during filling of the sample container are not required to be collected or captured.
 - ii. Containers that are part of a closed-purge system must be covered or closed when not being filled or emptied.
 - iii. Gases remaining in the tubing or piping between the closed-purge system valve(s) and sample container valve(s) after the valves are closed and the sample container is disconnected are not required to be collected or captured.
 - iv. Each closed-purge, closed-loop, or closed-vent system shall be designed and operated to meet requirements in either paragraph (b)(4)(i), (ii), (iii), or (iv) of § 60.482-5a.
 - A. Return the purged process fluid directly to the process line.
 - B. Collect and recycle the purged process fluid to a process.
 - C. Capture and transport all the purged process fluid to a control device that complies with the requirements of § 60.482–10a.
 - D. Collect, store, and transport the purged process fluid to any of the following systems or facilities:
 - 1. A waste management unit as defined in 40 C.F.R. § 63.111, if the waste management unit is subject to and operated in compliance with the provisions of 40 C.F.R. § 63 subpart G, applicable to Group 1 wastewater streams;
 - 2. A treatment, storage, or disposal facility subject to regulation under 40 C.F.R. §§ 262, 264, 265, or 266;
 - 3. A facility permitted, licensed, or registered by a state to manage municipal or industrial solid waste, if the process fluids are not hazardous waste as defined in 40 C.F.R. § 261;
 - 4. A waste management unit subject to and operated in compliance with the treatment requirements of 40 C.F.R. § 61.348(a), provided all waste management units that collect, store, or transport the purged process fluid to the treatment unit are subject to and operated in compliance with the management requirements of 40 C.F.R. § 61.343 through 40 C.F.R. § 61.347; or

5. A device used to burn off-specification used oil for energy recovery in accordance with 40 C.F.R. § 279 subpart G, provided the purged process fluid is not hazardous waste as defined in 40 C.F.R. § 261.
- r. Each open-ended valve or line shall be equipped with a cap, blind flange, plug, or a second valve, except as provided in § 60.482-1a(c) and paragraphs (d) and (e) of § 60.482-6a. [Reg.19.304 and 40 C.F.R. § 60.482-6a(a)(1)]
 - s. The cap, blind flange, plug, or second valve shall seal the open end at all times except during operations requiring process fluid flow through the open-ended valve or line. [Reg.19.304 and 40 C.F.R. § 60.482-6a(a)(2)]
 - t. Each open-ended valve or line equipped with a second valve shall be operated in a manner such that the valve on the process fluid end is closed before the second valve is closed. [Reg.19.304 and 40 C.F.R. § 60.482-6a(b)]
 - u. When a double block-and-bleed system is being used, the bleed valve or line may remain open during operations that require venting the line between the block valves but shall comply with paragraph (a) of § 60.482-6a at all other times. [Reg.19.304 and 40 C.F.R. § 60.482-6a(c)]
 - v. Open-ended valves or lines in an emergency shutdown system which are designed to open automatically in the event of a process upset are exempt from the requirements of paragraphs (a), (b), and (c) of § 60.482-6a. [Reg.19.304 and 40 C.F.R. § 60.482-6a(d)]
 - w. Open-ended valves or lines containing materials which would autocatalytically polymerize or would present an explosion, serious overpressure, or other safety hazard if capped or equipped with a double block and bleed system as specified in paragraphs (a) through (c) of § 60.482-6a are exempt from the requirements of paragraphs (a) through (c) of § 60.482-6a. [Reg.19.304 and 40 C.F.R. § 60.482-6a(e)]
 - x. Each valve shall be monitored monthly to detect leaks by the methods specified in § 60.485a(b) and shall comply with paragraphs (b) through (e) of § 60.482-7a. [Reg.19.304 and 40 C.F.R. § 60.482-7a(a)(1)]
 - y. A valve that begins operation in gas/vapor service or light liquid service after the initial startup date for the process unit must be monitored according to paragraphs (a)(2)(i) or (ii), except for a valve that replaces a leaking valve. [Reg.19.304 and 40 C.F.R. § 60.482-7a(a)(2)]
 - i. Monitor the valve as in paragraph (a)(1) of § 60.482-7a. The valve must be monitored for the first time within 30 days after the end of its startup period to ensure proper installation.

- z. If an instrument reading of 500 ppm or greater is measured, a leak is detected. [Reg.19.304 and 40 C.F.R. § 60.482-7a(b)]
- aa. Any valve for which a leak is not detected for 2 successive months may be monitored the first month of every quarter, beginning with the next quarter, until a leak is detected. [Reg.19.304 and 40 C.F.R. § 60.482-7a(c)(1)(i)]
- bb. As an alternative to monitoring all of the valves in the first month of a quarter, an owner or operator may elect to subdivide the process unit into two or three subgroups of valves and monitor each subgroup in a different month during the quarter, provided each subgroup is monitored every 3 months. The owner or operator must keep records of the valves assigned to each subgroup. [Reg.19.304 and 40 C.F.R. § 60.482-7a(c)(1)(ii)]
- cc. If a leak is detected, the valve shall be monitored monthly until a leak is not detected for 2 successive months. [Reg.19.304 and 40 C.F.R. § 60.482-7a(c)(2)]
- dd. When a leak is detected, it shall be repaired as soon as practicable, but no later than 15 calendar days after the leak is detected, except as provided in § 60.482-9a. [Reg.19.304 and 40 C.F.R. § 60.482-7a(d)(1)]
- ee. A first attempt at repair shall be made no later than 5 calendar days after each leak is detected. [Reg.19.304 and 40 C.F.R. § 60.482-7a(d)(2)]
- ff. First attempts at repair include, but are not limited to, the following best practices where practicable: [Reg.19.304 and 40 C.F.R. § 60.482-7a(e)]
 - i. Tightening of bonnet bolts;
 - ii. Replacement of bonnet bolts;
 - iii. Tightening of packing gland nuts;
 - iv. Injection of lubricant into lubricated packing.
- gg. If evidence of a potential leak is found by visual, audible, olfactory, or any other detection method at pumps, valves, and connectors in heavy liquid service and pressure relief devices in light liquid or heavy liquid service, the owner or operator shall follow either one of the following procedures: [Reg.19.304 and 40 C.F.R. § 60.482-8a(a)]
 - i. The owner or operator shall monitor the equipment within 5 days by the method specified in § 60.485a(b) and shall comply with the requirements of paragraphs (b) through (d) of § 60.482-8a.
 - ii. The owner or operator shall eliminate the visual, audible, olfactory, or other indication of a potential leak within 5 calendar days of detection.
- hh. If an instrument reading of 10,000 ppm or greater is measured, a leak is detected. [Reg.19.304 and 40 C.F.R. § 60.482-8a(b)]

- ii. When a leak is detected, it shall be repaired as soon as practicable, but not later than 15 calendar days after it is detected, except as provided in § 60.482-9a. [Reg.19.304 and 40 C.F.R. § 60.482-8a(c)(1)]
- jj. The first attempt at repair shall be made no later than 5 calendar days after each leak is detected. [Reg.19.304 and 40 C.F.R. § 60.482-8a(c)(2)]
- kk. First attempts at repair include, but are not limited to, the best practices described under §§ 60.482-2a(c)(2) and 60.482-7a(e). [Reg.19.304 and 40 C.F.R. § 60.482-8a(d)]
- ll. Delay of repair of equipment for which leaks have been detected will be allowed if repair within 15 days is technically infeasible without a process unit shutdown. Repair of this equipment shall occur before the end of the next process unit shutdown. Monitoring to verify repair must occur within 15 days after startup of the process unit. [Reg.19.304 and 40 C.F.R. § 60.482-9a(a)]
- mm. Delay of repair of equipment will be allowed for equipment which is isolated from the process and which does not remain in VOC service. [Reg.19.304 and 40 C.F.R. § 60.482-9a(b)]
- nn. Delay of repair for valves and connectors will be allowed if: [Reg.19.304 and 40 C.F.R. § 60.482-9a(c)]
 - i. The owner or operator demonstrates that emissions of purged material resulting from immediate repair are greater than the fugitive emissions likely to result from delay of repair, and
 - ii. When repair procedures are effected, the purged material is collected and destroyed or recovered in a control device complying with § 60.482-10a.
- oo. Delay of repair for pumps will be allowed if: [Reg.19.304 and 40 C.F.R. § 60.482-9a(d)]
 - i. Repair requires the use of a dual mechanical seal system that includes a barrier fluid system, and
 - ii. Repair is completed as soon as practicable, but not later than 6 months after the leak was detected.
- pp. Delay of repair beyond a process unit shutdown will be allowed for a valve, if valve assembly replacement is necessary during the process unit shutdown, valve assembly supplies have been depleted, and valve assembly supplies had been sufficiently stocked before the supplies were depleted. Delay of repair beyond the next process unit shutdown will not be allowed unless the next process unit shutdown occurs sooner than 6 months after the first process unit shutdown. [Reg.19.304 and 40 C.F.R. § 60.482-9a(e)]

- qq. When delay of repair is allowed for a leaking pump, valve, or connector that remains in service, the pump, valve, or connector may be considered to be repaired and no longer subject to delay of repair requirements if two consecutive monthly monitoring instrument readings are below the leak definition. [Reg.19.304 and 40 C.F.R. § 60.482-9a(f)]
- rr. The owner or operator shall initially monitor all connectors in the process unit for leaks by the later of either 12 months after the compliance date or 12 months after initial startup. If all connectors in the process unit have been monitored for leaks prior to the compliance date, no initial monitoring is required provided either no process changes have been made since the monitoring or the owner or operator can determine that the results of the monitoring, with or without adjustments, reliably demonstrate compliance despite process changes. If required to monitor because of a process change, the owner or operator is required to monitor only those connectors involved in the process change. [Reg.19.304 and 40 C.F.R. § 60.482-11a(a)]
- ss. Except as allowed in § 60.482-10a, the owner or operator shall monitor all connectors in gas and vapor and light liquid service as specified in paragraphs (a) and (b)(3) of § 60.482-11a. [Reg.19.304 and 40 C.F.R. § 60.482-11a(b)]
- i. The connectors shall be monitored to detect leaks by the method specified in § 60.485a(b) and, as applicable, § 60.485a(c).
 - ii. If an instrument reading greater than or equal to 500 ppm is measured, a leak is detected.
 - iii. The owner or operator shall perform monitoring, subsequent to the initial monitoring required in paragraph (a) of § 60.482-11a, as specified in paragraphs (b)(3)(i) through (iii) of § 60.482-11a, and shall comply with the requirements of paragraphs (b)(3)(iv) and (v) of § 60.482-11a. The required period in which monitoring must be conducted shall be determined from paragraphs (b)(3)(i) through (iii) of § 60.482-11a using the monitoring results from the preceding monitoring period. The percent leaking connectors shall be calculated as specified in paragraph (c) of § 60.482-11a.
 - A. If the percent leaking connectors in the process unit were greater than or equal to 0.5 percent, then monitor within 12 months (1 year).
 - B. If the percent leaking connectors in the process unit was greater than or equal to 0.25 percent but less than 0.5 percent, then monitor within 4 years. An owner or operator may comply with the requirements of § 60.482-11a(b)(3)(ii) by monitoring at least 40 percent of the connectors within 2 years of the start of the monitoring period, provided all connectors have been monitored by the end of the 4-year monitoring period.
 - C. If the percent leaking connectors in the process unit was less than 0.25 percent, then monitor as provided in paragraph (b)(3)(iii)(A) of § 60.482-11a and either paragraph (b)(3)(iii)(B) or (b)(3)(iii)(C) of § 60.482-11a, as appropriate.

1. An owner or operator shall monitor at least 50 percent of the connectors within 4 years of the start of the monitoring period.
 2. If the percent of leaking connectors calculated from the monitoring results in paragraph (b)(3)(iii)(A) of § 60.482-11a is greater than or equal to 0.35 percent of the monitored connectors, the owner or operator shall monitor as soon as practical, but within the next 6 months, all connectors that have not yet been monitored during the monitoring period. At the conclusion of monitoring, a new monitoring period shall be started pursuant to paragraph (b)(3) of § 60.482-11a, based on the percent of leaking connectors within the total monitored connectors.
 3. If the percent of leaking connectors calculated from the monitoring results in paragraph (b)(3)(iii)(A) of § 60.482-11a is less than 0.35 percent of the monitored connectors, the owner or operator shall monitor all connectors that have not yet been monitored within 8 years of the start of the monitoring period.
- D. If, during the monitoring conducted pursuant to paragraphs (b)(3)(i) through (iii) of § 60.482-11a, a connector is found to be leaking, it shall be re-monitored once within 90 days after repair to confirm that it is not leaking.
- E. The owner or operator shall keep a record of the start date and end date of each monitoring period under § 60.482-11a for each process unit.
- tt. For use in determining the monitoring frequency, as specified in paragraphs (a) and (b)(3) of § 60.482-11a, the percent leaking connectors as used in paragraphs (a) and (b)(3) of § 60.482-11a shall be calculated by using the following equation: [Reg.19.304 and 40 C.F.R. § 60.482-11a(c)]
- $$\%C_L = C_L / C_t * 100$$
- Where:
- $\%C_L$ = Percent of leaking connectors as determined through periodic monitoring required in paragraphs (a) and (b)(3)(i) through (iii) of §60.482-11a.
- C_L = Number of connectors measured at 500 ppm or greater, by the method specified in §60.485a(b).
- C_t = Total number of monitored connectors in the process unit or affected facility.
- uu. When a leak is detected pursuant to paragraphs (a) and (b) of § 60.482-11a, it shall be repaired as soon as practicable, but not later than 15 calendar days after it is detected, except as provided in § 60.482-9a. A first attempt at repair as defined in 40 C.F.R. § 60 Subpart VVa shall be made no later than 5 calendar days after the leak is detected. [Reg.19.304 and 40 C.F.R. § 60.482-11a(d)]

- vv. Except for instrumentation systems and inaccessible, ceramic, or ceramic-lined connectors meeting the provisions of paragraph (f) of § 60.482-11a, identify the connectors subject to the requirements of 40 C.F.R. § 60 Subpart VVa. Connectors need not be individually identified if all connectors in a designated area or length of pipe subject to the provisions of 40 C.F.R. § 60 Subpart VVa are identified as a group, and the number of connectors subject is indicated. [Reg.19.304 and 40 C.F.R. § 60.482-11a(g)] Effective Date Note: At 73 FR 31376, June 2, 2008, § 60.482-11a was stayed until further notice.
- ww. In conducting the performance tests required in § 60.8, the owner or operator shall use as reference methods and procedures the test methods in appendix A of this part or other methods and procedures as specified in §60.485a, except as provided in § 60.8(b). [Reg.19.304 and 40 C.F.R. § 60.485a(a)]
- xx. The owner or operator shall determine compliance with the standards in §§ 60.482-1a through 60.482-11a as follows: [Reg.19.304 and 40 C.F.R. § 60.485a(b)]
- i. Method 21 shall be used to determine the presence of leaking sources. The instrument shall be calibrated before use each day of its use by the procedures specified in Method 21 of appendix A-7 of this part. The following calibration gases shall be used:
 - A. Zero air (less than 10 ppm of hydrocarbon in air); and
 - B. A mixture of methane or n-hexane and air at a concentration no more than 2,000 ppm greater than the leak definition concentration of the equipment monitored. If the monitoring instrument's design allows for multiple calibration scales, then the lower scale shall be calibrated with a calibration gas that is no higher than 2,000 ppm above the concentration specified as a leak, and the highest scale shall be calibrated with a calibration gas that is approximately equal to 10,000 ppm. If only one scale on an instrument will be used during monitoring, the owner or operator need not calibrate the scales that will not be used during that day's monitoring.
 - ii. A calibration drift assessment shall be performed, at a minimum, at the end of each monitoring day. Check the instrument using the same calibration gas(es) that were used to calibrate the instrument before use. Follow the procedures specified in Method 21 of appendix A-7 of this part, Section 10.1, except do not adjust the meter readout to correspond to the calibration gas value. Record the instrument reading for each scale used as specified in §60.486a(e)(7). Calculate the average algebraic difference between the three meter readings and the most recent calibration value. Divide this algebraic difference by the initial calibration value and multiply by 100 to express the calibration drift as a percentage. If any calibration drift assessment shows a negative drift of more than 10 percent from the initial calibration value, then all equipment monitored since the last calibration with instrument readings below the appropriate leak definition and above the leak definition multiplied by (100

minus the percent of negative drift/divided by 100) must be re-monitored. If any calibration drift assessment shows a positive drift of more than 10 percent from the initial calibration value, then, at the owner/operator's discretion, all equipment since the last calibration with instrument readings above the appropriate leak definition and below the leak definition multiplied by (100 plus the percent of positive drift/divided by 100) may be re-monitored.

- yy. The owner or operator shall determine compliance with the no-detectable-emission standards in § 60.482–4a as follows: [Reg.19.304 and 40 C.F.R. § 60.485a(c)]
 - i. The requirements of paragraph (b) of § 60.485a shall apply.
 - ii. Method 21 of appendix A–7 of this part shall be used to determine the background level. All potential leak interfaces shall be traversed as close to the interface as possible. The arithmetic difference between the maximum concentration indicated by the instrument and the background level is compared with 500 ppm for determining compliance.

- zz. The owner or operator shall test each piece of equipment unless he demonstrates that a process unit is not in VOC service, i.e., that the VOC content would never be reasonably expected to exceed 10 percent by weight. For purposes of this demonstration, the following methods and procedures shall be used: [Reg.19.304 and 40 C.F.R. § 60.485a(d)]
 - i. Procedures that conform to the general methods in ASTM E260–73, 91, or 96, E168–67, 77, or 92, E169–63, 77, or 93 (incorporated by reference—see § 60.17) shall be used to determine the percent VOC content in the process fluid that is contained in or contacts a piece of equipment.
 - ii. Organic compounds that are considered by the Administrator to have negligible photochemical reactivity may be excluded from the total quantity of organic compounds in determining the VOC content of the process fluid.
 - iii. Engineering judgment may be used to estimate the VOC content, if a piece of equipment had not been shown previously to be in service. If the Administrator disagrees with the judgment, paragraphs (d)(1) and (2) of § 60.485a shall be used to resolve the disagreement.

- aaa. The owner or operator shall demonstrate that a piece of equipment is in light liquid service by showing that all the following conditions apply: [Reg.19.304 and 40 C.F.R. § 60.485a(e)]
 - i. The vapor pressure of one or more of the organic components is greater than 0.3 kPa at 20 °C (1.2 in. H₂O at 68 °F). Standard reference texts or ASTM D2879–83, 96, or 97 (incorporated by reference—see § 60.17) shall be used to determine the vapor pressures.
 - ii. The total concentration of the pure organic components having a vapor pressure greater than 0.3 kPa at 20 °C (1.2 in. H₂O at 68 °F) is equal to or greater than 20 percent by weight.
 - iii. The fluid is a liquid at operating conditions.

- bbb. Samples used in conjunction with paragraphs (d), (e), and (g) of §60.485a shall be representative of the process fluid that is contained in or contacts the equipment. [Reg.19.304 and 40 C.F.R. § 60.485a(f)]
- ccc. Each owner or operator subject to the provisions of 40 C.F.R. § 60 Subpart VVa shall comply with the recordkeeping requirements of § 60.486a. [Reg.19.304 and 40 C.F.R. § 60.486a(a)(1)]
- ddd. An owner or operator of more than one affected facility subject to the provisions of 40 C.F.R. § 60 Subpart VVa may comply with the recordkeeping requirements for these facilities in one recordkeeping system if the system identifies each record by each facility. [Reg.19.304 and 40 C.F.R. § 60.486a(a)(2)]
- eee. The owner or operator shall record the information specified in paragraphs (a)(3)(i) through (v) of § 60.486a for each monitoring event required by §§ 60.482–2a, 60.482–3a, 60.482–7a, 60.482–8a, and 60.482–11a. [Reg.19.304 and 40 C.F.R. § 60.486a(a)(3)]
 - i. Monitoring instrument identification.
 - ii. Operator identification.
 - iii. Equipment identification.
 - iv. Date of monitoring.
 - v. Instrument reading.
- fff. When each leak is detected as specified in §§ 60.482–2a, 60.482–3a, 60.482–7a, 60.482–8a, and 60.482–11a, the following requirements apply: [Reg.19.304 and 40 C.F.R. § 60.486a(b)]
 - i. A weatherproof and readily visible identification, marked with the equipment identification number, shall be attached to the leaking equipment.
 - ii. The identification on a valve may be removed after it has been monitored for 2 successive months as specified in § 60.482–7a(c) and no leak has been detected during those 2 months.
 - iii. The identification on a connector may be removed after it has been monitored as specified in § 60.482–11a(b)(3)(iv) and no leak has been detected during that monitoring.
 - iv. The identification on equipment, except on a valve or connector, may be removed after it has been repaired.
- ggg. When each leak is detected as specified in §§ 60.482–2a, 60.482–3a, 60.482–7a, 60.482–8a, and 60.482–11a, the following information shall be recorded in a log and shall be kept for 2 years in a readily accessible location: [Reg.19.304 and 40 C.F.R. § 60.486a(c)]
 - i. The instrument and operator identification numbers and the equipment identification number, except when indications of liquids dripping from a pump are designated as a leak.

- ii. The date the leak was detected and the dates of each attempt to repair the leak.
 - iii. Repair methods applied in each attempt to repair the leak.
 - iv. Maximum instrument reading measured by Method 21 of appendix A-7 of this part at the time the leak is successfully repaired or determined to be non-repairable, except when a pump is repaired by eliminating indications of liquids dripping.
 - v. "Repair delayed" and the reason for the delay if a leak is not repaired within 15 calendar days after discovery of the leak.
 - vi. The signature of the owner or operator (or designate) whose decision it was that repair could not be effected without a process shutdown.
 - vii. The expected date of successful repair of the leak if a leak is not repaired within 15 days.
 - viii. Dates of process unit shutdowns that occur while the equipment is unrepaired.
 - ix. The date of successful repair of the leak.
- hhh. The following information pertaining to all equipment subject to the requirements in §§ 60.482-1a to 60.482-11a shall be recorded in a log that is kept in a readily accessible location: [Reg.19.304 and 40 C.F.R. § 60.486a(e)]
- i. A list of identification numbers for equipment subject to the requirements of 40 C.F.R. § 60, Subpart VVa.
 - ii. A list of equipment identification numbers for pressure relief devices required to comply with § 60.482-4a.
 - iii. The dates of each compliance test as required in §§ 60.482-2a(e), 60.482-3a(i), 60.482-4a, and 60.482-7a(f).
 - iv. The background level measured during each compliance test.
 - v. The maximum instrument reading measured at the equipment during each compliance test.
 - vi. A list of identification numbers for equipment in vacuum service.
 - vii. A list of identification numbers for equipment that the owner or operator designates as operating in VOC service less than 300 hr/yr in accordance with § 60.482-1a(e), a description of the conditions under which the equipment is in VOC service, and rationale supporting the designation that it is in VOC service less than 300 hr/yr.
 - viii. The date and results of the weekly visual inspection for indications of liquids dripping from pumps in light liquid service.
 - ix. Records of the information specified in paragraphs (e)(8)(i) through (vi) of § 60.486a for monitoring instrument calibrations conducted according to sections 8.1.2 and 10 of Method 21 of appendix A-7 of this part and § 60.485a(b).
 - A. Date of calibration and initials of operator performing the calibration.
 - B. Calibration gas cylinder identification, certification date, and certified concentration.
 - C. Instrument scale(s) used.

- D. A description of any corrective action taken if the meter readout could not be adjusted to correspond to the calibration gas value in accordance with section 10.1 of Method 21 of appendix A-7 of Part 60.
 - E. Results of each calibration drift assessment required by § 60.485a(b)(2) (i.e., instrument reading for calibration at end of monitoring day and the calculated percent difference from the initial calibration value).
 - F. If an owner or operator makes their own calibration gas, a description of the procedure used.
 - x. The connector monitoring schedule for each process unit as specified in § 60.482-11a(b)(3)(v).
 - xi. Records of each release from a pressure relief device subject to § 60.482-4a.
- iii. Information and data used to demonstrate that a piece of equipment is not in VOC service shall be recorded in a log that is kept in a readily accessible location. [Reg.19.304 and 40 C.F.R. § 60.486a(j)]
- jjj. The provisions of § 60.7(b) and (d) do not apply to affected facilities subject to 40 C.F.R. § 60 Subpart VVa. [Reg.19.304 and 40 C.F.R. § 60.486a(k)]
- kkk. Each owner or operator subject to the provisions of 40 C.F.R. § 60 Subpart VVa shall submit semiannual reports to the Administrator beginning 6 months after the initial startup date. [Reg.19.304 and 40 C.F.R. § 60.487a(a)]
- lll. The initial semiannual report to the Administrator shall include the following information: [Reg.19.304 and 40 C.F.R. § 60.487a(b)]
- i. Process unit identification.
 - ii. Number of valves subject to the requirements of § 60.482-7a, excluding those valves designated for no detectable emissions under the provisions of § 60.482-7a(f).
 - iii. Number of pumps subject to the requirements of § 60.482-2a, excluding those pumps designated for no detectable emissions under the provisions of § 60.482-2a(e) and those pumps complying with § 60.482-2a(f).
 - iv. Number of connectors subject to the requirements of § 60.482-11a.
- mmm. All semiannual reports to the Administrator shall include the following information, summarized from the information in § 60.486a: [Reg.19.304 and 40 C.F.R. § 60.487a(c)]
- i. Process unit identification.
 - ii. For each month during the semiannual reporting period,
 - A. Number of valves for which leaks were detected as described in §§ 60.482-7a(b) or 60.483-2a,
 - B. Number of valves for which leaks were not repaired as required in § 60.482-7a(d)(1),
 - C. Number of pumps for which leaks were detected as described in §§ 60.482-2a(b), (d)(4)(ii)(A) or (B), or (d)(5)(iii),

- D. Number of pumps for which leaks were not repaired as required in §§ 60.482–2a(c)(1) and (d)(6),
 - E. Number of connectors for which leaks were detected as described in § 60.482–11a(b)
 - F. Number of connectors for which leaks were not repaired as required in § 60.482–11a(d), and
 - G. The facts that explain each delay of repair and, where appropriate, why a process unit shutdown was technically infeasible.
- iii. Dates of process unit shutdowns which occurred within the semiannual reporting period.
 - iv. Revisions to items reported according to paragraph (b) of § 60.487a if changes have occurred since the initial report or subsequent revisions to the initial report.
- nnn. An owner or operator shall report the results of all performance tests in accordance with § 60.8 of the General Provisions. The provisions of § 60.8(d) do not apply to affected facilities subject to the provisions of 40 C.F.R. § 60 Subpart VVa except that an owner or operator must notify the Administrator of the schedule for the initial performance tests at least 30 days before the initial performance tests. [Reg.19.304 and 40 C.F.R. § 60.487a(e)]
110. The permittee shall not load more than one tanker per hour at SN-40. Supporting documentation shall be maintained on site to demonstrate compliance with this specific condition. [Reg.19.705 and Ark. Code Ann. § 8-4-203 as referenced by Ark. Code Ann. §§ 8-4-304 and 8-4-311]
111. Within 180 days of issuance of Permit 1009-AOP-R11, the facility shall begin testing for total dissolved solids (TDS) in each of the Cooling Towers (SN-35 and SN-36). The TDS shall not exceed 13,600 parts per million (ppm) on any sample result taken when any of the cooling towers are operating. The permittee shall develop a conductivity vs. TDS curve and test for conductivity on a weekly basis when any of the cooling towers are operating. The conductivity result shall not exceed the level that correlates with 13,600 ppm for any sample result taken when any of the cooling towers are operating. The permittee shall also determine, directly, TDS once every three months. The results shall be kept on site and made available to Department personnel upon request. [Reg.19.705 and Reg.19.703, Reg.18.1004 and Reg.18.1003, and Ark. Code Ann. § 8-4-203 as referenced by Ark. Code Ann. §§ 8-4-304 and 8-4-311]

**SN-32
 Lamp Recycling System**

Source Description

The lamp recycling system (SN-32) processes fluorescent lamps. The bulbs are crushed and separated into glass, end caps, and phosphor powder. Emissions from the bulb crusher are exhausted into a baghouse for particulate removal followed by a carbon adsorber for mercury removal.

Specific Conditions

112. The permittee shall not exceed the emission rates set forth in the following table. [Reg.19.501 *et seq.* and 40 C.F.R. § 52 Subpart E]

Pollutant	lb/hr	tpy
PM ₁₀	0.1	0.1

113. The permittee shall not exceed the emission rates set forth in the following table. [Reg.18.801 and Ark. Code Ann. § 8-4-203 as referenced by Ark. Code Ann. §§ 8-4-304 and 8-4-311]

Pollutant	lb/hr	tpy
PM	0.1	0.1
Mercury	0.000013	0.000057

114. Visible emissions may not exceed the limits specified in the following table of this permit as measured by EPA Reference Method 9. [Ark. Code Ann. § 8-4-203 as referenced by Ark. Code Ann. §§ 8-4-304 and 8-4-311]

SN	Limit	Regulatory Citation
SN-32	5%	Reg.18.501 and Ark. Code Ann.

115. The permittee shall conduct weekly observations of the opacity from sources SN-32 and keep a record of these observations. If the permittee detects visible emissions, the permittee must immediately take action to identify and correct the cause of the visible emissions. After implementing the corrective action, the permittee must document that the source complies with the visible emissions requirements. The permittee shall maintain records of all observations, the cause of any visible emissions, and the corrective action taken. The permittee must keep these records onsite and make them available to Department personnel upon request. [Reg.18.1004 and Ark. Code Ann. § 8-4-203 as referenced by Ark. Code Ann. §§ 8-4-304 and 8-4-311]

Clean Harbors El Dorado, LLC

Permit #: 1009-AOP-R16

AFIN: 70-00098

116. The permittee shall keep records of the operating plan for the use of carbon canisters and the maintenance performed on the canisters at SN-32. This plan is attached as Appendix R. [Reg.18.1004 and Ark. Code Ann. § 8-4-203 as referenced by Ark. Code Ann. §§ 8-4-304 and 8-4-311]
117. The permittee shall not process more than 38,435 pounds of bulbs per day at SN-32. [Reg.19.705, Ark. Code Ann. § 8-4-203 as referenced by Ark. Code Ann. §§ 8-4-304 and 8-4-311, and 40 C.F.R. § 70.6]
118. The permittee shall maintain daily records which demonstrate compliance with Specific Condition #117. These records shall be updated daily. The records shall be kept onsite and made available to Department personnel upon request. [Reg.19.705 and 40 C.F.R. § 52 Subpart E]

SN-33
Non-Hazardous Waste Shredder

Source Description

The shredder is used to reduce the volume of non-hazardous debris and other solid wastes. The overall shredder process includes fugitive PM emissions from shredding debris/waste, unloading waste to mixing tank, addition of absorbent, mixing, and transfer from tank to rolloff.

Specific Conditions

119. The permittee shall not exceed the emission rates set forth in the following table. The permittee shall demonstrate compliance with this condition by compliance with Specific Conditions #121, #123, and #126. [Reg.19.501 *et seq.* and 40 C.F.R. § 52 Subpart E]

Pollutant	lb/hr	tpy
PM ₁₀	0.2	0.5

120. The permittee shall not exceed the emission rates set forth in the following table. The permittee shall demonstrate compliance with this condition by compliance with Specific Conditions #121, #123, and #125. [Reg.18.801 and Ark. Code Ann. § 8-4-203 as referenced by Ark. Code Ann. §§ 8-4-304 and 8-4-311]

Pollutant	lb/hr	tpy
PM	0.2	0.5

121. Visible emissions may not exceed the limits specified in the following table of this permit as measured by EPA Reference Method 9. [Ark. Code Ann. § 8-4-203 as referenced by Ark. Code Ann. §§ 8-4-304 and 8-4-311]

SN	Limit	Regulatory Citation
33	5%	Reg.18.501

122. The permittee shall conduct weekly observations of the opacity from source SN-33 and keep a record of these observations. If the permittee detects visible emissions, the permittee must immediately take action to identify and correct the cause of the visible emissions. After implementing the corrective action, the permittee must document that the source complies with the visible emissions requirements. The permittee shall maintain records of all observations, the cause of any visible emissions, and the corrective action taken. The permittee must keep these records onsite and make them available to Department personnel upon request. [Reg.18.1004 and Ark. Code Ann. § 8-4-203 as referenced by Ark. Code Ann. §§ 8-4-304 and 8-4-311]

Clean Harbors El Dorado, LLC

Permit #: 1009-AOP-R16

AFIN: 70-00098

123. The permittee shall not process more than 75,200 tons of debris and waste combined per consecutive 12 month period at SN-33. [Reg.19.705, Ark. Code Ann. § 8-4-203 as referenced by Ark. Code Ann. §§ 8-4-304 and 8-4-311, and 40 C.F.R. § 70.6]
124. The permittee shall maintain monthly records which demonstrate compliance with Specific Condition #123. These records shall be updated by the fifteenth day of the month following the month to which the records pertain. A twelve month rolling total and each individual month's data shall be maintained on site, made available to Department personnel upon request, and submitted in accordance with General Provision #7. [Reg.19.705 and 40 C.F.R. § 52 Subpart E]
125. The permittee shall not process any hazardous materials at SN-33. The permittee shall maintain appropriate documentation onsite to demonstrate compliance with this specific condition. This documentation shall be made available to Department personnel upon request. [Reg.18.1004 and Ark. Code Ann. § 8-4-203 as referenced by Ark. Code Ann. §§ 8-4-304 and 8-4-311]
126. The permittee shall not process any VOC-containing materials at SN-33. The permittee shall maintain appropriate documentation onsite to demonstrate compliance with this specific condition. This documentation shall be made available to Department personnel upon request. [Reg.19.705, Ark. Code Ann. § 8-4-203 as referenced by Ark. Code Ann. §§ 8-4-304 and 8-4-311, and 40 C.F.R. § 70.6]

SN-34
No. 1 Package Boiler

Source Description

Clean Harbors currently operates one natural gas fired boiler to produce steam which is used to create a venturi jet downstream of the Fixed Incinerator Unit scrubber. This boiler has a heat input capacity of 33.75 MMBTU/hr.

Specific Conditions

127. The permittee shall not exceed the emission rates set forth in the following table. The permittee shall demonstrate compliance with this condition by compliance with Specific Condition #130. [Reg.19.501 *et seq.* and 40 C.F.R. § 52 Subpart E]

Pollutant	lb/hr	tpy
PM ₁₀	0.3	1.2
SO ₂	0.1	0.1
VOC	0.2	0.9
CO	2.8	12.2
NO _x	3.4	14.5
Lead Compounds	0.01	0.01

128. The permittee shall not exceed the emission rates set forth in the following table. The permittee shall demonstrate compliance with this condition by compliance with Specific Condition #130. [Reg.18.801 and Ark. Code Ann. § 8-4-203 as referenced by Ark. Code Ann. §§ 8-4-304 and 8-4-311]

Pollutant	lb/hr	tpy
PM	0.3	1.2
Arsenic Compounds	0.01	0.01
Beryllium Compounds	0.0001	0.01
Cadmium Compounds	0.001	0.01
Fluorene	0.01	0.01
Cobalt Compounds	0.01	0.01
Manganese Compounds	0.01	0.01
Mercury Compounds	0.01	0.01
Nickel Compounds	0.01	0.01
Phenanthrene	0.01	0.01
Selenium Compounds	0.01	0.01
Single Organic HAP	0.06	0.27
Total Organic HAP	0.07	0.28

Clean Harbors El Dorado, LLC
Permit #: 1009-AOP-R16
AFIN: 70-00098

129. The permittee shall only use natural gas as fuel for SN-34. [Reg.19.705, Ark. Code Ann. § 8-4-203 as referenced by Ark. Code Ann. §§ 8-4-304 and 8-4-311, and 40 C.F.R. § 70.6]

40 C.F.R. § 60, Subpart Dc Conditions for SN-34

130. SN-34 is subject to 40 C.F.R. § 60 Subpart Dc – Standards of Performance for Small Industrial, Commercial, Institutional Steam Generating Units. The permittee shall comply with all applicable requirements under 40 C.F.R. § 60 Subpart Dc. These requirements include, but are not limited to, the following: [Reg.19.304 and 40 C.F.R. § 60 Subpart Dc]

- a. As an alternative to meeting the requirements of paragraph (g)(1) of § 60.48c(g), the owner or operator of an affected facility that combusts only natural gas, wood, fuels using fuel certification in § 60.48c(f) to demonstrate compliance with the SO₂ standard, fuels not subject to an emissions standard (excluding opacity), or a mixture of these fuels may elect to record and maintain records of the amount of each fuel combusted during each calendar month. [Reg.19.304 and 40 C.F.R. § 60.48c(g)(2)]
- b. All records required under § 60.48c shall be maintained by the owner or operator of the affected facility for a period of two years following the date of such record. [Reg.19.304 and 40 C.F.R. § 60.48c(i)]
- c. The reporting period for the reports required under 40 C.F.R. § 60 Subpart Dc is each six-month period. All reports shall be submitted to the Administrator and shall be postmarked by the 30th day following the end of the reporting period. [Reg.19.304 and 40 C.F.R. § 60.48c(j)]

40 C.F.R. § 63, Subpart DDDDD Conditions for SN-34

131. The permittee is subject to and shall comply with all applicable requirements of 40 C.F.R. § 63 Subpart DDDDD – *National Emission Standards for Hazardous Air Pollutants for Major Sources: Industrial, Commercial, and Institutional Boilers and Process Heaters*, which establishes national emission limitations and work practice standards for Hazardous Air Pollutants (HAP) emitted from industrial, commercial, and institutional boilers and process heaters located at major sources of HAP. 40 C.F.R. § 63 Subpart DDDDD also establishes requirements to demonstrate initial and continuous compliance with the emission limitations and work practice standards. The existing 33.75 MMBtu/hr No. 1 Package Boiler (SN-34) is subject to 40 C.F.R. § 63 Subpart DDDDD § 63.7485 and must comply with the applicable requirements of this regulation no later than January 31, 2016, except as provided in § 63.6(i). [Reg.19.304 and 40 C.F.R. §§19.304, 63.7480, and 63.7495(b)]

132. As specified in § 63.9(b)(2), if your affected source was started-up before January 31, 2013, an Initial Notification must be submitted no later than 120 days after January 31, 2013. [Reg.19.304 and 40 C.F.R. § 63.7545(b)]
133. Boilers and process heaters in the units designed to burn gas 1 fuels subcategory are not subject to the emission limits in Tables 1 and 2 or 11 through 13 to 40 C.F.R. § 63 Subpart DDDDD, or the operating limits in Table 4 to 40 C.F.R. § 63 Subpart DDDDD. If the boiler or process heater has a heat input capacity of 10 million Btu per hour or greater, the permittee must conduct an annual tune-up of the boiler or process heater to demonstrate continuous compliance as specified in § 63.7540(a)(10)(i) through(vi). [Reg.19.304 and 40 C.F.R. §§ 19.304, 63.7500(e), and 63.7540(a)(10)(i) through (vi)]
- a. As applicable, inspect the burner, and clean or replace any components of the burner as necessary (the permittee may delay the burner inspection until the next scheduled unit shutdown). Units that produce electricity for sale may delay the burner inspection until the first outage, not to exceed 36 months from the previous inspection. At units where entry into a piece of process equipment or into a storage vessel is required to complete the tune-up inspections, inspections are required only during planned entries into the storage vessel or process equipment; [§ 63.7540(a)(10)(i)]
 - b. Inspect the flame pattern, as applicable, and adjust the burner as necessary to optimize the flame pattern. The adjustment should be consistent with the manufacturer's specifications, if available; [§ 63.7540(a)(10)(ii)]
 - c. Inspect the system controlling the air-to-fuel ratio, as applicable, and ensure that it is correctly calibrated and functioning properly (the permittee may delay the inspection until the next scheduled shutdown). Units that produce electricity for sale may delay the inspection until the first outage, not to exceed 36 months from the previous inspection; [§ 63.7540(a)(10)(iii)]
 - d. Optimize total emissions of CO. This optimization should be consistent with the manufacturer's specifications, if available, and with any NO_x requirement to which the unit is subject; [§ 63.740(a)(10)(iv)]
 - e. Measure the concentrations in the effluent stream of CO in parts per million, by volume, and oxygen in volume percent, before and after the adjustments are made (measurements may be either on a dry or wet basis, as long as it is the same basis before and after the adjustments are made). Measurements may be taken using a portable CO analyzer; and [§ 63.7540(a)(10)(v)]
 - f. Maintain on-site and submit an annual report containing the information in § 63.7540(a)(10)(vi)(A) through (C), in accordance with General Provision #7.
 - i. The concentrations of CO in the effluent stream in parts per million by volume, and oxygen in volume percent, measured at high fire or typical operating load, before and after the tune-up of the boiler or process heater; [§ 63.7540(a)(10)(vi)(A)]
 - ii. A description of any corrective actions taken as a part of the tune-up; and [§ 63.7540(a)(10)(vi)(B)]

- iii. The type and amount of fuel used over the 12 months prior to the tune-up, but only if the unit was physically and legally capable of using more than one type of fuel during that period. Units sharing a fuel meter may estimate the fuel used by each unit. [§ 63.7540(a)(10)(vi)(C)]

134. An existing affected source (as defined in § 63.7490) must complete the one-time energy assessment specified in Table 3 item #4 to 40 C.F.R. § 63 Subpart DDDDD no later than the compliance date, January 31, 2016, as follows. [Reg.19.304 and 40 C.F.R. §§ 63.7510(e) and (j), Table 3 item #4 to Subpart DDDDD of § 63]

Table 3 to Subpart DDDDD of Part 63 – Work Practice Standards	
If your unit is . . .	You must meet the following . . .
4. An existing boiler or process heater located at a major source facility, not including limited use units	Must have a one-time energy assessment performed by a qualified energy assessor. An energy assessment completed on or after January 1, 2008, that meets or is amended to meet the energy assessment requirements in this table, satisfies the energy assessment requirement. A facility that operates under an energy management program compatible with ISO 50001 that includes the affected units also satisfies the energy assessment requirement. The energy assessment must include the following with extent of the evaluation for items a. to e. appropriate for the on-site technical hours listed in § 63.7575:
	a. A visual inspection of the boiler or process heater system.
	b. An evaluation of operating characteristics of the boiler or process heater systems, specifications of energy using systems, operating and maintenance procedures, and unusual operating constraints.
	c. An inventory of major energy use systems consuming energy from affected boilers and process heaters and which are under the control of the boiler/process heater owner/operator.
	d. A review of available architectural and engineering plans, facility operation and maintenance procedures and logs, and fuel usage.
	e. A review of the facility's energy management practices and provide recommendations for improvements consistent with the definition of energy management practices, if identified.
	f. A list of cost-effective energy conservation measures that are within the facility's control.
	g. A list of the energy savings potential of the energy conservation measures identified.
	h. A comprehensive report detailing the ways to improve efficiency, the cost of specific improvements, benefits, and the time frame for

Table 3 to Subpart DDDDD of Part 63 – Work Practice Standards	
If your unit is . . .	You must meet the following . . .
	recouping those investments.

135. The permittee must keep records according to § 63.7555(a)(1) and (2) as follows:
 [Reg.19.304 and 40 C.F.R. §§ 63.7555(a)(1) and (2)]
- a. A copy of each notification and report that the permittee submitted to comply with 40 C.F.R. § 63 Subpart DDDDD, including all documentation supporting any Initial Notification or Notification of Compliance Status or semiannual compliance report that the permittee submitted, according to the requirements in § 63.10(b)(2)(xiv). [§ 63.7555(a)(1)]
 - b. Records of performance tests, fuel analyses, or other compliance demonstrations and performance evaluations as required in § 63.10(b)(2)(viii). [§ 63.7555(a)(2)]
136. Records must be in a form suitable and readily available for expeditious review, according to § 63.10(b)(1). Each record must be kept for 5 years following the date of each occurrence, measurement, maintenance, corrective action, report, or record. Each record must be kept on site, or be accessible from on site (for example, through a computer network), for at least 2 years after the date of each occurrence, measurement, maintenance, corrective action, report, or record, according to § 63.10(b)(1). The permittee may keep the records off site for the remaining 3 years. [Reg.19.304 and 40 C.F.R. § 63.7560]

SN-42 and SN-43

Incinerator Cooling Towers

Source Description

The facility operates two cooling towers with two cells each. Cooling Tower SN-42 is for Incinerator SN-01 and cooling tower SN-43 is for Incinerator SN-44. The water flow rate for SN-42 is 6,200 gallons per minute and for SN-43 is 6,500 gallons per minute.

Specific Conditions

137. The permittee shall not exceed the emission rates set forth in the following table. Emissions from these sources have been calculated based on the maximum capacity of each unit. The permittee shall demonstrate compliance with this condition by compliance with Specific Condition #140. [Reg.19.501 *et seq.* and 40 C.F.R. § 52 Subpart E]

SN	Description	Pollutant	lb/hr	tpy
42	Cooling Tower for SN-01	PM ₁₀	0.6	2.3
43	Cooling Tower for SN-44	PM ₁₀	0.1	0.2

138. The permittee shall not exceed the emission rates set forth in the following table. Emissions from these sources have been calculated based on the maximum capacity of each unit. The permittee shall demonstrate compliance with this condition by compliance with Specific Condition #140. [Reg.18.801 and Ark. Code Ann. § 8-4-203 as referenced by §§ 8-4-304 and 8-4-311]

SN	Description	Pollutant	lb/hr	tpy
42	Cooling Tower for SN-01	PM	3.4	14.8
43	Cooling Tower for SN-44	PM	0.3	1.2

139. The permittee shall not exceed 20% opacity from the Cooling Towers (SN-42 and SN-43) as measured by EPA Reference Method 9. Compliance with the opacity limits is demonstrated by compliance with Specific Condition #140. [Reg.18.501 and Ark. Code Ann. § 8-4-203 as referenced by Ark. Code Ann. §§ 8-4-304 and 8-4-311]

Clean Harbors El Dorado, LLC

Permit #: 1009-AOP-R16

AFIN: 70-00098

140. Within 180 days of issuance of Permit 1009-AOP-R11, the facility shall begin testing for total dissolved solids (TDS) in each of the Cooling Towers (SN-42 and SN-43). The TDS shall not exceed 13,600 parts per million (ppm) on any sample result taken when any of the cooling towers are operating. The permittee shall develop a conductivity vs. TDS curve and test for conductivity on a weekly basis when any of the cooling towers are operating. The conductivity result shall not exceed the level that correlates with 13,600 ppm for any sample result taken when any of the cooling towers are operating. The permittee shall also determine, directly, TDS once every three months. The results shall be kept on site and made available to Department personnel upon request. [Reg.19.705 and Reg.19.703, Reg.18.1004 and Reg.18.1003, and Ark. Code Ann. § 8-4-203 as referenced by Ark. Code Ann. §§ 8-4-304 and 8-4-311]

SN-44
Fixed Incinerator Unit 44

Source Description

The Fixed Incinerator Unit 44 is comprised of a rotary kiln, a Secondary Combustion Chamber (SCC), a gas conditioning system, and an air pollution control train.

Wastes are fed to one of two primary feed locations: the rotary kiln or the SCC. Combustion gases from the SCC are routed through a spray dryer for gas conditioning. The gas stream then passes into baghouse #1, a saturator, two parallel condenser towers, a demister, baghouse #2, and the de-NO_x unit.

All of these combustion units have a combined capacity of 61,025 pounds/hour of waste feed. The sulfur feed rate will be limited to 2045 lb/hr and 1590 tons/year.

Specific Conditions

141. The permittee shall not exceed the emission rates set forth in the following table. The permittee shall demonstrate compliance with this condition by Specific Conditions #143, #147, #149, #151, and #154, Plantwide Condition #191, and equipment limitations. [Reg.19.501 *et seq.* and 40 C.F.R. § 52 Subpart E]

Pollutant	lb/hr	tpy
PM ₁₀	0.6	2.5
SO ₂	45.0	35.0
VOC	1.9	8.1
CO	18.3	80.2
NO _x	56.2 ^b	38.0
Lead Compounds	0.0016 ^a	0.007 ^a

a. Combined limits for lead and cadmium.

b. 12-hour averaging period for NO_x lb/hr. See Specific Condition #153.

142. The permittee shall not exceed the emission rates set forth in the following table. The permittee shall demonstrate compliance with this condition by Specific Conditions #143, #146, #151, and #152, Plantwide Condition #191, and equipment limitations. [Reg.18.801 and Ark. Code Ann. § 8-4-203 as referenced by Ark. Code Ann. §§ 8-4-304 and 8-4-311]

Clean Harbors El Dorado, LLC
 Permit #: 1009-AOP-R16
 AFIN: 70-00098

Pollutant	lb/hr	tpy
PM	0.6	2.5
Antimony Compounds	0.57	2.48
Arsenic Compounds	0.0036 ^b	0.016 ^b
Beryllium Compounds	0.0036 ^{b, c}	0.016 ^b
Cadmium Compounds	0.0016 ^a	0.007 ^a
Calcium cyanimide	1.84	8.02
Chlorine	4.79 ^d	20.97 ^d
Chromium Compounds	0.0036 ^b	0.016 ^b
Cobalt Compounds	0.57	2.48
Cyanide Compounds	1.84	8.02
Dioxins/Furans	1.70E-8	7.45E-8
Hydrazine	1.02	4.48
Hydrochloric acid	4.93 ^d	21.59 ^d
Hydrogen fluoride	0.60	2.70
Manganese Compounds	0.57	2.48
Mercury Compounds	0.002 ^e	0.009
Methyl chloroform	1.84	8.02
Methylene chloride	1.84	8.02
Nickel Compounds	0.57	2.48
Phosphine	1.84	8.02
Phosphorus	1.84	8.02
Selenium Compounds	0.57	2.48
Tetrachloroethylene	1.84	8.02
Titanium Tetrachloride	1.84	8.02
Single Organic HAP	1.84	8.02
Total Organic HAP	1.84	8.02

Pollutant	lb/hr	tpy
Ammonia	2.3	9.8

- a. Combined limits for lead and cadmium.
- b. Combined limits for arsenic, beryllium, and chromium.
- c. Beryllium emissions are also limited by 40 C.F.R. § 61 Subpart C.
- d. Combined limit for chlorine and hydrogen chloride of 32 ppm, expressed as chloride equivalent.
- e. Mercury emissions are also limited by 40 C.F.R. § 61 Subpart E.

143. Visible emissions may not exceed the limits specified in the following table of this permit as measured by EPA Reference Method 9. [Ark. Code Ann. § 8-4-203 as referenced by Ark. Code Ann. §§ 8-4-304 and 8-4-311]

SN	Limit	Regulatory Citation
44	20%	Reg.19.503 and 40 C.F.R. § 52 Subpart E

144. The permittee shall maintain a Continuous Opacity Monitoring System (COMS) or a Continuous Parameter Monitoring System (CPMS) to demonstrate compliance with Specific Condition #143. The monitoring system shall comply with the Air Division’s “Continuous Emission Monitoring Systems Conditions.” The facility will develop a correlation curve with the COMS and CPMS outputs within 60 days of issuance of the permit and use the curve to predict opacity when using the CPMS to demonstrate compliance with Specific Condition #143 [Reg.19.705 and 40 C.F.R. § 52 Subpart E]
145. The permittee shall install and maintain Continuous Emission Monitoring Systems (CEMS) to demonstrate compliance with the hourly and annual NO_x emission limits in Specific Condition #141. These CEMS shall comply with the Air Division’s “Continuous Emission Monitoring Systems Conditions.” These CEMS shall be installed and operating at start-up of SN-44. [Reg.19.705 and 40 C.F.R. § 52 Subpart E]
146. The permittee shall maintain a destruction and removal efficiency of 99.997% for organic HAPs (excluding dioxins and furans). Compliance with this condition shall be demonstrated during the comprehensive performance test as required by 40 C.F.R. § 63 Subpart EEE. [Reg.19.705 of Regulation #19; Ark. Code Ann. § 8-4-203 as referenced by Ark. Code Ann. §§ 8-4-304 and 8-4-311; and 40 C.F.R. § 70.6]
147. The facility shall limit the sulfur feed rate to 2045 lb/hr and 1590 tons/yr at SN-44. [Reg.19.501 *et seq.* and 40 C.F.R. § 52 Subpart E]
148. The permittee shall maintain monthly records to demonstrate compliance with Specific Condition #147. The permittee shall update these records by the fifteenth day of the month following the month to which the records pertain. These records shall be

- maintained on-site, made available to Department personnel upon request and submitted in accordance with General Provision #7. [Reg.19.705 and 40 C.F.R. § 52 Subpart E]
149. The control efficiency of the scrubber shall be maintained at a minimum of 98.9% for SO₂ removal. [Reg.19.705, Ark. Code Ann. § 8-4-203 as referenced by Ark. Code Ann. §§ 8-4-304 and 8-4-311, and 40 C.F.R. § 70.6]
 150. The permittee shall conduct testing to determine the control efficiency of the scrubber for SO₂ at SN-44. This testing shall be conducted in accordance with EPA Reference Method 6C and Plantwide Condition #3. The initial test shall be conducted during the next comprehensive performance test (CPT) which will be conducted as required by 40 C.F.R. § 63 Subpart EEE. This testing shall be performed a minimum of once every 5 years. The result of this testing shall maintained on-site, made available to Department personnel upon request and submitted in accordance with General Provision #7. [Reg.19.702 and 40 C.F.R. § 52 Subpart E]
 151. The permittee shall conduct all particulate testing with the inclusion of EPA Method 202. The initial testing shall be performed at the same time as the CPT required by 40 C.F.R. § 63 Subpart EEE. This testing shall be performed a minimum of once every five years. EPA Method 202 is not to be utilized as part of the demonstration of compliance with 40 C.F.R. § 63 Subpart EEE particulate limits. A copy of these test results shall be submitted in accordance with General Provision #7. [Reg.19.702 and 40 C.F.R. § 52 Subpart E]
 152. The permittee shall test SN-44 for cyanide compounds, hydrazine, hydrogen fluoride, phosphine, and titanium tetrachloride while operating at 90% or greater capacity. Emission results shall be extrapolated to correlate with 100% of the permitted capacity to determine compliance. These tests shall be performed using test methods as approved by ADEQ, and shall be conducted in accordance with Plantwide Condition #3. This testing shall be conducted during the next CPT which will be conducted as required by 40 C.F.R. § 63 Subpart EEE. [Reg.18.1002 and Ark. Code Ann. § 8-4-203 as referenced by Ark. Code Ann. §§ 8-4-304 and 8-4-311]
 153. The permittee may not exceed average emissions of 56.2 lb/hr at SN-44 over a rolling 12-hour averaging period. Compliance with the lb/hr limit for NO_x will be demonstrated by comparison of the limit to the 12-hour rolling average NO_x reading obtained from the CEMs installed pursuant to with Specific Condition #145. To show compliance with the lb/hr limit such comparisons will be made for each hour that the source is in operation. These records shall be kept on site and shall be provided to Department personnel upon request. Records shall be submitted in accordance with General Provision #7. [Reg.19.501 and Ark. Code Ann. § 8-4-203 as referenced by Ark. Code Ann. §§ 8-4-304 and 8-4-311]

Clean Harbors El Dorado, LLC

Permit #: 1009-AOP-R16

AFIN: 70-00098

154. The permittee must operate the De-NO_x control process at all times while SN-44 is in operation. [Reg.19.705 and Ark. Code Ann. § 8-4-203 as referenced by Ark. Code Ann. §§ 8-4-304 and 8-4-311]

155. The permittee must submit a modification to this permit within 12 months of SN-44 initial startup that evaluates hourly NO_x emission rates. This modification will contain at least 6 months of hourly data from SN-44 to evaluate the potential for lower permitted hourly NO_x emissions of the unit. An application was received on October 5, 2017. [Reg.19.705 and Ark. Code Ann. § 8-4-203 as referenced by Ark. Code Ann. §§ 8-4-304 and 8-4-311]

**SN-45
Fuel Storage Tank**

This tank will be used to store fuel for SN-44 start up. Exhaust from the tank is controlled by routing to the SCC (Secondary combustion chamber). When the SCC is down, the exhaust is routed to a carbon tank system for emission control. Control efficiency for the SCC is 99.99% and carbon is 99%. In order to estimate worst case emissions, the scenario with carbon control is used in the emission calculations. Emissions were estimated utilizing TANKS 4.0.9d software.

Specific Conditions

156. The permittee shall not exceed the emission rates set forth in the following table. The permittee shall demonstrate compliance with this condition by compliance with Specific Condition #158. [Reg.19.501 *et seq.* and 40 C.F.R. § 52 Subpart E]

Pollutant	lb/hr	tpy
VOC	0.1	0.1

157. The permittee shall not exceed the emission rates set forth in the following table. The permittee shall demonstrate compliance with this condition by compliance with Specific Condition #158. [Reg.18.801 and Ark. Code Ann. § 8-4-203 as referenced by Ark. Code Ann. §§ 8-4-304 and 8-4-311]

Pollutant	lb/hr	tpy
Single Organic HAP	0.01	0.01
Total Organic HAP	0.01	0.01

158. The permittee shall not exceed a throughput of 399,360 gallons of diesel fuel at SN-45 per rolling 12 month period.
159. The permittee shall maintain monthly records to demonstrate compliance with Specific Condition #158. The permittee shall update these records by the fifteenth day of the month following the month to which the records pertain. The twelve month rolling totals and each individual month's data shall be maintained on-site, made available to Department personnel upon request, and submitted in accordance with General Provision #7.

**SN-46
 Gondola Transferring Operations**

The emissions associated with solidification and the gondola transferring operation are controlled with a baghouse. The facility plans to add hydrated lime to absorb excess moisture from the wet ash. The hydrated lime is dusty and becomes an airborne particulate which will be controlled by a baghouse. Particulate emissions are estimated based on blower capacity and ADEQ grain loading factor.

160. The permittee shall not exceed the emission rates set forth in the following table. The permittee shall demonstrate compliance with this condition by compliance with equipment limitations. [Reg.19.501 *et seq.* and 40 C.F.R. § 52 Subpart E]

Source	Pollutant	lb/hr	tpy
SN-46	PM ₁₀	1.5	6.2

161. The permittee shall not exceed the emission rates set forth in the following table. The permittee shall demonstrate compliance with this condition by compliance with equipment limitations. [Reg.18.801 and Ark. Code Ann. § 8-4-203 as referenced by Ark. Code Ann. §§ 8-4-304 and 8-4-311]

Source	Pollutant	lb/hr	tpy
SN-46	PM	2.6	11.3

162. Visible emissions may not exceed the limits specified in the following table of this permit as measured by EPA Reference Method 9.

SN	Limit	Regulatory Citation
46	5%	Reg.18.501

163. The permittee shall conduct weekly observations of the opacity from source SN-46 and keep a record of these observations. If the permittee detects visible emissions that exceed the limit, the permittee must immediately take action to identify and correct the cause of the visible emissions. After implementing the corrective action, the permittee must document that the source complies with the visible emissions requirements. The permittee shall maintain records of the cause of any visible emissions and the corrective action taken. The permittee must keep these records onsite and make them available to Department personnel upon request. [Reg.18.1004 and Ark. Code Ann. § 8-4-203 as referenced by Ark. Code Ann. §§ 8-4-304 and 8-4-311]

Clean Harbors El Dorado, LLC
Permit #: 1009-AOP-R16
AFIN: 70-00098

SECTION V: COMPLIANCE PLAN AND SCHEDULE

Clean Harbors El Dorado, LLC will continue to operate in compliance with those identified regulatory provisions. The facility will examine and analyze future regulations that may apply and determine their applicability with any necessary action taken on a timely basis.

SECTION VI: PLANTWIDE CONDITIONS

1. The permittee shall notify the Director in writing within thirty (30) days after commencing construction, completing construction, first placing the equipment and/or facility in operation, and reaching the equipment and/or facility target production rate. [Reg.19.704, 40 C.F.R. § 52 Subpart E, and Ark. Code Ann. § 8-4-203 as referenced by Ark. Code Ann. §§ 8-4-304 and 8-4-311]
2. If the permittee fails to start construction within eighteen months or suspends construction for eighteen months or more, the Director may cancel all or part of this permit. [Reg.19.410(B) and 40 C.F.R. § 52 Subpart E]
3. The permittee must test any equipment scheduled for testing, unless otherwise stated in the Specific Conditions of this permit or by any federally regulated requirements, within the following time frames: (1) new equipment or newly modified equipment within sixty (60) days of achieving the maximum production rate, but no later than 180 days after initial start up of the permitted source or (2) operating equipment according to the time frames set forth by the Department or within 180 days of permit issuance if no date is specified. The permittee must notify the Department of the scheduled date of compliance testing at least fifteen (15) business days in advance of such test. The permittee shall submit the compliance test results to the Department within sixty (60) calendar days after completing the testing. [Reg.19.702 and/or Reg.18.1002 and Ark. Code Ann. § 8-4-203 as referenced by Ark. Code Ann. §§ 8-4-304 and 8-4-311]
4. The permittee must provide:
 - a. Sampling ports adequate for applicable test methods;
 - b. Safe sampling platforms;
 - c. Safe access to sampling platforms; and
 - d. Utilities for sampling and testing equipment.

[Reg.19.702 and/or Reg.18.1002 and Ark. Code Ann. § 8-4-203 as referenced by Ark. Code Ann. §§ 8-4-304 and 8-4-311]
5. The permittee must operate the equipment, control apparatus and emission monitoring equipment within the design limitations. The permittee shall maintain the equipment in good condition at all times. [Reg.19.303 and Ark. Code Ann. § 8-4-203 as referenced by Ark. Code Ann. §§ 8-4-304 and 8-4-311]
6. This permit subsumes and incorporates all previously issued air permits for this facility. [Reg. 26 and Ark. Code Ann. § 8-4-203 as referenced by Ark. Code Ann. §§ 8-4-304 and 8-4-311]
7. The permittee must prepare and implement a Startup, Shutdown, and Malfunction Plan (SSM). If the Department requests a review of the SSM, the permittee will make the

SSM available for review. The permittee must keep a copy of the SSM at the source's location and retain all previous versions of the SSM plan for five years. [Reg.19.304 and 40 C.F.R. § 63.6(e)(3)]

Divert Stack Events

8. Opening of any of the divert stack(s) while uncombusted waste material is contained in the kiln(s) shall constitute an operational divert stack event. [Reg.19.705, Ark. Code Ann. § 8-4-203 as referenced by Ark. Code Ann. §§ 8-4-304 and 8-4-311, and 40 C.F.R. § 52 Subpart E]
9. No divert stack shall be opened during an operational divert stack event without first stopping the waste feed and halting the SN-01 kiln(s) rotation. Rotation of the SN-44 kiln shall be allowed during divert stack events. No waste feed shall be introduced into the kiln(s) without first closing the divert stack(s). [Reg.19.705, Ark. Code Ann. § 8-4-203 as referenced by Ark. Code Ann. §§ 8-4-304 and 8-4-311, and 40 C.F.R. § 52 Subpart E]
10. Within one hour of an operational divert stack event, the permittee shall notify the on-site inspector. If the on-site inspector is unavailable, the permittee shall note the time of the notification attempt in the operation log for the unit. [Reg.19.705 and 40 C.F.R. § 52 Subpart E]
11. The permittee is limited to twelve operational divert stack events per year, and shall not exceed three divert stack events during any rolling 30 day period. [Reg.19.705, Ark. Code Ann. § 8-4-203 as referenced by Ark. Code Ann. §§ 8-4-304 and 8-4-311, and 40 C.F.R. § 52 Subpart E]
12. The permittee shall maintain records which demonstrate compliance with the limit set in Plantwide Condition #11. These records may be used by the Department for enforcement purposes. Records shall be updated during each event, shall be kept on site, and shall be provided to Department in accordance with General Provision #7. [Reg.19.705 and 40 C.F.R. § 52 Subpart E]
13. Within 5 working days of the operational divert stack event, the permittee shall submit to the Department a written report detailing the cause(s) of the event, the duration of the event, actions taken during the event, and actions taken to correct the cause(s). [Reg.19.705 and 40 C.F.R. § 52, Subpart E]
14. Opening of any of the divert stack(s) while uncombusted waste material is NOT contained in the kiln(s) shall constitute a maintenance divert stack event and not be subject to Plant Wide Conditions #6 through #13. [Reg.19.705, Ark. Code Ann. § 8-4-203 as referenced by Ark. Code Ann. §§ 8-4-304 and 8-4-311, and 40 C.F.R. § 52 Subpart E]

Clean Harbors El Dorado, LLC
Permit #: 1009-AOP-R16
AFIN: 70-00098

15. Prior to opening the divert stacks for a maintenance divert stack event, the permittee shall: [Reg.19.705, Ark. Code Ann. § 8-4-203 as referenced by Ark. Code Ann. §§ 8-4-304 and 8-4-311, and 40 C.F.R. § 52 Subpart E]
 - a. Shut down all waste feed;
 - b. Burn out using natural gas as sole source of fuel for one hour prior to opening the divert vent;
 - c. Shut off all burners;
 - d. Do not allow combustion (including natural gas combustion) to take place in the kilns or SCC while vent is open; and
 - e. Follow Emergency Safety Ventilation Procedures set in the MACT Operating Plan.
16. The permittee shall maintain records which demonstrate compliance with the limits set in Plantwide Condition #15. These records may be used by the Department for enforcement purposes. Records shall be updated during each event, shall be kept on site, and shall be provided to Department in accordance with General Condition #7. [Reg.19.705 and 40 C.F.R. § 52 Subpart E]

40 C.F.R. § 61, Subpart C

17. This facility is considered an affected source and is subject, but not limited to, the following requirements. [Reg.19.304 and 40 C.F.R. § 61 Subpart C – National Emission Standard for Beryllium]
18. The permittee shall not emit to the atmosphere greater than 10 grams of beryllium over a 24-hour period. [Reg.19.304 and 40 C.F.R. § 61.32(a)]
19. Within 90 days of startup of the new APC system, the permittee shall test SN-44 according to Method 104 of Appendix B of 40 C.F.R. § 61. CPT for SN-01 was conducted in March, 2006. [Reg.19.304 and 40 C.F.R. § 61.33(a)]
20. The permittee shall notify the Department at least 30 days prior to an emission test. [Reg.19.304 and 40 C.F.R. § 61.33(b)]
21. The permittee shall take samples over such a period or periods as are necessary to accurately determine the maximum emissions which will occur in any 24-hour period. [Reg.19.304 and 40 C.F.R. § 61.33(c)]
22. The permittee shall analyze all samples and beryllium emissions shall be determined within 30 days after the source test. Test results will then be sent to the Department. [Reg.19.304 and 40 C.F.R. § 61.33(d)]

40 C.F.R. § 61, Subpart E

Clean Harbors El Dorado, LLC
Permit #: 1009-AOP-R16
AFIN: 70-00098

23. This facility is considered an affected source and is subject, but not limited to, the following requirements. [Reg.19.304 and 40 C.F.R. § 61 Subpart E – National Emission Standards for Mercury]
24. The permittee shall not emit to the atmosphere greater than 3200 grams of mercury per 24-hour period. [Reg.19.304 and 40 C.F.R. § 61.52(b)]
25. Within 90 days of startup of the new APC system, the permittee shall test SN-44 for mercury emissions using Method 101A in Appendix B of 40 C.F.R. § 61. CPT for SN-01 was conducted in March, 2006. [Reg.19.304 and 40 C.F.R. §61.53(d)(2)]
26. The permittee shall notify the Department at least 30 days prior to an emission test. [Reg.19.304 and 40 C.F.R. § 61.53(d)(3)]
27. The permittee shall take samples over such a period or periods as are necessary to accurately determine the maximum emissions which will occur in any 24-hour period. [Reg.19.304 and 40 C.F.R. § 61.53(d)(4)]
28. The permittee shall analyze all samples and mercury emissions shall be determined within 30 days after the source test. Test results will then be sent to the Department. [Reg.19.304 and 40 C.F.R. § 61.53(d)(5)]
29. The permittee is required to monitor mercury emissions in accordance with § 61.55(a) if the mercury emissions are greater than 1,600 grams per 24-hour period. [Reg.19.304 and 40 C.F.R. § 61.55(a)]

40 C.F.R. § 61, Subpart FF

30. This facility is considered an affected source and is subject, but not limited to, the following requirements. [Reg.19.304 and 40 C.F.R. § 61 Subpart FF]
31. A treatment process or waste stream is in compliance with the requirements of 40 C.F.R. § 61 Subpart FF and exempt from the requirements of paragraph (c) of § 61.348 because the facility is a hazardous waste incinerator for which the owner or operator has been issued a final permit under 40 C.F.R. § 270 and complies with the requirements of 40 C.F.R. § 264 Subpart O. [Reg.19.304 and 40 C.F.R. § 61.348(d)]
32. The facility shall develop and implement a written startup, shutdown, and malfunction plan for those sources indicated as being subject to 40 C.F.R. § 63 Subpart FF. The plan shall include those items listed in 40 C.F.R. § 63.6(e)(3) *et seq.* The plan shall be maintained on site and be available to Department personnel upon request. [Reg.19.304 and 40 C.F.R. § 63.6(e)(3)(i)]

40 C.F.R. § 63, Subpart DD

33. Tanks RCRA 1 through 4, RCRA 8 through RCRA 15, RCRA 602 through 609, 144-TNK-201 through 144-TNK-204, 600-TNK-502 through 600-TNK-504, 600-TNK-505 through 600-TNK-527, containers (including but not limited to: drums, tank trucks, and railcars), vacuum pot distillation unit, thin film evaporator, two distillation columns, transfer systems, and equipment components are subject to 40 C.F.R. § 63 Subpart DD – National Emission Standards for Hazardous Air Pollutants from Off-Site Waste and Recovery Operations. The permittee shall comply with all applicable requirements under 40 C.F.R. § 63 Subpart DD. These requirements include, but are not limited to, the following requirements. [Reg.19.304 and 40 C.F.R. § 63 Subpart DD]
34. Affected sources —(1) Off-site material management units. For each operation specified in paragraphs (a)(2)(i) through (a)(2)(vi) of § 63.680 that is located at the plant site, the affected source is the entire group of off-site material management units associated with the operation. An off-site material management unit is a tank, container, surface impoundment, oil-water separator, organic-water separator, or transfer system used to manage off-site material. For the purpose of implementing the standards under 40 C.F.R. § 63 Subpart DD, a unit that meets the definition of a tank or container but also is equipped with a vent that serves as a process vent for any of the processes listed in paragraphs (c)(2)(i) through (c)(2)(vi) of § 63.680 is not an off-site material management unit but instead is a process vent and is to be included in the appropriate affected source group under paragraph (c)(2) of § 63.680. Examples of such a unit may include, but are not limited to, a distillate receiver vessel, a primary condenser, a bottoms receiver vessel, a surge control tank, a separator tank, and a hot well. [Reg.19.304 and 40 C.F.R. § 63.680(c)(1)]
35. Process vents. For each operation specified in paragraphs (a)(2)(i) through (a)(2)(vi) of § 63.680 that is located at the plant site, the affected source is the entire group of process equipment associated with the process vents for the processes listed in paragraphs (c)(2)(i) through (c)(2)(vi) of §63.680. [Reg.19.304 and 40 C.F.R. § 63.680(c)(2)]
- a. Distillation process used for the treatment, recycling, or recovery of off-site material. Distillation means a process, either batch or continuous, separating one or more off-site material feed streams into two or more exit streams having different component concentrations from those in the feed stream or streams. The separation is achieved by the redistribution of the components between the liquid and vapor phases as they approach equilibrium within the distillation unit. [Reg.19.304 and 40 C.F.R. § 63.680(c)(2)(i)]
 - b. Thin-film evaporation process used for the treatment, recycling, or recovery of off-site material. Thin-film evaporation means a liquid mixture separation process or method that uses a heating surface consisting of a large diameter tube that may be either straight or tapered, horizontal or vertical. Liquid is spread on the tube wall by a rotating assembly of blades that maintain a close clearance from the wall or actually ride on the film of liquid on the wall. [Reg.19.304 and 40 C.F.R. § 63.680(c)(2)(iii)]

36. Equipment leaks. For each operation specified in paragraphs (a)(2)(i) through (a)(2)(vi) of § 63.680 that is located at the plant site, the affected source is the entire group of equipment components for which each component meets all of the conditions specified in paragraphs (c)(3)(i) through (c)(3)(iii) of § 63.680. If any one of these conditions does not apply to an equipment component, then that component is not part of the affected source for equipment leaks. [Reg.19.304 and 40 C.F.R. § 63.680(c)(3)]
- a. The equipment component is a pump, compressor, agitator, pressure relief device, sampling connection system, open-ended valve or line, valve, connector, or instrumentation system; [Reg.19.304 and 40 C.F.R. § 63.680(c)(3)(i)]
 - b. The equipment component contains or contacts off-site material having a total HAP concentration equal to or greater than 10 percent by weight; and [Reg.19.304 and 40 C.F.R. § 63.680(c)(3)(ii)]
 - c. The equipment component is intended to operate for 300 hours or more during a calendar year in off-site material service, as defined in § 63.681 of 40 C.F.R. § 63 Subpart DD. [Reg.19.304 and 40 C.F.R. § 63.680(c)(3)(iii)]
37. Compliance dates —(1) Existing sources. The owner or operator of an affected source that commenced construction or reconstruction before October 13, 1994, must achieve compliance with the provisions of 40 C.F.R. § 63 Subpart DD on or before the date specified in paragraph (e)(1)(i) or (e)(1)(ii) of § 63.680 as applicable to the affected source. [Reg.19.304 and 40 C.F.R. § 63.680(e)(1)]
- a. For an affected source that commenced construction or reconstruction before October 13, 1994 and receives off-site material for the first time before February 1, 2000, the owner or operator of this affected source must achieve compliance with the provisions of 40 C.F.R. § 63 Subpart DD on or before February 1, 2000 unless an extension has been granted by the Administrator as provided in 40 C.F.R. § 63.6(i). [Reg.19.304 and 40 C.F.R. § 63.680(e)(1)(i)]
 - b. For an affected source that commenced construction or reconstruction before October 13, 1994, but receives off-site material for the first time on or after February 1, 2000, the owner or operator of the affected source must achieve compliance with the provisions of 40 C.F.R. § 63 Subpart DD upon the first date that the affected source begins to manage off-site material. [Reg.19.304 and 40 C.F.R. § 63.680(e)(1)(ii)]
38. New sources. The owner or operator of an affected source for which construction or reconstruction commences on or after October 13, 1994, must achieve compliance with the provisions of 40 C.F.R. § 63 Subpart DD on or before July 1, 1996, or upon initial startup of operations, whichever date is later as provided in 40 C.F.R. § 63.6(b). [Reg.19.304 and 40 C.F.R. § 63.680(e)(2)]

39. The provisions of 40 C.F.R. § 63 subpart A—General Provisions that apply and those that do not apply to 40 C.F.R. § 63 Subpart DD are specified in Table 2 of 40 C.F.R. § 63 Subpart DD. [Reg.19.304 and 40 C.F.R. § 63.680(f)]
40. Off-site material management units. (1) For each off-site material management unit that is part of an affected source, the owner or operator must meet the requirements in paragraph (b)(1)(i) of § 63.683. [Reg.19.304 and 40 C.F.R. § 63.683(b)(1)]
 - a. The owner or operator controls air emissions from the off-site material management unit in accordance with the applicable standards specified in §§ 63.685 through 63.689 of 40 C.F.R. § 63 Subpart DD. [Reg.19.304 and 40 C.F.R. § 63.683(b)(1)(i)]
41. Process vents. (1) For each process vent that is part of an affected source, the owner or operator must meet the requirements in paragraph (c)(1)(i) of § 63.683. [Reg.19.304 and 40 C.F.R. § 63.683(c)(1)]
 - a. The owner or operator controls air emissions from the process vent in accordance with the standards specified in § 63.690 of 40 C.F.R. § 63 Subpart DD. [Reg.19.304 and 40 C.F.R. § 63.683(c)(1)(i)]
42. Equipment leaks. The owner or operator must control equipment leaks from each equipment component that is part of the affected source specified in § 63.680(c)(3) of 40 C.F.R. § 63 Subpart DD by implementing leak detection and control measures in accordance with the standards specified in § 63.691 of 40 C.F.R. § 63 Subpart DD. [Reg.19.304 and 40 C.F.R. § 63.683(d)]
43. The owner or operator shall control air emissions from each tank subject to § 63.685 in accordance with the following applicable requirements: [Reg.19.304 and 40 C.F.R. § 63.685(b)]
 - a. For a tank that is part of an existing affected source but the tank is not used to manage off-site material having a maximum HAP vapor pressure kilopascal (kPa) that is equal to or greater than 76.6 kPa nor is the tank used for a waste stabilization process as defined in § 63.681 of 40 C.F.R. § 63 Subpart DD, the owner or operator shall determine whether the tank is required to use either Tank Level 1 controls or Tank Level 2 controls as specified for the tank by Table 3 of 40 C.F.R. § 63 Subpart DD based on the off-site material maximum HAP vapor pressure and the tank's design capacity. The owner or operator shall control air emissions from a tank required by Table 3 to use Tank Level 1 controls in accordance with the requirements of paragraph (c) of § 63.685. The owner or operator shall control air emissions from a tank required by Table 3 to use Tank Level 2 controls in accordance with the requirements of paragraph (d) of § 63.685. [Reg.19.304 and 40 C.F.R. § 63.685(b)(1)]

- b. For a tank that is part of a new affected source but the tank is not used to manage off-site material having a maximum HAP vapor pressure that is equal to or greater than 76.6 kPa nor is the tank used for a waste stabilization process as defined in § 63.681 of 40 C.F.R. § 63 Subpart DD, the owner or operator shall determine whether the tank is required to use either Tank Level 1 controls or Tank Level 2 controls as specified for the tank by Table 4 of 40 C.F.R. § 63 Subpart DD based on the off-site material maximum HAP vapor pressure and the tank's design capacity. The owner or operator shall control air emissions from a tank required by Table 4 to use Tank Level 1 controls in accordance with the requirements of paragraph (c) of § 63.685. The owner or operator shall control air emissions from a tank required by Table 4 to use Tank Level 2 controls in accordance with the requirements of paragraph (d) of § 63.685. [Reg.19.304 and 40 C.F.R. § 63.685(b)(2)]
44. Owners and operators controlling air emissions from a tank using Tank Level 1 controls shall meet the following requirements: [Reg.19.304 and 40 C.F.R. § 63.685(c)]
- a. The owner or operator shall determine the maximum HAP vapor pressure for an off-site material to be managed in the tank using Tank Level 1 controls before the first time the off-site material is placed in the tank. The maximum HAP vapor pressure shall be determined using the procedures specified in § 63.694(j) of 40 C.F.R. § 63 Subpart DD. Thereafter, the owner or operator shall perform a new determination whenever changes to the off-site material managed in the tank could potentially cause the maximum HAP vapor pressure to increase to a level that is equal to or greater than the maximum HAP vapor pressure limit for the tank design capacity category specified in Table 3 or Table 4 of 40 C.F.R. § 63 Subpart DD, as applicable to the tank. [Reg.19.304 and 40 C.F.R. § 63.685(c)(1)]
 - b. The owner or operator must control air emissions from the tank in accordance with the requirements in either paragraph (c)(2)(i) or (c)(2)(ii) of § 63.685, as applicable to the tank. [Reg.19.304 and 40 C.F.R. § 63.685(c)(2)]
 - i. The owner or operator controls air emissions from the tank in accordance with the provisions specified in subpart OO of 40 C.F.R. § 63—National Emission Standards for Tanks—Level 1. [Reg.19.304 and 40 C.F.R. § 63.685(c)(2)(i)]
 - ii. As an alternative to meeting the requirements in paragraph (c)(2)(i) of § 63.685, an owner or operator may control air emissions from the tank in accordance with the provisions for Tank Level 2 controls as specified in paragraph (d) of § 63.685. [Reg.19.304 and 40 C.F.R. § 63.685(c)(2)(ii)]
45. Owners and operators controlling air emissions from a tank using Tank Level 2 controls shall use one of the following tanks: [Reg.19.304 and 40 C.F.R. § 63.685(d)]
- a. A tank vented through a closed-vent system to a control device in accordance with the requirements specified in paragraph (g) of § 63.685. [Reg.19.304 and 40 C.F.R. § 63.685(d)(3)]

46. The owner or operator who controls tank air emissions by venting to a control device shall meet the requirements specified in paragraphs (g)(1) through (g)(3) of § 63.685. [Reg.19.304 and 40 C.F.R. § 63.685(g)]
- a. The tank shall be covered by a fixed roof and vented directly through a closed-vent system to a control device in accordance with the following requirements: [Reg.19.304 and 40 C.F.R. § 63.685(g)(1)]
 - i. The fixed roof and its closure devices shall be designed to form a continuous barrier over the entire surface area of the liquid in the tank. [Reg.19.304 and 40 C.F.R. § 63.685(g)(1)(i)]
 - ii. Each opening in the fixed roof not vented to the control device shall be equipped with a closure device. If the pressure in the vapor headspace underneath the fixed roof is less than atmospheric pressure when the control device is operating, the closure devices shall be designed to operate such that when the closure device is secured in the closed position there are no visible cracks, holes, gaps, or other open spaces in the closure device or between the perimeter of the cover opening and the closure device. If the pressure in the vapor headspace underneath the fixed roof is equal to or greater than atmospheric pressure when the control device is operating, the closure device shall be designed to operate with no detectable organic emissions. [Reg.19.304 and 40 C.F.R. § 63.685(g)(1)(ii)]
 - iii. The fixed roof and its closure devices shall be made of suitable materials that will minimize exposure of the off-site material to the atmosphere, to the extent practical, and will maintain the integrity of the equipment throughout its intended service life. Factors to be considered when selecting the materials for and designing the fixed roof and closure devices shall include: organic vapor permeability, the effects of any contact with the liquid and its vapor managed in the tank; the effects of outdoor exposure to wind, moisture, and sunlight; and the operating practices used for the tank on which the fixed roof is installed. [Reg.19.304 and 40 C.F.R. § 63.685(g)(1)(iii)]
 - iv. The closed-vent system and control device shall be designed and operated in accordance with the requirements of § 63.693 of 40 C.F.R. § 63 Subpart DD. [Reg.19.304 and 40 C.F.R. § 63.685(g)(1)(iv)]
 - b. Whenever an off-site material is in the tank, the fixed roof shall be installed with each closure device secured in the closed position and the vapor headspace underneath the fixed roof vented to the control device except as follows: [Reg.19.304 and 40 C.F.R. § 63.685(g)(2)]
 - i. Venting to the control device is not required, and opening of closure devices or removal of the fixed roof is allowed at the following times: [Reg.19.304 and 40 C.F.R. § 63.685(g)(2)(i)]
 - A. To provide access to the tank for performing routine inspection, maintenance, or other activities needed for normal operations. Examples of such activities include those times when a worker needs to open a port to sample liquid in the tank, or when a worker needs to open a hatch to maintain or repair equipment. Following completion of the activity, the owner or operator shall promptly

- secure the closure device in the closed position or reinstall the cover, as applicable, to the tank. [Reg.19.304 and 40 C.F.R. § 63.685(g)(2)(i)(A)]
- B. To remove accumulated sludge or other residues from the bottom of the tank. [Reg.19.304 and 40 C.F.R. § 63.685(g)(2)(i)(B)]
- ii. Opening of a safety device, as defined in § 63.681 of 40 C.F.R. § 63 Subpart DD, is allowed at any time conditions require it to do so to avoid an unsafe condition. [Reg.19.304 and 40 C.F.R. § 63.685(g)(2)(ii)]
- c. The owner or operator shall inspect and monitor the air emission control equipment in accordance with the procedures specified in § 63.695 of 40 C.F.R. § 63 Subpart DD. [Reg.19.304 and 40 C.F.R. § 63.685(g)(3)]
47. The owner or operator shall control air emissions from each container subject to § 63.688 in accordance with the following requirements, as applicable to the container. [Reg.19.304 and 40 C.F.R. § 63.688(b)]
- a. For a container having a design capacity greater than 0.1 m³ and less than or equal to 0.46 m³, the owner or operator must control air emissions from the container in accordance with the requirements in either paragraph (b)(1)(i) or (b)(1)(ii) of § 63.688. [Reg.19.304 and 40 C.F.R. § 63.688(b)(1)]
- i. The owner or operator controls air emissions from the container in accordance with the standards for Container Level 1 controls as specified in 40 C.F.R. § 63 subpart PP—National Emission Standards for Containers. [Reg.19.304 and 40 C.F.R. § 63.688(b)(1)(i)]
- ii. As an alternative to meeting the requirements in paragraph (b)(1)(i) of § 63.688, an owner or operator may choose to control air emissions from the container in accordance with the standards for either Container Level 2 controls or Container Level 3 controls as specified in subpart PP of this part 63—National Emission Standards for Containers. [Reg.19.304 and 40 C.F.R. § 63.688(b)(1)(ii)]
- b. For a container having a design capacity greater than 0.46 m³ and the container is not in light-material service as defined in §63.681 of 40 C.F.R. § 63 Subpart DD, the owner or operator must control air emissions from the container in accordance with the requirements in either paragraph (b)(1)(i) or (b)(1)(ii) of § 63.688. [Reg.19.304 and 40 C.F.R. § 63.688(b)(2)]
- c. For a container having a design capacity greater than 0.46 m³ and the container is in light-material service as defined in §63.681 of 40 C.F.R. § 63 Subpart DD, the owner or operator must control air emissions from the container in accordance with the requirements in either paragraph (b)(3)(i) or (b)(3)(ii) of § 63.688. [Reg.19.304 and 40 C.F.R. § 63.688(b)(3)]
- i. The owner or operator controls air emissions from the container in accordance with the standards for Container Level 2 controls as specified in 40 C.F.R. § 63 subpart PP—National Emission Standards for Containers. [Reg.19.304 and 40 C.F.R. § 63.688(b)(3)(i)]

- ii. As an alternative to meeting the requirements in paragraph (b)(3)(i) of § 63.688, an owner or operator may choose to control air emissions from the container in accordance with the standards for Container Level 3 controls as specified in 40 C.F.R. § 63 subpart PP—National Emission Standards for Containers. [Reg.19.304 and 40 C.F.R. § 63.688(b)(3)(ii)]

- 48. For each transfer system that is subject to § 63.689, the owner or operator shall control air emissions by using the transfer systems specified in paragraphs (c)(2) of § 63.689. [Reg.19.304 and 40 C.F.R. § 63.689(c)]
 - a. A transfer system that consists of continuous hard-piping. All joints or seams between the pipe sections shall be permanently or semi-permanently sealed (e.g., a welded joint between two sections of metal pipe or a bolted and gasketed flange). [Reg.19.304 and 40 C.F.R. § 63.689(c)(2)]

- 49. The owner or operator must route the vent stream from each affected process vent through a closed-vent system to a control device that meets the standards specified in § 63.693 of 40 C.F.R. § 63 Subpart DD. For the purpose of complying with paragraph (b) of § 63.690, a primary condenser is not a control device; however, a second condenser or other organic recovery device that is operated downstream of the primary condenser is considered a control device. [Reg.19.304 and 40 C.F.R. § 63.690(b)]

- 50. The owner or operator shall control the HAP emitted from equipment leaks in accordance with the applicable provisions specified in either paragraph (b)(1) or (b)(2) of § 63.691. [Reg.19.304 and 40 C.F.R. § 63.691(b)]
 - a. The owner or operator controls the HAP emitted from equipment leaks in accordance with §§ 61.242 through 61.247 in 40 C.F.R. § 61 subpart V—National Emission Standards for Equipment Leaks; or [Reg.19.304 and 40 C.F.R. § 63.691(b)(1)]

- 51. For each closed-vent system and control device used to comply with § 63.693, the owner or operator shall meet the following requirements: [Reg.19.304 and 40 C.F.R. § 63.693(b)]
 - a. The owner or operator must use a closed-vent system that meets the requirements specified in paragraph (c) of § 63.693. [Reg.19.304 and 40 C.F.R. § 63.693(b)(1)]
 - b. The owner or operator must use a control device that meets the requirements specified in paragraphs (d) through (h) of § 63.693 as applicable to the type and design of the control device selected by the owner or operator to comply with the provisions of § 63.693. [Reg.19.304 and 40 C.F.R. § 63.693(b)(2)]
 - c. Whenever gases or vapors containing HAP are vented through a closed-vent system connected to a control device used to comply with § 63.693, the control device must

- be operating except at those times listed in either paragraph (b)(3)(i) or (b)(3)(ii) of § 63.693. [Reg.19.304 and 40 C.F.R. § 63.693(b)(3)]
- i. The control device may be bypassed for the purpose of performing planned routine maintenance of the closed-vent system or control device in situations when the routine maintenance cannot be performed during periods that the emission point vented to the control device is shutdown. On an annual basis, the total time that the closed-vent system or control device is bypassed to perform routine maintenance shall not exceed 240 hours per each calendar year. [Reg.19.304 and 40 C.F.R. § 63.693(b)(3)(i)]
 - ii. The control device may be bypassed for the purpose of correcting a malfunction of the closed-vent system or control device. The owner or operator shall perform the adjustments or repairs necessary to correct the malfunction as soon as practicable after the malfunction is detected. [Reg.19.304 and 40 C.F.R. § 63.693(b)(3)(ii)]
- d. The owner or operator must inspect and monitor each closed-vent system in accordance with the requirements specified in either paragraph (b)(4)(i) or (b)(4)(ii) of § 63.693. [Reg.19.304 and 40 C.F.R. § 63.693(b)(4)]
- i. The owner or operator inspects and monitors the closed-vent system in accordance with the requirements specified in §63.695(c) of 40 C.F.R. § 63 Subpart DD, and complies with the applicable recordkeeping requirements in § 63.696 of 40 C.F.R. § 63 Subpart DD and the applicable reporting requirements in § 63.697 of 40 C.F.R. § 63 Subpart DD. [Reg.19.304 and 40 C.F.R. § 63.693(b)(4)(i)]
 - ii. As an alternative to meeting the requirements specified in paragraph (b)(4)(i) of § 63.693, the owner or operator may choose to inspect and monitor the closed-vent system in accordance with the requirements under 40 C.F.R. § 63 subpart H—National Emission Standards for Organic Hazardous Air Pollutants for Equipment Leaks as specified in 40 C.F.R. § 63.172(f) through (h), and complies with the applicable recordkeeping requirements in 40 C.F.R. § 63.181 and the applicable reporting requirements in 40 C.F.R. § 63.182. [Reg.19.304 and 40 C.F.R. § 63.693(b)(4)(ii)]
- e. The owner or operator must monitor the operation of each control device in accordance with the requirements specified in paragraphs (d) through (h) of § 63.693 as applicable to the type and design of the control device selected by the owner or operator to comply with the provisions of § 63.693. [Reg.19.304 and 40 C.F.R. § 63.693(b)(5)]
- f. The owner or operator shall maintain records for each control device in accordance with the requirements of § 63.696 of 40 C.F.R. § 63 Subpart DD. [Reg.19.304 and 40 C.F.R. § 63.693(b)(6)]

- g. The owner or operator shall prepare and submit reports for each control device in accordance with the requirements of § 63.697 of 40 C.F.R. § 63 Subpart DD. [Reg.19.304 and 40 C.F.R. § 63.693(b)(7)]
 - h. In the case when an owner or operator chooses to use a design analysis to demonstrate compliance of a control device with the applicable performance requirements specified in § 63.693 as provided for in paragraphs (d) through (g) of § 63.693, the Administrator may request that the design analysis be revised or amended by the owner or operator to correct any deficiencies identified by the Administrator. If the owner or operator and the Administrator do not agree on the acceptability of using the design analysis (including any changes requested by the Administrator) to demonstrate that the control device achieves the applicable performance requirements, then the disagreement must be resolved using the results of a performance test conducted by the owner or operator in accordance with the requirements of § 63.694(l) of 40 C.F.R. § 63 Subpart DD. The Administrator may choose to have an authorized representative observe the performance test conducted by the owner or operator. Should the results of this performance test not agree with the determination of control device performance based on the design analysis, then the results of the performance test will be used to establish compliance with 40 C.F.R. § 63 Subpart DD. [Reg.19.304 and 40 C.F.R. § 63.693(b)(8)]
52. Closed-vent system requirements. [Reg.19.304 and 40 C.F.R. § 63.693(c)]
- a. The vent stream required to be controlled shall be conveyed to the control device by either of the following closed-vent systems: [Reg.19.304 and 40 C.F.R. § 63.693(c)(1)]
 - i. A closed-vent system that is designed to operate with no detectable organic emissions using the procedure specified in § 63.694(k) of 40 C.F.R. § 63 Subpart DD; or [Reg.19.304 and 40 C.F.R. § 63.693(c)(1)(i)]
 - ii. A closed-vent system that is designed to operate at a pressure below atmospheric pressure. The system shall be equipped with at least one pressure gage or other pressure measurement device that can be read from a readily accessible location to verify that negative pressure is being maintained in the closed-vent system when the control device is operating. [Reg.19.304 and 40 C.F.R. § 63.693(c)(1)(ii)]
53. Carbon adsorption control device requirements. [Reg.19.304 and 40 C.F.R. § 63.693(d)]
- a. The carbon adsorption system must achieve the performance specifications in either paragraph (d)(1)(i) or (d)(1)(ii) of § 63.693. [Reg.19.304 and 40 C.F.R. § 63.693(d)(1)]
 - i. Recover 95 percent or more, on a weight-basis, of the total organic compounds (TOC), less methane and ethane, contained in the vent stream entering the carbon adsorption system; or [Reg.19.304 and 40 C.F.R. § 63.693(d)(1)(i)]

- ii. Recover 95 percent or more, on a weight-basis, of the total HAP listed in Table 1 of 40 C.F.R. § 63 Subpart DD contained in the vent stream entering the carbon adsorption system. [Reg.19.304 and 40 C.F.R. § 63.693(d)(1)(ii)]
- b. The owner or operator must demonstrate that the carbon adsorption system achieves the performance requirements in paragraph (d)(1) of § 63.693 by either performing a performance test as specified in paragraph (d)(2)(i) of § 63.693 or a design analysis as specified in paragraph (d)(2)(ii) of § 63.693. [Reg.19.304 and 40 C.F.R. § 63.693(d)(2)]
 - i. An owner or operator choosing to use a performance test to demonstrate compliance must conduct the test in accordance with the requirements of § 63.694(l) of 40 C.F.R. § 63 Subpart DD. [Reg.19.304 and 40 C.F.R. § 63.693(d)(2)(i)]
 - ii. An owner or operator choosing to use a design analysis to demonstrate compliance must include as part of this design analysis the information specified in paragraph (d)(2)(ii)(B) of § 63.693 as applicable to the carbon adsorption system design. [Reg.19.304 and 40 C.F.R. § 63.693(d)(2)(ii)]
 - A. For a nonregenerable carbon adsorption system (e.g., a carbon canister), the design analysis shall address the vent stream composition, constituent concentrations, flow rate, relative humidity, and temperature and shall establish the design exhaust vent stream organic compound concentration, carbon bed capacity, activated carbon type and working capacity, and design carbon replacement interval based on the total carbon working capacity of the control device and emission point operating schedule. [Reg.19.304 and 40 C.F.R. § 63.693(d)(2)(ii)(B)]
- c. The owner or operator must monitor the operation of the carbon adsorption system in accordance with the requirements of § 63.695(e) using the continuous monitoring systems specified in paragraphs (d)(3)(ii) of § 63.693. Monitoring the operation of a nonregenerable carbon adsorption system (e.g., a carbon canister) using a continuous monitoring system is not required when the carbon canister or the carbon in the control device is replaced on a regular basis according to the requirements in paragraph (d)(4)(iii) of § 63.693. [Reg.19.304 and 40 C.F.R. § 63.693(d)(3)]
 - i. A continuous monitoring system to measure and record the daily average concentration level of organic compounds in the exhaust gas stream from the control device. The organic monitoring system must comply either with Performance Specification 8 or 9 in 40 C.F.R. § 60 appendix B. The relative accuracy provision of Performance Specification 8, Sections 2.4 and 3 need not be conducted. [Reg.19.304 and 40 C.F.R. § 63.693(d)(3)(ii)]
- d. The owner or operator shall manage the carbon used for the carbon adsorption system, as follows: [Reg.19.304 and 40 C.F.R. § 63.693(d)(4)]
 - i. Following the initial startup of the control device, all carbon in the control device shall be replaced with fresh carbon on a regular, predetermined time interval that is no longer than the carbon service life established for the carbon adsorption

- system. The provisions of this paragraph (d)(4)(i) do not apply to a nonregenerable carbon adsorption system (e.g., a carbon canister) for which the carbon canister or the carbon in the control device is replaced on a regular basis according to the requirements in paragraph (d)(4)(iii) of § 63.693. [Reg.19.304 and 40 C.F.R. § 63.693(d)(4)(i)]
- ii. The spent carbon removed from the carbon adsorption system must be either regenerated, reactivated, or burned in one of the units specified in paragraphs (d)(4)(ii)(A) through (d)(4)(ii)(G) of § 63.693. [Reg.19.304 and 40 C.F.R. § 63.693(d)(4)(ii)]
 - A. Regenerated or reactivated in a thermal treatment unit for which the owner or operator has been issued a final permit under 40 C.F.R. § 270 that implements the requirements of 40 C.F.R. § 264 subpart X. [Reg.19.304 and 40 C.F.R. § 63.693(d)(4)(ii)(A)]
 - B. Regenerated or reactivated in a thermal treatment unit equipped with and operating air emission controls in accordance with § 63.693. [Reg.19.304 and 40 C.F.R. § 63.693(d)(4)(ii)(B)]
 - C. Regenerated or reactivated in a thermal treatment unit equipped with and operating organic air emission controls in accordance with a national emission standard for hazardous air pollutants under another subpart in 40 C.F.R. § 63 or 40 C.F.R. § 61. [Reg.19.304 and 40 C.F.R. § 63.693(d)(4)(ii)(C)]
 - D. Burned in a hazardous waste incinerator for which the owner or operator has been issued a final permit under 40 C.F.R. § 270 that implements the requirements of 40 C.F.R. § 264 subpart O. [Reg.19.304 and 40 C.F.R. § 63.693(d)(4)(ii)(D)]
 - E. Burned in a hazardous waste incinerator for which the owner or operator has designed and operates the incinerator in accordance with the interim status requirements of 40 C.F.R. § 265 subpart O. [Reg.19.304 and 40 C.F.R. § 63.693(d)(4)(ii)(E)]
 - F. Burned in a boiler or industrial furnace for which the owner or operator has been issued a final permit under 40 C.F.R. § 270 that implements the requirements of 40 C.F.R. § 266 subpart H. [Reg.19.304 and 40 C.F.R. § 63.693(d)(4)(ii)(F)]
 - G. Burned in a boiler or industrial furnace for which the owner or operator has designed and operates the unit in accordance with the interim status requirements of 40 C.F.R. § 266 subpart H. [Reg.19.304 and 40 C.F.R. § 63.693(d)(4)(ii)(G)]
 - iii. As an alternative to meeting the requirements in paragraphs (d)(3) and (d)(4)(i) of § 63.693, an owner or operator of a nonregenerable carbon adsorption system may choose to replace on a regular basis the carbon canister or the carbon in the control device using the procedures in either paragraph (d)(4)(iii)(A) or (d)(4)(iii)(B) of § 63.693. For the purpose of complying with this paragraph (d)(4)(iii), a nonregenerable carbon adsorption system means a carbon adsorption system that does not regenerate the carbon bed directly onsite in the control device, such as a carbon canister. The spent carbon removed from the nonregenerable carbon adsorption system must be managed according to the

requirements in paragraph (d)(4)(ii) of § 63.693. [Reg.19.304 and 40 C.F.R. § 63.693(d)(4)(iii)]

- A. Monitor the concentration level of the organic compounds in the exhaust vent from the carbon adsorption system on a regular schedule, and when carbon breakthrough is indicated, immediately replace either the existing carbon canister with a new carbon canister or replace the existing carbon in the control device with fresh carbon. Measurement of the concentration level of the organic compounds in the exhaust vent stream must be made with a detection instrument that is appropriate for the composition of organic constituents in the vent stream and is routinely calibrated to measure the organic concentration level expected to occur at breakthrough. The monitoring frequency must be daily or at an interval no greater than 20 percent of the time required to consume the total carbon working capacity established as a requirement of paragraph (d)(2)(ii)(B) of § 63.693, whichever is longer. [Reg.19.304 and 40 C.F.R. § 63.693(d)(4)(iii)(A)]
- B. Replace either the existing carbon canister with a new carbon canister or replace the existing carbon in the control device with fresh carbon at a regular, predetermined time interval that is less than the design carbon replacement interval established as a requirement of paragraph (d)(2)(ii)(B) of § 63.693. [Reg.19.304 and 40 C.F.R. § 63.693(d)(4)(iii)(B)]

54. Vapor incinerator control device requirements. [Reg.19.304 and 40 C.F.R. § 63.693(f)]

- a. The vapor incinerator must achieve the performance specifications in either paragraph (f)(1)(i), (f)(1)(ii), or (f)(1)(iii) of § 63.693. [Reg.19.304 and 40 C.F.R. § 63.693(f)(1)]
 - i. Destroy the total organic compounds (TOC), less methane and ethane, contained in the vent stream entering the vapor incinerator either: [Reg.19.304 and 40 C.F.R. § 63.693(f)(1)(i)]
 - A. By 95 percent or more, on a weight-basis, or [Reg.19.304 and 40 C.F.R. § 63.693(f)(1)(i)(A)]
 - B. To achieve a total incinerator outlet concentration for the TOC, less methane and ethane, of less than or equal to ppmv on a dry basis corrected to 3 percent oxygen. [Reg.19.304 and 40 C.F.R. § 63.693(f)(1)(i)(B)]
 - ii. Destroy the HAP listed in Table 1 of 40 C.F.R. § 63 Subpart DD contained in the vent stream entering the vapor incinerator either: [Reg.19.304 and 40 C.F.R. § 63.693(f)(1)(ii)]
 - A. By 95 percent or more, on a total HAP weight-basis, or [Reg.19.304 and 40 C.F.R. § 63.693(f)(1)(ii)(A)]
 - B. To achieve a total incinerator outlet concentration for the HAP, listed in Table 1 of 40 C.F.R. § 63 Subpart DD, of less than or equal to ppmv on a dry basis corrected to 3 percent oxygen. [Reg.19.304 and 40 C.F.R. § 63.693(f)(1)(ii)(B)]

- iii. Maintain the conditions in the vapor incinerator combustion chamber at a residence time of 0.5 seconds or longer and at a temperature of 760°C or higher. [Reg.19.304 and 40 C.F.R. § 63.693(f)(1)(iii)]
 - b. The owner or operator must demonstrate that the vapor incinerator achieves the performance requirements in paragraph (f)(1) of § 63.693 by either performing a performance test as specified in paragraph (f)(2)(i) of § 63.693 or a design analysis as specified in paragraph (f)(2)(ii) of § 63.693. [Reg.19.304 and 40 C.F.R. § 63.693(f)(2)]
 - i. An owner or operator choosing to use a performance test to demonstrate compliance must conduct the test in accordance with the requirements of § 63.694(l) of 40 C.F.R. § 63 Subpart DD. [Reg.19.304 and 40 C.F.R. § 63.693(f)(2)(i)]
 - ii. An owner or operator choosing to use a design analysis to demonstrate compliance must include as part of this design analysis the information specified in either paragraph (f)(2)(ii)(A) or (f)(2)(ii)(B) of § 63.693 as applicable to the vapor incinerator design. [Reg.19.304 and 40 C.F.R. § 63.693(f)(2)(ii)]
 - A. For a thermal vapor incinerator, the design analysis shall address the vent stream composition, constituent concentrations, and flow rate and shall establish the design minimum and average temperatures in the combustion chamber and the combustion chamber residence time. [Reg.19.304 and 40 C.F.R. § 63.693(f)(2)(ii)(A)]
 - c. The owner or operator must monitor the operation of the vapor incinerator in accordance with the requirements of § 63.695(e) of 40 C.F.R. § 63 Subpart DD using one of the continuous monitoring systems specified in paragraphs (f)(3)(i) through (f)(3)(iv) of § 63.693 as applicable to the type of vapor incinerator used. [Reg.19.304 and 40 C.F.R. § 63.693(f)(3)]
 - i. For a thermal vapor incinerator, a continuous parameter monitoring system to measure and record the daily average temperature of the exhaust gases from the control device. The accuracy of the temperature monitoring device must be ± 1 percent of the temperature being measured, expressed in degrees Celsius of ± 0.5 °C, whichever is greater. [Reg.19.304 and 40 C.F.R. § 63.693(f)(3)(i)]
 - ii. For either type of vapor incinerator, a continuous monitoring system to measure and record the daily average concentration of organic compounds in the exhaust vent stream from the control device. The organic monitoring system must comply either with Performance Specification 8 or 9 in 40 C.F.R. § 60 appendix B. The relative accuracy provision of Performance Specification 8, Sections 2.4 and 3 need not be conducted. [Reg.19.304 and 40 C.F.R. § 63.693(f)(3)(iii)]
55. To determine maximum organic HAP vapor pressure of off-site materials in tanks for compliance with the standards specified in § 63.685 of 40 C.F.R. § 63 Subpart DD, the testing methods and procedures are specified in paragraph (j) of § 63.694. [Reg.19.304 and 40 C.F.R. § 63.694(a)(9)]

56. To determine no detectable organic emissions, the testing methods and procedures are specified in paragraph (k) of § 63.694. [Reg.19.304 and 40 C.F.R. § 63.694(a)(10)]
57. To determine closed-vent system and control device performance for compliance with the standards specified in § 63.693 of 40 C.F.R. § 63 Subpart DD, the testing methods and procedures are specified in paragraph (l) of § 63.694. [Reg.19.304 and 40 C.F.R. § 63.694(a)(11)]
58. To determine process vent stream flow rate and total organic HAP concentration for compliance with the standards specified in § 63.693 of 40 C.F.R. § 63 Subpart DD, the testing methods and procedures are specified in paragraph (m) of § 63.694. [Reg.19.304 and 40 C.F.R. § 63.694(a)(12)]
59. Determination of maximum HAP vapor pressure for off-site material in a tank. [Reg.19.304 and 40 C.F.R. § 63.694(j)]
 - a. The maximum HAP vapor pressure of the off-site material composition managed in a tank shall be determined using either direct measurement as specified in paragraph (j)(2) of § 63.694 or by knowledge of the off-site material as specified by paragraph (j)(3) of § 63.694. [Reg.19.304 and 40 C.F.R. § 63.694(j)(1)]
 - b. Direct measurement to determine the maximum HAP vapor pressure of an off-site material. [Reg.19.304 and 40 C.F.R. § 63.694(j)(2)]
 - i. Sampling. A sufficient number of samples shall be collected to be representative of the off-site material contained in the tank. All samples shall be collected and handled in accordance with written procedures prepared by the owner or operator and documented in a site sampling plan. This plan shall describe the procedure by which representative samples of the off-site material is collected such that a minimum loss of organics occurs throughout the sample collection and handling process and by which sample integrity is maintained. A copy of the written sampling plan shall be maintained on-site in the plant site operating records. An example of an acceptable sampling plan includes a plan incorporating sample collection and handling procedures in accordance with the requirements specified in “Test Methods for Evaluating Solid Waste, Physical/Chemical Methods,” EPA Publication No. SW-846 or Method 25D in 40 C.F.R. § 60 appendix A. [Reg.19.304 and 40 C.F.R. § 63.694(j)(2)(i)]
 - ii. Analysis. Any one of the following methods may be used to analyze the samples and compute the maximum HAP vapor pressure of the off-site material: [Reg.19.304 and 40 C.F.R. § 63.694(j)(2)(ii)]
 - A. Method 25E in 40 C.F.R. § 60 appendix A;
 - B. Methods described in American Petroleum Institute Bulletin 2517, “Evaporation Loss from External Floating Roof Tanks,”;
 - C. Methods obtained from standard reference texts;
 - D. ASTM Method 2879-83; or
 - E. Any other method approved by the Administrator.

- c. Use of knowledge to determine the maximum HAP vapor pressure of the off-site material. Documentation shall be prepared and recorded that presents the information used as the basis for the owner's or operator's knowledge that the maximum HAP vapor pressure of the off-site material is less than the maximum vapor pressure limit listed in Table 3 or Table 4 of 40 C.F.R. § 63 Subpart DD for the applicable tank design capacity category. Examples of information that may be used include: the off-site material is generated by a process for which at other locations it previously has been determined by direct measurement that the off-site material maximum HAP vapor pressure is less than the maximum vapor pressure limit for the appropriate tank design capacity category. [Reg.19.304 and 40 C.F.R. § 63.694(j)(3)]
60. Procedure for determining no detectable organic emissions for the purpose of complying with 40 C.F.R. § 63 Subpart DD. [Reg.19.304 and 40 C.F.R. § 63.694(k)]
- a. The test shall be conducted in accordance with the procedures specified in Method 21 of 40 C.F.R. § 60 appendix A. Each potential leak interface (i.e., a location where organic vapor leakage could occur) on the cover and associated closure devices shall be checked. Potential leak interfaces that are associated with covers and closure devices include, but are not limited to: the interface of the cover and its foundation mounting; the periphery of any opening on the cover and its associated closure device; and the sealing seat interface on a spring-loaded pressure-relief valve. [Reg.19.304 and 40 C.F.R. § 63.694(k)(1)]
 - b. The test shall be performed when the unit contains a material having a total organic concentration representative of the range of concentrations for the materials expected to be managed in the unit. During the test, the cover and closure devices shall be secured in the closed position. [Reg.19.304 and 40 C.F.R. § 63.694(k)(2)]
 - c. The detection instrument shall meet the performance criteria of Method 21 of 40 C.F.R. § 60 appendix A, except the instrument response factor criteria in section 3.1.2(a) of Method 21 shall be for the average composition of the organic constituents in the material placed in the unit, not for each individual organic constituent. [Reg.19.304 and 40 C.F.R. § 63.694(k)(3)]
 - d. The detection instrument shall be calibrated before use on each day of its use by the procedures specified in Method 21 of 40 C.F.R. § 60 appendix A. [Reg.19.304 and 40 C.F.R. § 63.694(k)(4)]
 - e. Calibration gases shall be as follows: [Reg.19.304 and 40 C.F.R. § 63.694(k)(5)]
 - i. Zero air (less than 10 ppmv hydrocarbon in air); and
 - ii. A mixture of methane or n-hexane in air at a concentration of approximately, but less than, 10,000 ppmv.

- f. An owner or operator may choose to adjust or not adjust the detection instrument readings to account for the background organic concentration level. If an owner or operator chooses to adjust the instrument readings for the background level, the background level value must be determined according to the procedures in Method 21 of 40 C.F.R. § 60 appendix A. [Reg.19.304 and 40 C.F.R. § 63.694(k)(6)]
- g. Each potential leak interface shall be checked by traversing the instrument probe around the potential leak interface as close to the interface as possible, as described in Method 21. In the case when the configuration of the cover or closure device prevents a complete traverse of the interface, all accessible portions of the interface shall be sampled. In the case when the configuration of the closure device prevents any sampling at the interface and the device is equipped with an enclosed extension or horn (e.g., some pressure relief devices), the instrument probe inlet shall be placed at approximately the center of the exhaust area to the atmosphere. [Reg.19.304 and 40 C.F.R. § 63.694(k)(7)]
- h. An owner or operator must determine if a potential leak interface operates with no detectable emissions using the applicable procedure specified in paragraph (k)(8)(i) or (k)(8)(ii) of § 63.694. [Reg.19.304 and 40 C.F.R. § 63.694(k)(8)]
 - i. If an owner or operator chooses not to adjust the detection instrument readings for the background organic concentration level, then the maximum organic concentration value measured by the detection instrument is compared directly to the applicable value for the potential leak interface as specified in paragraph (k)(9) of § 63.694. [Reg.19.304 and 40 C.F.R. § 63.694(k)(8)(i)]
 - ii. If an owner or operator chooses to adjust the detection instrument readings for the background organic concentration level, the value of the arithmetic difference between the maximum organic concentration value measured by the instrument and the background organic concentration value as determined in paragraph (k)(6) of § 63.694 is compared with the applicable value for the potential leak interface as specified in paragraph (k)(9) of § 63.694. [Reg.19.304 and 40 C.F.R. § 63.694(k)(8)(ii)]
- i. A potential leak interface is determined to operate with no detectable emissions using the applicable criteria specified in paragraphs (k)(9)(i) and (k)(9)(ii) of § 63.694. [Reg.19.304 and 40 C.F.R. § 63.694(k)(9)]
 - i. For a potential leak interface other than a seal around a shaft that passes through a cover opening, the potential leak interface is determined to operate with no detectable organic emissions if the organic concentration value determined in paragraph (k)(8) is less than 500 ppmv. [Reg.19.304 and 40 C.F.R. § 63.694(k)(9)(i)]
 - ii. For a seal around a shaft that passes through a cover opening, the potential leak interface is determined to operate with no detectable organic emissions if the organic concentration value determined in paragraph (k)(8) is less than 10,000 ppmv. [Reg.19.304 and 40 C.F.R. § 63.694(k)(9)(ii)]

61. Control device performance test procedures. [Reg.19.304 and 40 C.F.R. § 63.694(1)]
- a. Method 1 or 1A of 40 C.F.R. § 60 appendix A, as appropriate, shall be used for selection of the sampling sites at the inlet and outlet of the control device. [Reg.19.304 and 40 C.F.R. § 63.694(1)(1)]
 - i. To determine compliance with a control device percent reduction requirement, sampling sites shall be located at the inlet of the control device as specified in paragraphs (1)(1)(i)(A) and (1)(1)(i)(B) of § 63.694, and at the outlet of the control device. [Reg.19.304 and 40 C.F.R. § 63.694(1)(1)(i)]
 - A. The control device inlet sampling site shall be located after the final product recovery device. [Reg.19.304 and 40 C.F.R. § 63.694(1)(1)(i)(A)]
 - B. If a vent stream is introduced with the combustion air or as an auxiliary fuel into a boiler or process heater, the location of the inlet sampling sites shall be selected to ensure that the measurement of total HAP concentration or TOC concentration, as applicable, includes all vent streams and primary and secondary fuels introduced into the boiler or process heater. [Reg.19.304 and 40 C.F.R. § 63.694(1)(1)(i)(B)]
 - ii. To determine compliance with an enclosed combustion device concentration limit, the sampling site shall be located at the outlet of the device. [Reg.19.304 and 40 C.F.R. § 63.694(1)(1)(ii)]
 - b. The gas volumetric flow rate shall be determined using Method 2, 2A, 2C, or 2D of 40 C.F.R. § 60 appendix A, as appropriate. [Reg.19.304 and 40 C.F.R. § 63.694(1)(2)]
 - c. To determine compliance with the control device percent reduction requirement, the owner or operator shall use Method 18 of 40 C.F.R. § 60 appendix A of Chapter I; alternatively, any other method or data that has been validated according to the applicable procedures in Method 301 in 40 C.F.R. § 63 appendix A of § 63 may be used. The following procedures shall be used to calculate percent reduction efficiency: [Reg.19.304 and 40 C.F.R. § 63.694(1)(3)]
 - i. The minimum sampling time for each run shall be 1 hour in which either an integrated sample or a minimum of four grab samples shall be taken. If grab sampling is used, then the samples shall be taken at approximately equal intervals in time such as 15 minute intervals during the run. [Reg.19.304 and 40 C.F.R. § 63.694(1)(3)(i)]
 - ii. The mass rate of either TOC (minus methane and ethane) or total HAP (E_i and E_o , respectively) shall be computed. [Reg.19.304 and 40 C.F.R. § 63.694(1)(3)(ii)]
 - A. The following equations shall be used: [Reg.19.304 and 40 C.F.R. § 63.694(1)(3)(ii)(A)]



Where:

C_{ij} , C_{oj} = Concentration of sample component j of the gas stream at the inlet and outlet of the control device, respectively, dry basis, parts per million by volume.

E_i , E_o = Mass rate of TOC (minus methane and ethane) or total HAP at the inlet and outlet of the control device, respectively, dry basis, kilogram per hour.

M_{ij} , M_{oj} = Molecular weight of sample component j of the gas stream at the inlet and outlet of the control device, respectively, gram/gram-mole.

Q_i , Q_o = Flow rate of gas stream at the inlet and outlet of the control device, respectively, dry standard cubic meter per minute.

K_2 = Constant, 2.494×10^{-6} (parts per million) $^{-1}$ (gram-mole per standard cubic meter) (kilogram/gram) (minute/hour), where standard temperature (gram-mole per standard cubic meter) is 20 °C.

- B. When the TOC mass rate is calculated, all organic compounds (minus methane and ethane) measured by Method 18 of 40 C.F.R. § 60 appendix A shall be summed using the equation in paragraph (1)(3)(ii)(A) of § 63.694. [Reg.19.304 and 40 C.F.R. § 63.694(1)(3)(ii)(B)]
- C. When the total HAP mass rate is calculated, only the HAP constituents shall be summed using the equation in paragraph (1)(3)(ii)(A) of § 63.694. [Reg.19.304 and 40 C.F.R. § 63.694(1)(3)(ii)(C)]
- iii. The percent reduction in TOC (minus methane and ethane) or total HAP shall be calculated as follows: [Reg.19.304 and 40 C.F.R. § 63.694(1)(3)(iii)]



where:

R_{cd} = Control efficiency of control device, percent.

E_i = Mass rate of TOC (minus methane and ethane) or total HAP at the inlet to the control device as calculated under paragraph (1)(3)(ii) of § 63.694, kilograms TOC per hour or kilograms HAP per hour.

E_o = Mass rate of TOC (minus methane and ethane) or total HAP at the outlet of the control device, as calculated under paragraph (1)(3)(ii) of § 63.694, kilograms TOC per hour or kilograms HAP per hour. [Reg.19.304 and 40 C.F.R. § 63.694(1)(3)(iii)]

- d. To determine compliance with the enclosed combustion device total HAP concentration limit of 40 C.F.R. § 63 Subpart DD, the owner or operator shall use Method 18 of 40 C.F.R. § 60 appendix A to measure either TOC (minus methane and ethane) or total HAP. Alternatively, any other method or data that has been validated according to Method 301 in appendix A of § 63, may be used. The following

procedures shall be used to calculate parts per million by volume concentration, corrected to 3 percent oxygen: [Reg.19.304 and 40 C.F.R. § 63.694(l)(4)]

- i. The minimum sampling time for each run shall be 1 hour in which either an integrated sample or a minimum of four grab samples shall be taken. If grab sampling is used, then the samples shall be taken at approximately equal intervals in time, such as 15 minute intervals during the run. [Reg.19.304 and 40 C.F.R. § 63.694(l)(4)(i)]
- ii. The TOC concentration or total HAP concentration shall be calculated according to paragraph (m)(4)(ii)(A) or (m)(4)(ii)(B) of § 63.694. [Reg.19.304 and 40 C.F.R. § 63.694(l)(4)(ii)]
 - A. The TOC concentration (C_{TOC}) is the sum of the concentrations of the individual components and shall be computed for each run using the following equation: [Reg.19.304 and 40 C.F.R. § 63.694(l)(4)(ii)(A)]



where:

C_{TOC} = Concentration of total organic compounds minus methane and ethane, dry basis, parts per million by volume.

C_{ji} = Concentration of sample components j of sample i , dry basis, parts per million by volume.

N = Number of components in the sample.

X = Number of samples in the sample run.

- B. The total HAP concentration (C_{HAP}) shall be computed according to the equation in paragraph (l)(4)(ii)(A) of § 63.694 except that only HAP constituents shall be summed. [Reg.19.304 and 40 C.F.R. § 63.694(l)(4)(ii)(B)]
 - iii. The measured TOC concentration or total HAP concentration shall be corrected to 3 percent oxygen as follows: [Reg.19.304 and 40 C.F.R. § 63.694(l)(4)(iii)]
 - A. The emission rate correction factor or excess air, integrated sampling and analysis procedures of Method 3B of 40 C.F.R. § 60 appendix A shall be used to determine the oxygen concentration ($\%O_{2dry}$). The samples shall be collected during the same time that the samples are collected for determining TOC concentration or total HAP concentration. [Reg.19.304 and 40 C.F.R. § 63.694(l)(4)(iii)(A)]
 - B. The concentration corrected to 3 percent oxygen (C_c) shall be computed using the following equation: [Reg.19.304 and 40 C.F.R. § 63.694(l)(4)(iii)(B)]



where:

C_c = TOC concentration or total HAP concentration corrected to 3 percent oxygen, dry basis, parts per million by volume.

C_m = Measured TOC concentration or total HAP concentration, dry basis, parts per million by volume.
 $\%O_{2dry}$ = Concentration of oxygen, dry basis, percent by volume.

62. Determination of process vent stream flow rate and total HAP concentration. [Reg.19.304 and 40 C.F.R. § 63.694(m)]
- a. Method 1 or 1A of 40 C.F.R. § 60 appendix A, as appropriate, must be used for selection of the sampling site. [Reg.19.304 and 40 C.F.R. § 63.694(m)(1)]
 - b. No traverse site selection method is needed for vents smaller than 0.10 meter in diameter. [Reg.19.304 and 40 C.F.R. § 63.694(m)(2)]
 - c. Process vent stream gas volumetric flow rate must be determined using Method 2, 2A, 2C, or 2D of 40 C.F.R. § 60 appendix A, as appropriate. [Reg.19.304 and 40 C.F.R. § 63.694(m)(3)]
 - d. Process vent stream total HAP concentration must be measured using the following procedures: [Reg.19.304 and 40 C.F.R. § 63.694(m)(4)]
 - i. Method 18 of 40 C.F.R. § 60 appendix A, must be used to measure the total HAP concentration. Alternatively, any other method or data that has been validated according to the protocol in Method 301 of appendix A of § 63 may be used. [Reg.19.304 and 40 C.F.R. § 63.694(m)(4)(i)]
 - ii. Where Method 18 of 40 C.F.R. § 60 appendix A, is used, the following procedures must be used to calculate parts per million by volume concentration: [Reg.19.304 and 40 C.F.R. § 63.694(m)(4)(ii)]
 - A. The minimum sampling time for each run must be 1 hour in which either an integrated sample or four grab samples must be taken. If grab sampling is used, then the samples must be taken at approximately equal intervals in time, such as 15 minute intervals during the run. [Reg.19.304 and 40 C.F.R. § 63.694(m)(4)(ii)(A)]
 - B. The total HAP concentration (C_{HAP}) must be computed according to the following equation: [Reg.19.304 and 40 C.F.R. § 63.694(m)(4)(ii)(B)]



Where:

C_{HAP} = Total concentration of HAP compounds listed in Table 1 of 40 C.F.R. § 63 Subpart DD, dry basis, parts per million by volume.

C_{ji} = Concentration of sample component j of the sample i, dry basis, parts per million by volume.

n = Number of components in the sample.

x = Number of samples in the sample run.

63. Tank Level 2 fixed roof and floating roof inspection requirements. [Reg.19.304 and 40 C.F.R. § 63.695(b)]
- a. Owners and operators that use a tank equipped with a fixed roof in accordance with the provisions of § 63.685(g) of 40 C.F.R. § 63 Subpart DD shall meet the following requirements: [Reg.19.304 and 40 C.F.R. § 63.695(b)(3)]
 - i. The fixed roof and its closure devices shall be visually inspected by the owner or operator to check for defects that could result in air emissions. Defects include, but are not limited to, visible cracks, holes, or gaps in the roof sections or between the roof and the separator wall; broken, cracked, or otherwise damaged seals or gaskets on closure devices; and broken or missing hatches, access covers, caps, or other closure devices. In the case when a tank is buried partially or entirely underground, inspection is required only for those portions of the cover that extend to or above the ground surface, and those connections that are on such portions of the cover (e.g., fill ports, access hatches, gauge wells, etc.) and can be opened to the atmosphere. [Reg.19.304 and 40 C.F.R. § 63.695(b)(3)(i)]
 - ii. The owner or operator must perform an initial inspection following installation of the fixed roof. Thereafter, the owner or operator must perform the inspections at least once every calendar year except as provided for in paragraph (f) of § 63.695. [Reg.19.304 and 40 C.F.R. § 63.695(b)(3)(ii)]
 - iii. In the event that a defect is detected, the owner or operator shall repair the defect in accordance with the requirements of paragraph (b)(4) of § 63.695. [Reg.19.304 and 40 C.F.R. § 63.695(b)(3)(iii)]
 - iv. The owner or operator shall maintain a record of the inspection in accordance with the requirements specified in § 63.696(e) of 40 C.F.R. § 63 Subpart DD. [Reg.19.304 and 40 C.F.R. § 63.695(b)(3)(iv)]
 - b. The owner or operator shall repair each defect detected during an inspection performed in accordance with the requirements of paragraph (b)(1), (b)(2), or (b)(3) of § 63.695 in the following manner: [Reg.19.304 and 40 C.F.R. § 63.695(b)(4)]
 - i. The owner or operator shall within 45 calendar days of detecting the defect either repair the defect or empty the tank and remove it from service. If within this 45-day period the defect cannot be repaired or the tank cannot be removed from service without disrupting operations at the plant site, the owner or operator is allowed two 30-day extensions. In cases when an owner or operator elects to use a 30-day extension, the owner or operator shall prepare and maintain documentation describing the defect, explaining why alternative storage capacity is not available, and specify a schedule of actions that will ensure that the control equipment will be repaired or the tank emptied as soon as possible. [Reg.19.304 and 40 C.F.R. § 63.695(b)(4)(i)]
 - ii. When a defect is detected during an inspection of a tank that has been emptied and degassed, the owner or operator shall repair the defect before refilling the tank. [Reg.19.304 and 40 C.F.R. § 63.695(b)(4)(ii)]

64. Owners and operators that use a closed-vent system in accordance with the provisions of § 63.693 of 40 C.F.R. § 63 Subpart DD shall meet the following inspection and monitoring requirements: [Reg.19.304 and 40 C.F.R. § 63.695(c)]
- a. Each closed-vent system that is used to comply with § 63.693(c)(1)(i) of 40 C.F.R. § 63 Subpart DD shall be inspected and monitored in accordance with the following requirements: [Reg.19.304 and 40 C.F.R. § 63.695(c)(1)]
 - i. At initial startup, the owner or operator shall monitor the closed-vent system components and connections using the procedures specified in § 63.694(k) of 40 C.F.R. § 63 Subpart DD to demonstrate that the closed-vent system operates with no detectable organic emissions. [Reg.19.304 and 40 C.F.R. § 63.695(c)(1)(i)]
 - ii. After initial startup, the owner or operator shall inspect and monitor the closed-vent system as follows: [Reg.19.304 and 40 C.F.R. § 63.695(c)(1)(ii)]
 - A. Closed-vent system joints, seams, or other connections that are permanently or semi-permanently sealed (e.g., a welded joint between two sections of hard piping or a bolted and gasketed ducting flange) shall be visually inspected at least once per year to check for defects that could result in air emissions. The owner or operator shall monitor a component or connection using the procedures specified in § 63.694(k) of 40 C.F.R. § 63 Subpart DD to demonstrate that it operates with no detectable organic emissions following any time the component is repaired or replaced (e.g., a section of damaged hard piping is replaced with new hard piping) or the connection is unsealed (e.g., a flange is unbolted). [Reg.19.304 and 40 C.F.R. § 63.695(c)(1)(ii)(A)]
 - B. Closed-vent system components or connections other than those specified in paragraph (c)(1)(ii)(A) of § 63.695, shall be monitored at least once per year using the procedures specified in § 63.694(k) of 40 C.F.R. § 63 Subpart DD to demonstrate that components or connections operate with no detectable organic emissions. [Reg.19.304 and 40 C.F.R. § 63.695(c)(1)(ii)(B)]
 - C. The continuous monitoring system required by § 63.693(b)(4)(i) shall monitor and record either an instantaneous data value at least once every 15 minutes or an average value for intervals of 15 minutes or less. [Reg.19.304 and 40 C.F.R. § 63.695(c)(1)(ii)(C)]
 - D. The owner or operator shall visually inspect the seal or closure mechanism required by § 63.693(c)(2)(ii) at least once every month to verify that the bypass mechanism is maintained in the closed position. [Reg.19.304 and 40 C.F.R. § 63.695(c)(1)(ii)(D)]
 - iii. In the event that a defect or leak is detected, the owner or operator shall repair the defect or leak in accordance with the requirements of paragraph (c)(3) of § 63.695. [Reg.19.304 and 40 C.F.R. § 63.695(c)(1)(iii)]
 - iv. The owner or operator shall maintain a record of the inspection and monitoring in accordance with the requirements specified in § 63.696 of 40 C.F.R. § 63 Subpart DD. [Reg.19.304 and 40 C.F.R. § 63.695(c)(1)(iv)]

- b. Each closed-vent system that is used to comply with § 63.693(c)(1)(ii) of 40 C.F.R. § 63 Subpart DD shall be inspected and monitored in accordance with the following requirements: [Reg.19.304 and 40 C.F.R. § 63.695(c)(2)]
 - i. The closed-vent system shall be visually inspected by the owner or operator to check for defects that could result in air emissions. Defects include, but are not limited to, visible cracks, holes, or gaps in ductwork or piping; loose connections; or broken or missing caps or other closure devices. [Reg.19.304 and 40 C.F.R. § 63.695(c)(2)(i)]
 - ii. The owner or operator must perform an initial inspection following installation of the closed-vent system. Thereafter, the owner or operator must perform the inspections at least once every calendar year except as provided for in paragraph (f) of § 63.695. [Reg.19.304 and 40 C.F.R. § 63.695(c)(2)(ii)]
 - iii. In the event that a defect is detected, the owner or operator shall repair the defect in accordance with the requirements of paragraph (c)(3) of § 63.695. [Reg.19.304 and 40 C.F.R. § 63.695(c)(2)(iii)]
 - iv. The owner or operator shall maintain a record of the inspection in accordance with the requirements specified in § 63.696 of 40 C.F.R. § 63 Subpart DD. [Reg.19.304 and 40 C.F.R. § 63.695(c)(2)(iv)]
 - c. The owner or operator shall repair all detected defects as follows: [Reg.19.304 and 40 C.F.R. § 63.695(c)(3)]
 - i. The owner or operator shall make first efforts at repair of the defect no later than 5 calendar days after detection and repair shall be completed as soon as possible but no later than 45 calendar days after detection. [Reg.19.304 and 40 C.F.R. § 63.695(c)(3)(i)]
 - ii. Repair of a defect may be delayed beyond 45 calendar days if either of the conditions specified in paragraph (c)(3)(ii)(A) or (c)(3)(ii)(B) of § 63.695 occurs. In this case, the owner or operator must repair the defect the next time the process or unit that vents to the closed-vent system is shutdown. Repair of the defect must be completed before the process or unit resumes operation. [Reg.19.304 and 40 C.F.R. § 63.695(c)(3)(ii)]
 - A. Completion of the repair is technically infeasible without the shutdown of the process or unit that vents to the closed-vent system. [Reg.19.304 and 40 C.F.R. § 63.695(c)(3)(ii)(A)]
 - B. The owner or operator determines that the air emissions resulting from the repair of the defect within the specified period would be greater than the fugitive emissions likely to result by delaying the repair until the next time the process or unit that vents to the closed-vent system is shutdown. [Reg.19.304 and 40 C.F.R. § 63.695(c)(3)(ii)(B)]
 - iii. The owner or operator shall maintain a record of the defect repair in accordance with the requirements specified in § 63.696 of 40 C.F.R. § 63 Subpart DD. [Reg.19.304 and 40 C.F.R. § 63.695(c)(3)(iii)]
65. Control device monitoring requirements. For each control device required under § 63.693 of 40 C.F.R. § 63 Subpart DD to be monitored in accordance with the provisions

of this paragraph (e), the owner or operator must ensure that each control device operates properly by monitoring the control device in accordance with the requirements specified in paragraphs (e)(1) through (e)(7) of § 63.695. [Reg.19.304 and 40 C.F.R. § 63.695(e)]

- a. A continuous parameter monitoring system must be used to measure the operating parameter or parameters specified for the control device in §§ 63.693(d) through 63.693(g) of 40 C.F.R. § 63 Subpart DD as applicable to the type and design of the control device. The continuous parameter monitoring system must meet the following specifications and requirements: [Reg.19.304 and 40 C.F.R. § 63.695(e)(1)]
 - i. The continuous parameter monitoring system must measure either an instantaneous value at least once every 15 minutes or an average value for intervals of 15 minutes or less and continuously record either: [Reg.19.304 and 40 C.F.R. § 63.695(e)(1)(i)]
 - A. Each measured data value; or [Reg.19.304 and 40 C.F.R. § 63.695(e)(1)(i)(A)]
 - B. Each block average value for each 1-hour period or shorter periods calculated from all measured data values during each period. If values are measured more frequently than once per minute, a single value for each minute may be used to calculate the hourly (or shorter period) block average instead of all measured values. [Reg.19.304 and 40 C.F.R. § 63.695(e)(1)(i)(B)]
 - ii. The monitoring system must be installed, calibrated, operated, and maintained in accordance with the manufacturer's specifications or other written procedures that provide reasonable assurance that the monitoring equipment is operating properly. [Reg.19.304 and 40 C.F.R. § 63.695(e)(1)(ii)]
- b. Using the data recorded by the monitoring system, the owner or operator must calculate the daily average value for each monitored operating parameter for each operating day. If operation of the control device is continuous, the operating day is a 24-hour period. If control device operation is not continuous, the operating day is the total number of hours of control device operation per 24-hour period. Valid data points must be available for 75 percent of the operating hours in an operating day to compute the daily average. [Reg.19.304 and 40 C.F.R. § 63.695(e)(2)]
- c. For each monitored operating parameter, the owner or operator must establish a minimum operating parameter value or a maximum operating parameter value, as appropriate, to define the range of conditions at which the control device must be operated to continuously achieve the applicable performance requirements specified in § 63.693(b)(2) of 40 C.F.R. § 63 Subpart DD. Each minimum or maximum operating parameter value must be established in accordance with the requirements in paragraphs (e)(3)(i) and (e)(3)(ii) of § 63.695. [Reg.19.304 and 40 C.F.R. § 63.695(e)(3)]
 - i. If the owner or operator conducts a performance test to demonstrate control device performance, then the minimum or maximum operating parameter value must be established based on values measured during the performance test and supplemented, as necessary, by the control device design specifications,

- manufacturer recommendations, or other applicable information. [Reg.19.304 and 40 C.F.R. § 63.695(e)(3)(i)]
- ii. If the owner or operator uses a control device design analysis to demonstrate control device performance, then the minimum or maximum operating parameter value must be established based on the control device design analysis and supplemented, as necessary, by the control device manufacturer recommendations or other applicable information. [Reg.19.304 and 40 C.F.R. § 63.695(e)(3)(ii)]
- d. An excursion for a given control device is determined to have occurred when the monitoring data or lack of monitoring data result in any one of the criteria specified in paragraphs (e)(4)(i) through (e)(4)(iii) of § 63.695 being met. When multiple operating parameters are monitored for the same control device and during the same operating day more than one of these operating parameters meets an excursion criterion specified in paragraphs (e)(4)(i) through (e)(4)(iii) of § 63.695, then a single excursion is determined to have occurred for the control device for that operating day. [Reg.19.304 and 40 C.F.R. § 63.695(e)(4)]
- i. An excursion occurs when the daily average value of a monitored operating parameter is less than the minimum operating parameter limit (or, if applicable, greater than the maximum operating parameter limit) established for the operating parameter in accordance with the requirements of paragraph (e)(3) of § 63.695. [Reg.19.304 and 40 C.F.R. § 63.695(e)(4)(i)]
 - ii. An excursion occurs when the period of control device operation is 4 hours or greater in an operating day and the monitoring data are insufficient to constitute a valid hour of data for at least 75 percent of the operating hours. Monitoring data are insufficient to constitute a valid hour of data if measured values are unavailable for any of the 15-minute periods within the hour. [Reg.19.304 and 40 C.F.R. § 63.695(e)(4)(ii)]
 - iii. An excursion occurs when the period of control device operation is less than 4 hours in an operating day and more than 1 of the hours during the period does not constitute a valid hour of data due to insufficient monitoring data. Monitoring data are insufficient to constitute a valid hour of data if measured values are unavailable for any of the 15-minute periods within the hour. [Reg.19.304 and 40 C.F.R. § 63.695(e)(4)(iii)]
- e. For each excursion, except as provided for in paragraph (e)(6) of this section, the owner or operator shall be deemed to have failed to have applied control in a manner that achieves the required operating parameter limits. Failure to achieve the required operating parameter limits is a violation of this standard. [Reg.19.304 and 40 C.F.R. § 63.695(e)(5)]
- f. An excursion is not a violation of this standard under any one of the conditions specified in paragraphs (e)(6)(i) and (e)(6)(ii) of § 63.695. [Reg.19.304 and 40 C.F.R. § 63.695(e)(6)]
- i. An excursion is not a violation nor does it count toward the number of excused excursions allowed under paragraph (e)(6)(ii) of § 63.695 when the excursion

- occurs during any one of the following periods: [Reg.19.304 and 40 C.F.R. § 63.695(e)(6)(i)]
- A. During a period of startup, shutdown, or malfunction when the affected facility is operated during such period in accordance with § 63.6(e)(1); or [Reg.19.304 and 40 C.F.R. § 63.695(e)(6)(i)(A)]
 - B. During periods of non-operation of the unit or the process that is vented to the control device (resulting in cessation of HAP emissions to which the monitoring applies). [Reg.19.304 and 40 C.F.R. § 63.695(e)(6)(i)(B)]
- ii. For each control device, one excused excursion is allowed per semiannual period for any reason. The initial semiannual period is the 6-month reporting period addressed by the first semiannual report submitted by the owner or operator in accordance with § 63.697(b)(4) of 40 C.F.R. § 63 Subpart DD. [Reg.19.304 and 40 C.F.R. § 63.695(e)(6)(ii)]
- g. Nothing in paragraphs (e)(1) through (e)(6) of § 63.695 shall be construed to allow or excuse a monitoring parameter excursion caused by any activity that violates other applicable provisions of 40 C.F.R. § 63 Subpart DD. [Reg.19.304 and 40 C.F.R. § 63.695(e)(7)]
66. Alternative inspection and monitoring interval. Following the initial inspection and monitoring of a piece of air pollution control equipment in accordance with the applicable provisions of § 63.695, subsequent inspection and monitoring of the equipment may be performed at intervals longer than 1 year when an owner or operator determines that performing the required inspection or monitoring procedures would expose a worker to dangerous, hazardous, or otherwise unsafe conditions and the owner or operator complies with the requirements specified in paragraphs (f)(1) and (f)(2) of § 63.695. [Reg.19.304 and 40 C.F.R. § 63.695(f)]
- a. The owner or operator must prepare and maintain at the plant site written documentation identifying the specific air pollution control equipment designated as “unsafe to inspect and monitor.” The documentation must include for each piece of air pollution control equipment designated as such a written explanation of the reasons why the equipment is unsafe to inspect or monitor using the applicable procedures under § 63.695. [Reg.19.304 and 40 C.F.R. § 63.695(f)(1)]
 - b. The owner or operator must develop and implement a written plan and schedule to inspect and monitor the air pollution control equipment using the applicable procedures specified in § 63.695 during times when a worker can safely access the air pollution control equipment. The required inspections and monitoring must be performed as frequently as practicable but do not need to be performed more frequently than the periodic schedule that would be otherwise applicable to the air pollution control equipment under the provisions of § 63.695. A copy of the written plan and schedule must be maintained at the plant site. [Reg.19.304 and 40 C.F.R. § 63.695(f)(2)]

67. The owner or operator shall comply with the recordkeeping requirements in § 63.10 under 40 C.F.R. § 63 subpart A—General Provisions that are applicable to 40 C.F.R. § 63 Subpart DD as specified in Table 2 of 40 C.F.R. § 63 Subpart DD. [Reg.19.304 and 40 C.F.R. § 63.696(a)]
68. The owner or operator of a control device subject to 40 C.F.R. § 63 Subpart DD shall maintain the records in accordance with the requirements of 40 C.F.R. § 63.10. [Reg.19.304 and 40 C.F.R. § 63.696(b)]
69. An owner or operator shall record, on a semiannual basis, the information specified in paragraphs (g)(1) and (g)(2) of § 63.696 for those planned routine maintenance operations that would require the control device not to meet the requirements of § 63.693(d) through (h) of 40 C.F.R. § 63 Subpart DD, as applicable. [Reg.19.304 and 40 C.F.R. § 63.696(g)]
 - a. A description of the planned routine maintenance that is anticipated to be performed for the control device during the next 6 months. This description shall include the type of maintenance necessary, planned frequency of maintenance, and lengths of maintenance periods. [Reg.19.304 and 40 C.F.R. § 63.696(g)(1)]
 - b. A description of the planned routine maintenance that was performed for the control device during the previous 6 months. This description shall include the type of maintenance performed and the total number of hours during these 6 months that the control device did not meet the requirement of § 63.693 (d) through (h) of 40 C.F.R. § 63 Subpart DD, as applicable, due to planned routine maintenance. [Reg.19.304 and 40 C.F.R. § 63.696(g)(2)]
70. An owner or operator shall record the information specified in paragraphs (h)(1) through (h)(3) of § 63.696 for those unexpected control device system malfunctions that would require the control device not to meet the requirements of § 63.693 (d) through (h) of 40 C.F.R. § 63 Subpart DD, as applicable. [Reg.19.304 and 40 C.F.R. § 63.696(h)]
 - a. The occurrence and duration of each malfunction of the control device system. [Reg.19.304 and 40 C.F.R. § 63.696(h)(1)]
 - b. The duration of each period during a malfunction when gases, vapors, or fumes are vented from the waste management unit through the closed-vent system to the control device while the control device is not properly functioning. [Reg.19.304 and 40 C.F.R. § 63.696(h)(2)]
 - c. Actions taken during periods of malfunction to restore a malfunctioning control device to its normal or usual manner of operation. [Reg.19.304 and 40 C.F.R. § 63.696(h)(3)]

71. Each owner or operator of an affected source subject to 40 C.F.R. § 63 Subpart DD must comply with the notification requirements specified in paragraph (a)(1) of § 63.697 and the reporting requirements specified in paragraph (a)(2) of § 63.697. [Reg.19.304 and 40 C.F.R. § 63.697(a)]
 - a. The owner or operator of an affected source must submit notices to the Administrator in accordance with the applicable notification requirements in 40 C.F.R. § 63.9 as specified in Table 2 of 40 C.F.R. § 63 Subpart DD. For the purpose of 40 C.F.R. § 63 Subpart DD, an owner or operator subject to the initial notification requirements under 40 C.F.R. § 63.9(b)(2) must submit the required notification on or before October 19, 1999. [Reg.19.304 and 40 C.F.R. § 63.697(a)(1)]
 - b. The owner or operator of an affected source must submit reports to the Administrator in accordance with the applicable reporting requirements in 40 C.F.R. § 63.10 as specified in Table 2 of 40 C.F.R. § 63 Subpart DD. [Reg.19.304 and 40 C.F.R. § 63.697(a)(2)]

72. The owner or operator of a control device used to meet the requirements of § 63.693 of 40 C.F.R. § 63 Subpart DD shall submit the following notifications and reports to the Administrator: [Reg.19.304 and 40 C.F.R. § 63.697(b)]
 - a. A Notification of Performance Tests specified in §§ 63.7 and 63.9(g),
 - b. Performance test reports specified in § 63.10(d)(2) and
 - c. Startup, shutdown, and malfunction reports specified in § 63.10(d)(5).
 - i. If actions taken by an owner or operator during a startup, shutdown, or malfunction of an affected source (including actions taken to correct a malfunction) are not completely consistent with the procedures specified in the source's startup, shutdown, and malfunction plan specified in § 63.6(e)(3), the owner or operator shall state such information in the report. The startup, shutdown, or malfunction report shall consist of a letter, containing the name, title, and signature of the responsible official who is certifying its accuracy, that shall be submitted to the Administrator, and
 - ii. Separate startup, shutdown, or malfunction reports are not required if the information is included in the summary report specified in paragraph (b)(4) of § 63.697.
 - d. A summary report specified in § 63.10(e)(3) shall be submitted on a semiannual basis (i.e., once every 6-month period). The summary report must include a description of all excursions as defined in § 63.695(e) of 40 C.F.R. § 63 Subpart DD that have occurred during the 6-month reporting period. For each excursion caused when the daily average value of a monitored operating parameter is less than the minimum operating parameter limit (or, if applicable, greater than the maximum operating parameter limit), the report must include the daily average values of the monitored

parameter, the applicable operating parameter limit, and the date and duration of the period that the exceedance occurred. For each excursion caused by lack of monitoring data, the report must include the date and duration of period when the monitoring data were not collected and the reason why the data were not collected.

40 C.F.R. § 63, Subpart EEE

73. This facility is considered an affected source and is subject, but not limited to, the following requirements. [Reg.19.304 and 40 C.F.R. § 63, Subpart EEE, National Emission Standards for Hazardous Air Pollutants From Hazardous Waste Combustors]
74. The permittee must comply with the standards set forth in 40 C.F.R. § 63 Subpart EEE no later than September 30, 2003 unless the Administrator grants an extension of time under §§ 63.6(i) or 63.1213. [Reg.19.304 and § 63.1206(a)(1)(i)(A)]
75. The permittee must comply with the emission standards under § 63.1219 and the other requirements of 40 C.F.R. § 63 Subpart EEE no later than October 14, 2008. [Reg.19.304 and § 63.1206(a)(1)(ii)(A)]
76. The emission standards and operating requirements set forth in 40 C.F.R. § 63, Subpart EEE apply at all times except: [Reg.19.304 and § 63.1206(b)(1)]
 - a. During periods of startup, shutdown, and malfunction, provided that hazardous waste is not in the combustion chamber (i.e., the hazardous waste feed to the combustor has been cutoff for a period time not less than the hazardous waste residence time, excluding residues that may adhere to the combustion chamber surfaces after waste feed is stopped) during those periods of operation, as provided by paragraph (c)(2)(ii) of § 63.1206; and
 - b. When hazardous waste is not in the combustion chamber (i.e., the hazardous waste feed to the combustor has been cutoff for a period time not less than the hazardous waste residence time, excluding residues that may adhere to the combustion chamber surfaces after waste feed is stopped), and the permittee has documented in the operating record that you are complying with all otherwise applicable requirements and standards promulgated under authority of sections 112 or 129 of the Clean Air Act in lieu of the emission standards under §§ 63.1203, 63.1204, 63.1205, 63.1215, 63.1216, 63.1217, 63.1218, 63.1219, 63.1220, and 63.1221; the monitoring and compliance standards of § 63.1206 and §§ 63.1207 through 63.1209, except the modes of operation requirements of § 63.1209(q); and the notification, reporting, and recordkeeping requirements of §§ 63.1210 through 63.1212.
77. The Administrator will determine compliance with the emission standards of 40 C.F.R. § 63 Subpart EEE as provided by § 63.6(f)(2). Conducting performance testing under operating conditions representative of the extreme range of normal conditions is consistent with the requirements of §§ 63.6(f)(2)(iii)(B) and 63.7(e)(1) to conduct

performance testing under representative operating conditions. [Reg.19.304 and § 63.1206(b)(2)]

78. The Administrator will make a finding concerning compliance with the emission standards and other requirements of 40 C.F.R. § 63 Subpart EEE as provided by § 63.6(f)(3). [Reg.19.304 and § 63.1206(b)(3)]
79. The Administrator may grant an extension of compliance with the emission standards of 40 C.F.R. § 63 Subpart EEE as provided by §§ 63.6(i) and 63.1213. [Reg.19.304 and § 63.1206(b)(4)]
80. If the permittee plans to change the design, operation, or maintenance practices of the source in a manner that may adversely affect compliance with any emission standard that is not monitored with a CEMS, the following must be followed: [Reg.19.304 and § 63.1206(b)(5)(i)]
 - a. The permittee must notify the Administrator at least 60 days prior to the change, unless the permittee documents the circumstances that dictate such prior notice is not reasonably feasible. The notification must include:
 - i. A description of the changes and which emission standards may be affected; and
 - ii. A comprehensive performance test schedule and test plan under the requirements of § 63.1207(f) that will document compliance with the affected emission standard(s);
 - b. The permittee must conduct a comprehensive performance test under the requirements of §§ 63.1207(f)(1) and (g)(1) to document compliance with the affected emission standard(s) and establish operating parameter limits as required under § 63.1209, and submit to the Administrator a Notification of Compliance under §§ 63.1207(j) and 63.1210(d); and
 - c. Restriction on waste burning.
 - i. Except as provided by § 63.1206(b)(5)(i)(C)(2), after the change and prior to submitting the notification of compliance, the permittee must not burn hazardous waste for more than a total of 720 hours (renewable at the discretion of the Administrator) and only for purposes of pretesting or comprehensive performance testing.
 - ii. The permittee may petition the Administrator to obtain written approval to burn hazardous waste in the interim prior to submitting a Notification of Compliance for purposes other than testing or pretesting. The permittee must specify operating requirements, including limits on operating parameters, that will demonstrate compliance with the emission standards of 40 C.F.R. § 63 Subpart EEE based on available information.
81. If the permittee determines that a change will not adversely affect compliance with the emission standards or operating requirements, the permittee must document the change in

- the operating record upon making such change. The permittee will revise as necessary the performance test plan, Documentation of Compliance, Notification of Compliance, and start-up, shutdown, and malfunction plan to reflect these changes. [Reg.19.304 and § 63.1206(b)(5)(ii)]
82. If a DRE test is acceptable as documentation of compliance with the DRE standard, the permittee may use the highest hourly rolling average hydrocarbon level achieved during those DRE test runs to document compliance with the hydrocarbon standard. An acceptable DRE test is any test for which the data and results are determined to meet quality assurance objectives (on a site-specific basis) such that the results adequately demonstrate compliance with the DRE standard. [Reg.19.304 and § 63.1206(b)(6)(i)]
83. If during the acceptable DRE test, the permittee did not obtain hydrocarbon emissions data sufficient to document compliance with the hydrocarbon standard, the permittee must either: [Reg.19.304 and § 63.1206(b)(6)(ii)]
- a. Perform, as part of the performance test, an “equivalent DRE test” to document compliance with the hydrocarbon standard; or
 - b. Perform a DRE test as part of the performance test.
84. The permittee must document compliance with the DRE standard under 40 C.F.R. § 63 Subpart EEE only once, provided that the permittee does not modify the source after the DRE test in a manner that could affect the ability of the source to achieve the DRE standard. [Reg.19.304 and § 63.1206(b)(7)(i)(A)]
85. The permittee may use any DRE test data that documents that the source achieves the required level of DRE provided:
- a. The permittee has not modified the design or operation of the source in a manner that could affect the ability of the source to achieve the DRE standard since the DRE test was performed; and,
 - b. The DRE test data meet quality assurance objectives determined on a site-specific basis. [Reg.19.304 and § 63.1206(b)(7)(i)(B)]
86. For sources that feed hazardous waste at a location in the combustion system other than the normal flame zone, the permittee must demonstrate compliance with the DRE standard during each comprehensive performance test. [Reg.19.304 and § 63.1206(b)(7)(ii)(A)]
87. For sources that do not use DRE previous testing to document conformance with the DRE standard pursuant to § 63.1207(c)(2), the permittee must perform DRE testing during the initial comprehensive performance test. [Reg.19.304 and § 63.1206(b)(7)(iii)]

88. Any particulate matter and opacity standards or any permit or other emissions operating parameter limits or conditions, including any limitation on workplace practices, that are applicable to hazardous waste combustors to insure compliance with any particulate matter or opacity standard of parts §§ 60, 61, 63, 264, 265, and 266 of Chapter I (i.e., any title 40 particulate or opacity standards) applicable to hazardous waste combustor do not apply while the permittee conducts particulate matter continuous emissions monitoring system (CEMS) correlation tests. [Reg.19.304 and § 63.1206(b)(8)(i) and (ii)]
89. For provisions of § 63.1206(b)(8) to apply, the permittee must develop a particulate matter CEMS correlation test plan that includes the following information. This test plan may be included as part of the comprehensive performance test plan required under §§ 63.1207(e) and (f): [Reg.19.304 and § 63.1206(b)(8)(iii)(A) and (B)]
 - a. Number of test conditions and number of runs for each test condition;
 - b. Target particulate matter emission level for each test condition;
 - c. How you plan to modify operations to attain the desired particulate matter emission levels;
 - d. Anticipated normal emission levels; and
 - e. Submit the test plan to the Administrator for approval at least 90 calendar days before the correlation test is scheduled to be conducted.
90. If the Administrator fails to approve or disapprove the correlation test plan with the time period specified by § 63.7(c)(3)(i), the plan is considered approved, unless the Administrator has requested additional information. [Reg.19.304 and § 63.1206(b)(8)(iv)]
91. The particulate matter and associated operating limits and conditions will not be waived for more than 96 hours, in the aggregate, for a correlation test, including all runs of all test conditions unless an extension to this limit has been granted by the Administrator prior to the occurrence. [Reg.19.304 and § 63.1206(b)(8)(v)]
92. The stack sampling team must be on-site and prepared to perform correlation testing no later than 24 hours after the permittee has modified operations to attain the desired particulate matter emissions concentrations; unless the permittee documents in the correlation test plan that a longer period of conditioning is appropriate. [Reg.19.304 and § 63.1206(b)(8)(vi)]
93. The permittee must return to operating conditions indicative of compliance with the applicable particulate matter and opacity standards as soon as possible after correlation testing is completed. [Reg.19.304 and § 63.1206(b)(8)(vii)]

94. The permittee must calculate the hazardous waste residence time and include the calculation in the performance test plan under § 63.1207(f) and the operating record. The permittee must also provide the hazardous waste residence time in the Documentation of Compliance under § 63.1211(c) and the Notification of Compliance under §§ 63.1207(j) and 63.1210(d). [Reg.19.304 and § 63.1206(b)(11)]
95. The permittee must conduct a minimum of three runs of a performance test required under § 63.1207 to document compliance with the emission standards of 40 C.F.R. § 63 Subpart EEE. [Reg.19.304 and § 63.1206(b)(12)(i)]
96. The permittee must document compliance with the emission standards based on the arithmetic average of the emission results of each run, except that the permittee must document compliance with the destruction and removal efficiency standard for each run of the comprehensive performance test individually. [Reg.19.304 and § 63.1206(b)(12)(ii)]
97. In lieu of complying with the particulate standard under § 63.1203, semivolatile and low volatile metal operating parameter limits must be established to ensure compliance with the alternative emission limitations described in paragraphs (b)(14)(ii) and (iii) of §§ 63.1206 pursuant to 63.1209(n), except that semivolatile metal feed rate limits apply to lead, cadmium, and selenium, combined, and low volatile metal feed rate limits apply to arsenic, beryllium, chromium, antimony, cobalt, manganese, and nickel, combined. [Reg.19.304 and § 63.1206(b)(14)(iv)]
98. The permittee must operate only under the operating requirements specified in the Documentation of Compliance under § 63.1211(c) or the Notification of Compliance under §§ 63.1207(j) and 63.1210(d), except during performance tests under approved test plans according to § 63.1207(e), (f), and (g) and under the conditions of paragraph (b)(1)(i) or (ii) of § 63.1206. [Reg.19.304 and § 63.1206(c)(1)(i)]
99. The Documentation of Compliance and the Notification of Compliance must contain operating requirements including, but not limited to, the operating requirements of §§ 63.1206 and 63.1209. [Reg.19.304 and § 63.1206(c)(1)(ii)]
100. Failure to comply with the operating requirements is failure to ensure compliance with the emissions standards of 40 C.F.R. § 63 Subpart EEE. [Reg.19.304 and § 63.1206(c)(1)(iii)]
101. Operating requirements in the Notification of Compliance are applicable requirements for purposes of parts 70 and 71 of Chapter I. [Reg.19.304 and § 63.1206(c)(1)(iv)]
102. The operating requirements specified in the Notification of Compliance will be incorporated in the Title V permit. [Reg.19.304 and § 63.1206(c)(1)(v)]

103. The permittee is subject to the startup, shutdown, and malfunction plan requirements of § 63.6(e)(3). [Reg.19.304 and § 63.1206(c)(2)(i)]
104. If the permittee elects to comply with §§ 270.235(a)(1)(iii), 270.235(a)(2)(iii), or 270.235(b)(1)(ii) of Chapter I to address RCRA concerns that you minimize emissions of toxic compounds from startup, shutdown, and malfunction events (including releases from emergency safety vents), then the permittee must comply with § 63.1206(c)(2)(ii). [Reg.19.304 and § 63.1206(c)(2)(ii)]
105. The permittee must identify in the plan the projected oxygen correction factor based on normal operations to use during periods of startup and shutdown. [Reg.19.304 and § 63.1206(c)(2)(iii)]
106. The permittee must record the plan in the operating record. [Reg.19.304 and § 63.1206(c)(2)(iv)]
107. During malfunctions, the automatic waste feed cutoff requirements of § 63.1206(c)(3) continue to apply, except for paragraphs (c)(3)(v) and (c)(3)(vi) of § 63.1206. If the permittee exceeds a § 63 Subpart EEE, of Chapter I emission standard monitored by a CEMS or COMs or operating limit specified under § 63.1209, the automatic waste feed cutoff system must immediately and automatically cutoff the hazardous waste feed, except as provided by paragraph (c)(3)(viii) of § 63.1206. If the malfunction itself prevents immediate and automatic cutoff of the hazardous waste feed, however, the permittee must cease feeding hazardous waste as quickly as possible. Although the automatic waste feed cutoff requirements continue to apply during a malfunction, an exceedance of an emission standard monitored by a CEMS or COMS or operating limit specified under § 63.1209 is not a violation of 40 C.F.R. § 63 Subpart EEE if the permittee operates in accordance with § 63.6(e)(1). [Reg.19.304 and § 63.1206(c)(2)(v)(A)(1) and (2)]
108. For each set of 10 exceedances of an emission standard or operating requirement while hazardous waste remains in the combustion chamber (*i.e.*, when the hazardous waste residence time has not transpired since the hazardous waste feed was cutoff) during a 60-day block period, the permittee must: [Reg.19.304 and § 63.1206(c)(2)(v)(A)(3)]
 - a. Within 45 days of the 10th exceedance, complete an investigation of the cause of each exceedance and evaluation of approaches to minimize the frequency, duration, and severity of each exceedance, and revise the startup, shutdown, and malfunction plan as warranted by the evaluation to minimize the frequency, duration, and severity of each exceedance; and
 - b. Record the results of the investigation and evaluation in the operating record, and include a summary of the investigation and evaluation, and any changes to the startup, shutdown, and malfunction plan, in the excess emissions report required under § 63.10(e)(3).

109. *Compliance with AWFCO requirements when burning hazardous waste during startup and shutdown.* [Reg.19.304 and § 63.1206(c)(2)(v)(B)]
- a. If the permittee feeds hazardous waste during startup or shutdown, the permittee must include waste feed restrictions (*e.g.*, type and quantity), and other appropriate operating conditions and limits in the startup, shutdown, and malfunction plan.
 - b. The permittee must interlock the operating limits you establish under paragraph (c)(2)(v)(B)(1) of § 63.1206 with the automatic waste feed cutoff system required under § 63.1206(c)(3), except for paragraphs (c)(3)(v) and (c)(3)(vi) of § 63.1206.
 - c. When feeding hazardous waste during startup or shutdown, the automatic waste feed cutoff system must immediately and automatically cutoff the hazardous waste feed if the permittee exceeds the operating limits the permittee establishes under paragraph (c)(2)(v)(B)(1) of § 63.1206, except as provided by paragraph (c)(3)(viii) of § 63.1206.
 - d. Although the automatic waste feed cutoff requirements of this paragraph (c)(2)(v)(B)(4) apply during startup and shutdown, an exceedance of an emission standard or operating limit is not a violation of 40 C.F.R. § 63 Subpart EEE if the permittee operates in accordance with § 63.6(e)(1).
110. Upon the compliance date, the permittee must operate the combustor with a functioning system that immediately and automatically cuts off the hazardous waste feed, except as provided by paragraph (c)(3)(viii) of § 63.1206: [Reg.19.304 and § 63.1206(c)(3)(i)]
- a. When any of the following are exceeded: operating parameter limits specified under § 63.1209; an emission standard monitored by CEMS; and the allowable combustion chamber pressure;
 - b. When the span value of any CMS detector, except a CEMS, is met or exceeded;
 - c. Upon malfunction of a CMS monitoring an operating parameter limit specified under § 63.1209 or an emission level; or
 - d. When any component of the automatic waste feed cutoff system fails.
111. During an automatic waste feed cutoff (AWFCO) the permittee must continue to duct combustion gases to the air pollution control system while hazardous waste remains in the combustion chamber (*i.e.*, if the hazardous waste residence time has not transpired since the hazardous waste feed cutoff system was activated). [Reg.19.304 and § 63.1206(c)(3)(ii)]

112. The permittee must continue to monitor during the cutoff the operating parameters for which limits are established under § 63.1209 and the emissions required under that section to be monitored by a CEMS, and the permittee shall not restart the hazardous waste feed until the operating parameters and emission levels are within specified limits. [Reg.19.304 and § 63.1206(c)(3)(iii)]
113. If the AWFCO system fails to automatically and immediately cutoff the flow of hazardous waste upon exceedance of a parameter required to be interlocked with the AWFCO system under paragraph (c)(3)(i) of § 63.1206, the permittee has failed to comply with the AWFCO requirements of paragraph (c)(3) of § 63.1206. If an equipment or other failure prevents immediate and automatic cutoff of the hazardous waste feed, however, the permittee must cease feeding hazardous waste as quickly as possible. [Reg.19.304 and § 63.1206(c)(3)(iv)]
114. If, after any AWFCO, there is an exceedance of any emission standard or operating requirement, irrespective of whether the exceedance occurred while hazardous waste remained in the combustion chamber (i.e., whether the hazardous waste residence time has transpired since the hazardous waste feed cutoff system was activated), the permittee shall investigate the cause of the AWFCO, take appropriate corrective measures to minimize future AWFCOs and record the findings and corrective measures in the operating record. [Reg.19.304 and § 63.1206(c)(3)(v)]
115. For each set of 10 exceedances of an emissions standard or operating requirement while hazardous waste remains in the combustion chamber (i.e., when the hazardous waste residence time has not transpired since the hazardous waste feed was cutoff), excluding residues that may adhere to the combustion chamber surfaces after waste feed is stopped, during a 60-day block period, the permittee must submit to the Administrator a written report within 5 calendar days of the 10th exceedance documenting the exceedances and the results of the investigation and corrective measures taken. [Reg.19.304 and § 63.1206(c)(3)(vi)(A)]
116. On a case-by-case basis, the Administrator may require excessive exceedance reporting when fewer than 10 exceedances occur during a 60-day block period. [Reg.19.304 and § 63.1206(c)(3)(vi)(B)]
117. The AWFCO system and associated alarms must be tested at least weekly to verify operability, unless the permittee documents in the operating record that weekly inspections will unduly restrict or upset operations and that less frequent inspection will be adequate. At a minimum, the permittee must conduct operability testing at least monthly. The permittee must document and record in the operating record AWFCO operability test procedures and results. [Reg.19.304 and § 63.1206(c)(3)(vii)]
118. The permittee may ramp down the waste feed rate of pumpable hazardous waste over a period not to exceed one minute, except as provided by paragraph (c)(3)(viii)(B). If the permittee elects to ramp down the waste feed, the permittee must document ramp down

procedures in the operating and maintenance plan. The procedure must specify that the ramp down begins immediately upon initiation of automatic waste feed cutoff and the procedures must prescribe a bona fide ramping down. If an emission standard or operating limit is exceeded during the ramp down, the permittee has failed to comply with the emission standards or operating requirements of 40 C.F.R. § 63 Subpart EEE. [Reg.19.304 and § 63.1206(c)(3)(viii)(A)]

119. If the automatic waste feed cutoff is triggered by an exceedance of any of the following operating limits, the permittee may not ramp down the waste feed cutoff: Minimum combustion temperature, maximum hazardous waste feed rate, or any hazardous waste firing system operating limits that may be established for the combustor. [Reg.19.304 and § 63.1206(c)(3)(viii)(B)]
120. The permittee is subject to the emergency safety vent (ESV) operating and reporting requirements set forth in § 63.1206(c)(4). [Reg.19.304 and §§ 63.1206(c)(4)(i through iv)]
121. The permittee is subject to the combustion system leak control system operating and reporting requirements set forth in § 63.1206(c)(5). [Reg.19.304 and §§ 63.1206(c)(5)(i through ii)]
122. The permittee is subject to the operator training and certification standards set forth in § 63.1206(c)(6). [Reg.19.304 and §§ 63.1206(c)(6)(i through vii)]
123. The permittee must prepare and at all times operate according to an operation and maintenance plan which complies with the requirements set forth in § 63.1206(c)(7). [Reg.19.304 and §§ 63.1206(c)(7)(i through iv)]
124. If the combustor is equipped with a baghouse (fabric filter), the permittee must continuously operate either:
 - a. A bag leak detection system that meets the specifications and requirements of paragraph (c)(8)(ii) of § 63.1206 and the permittee must comply with the corrective measures and notification requirements of paragraphs (c)(8)(iii) and (iv) of § 63.1206; or
 - b. A particulate matter detection system under paragraph (c)(9) of § 63.1206.
125. If the permittee operates a bag leak detection system, then the permittee is subject to the bag leak detection system standards set forth in § 63.1206(c)(8). [Reg.19.304 and §§ 63.1206(c)(8)(ii through iv)]
126. If the permittee operates a particulate matter detection system, the permittee is subject to the particulate matter detection system standards set forth in § 63.1206(c)(9). [Reg.19.304 and § 63.1206(c)(9)]

127. The permittee must conduct performance testing in accordance with the applicable requirements contained in § 63.1207. [Reg.19.304 and §§ 63.1207(a-m)]
128. The permittee must commence the initial comprehensive performance test not later than six months after the compliance date. An extension to March 30, 2006 for conducting the comprehensive performance test was given by the Environmental Protection Agency. [Reg.19.304 and § 63.1207(c)(1)]
129. The permittee must conduct testing periodically as described in paragraphs (d)(1) through (3) of § 63.1207. The date of commencement of the initial comprehensive performance test is the basis for establishing the deadline to commence the initial confirmatory performance test and the next comprehensive performance test. The permittee may conduct performance testing at any time prior to the required date. The deadline for commencing subsequent confirmatory and comprehensive performance testing is based on the date of commencement of the previous comprehensive performance test. [Reg.19.304 and §§ 63.1207(d)(1) through (3)]
 - a. The permittee must commence testing no later than 61 months after the date of commencing the previous comprehensive performance test.
 - b. The permittee must commence confirmatory performance testing no later than 31 months after the date of commencing the previous comprehensive performance test. To insure that the confirmatory test is conducted approximately midway between comprehensive performance tests, the Administrator will not approve a test plan that schedules testing within 18 months of commencing the previous comprehensive performance test.
 - c. The permittee must complete performance testing within 60 days after the date of commencement, unless the Administrator determines that a time extension is warranted based on documentation in writing of factors beyond the permittee's control that prevent the permittee from meeting the 60-day deadline.
130. Except as provided in paragraph (c)(2) of § 63.1207, the permittee must conduct only an initial comprehensive performance test under the interim standards (§§ 63.1203 through 63.1205); all subsequent comprehensive performance testing requirements are waived under the interim standards. The provisions in the introductory text to paragraph (d) and in paragraph (d)(1) of § 63.1207 apply only to tests used to demonstrate compliance with the standards under §§ 63.1219 through 63.1221. [Reg.19.304 and § 63.1207(d)(4)(i)]
131. The permittee is not required to conduct a confirmatory test under the interim standards (§§ 63.1203 through 63.1205). The confirmatory testing requirements in the introductory text to paragraph (d) and in paragraph (d)(2) of § 63.1207 apply only after the permittee has demonstrated compliance with the standards under §§ 63.1219 through 63.1221. [Reg.19.304 and § 63.1207(d)(4)(ii)]

132. The permittee must submit to the Administrator a notification of intent to conduct a comprehensive performance test and CMS performance evaluation and a site specific test plan and CMS performance evaluation plan at least one year before the performance test and performance evaluation are scheduled to begin. [Reg.19.304 and § 63.1207(e)(1)(i)]
133. The permittee must submit to the Administrator a notification of intent to conduct the comprehensive performance test at least 60 calendar days before the test is scheduled to begin. [Reg.19.304 and § 63.1207(e)(1)(i)(B)]
134. The permittee must submit to the Administrator a notification of intent to conduct a confirmatory performance test and CMS performance evaluation and a site-specific test plan and CMS performance evaluation plan at least 60 calendar days before the performance test is scheduled to begin. [Reg.19.304 and § 63.1207(e)(1)(ii)]
135. The permittee shall use the test methods contained in § 63.1208 when determining compliance with the emissions standards of 40 C.F.R. § 63 Subpart EEE. [Reg.19.304 and §§ 63.1208(a-b)]
136. The permittee is subject to the applicable monitoring requirements contained in § 63.1209. [Reg.19.304 and §§ 63.1209 (a-r)]
137. The permittee must use either a carbon monoxide or hydrocarbon CEMS to demonstrate and monitor compliance with the carbon monoxide and hydrocarbon standards under 40 C.F.R. § 63 Subpart EEE. The permittee must also use an oxygen CEMS to continuously correct the carbon monoxide or hydrocarbon levels to 7 percent oxygen. [Reg.19.304 and § 63.1209(a)(1)(i)]
138. The permittee must install, calibrate, maintain, and operate a particulate matter CEMS to demonstrate and monitor compliance with the particulate matter standards under 40 C.F.R. § 63 Subpart EEE. However, compliance with the requirements in § 63.1209 to install, calibrate, maintain, and operate the PM CEMS is not required until such time that the Agency promulgates all performance specifications and operational requirements applicable to PM CEMS. [Reg.19.304 and § 63.1209(a)(1)(iii)]
139. The permittee must install, calibrate, maintain, and continuously operate the COMS and CEMS in compliance with the quality assurance procedures provided in the appendix to 40 C.F.R. § 63 Subpart EEE and Performance Specifications 1 (opacity), 4B (carbon monoxide and oxygen), and 8A (hydrocarbons) in Appendix B, § 60 of Chapter I. [Reg.19.304 and § 63.1209(a)(2)]
140. If a carbon monoxide CEMS is used, the permittee is subject to the provisions of § 63.1209(a)(3) if a carbon monoxide exceedance is detected. [Reg.19.304 and § 63.1209(a)(3)]

141. If a hydrocarbon CEMS is used, the permittee is subject to the provisions of § 63.1209(a)(4) if a hydrocarbon exceedance is detected. [Reg.19.304 and § 63.1209(a)(4)]
142. If the permittee elects to comply with the carbon monoxide and hydrocarbon emission standard by continuously monitoring carbon monoxide with a CEMS, the permittee must demonstrate that hydrocarbon emissions during the comprehensive performance test do not exceed the hydrocarbon emissions standard. In addition, the limits the permittee establishes on the destruction and removal efficiency (DRE) operating parameters required under paragraph (j) of § 63.1209 also ensure that the permittee maintains compliance with the hydrocarbon emission standard. If the permittee does not conduct the hydrocarbon demonstration and DRE tests concurrently, the permittee must establish separate operating parameter limits under paragraph (j) of § 63.1209 based on each test and the more restrictive of the operating parameter limits applies. [Reg.19.304 and § 63.1209(a)(7)]
143. The permittee is subject to the CMS standards of § 63.1209(b). [Reg.19.304 and § 63.1209(b)]
144. Prior to feeding the material, the permittee must obtain an analysis of each feed stream that is sufficient to document compliance with the applicable feed rate limits provided in § 63.1209. [Reg.19.304 and § 63.1209(c)(1)]
145. The permittee must develop and implement a feed stream analysis plan and record it in the operating record. [Reg.19.304 and § 63.1209(c)(2)]
146. The permittee must submit the feed stream analysis plan to the Administrator for review and approval, if requested. [Reg.19.304 and § 63.1209(c)(3)]
147. To comply with the applicable feed rate limits of § 63.1209, the permittee must monitor and record the feed rates as follows: [Reg.19.304 and § 63.1209(c)(4)]
 - a. Determine and record the value of the parameter for each feed stream by sampling and analysis or other method;
 - b. Determine and record the mass or volume flow rate of each feed stream by a CMS. If the permittee determines flow rate of a feed stream by volume, the permittee must determine and record the density of the feed stream by sampling and analysis (unless the permittee reports the constituent concentration in units of weight per volume); and
 - c. Calculate and record the mass feed rate of the parameter per unit time.
148. The requirements of §§ 63.8(d) (Quality control program) and (e) (Performance evaluation of continuous monitoring systems) apply, except that the permittee must conduct performance evaluations components of the CMS under the frequency and procedures (for example, submittal of performance evaluation test plan for review and

approval) applicable to performance tests as provided by § 63.1207. [Reg.19.304 and § 63.1209(d)(1)]

149. The permittee must comply with the quality assurance procedures for CEMS prescribed in the appendix to 40 C.F.R. § 63 Subpart EEE. [Reg.19.304 and § 63.1209(d)(2)]
150. To remain in compliance with the destruction and removal efficiency (DRE) standards, the permittee must establish operating limits during the comprehensive performance test (or during a previous DRE test under provisions of § 63.1206(b)(7)) for the following parameters, unless the limits are based on manufacturer specifications and comply with those limits at all times that hazardous waste remains in the combustion chamber (i.e., the hazardous waste residence time has not transpired since the hazardous waste feed cutoff system was activated). [Reg.19.304 and § 63.1209(j)]
- a. The permittee must measure the temperature of each combustion chamber at locations that best represents, as practicable, the bulk gas temperature in the combustion zone. The permittee must document the temperature measurement location in the test plan submitted under § 63.1207(e). The permittee must establish a minimum hourly rolling average limit as the average of the test run averages. [Reg.19.304 and § 63.1209(j)(1)(i) and (ii)]
 - b. As an indicator of gas residence time in the control device, the permittee must establish and comply with a limit on the maximum flue gas flow rate, the maximum production rate, or another parameter that is documented in the site-specific test plan as an appropriate surrogate for gas residence time, as the average of the maximum hourly rolling averages for each run. The permittee must comply with this limit on an hourly rolling average basis. [Reg.19.304 and § 63.1209(j)(2)(i) and (ii)]
 - c. The permittee must establish limits on the maximum pumpable and total (i.e., pumpable and non-pumpable) hazardous waste feed rate for each location where hazardous waste is fed. Based on the most recent comprehensive performance test, these limits are listed below. [Reg.19.304 and § 63.1209(j)(3)(i)]

Location		Maximum Total Hazardous Waste Feed Rate (lb/hr)	Maximum Pumpable Hazardous Waste Feed Rate (lb/hr)	Averaging Period
SN-01	Kiln 1	13,383	5,005	Hourly Rolling Average
	Kiln 2	30,168	9,527	
SN-44	Kiln	20,000	7,000	
SN-01	Secondary	13,601	13,601	Hourly Rolling

Location		Maximum Total Hazardous Waste Feed Rate (lb/hr)	Maximum Pumpable Hazardous Waste Feed Rate (lb/hr)	Averaging Period
SN-44	Combustion Chamber	15,000	15,000	Average
SN-01 Waste Fired Boiler		3,873	3,873	Hourly Rolling Average

151. The permittee must specify operating parameters and limits to insure that good operation of each hazardous waste firing system is maintained. [Reg.19.304 and § 63.1209(j)(4)]
152. The permittee must comply with the dioxin and furans emission standard by establishing and complying with the following operating parameter limits. The permittee must base the limits on operations during the comprehensive performance test, unless the limits are based on manufacturer specifications. [Reg.19.304 and § 63.1209(k)]
153. The permittee must establish a limit on the maximum temperature of the gas at the inlet to the baghouse on an hourly rolling average. The permittee must establish the hourly rolling average limit as the average of the test run averages. [Reg.19.304 and § 63.1209(k)(1)(i)]
154. The permittee must measure the temperature of each combustion chamber at a location that best represents, as practicable, the bulk gas temperature in the combustion zone. The permittee must document the temperature measurement location in the test plan. These temperatures are: [Reg.19.304 and § 63.1209(k)(2)(i)]

Location		Minimum Temperature (°F)	Averaging Period
SN-01	Secondary Combustion Chamber	1,851	Hourly Rolling Average
SN-44		1,800	
SN-01 Waste Fired Boiler		1,856	Hourly Rolling Average

155. As an indicator of gas residence time in the control device, the permittee must establish and comply with a limit on the maximum flue gas flow rate, the maximum production rate, or another parameter that the permittee documents in the site-specific test plan as an appropriate surrogate for gas residence time, as the average of the maximum hourly rolling averages for each run. The maximum flue gas flow rate shall be 100,568 acfm for

SN-01 and 89,000 acfm for SN-44 on an hourly rolling average basis. [Reg.19.304 and § 63.1209(k)(3)(i)]

156. The permittee established limits on the maximum pumpable and total (pumpable and non-pumpable) hazardous waste feed rate for each location where waste is fed. These feed rates are: [Reg.19.304 and § 63.1209(k)(4)(i)]

Location		Maximum Total Hazardous Waste Feed Rate (lb/hr)	Maximum Pumpable Hazardous Waste Feed Rate (lb/hr)	Averaging Period
SN-01	Kiln 1	13,383	5,005	Hourly Rolling Average
	Kiln 2	30,168	9,527	
SN-44	Kiln	20,000	7,000	
SN-01	Secondary Combustion Chamber	13,601	13,601	Hourly Rolling Average
SN-44		15,000	15,000	
SN-01 Waste Fired Boiler		3,873	3,873	Hourly Rolling Average

157. If the combustor is equipped with an activated carbon injection system or a carbon bed system, it is subject to the provisions of § 63.1209(k) (5). [Reg.19.304 and § 63.1209(k)(5)]
158. If the combustor is equipped with an activated carbon injection system, it is subject to the provisions of § 63.1209(k) (6). [Reg.19.304 and § 63.1209(k)(6)]
159. The permittee must establish a limit on minimum carbon injection rate on an hourly rolling average calculated as the average of the test run averages. If the carbon injection system injects carbon at more than one location, the permittee must establish a carbon feed rate limit for each location. The minimum carbon feed rate limit for SN-01 is 22.4 lb/hr and for SN-44 is 23.0 lb/hr (hourly rolling average). [Reg.19.304 and § 63.1209(k)(6)(i)]
160. The permittee must establish a limit on minimum carrier fluid (gas or liquid) flow rate or pressure drop as an hourly rolling average based on the manufacturer's specifications. The permittee must document the specifications in the test plan submitted under §§ 63.1207(e) and (f). The minimum carrier fluid flow rate for SN-01 is 30 scfm and for SN-44 is 3 scfm (hourly rolling average). [Reg.19.304 and § 63.1209(k)(6)(ii)]
161. The permittee must specify and use the brand (*i.e.*, manufacturer) and type of carbon used during the comprehensive performance test until a subsequent comprehensive

performance test is conducted, unless the permittee documents in the site-specific performance test plan required under §§ 63.1207(e) and (f) key parameters that affect adsorption and establish limits on those parameters based on the carbon used in the performance test. The permittee may substitute at any time a different brand or type of carbon provided that the replacement has equivalent or improved properties compared to the carbon used in the performance test and conforms to the key sorbent parameters the permittee identifies under § 63.1209 (k)(6)(iii)(A). The permittee must include in the operating record documentation that the substitute carbon will provide the same level of control as the original carbon. [Reg.19.304 and § 63.1209(k)(6)(iii)]

162. The permittee must comply with the mercury emission standard by establishing and complying with the operating parameter limits found in § 63.1209(l). [Reg.19.304 and § 63.1209(l)]
163. For incinerators and solid fuel boilers, when complying with the mercury emission standards under §§ 63.1203, 63.1216 and 63.1219, the permittee must establish a 12-hour rolling average limit for the total feed rate of mercury in all feed streams and the Waste Fired Boiler as the average of the test run averages. The feed rate of all SN-01 and SN-44 feed streams shall not exceed 0.46 lb/hr mercury each and the feed rate for SN-01 WFB mercury shall not exceed 0.187 lb/hr (rolling 12 hour average). [Reg.19.304 and § 63.1209(l)(1)(i)]
164. The permittee must comply with the particulate matter emission standard by establishing and complying with the operating parameter limits found in § 63.1209(m) of 40 C.F.R. § 63 Subpart EEE. [Reg.19.304 and § 63.1209(m)]
165. The permittee must establish the minimum pressure drop across the SN-01 wet scrubber on an hourly rolling average, established as the average of the test run averages. The minimum pressure drop across the SN-01 high energy scrubber is 33.8 in. w.c. (hourly rolling average). [Reg.19.304 and § 63.1209(m)(1)(i)(A)]
166. The permittee must establish a limit on solids content of the scrubber liquid using a CMS or by manual sampling and analysis. If the permittee elects to monitor solids content manually, the permittee must sample and analyze the scrubber liquid hourly unless the permittee supports an alternative monitoring frequency in the performance test plan that the permittee submits for review and approval, or establish a minimum blowdown rate using a CMS and either a minimum scrubber tank volume or liquid level using a CMS. [Reg.19.304 and § 63.1209(m)(1)(i)(B)(1)(i) and (ii)]
167. For maximum solids content monitored with a CMS, the permittee must establish a limit on a twelve-hour rolling average as the average of the test run averages. [Reg.19.304 and § 63.1209(m)(1)(i)(B)(2)]
168. For maximum solids content measured manually, the permittee must establish an hourly limit, as measured at least once per hour, unless the permittee supports an alternative

- monitoring frequency in the performance test plan that the permittee submits for review and approval. The permittee must establish the maximum hourly limit as the average of the manual measurement averages for each run. [Reg.19.304 and § 63.1209(m)(1)(i)(B)(3)]
169. For minimum blowdown rate and either a minimum scrubber tank volume or liquid level using a CMS, the permittee must establish a limit on an hourly rolling average as the average of the test run averages. [Reg.19.304 and § 63.1209(m)(1)(i)(B)(4)]
170. The permittee established limits on the minimum scrubber water flow rate and maximum flue gas flow rate on an hourly rolling average based upon testing. If the permittee establishes limits on maximum flue gas flow rate under this paragraph, the permittee need not establish a limit on maximum flue gas flow rate under paragraph (m)(2) of § 63.1209. The permittee must establish these hourly rolling average limits as the average of the test run averages. The minimum scrubber water flow rate for SN-01 is 664 gpm and for SN-44 is 4,500 gpm (hourly rolling average). The maximum flue gas flow rate for SN-01 is 100,568 acfm and for SN-44 is 89,000 acfm (hourly rolling average). [Reg.19.304 and § 63.1209(m)(1)(i)(C)]
171. If the combustor is equipped with a baghouse, the permittee must establish a limit on the minimum pressure drop and the maximum pressure drop across each baghouse cell based on manufacturer's specifications. The permittee must comply with the limit on an hourly rolling average. The minimum baghouse pressure drop per cell is 1 in. w.c. The maximum baghouse pressure drop per cell is 16 in. w.c. [Reg.19.304 and § 63.1209(m)(1)(ii)]
172. The permittee established a maximum ash feed rate limit based upon testing. The total feed rate of ash for SN-01 shall not exceed 15,695 lb/hr and for SN-44 shall not exceed 20,000 lb/hr. The feed rate of ash for the WFB shall not exceed 164.2 lb/hr (12 hour rolling average). [Reg.19.304 and § 63.1209(m)(3)]
173. The permittee must comply with the semi-volatile metal (cadmium and lead) and low volatile metal (arsenic, beryllium, and chromium) emission standards by establishing and complying with the following operating parameter limits. [Reg.19.304 and § 63.1209(n)]
174. The permittee must establish a limit on the maximum inlet temperature to the primary dry metals emissions control device on an hourly rolling basis as the average of the test run averages. [Reg.19.304 and § 63.1209(n)(1)]

175. The permittee established feed rate limits for semi-volatile metals and low volatile metals as set forth in § 63.1209(n) (2). These feed rate limits are: [Reg.19.304 and § 63.1209(n)(2)]

Metal		Maximum Feed rate Limit (lb/hr, 12 hr-RA)	Maximum Pumpable System Feed rate Limit (lb/hr, 12 hr-RA)	Maximum WFB Feed rate Limit (lb/MMBtu, 12 hr-RA)	Maximum WFB Chromium Feed rate Limit (lb/MMBtu, 12 hr-RA)	Maximum WFB Chromium Feed rate Limit (lb/hr, 12 hr-RA)
SN-01	Semi volatile	123		3.12		
SN-44		116				
SN-01	Low volatile	44	44		2.87	30
SN-44		114				

176. The permittee must establish operating parameter limits on the particulate matter control device as specified by paragraph § 63.1209(m)(1). [Reg.19.304 and § 63.1209(n)(3)]
177. The permittee established a 12-hour rolling average limit for the feed rate of total chlorine and chloride in all feed streams and the WFB from testing. The feed rate of chlorine and chloride shall not exceed 2718 lb/hr for all SN-01 combined feed streams, 4,000 lb/hr for all SN-44 combined feed streams, and 1,020 Lb/MMBtu for the SN-01 WFB (12 hour rolling average). [Reg.19.304 and § 63.1209(n)(4)]
178. As an indicator of gas residence time in the control device, the permittee must establish a limit on the maximum flue gas flow rate, the maximum production rate, or another parameter that the permittee documents in the site-specific test plan as an appropriate surrogate for gas residence time, as the average of the maximum hourly rolling averages for each run. The permittee must comply with this limit on an hourly rolling average basis. [Reg.19.304 and § 63.1209(n)(5)]
179. The permittee must comply with the hydrochloric acid and chlorine emission standards by establishing and complying with the operating parameter limits found in § 63.1209(o). [Reg.19.304 and § 63.1209(o)]
180. The permittee must establish a 12-hour rolling average limit for the total feed rate of chlorine (organic and inorganic) in all feed streams and the WFB as the average of the test run averages. The feed rate of total chlorine and chloride shall not exceed 2718 lb/hr for all SN-01 feed streams, 4,000 lb/hr for all SN-44 combined feed streams and 1,020

- lb/MMBtu for the SN-01 WFB (12 hour rolling average). [Reg.19.304 and § 63.1209(o)(1)(i)]
181. The permittee must establish a limit on minimum pressure drop across the SN-01 wet scrubber on an hourly rolling average as the average of the test run averages. [Reg.19.304 and § 63.1209(o)(3)(i)]
 182. The permittee established a limit on minimum pH on an hourly rolling average as the average of the test run averages. The minimum pH of the inlet water to the SN-01 high energy scrubber is 3.4 and to the SN-44 spray tower condenser is 2.7 (hourly rolling average). [Reg.19.304 and § 63.1209(o)(3)(iv)]
 183. The permittee must establish limits on either the minimum liquid to gas ratio or the minimum scrubber water flow rate and maximum flue gas flow rate on an hourly rolling average as the average of the test run averages. If the permittee establishes limits on maximum flue gas flow rate under this paragraph, the permittee need not establish a limit on maximum flue gas flow rate under paragraph (o)(2) of § 63.1209. [Reg.19.304 and § 63.1209(o)(3)(v)]
 184. If the permittee complies with the requirements for combustion system leaks under § 63.1206(c)(5) by maintaining combustion chamber zone pressure lower than ambient pressure, the permittee must monitor the pressure instantaneously and the automatic waste feed cutoff system must be engaged when negative pressure is not adequately maintained. [Reg.19.304 and § 63.1209(p)]
 185. The permittee shall submit all of the applicable notifications prior to the deadlines established in 40 C.F.R. § 63 Subpart EEE. [Reg.19.304 and § 63.1210(a)(1)]
 186. The permittee must submit the required notifications outlined in § 63.1210(a)(2) to the Administrator in order to request or elect to comply with the alternative requirements contained in 40 C.F.R. § 63 Subpart EEE. [Reg.19.304 and § 63.1210(a)(2)]
 187. Upon postmark of the Notification of Compliance, the operating parameter limits identified in the Notification of Compliance, as applicable, shall be complied with, the limits identified in the Document of Compliance or a previous Notification of Compliance are no longer applicable. [Reg.19.304 and § 63.1210(d)(2)]
 188. The permittee shall comply with the recordkeeping and reporting requirements of § 63.1211. [Reg.19.304 and § 63.1211]
 189. The permittee may request an extension of the compliance date to install pollution prevention or waste minimization controls provided that the conditions outlined in § 63.1213 are met. [Reg.19.304 and § 63.1213]

190. Prior to April 14, 2008, the permittee shall submit an application to the Department which addresses all of the applicable requirements of §§ 63.1217 and 63.1219. An application was received on April 11, 2008. [Reg.19.304 and § 26.1011(A)(1)]
191. For existing sources, the permittee must not discharge or cause combustion gases to be emitted into the atmosphere that contain: [Reg.19.304 and § 63.1219(a)]
- a. For dioxins and furans:
 - i. Emissions in excess of 0.20 ng TEQ/dscm, corrected to 7 percent oxygen; or
 - ii. Emissions in excess of 0.40 ng TEQ/dscm, corrected to 7 percent oxygen, provided that the combustion gas temperature at the inlet to the initial particulate matter control device is 400 °F or lower based on the average of the test run average temperatures. (For purposes of compliance, operation of a wet particulate matter control device is presumed to meet the 400 °F or lower requirement);
 - b. Mercury in excess of 130 µgm/dscm, corrected to 7 percent oxygen;
 - c. Cadmium and lead in excess of 230 µgm/dscm, combined emissions, corrected to 7 percent oxygen;
 - d. Arsenic, beryllium, and chromium in excess of 92 µgm/dscm, combined emissions, corrected to 7 percent oxygen;
 - e. For carbon monoxide and hydrocarbons, either:
 - i. Carbon monoxide in excess of 100 parts per million by volume, over an hourly rolling average (monitored continuously with a continuous emissions monitoring system), dry basis and corrected to 7 percent oxygen. If the permittee elects to comply with this carbon monoxide standard rather than the hydrocarbon standard under paragraph (a)(5)(ii) of § 63.1219, the permittee must also document that, during the destruction and removal efficiency (DRE) test runs or their equivalent as provided by § 63.1206(b)(7), hydrocarbons do not exceed 10 parts per million by volume during those runs, over an hourly rolling average (monitored continuously with a continuous emissions monitoring system), dry basis, corrected to 7 percent oxygen, and reported as propane; or
 - ii. Hydrocarbons in excess of 10 parts per million by volume, over an hourly rolling average (monitored continuously with a continuous emissions monitoring system), dry basis, corrected to 7 percent oxygen, and reported as propane;
 - f. Hydrogen chloride and chlorine gas (total chlorine) in excess of 32 parts per million by volume, combined emissions, expressed as a chloride (Cl(-)) equivalent, dry basis and corrected to 7 percent oxygen; and
 - g. Particulate matter in excess of 0.013 gr/dscf corrected to 7 percent oxygen.

192. For new sources, the permittee must not discharge or cause combustion gases to be emitted into the atmosphere that contain: [Reg.19.304 and § 63.1219(b)]
- a. For Dioxins and furans:
 - i. Emissions in excess of 0.11 ng TEQ/dscm corrected to 7 percent oxygen; or
 - ii. Emissions in excess of 0.20 ng TEQ/dscm corrected to 7 percent oxygen for sources not equipped with either a waste heat boiler or dry air pollution control system;
 - b. Mercury in excess of 8.1 µgm/dscm, corrected to 7 percent oxygen;
 - c. Cadmium and lead in excess of 10 µgm/dscm, combined emissions, corrected to 7 percent oxygen;
 - d. Arsenic, beryllium, and chromium in excess of 23 µgm/dscm, combined emissions, corrected to 7 percent oxygen;
 - e. For carbon monoxide and hydrocarbons, either:
 - i. Carbon monoxide in excess of 100 parts per million by volume, over an hourly rolling average (monitored continuously with a continuous emissions monitoring system), dry basis and corrected to 7 percent oxygen. If you elect to comply with this carbon monoxide standard rather than the hydrocarbon standard under paragraph (b)(5)(ii) of this section, you must also document that, during the destruction and removal efficiency (DRE) test runs or their equivalent as provided by § 63.1206(b)(7), hydrocarbons do not exceed 10 parts per million by volume during those runs, over an hourly rolling average (monitored continuously with a continuous emissions monitoring system), dry basis, corrected to 7 percent oxygen, and reported as propane; or
 - ii. Hydrocarbons in excess of 10 parts per million by volume, over an hourly rolling average (monitored continuously with a continuous emissions monitoring system), dry basis, corrected to 7 percent oxygen, and reported as propane;
 - f. Hydrogen chloride and chlorine gas in excess of 21 parts per million by volume, combined emissions, expressed as a chloride (Cl⁻) equivalent, dry basis and corrected to 7 percent oxygen; and
 - g. Particulate matter emissions in excess of 0.0016 gr/dscf corrected to 7 percent oxygen.
193. The permittee must achieve a destruction and removal efficiency (DRE) of 99.99% for each principle organic hazardous constituent (POHC) designated under paragraph (c)(3) of § 63.1219. The permittee must calculate DRE for each POHC from the following equation: [Reg.19.304 and § 63.1219(c)(1)]

$$\text{DRE} = [1 - (\text{Wout}/ \text{Win})] \times 100\%$$

Where:

Win = mass feed rate of one POHC in a waste feed stream; and
Wout = mass emission rate of the same POHC present in exhaust emissions prior to release to the atmosphere.

194. The permittee must treat each POHC in the waste feed that the permittee specified under paragraph (c)(3)(ii) of § 63.1219 to the extent required by paragraphs (c)(1) and (c)(2) of § 63.1219. [Reg.19.304 and § 63.1219(c)(3)(i)]
195. The permittee must specify one or more POHCs that are representative of the most difficult to destroy organic compounds in your hazardous waste feed stream. The permittee must base this specification on the degree of difficulty of incineration of the organic constituents in the hazardous waste and on their concentration or mass in the hazardous waste feed, considering the results of hazardous waste analyses or other data and information. [Reg.19.304 and § 63.1219(c)(3)(ii)]

Risk Assessment Requirements

196. Compliance with the conditions of this air permit is also contingent upon the compliance with the Risk Assessment Requirements contained in the RCRA Permit No. 10H-RN1. [Ark. Code Ann. § 8-4-203 as referenced by Ark. Code Ann. §§ 8-4-304 and 8-4-311]

Acid Rain (Title IV)

197. The Director prohibits the permittee to cause any emissions exceeding any allowances the source lawfully holds under Title IV of the Act or the regulations promulgated under the Act. No permit revision is required for increases in emissions allowed by allowances acquired pursuant to the acid rain program, if such increases do not require a permit revision under any other applicable requirement. This permit establishes no limit on the number of allowances held by the permittee. However, the source may not use allowances as a defense for noncompliance with any other applicable requirement of this permit or the Act. The permittee will account for any such allowance according to the procedures established in regulations promulgated under Title IV of the Act. [Reg. 26.701 and 40 C.F.R. § 70.6(a)(4)]

Title VI Provisions

198. The permittee must comply with the standards for labeling of products using ozone-depleting substances. [40 C.F.R. § 82 Subpart E]
- a. All containers containing a class I or class II substance stored or transported, all products containing a class I substance, and all products directly manufactured with a

- class I substance must bear the required warning statement if it is being introduced to interstate commerce pursuant to § 82.106.
- b. The placement of the required warning statement must comply with the requirements pursuant to § 82.108.
 - c. The form of the label bearing the required warning must comply with the requirements pursuant to § 82.110.
 - d. No person may modify, remove, or interfere with the required warning statement except as described in § 82.112.
199. The permittee must comply with the standards for recycling and emissions reduction, except as provided for MVACs in Subpart B. [40 C.F.R. § 82 Subpart F]
- a. Persons opening appliances for maintenance, service, repair, or disposal must comply with the required practices pursuant to § 82.156.
 - b. Equipment used during the maintenance, service, repair, or disposal of appliances must comply with the standards for recycling and recovery equipment pursuant to § 82.158.
 - c. Persons performing maintenance, service repair, or disposal of appliances must be certified by an approved technician certification program pursuant to § 82.161.
 - d. Persons disposing of small appliances, MVACs, and MVAC like appliances must comply with record keeping requirements pursuant to § 82.166. (“MVAC like appliance” as defined at § 82.152)
 - e. Persons owning commercial or industrial process refrigeration equipment must comply with leak repair requirements pursuant to § 82.156.
 - f. Owners/operators of appliances normally containing 50 or more pounds of refrigerant must keep records of refrigerant purchased and added to such appliances pursuant to § 82.166.
200. If the permittee manufactures, transforms, destroys, imports, or exports a class I or class II substance, the permittee is subject to all requirements as specified in 40 C.F.R. § 82 Subpart A, Production and Consumption Controls.
201. If the permittee performs a service on motor (fleet) vehicles when this service involves ozone depleting substance refrigerant (or regulated substitute substance) in the motor vehicle air conditioner (MVAC), the permittee is subject to all the applicable requirements as specified in 40 C.F.R. § 82 Subpart B, Servicing of Motor Vehicle Air Conditioners.

Clean Harbors El Dorado, LLC
Permit #: 1009-AOP-R16
AFIN: 70-00098

The term “motor vehicle” as used in Subpart B does not include a vehicle in which final assembly of the vehicle has not been completed. The term “MVAC” as used in Subpart B does not include the air tight sealed refrigeration system used as refrigerated cargo, or the system used on passenger buses using HCFC 22 refrigerant.

202. The permittee can switch from any ozone depleting substance to any alternative listed in the Significant New Alternatives Program (SNAP) promulgated pursuant to 40 C.F.R. § 82, Subpart G.

SECTION VII: INSIGNIFICANT ACTIVITIES

The Department deems the following types of activities or emissions as insignificant on the basis of size, emission rate, production rate, or activity in accordance with Group A of the Insignificant Activities list found in Regulation 18 and Regulation 19 Appendix A. Group B insignificant activities may be listed but are not required to be listed in permits. Insignificant activity emission determinations rely upon the information submitted by the permittee in an application dated July 16, 2015. [Reg.26.304 and Ark. Code Ann. § 8-4-203 as referenced by Ark. Code Ann. §§ 8-4-304 and 8-4-311]

Description	Category
SN-15 NaSH Storage at Brine Unit (formally SN-22)	B-21
10,000 gal Diesel Storage Tank and Dispenser Unit	A-3
Nine (9) Solar Sipper LNAPL Recovery Systems	A-13
Surface Water Treatment	A-13
SN-22 Brine Plant Sources (other than listed)	A-13
Filter Aid Loading Operation (at Tank 597) (formally SN-22)	A-13
Bulk Solid Mixing Process Backup Carbon Filter	A-13
Railcar Unloading Emergency Scrubber	A-13
Diesel Storage Tank for SN-44 Startup	A-3

SECTION VIII: GENERAL PROVISIONS

1. Any terms or conditions included in this permit which specify and reference Arkansas Pollution Control & Ecology Commission Regulation 18 or the Arkansas Water and Air Pollution Control Act (Ark. Code Ann. § 8-4-101 *et seq.*) as the sole origin of and authority for the terms or conditions are not required under the Clean Air Act or any of its applicable requirements, and are not federally enforceable under the Clean Air Act. Arkansas Pollution Control & Ecology Commission Regulation 18 was adopted pursuant to the Arkansas Water and Air Pollution Control Act (Ark. Code Ann. § 8-4-101 *et seq.*). Any terms or conditions included in this permit which specify and reference Arkansas Pollution Control & Ecology Commission Regulation 18 or the Arkansas Water and Air Pollution Control Act (Ark. Code Ann. § 8-4-101 *et seq.*) as the origin of and authority for the terms or conditions are enforceable under this Arkansas statute. [40 C.F.R. § 70.6(b)(2)]
2. This permit shall be valid for a period of five (5) years beginning on the date this permit becomes effective and ending five (5) years later. [40 C.F.R. § 70.6(a)(2) and Reg.26.701(B)]
3. The permittee must submit a complete application for permit renewal at least six (6) months before permit expiration. Permit expiration terminates the permittee's right to operate unless the permittee submitted a complete renewal application at least six (6) months before permit expiration. If the permittee submits a complete application, the existing permit will remain in effect until the Department takes final action on the renewal application. The Department will not necessarily notify the permittee when the permit renewal application is due. [Reg.26.406]
4. Where an applicable requirement of the Clean Air Act, as amended, 42 U.S.C. 7401, *et seq.* (Act) is more stringent than an applicable requirement of regulations promulgated under Title IV of the Act, the permit incorporates both provisions into the permit, and the Director or the Administrator can enforce both provisions. [40 C.F.R. § 70.6(a)(1)(ii) and Reg.26.701(A)(2)]
5. The permittee must maintain the following records of monitoring information as required by this permit.
 - a. The date, place as defined in this permit, and time of sampling or measurements;
 - b. The date(s) analyses performed;
 - c. The company or entity performing the analyses;
 - d. The analytical techniques or methods used;
 - e. The results of such analyses; and
 - f. The operating conditions existing at the time of sampling or measurement.

[40 C.F.R. § 70.6(a)(3)(ii)(A) and Reg.26.701(C)(2)]

6. The permittee must retain the records of all required monitoring data and support information for at least five (5) years from the date of the monitoring sample, measurement, report, or application. Support information includes all calibration and maintenance records and all original strip chart recordings for continuous monitoring instrumentation, and copies of all reports required by this permit. [40 C.F.R. § 70.6(a)(3)(ii)(B) and Reg.26.701(C)(2)(b)]
7. The permittee must submit reports of all required monitoring every six (6) months. If the permit establishes no other reporting period, the reporting period shall end on the last day of the month six months after the issuance of the initial Title V permit and every six months thereafter. The report is due on the first day of the second month after the end of the reporting period. The first report due after issuance of the initial Title V permit shall contain six months of data and each report thereafter shall contain 12 months of data. The report shall contain data for all monitoring requirements in effect during the reporting period. If a monitoring requirement is not in effect for the entire reporting period, only those months of data in which the monitoring requirement was in effect are required to be reported. The report must clearly identify all instances of deviations from permit requirements. A responsible official as defined in Reg.26.2 must certify all required reports. The permittee will send the reports to the address below:

Arkansas Department of Environmental Quality
Office of Air Quality
ATTN: Compliance Inspector Supervisor
5301 Northshore Drive
North Little Rock, AR 72118-5317

[40 C.F.R. § 70.6(a)(3)(iii)(A) and Reg.26.701(C)(3)(a)]

8. The permittee shall report to the Department all deviations from permit requirements, including those attributable to upset conditions as defined in the permit.
 - a. For all upset conditions (as defined in Reg.19.601), the permittee will make an initial report to the Department by the next business day after the discovery of the occurrence. The initial report may be made by telephone and shall include:
 - i. The facility name and location;
 - ii. The process unit or emission source deviating from the permit limit;
 - iii. The permit limit, including the identification of pollutants, from which deviation occurs;
 - iv. The date and time the deviation started;
 - v. The duration of the deviation;
 - vi. The emissions during the deviation;
 - vii. The probable cause of such deviations;
 - viii. Any corrective actions or preventive measures taken or being taken to prevent such deviations in the future; and

ix. The name of the person submitting the report.

The permittee shall make a full report in writing to the Department within five (5) business days of discovery of the occurrence. The report must include, in addition to the information required by the initial report, a schedule of actions taken or planned to eliminate future occurrences and/or to minimize the amount the permit's limits were exceeded and to reduce the length of time the limits were exceeded. The permittee may submit a full report in writing (by facsimile, overnight courier, or other means) by the next business day after discovery of the occurrence, and the report will serve as both the initial report and full report.

- b. For all deviations, the permittee shall report such events in semi-annual reporting and annual certifications required in this permit. This includes all upset conditions reported in 8a above. The semi-annual report must include all the information as required by the initial and full reports required in 8a.

[Reg.19.601, Reg.19.602, Reg.26.701(C)(3)(b), and 40 C.F.R. § 70.6(a)(3)(iii)(B)]

9. If any provision of the permit or the application thereof to any person or circumstance is held invalid, such invalidity will not affect other provisions or applications hereof which can be given effect without the invalid provision or application, and to this end, provisions of this Regulation are declared to be separable and severable. [40 C.F.R. § 70.6(a)(5), Reg.26.701(E), and Ark. Code Ann. § 8-4-203 as referenced by Ark. Code Ann. §§ 8-4-304 and 8-4-311]
10. The permittee must comply with all conditions of this Part 70 permit. Any permit noncompliance with applicable requirements as defined in Regulation 26 constitutes a violation of the Clean Air Act, as amended, 42 U.S.C. § 7401, *et seq.* and is grounds for enforcement action; for permit termination, revocation and reissuance, for permit modification; or for denial of a permit renewal application. [40 C.F.R. § 70.6(a)(6)(i) and Reg.26.701(F)(1)]
11. It shall not be a defense for a permittee in an enforcement action that it would have been necessary to halt or reduce the permitted activity to maintain compliance with the conditions of this permit. [40 C.F.R. § 70.6(a)(6)(ii) and Reg.26.701(F)(2)]
12. The Department may modify, revoke, reopen and reissue the permit or terminate the permit for cause. The filing of a request by the permittee for a permit modification, revocation and reissuance, termination, or of a notification of planned changes or anticipated noncompliance does not stay any permit condition. [40 C.F.R. § 70.6(a)(6)(iii) and Reg.26.701(F)(3)]
13. This permit does not convey any property rights of any sort, or any exclusive privilege. [40 C.F.R. § 70.6(a)(6)(iv) and Reg.26.701(F)(4)]

14. The permittee must furnish to the Director, within the time specified by the Director, any information that the Director may request in writing to determine whether cause exists for modifying, revoking and reissuing, or terminating the permit or to determine compliance with the permit. Upon request, the permittee must also furnish to the Director copies of records required by the permit. For information the permittee claims confidentiality, the Department may require the permittee to furnish such records directly to the Director along with a claim of confidentiality. [40 C.F.R. § 70.6(a)(6)(v) and Reg.26.701(F)(5)]
15. The permittee must pay all permit fees in accordance with the procedures established in Regulation 9. [40 C.F.R. § 70.6(a)(7) and Reg.26.701(G)]
16. No permit revision shall be required, under any approved economic incentives, marketable permits, emissions trading and other similar programs or processes for changes provided for elsewhere in this permit. [40 C.F.R. § 70.6(a)(8) and Reg.26.701(H)]
17. If the permit allows different operating scenarios, the permittee shall, contemporaneously with making a change from one operating scenario to another, record in a log at the permitted facility a record of the operational scenario. [40 C.F.R. § 70.6(a)(9)(i) and Reg.26.701(I)(1)]
18. The Administrator and citizens may enforce under the Act all terms and conditions in this permit, including any provisions designed to limit a source's potential to emit, unless the Department specifically designates terms and conditions of the permit as being federally unenforceable under the Act or under any of its applicable requirements. [40 C.F.R. § 70.6(b) and Reg.26.702(A) and (B)]
19. Any document (including reports) required by this permit pursuant to 40 C.F.R. § 70 must contain a certification by a responsible official as defined in Reg.26.2. [40 C.F.R. § 70.6(c)(1) and Reg.26.703(A)]
20. The permittee must allow an authorized representative of the Department, upon presentation of credentials, to perform the following: [40 C.F.R. § 70.6(c)(2) and Reg.26.703(B)]
 - a. Enter upon the permittee's premises where the permitted source is located or emissions related activity is conducted, or where records must be kept under the conditions of this permit;
 - b. Have access to and copy, at reasonable times, any records required under the conditions of this permit;
 - c. Inspect at reasonable times any facilities, equipment (including monitoring and air pollution control equipment), practices, or operations regulated or required under this permit; and
 - d. As authorized by the Act, sample or monitor at reasonable times substances or parameters for assuring compliance with this permit or applicable requirements.

21. The permittee shall submit a compliance certification with the terms and conditions contained in the permit, including emission limitations, standards, or work practices. The permittee must submit the compliance certification annually. If the permit establishes no other reporting period, the reporting period shall end on the last day of the anniversary month of the initial Title V permit. The report is due on the first day of the second month after the end of the reporting period. The permittee must also submit the compliance certification to the Administrator as well as to the Department. All compliance certifications required by this permit must include the following: [40 C.F.R. § 70.6(c)(5) and Reg.26.703(E)(3)]
 - a. The identification of each term or condition of the permit that is the basis of the certification;
 - b. The compliance status;
 - c. Whether compliance was continuous or intermittent;
 - d. The method(s) used for determining the compliance status of the source, currently and over the reporting period established by the monitoring requirements of this permit; and
 - e. Such other facts as the Department may require elsewhere in this permit or by § 114(a)(3) and § 504(b) of the Act.
22. Nothing in this permit will alter or affect the following: [Reg.26.704(C)]
 - a. The provisions of Section 303 of the Act (emergency orders), including the authority of the Administrator under that section;
 - b. The liability of the permittee for any violation of applicable requirements prior to or at the time of permit issuance;
 - c. The applicable requirements of the acid rain program, consistent with § 408(a) of the Act; or
 - d. The ability of EPA to obtain information from a source pursuant to § 114 of the Act.
23. This permit authorizes only those pollutant emitting activities addressed in this permit. [Ark. Code Ann. § 8-4-203 as referenced by Ark. Code Ann. §§ 8-4-304 and 8-4-311]
24. The permittee may request in writing and at least 15 days in advance of the deadline, an extension to any testing, compliance or other dates in this permit. No such extensions are authorized until the permittee receives written Department approval. The Department may grant such a request, at its discretion in the following circumstances:
 - a. Such an extension does not violate a federal requirement;
 - b. The permittee demonstrates the need for the extension; and
 - c. The permittee documents that all reasonable measures have been taken to meet the current deadline and documents reasons it cannot be met.

[Reg.18.314(A), Reg.19.416(A), Reg.26.1013(A), Ark. Code Ann. § 8-4-203 as referenced by Ark. Code Ann. §§ 8-4-304 and 8-4-311, and 40 C.F.R. § 52 Subpart E]

25. The permittee may request in writing and at least 30 days in advance, temporary emissions and/or testing that would otherwise exceed an emission rate, throughput requirement, or other limit in this permit. No such activities are authorized until the permittee receives written Department approval. Any such emissions shall be included in the facility's total emissions and reported as such. The Department may grant such a request, at its discretion under the following conditions:
- a. Such a request does not violate a federal requirement;
 - b. Such a request is temporary in nature;
 - c. Such a request will not result in a condition of air pollution;
 - d. The request contains such information necessary for the Department to evaluate the request, including but not limited to, quantification of such emissions and the date/time such emission will occur;
 - e. Such a request will result in increased emissions less than five tons of any individual criteria pollutant, one ton of any single HAP and 2.5 tons of total HAPs; and
 - f. The permittee maintains records of the dates and results of such temporary emissions/testing.

[Reg.18.314(B), Reg.19.416(B), Reg.26.1013(B), Ark. Code Ann. § 8-4-203 as referenced by Ark. Code Ann. §§ 8-4-304 and 8-4-311, and 40 C.F.R. § 52 Subpart E]

26. The permittee may request in writing and at least 30 days in advance, an alternative to the specified monitoring in this permit. No such alternatives are authorized until the permittee receives written Department approval. The Department may grant such a request, at its discretion under the following conditions:
- d. The request does not violate a federal requirement;
 - e. The request provides an equivalent or greater degree of actual monitoring to the current requirements; and
 - f. Any such request, if approved, is incorporated in the next permit modification application by the permittee.

[Reg.18.314(C), Reg.19.416(C), Reg.26.1013(C), Ark. Code Ann. § 8-4-203 as referenced by Ark. Code Ann. §§ 8-4-304 and 8-4-311, and 40 C.F.R. § 52 Subpart E]

27. Any credible evidence based on sampling, monitoring, and reporting may be used to determine violations of applicable emission limitations. [Reg.18.1001, Reg.19.701, Ark. Code Ann. § 8-4-203 as referenced by Ark. Code Ann. §§ 8-4-304 and 8-4-311, and 40 C.F.R. § 52 Subpart E]

Appendix A – 40 CFR Part 60, Subpart Dc

ELECTRONIC CODE OF FEDERAL REGULATIONS

e-CFR Data is current as of August 30, 2013

Title 40: Protection of Environment

[PART 60—STANDARDS OF PERFORMANCE FOR NEW STATIONARY SOURCES](#)

Subpart **Dc**—Standards of Performance for Small Industrial-Commercial-Institutional Steam Generating Units

Contents

- [§ 60.40c](#) Applicability and delegation of authority.
 - [§ 60.41c](#) Definitions.
 - [§ 60.42c](#) Standard for sulfur dioxide (SO₂).
 - [§ 60.43c](#) Standard for particulate matter (PM).
 - [§ 60.44c](#) Compliance and performance test methods and procedures for sulfur dioxide.
 - [§ 60.45c](#) Compliance and performance test methods and procedures for particulate matter.
 - [§ 60.46c](#) Emission monitoring for sulfur dioxide.
 - [§ 60.47c](#) Emission monitoring for particulate matter.
 - [§ 60.48c](#) Reporting and recordkeeping requirements.
-

SOURCE: 72 FR 32759, June 13, 2007, unless otherwise noted.

§ 60.40c Applicability and delegation of authority.

(a) Except as provided in paragraphs (d), (e), (f), and (g) of this section, the affected facility to which this subpart applies is each steam generating unit for which construction, modification, or reconstruction is commenced after June 9, 1989 and that has a maximum design heat input capacity of 29 megawatts (MW) (100 million British thermal units per hour (MMBtu/h)) or less, but greater than or equal to 2.9 MW (10 MMBtu/h).

(b) In delegating implementation and enforcement authority to a State under section 111(c) of the Clean Air Act, § 60.48c(a)(4) shall be retained by the Administrator and not transferred to a State.

(c) Steam generating units that meet the applicability requirements in paragraph (a) of this section are not subject to the sulfur dioxide (SO₂) or particulate matter (PM) emission limits, performance testing requirements, or monitoring requirements under this subpart (§§ 60.42c, 60.43c, 60.44c, 60.45c, 60.46c, or 60.47c) during periods of combustion research, as defined in § 60.41c.

(d) Any temporary change to an existing steam generating unit for the purpose of conducting combustion research is not considered a modification under § 60.14.

(e) Affected facilities (*i.e.* heat recovery steam generators and fuel heaters) that are associated with stationary combustion turbines and meet the applicability requirements of subpart KKKK of this part are not subject to this subpart. This subpart will continue to apply to all other heat recovery steam generators, fuel heaters, and other affected facilities that are capable of combusting more than or equal to 2.9 MW (10 MMBtu/h) heat input of fossil fuel but less than or equal to 29 MW (100 MMBtu/h) heat input of fossil fuel. If the heat recovery steam generator, fuel heater, or other affected facility is subject to this subpart, only emissions resulting from combustion of fuels in the steam generating unit are subject to this subpart. (The stationary combustion turbine emissions are subject to subpart GG or KKKK, as applicable, of this part.)

(f) Any affected facility that meets the applicability requirements of and is subject to subpart AAAA or subpart CCCC of this part is not subject to this subpart.

(g) Any facility that meets the applicability requirements and is subject to an EPA approved State or Federal section 111(d)/129 plan implementing subpart BBBB of this part is not subject to this subpart.

(h) Affected facilities that also meet the applicability requirements under subpart J or subpart Ja of this part are subject to the PM and NO_x standards under this subpart and the SO₂ standards under subpart J or subpart Ja of this part, as applicable.

(i) Temporary boilers are not subject to this subpart.

[72 FR 32759, June 13, 2007, as amended at 74 FR 5090, Jan. 28, 2009; 77 FR 9461, Feb. 16, 2012]

§ 60.41c Definitions.

As used in this subpart, all terms not defined herein shall have the meaning given them in the Clean Air Act and in subpart A of this part.

Annual capacity factor means the ratio between the actual heat input to a steam generating unit from an individual fuel or combination of fuels during a period of 12 consecutive calendar months and the potential heat input to the steam generating unit from all fuels had the steam generating unit been operated for 8,760 hours during that 12-month period at the maximum design heat input capacity. In the case of steam generating units that are rented or leased, the actual heat input shall be determined based on the combined heat input from all operations of the affected facility during a period of 12 consecutive calendar months.

Coal means all solid fuels classified as anthracite, bituminous, subbituminous, or lignite by the American Society of Testing and Materials in ASTM D388 (incorporated by reference, see § 60.17), coal refuse, and petroleum coke. Coal-derived synthetic fuels derived from coal for the purposes of creating useful heat, including but not limited to solvent refined coal, gasified coal not meeting the definition of natural gas, coal-oil mixtures, and coal-water mixtures, are also included in this definition for the purposes of this subpart.

Coal refuse means any by-product of coal mining or coal cleaning operations with an ash content greater than 50 percent (by weight) and a heating value less than 13,900 kilojoules per kilogram (kJ/kg) (6,000 Btu per pound (Btu/lb) on a dry basis.

Combined cycle system means a system in which a separate source (such as a stationary gas turbine, internal combustion engine, or kiln) provides exhaust gas to a steam generating unit.

Combustion research means the experimental firing of any fuel or combination of fuels in a steam generating unit for the purpose of conducting research and development of more efficient combustion or more effective prevention or control of air pollutant emissions from combustion, provided that, during these periods of research and development, the heat generated is not used for any purpose other than preheating combustion air for use by that steam generating unit (*i.e.* , the heat generated is released to the atmosphere without being used for space heating, process heating, driving pumps, preheating combustion air for other units, generating electricity, or any other purpose).

Conventional technology means wet flue gas desulfurization technology, dry flue gas desulfurization technology, atmospheric fluidized bed combustion technology, and oil hydrodesulfurization technology.

Distillate oil means fuel oil that complies with the specifications for fuel oil numbers 1 or 2, as defined by the American Society for Testing and Materials in ASTM D396 (incorporated by reference, see § 60.17), diesel fuel oil numbers 1 or 2, as defined by the American Society for Testing and Materials in ASTM D975 (incorporated by reference, see § 60.17), kerosine, as defined by the American Society of Testing and Materials in ASTM D3699 (incorporated by reference, see § 60.17),

biodiesel as defined by the American Society of Testing and Materials in ASTM D6751 (incorporated by reference, see § 60.17), or biodiesel blends as defined by the American Society of Testing and Materials in ASTM D7467 (incorporated by reference, see § 60.17).

Dry flue gas desulfurization technology means a SO₂ control system that is located between the steam generating unit and the exhaust vent or stack, and that removes sulfur oxides from the combustion gases of the steam generating unit by contacting the combustion gases with an alkaline reagent and water, whether introduced separately or as a premixed slurry or solution and forming a dry powder material. This definition includes devices where the dry powder material is subsequently converted to another form. Alkaline reagents used in dry flue gas desulfurization systems include, but are not limited to, lime and sodium compounds.

Duct burner means a device that combusts fuel and that is placed in the exhaust duct from another source (such as a stationary gas turbine, internal combustion engine, kiln, etc.) to allow the firing of additional fuel to heat the exhaust gases before the exhaust gases enter a steam generating unit.

Emerging technology means any SO₂ control system that is not defined as a conventional technology under this section, and for which the owner or operator of the affected facility has received approval from the Administrator to operate as an emerging technology under § 60.48c(a)(4).

Federally enforceable means all limitations and conditions that are enforceable by the Administrator, including the requirements of 40 CFR parts 60 and 61, requirements within any applicable State implementation plan, and any permit requirements established under 40 CFR 52.21 or under 40 CFR 51.18 and 51.24.

Fluidized bed combustion technology means a device wherein fuel is distributed onto a bed (or series of beds) of limestone aggregate (or other sorbent materials) for combustion; and these materials are forced upward in the device by the flow of combustion air and the gaseous products of combustion. Fluidized bed combustion technology includes, but is not limited to, bubbling bed units and circulating bed units.

Fuel pretreatment means a process that removes a portion of the sulfur in a fuel before combustion of the fuel in a steam generating unit.

Heat input means heat derived from combustion of fuel in a steam generating unit and does not include the heat derived from preheated combustion air, recirculated flue gases, or exhaust gases from other sources (such as stationary gas turbines, internal combustion engines, and kilns).

Heat transfer medium means any material that is used to transfer heat from one point to another point.

Maximum design heat input capacity means the ability of a steam generating unit to combust a stated maximum amount of fuel (or combination of fuels) on a steady state basis as determined by the physical design and characteristics of the steam generating unit.

Natural gas means:

(1) A naturally occurring mixture of hydrocarbon and nonhydrocarbon gases found in geologic formations beneath the earth's surface, of which the principal constituent is methane; or

(2) Liquefied petroleum (LP) gas, as defined by the American Society for Testing and Materials in ASTM D1835 (incorporated by reference, see § 60.17); or

(3) A mixture of hydrocarbons that maintains a gaseous state at ISO conditions. Additionally, natural gas must either be composed of at least 70 percent methane by volume or have a gross calorific value between 34 and 43 megajoules (MJ) per dry standard cubic meter (910 and 1,150 Btu per dry standard cubic foot).

Noncontinental area means the State of Hawaii, the Virgin Islands, Guam, American Samoa, the Commonwealth of Puerto Rico, or the Northern Mariana Islands.

Oil means crude oil or petroleum, or a liquid fuel derived from crude oil or petroleum, including distillate oil and residual oil.

Potential sulfur dioxide emission rate means the theoretical SO₂ emissions (nanograms per joule (ng/J) or lb/MMBtu heat input) that would result from combusting fuel in an uncleaned state and without using emission control systems.

Process heater means a device that is primarily used to heat a material to initiate or promote a chemical reaction in which the material participates as a reactant or catalyst.

Residual oil means crude oil, fuel oil that does not comply with the specifications under the definition of distillate oil, and all fuel oil numbers 4, 5, and 6, as defined by the American Society for Testing and Materials in ASTM D396 (incorporated by reference, see § 60.17).

Steam generating unit means a device that combusts any fuel and produces steam or heats water or heats any heat transfer medium. This term includes any duct burner that combusts fuel and is part of a combined cycle system. This term does not include process heaters as defined in this subpart.

Steam generating unit operating day means a 24-hour period between 12:00 midnight and the following midnight during which any fuel is combusted at any time in the steam generating unit. It is not necessary for fuel to be combusted continuously for the entire 24-hour period.

Temporary boiler means a steam generating unit that combusts natural gas or distillate oil with a potential SO₂ emissions rate no greater than 26 ng/J (0.060 lb/MMBtu), and the unit is designed to, and is capable of, being carried or moved from one location to another by means of, for example, wheels, skids, carrying handles, dollies, trailers, or platforms. A steam generating unit is not a temporary boiler if any one of the following conditions exists:

- (1) The equipment is attached to a foundation.
- (2) The steam generating unit or a replacement remains at a location for more than 180 consecutive days. Any temporary boiler that replaces a temporary boiler at a location and performs the same or similar function will be included in calculating the consecutive time period.
- (3) The equipment is located at a seasonal facility and operates during the full annual operating period of the seasonal facility, remains at the facility for at least 2 years, and operates at that facility for at least 3 months each year.
- (4) The equipment is moved from one location to another in an attempt to circumvent the residence time requirements of this definition.

Wet flue gas desulfurization technology means an SO₂ control system that is located between the steam generating unit and the exhaust vent or stack, and that removes sulfur oxides from the combustion gases of the steam generating unit by contacting the combustion gases with an alkaline slurry or solution and forming a liquid material. This definition includes devices where the liquid material is subsequently converted to another form. Alkaline reagents used in wet flue gas desulfurization systems include, but are not limited to, lime, limestone, and sodium compounds.

Wet scrubber system means any emission control device that mixes an aqueous stream or slurry with the exhaust gases from a steam generating unit to control emissions of PM or SO₂.

Wood means wood, wood residue, bark, or any derivative fuel or residue thereof, in any form, including but not limited to sawdust, sanderdust, wood chips, scraps, slabs, millings, shavings, and processed pellets made from wood or other forest residues.

[72 FR 32759, June 13, 2007, as amended at 74 FR 5090, Jan. 28, 2009; 77 FR 9461, Feb. 16, 2012]

§ 60.42c Standard for sulfur dioxide (SO₂).

(a) Except as provided in paragraphs (b), (c), and (e) of this section, on and after the date on which the performance test is completed or required to be completed under § 60.8, whichever date comes first, the owner or operator of an affected facility that combusts only coal shall neither: cause to be discharged into the atmosphere from the affected facility any gases that contain SO₂ in excess of 87 ng/J (0.20 lb/MMBtu) heat input or 10 percent (0.10) of the potential SO₂ emission rate (90 percent reduction), nor cause to be discharged into the atmosphere from the affected facility any gases that contain SO₂ in excess of 520 ng/J (1.2 lb/MMBtu) heat input. If coal is combusted with other fuels, the affected facility shall neither: cause to be discharged into the atmosphere from the affected facility any gases that contain SO₂ in excess of 87 ng/J (0.20 lb/MMBtu) heat input or 10 percent (0.10) of the potential SO₂ emission rate (90 percent reduction), nor cause to be discharged into the atmosphere from the affected facility any gases that contain SO₂ in excess of the emission limit is determined pursuant to paragraph (e)(2) of this section.

(b) Except as provided in paragraphs (c) and (e) of this section, on and after the date on which the performance test is completed or required to be completed under § 60.8, whichever date comes first, the owner or operator of an affected facility that:

(1) Combusts only coal refuse alone in a fluidized bed combustion steam generating unit shall neither:

(i) Cause to be discharged into the atmosphere from that affected facility any gases that contain SO₂ in excess of 87 ng/J (0.20 lb/MMBtu) heat input or 20 percent (0.20) of the potential SO₂ emission rate (80 percent reduction); nor

(ii) Cause to be discharged into the atmosphere from that affected facility any gases that contain SO₂ in excess of SO₂ in excess of 520 ng/J (1.2 lb/MMBtu) heat input. If coal is fired with coal refuse, the affected facility subject to paragraph (a) of this section. If oil or any other fuel (except coal) is fired with coal refuse, the affected facility is subject to the 87 ng/J (0.20 lb/MMBtu) heat input SO₂ emissions limit or the 90 percent SO₂ reduction requirement specified in paragraph (a) of this section and the emission limit is determined pursuant to paragraph (e)(2) of this section.

(2) Combusts only coal and that uses an emerging technology for the control of SO₂ emissions shall neither:

(i) Cause to be discharged into the atmosphere from that affected facility any gases that contain SO₂ in excess of 50 percent (0.50) of the potential SO₂ emission rate (50 percent reduction); nor

(ii) Cause to be discharged into the atmosphere from that affected facility any gases that contain SO₂ in excess of 260 ng/J (0.60 lb/MMBtu) heat input. If coal is combusted with other fuels, the affected facility is subject to the 50 percent SO₂ reduction requirement specified in this paragraph and the emission limit determined pursuant to paragraph (e)(2) of this section.

(c) On and after the date on which the initial performance test is completed or required to be completed under § 60.8, whichever date comes first, no owner or operator of an affected facility that combusts coal, alone or in combination with any other fuel, and is listed in paragraphs (c)(1), (2), (3), or (4) of this section shall cause to be discharged into the atmosphere from that affected facility any gases that contain SO₂ in excess of the emission limit determined pursuant to paragraph (e)(2) of this section. Percent reduction requirements are not applicable to affected facilities under paragraphs (c) (1), (2), (3), or (4).

(1) Affected facilities that have a heat input capacity of 22 MW (75 MMBtu/h) or less;

(2) Affected facilities that have an annual capacity for coal of 55 percent (0.55) or less and are subject to a federally enforceable requirement limiting operation of the affected facility to an annual capacity factor for coal of 55 percent (0.55) or less.

(3) Affected facilities located in a noncontinental area; or

(4) Affected facilities that combust coal in a duct burner as part of a combined cycle system where 30 percent (0.30) or less of the heat entering the steam generating unit is from combustion of coal in the duct burner and 70 percent (0.70) or more of the heat entering the steam generating unit is from exhaust gases entering the duct burner.

(d) On and after the date on which the initial performance test is completed or required to be completed under § 60.8, whichever date comes first, no owner or operator of an affected facility that combusts oil shall cause to be discharged into the atmosphere from that affected facility any gases that contain SO₂ in excess of 215 ng/J (0.50 lb/MMBtu) heat input from oil; or, as an alternative, no owner or operator of an affected facility that combusts oil shall combust oil in the affected facility that contains greater than 0.5 weight percent sulfur. The percent reduction requirements are not applicable to affected facilities under this paragraph.

(e) On and after the date on which the initial performance test is completed or required to be completed under § 60.8, whichever date comes first, no owner or operator of an affected facility that combusts coal, oil, or coal and oil with any other fuel shall cause to be discharged into the atmosphere from that affected facility any gases that contain SO₂ in excess of the following:

(1) The percent of potential SO₂ emission rate or numerical SO₂ emission rate required under paragraph (a) or (b)(2) of this section, as applicable, for any affected facility that

- (i) Combusts coal in combination with any other fuel;
- (ii) Has a heat input capacity greater than 22 MW (75 MMBtu/h); and
- (iii) Has an annual capacity factor for coal greater than 55 percent (0.55); and

(2) The emission limit determined according to the following formula for any affected facility that combusts coal, oil, or coal and oil with any other fuel:

$$E_s = \frac{(K_a H_a + K_b H_b + K_c H_c)}{(H_a + H_b + H_c)}$$

Where:

E_s = SO₂ emission limit, expressed in ng/J or lb/MMBtu heat input;

K_a = 520 ng/J (1.2 lb/MMBtu);

K_b = 260 ng/J (0.60 lb/MMBtu);

K_c = 215 ng/J (0.50 lb/MMBtu);

H_a = Heat input from the combustion of coal, except coal combusted in an affected facility subject to paragraph (b)(2) of this section, in Joules (J) [MMBtu];

H_b = Heat input from the combustion of coal in an affected facility subject to paragraph (b)(2) of this section, in J (MMBtu); and

H_c = Heat input from the combustion of oil, in J (MMBtu).

(f) Reduction in the potential SO₂ emission rate through fuel pretreatment is not credited toward the percent reduction requirement under paragraph (b)(2) of this section unless:

(1) Fuel pretreatment results in a 50 percent (0.50) or greater reduction in the potential SO₂ emission rate; and

(2) Emissions from the pretreated fuel (without either combustion or post-combustion SO₂ control) are equal to or less than the emission limits specified under paragraph (b)(2) of this section.

(g) Except as provided in paragraph (h) of this section, compliance with the percent reduction requirements, fuel oil sulfur limits, and emission limits of this section shall be determined on a 30-day rolling average basis.

(h) For affected facilities listed under paragraphs (h)(1), (2), (3), or (4) of this section, compliance with the emission limits or fuel oil sulfur limits under this section may be determined based on a certification from the fuel supplier, as described under § 60.48c(f), as applicable.

(1) Distillate oil-fired affected facilities with heat input capacities between 2.9 and 29 MW (10 and 100 MMBtu/hr).

(2) Residual oil-fired affected facilities with heat input capacities between 2.9 and 8.7 MW (10 and 30 MMBtu/hr).

(3) Coal-fired affected facilities with heat input capacities between 2.9 and 8.7 MW (10 and 30 MMBtu/h).

(4) Other fuels-fired affected facilities with heat input capacities between 2.9 and 8.7 MW (10 and 30 MMBtu/h).

(i) The SO₂ emission limits, fuel oil sulfur limits, and percent reduction requirements under this section apply at all times, including periods of startup, shutdown, and malfunction.

(j) For affected facilities located in noncontinental areas and affected facilities complying with the percent reduction standard, only the heat input supplied to the affected facility from the combustion of coal and oil is counted under this section. No credit is provided for the heat input to the affected facility from wood or other fuels or for heat derived from exhaust gases from other sources, such as stationary gas turbines, internal combustion engines, and kilns.

[72 FR 32759, June 13, 2007, as amended at 74 FR 5090, Jan. 28, 2009; 77 FR 9462, Feb. 16, 2012]

§ 60.43c Standard for particulate matter (PM).

(a) On and after the date on which the initial performance test is completed or required to be completed under § 60.8, whichever date comes first, no owner or operator of an affected facility that commenced construction, reconstruction, or modification on or before February 28, 2005, that combusts coal or combusts mixtures of coal with other fuels and has a heat input capacity of 8.7 MW (30 MMBtu/h) or greater, shall cause to be discharged into the atmosphere from that affected facility any gases that contain PM in excess of the following emission limits:

(1) 22 ng/J (0.051 lb/MMBtu) heat input if the affected facility combusts only coal, or combusts coal with other fuels and has an annual capacity factor for the other fuels of 10 percent (0.10) or less.

(2) 43 ng/J (0.10 lb/MMBtu) heat input if the affected facility combusts coal with other fuels, has an annual capacity factor for the other fuels greater than 10 percent (0.10), and is subject to a federally enforceable requirement limiting operation of the affected facility to an annual capacity factor greater than 10 percent (0.10) for fuels other than coal.

(b) On and after the date on which the initial performance test is completed or required to be completed under § 60.8, whichever date comes first, no owner or operator of an affected facility that commenced construction, reconstruction, or modification on or before February 28, 2005, that combusts wood or combusts mixtures of wood with other fuels (except coal) and has a heat input capacity of 8.7 MW (30 MMBtu/h) or greater, shall cause to be discharged into the atmosphere from that affected facility any gases that contain PM in excess of the following emissions limits:

(1) 43 ng/J (0.10 lb/MMBtu) heat input if the affected facility has an annual capacity factor for wood greater than 30 percent (0.30); or

(2) 130 ng/J (0.30 lb/MMBtu) heat input if the affected facility has an annual capacity factor for wood of 30 percent (0.30) or less and is subject to a federally enforceable requirement limiting operation of the affected facility to an annual capacity factor for wood of 30 percent (0.30) or less.

(c) On and after the date on which the initial performance test is completed or required to be completed under § 60.8, whichever date comes first, no owner or operator of an affected facility that combusts coal, wood, or oil and has a heat input capacity of 8.7 MW (30 MMBtu/h) or greater shall cause to be discharged into the atmosphere from that affected facility any gases that exhibit greater than 20 percent opacity (6-minute average), except for one 6-minute period per hour of not more than 27 percent opacity. Owners and operators of an affected facility that elect to install, calibrate, maintain, and operate a continuous emissions monitoring system (CEMS) for measuring PM emissions according to the requirements of this subpart and are subject to a federally enforceable PM limit of 0.030 lb/MMBtu or less are exempt from the opacity standard specified in this paragraph (c).

(d) The PM and opacity standards under this section apply at all times, except during periods of startup, shutdown, or malfunction.

(e)(1) On and after the date on which the initial performance test is completed or is required to be completed under § 60.8, whichever date comes first, no owner or operator of an affected facility that commences construction, reconstruction, or modification after February 28, 2005, and that combusts coal, oil, wood, a mixture of these fuels, or a mixture of these fuels with any other fuels and has a heat input capacity of 8.7 MW (30 MMBtu/h) or greater shall cause to be discharged into the atmosphere from that affected facility any gases that contain PM in excess of 13 ng/J (0.030 lb/MMBtu) heat input, except as provided in paragraphs (e)(2), (e)(3), and (e)(4) of this section.

(2) As an alternative to meeting the requirements of paragraph (e)(1) of this section, the owner or operator of an affected facility for which modification commenced after February 28, 2005, may elect to meet the requirements of this paragraph. On and after the date on which the initial performance test is completed or required to be completed under § 60.8, whichever date comes first, no owner or operator of an affected facility that commences modification after February 28, 2005 shall cause to be discharged into the atmosphere from that affected facility any gases that contain PM in excess of both:

(i) 22 ng/J (0.051 lb/MMBtu) heat input derived from the combustion of coal, oil, wood, a mixture of these fuels, or a mixture of these fuels with any other fuels; and

(ii) 0.2 percent of the combustion concentration (99.8 percent reduction) when combusting coal, oil, wood, a mixture of these fuels, or a mixture of these fuels with any other fuels.

(3) On and after the date on which the initial performance test is completed or is required to be completed under § 60.8, whichever date comes first, no owner or operator of an affected facility that commences modification after February 28, 2005, and that combusts over 30 percent wood (by heat input) on an annual basis and has a heat input capacity of 8.7 MW (30 MMBtu/h) or greater shall cause to be discharged into the atmosphere from that affected facility any gases that contain PM in excess of 43 ng/J (0.10 lb/MMBtu) heat input.

(4) An owner or operator of an affected facility that commences construction, reconstruction, or modification after February 28, 2005, and that combusts only oil that contains no more than 0.50 weight percent sulfur or a mixture of 0.50 weight percent sulfur oil with other fuels not subject to a PM standard under § 60.43c and not using a post-combustion technology (except a wet scrubber) to reduce PM or SO₂ emissions is not subject to the PM limit in this section.

[72 FR 32759, June 13, 2007, as amended at 74 FR 5091, Jan. 28, 2009; 77 FR 9462, Feb. 16, 2012]

§ 60.44c Compliance and performance test methods and procedures for sulfur dioxide.

(a) Except as provided in paragraphs (g) and (h) of this section and § 60.8(b), performance tests required under § 60.8 shall be conducted following the procedures specified in paragraphs (b), (c), (d), (e), and (f) of this section, as applicable. Section 60.8(f) does not apply to this section. The 30-day

notice required in § 60.8(d) applies only to the initial performance test unless otherwise specified by the Administrator.

(b) The initial performance test required under § 60.8 shall be conducted over 30 consecutive operating days of the steam generating unit. Compliance with the percent reduction requirements and SO₂ emission limits under § 60.42c shall be determined using a 30-day average. The first operating day included in the initial performance test shall be scheduled within 30 days after achieving the maximum production rate at which the affected facility will be operated, but not later than 180 days after the initial startup of the facility. The steam generating unit load during the 30-day period does not have to be the maximum design heat input capacity, but must be representative of future operating conditions.

(c) After the initial performance test required under paragraph (b) of this section and § 60.8, compliance with the percent reduction requirements and SO₂ emission limits under § 60.42c is based on the average percent reduction and the average SO₂ emission rates for 30 consecutive steam generating unit operating days. A separate performance test is completed at the end of each steam generating unit operating day, and a new 30-day average percent reduction and SO₂ emission rate are calculated to show compliance with the standard.

(d) If only coal, only oil, or a mixture of coal and oil is combusted in an affected facility, the procedures in Method 19 of appendix A of this part are used to determine the hourly SO₂ emission rate (E_{ho}) and the 30-day average SO₂ emission rate (E_{ao}). The hourly averages used to compute the 30-day averages are obtained from the CEMS. Method 19 of appendix A of this part shall be used to calculate E_{ao} when using daily fuel sampling or Method 6B of appendix A of this part.

(e) If coal, oil, or coal and oil are combusted with other fuels:

(1) An adjusted E_{ho} ($E_{ho o}$) is used in Equation 19-19 of Method 19 of appendix A of this part to compute the adjusted E_{ao} ($E_{ao o}$). The $E_{ho o}$ is computed using the following formula:

$$E_{ho o} = \frac{E_w - E_w(1 - X_k)}{X_k}$$

Where:

$E_{ho o}$ = Adjusted E_{ho} , ng/J (lb/MMBtu);

E_{ho} = Hourly SO₂ emission rate, ng/J (lb/MMBtu);

E_w = SO₂ concentration in fuels other than coal and oil combusted in the affected facility, as determined by fuel sampling and analysis procedures in Method 9 of appendix A of this part, ng/J (lb/MMBtu). The value E_w for each fuel lot is used for each hourly average during the time that the lot is being combusted. The owner or operator does not have to measure E_w if the owner or operator elects to assume $E_w = 0$.

X_k = Fraction of the total heat input from fuel combustion derived from coal and oil, as determined by applicable procedures in Method 19 of appendix A of this part.

(2) The owner or operator of an affected facility that qualifies under the provisions of § 60.42c(c) or (d) (where percent reduction is not required) does not have to measure the parameters E_w or X_k if the owner or operator of the affected facility elects to measure emission rates of the coal or oil using the fuel sampling and analysis procedures under Method 19 of appendix A of this part.

(f) Affected facilities subject to the percent reduction requirements under § 60.42c(a) or (b) shall determine compliance with the SO₂ emission limits under § 60.42c pursuant to paragraphs (d) or (e) of this section, and shall determine compliance with the percent reduction requirements using the following procedures:

(1) If only coal is combusted, the percent of potential SO₂ emission rate is computed using the following formula:

$$\%P_s = 100 \left(1 - \frac{\%R_g}{100} \right) \left(1 - \frac{\%R_f}{100} \right)$$

Where:

$\%P_s$ = Potential SO₂ emission rate, in percent;

$\%R_g$ = SO₂ removal efficiency of the control device as determined by Method 19 of appendix A of this part, in percent; and

$\%R_f$ = SO₂ removal efficiency of fuel pretreatment as determined by Method 19 of appendix A of this part, in percent.

(2) If coal, oil, or coal and oil are combusted with other fuels, the same procedures required in paragraph (f)(1) of this section are used, except as provided for in the following:

(i) To compute the $\%P_s$, an adjusted $\%R_g$ ($\%R_{g\ o}$) is computed from $E_{a\ o}$ from paragraph (e)(1) of this section and an adjusted average SO₂ inlet rate ($E_{a\ i\ o}$) using the following formula:

$$\%R_{g\ o} = 100 \left(1 - \frac{E_{a\ o}}{E_{a\ i\ o}} \right)$$

Where:

$\%R_{g\ o}$ = Adjusted $\%R_g$, in percent;

$E_{a\ o}$ = Adjusted $E_{a\ o}$, ng/J (lb/MMBtu); and

$E_{a\ i\ o}$ = Adjusted average SO₂ inlet rate, ng/J (lb/MMBtu).

(ii) To compute $E_{a\ i\ o}$, an adjusted hourly SO₂ inlet rate ($E_{h\ i\ o}$) is used. The $E_{h\ i\ o}$ is computed using the following formula:

$$E_{h\ i\ o} = \frac{E_{h\ i} - E_w(1 - X_k)}{X_k}$$

Where:

$E_{h\ i\ o}$ = Adjusted $E_{h\ i}$, ng/J (lb/MMBtu);

$E_{h\ i}$ = Hourly SO₂ inlet rate, ng/J (lb/MMBtu);

E_w = SO₂ concentration in fuels other than coal and oil combusted in the affected facility, as determined by fuel sampling and analysis procedures in Method 19 of appendix A of this part, ng/J (lb/MMBtu). The value E_w for each fuel lot is used for each hourly average during the time that the lot is being combusted. The owner or operator does not have to measure E_w if the owner or operator elects to assume $E_w = 0$; and

X_k = Fraction of the total heat input from fuel combustion derived from coal and oil, as determined by applicable procedures in Method 19 of appendix A of this part.

(g) For oil-fired affected facilities where the owner or operator seeks to demonstrate compliance with the fuel oil sulfur limits under § 60.42c based on shipment fuel sampling, the initial performance test shall consist of sampling and analyzing the oil in the initial tank of oil to be fired in the steam generating unit to demonstrate that the oil contains 0.5 weight percent sulfur or less. Thereafter, the owner or operator of the affected facility shall sample the oil in the fuel tank after each new shipment of oil is received, as described under § 60.46c(d)(2).

(h) For affected facilities subject to § 60.42c(h)(1), (2), or (3) where the owner or operator seeks to demonstrate compliance with the SO₂ standards based on fuel supplier certification, the performance test shall consist of the certification from the fuel supplier, as described in § 60.48c(f), as applicable.

(i) The owner or operator of an affected facility seeking to demonstrate compliance with the SO₂ standards under § 60.42c(c)(2) shall demonstrate the maximum design heat input capacity of the steam generating unit by operating the steam generating unit at this capacity for 24 hours. This demonstration shall be made during the initial performance test, and a subsequent demonstration may be requested at any other time. If the demonstrated 24-hour average firing rate for the affected facility is less than the maximum design heat input capacity stated by the manufacturer of the affected facility, the demonstrated 24-hour average firing rate shall be used to determine the annual capacity factor for the affected facility; otherwise, the maximum design heat input capacity provided by the manufacturer shall be used.

(j) The owner or operator of an affected facility shall use all valid SO₂ emissions data in calculating %P_s and E_{ho} under paragraphs (d), (e), or (f) of this section, as applicable, whether or not the minimum emissions data requirements under § 60.46c(f) are achieved. All valid emissions data, including valid data collected during periods of startup, shutdown, and malfunction, shall be used in calculating %P_s or E_{ho} pursuant to paragraphs (d), (e), or (f) of this section, as applicable.

[72 FR 32759, June 13, 2007, as amended at 74 FR 5091, Jan. 28, 2009]

§ 60.45c Compliance and performance test methods and procedures for particulate matter.

(a) The owner or operator of an affected facility subject to the PM and/or opacity standards under § 60.43c shall conduct an initial performance test as required under § 60.8, and shall conduct subsequent performance tests as requested by the Administrator, to determine compliance with the standards using the following procedures and reference methods, except as specified in paragraph (c) of this section.

(1) Method 1 of appendix A of this part shall be used to select the sampling site and the number of traverse sampling points.

(2) Method 3A or 3B of appendix A-2 of this part shall be used for gas analysis when applying Method 5 or 5B of appendix A-3 of this part or 17 of appendix A-6 of this part.

(3) Method 5, 5B, or 17 of appendix A of this part shall be used to measure the concentration of PM as follows:

(i) Method 5 of appendix A of this part may be used only at affected facilities without wet scrubber systems.

(ii) Method 17 of appendix A of this part may be used at affected facilities with or without wet scrubber systems provided the stack gas temperature does not exceed a temperature of 160 °C (320 °F). The procedures of Sections 8.1 and 11.1 of Method 5B of appendix A of this part may be used in Method 17 of appendix A of this part only if Method 17 of appendix A of this part is used in conjunction with a wet scrubber system. Method 17 of appendix A of this part shall not be used in conjunction with a wet scrubber system if the effluent is saturated or laden with water droplets.

(iii) Method 5B of appendix A of this part may be used in conjunction with a wet scrubber system.

(4) The sampling time for each run shall be at least 120 minutes and the minimum sampling volume shall be 1.7 dry standard cubic meters (dscm) [60 dry standard cubic feet (dscf)] except that smaller sampling times or volumes may be approved by the Administrator when necessitated by process variables or other factors.

(5) For Method 5 or 5B of appendix A of this part, the temperature of the sample gas in the probe and filter holder shall be monitored and maintained at 160 ±14 °C (320±25 °F).

(6) For determination of PM emissions, an oxygen (O₂) or carbon dioxide (CO₂) measurement shall be obtained simultaneously with each run of Method 5, 5B, or 17 of appendix A of this part by traversing the duct at the same sampling location.

(7) For each run using Method 5, 5B, or 17 of appendix A of this part, the emission rates expressed in ng/J (lb/MMBtu) heat input shall be determined using:

(i) The O₂ or CO₂ measurements and PM measurements obtained under this section, (ii) The dry basis F factor, and

(iii) The dry basis emission rate calculation procedure contained in Method 19 of appendix A of this part.

(8) Method 9 of appendix A-4 of this part shall be used for determining the opacity of stack emissions.

(b) The owner or operator of an affected facility seeking to demonstrate compliance with the PM standards under § 60.43c(b)(2) shall demonstrate the maximum design heat input capacity of the steam generating unit by operating the steam generating unit at this capacity for 24 hours. This demonstration shall be made during the initial performance test, and a subsequent demonstration may be requested at any other time. If the demonstrated 24-hour average firing rate for the affected facility is less than the maximum design heat input capacity stated by the manufacturer of the affected facility, the demonstrated 24-hour average firing rate shall be used to determine the annual capacity factor for the affected facility; otherwise, the maximum design heat input capacity provided by the manufacturer shall be used.

(c) In place of PM testing with Method 5 or 5B of appendix A-3 of this part or Method 17 of appendix A-6 of this part, an owner or operator may elect to install, calibrate, maintain, and operate a CEMS for monitoring PM emissions discharged to the atmosphere and record the output of the system. The owner or operator of an affected facility who elects to continuously monitor PM emissions instead of conducting performance testing using Method 5 or 5B of appendix A-3 of this part or Method 17 of appendix A-6 of this part shall install, calibrate, maintain, and operate a CEMS and shall comply with the requirements specified in paragraphs (c)(1) through (c)(14) of this section.

(1) Notify the Administrator 1 month before starting use of the system.

(2) Notify the Administrator 1 month before stopping use of the system.

(3) The monitor shall be installed, evaluated, and operated in accordance with § 60.13 of subpart A of this part.

(4) The initial performance evaluation shall be completed no later than 180 days after the date of initial startup of the affected facility, as specified under § 60.8 of subpart A of this part or within 180 days of notification to the Administrator of use of CEMS if the owner or operator was previously determining compliance by Method 5, 5B, or 17 of appendix A of this part performance tests, whichever is later.

(5) The owner or operator of an affected facility shall conduct an initial performance test for PM emissions as required under § 60.8 of subpart A of this part. Compliance with the PM emission limit shall be determined by using the CEMS specified in paragraph (d) of this section to measure PM and calculating a 24-hour block arithmetic average emission concentration using EPA Reference Method 19 of appendix A of this part, section 4.1.

(6) Compliance with the PM emission limit shall be determined based on the 24-hour daily (block) average of the hourly arithmetic average emission concentrations using CEMS outlet data.

(7) At a minimum, valid CEMS hourly averages shall be obtained as specified in paragraph (c)(7) (i) of this section for 75 percent of the total operating hours per 30-day rolling average.

(i) At least two data points per hour shall be used to calculate each 1-hour arithmetic average.

(ii) [Reserved]

(8) The 1-hour arithmetic averages required under paragraph (c)(7) of this section shall be expressed in ng/J or lb/MMBtu heat input and shall be used to calculate the boiler operating day daily arithmetic average emission concentrations. The 1-hour arithmetic averages shall be calculated using the data points required under § 60.13(e)(2) of subpart A of this part.

(9) All valid CEMS data shall be used in calculating average emission concentrations even if the minimum CEMS data requirements of paragraph (c)(7) of this section are not met.

(10) The CEMS shall be operated according to Performance Specification 11 in appendix B of this part.

(11) During the correlation testing runs of the CEMS required by Performance Specification 11 in appendix B of this part, PM and O₂ (or CO₂) data shall be collected concurrently (or within a 30- to 60-minute period) by both the continuous emission monitors and performance tests conducted using the following test methods.

(i) For PM, Method 5 or 5B of appendix A-3 of this part or Method 17 of appendix A-6 of this part shall be used; and

(ii) For O₂ (or CO₂), Method 3A or 3B of appendix A-2 of this part, as applicable shall be used.

(12) Quarterly accuracy determinations and daily calibration drift tests shall be performed in accordance with procedure 2 in appendix F of this part. Relative Response Audit's must be performed annually and Response Correlation Audits must be performed every 3 years.

(13) When PM emissions data are not obtained because of CEMS breakdowns, repairs, calibration checks, and zero and span adjustments, emissions data shall be obtained by using other monitoring systems as approved by the Administrator or EPA Reference Method 19 of appendix A of this part to provide, as necessary, valid emissions data for a minimum of 75 percent of total operating hours on a 30-day rolling average.

(14) As of January 1, 2012, and within 90 days after the date of completing each performance test, as defined in § 60.8, conducted to demonstrate compliance with this subpart, you must submit relative accuracy test audit (*i.e.*, reference method) data and performance test (*i.e.*, compliance test) data, except opacity data, electronically to EPA's Central Data Exchange (CDX) by using the Electronic Reporting Tool (ERT) (see http://www.epa.gov/ttn/chief/ert/ert_tool.html/) or other compatible electronic spreadsheet. Only data collected using test methods compatible with ERT are subject to this requirement to be submitted electronically into EPA's WebFIRE database.

(d) The owner or operator of an affected facility seeking to demonstrate compliance under § 60.43c(e)(4) shall follow the applicable procedures under § 60.48c(f). For residual oil-fired affected facilities, fuel supplier certifications are only allowed for facilities with heat input capacities between 2.9 and 8.7 MW (10 to 30 MMBtu/h).

[72 FR 32759, June 13, 2007, as amended at 74 FR 5091, Jan. 28, 2009; 76 FR 3523, Jan. 20, 2011; 77 FR 9463, Feb. 16, 2012]

§ 60.46c Emission monitoring for sulfur dioxide.

(a) Except as provided in paragraphs (d) and (e) of this section, the owner or operator of an affected facility subject to the SO₂ emission limits under § 60.42c shall install, calibrate, maintain, and operate a CEMS for measuring SO₂ concentrations and either O₂ or CO₂ concentrations at the outlet of the SO₂ control device (or the outlet of the steam generating unit if no SO₂ control device is used), and shall record the output of the system. The owner or operator of an affected facility subject to the percent reduction requirements under § 60.42c shall measure SO₂ concentrations and either O₂ or CO₂ concentrations at both the inlet and outlet of the SO₂ control device.

(b) The 1-hour average SO₂ emission rates measured by a CEMS shall be expressed in ng/J or lb/MMBtu heat input and shall be used to calculate the average emission rates under § 60.42c. Each

1-hour average SO₂ emission rate must be based on at least 30 minutes of operation, and shall be calculated using the data points required under § 60.13(h)(2). Hourly SO₂ emission rates are not calculated if the affected facility is operated less than 30 minutes in a 1-hour period and are not counted toward determination of a steam generating unit operating day.

(c) The procedures under § 60.13 shall be followed for installation, evaluation, and operation of the CEMS.

(1) All CEMS shall be operated in accordance with the applicable procedures under Performance Specifications 1, 2, and 3 of appendix B of this part.

(2) Quarterly accuracy determinations and daily calibration drift tests shall be performed in accordance with Procedure 1 of appendix F of this part.

(3) For affected facilities subject to the percent reduction requirements under § 60.42c, the span value of the SO₂ CEMS at the inlet to the SO₂ control device shall be 125 percent of the maximum estimated hourly potential SO₂ emission rate of the fuel combusted, and the span value of the SO₂ CEMS at the outlet from the SO₂ control device shall be 50 percent of the maximum estimated hourly potential SO₂ emission rate of the fuel combusted.

(4) For affected facilities that are not subject to the percent reduction requirements of § 60.42c, the span value of the SO₂ CEMS at the outlet from the SO₂ control device (or outlet of the steam generating unit if no SO₂ control device is used) shall be 125 percent of the maximum estimated hourly potential SO₂ emission rate of the fuel combusted.

(d) As an alternative to operating a CEMS at the inlet to the SO₂ control device (or outlet of the steam generating unit if no SO₂ control device is used) as required under paragraph (a) of this section, an owner or operator may elect to determine the average SO₂ emission rate by sampling the fuel prior to combustion. As an alternative to operating a CEMS at the outlet from the SO₂ control device (or outlet of the steam generating unit if no SO₂ control device is used) as required under paragraph (a) of this section, an owner or operator may elect to determine the average SO₂ emission rate by using Method 6B of appendix A of this part. Fuel sampling shall be conducted pursuant to either paragraph (d)(1) or (d)(2) of this section. Method 6B of appendix A of this part shall be conducted pursuant to paragraph (d)(3) of this section.

(1) For affected facilities combusting coal or oil, coal or oil samples shall be collected daily in an as-fired condition at the inlet to the steam generating unit and analyzed for sulfur content and heat content according to the Method 19 of appendix A of this part. Method 19 of appendix A of this part provides procedures for converting these measurements into the format to be used in calculating the average SO₂ input rate.

(2) As an alternative fuel sampling procedure for affected facilities combusting oil, oil samples may be collected from the fuel tank for each steam generating unit immediately after the fuel tank is filled and before any oil is combusted. The owner or operator of the affected facility shall analyze the oil sample to determine the sulfur content of the oil. If a partially empty fuel tank is refilled, a new sample and analysis of the fuel in the tank would be required upon filling. Results of the fuel analysis taken after each new shipment of oil is received shall be used as the daily value when calculating the 30-day rolling average until the next shipment is received. If the fuel analysis shows that the sulfur content in the fuel tank is greater than 0.5 weight percent sulfur, the owner or operator shall ensure that the sulfur content of subsequent oil shipments is low enough to cause the 30-day rolling average sulfur content to be 0.5 weight percent sulfur or less.

(3) Method 6B of appendix A of this part may be used in lieu of CEMS to measure SO₂ at the inlet or outlet of the SO₂ control system. An initial stratification test is required to verify the adequacy of the Method 6B of appendix A of this part sampling location. The stratification test shall consist of three paired runs of a suitable SO₂ and CO₂ measurement train operated at the candidate location and a second similar train operated according to the procedures in § 3.2 and the applicable procedures in section 7 of Performance Specification 2 of appendix B of this part. Method 6B of appendix A of this

part, Method 6A of appendix A of this part, or a combination of Methods 6 and 3 of appendix A of this part or Methods 6C and 3A of appendix A of this part are suitable measurement techniques. If Method 6B of appendix A of this part is used for the second train, sampling time and timer operation may be adjusted for the stratification test as long as an adequate sample volume is collected; however, both sampling trains are to be operated similarly. For the location to be adequate for Method 6B of appendix A of this part 24-hour tests, the mean of the absolute difference between the three paired runs must be less than 10 percent (0.10).

(e) The monitoring requirements of paragraphs (a) and (d) of this section shall not apply to affected facilities subject to § 60.42c(h) (1), (2), or (3) where the owner or operator of the affected facility seeks to demonstrate compliance with the SO₂ standards based on fuel supplier certification, as described under § 60.48c(f), as applicable.

(f) The owner or operator of an affected facility operating a CEMS pursuant to paragraph (a) of this section, or conducting as-fired fuel sampling pursuant to paragraph (d)(1) of this section, shall obtain emission data for at least 75 percent of the operating hours in at least 22 out of 30 successive steam generating unit operating days. If this minimum data requirement is not met with a single monitoring system, the owner or operator of the affected facility shall supplement the emission data with data collected with other monitoring systems as approved by the Administrator.

§ 60.47c Emission monitoring for particulate matter.

(a) Except as provided in paragraphs (c), (d), (e), and (f) of this section, the owner or operator of an affected facility combusting coal, oil, or wood that is subject to the opacity standards under § 60.43c shall install, calibrate, maintain, and operate a continuous opacity monitoring system (COMS) for measuring the opacity of the emissions discharged to the atmosphere and record the output of the system. The owner or operator of an affected facility subject to an opacity standard in § 60.43c(c) that is not required to use a COMS due to paragraphs (c), (d), (e), or (f) of this section that elects not to use a COMS shall conduct a performance test using Method 9 of appendix A-4 of this part and the procedures in § 60.11 to demonstrate compliance with the applicable limit in § 60.43c by April 29, 2011, within 45 days of stopping use of an existing COMS, or within 180 days after initial startup of the facility, whichever is later, and shall comply with either paragraphs (a)(1), (a)(2), or (a)(3) of this section. The observation period for Method 9 of appendix A-4 of this part performance tests may be reduced from 3 hours to 60 minutes if all 6-minute averages are less than 10 percent and all individual 15-second observations are less than or equal to 20 percent during the initial 60 minutes of observation.

(1) Except as provided in paragraph (a)(2) and (a)(3) of this section, the owner or operator shall conduct subsequent Method 9 of appendix A-4 of this part performance tests using the procedures in paragraph (a) of this section according to the applicable schedule in paragraphs (a)(1)(i) through (a)(1)(iv) of this section, as determined by the most recent Method 9 of appendix A-4 of this part performance test results.

(i) If no visible emissions are observed, a subsequent Method 9 of appendix A-4 of this part performance test must be completed within 12 calendar months from the date that the most recent performance test was conducted or within 45 days of the next day that fuel with an opacity standard is combusted, whichever is later;

(ii) If visible emissions are observed but the maximum 6-minute average opacity is less than or equal to 5 percent, a subsequent Method 9 of appendix A-4 of this part performance test must be completed within 6 calendar months from the date that the most recent performance test was conducted or within 45 days of the next day that fuel with an opacity standard is combusted, whichever is later;

(iii) If the maximum 6-minute average opacity is greater than 5 percent but less than or equal to 10 percent, a subsequent Method 9 of appendix A-4 of this part performance test must be completed within 3 calendar months from the date that the most recent performance test was conducted or within 45 days of the next day that fuel with an opacity standard is combusted, whichever is later; or

(iv) If the maximum 6-minute average opacity is greater than 10 percent, a subsequent Method 9 of appendix A-4 of this part performance test must be completed within 45 calendar days from the date that the most recent performance test was conducted.

(2) If the maximum 6-minute opacity is less than 10 percent during the most recent Method 9 of appendix A-4 of this part performance test, the owner or operator may, as an alternative to performing subsequent Method 9 of appendix A-4 of this part performance tests, elect to perform subsequent monitoring using Method 22 of appendix A-7 of this part according to the procedures specified in paragraphs (a)(2)(i) and (ii) of this section.

(i) The owner or operator shall conduct 10 minute observations (during normal operation) each operating day the affected facility fires fuel for which an opacity standard is applicable using Method 22 of appendix A-7 of this part and demonstrate that the sum of the occurrences of any visible emissions is not in excess of 5 percent of the observation period (*i.e.* , 30 seconds per 10 minute period). If the sum of the occurrence of any visible emissions is greater than 30 seconds during the initial 10 minute observation, immediately conduct a 30 minute observation. If the sum of the occurrence of visible emissions is greater than 5 percent of the observation period (*i.e.*, 90 seconds per 30 minute period), the owner or operator shall either document and adjust the operation of the facility and demonstrate within 24 hours that the sum of the occurrence of visible emissions is equal to or less than 5 percent during a 30 minute observation (*i.e.*, 90 seconds) or conduct a new Method 9 of appendix A-4 of this part performance test using the procedures in paragraph (a) of this section within 45 calendar days according to the requirements in § 60.45c(a)(8).

(ii) If no visible emissions are observed for 10 operating days during which an opacity standard is applicable, observations can be reduced to once every 7 operating days during which an opacity standard is applicable. If any visible emissions are observed, daily observations shall be resumed.

(3) If the maximum 6-minute opacity is less than 10 percent during the most recent Method 9 of appendix A-4 of this part performance test, the owner or operator may, as an alternative to performing subsequent Method 9 of appendix A-4 performance tests, elect to perform subsequent monitoring using a digital opacity compliance system according to a site-specific monitoring plan approved by the Administrator. The observations shall be similar, but not necessarily identical, to the requirements in paragraph (a)(2) of this section. For reference purposes in preparing the monitoring plan, see OAQPS "Determination of Visible Emission Opacity from Stationary Sources Using Computer-Based Photographic Analysis Systems." This document is available from the U.S. Environmental Protection Agency (U.S. EPA); Office of Air Quality and Planning Standards; Sector Policies and Programs Division; Measurement Policy Group (D243-02), Research Triangle Park, NC 27711. This document is also available on the Technology Transfer Network (TTN) under Emission Measurement Center Preliminary Methods.

(b) All COMS shall be operated in accordance with the applicable procedures under Performance Specification 1 of appendix B of this part. The span value of the opacity COMS shall be between 60 and 80 percent.

(c) Owners and operators of an affected facilities that burn only distillate oil that contains no more than 0.5 weight percent sulfur and/or liquid or gaseous fuels with potential sulfur dioxide emission rates of 26 ng/J (0.060 lb/MMBtu) heat input or less and that do not use a post-combustion technology to reduce SO₂ or PM emissions and that are subject to an opacity standard in § 60.43c(c) are not required to operate a COMS if they follow the applicable procedures in § 60.48c(f).

(d) Owners or operators complying with the PM emission limit by using a PM CEMS must calibrate, maintain, operate, and record the output of the system for PM emissions discharged to the atmosphere as specified in § 60.45c(c). The CEMS specified in paragraph § 60.45c(c) shall be operated and data recorded during all periods of operation of the affected facility except for CEMS breakdowns and repairs. Data is recorded during calibration checks, and zero and span adjustments.

(e) Owners and operators of an affected facility that is subject to an opacity standard in § 60.43c (c) and that does not use post-combustion technology (except a wet scrubber) for reducing PM, SO₂ , or carbon monoxide (CO) emissions, burns only gaseous fuels or fuel oils that contain less than or

equal to 0.5 weight percent sulfur, and is operated such that emissions of CO discharged to the atmosphere from the affected facility are maintained at levels less than or equal to 0.15 lb/MMBtu on a boiler operating day average basis is not required to operate a COMS. Owners and operators of affected facilities electing to comply with this paragraph must demonstrate compliance according to the procedures specified in paragraphs (e)(1) through (4) of this section; or

(1) You must monitor CO emissions using a CEMS according to the procedures specified in paragraphs (e)(1)(i) through (iv) of this section.

(i) The CO CEMS must be installed, certified, maintained, and operated according to the provisions in § 60.58b(i)(3) of subpart Eb of this part.

(ii) Each 1-hour CO emissions average is calculated using the data points generated by the CO CEMS expressed in parts per million by volume corrected to 3 percent oxygen (dry basis).

(iii) At a minimum, valid 1-hour CO emissions averages must be obtained for at least 90 percent of the operating hours on a 30-day rolling average basis. The 1-hour averages are calculated using the data points required in § 60.13(h)(2).

(iv) Quarterly accuracy determinations and daily calibration drift tests for the CO CEMS must be performed in accordance with procedure 1 in appendix F of this part.

(2) You must calculate the 1-hour average CO emissions levels for each steam generating unit operating day by multiplying the average hourly CO output concentration measured by the CO CEMS times the corresponding average hourly flue gas flow rate and divided by the corresponding average hourly heat input to the affected source. The 24-hour average CO emission level is determined by calculating the arithmetic average of the hourly CO emission levels computed for each steam generating unit operating day.

(3) You must evaluate the preceding 24-hour average CO emission level each steam generating unit operating day excluding periods of affected source startup, shutdown, or malfunction. If the 24-hour average CO emission level is greater than 0.15 lb/MMBtu, you must initiate investigation of the relevant equipment and control systems within 24 hours of the first discovery of the high emission incident and, take the appropriate corrective action as soon as practicable to adjust control settings or repair equipment to reduce the 24-hour average CO emission level to 0.15 lb/MMBtu or less.

(4) You must record the CO measurements and calculations performed according to paragraph (e) of this section and any corrective actions taken. The record of corrective action taken must include the date and time during which the 24-hour average CO emission level was greater than 0.15 lb/MMBtu, and the date, time, and description of the corrective action.

(f) An owner or operator of an affected facility that is subject to an opacity standard in § 60.43c(c) is not required to operate a COMS provided that the affected facility meets the conditions in either paragraphs (f)(1), (2), or (3) of this section.

(1) The affected facility uses a fabric filter (baghouse) as the primary PM control device and, the owner or operator operates a bag leak detection system to monitor the performance of the fabric filter according to the requirements in section § 60.48Da of this part.

(2) The affected facility uses an ESP as the primary PM control device, and the owner or operator uses an ESP predictive model to monitor the performance of the ESP developed in accordance and operated according to the requirements in section § 60.48Da of this part.

(3) The affected facility burns only gaseous fuels and/or fuel oils that contain no greater than 0.5 weight percent sulfur, and the owner or operator operates the unit according to a written site-specific monitoring plan approved by the permitting authority. This monitoring plan must include procedures and criteria for establishing and monitoring specific parameters for the affected facility indicative of compliance with the opacity standard. For testing performed as part of this site-specific monitoring plan, the permitting authority may require as an alternative to the notification and reporting

requirements specified in §§ 60.8 and 60.11 that the owner or operator submit any deviations with the excess emissions report required under § 60.48c(c).

[72 FR 32759, June 13, 2007, as amended at 74 FR 5091, Jan. 28, 2009; 76 FR 3523, Jan. 20, 2011; 77 FR 9463, Feb. 16, 2012]

§ 60.48c Reporting and recordkeeping requirements.

(a) The owner or operator of each affected facility shall submit notification of the date of construction or reconstruction and actual startup, as provided by § 60.7 of this part. This notification shall include:

(1) The design heat input capacity of the affected facility and identification of fuels to be combusted in the affected facility.

(2) If applicable, a copy of any federally enforceable requirement that limits the annual capacity factor for any fuel or mixture of fuels under § 60.42c, or § 60.43c.

(3) The annual capacity factor at which the owner or operator anticipates operating the affected facility based on all fuels fired and based on each individual fuel fired.

(4) Notification if an emerging technology will be used for controlling SO₂ emissions. The Administrator will examine the description of the control device and will determine whether the technology qualifies as an emerging technology. In making this determination, the Administrator may require the owner or operator of the affected facility to submit additional information concerning the control device. The affected facility is subject to the provisions of § 60.42c(a) or (b)(1), unless and until this determination is made by the Administrator.

(b) The owner or operator of each affected facility subject to the SO₂ emission limits of § 60.42c, or the PM or opacity limits of § 60.43c, shall submit to the Administrator the performance test data from the initial and any subsequent performance tests and, if applicable, the performance evaluation of the CEMS and/or COMS using the applicable performance specifications in appendix B of this part.

(c) In addition to the applicable requirements in § 60.7, the owner or operator of an affected facility subject to the opacity limits in § 60.43c(c) shall submit excess emission reports for any excess emissions from the affected facility that occur during the reporting period and maintain records according to the requirements specified in paragraphs (c)(1) through (3) of this section, as applicable to the visible emissions monitoring method used.

(1) For each performance test conducted using Method 9 of appendix A-4 of this part, the owner or operator shall keep the records including the information specified in paragraphs (c)(1)(i) through (iii) of this section.

(i) Dates and time intervals of all opacity observation periods;

(ii) Name, affiliation, and copy of current visible emission reading certification for each visible emission observer participating in the performance test; and

(iii) Copies of all visible emission observer opacity field data sheets;

(2) For each performance test conducted using Method 22 of appendix A-4 of this part, the owner or operator shall keep the records including the information specified in paragraphs (c)(2)(i) through (iv) of this section.

(i) Dates and time intervals of all visible emissions observation periods;

(ii) Name and affiliation for each visible emission observer participating in the performance test;

(iii) Copies of all visible emission observer opacity field data sheets; and

(iv) Documentation of any adjustments made and the time the adjustments were completed to the affected facility operation by the owner or operator to demonstrate compliance with the applicable monitoring requirements.

(3) For each digital opacity compliance system, the owner or operator shall maintain records and submit reports according to the requirements specified in the site-specific monitoring plan approved by the Administrator

(d) The owner or operator of each affected facility subject to the SO₂ emission limits, fuel oil sulfur limits, or percent reduction requirements under § 60.42c shall submit reports to the Administrator.

(e) The owner or operator of each affected facility subject to the SO₂ emission limits, fuel oil sulfur limits, or percent reduction requirements under § 60.42c shall keep records and submit reports as required under paragraph (d) of this section, including the following information, as applicable.

(1) Calendar dates covered in the reporting period.

(2) Each 30-day average SO₂ emission rate (ng/J or lb/MMBtu), or 30-day average sulfur content (weight percent), calculated during the reporting period, ending with the last 30-day period; reasons for any noncompliance with the emission standards; and a description of corrective actions taken.

(3) Each 30-day average percent of potential SO₂ emission rate calculated during the reporting period, ending with the last 30-day period; reasons for any noncompliance with the emission standards; and a description of the corrective actions taken.

(4) Identification of any steam generating unit operating days for which SO₂ or diluent (O₂ or CO₂) data have not been obtained by an approved method for at least 75 percent of the operating hours; justification for not obtaining sufficient data; and a description of corrective actions taken.

(5) Identification of any times when emissions data have been excluded from the calculation of average emission rates; justification for excluding data; and a description of corrective actions taken if data have been excluded for periods other than those during which coal or oil were not combusted in the steam generating unit.

(6) Identification of the F factor used in calculations, method of determination, and type of fuel combusted.

(7) Identification of whether averages have been obtained based on CEMS rather than manual sampling methods.

(8) If a CEMS is used, identification of any times when the pollutant concentration exceeded the full span of the CEMS.

(9) If a CEMS is used, description of any modifications to the CEMS that could affect the ability of the CEMS to comply with Performance Specifications 2 or 3 of appendix B of this part.

(10) If a CEMS is used, results of daily CEMS drift tests and quarterly accuracy assessments as required under appendix F, Procedure 1 of this part.

(11) If fuel supplier certification is used to demonstrate compliance, records of fuel supplier certification as described under paragraph (f)(1), (2), (3), or (4) of this section, as applicable. In addition to records of fuel supplier certifications, the report shall include a certified statement signed by the owner or operator of the affected facility that the records of fuel supplier certifications submitted represent all of the fuel combusted during the reporting period.

(f) Fuel supplier certification shall include the following information:

(1) For distillate oil:

(i) The name of the oil supplier;

(ii) A statement from the oil supplier that the oil complies with the specifications under the definition of distillate oil in § 60.41c; and

(iii) The sulfur content or maximum sulfur content of the oil.

(2) For residual oil:

(i) The name of the oil supplier;

(ii) The location of the oil when the sample was drawn for analysis to determine the sulfur content of the oil, specifically including whether the oil was sampled as delivered to the affected facility, or whether the sample was drawn from oil in storage at the oil supplier's or oil refiner's facility, or other location;

(iii) The sulfur content of the oil from which the shipment came (or of the shipment itself); and

(iv) The method used to determine the sulfur content of the oil.

(3) For coal:

(i) The name of the coal supplier;

(ii) The location of the coal when the sample was collected for analysis to determine the properties of the coal, specifically including whether the coal was sampled as delivered to the affected facility or whether the sample was collected from coal in storage at the mine, at a coal preparation plant, at a coal supplier's facility, or at another location. The certification shall include the name of the coal mine (and coal seam), coal storage facility, or coal preparation plant (where the sample was collected);

(iii) The results of the analysis of the coal from which the shipment came (or of the shipment itself) including the sulfur content, moisture content, ash content, and heat content; and

(iv) The methods used to determine the properties of the coal.

(4) For other fuels:

(i) The name of the supplier of the fuel;

(ii) The potential sulfur emissions rate or maximum potential sulfur emissions rate of the fuel in ng/J heat input; and

(iii) The method used to determine the potential sulfur emissions rate of the fuel.

(g)(1) Except as provided under paragraphs (g)(2) and (g)(3) of this section, the owner or operator of each affected facility shall record and maintain records of the amount of each fuel combusted during each operating day.

(2) As an alternative to meeting the requirements of paragraph (g)(1) of this section, the owner or operator of an affected facility that combusts only natural gas, wood, fuels using fuel certification in § 60.48c(f) to demonstrate compliance with the SO₂ standard, fuels not subject to an emissions standard (excluding opacity), or a mixture of these fuels may elect to record and maintain records of the amount of each fuel combusted during each calendar month.

(3) As an alternative to meeting the requirements of paragraph (g)(1) of this section, the owner or operator of an affected facility or multiple affected facilities located on a contiguous property unit where the only fuels combusted in any steam generating unit (including steam generating units not subject to this subpart) at that property are natural gas, wood, distillate oil meeting the most current requirements in § 60.42C to use fuel certification to demonstrate compliance with the SO₂ standard, and/or fuels, excluding coal and residual oil, not subject to an emissions standard (excluding opacity) may elect to

record and maintain records of the total amount of each steam generating unit fuel delivered to that property during each calendar month.

(h) The owner or operator of each affected facility subject to a federally enforceable requirement limiting the annual capacity factor for any fuel or mixture of fuels under § 60.42c or § 60.43c shall calculate the annual capacity factor individually for each fuel combusted. The annual capacity factor is determined on a 12-month rolling average basis with a new annual capacity factor calculated at the end of the calendar month.

(i) All records required under this section shall be maintained by the owner or operator of the affected facility for a period of two years following the date of such record.

(j) The reporting period for the reports required under this subpart is each six-month period. All reports shall be submitted to the Administrator and shall be postmarked by the 30th day following the end of the reporting period.

[72 FR 32759, June 13, 2007, as amended at 74 FR 5091, Jan. 28, 2009]

For questions or comments regarding e-CFR editorial content, features, or design, email ecfr@nara.gov.
For questions concerning e-CFR programming and delivery issues, email webteam@gpo.gov.

Appendix B – 40 CFR Part 60, Subpart Kb

ELECTRONIC CODE OF FEDERAL REGULATIONS

e-CFR Data is current as of August 30, 2013

Title 40: Protection of Environment

[PART 60—STANDARDS OF PERFORMANCE FOR NEW STATIONARY SOURCES](#)

Subpart Kb—Standards of Performance for Volatile Organic Liquid Storage Vessels (Including Petroleum Liquid Storage Vessels) for Which Construction, Reconstruction, or Modification Commenced After July 23, 1984

Contents

- [§ 60.110b](#) Applicability and designation of affected facility.
 - [§ 60.111b](#) Definitions.
 - [§ 60.112b](#) Standard for volatile organic compounds (VOC).
 - [§ 60.113b](#) Testing and procedures.
 - [§ 60.114b](#) Alternative means of emission limitation.
 - [§ 60.115b](#) Reporting and recordkeeping requirements.
 - [§ 60.116b](#) Monitoring of operations.
 - [§ 60.117b](#) Delegation of authority.
-

SOURCE: 52 FR 11429, Apr. 8, 1987, unless otherwise noted.

§ 60.110b Applicability and designation of affected facility.

(a) Except as provided in paragraph (b) of this section, the affected facility to which this subpart applies is each storage vessel with a capacity greater than or equal to 75 cubic meters (m³) that is used to store volatile organic liquids (VOL) for which construction, reconstruction, or modification is commenced after July 23, 1984.

(b) This subpart does not apply to storage vessels with a capacity greater than or equal to 151 m³ storing a liquid with a maximum true vapor pressure less than 3.5 kilopascals (kPa) or with a capacity greater than or equal to 75 m³ but less than 151 m³ storing a liquid with a maximum true vapor pressure less than 15.0 kPa.

(c) [Reserved]

(d) This subpart does not apply to the following:

- (1) Vessels at coke oven by-product plants.
- (2) Pressure vessels designed to operate in excess of 204.9 kPa and without emissions to the atmosphere.
- (3) Vessels permanently attached to mobile vehicles such as trucks, railcars, barges, or ships.
- (4) Vessels with a design capacity less than or equal to 1,589.874 m³ used for petroleum or condensate stored, processed, or treated prior to custody transfer.
- (5) Vessels located at bulk gasoline plants.

(6) Storage vessels located at gasoline service stations.

(7) Vessels used to store beverage alcohol.

(8) Vessels subject to subpart GGGG of 40 CFR part 63.

(e) *Alternative means of compliance* —(1) *Option to comply with part 65.* Owners or operators may choose to comply with 40 CFR part 65, subpart C, to satisfy the requirements of §§ 60.112b through 60.117b for storage vessels that are subject to this subpart that meet the specifications in paragraphs (e)(1)(i) and (ii) of this section. When choosing to comply with 40 CFR part 65, subpart C, the monitoring requirements of § 60.116b(c), (e), (f)(1), and (g) still apply. Other provisions applying to owners or operators who choose to comply with 40 CFR part 65 are provided in 40 CFR 65.1.

(i) A storage vessel with a design capacity greater than or equal to 151 m³ containing a VOL that, as stored, has a maximum true vapor pressure equal to or greater than 5.2 kPa; or

(ii) A storage vessel with a design capacity greater than 75 m³ but less than 151 m³ containing a VOL that, as stored, has a maximum true vapor pressure equal to or greater than 27.6 kPa.

(2) *Part 60, subpart A.* Owners or operators who choose to comply with 40 CFR part 65, subpart C, must also comply with §§ 60.1, 60.2, 60.5, 60.6, 60.7(a)(1) and (4), 60.14, 60.15, and 60.16 for those storage vessels. All sections and paragraphs of subpart A of this part that are not mentioned in this paragraph (e)(2) do not apply to owners or operators of storage vessels complying with 40 CFR part 65, subpart C, except that provisions required to be met prior to implementing 40 CFR part 65 still apply. Owners and operators who choose to comply with 40 CFR part 65, subpart C, must comply with 40 CFR part 65, subpart A.

(3) *Internal floating roof report.* If an owner or operator installs an internal floating roof and, at initial startup, chooses to comply with 40 CFR part 65, subpart C, a report shall be furnished to the Administrator stating that the control equipment meets the specifications of 40 CFR 65.43. This report shall be an attachment to the notification required by 40 CFR 65.5(b).

(4) *External floating roof report.* If an owner or operator installs an external floating roof and, at initial startup, chooses to comply with 40 CFR part 65, subpart C, a report shall be furnished to the Administrator stating that the control equipment meets the specifications of 40 CFR 65.44. This report shall be an attachment to the notification required by 40 CFR 65.5(b).

[52 FR 11429, Apr. 8, 1987, as amended at 54 FR 32973, Aug. 11, 1989; 65 FR 78275, Dec. 14, 2000; 68 FR 59332, Oct. 15, 2003]

§ 60.111b Definitions.

Terms used in this subpart are defined in the Act, in subpart A of this part, or in this subpart as follows:

Bulk gasoline plant means any gasoline distribution facility that has a gasoline throughput less than or equal to 75,700 liters per day. Gasoline throughput shall be the maximum calculated design throughput as may be limited by compliance with an enforceable condition under Federal requirement or Federal, State or local law, and discoverable by the Administrator and any other person.

Condensate means hydrocarbon liquid separated from natural gas that condenses due to changes in the temperature or pressure, or both, and remains liquid at standard conditions.

Custody transfer means the transfer of produced petroleum and/or condensate, after processing and/or treatment in the producing operations, from storage vessels or automatic transfer facilities to pipelines or any other forms of transportation.

Fill means the introduction of VOL into a storage vessel but not necessarily to complete capacity.

Gasoline service station means any site where gasoline is dispensed to motor vehicle fuel tanks from stationary storage tanks.

Maximum true vapor pressure means the equilibrium partial pressure exerted by the volatile organic compounds (as defined in 40 CFR 51.100) in the stored VOL at the temperature equal to the highest calendar-month average of the VOL storage temperature for VOL's stored above or below the ambient temperature or at the local maximum monthly average temperature as reported by the National Weather Service for VOL's stored at the ambient temperature, as determined:

- (1) In accordance with methods described in American Petroleum Institute Bulletin 2517, Evaporation Loss From External Floating Roof Tanks, (incorporated by reference—see § 60.17); or
- (2) As obtained from standard reference texts; or
- (3) As determined by ASTM D2879-83, 96, or 97 (incorporated by reference—see § 60.17);
- (4) Any other method approved by the Administrator.

Petroleum means the crude oil removed from the earth and the oils derived from tar sands, shale, and coal.

Petroleum liquids means petroleum, condensate, and any finished or intermediate products manufactured in a petroleum refinery.

Process tank means a tank that is used within a process (including a solvent or raw material recovery process) to collect material discharged from a feedstock storage vessel or equipment within the process before the material is transferred to other equipment within the process, to a product or by-product storage vessel, or to a vessel used to store recovered solvent or raw material. In many process tanks, unit operations such as reactions and blending are conducted. Other process tanks, such as surge control vessels and bottoms receivers, however, may not involve unit operations.

Reid vapor pressure means the absolute vapor pressure of volatile crude oil and volatile nonviscous petroleum liquids except liquified petroleum gases, as determined by ASTM D323-82 or 94 (incorporated by reference—see § 60.17).

Storage vessel means each tank, reservoir, or container used for the storage of volatile organic liquids but does not include:

- (1) Frames, housing, auxiliary supports, or other components that are not directly involved in the containment of liquids or vapors;
- (2) Subsurface caverns or porous rock reservoirs; or
- (3) Process tanks.

Volatile organic liquid (VOL) means any organic liquid which can emit volatile organic compounds (as defined in 40 CFR 51.100) into the atmosphere.

Waste means any liquid resulting from industrial, commercial, mining or agricultural operations, or from community activities that is discarded or is being accumulated, stored, or physically, chemically, or biologically treated prior to being discarded or recycled.

[52 FR 11429, Apr. 8, 1987, as amended at 54 FR 32973, Aug. 11, 1989; 65 FR 61756, Oct. 17, 2000; 68 FR 59333, Oct. 15, 2003]

§ 60.112b Standard for volatile organic compounds (VOC).

(a) The owner or operator of each storage vessel either with a design capacity greater than or equal to 151 m³ containing a VOL that, as stored, has a maximum true vapor pressure equal to or greater than 5.2 kPa but less than 76.6 kPa or with a design capacity greater than or equal to 75 m³

but less than 151 m³ containing a VOL that, as stored, has a maximum true vapor pressure equal to or greater than 27.6 kPa but less than 76.6 kPa, shall equip each storage vessel with one of the following:

(1) A fixed roof in combination with an internal floating roof meeting the following specifications:

(i) The internal floating roof shall rest or float on the liquid surface (but not necessarily in complete contact with it) inside a storage vessel that has a fixed roof. The internal floating roof shall be floating on the liquid surface at all times, except during initial fill and during those intervals when the storage vessel is completely emptied or subsequently emptied and refilled. When the roof is resting on the leg supports, the process of filling, emptying, or refilling shall be continuous and shall be accomplished as rapidly as possible.

(ii) Each internal floating roof shall be equipped with one of the following closure devices between the wall of the storage vessel and the edge of the internal floating roof:

(A) A foam- or liquid-filled seal mounted in contact with the liquid (liquid-mounted seal). A liquid-mounted seal means a foam- or liquid-filled seal mounted in contact with the liquid between the wall of the storage vessel and the floating roof continuously around the circumference of the tank.

(B) Two seals mounted one above the other so that each forms a continuous closure that completely covers the space between the wall of the storage vessel and the edge of the internal floating roof. The lower seal may be vapor-mounted, but both must be continuous.

(C) A mechanical shoe seal. A mechanical shoe seal is a metal sheet held vertically against the wall of the storage vessel by springs or weighted levers and is connected by braces to the floating roof. A flexible coated fabric (envelope) spans the annular space between the metal sheet and the floating roof.

(iii) Each opening in a noncontact internal floating roof except for automatic bleeder vents (vacuum breaker vents) and the rim space vents is to provide a projection below the liquid surface.

(iv) Each opening in the internal floating roof except for leg sleeves, automatic bleeder vents, rim space vents, column wells, ladder wells, sample wells, and stub drains is to be equipped with a cover or lid which is to be maintained in a closed position at all times (i.e., no visible gap) except when the device is in actual use. The cover or lid shall be equipped with a gasket. Covers on each access hatch and automatic gauge float well shall be bolted except when they are in use.

(v) Automatic bleeder vents shall be equipped with a gasket and are to be closed at all times when the roof is floating except when the roof is being floated off or is being landed on the roof leg supports.

(vi) Rim space vents shall be equipped with a gasket and are to be set to open only when the internal floating roof is not floating or at the manufacturer's recommended setting.

(vii) Each penetration of the internal floating roof for the purpose of sampling shall be a sample well. The sample well shall have a slit fabric cover that covers at least 90 percent of the opening.

(viii) Each penetration of the internal floating roof that allows for passage of a column supporting the fixed roof shall have a flexible fabric sleeve seal or a gasketed sliding cover.

(ix) Each penetration of the internal floating roof that allows for passage of a ladder shall have a gasketed sliding cover.

(2) An external floating roof. An external floating roof means a pontoon-type or double-deck type cover that rests on the liquid surface in a vessel with no fixed roof. Each external floating roof must meet the following specifications:

(i) Each external floating roof shall be equipped with a closure device between the wall of the storage vessel and the roof edge. The closure device is to consist of two seals, one above the other. The lower seal is referred to as the primary seal, and the upper seal is referred to as the secondary seal.

(A) The primary seal shall be either a mechanical shoe seal or a liquid-mounted seal. Except as provided in § 60.113b(b)(4), the seal shall completely cover the annular space between the edge of the floating roof and tank wall.

(B) The secondary seal shall completely cover the annular space between the external floating roof and the wall of the storage vessel in a continuous fashion except as allowed in § 60.113b(b)(4).

(ii) Except for automatic bleeder vents and rim space vents, each opening in a noncontact external floating roof shall provide a projection below the liquid surface. Except for automatic bleeder vents, rim space vents, roof drains, and leg sleeves, each opening in the roof is to be equipped with a gasketed cover, seal, or lid that is to be maintained in a closed position at all times (i.e., no visible gap) except when the device is in actual use. Automatic bleeder vents are to be closed at all times when the roof is floating except when the roof is being floated off or is being landed on the roof leg supports. Rim vents are to be set to open when the roof is being floated off the roof legs supports or at the manufacturer's recommended setting. Automatic bleeder vents and rim space vents are to be gasketed. Each emergency roof drain is to be provided with a slotted membrane fabric cover that covers at least 90 percent of the area of the opening.

(iii) The roof shall be floating on the liquid at all times (i.e., off the roof leg supports) except during initial fill until the roof is lifted off leg supports and when the tank is completely emptied and subsequently refilled. The process of filling, emptying, or refilling when the roof is resting on the leg supports shall be continuous and shall be accomplished as rapidly as possible.

(3) A closed vent system and control device meeting the following specifications:

(i) The closed vent system shall be designed to collect all VOC vapors and gases discharged from the storage vessel and operated with no detectable emissions as indicated by an instrument reading of less than 500 ppm above background and visual inspections, as determined in part 60, subpart VV, § 60.485(b).

(ii) The control device shall be designed and operated to reduce inlet VOC emissions by 95 percent or greater. If a flare is used as the control device, it shall meet the specifications described in the general control device requirements (§ 60.18) of the General Provisions.

(4) A system equivalent to those described in paragraphs (a)(1), (a)(2), or (a)(3) of this section as provided in § 60.114b of this subpart.

(b) The owner or operator of each storage vessel with a design capacity greater than or equal to 75 m³ which contains a VOL that, as stored, has a maximum true vapor pressure greater than or equal to 76.6 kPa shall equip each storage vessel with one of the following:

(1) A closed vent system and control device as specified in § 60.112b(a)(3).

(2) A system equivalent to that described in paragraph (b)(1) as provided in § 60.114b of this subpart.

(c) *Site-specific standard for Merck & Co., Inc.'s Stonewall Plant in Elkton, Virginia.* This paragraph applies only to the pharmaceutical manufacturing facility, commonly referred to as the Stonewall Plant, located at Route 340 South, in Elkton, Virginia ("site").

(1) For any storage vessel that otherwise would be subject to the control technology requirements of paragraphs (a) or (b) of this section, the site shall have the option of either complying directly with the requirements of this subpart, or reducing the site-wide total criteria pollutant emissions cap (total emissions cap) in accordance with the procedures set forth in a permit issued pursuant to 40 CFR

52.2454. If the site chooses the option of reducing the total emissions cap in accordance with the procedures set forth in such permit, the requirements of such permit shall apply in lieu of the otherwise applicable requirements of this subpart for such storage vessel.

(2) For any storage vessel at the site not subject to the requirements of 40 CFR 60.112b (a) or (b), the requirements of 40 CFR 60.116b (b) and (c) and the General Provisions (subpart A of this part) shall not apply.

[52 FR 11429, Apr. 8, 1987, as amended at 62 FR 52641, Oct. 8, 1997]

§ 60.113b Testing and procedures.

The owner or operator of each storage vessel as specified in § 60.112b(a) shall meet the requirements of paragraph (a), (b), or (c) of this section. The applicable paragraph for a particular storage vessel depends on the control equipment installed to meet the requirements of § 60.112b.

(a) After installing the control equipment required to meet § 60.112b(a)(1) (permanently affixed roof and internal floating roof), each owner or operator shall:

(1) Visually inspect the internal floating roof, the primary seal, and the secondary seal (if one is in service), prior to filling the storage vessel with VOL. If there are holes, tears, or other openings in the primary seal, the secondary seal, or the seal fabric or defects in the internal floating roof, or both, the owner or operator shall repair the items before filling the storage vessel.

(2) For Vessels equipped with a liquid-mounted or mechanical shoe primary seal, visually inspect the internal floating roof and the primary seal or the secondary seal (if one is in service) through manholes and roof hatches on the fixed roof at least once every 12 months after initial fill. If the internal floating roof is not resting on the surface of the VOL inside the storage vessel, or there is liquid accumulated on the roof, or the seal is detached, or there are holes or tears in the seal fabric, the owner or operator shall repair the items or empty and remove the storage vessel from service within 45 days. If a failure that is detected during inspections required in this paragraph cannot be repaired within 45 days and if the vessel cannot be emptied within 45 days, a 30-day extension may be requested from the Administrator in the inspection report required in § 60.115b(a)(3). Such a request for an extension must document that alternate storage capacity is unavailable and specify a schedule of actions the company will take that will assure that the control equipment will be repaired or the vessel will be emptied as soon as possible.

(3) For vessels equipped with a double-seal system as specified in § 60.112b(a)(1)(ii)(B):

(i) Visually inspect the vessel as specified in paragraph (a)(4) of this section at least every 5 years; or

(ii) Visually inspect the vessel as specified in paragraph (a)(2) of this section.

(4) Visually inspect the internal floating roof, the primary seal, the secondary seal (if one is in service), gaskets, slotted membranes and sleeve seals (if any) each time the storage vessel is emptied and degassed. If the internal floating roof has defects, the primary seal has holes, tears, or other openings in the seal or the seal fabric, or the secondary seal has holes, tears, or other openings in the seal or the seal fabric, or the gaskets no longer close off the liquid surfaces from the atmosphere, or the slotted membrane has more than 10 percent open area, the owner or operator shall repair the items as necessary so that none of the conditions specified in this paragraph exist before refilling the storage vessel with VOL. In no event shall inspections conducted in accordance with this provision occur at intervals greater than 10 years in the case of vessels conducting the annual visual inspection as specified in paragraphs (a)(2) and (a)(3)(ii) of this section and at intervals no greater than 5 years in the case of vessels specified in paragraph (a)(3)(i) of this section.

(5) Notify the Administrator in writing at least 30 days prior to the filling or refilling of each storage vessel for which an inspection is required by paragraphs (a)(1) and (a)(4) of this section to afford the Administrator the opportunity to have an observer present. If the inspection required by paragraph (a)

(4) of this section is not planned and the owner or operator could not have known about the inspection 30 days in advance or refilling the tank, the owner or operator shall notify the Administrator at least 7 days prior to the refilling of the storage vessel. Notification shall be made by telephone immediately followed by written documentation demonstrating why the inspection was unplanned. Alternatively, this notification including the written documentation may be made in writing and sent by express mail so that it is received by the Administrator at least 7 days prior to the refilling.

(b) After installing the control equipment required to meet § 60.112b(a)(2) (external floating roof), the owner or operator shall:

(1) Determine the gap areas and maximum gap widths, between the primary seal and the wall of the storage vessel and between the secondary seal and the wall of the storage vessel according to the following frequency.

(i) Measurements of gaps between the tank wall and the primary seal (seal gaps) shall be performed during the hydrostatic testing of the vessel or within 60 days of the initial fill with VOL and at least once every 5 years thereafter.

(ii) Measurements of gaps between the tank wall and the secondary seal shall be performed within 60 days of the initial fill with VOL and at least once per year thereafter.

(iii) If any source ceases to store VOL for a period of 1 year or more, subsequent introduction of VOL into the vessel shall be considered an initial fill for the purposes of paragraphs (b)(1)(i) and (b)(1)(ii) of this section.

(2) Determine gap widths and areas in the primary and secondary seals individually by the following procedures:

(i) Measure seal gaps, if any, at one or more floating roof levels when the roof is floating off the roof leg supports.

(ii) Measure seal gaps around the entire circumference of the tank in each place where a 0.32-cm diameter uniform probe passes freely (without forcing or binding against seal) between the seal and the wall of the storage vessel and measure the circumferential distance of each such location.

(iii) The total surface area of each gap described in paragraph (b)(2)(ii) of this section shall be determined by using probes of various widths to measure accurately the actual distance from the tank wall to the seal and multiplying each such width by its respective circumferential distance.

(3) Add the gap surface area of each gap location for the primary seal and the secondary seal individually and divide the sum for each seal by the nominal diameter of the tank and compare each ratio to the respective standards in paragraph (b)(4) of this section.

(4) Make necessary repairs or empty the storage vessel within 45 days of identification in any inspection for seals not meeting the requirements listed in (b)(4) (i) and (ii) of this section:

(i) The accumulated area of gaps between the tank wall and the mechanical shoe or liquid-mounted primary seal shall not exceed 212 cm^2 per meter of tank diameter, and the width of any portion of any gap shall not exceed 3.81 cm.

(A) One end of the mechanical shoe is to extend into the stored liquid, and the other end is to extend a minimum vertical distance of 61 cm above the stored liquid surface.

(B) There are to be no holes, tears, or other openings in the shoe, seal fabric, or seal envelope.

(ii) The secondary seal is to meet the following requirements:

(A) The secondary seal is to be installed above the primary seal so that it completely covers the space between the roof edge and the tank wall except as provided in paragraph (b)(2)(iii) of this section.

(B) The accumulated area of gaps between the tank wall and the secondary seal shall not exceed 21.2 cm² per meter of tank diameter, and the width of any portion of any gap shall not exceed 1.27 cm.

(C) There are to be no holes, tears, or other openings in the seal or seal fabric.

(iii) If a failure that is detected during inspections required in paragraph (b)(1) of § 60.113b(b) cannot be repaired within 45 days and if the vessel cannot be emptied within 45 days, a 30-day extension may be requested from the Administrator in the inspection report required in § 60.115b(b)(4). Such extension request must include a demonstration of unavailability of alternate storage capacity and a specification of a schedule that will assure that the control equipment will be repaired or the vessel will be emptied as soon as possible.

(5) Notify the Administrator 30 days in advance of any gap measurements required by paragraph (b)(1) of this section to afford the Administrator the opportunity to have an observer present.

(6) Visually inspect the external floating roof, the primary seal, secondary seal, and fittings each time the vessel is emptied and degassed.

(i) If the external floating roof has defects, the primary seal has holes, tears, or other openings in the seal or the seal fabric, or the secondary seal has holes, tears, or other openings in the seal or the seal fabric, the owner or operator shall repair the items as necessary so that none of the conditions specified in this paragraph exist before filling or refilling the storage vessel with VOL.

(ii) For all the inspections required by paragraph (b)(6) of this section, the owner or operator shall notify the Administrator in writing at least 30 days prior to the filling or refilling of each storage vessel to afford the Administrator the opportunity to inspect the storage vessel prior to refilling. If the inspection required by paragraph (b)(6) of this section is not planned and the owner or operator could not have known about the inspection 30 days in advance of refilling the tank, the owner or operator shall notify the Administrator at least 7 days prior to the refilling of the storage vessel. Notification shall be made by telephone immediately followed by written documentation demonstrating why the inspection was unplanned. Alternatively, this notification including the written documentation may be made in writing and sent by express mail so that it is received by the Administrator at least 7 days prior to the refilling.

(c) The owner or operator of each source that is equipped with a closed vent system and control device as required in § 60.112b (a)(3) or (b)(2) (other than a flare) is exempt from § 60.8 of the General Provisions and shall meet the following requirements.

(1) Submit for approval by the Administrator as an attachment to the notification required by § 60.7(a)(1) or, if the facility is exempt from § 60.7(a)(1), as an attachment to the notification required by § 60.7(a)(2), an operating plan containing the information listed below.

(i) Documentation demonstrating that the control device will achieve the required control efficiency during maximum loading conditions. This documentation is to include a description of the gas stream which enters the control device, including flow and VOC content under varying liquid level conditions (dynamic and static) and manufacturer's design specifications for the control device. If the control device or the closed vent capture system receives vapors, gases, or liquids other than fuels from sources that are not designated sources under this subpart, the efficiency demonstration is to include consideration of all vapors, gases, and liquids received by the closed vent capture system and control device. If an enclosed combustion device with a minimum residence time of 0.75 seconds and a minimum temperature of 816 °C is used to meet the 95 percent requirement, documentation that those conditions will exist is sufficient to meet the requirements of this paragraph.

(ii) A description of the parameter or parameters to be monitored to ensure that the control device will be operated in conformance with its design and an explanation of the criteria used for selection of that parameter (or parameters).

(2) Operate the closed vent system and control device and monitor the parameters of the closed vent system and control device in accordance with the operating plan submitted to the Administrator in

accordance with paragraph (c)(1) of this section, unless the plan was modified by the Administrator during the review process. In this case, the modified plan applies.

(d) The owner or operator of each source that is equipped with a closed vent system and a flare to meet the requirements in § 60.112b (a)(3) or (b)(2) shall meet the requirements as specified in the general control device requirements, § 60.18 (e) and (f).

[52 FR 11429, Apr. 8, 1987, as amended at 54 FR 32973, Aug. 11, 1989]

§ 60.114b Alternative means of emission limitation.

(a) If, in the Administrator's judgment, an alternative means of emission limitation will achieve a reduction in emissions at least equivalent to the reduction in emissions achieved by any requirement in § 60.112b, the Administrator will publish in the FEDERAL REGISTER a notice permitting the use of the alternative means for purposes of compliance with that requirement.

(b) Any notice under paragraph (a) of this section will be published only after notice and an opportunity for a hearing.

(c) Any person seeking permission under this section shall submit to the Administrator a written application including:

(1) An actual emissions test that uses a full-sized or scale-model storage vessel that accurately collects and measures all VOC emissions from a given control device and that accurately simulates wind and accounts for other emission variables such as temperature and barometric pressure.

(2) An engineering evaluation that the Administrator determines is an accurate method of determining equivalence.

(d) The Administrator may condition the permission on requirements that may be necessary to ensure operation and maintenance to achieve the same emissions reduction as specified in § 60.112b.

§ 60.115b Reporting and recordkeeping requirements.

The owner or operator of each storage vessel as specified in § 60.112b(a) shall keep records and furnish reports as required by paragraphs (a), (b), or (c) of this section depending upon the control equipment installed to meet the requirements of § 60.112b. The owner or operator shall keep copies of all reports and records required by this section, except for the record required by (c)(1), for at least 2 years. The record required by (c)(1) will be kept for the life of the control equipment.

(a) After installing control equipment in accordance with § 60.112b(a)(1) (fixed roof and internal floating roof), the owner or operator shall meet the following requirements.

(1) Furnish the Administrator with a report that describes the control equipment and certifies that the control equipment meets the specifications of § 60.112b(a)(1) and § 60.113b(a)(1). This report shall be an attachment to the notification required by § 60.7(a)(3).

(2) Keep a record of each inspection performed as required by § 60.113b (a)(1), (a)(2), (a)(3), and (a)(4). Each record shall identify the storage vessel on which the inspection was performed and shall contain the date the vessel was inspected and the observed condition of each component of the control equipment (seals, internal floating roof, and fittings).

(3) If any of the conditions described in § 60.113b(a)(2) are detected during the annual visual inspection required by § 60.113b(a)(2), a report shall be furnished to the Administrator within 30 days of the inspection. Each report shall identify the storage vessel, the nature of the defects, and the date the storage vessel was emptied or the nature of and date the repair was made.

(4) After each inspection required by § 60.113b(a)(3) that finds holes or tears in the seal or seal fabric, or defects in the internal floating roof, or other control equipment defects listed in § 60.113b(a)

(3)(ii), a report shall be furnished to the Administrator within 30 days of the inspection. The report shall identify the storage vessel and the reason it did not meet the specifications of § 61.112b(a)(1) or § 60.113b(a)(3) and list each repair made.

(b) After installing control equipment in accordance with § 61.112b(a)(2) (external floating roof), the owner or operator shall meet the following requirements.

(1) Furnish the Administrator with a report that describes the control equipment and certifies that the control equipment meets the specifications of § 60.112b(a)(2) and § 60.113b(b)(2), (b)(3), and (b)(4). This report shall be an attachment to the notification required by § 60.7(a)(3).

(2) Within 60 days of performing the seal gap measurements required by § 60.113b(b)(1), furnish the Administrator with a report that contains:

(i) The date of measurement.

(ii) The raw data obtained in the measurement.

(iii) The calculations described in § 60.113b (b)(2) and (b)(3).

(3) Keep a record of each gap measurement performed as required by § 60.113b(b). Each record shall identify the storage vessel in which the measurement was performed and shall contain:

(i) The date of measurement.

(ii) The raw data obtained in the measurement.

(iii) The calculations described in § 60.113b (b)(2) and (b)(3).

(4) After each seal gap measurement that detects gaps exceeding the limitations specified by § 60.113b(b)(4), submit a report to the Administrator within 30 days of the inspection. The report will identify the vessel and contain the information specified in paragraph (b)(2) of this section and the date the vessel was emptied or the repairs made and date of repair.

(c) After installing control equipment in accordance with § 60.112b (a)(3) or (b)(1) (closed vent system and control device other than a flare), the owner or operator shall keep the following records.

(1) A copy of the operating plan.

(2) A record of the measured values of the parameters monitored in accordance with § 60.113b(c)(2).

(d) After installing a closed vent system and flare to comply with § 60.112b, the owner or operator shall meet the following requirements.

(1) A report containing the measurements required by § 60.18(f) (1), (2), (3), (4), (5), and (6) shall be furnished to the Administrator as required by § 60.8 of the General Provisions. This report shall be submitted within 6 months of the initial start-up date.

(2) Records shall be kept of all periods of operation during which the flare pilot flame is absent.

(3) Semiannual reports of all periods recorded under § 60.115b(d)(2) in which the pilot flame was absent shall be furnished to the Administrator.

§ 60.116b Monitoring of operations.

(a) The owner or operator shall keep copies of all records required by this section, except for the record required by paragraph (b) of this section, for at least 2 years. The record required by paragraph (b) of this section will be kept for the life of the source.

(b) The owner or operator of each storage vessel as specified in § 60.110b(a) shall keep readily accessible records showing the dimension of the storage vessel and an analysis showing the capacity of the storage vessel.

(c) Except as provided in paragraphs (f) and (g) of this section, the owner or operator of each storage vessel either with a design capacity greater than or equal to 151 m³ storing a liquid with a maximum true vapor pressure greater than or equal to 3.5 kPa or with a design capacity greater than or equal to 75 m³ but less than 151 m³ storing a liquid with a maximum true vapor pressure greater than or equal to 15.0 kPa shall maintain a record of the VOL stored, the period of storage, and the maximum true vapor pressure of that VOL during the respective storage period.

(d) Except as provided in paragraph (g) of this section, the owner or operator of each storage vessel either with a design capacity greater than or equal to 151 m³ storing a liquid with a maximum true vapor pressure that is normally less than 5.2 kPa or with a design capacity greater than or equal to 75 m³ but less than 151 m³ storing a liquid with a maximum true vapor pressure that is normally less than 27.6 kPa shall notify the Administrator within 30 days when the maximum true vapor pressure of the liquid exceeds the respective maximum true vapor pressure values for each volume range.

(e) Available data on the storage temperature may be used to determine the maximum true vapor pressure as determined below.

(1) For vessels operated above or below ambient temperatures, the maximum true vapor pressure is calculated based upon the highest expected calendar-month average of the storage temperature. For vessels operated at ambient temperatures, the maximum true vapor pressure is calculated based upon the maximum local monthly average ambient temperature as reported by the National Weather Service.

(2) For crude oil or refined petroleum products the vapor pressure may be obtained by the following:

(i) Available data on the Reid vapor pressure and the maximum expected storage temperature based on the highest expected calendar-month average temperature of the stored product may be used to determine the maximum true vapor pressure from nomographs contained in API Bulletin 2517 (incorporated by reference—see § 60.17), unless the Administrator specifically requests that the liquid be sampled, the actual storage temperature determined, and the Reid vapor pressure determined from the sample(s).

(ii) The true vapor pressure of each type of crude oil with a Reid vapor pressure less than 13.8 kPa or with physical properties that preclude determination by the recommended method is to be determined from available data and recorded if the estimated maximum true vapor pressure is greater than 3.5 kPa.

(3) For other liquids, the vapor pressure:

(i) May be obtained from standard reference texts, or

(ii) Determined by ASTM D2879-83, 96, or 97 (incorporated by reference—see § 60.17); or

(iii) Measured by an appropriate method approved by the Administrator; or

(iv) Calculated by an appropriate method approved by the Administrator.

(f) The owner or operator of each vessel storing a waste mixture of indeterminate or variable composition shall be subject to the following requirements.

(1) Prior to the initial filling of the vessel, the highest maximum true vapor pressure for the range of anticipated liquid compositions to be stored will be determined using the methods described in paragraph (e) of this section.

(2) For vessels in which the vapor pressure of the anticipated liquid composition is above the cutoff for monitoring but below the cutoff for controls as defined in § 60.112b(a), an initial physical test of the vapor pressure is required; and a physical test at least once every 6 months thereafter is required as determined by the following methods:

- (i) ASTM D2879-83, 96, or 97 (incorporated by reference—see § 60.17); or
- (ii) ASTM D323-82 or 94 (incorporated by reference—see § 60.17); or
- (iii) As measured by an appropriate method as approved by the Administrator.

(g) The owner or operator of each vessel equipped with a closed vent system and control device meeting the specification of § 60.112b or with emissions reductions equipment as specified in 40 CFR 65.42(b)(4), (b)(5), (b)(6), or (c) is exempt from the requirements of paragraphs (c) and (d) of this section.

[52 FR 11429, Apr. 8, 1987, as amended at 65 FR 61756, Oct. 17, 2000; 65 FR 78276, Dec. 14, 2000; 68 FR 59333, Oct. 15, 2003]

§ 60.117b Delegation of authority.

(a) In delegating implementation and enforcement authority to a State under section 111(c) of the Act, the authorities contained in paragraph (b) of this section shall be retained by the Administrator and not transferred to a State.

(b) Authorities which will not be delegated to States: §§ 60.111b(f)(4), 60.114b, 60.116b(e)(3)(iii), 60.116b(e)(3)(iv), and 60.116b(f)(2)(iii).

[52 FR 11429, Apr. 8, 1987, as amended at 52 FR 22780, June 16, 1987]

For questions or comments regarding e-CFR editorial content, features, or design, email ecfr@nara.gov.
For questions concerning e-CFR programming and delivery issues, email webteam@gpo.gov.

Appendix C – 40 CFR Part 60, Subpart VVa

ELECTRONIC CODE OF FEDERAL REGULATIONS

e-CFR Data is current as of August 30, 2013

Title 40: Protection of Environment

PART 60—STANDARDS OF PERFORMANCE FOR NEW STATIONARY SOURCES

Subpart VVa—Standards of Performance for Equipment Leaks of VOC in the Synthetic Organic Chemicals Manufacturing Industry for Which Construction, Reconstruction, or Modification Commenced After November 7, 2006

Contents

- § 60.480a Applicability and designation of affected facility.
 - § 60.481a Definitions.
 - § 60.482-1a Standards: General.
 - § 60.482-2a Standards: Pumps in light liquid service.
 - § 60.482-3a Standards: Compressors.
 - § 60.482-4a Standards: Pressure relief devices in gas/vapor service.
 - § 60.482-5a Standards: Sampling connection systems.
 - § 60.482-6a Standards: Open-ended valves or lines.
 - § 60.482-7a Standards: Valves in gas/vapor service and in light liquid service.
 - § 60.482-8a Standards: Pumps, valves, and connectors in heavy liquid service and pressure relief devices in light liquid or heavy liquid service.
 - § 60.482-9a Standards: Delay of repair.
 - § 60.482-10a Standards: Closed vent systems and control devices.
 - § 60.482-11a Standards: Connectors in gas/vapor service and in light liquid service.
 - § 60.483-1a Alternative standards for valves—allowable percentage of valves leaking.
 - § 60.483-2a Alternative standards for valves—skip period leak detection and repair.
 - § 60.484a Equivalence of means of emission limitation.
 - § 60.485a Test methods and procedures.
 - § 60.486a Recordkeeping requirements.
 - § 60.487a Reporting requirements.
 - § 60.488a Reconstruction.
 - § 60.489a List of chemicals produced by affected facilities.
-

SOURCE: 72 FR 64883, Nov. 16, 2007, unless otherwise noted.

§ 60.480a Applicability and designation of affected facility.

(a)(1) The provisions of this subpart apply to affected facilities in the synthetic organic chemicals manufacturing industry.

(2) The group of all equipment (defined in § 60.481a) within a process unit is an affected facility.

(b) Any affected facility under paragraph (a) of this section that commences construction, reconstruction, or modification after November 7, 2006, shall be subject to the requirements of this subpart.

(c) Addition or replacement of equipment for the purpose of process improvement which is accomplished without a capital expenditure shall not by itself be considered a modification under this subpart.

(d)(1) If an owner or operator applies for one or more of the exemptions in this paragraph, then the owner or operator shall maintain records as required in § 60.486a(i).

(2) Any affected facility that has the design capacity to produce less than 1,000 Mg/yr (1,102 ton/yr) of a chemical listed in § 60.489 is exempt from §§ 60.482-1a through 60.482-11a.

(3) If an affected facility produces heavy liquid chemicals only from heavy liquid feed or raw materials, then it is exempt from §§ 60.482-1a through 60.482-11a.

(4) Any affected facility that produces beverage alcohol is exempt from §§ 60.482-1a through 60.482-11a.

(5) Any affected facility that has no equipment in volatile organic compounds (VOC) service is exempt from §§ 60.482-1a through 60.482-11a.

(e) *Alternative means of compliance* —(1) *Option to comply with part 65.* (i) Owners or operators may choose to comply with the provisions of 40 CFR part 65, subpart F, to satisfy the requirements of §§ 60.482-1a through 60.487a for an affected facility. When choosing to comply with 40 CFR part 65, subpart F, the requirements of §§ 60.485a(d), (e), and (f), and 60.486a(i) and (j) still apply. Other provisions applying to an owner or operator who chooses to comply with 40 CFR part 65 are provided in 40 CFR 65.1.

(ii) *Part 60, subpart A.* Owners or operators who choose to comply with 40 CFR part 65, subpart F must also comply with §§ 60.1, 60.2, 60.5, 60.6, 60.7(a)(1) and (4), 60.14, 60.15, and 60.16 for that equipment. All sections and paragraphs of subpart A of this part that are not mentioned in this paragraph (e)(1)(ii) do not apply to owners or operators of equipment subject to this subpart complying with 40 CFR part 65, subpart F, except that provisions required to be met prior to implementing 40 CFR part 65 still apply. Owners and operators who choose to comply with 40 CFR part 65, subpart F, must comply with 40 CFR part 65, subpart A.

(2) *Part 63, subpart H.* (i) Owners or operators may choose to comply with the provisions of 40 CFR part 63, subpart H, to satisfy the requirements of §§ 60.482-1a through 60.487a for an affected facility. When choosing to comply with 40 CFR part 63, subpart H, the requirements of § 60.485a(d), (e), and (f), and § 60.486a(i) and (j) still apply.

(ii) *Part 60, subpart A.* Owners or operators who choose to comply with 40 CFR part 63, subpart H must also comply with §§ 60.1, 60.2, 60.5, 60.6, 60.7(a)(1) and (4), 60.14, 60.15, and 60.16 for that equipment. All sections and paragraphs of subpart A of this part that are not mentioned in this paragraph (e)(2)(ii) do not apply to owners or operators of equipment subject to this subpart complying with 40 CFR part 63, subpart H, except that provisions required to be met prior to implementing 40 CFR part 63 still apply. Owners and operators who choose to comply with 40 CFR part 63, subpart H, must comply with 40 CFR part 63, subpart A.

(f) *Stay of standards.* (1) Owners or operators that start a new, reconstructed, or modified affected source prior to November 16, 2007 are not required to comply with the requirements in this paragraph until EPA takes final action to require compliance and publishes a document in the FEDERAL REGISTER .

(i) The definition of “capital expenditure” in § 60.481a of this subpart. While the definition of “capital expenditure” is stayed, owners or operators should use the definition found in § 60.481 of subpart VV of this part.

(ii) [Reserved]

(2) Owners or operators are not required to comply with the requirements in this paragraph until EPA takes final action to require compliance and publishes a document in the FEDERAL REGISTER .

(i) The definition of “process unit” in § 60.481a of this subpart. While the definition of “process unit” is stayed, owners or operators should use the following definition:

Process unit means components assembled to produce, as intermediate or final products, one or more of the chemicals listed in § 60.489 of this part. A process unit can operate independently if supplied with sufficient feed or raw materials and sufficient storage facilities for the product.

(ii) The method of allocation of shared storage vessels in § 60.482-1a(g) of this subpart.

(iii) The standards for connectors in gas/vapor service and in light liquid service in § 60.482-11a of this subpart.

[72 FR 64883, Nov. 16, 2007, as amended at 73 FR 31375, June 2, 2008]

§ 60.481a Definitions.

As used in this subpart, all terms not defined herein shall have the meaning given them in the Clean Air Act (CAA) or in subpart A of part 60, and the following terms shall have the specific meanings given them.

Capital expenditure means, in addition to the definition in 40 CFR 60.2, an expenditure for a physical or operational change to an existing facility that:

(a) Exceeds P, the product of the facility's replacement cost, R, and an adjusted annual asset guideline repair allowance, A, as reflected by the following equation: $P = R \times A$, where:

(1) The adjusted annual asset guideline repair allowance, A, is the product of the percent of the replacement cost, Y, and the applicable basic annual asset guideline repair allowance, B, divided by 100 as reflected by the following equation:

$$A = Y \times (B \div 100);$$

(2) The percent Y is determined from the following equation: $Y = 1.0 - 0.575 \log X$, where X is 2006 minus the year of construction; and

(3) The applicable basic annual asset guideline repair allowance, B, is selected from the following table consistent with the applicable subpart:

TABLE FOR DETERMINING APPLICABLE VALUE FOR B

Subpart applicable to facility	Value of B to be used in equation
VVa	12.5
GGGa	7.0

Closed-loop system means an enclosed system that returns process fluid to the process.

Closed-purge system means a system or combination of systems and portable containers to capture purged liquids. Containers for purged liquids must be covered or closed when not being filled or emptied.

Closed vent system means a system that is not open to the atmosphere and that is composed of hard-piping, ductwork, connections, and, if necessary, flow-inducing devices that transport gas or vapor from a piece or pieces of equipment to a control device or back to a process.

Connector means flanged, screwed, or other joined fittings used to connect two pipe lines or a pipe line and a piece of process equipment or that close an opening in a pipe that could be connected

to another pipe. Joined fittings welded completely around the circumference of the interface are not considered connectors for the purpose of this regulation.

Control device means an enclosed combustion device, vapor recovery system, or flare.

Distance piece means an open or enclosed casing through which the piston rod travels, separating the compressor cylinder from the crankcase.

Double block and bleed system means two block valves connected in series with a bleed valve or line that can vent the line between the two block valves.

Duct work means a conveyance system such as those commonly used for heating and ventilation systems. It is often made of sheet metal and often has sections connected by screws or crimping. Hard-piping is not ductwork.

Equipment means each pump, compressor, pressure relief device, sampling connection system, open-ended valve or line, valve, and flange or other connector in VOC service and any devices or systems required by this subpart.

First attempt at repair means to take action for the purpose of stopping or reducing leakage of organic material to the atmosphere using best practices.

Fuel gas means gases that are combusted to derive useful work or heat.

Fuel gas system means the offsite and onsite piping and flow and pressure control system that gathers gaseous stream(s) generated by onsite operations, may blend them with other sources of gas, and transports the gaseous stream for use as fuel gas in combustion devices or in-process combustion equipment, such as furnaces and gas turbines, either singly or in combination.

Hard-piping means pipe or tubing that is manufactured and properly installed using good engineering judgment and standards such as ASME B31.3, Process Piping (available from the American Society of Mechanical Engineers, P.O. Box 2300, Fairfield, NJ 07007-2300).

In gas/vapor service means that the piece of equipment contains process fluid that is in the gaseous state at operating conditions.

In heavy liquid service means that the piece of equipment is not in gas/vapor service or in light liquid service.

In light liquid service means that the piece of equipment contains a liquid that meets the conditions specified in § 60.485a(e).

In-situ sampling systems means nonextractive samplers or in-line samplers.

In vacuum service means that equipment is operating at an internal pressure which is at least 5 kilopascals (kPa) (0.7 psia) below ambient pressure.

In VOC service means that the piece of equipment contains or contacts a process fluid that is at least 10 percent VOC by weight. (The provisions of § 60.485a(d) specify how to determine that a piece of equipment is not in VOC service.)

Initial calibration value means the concentration measured during the initial calibration at the beginning of each day required in § 60.485a(b)(1), or the most recent calibration if the instrument is recalibrated during the day (i.e., the calibration is adjusted) after a calibration drift assessment.

Liquids dripping means any visible leakage from the seal including spraying, misting, clouding, and ice formation.

Open-ended valve or line means any valve, except safety relief valves, having one side of the valve seat in contact with process fluid and one side open to the atmosphere, either directly or through open piping.

Pressure release means the emission of materials resulting from system pressure being greater than set pressure of the pressure relief device.

Process improvement means routine changes made for safety and occupational health requirements, for energy savings, for better utility, for ease of maintenance and operation, for correction of design deficiencies, for bottleneck removal, for changing product requirements, or for environmental control.

Process unit means the components assembled and connected by pipes or ducts to process raw materials and to produce, as intermediate or final products, one or more of the chemicals listed in § 60.489. A process unit can operate independently if supplied with sufficient feed or raw materials and sufficient storage facilities for the product. For the purpose of this subpart, process unit includes any feed, intermediate and final product storage vessels (except as specified in § 60.482-1a(g)), product transfer racks, and connected ducts and piping. A process unit includes all equipment as defined in this subpart.

Process unit shutdown means a work practice or operational procedure that stops production from a process unit or part of a process unit during which it is technically feasible to clear process material from a process unit or part of a process unit consistent with safety constraints and during which repairs can be accomplished. The following are not considered process unit shutdowns:

(1) An unscheduled work practice or operational procedure that stops production from a process unit or part of a process unit for less than 24 hours.

(2) An unscheduled work practice or operational procedure that would stop production from a process unit or part of a process unit for a shorter period of time than would be required to clear the process unit or part of the process unit of materials and start up the unit, and would result in greater emissions than delay of repair of leaking components until the next scheduled process unit shutdown.

(3) The use of spare equipment and technically feasible bypassing of equipment without stopping production.

Quarter means a 3-month period; the first quarter concludes on the last day of the last full month during the 180 days following initial startup.

Repaired means that equipment is adjusted, or otherwise altered, in order to eliminate a leak as defined in the applicable sections of this subpart and, except for leaks identified in accordance with §§ 60.482-2a(b)(2)(ii) and (d)(6)(ii) and (d)(6)(iii), 60.482-3a(f), and 60.482-10a(f)(1)(ii), is re-monitored as specified in § 60.485a(b) to verify that emissions from the equipment are below the applicable leak definition.

Replacement cost means the capital needed to purchase all the depreciable components in a facility.

Sampling connection system means an assembly of equipment within a process unit used during periods of representative operation to take samples of the process fluid. Equipment used to take nonroutine grab samples is not considered a sampling connection system.

Sensor means a device that measures a physical quantity or the change in a physical quantity such as temperature, pressure, flow rate, pH, or liquid level.

Storage vessel means a tank or other vessel that is used to store organic liquids that are used in the process as raw material feedstocks, produced as intermediates or final products, or generated as wastes. Storage vessel does not include vessels permanently attached to motor vehicles, such as trucks, railcars, barges or ships.

Synthetic organic chemicals manufacturing industry means the industry that produces, as intermediates or final products, one or more of the chemicals listed in § 60.489.

Transfer rack means the collection of loading arms and loading hoses, at a single loading rack, that are used to fill tank trucks and/or railcars with organic liquids.

Volatile organic compounds or VOC means, for the purposes of this subpart, any reactive organic compounds as defined in § 60.2 Definitions.

EFFECTIVE DATE NOTE: At 73 FR 31376, June 2, 2008, in § 60.481a, the definitions of “capital expenditure” and “process unit” were stayed until further notice.

§ 60.482-1a Standards: General.

(a) Each owner or operator subject to the provisions of this subpart shall demonstrate compliance with the requirements of §§ 60.482-1a through 60.482-10a or § 60.480a(e) for all equipment within 180 days of initial startup.

(b) Compliance with §§ 60.482-1a to 60.482-10a will be determined by review of records and reports, review of performance test results, and inspection using the methods and procedures specified in § 60.485a.

(c)(1) An owner or operator may request a determination of equivalence of a means of emission limitation to the requirements of §§ 60.482-2a, 60.482-3a, 60.482-5a, 60.482-6a, 60.482-7a, 60.482-8a, and 60.482-10a as provided in § 60.484a.

(2) If the Administrator makes a determination that a means of emission limitation is at least equivalent to the requirements of §§ 60.482-2a, 60.482-3a, 60.482-5a, 60.482-6a, 60.482-7a, 60.482-8a, or 60.482-10a, an owner or operator shall comply with the requirements of that determination.

(d) Equipment that is in vacuum service is excluded from the requirements of §§ 60.482-2a through 60.482-10a if it is identified as required in § 60.486a(e)(5).

(e) Equipment that an owner or operator designates as being in VOC service less than 300 hr/yr is excluded from the requirements of §§ 60.482-2a through 60.482-11a if it is identified as required in § 60.486a(e)(6) and it meets any of the conditions specified in paragraphs (e)(1) through (3) of this section.

(1) The equipment is in VOC service only during startup and shutdown, excluding startup and shutdown between batches of the same campaign for a batch process.

(2) The equipment is in VOC service only during process malfunctions or other emergencies.

(3) The equipment is backup equipment that is in VOC service only when the primary equipment is out of service.

(f)(1) If a dedicated batch process unit operates less than 365 days during a year, an owner or operator may monitor to detect leaks from pumps, valves, and open-ended valves or lines at the frequency specified in the following table instead of monitoring as specified in §§ 60.482-2a, 60.482-7a, and 60.483.2a:

Operating time (percent of hours during year)	Equivalent monitoring frequency time in use		
	Monthly	Quarterly	Semiannually
0 to <25	Quarterly	Annually	Annually.
25 to <50	Quarterly	Semiannually	Annually.
50 to <75	Bimonthly	Three quarters	Semiannually.
75 to 100	Monthly	Quarterly	Semiannually.

(2) Pumps and valves that are shared among two or more batch process units that are subject to this subpart may be monitored at the frequencies specified in paragraph (f)(1) of this section, provided the operating time of all such process units is considered.

(3) The monitoring frequencies specified in paragraph (f)(1) of this section are not requirements for monitoring at specific intervals and can be adjusted to accommodate process operations. An owner or operator may monitor at any time during the specified monitoring period (e.g., month, quarter, year), provided the monitoring is conducted at a reasonable interval after completion of the last monitoring campaign. Reasonable intervals are defined in paragraphs (f)(3)(i) through (iv) of this section.

(i) When monitoring is conducted quarterly, monitoring events must be separated by at least 30 calendar days.

(ii) When monitoring is conducted semiannually (*i.e.* , once every 2 quarters), monitoring events must be separated by at least 60 calendar days.

(iii) When monitoring is conducted in 3 quarters per year, monitoring events must be separated by at least 90 calendar days.

(iv) When monitoring is conducted annually, monitoring events must be separated by at least 120 calendar days.

(g) If the storage vessel is shared with multiple process units, the process unit with the greatest annual amount of stored materials (predominant use) is the process unit the storage vessel is assigned to. If the storage vessel is shared equally among process units, and one of the process units has equipment subject to this subpart, the storage vessel is assigned to that process unit. If the storage vessel is shared equally among process units, none of which have equipment subject to this subpart of this part, the storage vessel is assigned to any process unit subject to subpart VV of this part. If the predominant use of the storage vessel varies from year to year, then the owner or operator must estimate the predominant use initially and reassess every 3 years. The owner or operator must keep records of the information and supporting calculations that show how predominant use is determined. All equipment on the storage vessel must be monitored when in VOC service.

EFFECTIVE DATE NOTE: At 73 FR 31376, June 2, 2008, in § 60.482-1a, paragraph (g) was stayed until further notice.

§ 60.482-2a Standards: Pumps in light liquid service.

(a)(1) Each pump in light liquid service shall be monitored monthly to detect leaks by the methods specified in § 60.485a(b), except as provided in § 60.482-1a(c) and (f) and paragraphs (d), (e), and (f) of this section. A pump that begins operation in light liquid service after the initial startup date for the process unit must be monitored for the first time within 30 days after the end of its startup period, except for a pump that replaces a leaking pump and except as provided in § 60.482-1a(c) and paragraphs (d), (e), and (f) of this section.

(2) Each pump in light liquid service shall be checked by visual inspection each calendar week for indications of liquids dripping from the pump seal, except as provided in § 60.482-1a(f).

(b)(1) The instrument reading that defines a leak is specified in paragraphs (b)(1)(i) and (ii) of this section.

(i) 5,000 parts per million (ppm) or greater for pumps handling polymerizing monomers;

(ii) 2,000 ppm or greater for all other pumps.

(2) If there are indications of liquids dripping from the pump seal, the owner or operator shall follow the procedure specified in either paragraph (b)(2)(i) or (ii) of this section. This requirement does not apply to a pump that was monitored after a previous weekly inspection and the instrument reading was less than the concentration specified in paragraph (b)(1)(i) or (ii) of this section, whichever is applicable.

(i) Monitor the pump within 5 days as specified in § 60.485a(b). A leak is detected if the instrument reading measured during monitoring indicates a leak as specified in paragraph (b)(1)(i) or (ii) of this section, whichever is applicable. The leak shall be repaired using the procedures in paragraph (c) of this section.

(ii) Designate the visual indications of liquids dripping as a leak, and repair the leak using either the procedures in paragraph (c) of this section or by eliminating the visual indications of liquids dripping.

(c)(1) When a leak is detected, it shall be repaired as soon as practicable, but not later than 15 calendar days after it is detected, except as provided in § 60.482-9a.

(2) A first attempt at repair shall be made no later than 5 calendar days after each leak is detected. First attempts at repair include, but are not limited to, the practices described in paragraphs (c)(2)(i) and (ii) of this section, where practicable.

(i) Tightening the packing gland nuts;

(ii) Ensuring that the seal flush is operating at design pressure and temperature.

(d) Each pump equipped with a dual mechanical seal system that includes a barrier fluid system is exempt from the requirements of paragraph (a) of this section, provided the requirements specified in paragraphs (d)(1) through (6) of this section are met.

(1) Each dual mechanical seal system is:

(i) Operated with the barrier fluid at a pressure that is at all times greater than the pump stuffing box pressure; or

(ii) Equipped with a barrier fluid degassing reservoir that is routed to a process or fuel gas system or connected by a closed vent system to a control device that complies with the requirements of § 60.482-10a; or

(iii) Equipped with a system that purges the barrier fluid into a process stream with zero VOC emissions to the atmosphere.

(2) The barrier fluid system is in heavy liquid service or is not in VOC service.

(3) Each barrier fluid system is equipped with a sensor that will detect failure of the seal system, the barrier fluid system, or both.

(4)(i) Each pump is checked by visual inspection, each calendar week, for indications of liquids dripping from the pump seals.

(ii) If there are indications of liquids dripping from the pump seal at the time of the weekly inspection, the owner or operator shall follow the procedure specified in either paragraph (d)(4)(ii)(A) or (B) of this section prior to the next required inspection.

(A) Monitor the pump within 5 days as specified in § 60.485a(b) to determine if there is a leak of VOC in the barrier fluid. If an instrument reading of 2,000 ppm or greater is measured, a leak is detected.

(B) Designate the visual indications of liquids dripping as a leak.

(5)(i) Each sensor as described in paragraph (d)(3) is checked daily or is equipped with an audible alarm.

(ii) The owner or operator determines, based on design considerations and operating experience, a criterion that indicates failure of the seal system, the barrier fluid system, or both.

(iii) If the sensor indicates failure of the seal system, the barrier fluid system, or both, based on the criterion established in paragraph (d)(5)(ii) of this section, a leak is detected.

(6)(i) When a leak is detected pursuant to paragraph (d)(4)(ii)(A) of this section, it shall be repaired as specified in paragraph (c) of this section.

(ii) A leak detected pursuant to paragraph (d)(5)(iii) of this section shall be repaired within 15 days of detection by eliminating the conditions that activated the sensor.

(iii) A designated leak pursuant to paragraph (d)(4)(ii)(B) of this section shall be repaired within 15 days of detection by eliminating visual indications of liquids dripping.

(e) Any pump that is designated, as described in § 60.486a(e)(1) and (2), for no detectable emissions, as indicated by an instrument reading of less than 500 ppm above background, is exempt from the requirements of paragraphs (a), (c), and (d) of this section if the pump:

(1) Has no externally actuated shaft penetrating the pump housing;

(2) Is demonstrated to be operating with no detectable emissions as indicated by an instrument reading of less than 500 ppm above background as measured by the methods specified in § 60.485a (c); and

(3) Is tested for compliance with paragraph (e)(2) of this section initially upon designation, annually, and at other times requested by the Administrator.

(f) If any pump is equipped with a closed vent system capable of capturing and transporting any leakage from the seal or seals to a process or to a fuel gas system or to a control device that complies with the requirements of § 60.482-10a, it is exempt from paragraphs (a) through (e) of this section.

(g) Any pump that is designated, as described in § 60.486a(f)(1), as an unsafe-to-monitor pump is exempt from the monitoring and inspection requirements of paragraphs (a) and (d)(4) through (6) of this section if:

(1) The owner or operator of the pump demonstrates that the pump is unsafe-to-monitor because monitoring personnel would be exposed to an immediate danger as a consequence of complying with paragraph (a) of this section; and

(2) The owner or operator of the pump has a written plan that requires monitoring of the pump as frequently as practicable during safe-to-monitor times, but not more frequently than the periodic monitoring schedule otherwise applicable, and repair of the equipment according to the procedures in paragraph (c) of this section if a leak is detected.

(h) Any pump that is located within the boundary of an unmanned plant site is exempt from the weekly visual inspection requirement of paragraphs (a)(2) and (d)(4) of this section, and the daily requirements of paragraph (d)(5) of this section, provided that each pump is visually inspected as often as practicable and at least monthly.

§ 60.482-3a Standards: Compressors.

(a) Each compressor shall be equipped with a seal system that includes a barrier fluid system and that prevents leakage of VOC to the atmosphere, except as provided in § 60.482-1a(c) and paragraphs (h), (i), and (j) of this section.

(b) Each compressor seal system as required in paragraph (a) of this section shall be:

(1) Operated with the barrier fluid at a pressure that is greater than the compressor stuffing box pressure; or

(2) Equipped with a barrier fluid system degassing reservoir that is routed to a process or fuel gas system or connected by a closed vent system to a control device that complies with the requirements of § 60.482-10a; or

(3) Equipped with a system that purges the barrier fluid into a process stream with zero VOC emissions to the atmosphere.

(c) The barrier fluid system shall be in heavy liquid service or shall not be in VOC service.

(d) Each barrier fluid system as described in paragraph (a) shall be equipped with a sensor that will detect failure of the seal system, barrier fluid system, or both.

(e)(1) Each sensor as required in paragraph (d) of this section shall be checked daily or shall be equipped with an audible alarm.

(2) The owner or operator shall determine, based on design considerations and operating experience, a criterion that indicates failure of the seal system, the barrier fluid system, or both.

(f) If the sensor indicates failure of the seal system, the barrier system, or both based on the criterion determined under paragraph (e)(2) of this section, a leak is detected.

(g)(1) When a leak is detected, it shall be repaired as soon as practicable, but not later than 15 calendar days after it is detected, except as provided in § 60.482-9a.

(2) A first attempt at repair shall be made no later than 5 calendar days after each leak is detected.

(h) A compressor is exempt from the requirements of paragraphs (a) and (b) of this section, if it is equipped with a closed vent system to capture and transport leakage from the compressor drive shaft back to a process or fuel gas system or to a control device that complies with the requirements of § 60.482-10a, except as provided in paragraph (i) of this section.

(i) Any compressor that is designated, as described in § 60.486a(e)(1) and (2), for no detectable emissions, as indicated by an instrument reading of less than 500 ppm above background, is exempt from the requirements of paragraphs (a) through (h) of this section if the compressor:

(1) Is demonstrated to be operating with no detectable emissions, as indicated by an instrument reading of less than 500 ppm above background, as measured by the methods specified in § 60.485a(c); and

(2) Is tested for compliance with paragraph (i)(1) of this section initially upon designation, annually, and at other times requested by the Administrator.

(j) Any existing reciprocating compressor in a process unit which becomes an affected facility under provisions of § 60.14 or § 60.15 is exempt from paragraphs (a) through (e) and (h) of this section, provided the owner or operator demonstrates that recasting the distance piece or replacing the compressor are the only options available to bring the compressor into compliance with the provisions of paragraphs (a) through (e) and (h) of this section.

§ 60.482-4a Standards: Pressure relief devices in gas/vapor service.

(a) Except during pressure releases, each pressure relief device in gas/vapor service shall be operated with no detectable emissions, as indicated by an instrument reading of less than 500 ppm above background, as determined by the methods specified in § 60.485a(c).

(b)(1) After each pressure release, the pressure relief device shall be returned to a condition of no detectable emissions, as indicated by an instrument reading of less than 500 ppm above background, as soon as practicable, but no later than 5 calendar days after the pressure release, except as provided in § 60.482-9a.

(2) No later than 5 calendar days after the pressure release, the pressure relief device shall be monitored to confirm the conditions of no detectable emissions, as indicated by an instrument reading of less than 500 ppm above background, by the methods specified in § 60.485a(c).

(c) Any pressure relief device that is routed to a process or fuel gas system or equipped with a closed vent system capable of capturing and transporting leakage through the pressure relief device to a control device as described in § 60.482-10a is exempted from the requirements of paragraphs (a) and (b) of this section.

(d)(1) Any pressure relief device that is equipped with a rupture disk upstream of the pressure relief device is exempt from the requirements of paragraphs (a) and (b) of this section, provided the owner or operator complies with the requirements in paragraph (d)(2) of this section.

(2) After each pressure release, a new rupture disk shall be installed upstream of the pressure relief device as soon as practicable, but no later than 5 calendar days after each pressure release, except as provided in § 60.482-9a.

§ 60.482-5a Standards: Sampling connection systems.

(a) Each sampling connection system shall be equipped with a closed-purge, closed-loop, or closed-vent system, except as provided in § 60.482-1a(c) and paragraph (c) of this section.

(b) Each closed-purge, closed-loop, or closed-vent system as required in paragraph (a) of this section shall comply with the requirements specified in paragraphs (b)(1) through (4) of this section.

(1) Gases displaced during filling of the sample container are not required to be collected or captured.

(2) Containers that are part of a closed-purge system must be covered or closed when not being filled or emptied.

(3) Gases remaining in the tubing or piping between the closed-purge system valve(s) and sample container valve(s) after the valves are closed and the sample container is disconnected are not required to be collected or captured.

(4) Each closed-purge, closed-loop, or closed-vent system shall be designed and operated to meet requirements in either paragraph (b)(4)(i), (ii), (iii), or (iv) of this section.

(i) Return the purged process fluid directly to the process line.

(ii) Collect and recycle the purged process fluid to a process.

(iii) Capture and transport all the purged process fluid to a control device that complies with the requirements of § 60.482-10a.

(iv) Collect, store, and transport the purged process fluid to any of the following systems or facilities:

(A) A waste management unit as defined in 40 CFR 63.111, if the waste management unit is subject to and operated in compliance with the provisions of 40 CFR part 63, subpart G, applicable to Group 1 wastewater streams;

(B) A treatment, storage, or disposal facility subject to regulation under 40 CFR part 262, 264, 265, or 266;

(C) A facility permitted, licensed, or registered by a state to manage municipal or industrial solid waste, if the process fluids are not hazardous waste as defined in 40 CFR part 261;

(D) A waste management unit subject to and operated in compliance with the treatment requirements of 40 CFR 61.348(a), provided all waste management units that collect, store, or

transport the purged process fluid to the treatment unit are subject to and operated in compliance with the management requirements of 40 CFR 61.343 through 40 CFR 61.347; or

(E) A device used to burn off-specification used oil for energy recovery in accordance with 40 CFR part 279, subpart G, provided the purged process fluid is not hazardous waste as defined in 40 CFR part 261.

(c) In-situ sampling systems and sampling systems without purges are exempt from the requirements of paragraphs (a) and (b) of this section.

§ 60.482-6a Standards: Open-ended valves or lines.

(a)(1) Each open-ended valve or line shall be equipped with a cap, blind flange, plug, or a second valve, except as provided in § 60.482-1a(c) and paragraphs (d) and (e) of this section.

(2) The cap, blind flange, plug, or second valve shall seal the open end at all times except during operations requiring process fluid flow through the open-ended valve or line.

(b) Each open-ended valve or line equipped with a second valve shall be operated in a manner such that the valve on the process fluid end is closed before the second valve is closed.

(c) When a double block-and-bleed system is being used, the bleed valve or line may remain open during operations that require venting the line between the block valves but shall comply with paragraph (a) of this section at all other times.

(d) Open-ended valves or lines in an emergency shutdown system which are designed to open automatically in the event of a process upset are exempt from the requirements of paragraphs (a), (b), and (c) of this section.

(e) Open-ended valves or lines containing materials which would autocatalytically polymerize or would present an explosion, serious overpressure, or other safety hazard if capped or equipped with a double block and bleed system as specified in paragraphs (a) through (c) of this section are exempt from the requirements of paragraphs (a) through (c) of this section.

§ 60.482-7a Standards: Valves in gas/vapor service and in light liquid service.

(a)(1) Each valve shall be monitored monthly to detect leaks by the methods specified in § 60.485a(b) and shall comply with paragraphs (b) through (e) of this section, except as provided in paragraphs (f), (g), and (h) of this section, § 60.482-1a(c) and (f), and §§ 60.483-1a and 60.483-2a.

(2) A valve that begins operation in gas/vapor service or light liquid service after the initial startup date for the process unit must be monitored according to paragraphs (a)(2)(i) or (ii), except for a valve that replaces a leaking valve and except as provided in paragraphs (f), (g), and (h) of this section, § 60.482-1a(c), and §§ 60.483-1a and 60.483-2a.

(i) Monitor the valve as in paragraph (a)(1) of this section. The valve must be monitored for the first time within 30 days after the end of its startup period to ensure proper installation.

(ii) If the existing valves in the process unit are monitored in accordance with § 60.483-1a or § 60.483-2a, count the new valve as leaking when calculating the percentage of valves leaking as described in § 60.483-2a(b)(5). If less than 2.0 percent of the valves are leaking for that process unit, the valve must be monitored for the first time during the next scheduled monitoring event for existing valves in the process unit or within 90 days, whichever comes first.

(b) If an instrument reading of 500 ppm or greater is measured, a leak is detected.

(c)(1)(i) Any valve for which a leak is not detected for 2 successive months may be monitored the first month of every quarter, beginning with the next quarter, until a leak is detected.

(ii) As an alternative to monitoring all of the valves in the first month of a quarter, an owner or operator may elect to subdivide the process unit into two or three subgroups of valves and monitor each subgroup in a different month during the quarter, provided each subgroup is monitored every 3 months. The owner or operator must keep records of the valves assigned to each subgroup.

(2) If a leak is detected, the valve shall be monitored monthly until a leak is not detected for 2 successive months.

(d)(1) When a leak is detected, it shall be repaired as soon as practicable, but no later than 15 calendar days after the leak is detected, except as provided in § 60.482-9a.

(2) A first attempt at repair shall be made no later than 5 calendar days after each leak is detected.

(e) First attempts at repair include, but are not limited to, the following best practices where practicable:

- (1) Tightening of bonnet bolts;
- (2) Replacement of bonnet bolts;
- (3) Tightening of packing gland nuts;
- (4) Injection of lubricant into lubricated packing.

(f) Any valve that is designated, as described in § 60.486a(e)(2), for no detectable emissions, as indicated by an instrument reading of less than 500 ppm above background, is exempt from the requirements of paragraph (a) of this section if the valve:

- (1) Has no external actuating mechanism in contact with the process fluid,
- (2) Is operated with emissions less than 500 ppm above background as determined by the method specified in § 60.485a(c), and
- (3) Is tested for compliance with paragraph (f)(2) of this section initially upon designation, annually, and at other times requested by the Administrator.

(g) Any valve that is designated, as described in § 60.486a(f)(1), as an unsafe-to-monitor valve is exempt from the requirements of paragraph (a) of this section if:

- (1) The owner or operator of the valve demonstrates that the valve is unsafe to monitor because monitoring personnel would be exposed to an immediate danger as a consequence of complying with paragraph (a) of this section, and
- (2) The owner or operator of the valve adheres to a written plan that requires monitoring of the valve as frequently as practicable during safe-to-monitor times.

(h) Any valve that is designated, as described in § 60.486a(f)(2), as a difficult-to-monitor valve is exempt from the requirements of paragraph (a) of this section if:

(1) The owner or operator of the valve demonstrates that the valve cannot be monitored without elevating the monitoring personnel more than 2 meters above a support surface.

(2) The process unit within which the valve is located either:

(i) Becomes an affected facility through § 60.14 or § 60.15 and was constructed on or before January 5, 1981; or

(ii) Has less than 3.0 percent of its total number of valves designated as difficult-to-monitor by the owner or operator.

(3) The owner or operator of the valve follows a written plan that requires monitoring of the valve at least once per calendar year.

§ 60.482-8a Standards: Pumps, valves, and connectors in heavy liquid service and pressure relief devices in light liquid or heavy liquid service.

(a) If evidence of a potential leak is found by visual, audible, olfactory, or any other detection method at pumps, valves, and connectors in heavy liquid service and pressure relief devices in light liquid or heavy liquid service, the owner or operator shall follow either one of the following procedures:

(1) The owner or operator shall monitor the equipment within 5 days by the method specified in § 60.485a(b) and shall comply with the requirements of paragraphs (b) through (d) of this section.

(2) The owner or operator shall eliminate the visual, audible, olfactory, or other indication of a potential leak within 5 calendar days of detection.

(b) If an instrument reading of 10,000 ppm or greater is measured, a leak is detected.

(c)(1) When a leak is detected, it shall be repaired as soon as practicable, but not later than 15 calendar days after it is detected, except as provided in § 60.482-9a.

(2) The first attempt at repair shall be made no later than 5 calendar days after each leak is detected.

(d) First attempts at repair include, but are not limited to, the best practices described under §§ 60.482-2a(c)(2) and 60.482-7a(e).

§ 60.482-9a Standards: Delay of repair.

(a) Delay of repair of equipment for which leaks have been detected will be allowed if repair within 15 days is technically infeasible without a process unit shutdown. Repair of this equipment shall occur before the end of the next process unit shutdown. Monitoring to verify repair must occur within 15 days after startup of the process unit.

(b) Delay of repair of equipment will be allowed for equipment which is isolated from the process and which does not remain in VOC service.

(c) Delay of repair for valves and connectors will be allowed if:

(1) The owner or operator demonstrates that emissions of purged material resulting from immediate repair are greater than the fugitive emissions likely to result from delay of repair, and

(2) When repair procedures are effected, the purged material is collected and destroyed or recovered in a control device complying with § 60.482-10a.

(d) Delay of repair for pumps will be allowed if:

(1) Repair requires the use of a dual mechanical seal system that includes a barrier fluid system, and

(2) Repair is completed as soon as practicable, but not later than 6 months after the leak was detected.

(e) Delay of repair beyond a process unit shutdown will be allowed for a valve, if valve assembly replacement is necessary during the process unit shutdown, valve assembly supplies have been depleted, and valve assembly supplies had been sufficiently stocked before the supplies were depleted. Delay of repair beyond the next process unit shutdown will not be allowed unless the next process unit shutdown occurs sooner than 6 months after the first process unit shutdown.

(f) When delay of repair is allowed for a leaking pump, valve, or connector that remains in service, the pump, valve, or connector may be considered to be repaired and no longer subject to delay of repair requirements if two consecutive monthly monitoring instrument readings are below the leak definition.

§ 60.482-10a Standards: Closed vent systems and control devices.

(a) Owners or operators of closed vent systems and control devices used to comply with provisions of this subpart shall comply with the provisions of this section.

(b) Vapor recovery systems (for example, condensers and absorbers) shall be designed and operated to recover the VOC emissions vented to them with an efficiency of 95 percent or greater, or to an exit concentration of 20 parts per million by volume (ppmv), whichever is less stringent.

(c) Enclosed combustion devices shall be designed and operated to reduce the VOC emissions vented to them with an efficiency of 95 percent or greater, or to an exit concentration of 20 ppmv, on a dry basis, corrected to 3 percent oxygen, whichever is less stringent or to provide a minimum residence time of 0.75 seconds at a minimum temperature of 816 °C.

(d) Flares used to comply with this subpart shall comply with the requirements of § 60.18.

(e) Owners or operators of control devices used to comply with the provisions of this subpart shall monitor these control devices to ensure that they are operated and maintained in conformance with their designs.

(f) Except as provided in paragraphs (i) through (k) of this section, each closed vent system shall be inspected according to the procedures and schedule specified in paragraphs (f)(1) and (2) of this section.

(1) If the vapor collection system or closed vent system is constructed of hard-piping, the owner or operator shall comply with the requirements specified in paragraphs (f)(1)(i) and (ii) of this section:

- (i) Conduct an initial inspection according to the procedures in § 60.485a(b); and
- (ii) Conduct annual visual inspections for visible, audible, or olfactory indications of leaks.

(2) If the vapor collection system or closed vent system is constructed of ductwork, the owner or operator shall:

- (i) Conduct an initial inspection according to the procedures in § 60.485a(b); and
- (ii) Conduct annual inspections according to the procedures in § 60.485a(b).

(g) Leaks, as indicated by an instrument reading greater than 500 ppmv above background or by visual inspections, shall be repaired as soon as practicable except as provided in paragraph (h) of this section.

(1) A first attempt at repair shall be made no later than 5 calendar days after the leak is detected.

(2) Repair shall be completed no later than 15 calendar days after the leak is detected.

(h) Delay of repair of a closed vent system for which leaks have been detected is allowed if the repair is technically infeasible without a process unit shutdown or if the owner or operator determines that emissions resulting from immediate repair would be greater than the fugitive emissions likely to result from delay of repair. Repair of such equipment shall be complete by the end of the next process unit shutdown.

(i) If a vapor collection system or closed vent system is operated under a vacuum, it is exempt from the inspection requirements of paragraphs (f)(1)(i) and (f)(2) of this section.

(j) Any parts of the closed vent system that are designated, as described in paragraph (l)(1) of this section, as unsafe to inspect are exempt from the inspection requirements of paragraphs (f)(1)(i) and (f)(2) of this section if they comply with the requirements specified in paragraphs (j)(1) and (2) of this section:

(1) The owner or operator determines that the equipment is unsafe to inspect because inspecting personnel would be exposed to an imminent or potential danger as a consequence of complying with paragraphs (f)(1)(i) or (f)(2) of this section; and

(2) The owner or operator has a written plan that requires inspection of the equipment as frequently as practicable during safe-to-inspect times.

(k) Any parts of the closed vent system that are designated, as described in paragraph (l)(2) of this section, as difficult to inspect are exempt from the inspection requirements of paragraphs (f)(1)(i) and (f)(2) of this section if they comply with the requirements specified in paragraphs (k)(1) through (3) of this section:

(1) The owner or operator determines that the equipment cannot be inspected without elevating the inspecting personnel more than 2 meters above a support surface; and

(2) The process unit within which the closed vent system is located becomes an affected facility through §§ 60.14 or 60.15, or the owner or operator designates less than 3.0 percent of the total number of closed vent system equipment as difficult to inspect; and

(3) The owner or operator has a written plan that requires inspection of the equipment at least once every 5 years. A closed vent system is exempt from inspection if it is operated under a vacuum.

(l) The owner or operator shall record the information specified in paragraphs (l)(1) through (5) of this section.

(1) Identification of all parts of the closed vent system that are designated as unsafe to inspect, an explanation of why the equipment is unsafe to inspect, and the plan for inspecting the equipment.

(2) Identification of all parts of the closed vent system that are designated as difficult to inspect, an explanation of why the equipment is difficult to inspect, and the plan for inspecting the equipment.

(3) For each inspection during which a leak is detected, a record of the information specified in § 60.486a(c).

(4) For each inspection conducted in accordance with § 60.485a(b) during which no leaks are detected, a record that the inspection was performed, the date of the inspection, and a statement that no leaks were detected.

(5) For each visual inspection conducted in accordance with paragraph (f)(1)(ii) of this section during which no leaks are detected, a record that the inspection was performed, the date of the inspection, and a statement that no leaks were detected.

(m) Closed vent systems and control devices used to comply with provisions of this subpart shall be operated at all times when emissions may be vented to them.

§ 60.482-11a Standards: Connectors in gas/vapor service and in light liquid service.

(a) The owner or operator shall initially monitor all connectors in the process unit for leaks by the later of either 12 months after the compliance date or 12 months after initial startup. If all connectors in the process unit have been monitored for leaks prior to the compliance date, no initial monitoring is required provided either no process changes have been made since the monitoring or the owner or operator can determine that the results of the monitoring, with or without adjustments, reliably demonstrate compliance despite process changes. If required to monitor because of a process change, the owner or operator is required to monitor only those connectors involved in the process change.

(b) Except as allowed in § 60.482-1a(c), § 60.482-10a, or as specified in paragraph (e) of this section, the owner or operator shall monitor all connectors in gas and vapor and light liquid service as specified in paragraphs (a) and (b)(3) of this section.

(1) The connectors shall be monitored to detect leaks by the method specified in § 60.485a(b) and, as applicable, § 60.485a(c).

(2) If an instrument reading greater than or equal to 500 ppm is measured, a leak is detected.

(3) The owner or operator shall perform monitoring, subsequent to the initial monitoring required in paragraph (a) of this section, as specified in paragraphs (b)(3)(i) through (iii) of this section, and shall comply with the requirements of paragraphs (b)(3)(iv) and (v) of this section. The required period in which monitoring must be conducted shall be determined from paragraphs (b)(3)(i) through (iii) of this section using the monitoring results from the preceding monitoring period. The percent leaking connectors shall be calculated as specified in paragraph (c) of this section.

(i) If the percent leaking connectors in the process unit was greater than or equal to 0.5 percent, then monitor within 12 months (1 year).

(ii) If the percent leaking connectors in the process unit was greater than or equal to 0.25 percent but less than 0.5 percent, then monitor within 4 years. An owner or operator may comply with the requirements of this paragraph by monitoring at least 40 percent of the connectors within 2 years of the start of the monitoring period, provided all connectors have been monitored by the end of the 4-year monitoring period.

(iii) If the percent leaking connectors in the process unit was less than 0.25 percent, then monitor as provided in paragraph (b)(3)(iii)(A) of this section and either paragraph (b)(3)(iii)(B) or (b)(3)(iii)(C) of this section, as appropriate.

(A) An owner or operator shall monitor at least 50 percent of the connectors within 4 years of the start of the monitoring period.

(B) If the percent of leaking connectors calculated from the monitoring results in paragraph (b)(3)(iii)(A) of this section is greater than or equal to 0.35 percent of the monitored connectors, the owner or operator shall monitor as soon as practical, but within the next 6 months, all connectors that have not yet been monitored during the monitoring period. At the conclusion of monitoring, a new monitoring period shall be started pursuant to paragraph (b)(3) of this section, based on the percent of leaking connectors within the total monitored connectors.

(C) If the percent of leaking connectors calculated from the monitoring results in paragraph (b)(3)(iii)(A) of this section is less than 0.35 percent of the monitored connectors, the owner or operator shall monitor all connectors that have not yet been monitored within 8 years of the start of the monitoring period.

(iv) If, during the monitoring conducted pursuant to paragraphs (b)(3)(i) through (iii) of this section, a connector is found to be leaking, it shall be re-monitored once within 90 days after repair to confirm that it is not leaking.

(v) The owner or operator shall keep a record of the start date and end date of each monitoring period under this section for each process unit.

(c) For use in determining the monitoring frequency, as specified in paragraphs (a) and (b)(3) of this section, the percent leaking connectors as used in paragraphs (a) and (b)(3) of this section shall be calculated by using the following equation:

$$\%C_L = C_L / C_t * 100$$

Where:

$\%C_L$ = Percent of leaking connectors as determined through periodic monitoring required in paragraphs (a) and (b)(3)(i) through (iii) of this section.

C_L = Number of connectors measured at 500 ppm or greater, by the method specified in § 60.485a(b).

C_t = Total number of monitored connectors in the process unit or affected facility.

(d) When a leak is detected pursuant to paragraphs (a) and (b) of this section, it shall be repaired as soon as practicable, but not later than 15 calendar days after it is detected, except as provided in § 60.482-9a. A first attempt at repair as defined in this subpart shall be made no later than 5 calendar days after the leak is detected.

(e) Any connector that is designated, as described in § 60.486a(f)(1), as an unsafe-to-monitor connector is exempt from the requirements of paragraphs (a) and (b) of this section if:

(1) The owner or operator of the connector demonstrates that the connector is unsafe-to-monitor because monitoring personnel would be exposed to an immediate danger as a consequence of complying with paragraphs (a) and (b) of this section; and

(2) The owner or operator of the connector has a written plan that requires monitoring of the connector as frequently as practicable during safe-to-monitor times but not more frequently than the periodic monitoring schedule otherwise applicable, and repair of the equipment according to the procedures in paragraph (d) of this section if a leak is detected.

(f) *Inaccessible, ceramic, or ceramic-lined connectors*. (1) Any connector that is inaccessible or that is ceramic or ceramic-lined (e.g., porcelain, glass, or glass-lined), is exempt from the monitoring requirements of paragraphs (a) and (b) of this section, from the leak repair requirements of paragraph (d) of this section, and from the recordkeeping and reporting requirements of §§ 63.1038 and 63.1039. An inaccessible connector is one that meets any of the provisions specified in paragraphs (f)(1)(i) through (vi) of this section, as applicable:

(i) Buried;

(ii) Insulated in a manner that prevents access to the connector by a monitor probe;

(iii) Obstructed by equipment or piping that prevents access to the connector by a monitor probe;

(iv) Unable to be reached from a wheeled scissor-lift or hydraulic-type scaffold that would allow access to connectors up to 7.6 meters (25 feet) above the ground;

(v) Inaccessible because it would require elevating the monitoring personnel more than 2 meters (7 feet) above a permanent support surface or would require the erection of scaffold; or

(vi) Not able to be accessed at any time in a safe manner to perform monitoring. Unsafe access includes, but is not limited to, the use of a wheeled scissor-lift on unstable or uneven terrain, the use of a motorized man-lift basket in areas where an ignition potential exists, or access would require near proximity to hazards such as electrical lines, or would risk damage to equipment.

(2) If any inaccessible, ceramic, or ceramic-lined connector is observed by visual, audible, olfactory, or other means to be leaking, the visual, audible, olfactory, or other indications of a leak to the atmosphere shall be eliminated as soon as practical.

(g) Except for instrumentation systems and inaccessible, ceramic, or ceramic-lined connectors meeting the provisions of paragraph (f) of this section, identify the connectors subject to the requirements of this subpart. Connectors need not be individually identified if all connectors in a designated area or length of pipe subject to the provisions of this subpart are identified as a group, and the number of connectors subject is indicated.

EFFECTIVE DATE NOTE: At 73 FR 31376, June 2, 2008, § 60.482-11a was stayed until further notice.

§ 60.483-1a Alternative standards for valves—allowable percentage of valves leaking.

(a) An owner or operator may elect to comply with an allowable percentage of valves leaking of equal to or less than 2.0 percent.

(b) The following requirements shall be met if an owner or operator wishes to comply with an allowable percentage of valves leaking:

(1) An owner or operator must notify the Administrator that the owner or operator has elected to comply with the allowable percentage of valves leaking before implementing this alternative standard, as specified in § 60.487a(d).

(2) A performance test as specified in paragraph (c) of this section shall be conducted initially upon designation, annually, and at other times requested by the Administrator.

(3) If a valve leak is detected, it shall be repaired in accordance with § 60.482-7a(d) and (e).

(c) Performance tests shall be conducted in the following manner:

(1) All valves in gas/vapor and light liquid service within the affected facility shall be monitored within 1 week by the methods specified in § 60.485a(b).

(2) If an instrument reading of 500 ppm or greater is measured, a leak is detected.

(3) The leak percentage shall be determined by dividing the number of valves for which leaks are detected by the number of valves in gas/vapor and light liquid service within the affected facility.

(d) Owners and operators who elect to comply with this alternative standard shall not have an affected facility with a leak percentage greater than 2.0 percent, determined as described in § 60.485a(h).

§ 60.483-2a Alternative standards for valves—skip period leak detection and repair.

(a)(1) An owner or operator may elect to comply with one of the alternative work practices specified in paragraphs (b)(2) and (3) of this section.

(2) An owner or operator must notify the Administrator before implementing one of the alternative work practices, as specified in § 60.487(d)a.

(b)(1) An owner or operator shall comply initially with the requirements for valves in gas/vapor service and valves in light liquid service, as described in § 60.482-7a.

(2) After 2 consecutive quarterly leak detection periods with the percent of valves leaking equal to or less than 2.0, an owner or operator may begin to skip 1 of the quarterly leak detection periods for the valves in gas/vapor and light liquid service.

(3) After 5 consecutive quarterly leak detection periods with the percent of valves leaking equal to or less than 2.0, an owner or operator may begin to skip 3 of the quarterly leak detection periods for the valves in gas/vapor and light liquid service.

(4) If the percent of valves leaking is greater than 2.0, the owner or operator shall comply with the requirements as described in § 60.482-7a but can again elect to use this section.

(5) The percent of valves leaking shall be determined as described in § 60.485a(h).

(6) An owner or operator must keep a record of the percent of valves found leaking during each leak detection period.

(7) A valve that begins operation in gas/vapor service or light liquid service after the initial startup date for a process unit following one of the alternative standards in this section must be monitored in

accordance with § 60.482-7a(a)(2)(i) or (ii) before the provisions of this section can be applied to that valve.

§ 60.484a Equivalence of means of emission limitation.

(a) Each owner or operator subject to the provisions of this subpart may apply to the Administrator for determination of equivalence for any means of emission limitation that achieves a reduction in emissions of VOC at least equivalent to the reduction in emissions of VOC achieved by the controls required in this subpart.

(b) Determination of equivalence to the equipment, design, and operational requirements of this subpart will be evaluated by the following guidelines:

(1) Each owner or operator applying for an equivalence determination shall be responsible for collecting and verifying test data to demonstrate equivalence of means of emission limitation.

(2) The Administrator will compare test data for demonstrating equivalence of the means of emission limitation to test data for the equipment, design, and operational requirements.

(3) The Administrator may condition the approval of equivalence on requirements that may be necessary to assure operation and maintenance to achieve the same emission reduction as the equipment, design, and operational requirements.

(c) Determination of equivalence to the required work practices in this subpart will be evaluated by the following guidelines:

(1) Each owner or operator applying for a determination of equivalence shall be responsible for collecting and verifying test data to demonstrate equivalence of an equivalent means of emission limitation.

(2) For each affected facility for which a determination of equivalence is requested, the emission reduction achieved by the required work practice shall be demonstrated.

(3) For each affected facility, for which a determination of equivalence is requested, the emission reduction achieved by the equivalent means of emission limitation shall be demonstrated.

(4) Each owner or operator applying for a determination of equivalence shall commit in writing to work practice(s) that provide for emission reductions equal to or greater than the emission reductions achieved by the required work practice.

(5) The Administrator will compare the demonstrated emission reduction for the equivalent means of emission limitation to the demonstrated emission reduction for the required work practices and will consider the commitment in paragraph (c)(4) of this section.

(6) The Administrator may condition the approval of equivalence on requirements that may be necessary to assure operation and maintenance to achieve the same emission reduction as the required work practice.

(d) An owner or operator may offer a unique approach to demonstrate the equivalence of any equivalent means of emission limitation.

(e)(1) After a request for determination of equivalence is received, the Administrator will publish a notice in the FEDERAL REGISTER and provide the opportunity for public hearing if the Administrator judges that the request may be approved.

(2) After notice and opportunity for public hearing, the Administrator will determine the equivalence of a means of emission limitation and will publish the determination in the FEDERAL REGISTER .

(3) Any equivalent means of emission limitations approved under this section shall constitute a required work practice, equipment, design, or operational standard within the meaning of section 111(h)(1) of the CAA.

(f)(1) Manufacturers of equipment used to control equipment leaks of VOC may apply to the Administrator for determination of equivalence for any equivalent means of emission limitation that achieves a reduction in emissions of VOC achieved by the equipment, design, and operational requirements of this subpart.

(2) The Administrator will make an equivalence determination according to the provisions of paragraphs (b), (c), (d), and (e) of this section.

§ 60.485a Test methods and procedures.

(a) In conducting the performance tests required in § 60.8, the owner or operator shall use as reference methods and procedures the test methods in appendix A of this part or other methods and procedures as specified in this section, except as provided in § 60.8(b).

(b) The owner or operator shall determine compliance with the standards in §§ 60.482-1a through 60.482-11a, 60.483a, and 60.484a as follows:

(1) Method 21 shall be used to determine the presence of leaking sources. The instrument shall be calibrated before use each day of its use by the procedures specified in Method 21 of appendix A-7 of this part. The following calibration gases shall be used:

(i) Zero air (less than 10 ppm of hydrocarbon in air); and

(ii) A mixture of methane or n-hexane and air at a concentration no more than 2,000 ppm greater than the leak definition concentration of the equipment monitored. If the monitoring instrument's design allows for multiple calibration scales, then the lower scale shall be calibrated with a calibration gas that is no higher than 2,000 ppm above the concentration specified as a leak, and the highest scale shall be calibrated with a calibration gas that is approximately equal to 10,000 ppm. If only one scale on an instrument will be used during monitoring, the owner or operator need not calibrate the scales that will not be used during that day's monitoring.

(2) A calibration drift assessment shall be performed, at a minimum, at the end of each monitoring day. Check the instrument using the same calibration gas(es) that were used to calibrate the instrument before use. Follow the procedures specified in Method 21 of appendix A-7 of this part, Section 10.1, except do not adjust the meter readout to correspond to the calibration gas value. Record the instrument reading for each scale used as specified in § 60.486a(e)(7). Calculate the average algebraic difference between the three meter readings and the most recent calibration value. Divide this algebraic difference by the initial calibration value and multiply by 100 to express the calibration drift as a percentage. If any calibration drift assessment shows a negative drift of more than 10 percent from the initial calibration value, then all equipment monitored since the last calibration with instrument readings below the appropriate leak definition and above the leak definition multiplied by (100 minus the percent of negative drift/divided by 100) must be re-monitored. If any calibration drift assessment shows a positive drift of more than 10 percent from the initial calibration value, then, at the owner/operator's discretion, all equipment since the last calibration with instrument readings above the appropriate leak definition and below the leak definition multiplied by (100 plus the percent of positive drift/divided by 100) may be re-monitored.

(c) The owner or operator shall determine compliance with the no-detectable-emission standards in §§ 60.482-2a(e), 60.482-3a(i), 60.482-4a, 60.482-7a(f), and 60.482-10a(e) as follows:

(1) The requirements of paragraph (b) shall apply.

(2) Method 21 of appendix A-7 of this part shall be used to determine the background level. All potential leak interfaces shall be traversed as close to the interface as possible. The arithmetic

difference between the maximum concentration indicated by the instrument and the background level is compared with 500 ppm for determining compliance.

(d) The owner or operator shall test each piece of equipment unless he demonstrates that a process unit is not in VOC service, i.e., that the VOC content would never be reasonably expected to exceed 10 percent by weight. For purposes of this demonstration, the following methods and procedures shall be used:

(1) Procedures that conform to the general methods in ASTM E260-73, 91, or 96, E168-67, 77, or 92, E169-63, 77, or 93 (incorporated by reference—see § 60.17) shall be used to determine the percent VOC content in the process fluid that is contained in or contacts a piece of equipment.

(2) Organic compounds that are considered by the Administrator to have negligible photochemical reactivity may be excluded from the total quantity of organic compounds in determining the VOC content of the process fluid.

(3) Engineering judgment may be used to estimate the VOC content, if a piece of equipment had not been shown previously to be in service. If the Administrator disagrees with the judgment, paragraphs (d)(1) and (2) of this section shall be used to resolve the disagreement.

(e) The owner or operator shall demonstrate that a piece of equipment is in light liquid service by showing that all the following conditions apply:

(1) The vapor pressure of one or more of the organic components is greater than 0.3 kPa at 20 °C (1.2 in. H₂O at 68 °F). Standard reference texts or ASTM D2879-83, 96, or 97 (incorporated by reference—see § 60.17) shall be used to determine the vapor pressures.

(2) The total concentration of the pure organic components having a vapor pressure greater than 0.3 kPa at 20 °C (1.2 in. H₂O at 68 °F) is equal to or greater than 20 percent by weight.

(3) The fluid is a liquid at operating conditions.

(f) Samples used in conjunction with paragraphs (d), (e), and (g) of this section shall be representative of the process fluid that is contained in or contacts the equipment or the gas being combusted in the flare.

(g) The owner or operator shall determine compliance with the standards of flares as follows:

(1) Method 22 of appendix A-7 of this part shall be used to determine visible emissions.

(2) A thermocouple or any other equivalent device shall be used to monitor the presence of a pilot flame in the flare.

(3) The maximum permitted velocity for air assisted flares shall be computed using the following equation:

$$V_{\max} = K_1 + K_2 H_T$$

Where:

V_{\max} = Maximum permitted velocity, m/sec (ft/sec).

H_T = Net heating value of the gas being combusted, MJ/scm (Btu/scf).

K_1 = 8.706 m/sec (metric units) = 28.56 ft/sec (English units).

K_2 = 0.7084 m⁴/(MJ-sec) (metric units) = 0.087 ft⁴/(Btu-sec) (English units).

(4) The net heating value (HT) of the gas being combusted in a flare shall be computed using the following equation:

$$H_T = K \sum_{i=1}^n C_i H_i$$

Where:

K = Conversion constant, 1.740×10^{-7} (g-mole)(MJ)/(ppm-scm-kcal) (metric units) = 4.674×10^{-6} [(g-mole)(Btu)/(ppm-scf-kcal)] (English units).

C_i = Concentration of sample component "i," ppm

H_i = net heat of combustion of sample component "i" at 25 °C and 760 mm Hg (77 °F and 14.7 psi), kcal/g-mole.

(5) Method 18 of appendix A-6 of this part or ASTM D6420-99 (2004) (where the target compound (s) are those listed in Section 1.1 of ASTM D6420-99, and the target concentration is between 150 parts per billion by volume and 100 ppmv) and ASTM D2504-67, 77, or 88 (Reapproved 1993) (incorporated by reference-see § 60.17) shall be used to determine the concentration of sample component "i."

(6) ASTM D2382-76 or 88 or D4809-95 (incorporated by reference-see § 60.17) shall be used to determine the net heat of combustion of component "i" if published values are not available or cannot be calculated.

(7) Method 2, 2A, 2C, or 2D of appendix A-7 of this part, as appropriate, shall be used to determine the actual exit velocity of a flare. If needed, the unobstructed (free) cross-sectional area of the flare tip shall be used.

(h) The owner or operator shall determine compliance with § 60.483-1a or § 60.483-2a as follows:

(1) The percent of valves leaking shall be determined using the following equation:

$$\%V_L = (V_L / V_T) * 100$$

Where:

$\%V_L$ = Percent leaking valves.

V_L = Number of valves found leaking.

V_T = The sum of the total number of valves monitored.

(2) The total number of valves monitored shall include difficult-to-monitor and unsafe-to-monitor valves only during the monitoring period in which those valves are monitored.

(3) The number of valves leaking shall include valves for which repair has been delayed.

(4) Any new valve that is not monitored within 30 days of being placed in service shall be included in the number of valves leaking and the total number of valves monitored for the monitoring period in which the valve is placed in service.

(5) If the process unit has been subdivided in accordance with § 60.482-7a(c)(1)(ii), the sum of valves found leaking during a monitoring period includes all subgroups.

(6) The total number of valves monitored does not include a valve monitored to verify repair.

§ 60.486a Recordkeeping requirements.

(a)(1) Each owner or operator subject to the provisions of this subpart shall comply with the recordkeeping requirements of this section.

(2) An owner or operator of more than one affected facility subject to the provisions of this subpart may comply with the recordkeeping requirements for these facilities in one recordkeeping system if the system identifies each record by each facility.

(3) The owner or operator shall record the information specified in paragraphs (a)(3)(i) through (v) of this section for each monitoring event required by §§ 60.482-2a, 60.482-3a, 60.482-7a, 60.482-8a, 60.482-11a, and 60.483-2a.

(i) Monitoring instrument identification.

(ii) Operator identification.

(iii) Equipment identification.

(iv) Date of monitoring.

(v) Instrument reading.

(b) When each leak is detected as specified in §§ 60.482-2a, 60.482-3a, 60.482-7a, 60.482-8a, 60.482-11a, and 60.483-2a, the following requirements apply:

(1) A weatherproof and readily visible identification, marked with the equipment identification number, shall be attached to the leaking equipment.

(2) The identification on a valve may be removed after it has been monitored for 2 successive months as specified in § 60.482-7a(c) and no leak has been detected during those 2 months.

(3) The identification on a connector may be removed after it has been monitored as specified in § 60.482-11a(b)(3)(iv) and no leak has been detected during that monitoring.

(4) The identification on equipment, except on a valve or connector, may be removed after it has been repaired.

(c) When each leak is detected as specified in §§ 60.482-2a, 60.482-3a, 60.482-7a, 60.482-8a, 60.482-11a, and 60.483-2a, the following information shall be recorded in a log and shall be kept for 2 years in a readily accessible location:

(1) The instrument and operator identification numbers and the equipment identification number, except when indications of liquids dripping from a pump are designated as a leak.

(2) The date the leak was detected and the dates of each attempt to repair the leak.

(3) Repair methods applied in each attempt to repair the leak.

(4) Maximum instrument reading measured by Method 21 of appendix A-7 of this part at the time the leak is successfully repaired or determined to be nonreparable, except when a pump is repaired by eliminating indications of liquids dripping.

(5) "Repair delayed" and the reason for the delay if a leak is not repaired within 15 calendar days after discovery of the leak.

(6) The signature of the owner or operator (or designate) whose decision it was that repair could not be effected without a process shutdown.

(7) The expected date of successful repair of the leak if a leak is not repaired within 15 days.

(8) Dates of process unit shutdowns that occur while the equipment is unrepaired.

(9) The date of successful repair of the leak.

(d) The following information pertaining to the design requirements for closed vent systems and control devices described in § 60.482-10a shall be recorded and kept in a readily accessible location:

(1) Detailed schematics, design specifications, and piping and instrumentation diagrams.

(2) The dates and descriptions of any changes in the design specifications.

(3) A description of the parameter or parameters monitored, as required in § 60.482-10a(e), to ensure that control devices are operated and maintained in conformance with their design and an explanation of why that parameter (or parameters) was selected for the monitoring.

(4) Periods when the closed vent systems and control devices required in §§ 60.482-2a, 60.482-3a, 60.482-4a, and 60.482-5a are not operated as designed, including periods when a flare pilot light does not have a flame.

(5) Dates of startups and shutdowns of the closed vent systems and control devices required in §§ 60.482-2a, 60.482-3a, 60.482-4a, and 60.482-5a.

(e) The following information pertaining to all equipment subject to the requirements in §§ 60.482-1a to 60.482-11a shall be recorded in a log that is kept in a readily accessible location:

(1) A list of identification numbers for equipment subject to the requirements of this subpart.

(2)(i) A list of identification numbers for equipment that are designated for no detectable emissions under the provisions of §§ 60.482-2a(e), 60.482-3a(i), and 60.482-7a(f).

(ii) The designation of equipment as subject to the requirements of § 60.482-2a(e), § 60.482-3a(i), or § 60.482-7a(f) shall be signed by the owner or operator. Alternatively, the owner or operator may establish a mechanism with their permitting authority that satisfies this requirement.

(3) A list of equipment identification numbers for pressure relief devices required to comply with § 60.482-4a.

(4)(i) The dates of each compliance test as required in §§ 60.482-2a(e), 60.482-3a(i), 60.482-4a, and 60.482-7a(f).

(ii) The background level measured during each compliance test.

(iii) The maximum instrument reading measured at the equipment during each compliance test.

(5) A list of identification numbers for equipment in vacuum service.

(6) A list of identification numbers for equipment that the owner or operator designates as operating in VOC service less than 300 hr/yr in accordance with § 60.482-1a(e), a description of the conditions under which the equipment is in VOC service, and rationale supporting the designation that it is in VOC service less than 300 hr/yr.

(7) The date and results of the weekly visual inspection for indications of liquids dripping from pumps in light liquid service.

(8) Records of the information specified in paragraphs (e)(8)(i) through (vi) of this section for monitoring instrument calibrations conducted according to sections 8.1.2 and 10 of Method 21 of appendix A-7 of this part and § 60.485a(b).

(i) Date of calibration and initials of operator performing the calibration.

(ii) Calibration gas cylinder identification, certification date, and certified concentration.

(iii) Instrument scale(s) used.

(iv) A description of any corrective action taken if the meter readout could not be adjusted to correspond to the calibration gas value in accordance with section 10.1 of Method 21 of appendix A-7 of this part.

(v) Results of each calibration drift assessment required by § 60.485a(b)(2) (i.e., instrument reading for calibration at end of monitoring day and the calculated percent difference from the initial calibration value).

(vi) If an owner or operator makes their own calibration gas, a description of the procedure used.

(9) The connector monitoring schedule for each process unit as specified in § 60.482-11a(b)(3)(v).

(10) Records of each release from a pressure relief device subject to § 60.482-4a.

(f) The following information pertaining to all valves subject to the requirements of § 60.482-7a(g) and (h), all pumps subject to the requirements of § 60.482-2a(g), and all connectors subject to the requirements of § 60.482-11a(e) shall be recorded in a log that is kept in a readily accessible location:

(1) A list of identification numbers for valves, pumps, and connectors that are designated as unsafe-to-monitor, an explanation for each valve, pump, or connector stating why the valve, pump, or connector is unsafe-to-monitor, and the plan for monitoring each valve, pump, or connector.

(2) A list of identification numbers for valves that are designated as difficult-to-monitor, an explanation for each valve stating why the valve is difficult-to-monitor, and the schedule for monitoring each valve.

(g) The following information shall be recorded for valves complying with § 60.483-2a:

(1) A schedule of monitoring.

(2) The percent of valves found leaking during each monitoring period.

(h) The following information shall be recorded in a log that is kept in a readily accessible location:

(1) Design criterion required in §§ 60.482-2a(d)(5) and 60.482-3a(e)(2) and explanation of the design criterion; and

(2) Any changes to this criterion and the reasons for the changes.

(i) The following information shall be recorded in a log that is kept in a readily accessible location for use in determining exemptions as provided in § 60.480a(d):

(1) An analysis demonstrating the design capacity of the affected facility,

(2) A statement listing the feed or raw materials and products from the affected facilities and an analysis demonstrating whether these chemicals are heavy liquids or beverage alcohol, and

(3) An analysis demonstrating that equipment is not in VOC service.

(j) Information and data used to demonstrate that a piece of equipment is not in VOC service shall be recorded in a log that is kept in a readily accessible location.

(k) The provisions of § 60.7(b) and (d) do not apply to affected facilities subject to this subpart.

§ 60.487a Reporting requirements.

(a) Each owner or operator subject to the provisions of this subpart shall submit semiannual reports to the Administrator beginning 6 months after the initial startup date.

(b) The initial semiannual report to the Administrator shall include the following information:

(1) Process unit identification.

(2) Number of valves subject to the requirements of § 60.482-7a, excluding those valves designated for no detectable emissions under the provisions of § 60.482-7a(f).

(3) Number of pumps subject to the requirements of § 60.482-2a, excluding those pumps designated for no detectable emissions under the provisions of § 60.482-2a(e) and those pumps complying with § 60.482-2a(f).

(4) Number of compressors subject to the requirements of § 60.482-3a, excluding those compressors designated for no detectable emissions under the provisions of § 60.482-3a(i) and those compressors complying with § 60.482-3a(h).

(5) Number of connectors subject to the requirements of § 60.482-11a.

(c) All semiannual reports to the Administrator shall include the following information, summarized from the information in § 60.486a:

(1) Process unit identification.

(2) For each month during the semiannual reporting period,

(i) Number of valves for which leaks were detected as described in § 60.482-7a(b) or § 60.483-2a,

(ii) Number of valves for which leaks were not repaired as required in § 60.482-7a(d)(1),

(iii) Number of pumps for which leaks were detected as described in § 60.482-2a(b), (d)(4)(ii)(A) or (B), or (d)(5)(iii),

(iv) Number of pumps for which leaks were not repaired as required in § 60.482-2a(c)(1) and (d) (6),

(v) Number of compressors for which leaks were detected as described in § 60.482-3a(f),

(vi) Number of compressors for which leaks were not repaired as required in § 60.482-3a(g)(1),

(vii) Number of connectors for which leaks were detected as described in § 60.482-11a(b)

(viii) Number of connectors for which leaks were not repaired as required in § 60.482-11a(d), and

(ix)-(x) [Reserved]

(xi) The facts that explain each delay of repair and, where appropriate, why a process unit shutdown was technically infeasible.

(3) Dates of process unit shutdowns which occurred within the semiannual reporting period.

(4) Revisions to items reported according to paragraph (b) of this section if changes have occurred since the initial report or subsequent revisions to the initial report.

(d) An owner or operator electing to comply with the provisions of §§ 60.483-1a or 60.483-2a shall notify the Administrator of the alternative standard selected 90 days before implementing either of the provisions.

(e) An owner or operator shall report the results of all performance tests in accordance with § 60.8 of the General Provisions. The provisions of § 60.8(d) do not apply to affected facilities subject to the provisions of this subpart except that an owner or operator must notify the Administrator of the schedule for the initial performance tests at least 30 days before the initial performance tests.

(f) The requirements of paragraphs (a) through (c) of this section remain in force until and unless EPA, in delegating enforcement authority to a state under section 111(c) of the CAA, approves

reporting requirements or an alternative means of compliance surveillance adopted by such state. In that event, affected sources within the state will be relieved of the obligation to comply with the requirements of paragraphs (a) through (c) of this section, provided that they comply with the requirements established by the state.

§ 60.488a Reconstruction.

For the purposes of this subpart:

(a) The cost of the following frequently replaced components of the facility shall not be considered in calculating either the “fixed capital cost of the new components” or the “fixed capital costs that would be required to construct a comparable new facility” under § 60.15: Pump seals, nuts and bolts, rupture disks, and packings.

(b) Under § 60.15, the “fixed capital cost of new components” includes the fixed capital cost of all depreciable components (except components specified in § 60.488a(a)) which are or will be replaced pursuant to all continuous programs of component replacement which are commenced within any 2-year period following the applicability date for the appropriate subpart. (See the “Applicability and designation of affected facility” section of the appropriate subpart.) For purposes of this paragraph, “commenced” means that an owner or operator has undertaken a continuous program of component replacement or that an owner or operator has entered into a contractual obligation to undertake and complete, within a reasonable time, a continuous program of component replacement.

§ 60.489a List of chemicals produced by affected facilities.

Process units that produce, as intermediates or final products, chemicals listed in § 60.489 are covered under this subpart. The applicability date for process units producing one or more of these chemicals is November 8, 2006.

For questions or comments regarding e-CFR editorial content, features, or design, email ecfr@nara.gov.
For questions concerning e-CFR programming and delivery issues, email webteam@gpo.gov.

Appendix D – 40 CFR Part 61, Subpart C

ELECTRONIC CODE OF FEDERAL REGULATIONS

e-CFR Data is current as of August 30, 2013

Title 40: Protection of Environment

PART 61—NATIONAL EMISSION STANDARDS FOR HAZARDOUS AIR POLLUTANTS

Subpart C—National Emission Standard for Beryllium

Contents

- [§ 61.30](#) Applicability.
 - [§ 61.31](#) Definitions.
 - [§ 61.32](#) Emission standard.
 - [§ 61.33](#) Stack sampling.
 - [§ 61.34](#) Air sampling.
-

§ 61.30 Applicability.

The provisions of this subpart are applicable to the following stationary sources:

(a) Extraction plants, ceramic plants, foundries, incinerators, and propellant plants which process beryllium ore, beryllium, beryllium oxide, beryllium alloys, or beryllium-containing waste.

(b) Machine shops which process beryllium, beryllium oxides, or any alloy when such alloy contains more than 5 percent beryllium by weight.

[38 FR 8826, Apr. 6, 1973, as amended at 65 FR 62151, Oct. 17, 2000]

§ 61.31 Definitions.

Terms used in this subpart are defined in the act, in subpart A of this part, or in this section as follows:

(a) *Beryllium* means the element beryllium. Where weights or concentrations are specified, such weights or concentrations apply to beryllium only, excluding the weight or concentration of any associated elements.

(b) *Extraction plant* means a facility chemically processing beryllium ore to beryllium metal, alloy, or oxide, or performing any of the intermediate steps in these processes.

(c) *Beryllium ore* means any naturally occurring material mined or gathered for its beryllium content.

(d) *Machine shop* means a facility performing cutting, grinding, turning, honing, milling, deburring, lapping, electrochemical machining, etching, or other similar operations.

(e) *Ceramic plant* means a manufacturing plant producing ceramic items.

(f) *Foundry* means a facility engaged in the melting or casting of beryllium metal or alloy.

(g) *Beryllium-containing waste* means material contaminated with beryllium and/or beryllium compounds used or generated during any process or operation performed by a source subject to this subpart.

(h) *Incinerator* means any furnace used in the process of burning waste for the primary purpose of reducing the volume of the waste by removing combustible matter.

(i) *Propellant* means a fuel and oxidizer physically or chemically combined which undergoes combustion to provide rocket propulsion.

(j) *Beryllium alloy* means any metal to which beryllium has been added in order to increase its beryllium content and which contains more than 0.1 percent beryllium by weight.

(k) *Propellant plant* means any facility engaged in the mixing, casting, or machining of propellant.

§ 61.32 Emission standard.

(a) Emissions to the atmosphere from stationary sources subject to the provisions of this subpart shall not exceed 10 grams (0.022 lb) of beryllium over a 24-hour period, except as provided in paragraph (b) of this section.

(b) Rather than meet the requirement of paragraph (a) of this section, an owner or operator may request approval from the Administrator to meet an ambient concentration limit on beryllium in the vicinity of the stationary source of $0.01 \mu\text{g}/\text{m}^3$ ($4.37 \times 10^{-6} \text{ gr}/\text{ft}^3$), averaged over a 30-day period.

(1) Approval of such requests may be granted by the Administrator provided that:

(i) At least 3 years of data is available which in the judgment of the Administrator demonstrates that the future ambient concentrations of beryllium in the vicinity of the stationary source will not exceed $0.01 \mu\text{g}/\text{m}^3$ ($4.37 \times 10^{-6} \text{ gr}/\text{ft}^3$), averaged over a 30-day period. Such 3-year period shall be the 3 years ending 30 days before the effective date of this standard.

(ii) The owner or operator requests such approval in writing within 30 days after the effective date of this standard.

(iii) The owner or operator submits a report to the Administrator within 45 days after the effective date of this standard which report includes the following information:

(a) Description of sampling method including the method and frequency of calibration.

(b) Method of sample analysis.

(c) Averaging technique for determining 30-day average concentrations.

(d) Number, identity, and location (address, coordinates, or distance and heading from plant) of sampling sites.

(e) Ground elevations and height above ground of sampling inlets.

(f) Plant and sampling area plots showing emission points and sampling sites. Topographic features significantly affecting dispersion including plant building heights and locations shall be included.

(g) Information necessary for estimating dispersion including stack height, inside diameter, exit gas temperature, exit velocity or flow rate, and beryllium concentration.

(h) A description of data and procedures (methods or models) used to design the air sampling network (i.e., number and location of sampling sites).

(i) Air sampling data indicating beryllium concentrations in the vicinity of the stationary source for the 3-year period specified in paragraph (b)(1) of this section. This data shall be presented chronologically and include the beryllium concentration and location of each individual sample taken by the network and the corresponding 30-day average beryllium concentrations.

(2) Within 60 days after receiving such report, the Administrator will notify the owner or operator in writing whether approval is granted or denied. Prior to denying approval to comply with the provisions of paragraph (b) of this section, the Administrator will consult with representatives of the statutory source for which the demonstration report was submitted.

(c) The burning of beryllium and/or beryllium-containing waste, except propellants, is prohibited except in incinerators, emissions from which must comply with the standard.

[38 FR 8826, Apr. 6, 1973, as amended at 65 FR 62151, Oct. 17, 2000]

§ 61.33 Stack sampling.

(a) Unless a waiver of emission testing is obtained under § 61.13, each owner or operator required to comply with § 61.32(a) shall test emissions from the source according to Method 104 of appendix B to this part. Method 103 of appendix B to this part is approved by the Administrator as an alternative method for sources subject to § 61.32(a). The emission test shall be performed—

(1) Within 90 days of the effective date in the case of an existing source or a new source which has an initial startup date preceding the effective date; or

(2) Within 90 days of startup in the case of a new source which did not have an initial startup date preceding the effective date.

(b) The Administrator shall be notified at least 30 days prior to an emission test so that he may at his option observe the test.

(c) Samples shall be taken over such a period or periods as are necessary to accurately determine the maximum emissions which will occur in any 24-hour period. Where emissions depend upon the relative frequency of operation of different types of processes, operating hours, operating capacities, or other factors, the calculation of maximum 24-hour-period emissions will be based on that combination of factors which is likely to occur during the subject period and which result in the maximum emissions. No changes in the operation shall be made, which would potentially increase emissions above that determined by the most recent source test, until a new emission level has been estimated by calculation and the results reported to the Administrator.

(d) All samples shall be analyzed and beryllium emissions shall be determined within 30 days after the source test. All determinations shall be reported to the Administrator by a registered letter dispatched before the close of the next business day following such determination.

(e) Records of emission test results and other data needed to determine total emissions shall be retained at the source and made available, for inspection by the Administrator, for a minimum of 2 years.

[38 FR 8826, Apr. 6, 1973, as amended at 50 FR 46294, Nov. 7, 1985]

§ 61.34 Air sampling.

(a) Stationary sources subject to § 61.32(b) shall locate air sampling sites in accordance with a plan approved by the Administrator. Such sites shall be located in such a manner as is calculated to detect maximum concentrations of beryllium in the ambient air.

(b) All monitoring sites shall be operated continuously except for a reasonable time allowance for instrument maintenance and calibration, for changing filters, or for replacement of equipment needing major repair.

(c) Filters shall be analyzed and concentrations calculated within 30 days after filters are collected. Records of concentrations at all sampling sites and other data needed to determine such concentrations shall be retained at the source and made available, for inspection by the Administrator, for a minimum of 2 years.

(d) Concentrations measured at all sampling sites shall be reported to the Administrator every 30 days by a registered letter.

(e) The Administrator may at any time require changes in, or expansion of, the sampling network.

For questions or comments regarding e-CFR editorial content, features, or design, email ecfr@nara.gov.

For questions concerning e-CFR programming and delivery issues, email webteam@gpo.gov.

Appendix E – 40 CFR Part 61, Subpart E

ELECTRONIC CODE OF FEDERAL REGULATIONS

e-CFR Data is current as of August 30, 2013

Title 40: Protection of Environment

PART 61—NATIONAL EMISSION STANDARDS FOR HAZARDOUS AIR POLLUTANTS

Subpart E—National Emission Standard for Mercury

Contents

- § 61.50 Applicability.
 - § 61.51 Definitions.
 - § 61.52 Emission standard.
 - § 61.53 Stack sampling.
 - § 61.54 Sludge sampling.
 - § 61.55 Monitoring of emissions and operations.
 - § 61.56 Delegation of authority.
-

§ 61.50 Applicability.

The provisions of this subpart are applicable to those stationary sources which process mercury ore to recover mercury, use mercury chlor-alkali cells to produce chlorine gas and alkali metal hydroxide, and incinerate or dry wastewater treatment plant sludge.

[40 FR 48302, Oct. 14, 1975]

§ 61.51 Definitions.

Terms used in this subpart are defined in the act, in subpart A of this part, or in this section as follows:

- (a) *Mercury* means the element mercury, excluding any associated elements, and includes mercury in particulates, vapors, aerosols, and compounds.
- (b) *Mercury ore* means a mineral mined specifically for its mercury content.
- (c) *Mercury ore processing facility* means a facility processing mercury ore to obtain mercury.
- (d) *Condenser stack gases* mean the gaseous effluent evolved from the stack of processes utilizing heat to extract mercury metal from mercury ore.
- (e) *Mercury chlor-alkali cell* means a device which is basically composed of an electrolyzer section and a denuder (decomposer) section and utilizes mercury to produce chlorine gas, hydrogen gas, and alkali metal hydroxide.
- (f) *Mercury chlor-alkali electrolyzer* means an electrolytic device which is part of a mercury chlor-alkali cell and utilizes a flowing mercury cathode to produce chlorine gas and alkali metal amalgam.
- (g) *Denuder* means a horizontal or vertical container which is part of a mercury chlor-alkali cell and in which water and alkali metal amalgam are converted to alkali metal hydroxide, mercury, and hydrogen gas in a short-circuited, electrolytic reaction.

(h) *Hydrogen gas stream* means a hydrogen stream formed in the chlor-alkali cell denuder.

(i) *End box* means a container(s) located on one or both ends of a mercury chlor-alkali electrolyzer which serves as a connection between the electrolyzer and denuder for rich and stripped amalgam.

(j) *End box ventilation system* means a ventilation system which collects mercury emissions from the end-boxes, the mercury pump sumps, and their water collection systems.

(k) *Cell room* means a structure(s) housing one or more mercury electrolytic chlor-alkali cells.

(l) *Sludge* means sludge produced by a treatment plant that processes municipal or industrial waste waters.

(m) *Sludge dryer* means a device used to reduce the moisture content of sludge by heating to temperatures above 65 °C (ca. 150 °F) directly with combustion gases.

[38 FR 8826, Apr. 6, 1973, as amended at 40 FR 48302, Oct. 14, 1975]

§ 61.52 Emission standard.

(a) Emissions to the atmosphere from mercury ore processing facilities and mercury cell chlor-alkali plants shall not exceed 2.3 kg (5.1 lb) of mercury per 24-hour period.

(b) Emissions to the atmosphere from sludge incineration plants, sludge drying plants, or a combination of these that process wastewater treatment plant sludges shall not exceed 3.2 kg (7.1 lb) of mercury per 24-hour period.

[40 FR 48302, Oct. 14, 1975, as amended at 65 FR 62151, Oct. 17, 2000]

§ 61.53 Stack sampling.

(a) *Mercury ore processing facility.* (1) Unless a waiver of emission testing is obtained under § 61.13, each owner or operator processing mercury ore shall test emissions from the source according to Method 101 of appendix B to this part. The emission test shall be performed—

(i) Within 90 days of the effective date in the case of an existing source or a new source which has an initial start-up date preceding the effective date; or

(ii) Within 90 days of startup in the case of a new source which did not have an initial startup date preceding the effective date.

(2) The Administrator shall be notified at least 30 days prior to an emission test, so that he may at his option observe the test.

(3) Samples shall be taken over such a period or periods as are necessary to accurately determine the maximum emissions which will occur in a 24-hour period. No changes in the operation shall be made, which would potentially increase emissions above that determined by the most recent source test, until the new emission level has been estimated by calculation and the results reported to the Administrator.

(4) All samples shall be analyzed and mercury emissions shall be determined within 30 days after the stack test. Each determination shall be reported to the Administrator by a registered letter dispatched within 15 calendar days following the date such determination is completed.

(5) Records of emission test results and other data needed to determine total emissions shall be retained at the source and made available, for inspection by the Administrator, for a minimum of 2 years.

(b) *Mercury chlor-alkali plant—hydrogen and end-box ventilation gas streams.* (1) Unless a waiver of emission testing is obtained under § 61.13, each owner or operator employing mercury chlor-alkali cell(s) shall test emissions from hydrogen streams according to Method 102 and from end-box ventilation gas streams according to Method 101 of appendix B to this part. The emission test shall be performed—

(i) Within 90 days of the effective date in the case of an existing source or a new source which has an initial startup date preceding the effective date; or

(ii) Within 90 days of startup in the case of a new source which did not have an initial startup date preceding the effective date.

(2) The Administrator shall be notified at least 30 days prior to an emission test, so that he may at his option observe the test.

(3) Samples shall be taken over such a period or periods as are necessary to accurately determine the maximum emissions which will occur in a 24-hour period. No changes in the operation shall be made, which would potentially increase emissions above that determined by the most recent source test, until the new emission has been estimated by calculation and the results reported to the Administrator.

(4) All samples shall be analyzed and mercury emissions shall be determined within 30 days after the stack test. Each determination shall be reported to the Administrator by a registered letter dispatched within 15 calendar days following the date such determination is completed.

(5) Records of emission test results and other data needed to determine total emissions shall be retained at the source and made available, for inspection by the Administrator, for a minimum of 2 years.

(c) *Mercury chlor-alkali plants—cell room ventilation system.* (1) Stationary sources using mercury chlor-alkali cells may test cell room emissions in accordance with paragraph (c)(2) of this section or demonstrate compliance with paragraph (c)(4) of this section and assume ventilation emissions of 1.3 kg/day (2.9 lb/day) of mercury.

(2) Unless a waiver of emission testing is obtained under § 61.13, each owner or operator shall pass all cell room air in force gas streams through stacks suitable for testing and shall test emissions from the source according to Method 101 in appendix B to this part. The emission test shall be performed—

(i) Within 90 days of the effective date in the case of an existing source or a new source which has an initial startup date preceding the effective date; or

(ii) Within 90 days of startup in the case of a new source which did not have an initial startup date preceding the effective date.

(3) The Administrator shall be notified at least 30 days prior to an emission test, so that he may at his option observe the test.

(4) An owner or operator may carry out approved design, maintenance, and housekeeping practices. A list of approved practices is provided in appendix A of "Review of National Emission Standards for Mercury," EPA-450/3-84-014a, December 1984. Copies are available from EPA's Central Docket Section, Docket item number A-84-41, III-B-1.

(d) *Sludge incineration and drying plants.* (1) Unless a waiver of emission testing is obtained under § 61.13, each owner or operator of a source subject to the standard in § 61.52(b) shall test emissions from that source. Such tests shall be conducted in accordance with the procedures set forth either in paragraph (d) of this section or in § 61.54.

(2) Method 101A in appendix B to this part shall be used to test emissions as follows:

(i) The test shall be performed within 90 days of the effective date of these regulations in the case of an existing source or a new source which has an initial startup date preceding the effective date.

(ii) The test shall be performed within 90 days of startup in the case of a new source which did not have an initial startup date preceding the effective date.

(3) The Administrator shall be notified at least 30 days prior to an emission test, so that he may at his option observe the test.

(4) Samples shall be taken over such a period or periods as are necessary to determine accurately the maximum emissions which will occur in a 24-hour period. No changes shall be made in the operation which would potentially increase emissions above the level determined by the most recent stack test, until the new emission level has been estimated by calculation and the results reported to the Administrator.

(5) All samples shall be analyzed and mercury emissions shall be determined within 30 days after the stack test. Each determination shall be reported to the Administrator by a registered letter dispatched within 15 calendar days following the date such determination is completed.

(6) Records of emission test results and other data needed to determine total emissions shall be retained at the source and shall be made available, for inspection by the Administrator, for a minimum of 2 years.

[38 FR 8826, Apr. 6, 1973, as amended at 40 FR 48302, Oct. 14, 1975; 47 FR 24704, June 8, 1982; 50 FR 46294, Nov. 7, 1985; 52 FR 8726, Mar. 19, 1987; 65 FR 62151, Oct. 17, 2000]

§ 61.54 Sludge sampling.

(a) As an alternative means for demonstrating compliance with § 61.52(b), an owner or operator may use Method 105 of appendix B and the procedures specified in this section.

(1) A sludge test shall be conducted within 90 days of the effective date of these regulations in the case of an existing source or a new source which has an initial startup date preceding the effective date; or

(2) A sludge test shall be conducted within 90 days of startup in the case of a new source which did not have an initial startup date preceding the effective date.

(b) The Administrator shall be notified at least 30 days prior to a sludge sampling test, so that he may at his option observe the test.

(c) Sludge shall be sampled according to paragraph (c)(1) of this section, sludge charging rate for the plant shall be determined according to paragraph (c)(2) of this section, and the sludge analysis shall be performed according to paragraph (c)(3) of this section.

(1) The sludge shall be sampled according to Method 105—Determination of Mercury in Wastewater Treatment Plant Sewage Sludges. A total of three composite samples shall be obtained within an operating period of 24 hours. When the 24-hour operating period is not continuous, the total sampling period shall not exceed 72 hours after the first grab sample is obtained. Samples shall not be exposed to any condition that may result in mercury contamination or loss.

(2) The maximum 24-hour period sludge incineration or drying rate shall be determined by use of a flow rate measurement device that can measure the mass rate of sludge charged to the incinerator or dryer with an accuracy of ± 5 percent over its operating range. Other methods of measuring sludge mass charging rates may be used if they have received prior approval by the Administrator.

(3) The sampling, handling, preparation, and analysis of sludge samples shall be accomplished according to Method 105 in appendix B of this part.

(d) The mercury emissions shall be determined by use of the following equation.

$$E_{Hg} = \frac{MQ F_{sm}(\mu g)}{1000}$$

where:

E_{Hg} =Mercury emissions, g/day.

M=Mercury concentration of sludge on a dry solids basis, $\mu\text{g/g}$.

Q=Sludge changing rate, kg/day.

F_{sm} =Weight fraction of solids in the collected sludge after mixing.

1000=Conversion factor, $\text{kg } \mu\text{g/g}^2$.

(e) No changes in the operation of a plant shall be made after a sludge test has been conducted which would potentially increase emissions above the level determined by the most recent sludge test, until the new emission level has been estimated by calculation and the results reported to the Administrator.

(f) All sludge samples shall be analyzed for mercury content within 30 days after the sludge sample is collected. Each determination shall be reported to the Administrator by a registered letter dispatched within 15 calendar days following the date such determination is completed.

(g) Records of sludge sampling, charging rate determination and other data needed to determine mercury content of wastewater treatment plant sludges shall be retained at the source and made available, for inspection by the Administrator, for a minimum of 2 years.

[40 FR 48303, Oct. 14, 1975, as amended at 49 FR 35770, Sept. 12, 1984; 52 FR 8727, Mar. 19, 1987; 53 FR 36972, Sept. 23, 1988]

§ 61.55 Monitoring of emissions and operations.

(a) *Wastewater treatment plant sludge incineration and drying plants.* All the sources for which mercury emissions exceed 1.6 kg (3.5 lb) per 24-hour period, demonstrated either by stack sampling according to § 61.53 or sludge sampling according to § 61.54, shall monitor mercury emissions at intervals of at least once per year by use of Method 105 of appendix B or the procedures specified in § 61.53 (d) (2) and (4). The results of monitoring shall be reported and retained according to § 61.53 (d) (5) and (6) or § 61.54 (f) and (g).

(b) *Mercury cell chlor-alkali plants—hydrogen and end-box ventilation gas streams.* (1) The owner or operator of each mercury cell chlor-alkali plant shall, within 1 year of the date of publication of these amendments or within 1 year of startup for a plant with initial startup after the date of publication, perform a mercury emission test that demonstrates compliance with the emission limits in § 61.52, on the hydrogen stream by Method 102 and on the end-box stream by Method 101 for the purpose of establishing limits for parameters to be monitored.

(2) During tests specified in paragraph (b)(1) of this section, the following control device parameters shall be monitored, except as provided in paragraph (c) of this section, and recorded manually or automatically at least once every 15 minutes:

(i) The exit gas temperature from uncontrolled streams;

(ii) The outlet temperature of the gas stream for the final (i.e., the farthest downstream) cooling system when no control devices other than coolers and demisters are used;

(iii) The outlet temperature of the gas stream from the final cooling system when the cooling system is followed by a molecular sieve or carbon adsorber;

(iv) Outlet concentration of available chlorine, pH, liquid flow rate, and inlet gas temperature of chlorinated brine scrubbers and hypochlorite scrubbers;

(v) The liquid flow rate and exit gas temperature for water scrubbers;

(vi) The inlet gas temperature of carbon adsorption systems; and

(vii) The temperature during the heating phase of the regeneration cycle for carbon adsorbers or molecular sieves.

(3) The recorded parameters in paragraphs (b)(2)(i) through (b)(2)(vi) of this section shall be averaged over the test period (a minimum of 6 hours) to provide an average number. The highest temperature reading that is measured in paragraph (b)(2)(vii) of this section is to be identified as the reference temperature for use in paragraph (b)(6)(ii) of this section.

(4)(i) Immediately following completion of the emission tests specified in paragraph (b)(1) of this section, the owner or operator of a mercury cell chlor-alkali plant shall monitor and record manually or automatically at least once per hour the same parameters specified in paragraphs (b)(2)(i) through (b)(2)(vi) of this section.

(ii) Immediately following completion of the emission tests specified in paragraph (b)(1) of this section, the owner or operator shall monitor and record manually or automatically, during each heating phase of the regeneration cycle, the temperature specified in paragraph (b)(2)(vii) of this section.

(5) Monitoring devices used in accordance with paragraphs (b)(2) and (b)(4) of this section shall be certified by their manufacturer to be accurate to within 10 percent, and shall be operated, maintained, and calibrated according to the manufacturer's instructions. Records of the certifications and calibrations shall be retained at the chlor-alkali plant and made available for inspection by the Administrator as follows: Certification, for as long as the device is used for this purpose; calibration for a minimum of 2 years.

(6)(i) When the hourly value of a parameter monitored in accordance with paragraph (b)(4)(i) of this section exceeds, or in the case of liquid flow rate and available chlorine falls below the value of that same parameter determined in paragraph (b)(2) of this section for 24 consecutive hours, the Administrator is to be notified within the next 10 days.

(ii) When the maximum hourly value of the temperature measured in accordance with paragraph (b)(4)(ii) of this section is below the reference temperature recorded according to paragraph (b)(3) of this section for three consecutive regeneration cycles, the Administrator is to be notified within the next 10 days.

(7) Semiannual reports shall be submitted to the Administrator indicating the time and date on which the hourly value of each parameter monitored according to paragraphs (b)(4)(i) and (b)(4)(ii) of this section fell outside the value of that same parameter determined under paragraph (b)(3) of this section; and corrective action taken, and the time and date of the corrective action. Parameter excursions will be considered unacceptable operation and maintenance of the emission control system. In addition, while compliance with the emission limits is determined primarily by conducting a performance test according to the procedures in § 61.53(b), reports of parameter excursions may be used as evidence in judging the duration of a violation that is determined by a performance test.

(8) Semiannual reports required in paragraph (b)(7) of this section shall be submitted to the Administrator on September 15 and March 15 of each year. The first semiannual report is to be submitted following the first full 6 month reporting period. The semiannual report due on September 15 (March 15) shall include all excursions monitored through August 31 (February 28) of the same calendar year.

(c) As an alternative to the monitoring, recordkeeping, and reporting requirements in paragraphs (b)(2) through (8) of this section, an owner or operator may develop and submit for the Administrator's review and approval a plant-specific monitoring plan. To be approved, such a plan must ensure not

only compliance with the emission limits of § 61.52(a) but also proper operation and maintenance of emissions control systems. Any site-specific monitoring plan submitted must, at a minimum, include the following:

(1) Identification of the critical parameter or parameters for the hydrogen stream and for the end-box ventilation stream that are to be monitored and an explanation of why the critical parameter(s) selected is the best indicator of proper control system performance and of mercury emission rates.

(2) Identification of the maximum or minimum value of each parameter (e.g., degrees temperature, concentration of mercury) that is not to be exceeded. The level(s) is to be directly correlated to the results of a performance test, conducted no more than 180 days prior to submittal of the plan, when the facility was in compliance with the emission limits of § 61.52(a).

(3) Designation of the frequency for recording the parameter measurements, with justification if the frequency is less than hourly. A longer recording frequency must be justified on the basis of the amount of time that could elapse during periods of process or control system upsets before the emission limits would be exceeded, and consideration is to be given to the time that would be necessary to repair the failure.

(4) Designation of the immediate actions to be taken in the event of an excursion beyond the value of the parameter established in paragraph (c)(2) of this section.

(5) Provisions for reporting, semiannually, parameter excursions and the corrective actions taken, and provisions for reporting within 10 days any significant excursion.

(6) Identification of the accuracy of the monitoring device(s) or of the readings obtained.

(7) Recordkeeping requirements for certifications and calibrations.

(d) *Mercury cell chlor-alkali plants—cell room ventilation system.* (1) Stationary sources determining cell room emissions in accordance with § 61.53(c)(4) shall maintain daily records of all leaks or spills of mercury. The records shall indicate the amount, location, time, and date the leaks or spills occurred, identify the cause of the leak or spill, state the immediate steps taken to minimize mercury emissions and steps taken to prevent future occurrences, and provide the time and date on which corrective steps were taken.

(2) The results of monitoring shall be recorded, retained at the source, and made available for inspection by the Administrator for a minimum of 2 years.

[52 FR 8727, Mar. 19, 1987, as amended at 65 FR 62151, Oct. 17, 2000]

§ 61.56 Delegation of authority.

(a) In delegating implementation and enforcement authority to a State under section 112(d) of the Act, the authorities contained in paragraph (b) of this section shall be retained by the Administrator and not transferred to a State.

(b) Authorities which will not be delegated to States: Sections 61.53(c)(4) and 61.55(d). The authorities not delegated to States listed are in addition to the authorities in the General Provisions, subpart A of 40 CFR part 61, that will not be delegated to States (§§ 61.04(b), 61.12(d)(1), and 61.13(h)(1)(ii)).

[52 FR 8728, Mar. 19, 1987]

For questions or comments regarding e-CFR editorial content, features, or design, email ecfr@nara.gov.
For questions concerning e-CFR programming and delivery issues, email webteam@gpo.gov.

Appendix F – 40 CFR Part 61, Subpart V

ELECTRONIC CODE OF FEDERAL REGULATIONS

e-CFR Data is current as of August 30, 2013

Title 40: Protection of Environment

PART 61—NATIONAL EMISSION STANDARDS FOR HAZARDOUS AIR POLLUTANTS

Subpart V—National Emission Standard for Equipment Leaks (Fugitive Emission Sources)

Contents

§ 61.240	Applicability and designation of sources.
§ 61.241	Definitions.
§ 61.242-1	Standards: General.
§ 61.242-2	Standards: Pumps.
§ 61.242-3	Standards: Compressors.
§ 61.242-4	Standards: Pressure relief devices in gas/vapor service.
§ 61.242-5	Standards: Sampling connecting systems.
§ 61.242-6	Standards: Open-ended valves or lines.
§ 61.242-7	Standards: Valves.
§ 61.242-8	Standards: Pressure relief services in liquid service and connectors.
§ 61.242-9	Standards: Surge control vessels and bottoms receivers.
§ 61.242-10	Standards: Delay of repair.
§ 61.242-11	Standards: Closed-vent systems and control devices.
§ 61.243-1	Alternative standards for valves in VHAP service—allowable percentage of valves leaking.
§ 61.243-2	Alternative standards for valves in VHAP service—skip period leak detection and repair.
§ 61.244	Alternative means of emission limitation.
§ 61.245	Test methods and procedures.
§ 61.246	Recordkeeping requirements.
§ 61.247	Reporting requirements.
Table 1 to Subpart V of Part 61	—Surge Control Vessels and Bottoms Receivers at Existing Sources
Table 2 to Subpart V of Part 61	—Surge Control Vessels and Bottoms Receivers at New Sources

SOURCE: 49 FR 23513, June 6, 1984, unless otherwise noted.

§ 61.240 Applicability and designation of sources.

(a) The provisions of this subpart apply to each of the following sources that are intended to operate in volatile hazardous air pollutant (VHAP) service: pumps, compressors, pressure relief devices, sampling connection systems, open-ended valves or lines, valves, connectors, surge control vessels, bottoms receivers, and control devices or systems required by this subpart.

(b) The provisions of this subpart apply to the sources listed in paragraph (a) after the date of promulgation of a specific subpart in part 61.

(c) While the provisions of this subpart are effective, a source to which this subpart applies that is also subject to the provisions of 40 CFR part 60 only will be required to comply with the provisions of this subpart.

(d) *Alternative means of compliance* —(1) *Option to comply with part 65*. Owners or operators may choose to comply with 40 CFR part 65 to satisfy the requirements of §§ 61.242-1 through 61.247 for equipment that is subject to this subpart and that is part of the same process unit. When choosing to comply with 40 CFR part 65, the requirements of §§ 61.245(d) and 61.246(i) and (j) still apply. Other provisions applying to owners or operators who choose to comply with 40 CFR part 65 are provided in 40 CFR 65.1.

(2) *Part 65, subpart C or F*. For owners or operators choosing to comply with 40 CFR part 65, each surge control vessel and bottoms receiver subject to this subpart that meets the conditions specified in table 1 or table 2 of this subpart shall meet the requirements for storage vessels in 40 CFR part 65, subpart C; all other equipment subject to this subpart shall meet the requirements in 40 CFR part 65, subpart F.

(3) *Part 61, subpart A*. Owners or operators who choose to comply with 40 CFR part 65, subpart C or F, must also comply with §§ 61.01, 61.02, 61.05 through 61.08, 61.10(b) through (d), 61.11, and 61.15 for that equipment. All sections and paragraphs of subpart A of this part that are not mentioned in this paragraph (d)(3) do not apply to owners or operators of equipment subject to this subpart complying with 40 CFR part 65, subpart C or F, except that provisions required to be met prior to implementing 40 CFR part 65 still apply. Owners and operators who choose to comply with 40 CFR part 65, subpart C or F, must comply with 40 CFR part 65, subpart A.

(4) *Rules referencing this subpart*. Owners or operators referenced to this subpart from subpart F or J of this part may choose to comply with 40 CFR part 65 for all equipment listed in paragraph (a) of this section.

[49 FR 23513, June 6, 1984, as amended at 65 FR 78280, Dec. 14, 2000]

§ 61.241 Definitions.

As used in this subpart, all terms not defined herein shall have the meaning given them in the Act, in subpart A of part 61, or in specific subparts of part 61; and the following terms shall have specific meaning given them:

Bottoms receiver means a tank that collects distillation bottoms before the stream is sent for storage or for further downstream processing.

Closed-vent system means a system that is not open to atmosphere and that is composed of hard-piping, ductwork, connections, and, if necessary, flow-inducing devices that transport gas or vapor from a piece or pieces of equipment to a control device or back to a process.

Connector means flanged, screwed, welded, or other joined fittings used to connect two pipe lines or a pipe line and a piece of equipment. For the purpose of reporting and recordkeeping, connector means flanged fittings that are not covered by insulation or other materials that prevent location of the fittings.

Control device means an enclosed combustion device, vapor recovery system, or flare.

Double block and bleed system means two block valves connected in series with a bleed valve or line that can vent the line between the two block valves.

Duct work means a conveyance system such as those commonly used for heating and ventilation systems. It is often made of sheet metal and often has sections connected by screws or crimping. Hard-piping is not ductwork.

Equipment means each pump, compressor, pressure relief device, sampling connection system, open-ended valve or line, valve, connector, surge control vessel, bottoms receiver in VHAP service, and any control devices or systems required by this subpart.

First attempt at repair means to take rapid action for the purpose of stopping or reducing leakage of organic material to atmosphere using best practices.

In gas/vapor service means that a piece of equipment contains process fluid that is in the gaseous state at operating conditions.

Fuel gas means gases that are combusted to derive useful work or heat.

Fuel gas system means the offsite and onsite piping and flow and pressure control system that gathers gaseous stream(s) generated by onsite operations, may blend them with other sources of gas, and transports the gaseous stream for use as fuel gas in combustion devices or in-process combustion equipment, such as furnaces and gas turbines, either singly or in combination.

Hard-piping means pipe or tubing that is manufactured and properly installed using good engineering judgement and standards such as ASME B31.3, Process Piping (available from the American Society of Mechanical Engineers, PO Box 2900, Fairfield, NJ 07007-2900).

In liquid service means that a piece of equipment is not in gas/vapor service.

In-situ sampling systems means nonextractive samplers or in-line samplers.

In vacuum service means that equipment is operating at an internal pressure which is at least 5 kilopascals (kPa) (0.7 psia) below ambient pressure.

In VHAP service means that a piece of equipment either contains or contacts a fluid (liquid or gas) that is at least 10 percent by weight a volatile hazardous air pollutant (VHAP) as determined according to the provisions of § 61.245(d). The provisions of § 61.245(d) also specify how to determine that a piece of equipment is not in VHAP service.

In VOC service means, for the purposes of this subpart, that (a) the piece of equipment contains or contacts a process fluid that is at least 10 percent VOC by weight (see 40 CFR 60.2 for the definition of volatile organic compound or VOC and 40 CFR 60.485(d) to determine whether a piece of equipment is not in VOC service) and (b) the piece of equipment is not in heavy liquid service as defined in 40 CFR 60.481.

Maximum true vapor pressure means the equilibrium partial pressure exerted by the total VHAP in the stored or transferred liquid at the temperature equal to the highest calendar-month average of the liquid storage or transfer temperature for liquids stored or transferred above or below the ambient temperature or at the local maximum monthly average temperature as reported by the National Weather Service for liquids stored or transferred at the ambient temperature, as determined:

(1) In accordance with methods described in American Petroleum Institute Publication 2517, Evaporative Loss From External Floating-Roof Tanks (incorporated by reference as specified in § 61.18); or

(2) As obtained from standard reference texts; or

(3) As determined by the American Society for Testing and Materials Method D2879-83, Standard Test Method for Vapor Pressure-Temperature Relationship and Initial Decomposition Temperature of Liquids by Isotenoscope (incorporated by reference as specified in § 61.18); or

(4) Any other method approved by the Administrator.

Open-ended valve or line means any valve, except pressure relief valves, having one side of the valve seat in contact with process fluid and one side open to atmosphere, either directly or through open piping.

Pressure release means the emission of materials resulting from the system pressure being greater than the set pressure of the pressure relief device.

Process unit means equipment assembled to produce a VHAP or its derivatives as intermediates or final products, or equipment assembled to use a VHAP in the production of a product. A process

unit can operate independently if supplied with sufficient feed or raw materials and sufficient product storage facilities.

Process unit shutdown means a work practice or operational procedure that stops production from a process unit or part of a process unit. An unscheduled work practice or operational procedure that stops production from a process unit or part of a process unit for less than 24 hours is not a process unit shutdown. The use of spare equipment and technically feasible bypassing of equipment without stopping production are not process unit shutdowns.

Repaired means that equipment is adjusted, or otherwise altered, to eliminate a leak.

Sampling connection system means an assembly of equipment within a process unit used during periods of representative operation to take samples of the process fluid. Equipment used to take non-routine grab samples is not considered a sampling connection system.

Semiannual means a 6-month period; the first semiannual period concludes on the last day of the last month during the 180 days following initial startup for new sources; and the first semiannual period concludes on the last day of the last full month during the 180 days after the effective date of a specific subpart that references this subpart for existing sources.

Sensor means a device that measures a physical quantity or the change in a physical quantity, such as temperature, pressure, flow rate, pH, or liquid level.

Stuffing box pressure means the fluid (liquid or gas) pressure inside the casing or housing of a piece of equipment, on the process side of the inboard seal.

Surge control vessel means feed drums, recycle drums, and intermediate vessels. Surge control vessels are used within a process unit when in-process storage, mixing, or management of flow rates of volumes is needed on a recurring or ongoing basis to assist in production of a product.

Volatile hazardous air pollutant or *VHAP* means a substance regulated under this part for which a standard for equipment leaks of the substance has been proposed and promulgated. Benzene is a VHAP. Vinyl chloride is a VHAP.

[49 FR 23513, June 6, 1984; 49 FR 38946, Oct. 2, 1984, as amended at 51 FR 34915, Sept. 30, 1986; 54 FR 38076, Sept. 14, 1989; 65 FR 62158, Oct. 17, 2000; 65 FR 78280, Dec. 14, 2000]

§ 61.242-1 Standards: General.

(a) Each owner or operator subject to the provisions of this subpart shall demonstrate compliance with the requirements of §§ 61.242-1 to 61.242-11 for each new and existing source as required in 40 CFR 61.05, except as provided in §§ 61.243 and 61.244.

(b) Compliance with this subpart will be determined by review of records, review of performance test results, and inspection using the methods and procedures specified in § 61.245.

(c)(1) An owner or operator may request a determination of alternative means of emission limitation to the requirements of §§ 61.242-2, 61.242-3, 61.242-5, 61.242-6, 61.242-7, 61.242-8, 61.242-9 and 61.242-11 as provided in § 61.244.

(2) If the Administrator makes a determination that a means of emission limitation is at least a permissible alternative to the requirements of § 61.242-2, 61.242-3, 61.242-5, 61.242-6, 61.242-7, 61.242-8, 61.242-9 or 61.242-11, an owner or operator shall comply with the requirements of that determination.

(d) Each piece of equipment to which this subpart applies shall be marked in such a manner that it can be distinguished readily from other pieces of equipment.

(e) Equipment that is in vacuum service is excluded from the requirements of § 61.242-2, to § 61.242-11 if it is identified as required in § 61.246(e)(5).

[49 FR 23513, June 6, 1984; 49 FR 38946, Oct. 2, 1984]

§ 61.242-2 Standards: Pumps.

(a)(1) Each pump shall be monitored monthly to detect leaks by the methods specified in § 61.245 (b), except as provided in § 61.242-1(c) and paragraphs (d), (e), (f) and (g) of this section.

(2) Each pump shall be checked by visual inspection each calendar week for indications of liquids dripping from the pump seal.

(b)(1) If an instrument reading of 10,000 ppm or greater is measured, a leak is detected.

(2) If there are indications of liquids dripping from the pump seal, a leak is detected.

(c)(1) When a leak is detected, it shall be repaired as soon as practicable, but not later than 15 calendar days after it is detected, except as provided in § 61.242-10.

(2) A first attempt at repair shall be made no later than 5 calendar days after each leak is detected.

(d) Each pump equipped with a dual mechanical seal system that includes a barrier fluid system is exempt from the requirements of paragraphs (a) and (b) of this section, provided the following requirements are met:

(1) Each dual mechanical seal system is:

(i) Operated with the barrier fluid at a pressure that is at all times greater than the pump stuffing box pressure; or

(ii) Equipped with a barrier fluid degassing reservoir that is routed to a process or fuel gas system or connected by a closed-vent system to a control device that complies with the requirements of § 61.242-11; or

(iii) Equipped with a system that purges the barrier fluid into a process stream with zero VHAP emissions to atmosphere.

(2) The barrier fluid is not in VHAP service and, if the pump is covered by standards under 40 CFR part 60, is not in VOC service.

(3) Each barrier fluid system is equipped with a sensor that will detect failure of the seal system, the barrier fluid system, or both.

(4) Each pump is checked by visual inspection each calendar week for indications of liquids dripping from the pump seal.

(i) If there are indications of liquid dripping from the pump seal at the time of the weekly inspection, the pump shall be monitored as specified in § 61.245 to determine the presence of VOC and VHAP in the barrier fluid.

(ii) If the monitor reading (taking into account any background readings) indicates the presence of VHAP, a leak is detected. For the purpose of this paragraph, the monitor may be calibrated with VHAP, or may employ a gas chromatography column to limit the response of the monitor to VHAP, at the option of the owner or operator.

(iii) If an instrument reading of 10,000 ppm or greater (total VOC) is measured, a leak is detected.

(5) Each sensor as described in paragraph (d)(3) of this section is checked daily or is equipped with an audible alarm.

(6)(i) The owner or operator determines, based on design considerations and operating experience, criteria applicable to the presence and frequency of drips and to the sensor that indicates failure of the seal system, the barrier fluid system, or both.

(ii) If indications of liquids dripping from the pump seal exceed the criteria established in paragraph (d)(6)(i) of this section, or if, based on the criteria established in paragraph (d)(6)(i) of this section, the sensor indicates failure of the seal system, the barrier fluid system, or both, a leak is detected.

(iii) When a leak is detected, it shall be repaired as soon as practicable, but no later than 15 calendar days after it is detected, except as provided in § 61.242-10.

(iv) A first attempt at repair shall be made no later than five calendar days after each leak is detected.

(e) Any pump that is designated, as described in § 61.246(e)(2), for no detectable emissions, as indicated by an instrument reading of less than 500 ppm above background, is exempt from the requirements of paragraphs (a), (c), and (d) if the pump:

(1) Has no externally actuated shaft penetrating the pump housing,

(2) Is demonstrated to be operating with no detectable emissions, as indicated by an instrument reading of less than 500 ppm above background, as measured by the method specified in § 61.245(c), and

(3) Is tested for compliance with paragraph (e)(2) initially upon designation, annually, and at other times requested by the Administrator.

(f) If any pump is equipped with a closed-vent system capable of capturing and transporting any leakage from the seal or seals to a process or fuel gas system or to a control device that complies with the requirements of § 61.242-11, it is exempt from the requirements of paragraphs (a) through (e) of this section.

(g) Any pump that is designated, as described in § 61.246(f)(1), as an unsafe-to-monitor pump is exempt from the monitoring and inspection requirements of paragraphs (a) and (d)(4) through (6) of this section if:

(1) The owner or operator of the pump demonstrates that the pump is unsafe-to-monitor because monitoring personnel would be exposed to an immediate danger as a consequence of complying with paragraph (a) of this section; and

(2) The owner or operator of the pump has a written plan that requires monitoring of the pump as frequently as practicable during safe-to-monitor times but not more frequently than the periodic monitoring schedule otherwise applicable, and repair of the equipment according to the procedures in paragraph (c) of this section if a leak is detected.

(h) Any pump that is located within the boundary of an unmanned plant site is exempt from the weekly visual inspection requirement of paragraphs (a)(2) and (d)(4) of this section, and the daily requirements of paragraph (d)(5) of this section, provided that each pump is visually inspected as often as practicable and at least monthly.

[49 FR 23513, June 6, 1984, as amended at 49 FR 38946, Oct. 2, 1984; 55 FR 28349, July 10, 1990; 65 FR 78281, Dec. 14, 2000]

§ 61.242-3 Standards: Compressors.

(a) Each compressor shall be equipped with a seal system that includes a barrier fluid system and that prevents leakage of process fluid to atmosphere, except as provided in § 61.242-1(c) and paragraphs (h) and (i) of this section.

(b) Each compressor seal system as required in paragraph (a) shall be:

(1) Operated with the barrier fluid at a pressure that is greater than the compressor stuffing box pressure; or

(2) Equipped with a barrier fluid system degassing reservoir that is routed to a process or fuel gas system or connected by a closed-vent system to a control device that complies with the requirements of § 61.242-11; or

(3) Equipped with a system that purges the barrier fluid into a process stream with zero VHAP emissions to atmosphere.

(c) The barrier fluid shall not be in VHAP service and, if the compressor is covered by standards under 40 CFR part 60, shall not be in VOC service.

(d) Each barrier fluid system as described in paragraphs (a)-(c) of this section shall be equipped with a sensor that will detect failure of the seal system, barrier fluid system, or both.

(e)(1) Each sensor as required in paragraph (d) of this section shall be checked daily or shall be equipped with an audible alarm unless the compressor is located within the boundary of an unmanned plant site.

(2) The owner or operator shall determine, based on design considerations and operating experience, a criterion that indicates failure of the seal system, the barrier fluid system, or both.

(f) If the sensor indicates failure of the seal system, the barrier fluid system, or both based on the criterion determined under paragraph (e)(2) of this section, a leak is detected.

(g)(1) When a leak is detected, it shall be repaired as soon as practicable, but not later than 15 calendar days after it is detected, except as provided in § 61.242-10.

(2) A first attempt at repair shall be made no later than 5 calendar days after each leak is detected.

(h) A compressor is exempt from the requirements of paragraphs (a) and (b) of this section if it is equipped with a closed-vent system to capture and transport leakage from the compressor drive shaft back to a process or fuel gas system or to a control device that complies with the requirements of § 61.242-11, except as provided in paragraph (i) of this section.

(i) Any Compressor that is designated, as described in § 61.246(e)(2), for no detectable emission as indicated by an instrument reading of less than 500 ppm above background is exempt from the requirements of paragraphs (a)-(h) if the compressor:

(1) Is demonstrated to be operating with no detectable emissions, as indicated by an instrument reading of less than 500 ppm above background, as measured by the method specified in § 61.245(c); and

(2) Is tested for compliance with paragraph (i)(1) initially upon designation, annually, and at other times requested by the Administrator.

[49 FR 23513, June 6, 1984; 49 FR 38946, Oct. 2, 1984, as amended at 65 FR 78281, Dec. 14, 2000]

§ 61.242-4 Standards: Pressure relief devices in gas/vapor service.

(a) Except during pressure releases, each pressure relief device in gas/vapor service shall be operated with no detectable emissions, as indicated by an instrument reading of less than 500 ppm above background, as measured by the method specified in § 61.245(c).

(b)(1) After each pressure release, the pressure relief device shall be returned to a condition of no detectable emissions, as indicated by an instrument reading of less than 500 ppm above background,

as soon as practicable, but no later than 5 calendar days after each pressure release, except as provided in § 61.242-10.

(2) No later than 5 calendar days after the pressure release, the pressure relief device shall be monitored to confirm the condition of no detectable emissions, as indicated by an instrument reading of less than 500 ppm above background, as measured by the method specified in § 61.245(c).

(c) Any pressure relief device that is routed to a process or fuel gas system or equipped with a closed-vent system capable of capturing and transporting leakage from the pressure relief device to a control device as described in § 61.242-11 is exempt from the requirements of paragraphs (a) and (b) of this section.

(d)(1) Any pressure relief device that is equipped with a rupture disk upstream of the pressure relief device is exempt from the requirements of paragraphs (a) and (b) of this section, provided the owner or operator complies with the requirements in paragraph (d)(2) of this section.

(2) After each pressure release, a new rupture disk shall be installed upstream of the pressure relief device as soon as practicable, but no later than 5 calendar days after each pressure release, except as provided in § 61.242-10.

[49 FR 23513, June 6, 1984; 49 FR 38946, Oct. 2, 1984, as amended at 65 FR 78281, Dec. 14, 2000]

§ 61.242-5 Standards: Sampling connecting systems.

(a) Each sampling connection system shall be equipped with a closed-purge, closed-loop, or closed vent system, except as provided in § 61.242-1(c). Gases displaced during filling of the sample container are not required to be collected or captured.

(b) Each closed-purge, closed-loop, or closed vent system as required in paragraph (a) of this section shall comply with the requirements specified in paragraphs (b)(1) through (4) of this section:

(1) Return the purged process fluid directly to the process line; or

(2) Collect and recycle the purged process fluid; or

(3) Be designed and operated to capture and transport all the purged process fluid to a control device that complies with the requirements of § 61.242-11; or

(4) Collect, store, and transport the purged process fluid to any of the following systems or facilities:

(i) A waste management unit as defined in 40 CFR 63.111 if the waste management unit is subject to and operated in compliance with the provisions of 40 CFR part 63, subpart G, applicable to Group 1 wastewater streams; or

(ii) A treatment, storage, or disposal facility subject to regulation under 40 CFR part 262, 264, 265, or 266; or

(iii) A facility permitted, licensed, or registered by a State to manage municipal or industrial solid waste, if the process fluids are not hazardous waste as defined in 40 CFR part 261.

(c) In-situ sampling systems and sampling systems without purges are exempt from the requirements of paragraphs (a) and (b) of this section.

[65 FR 78281, Dec. 14, 2000]

§ 61.242-6 Standards: Open-ended valves or lines.

(a)(1) Each open-ended valve or line shall be equipped with a cap, blind flange, plug, or a second valve, except as provided in § 61.242-1(c).

(2) The cap, blind flange, plug, or second valve shall seal the open end at all times except during operations requiring process fluid flow through the open-ended valve or line.

(b) Each open-ended valve or line equipped with a second valve shall be operated in a manner such that the valve on the process fluid end is closed before the second valve is closed.

(c) When a double block and bleed system is being used, the bleed valve or line may remain open during operations that require venting the line between the block valves but shall comply with paragraph (a) at all other times.

(d) Open-ended valves or lines in an emergency shutdown system which are designed to open automatically in the event of a process upset are exempt from the requirements of paragraphs (a), (b) and (c) of this section.

(e) Open-ended valves or lines containing materials which would autocatalytically polymerize or would present an explosion, serious overpressure, or other safety hazard if capped or equipped with a double block and bleed system as specified in paragraphs (a) through (c) of this section are exempt from the requirements of paragraphs (a) through (c) of this section.

[49 FR 23513, June 6, 1984, as amended at 65 FR 78282, Dec. 14, 2000]

§ 61.242-7 Standards: Valves.

(a) Each valve shall be monitored monthly to detect leaks by the method specified in § 61.245(b) and shall comply with paragraphs (b)-(e), except as provided in paragraphs (f), (g), and (h) of this section, § 61.243-1 or § 61.243-2, and § 61.242-1(c).

(b) If an instrument reading of 10,000 ppm or greater is measured, a leak is detected.

(c)(1) Any valve for which a leak is not detected for 2 successive months may be monitored the first month of every quarter, beginning with the next quarter, until a leak is detected.

(2) If a leak is detected, the valve shall be monitored monthly until a leak is not detected for 2 successive months.

(d)(1) When a leak is detected, it shall be repaired as soon as practicable, but no later than 15 calendar days after the leak is detected, except as provided in § 61.242-10.

(2) A first attempt at repair shall be made no later than 5 calendar days after each leak is detected.

(e) First attempts at repair include, but are not limited to, the following best practices where practicable:

- (1) Tightening of bonnet bolts;
- (2) Replacement of bonnet bolts;
- (3) Tightening of packing gland nuts; and
- (4) Injection of lubricant into lubricated packing.

(f) Any valve that is designated, as described in § 61.246(e)(2), for no detectable emissions, as indicated by an instrument reading of less than 500 ppm above background, is exempt from the requirements of paragraph (a) if the valve:

(1) Has no external actuating mechanism in contact with the process fluid;

(2) Is operated with emissions less than 500 ppm above background, as measured by the method specified in § 61.245(c); and

(3) Is tested for compliance with paragraph (f)(2) initially upon designation, annually, and at other times requested by the Administrator.

(g) Any valve that is designated, as described in § 61.246(f)(1), as an unsafe-to-monitor valve is exempt from the requirements of paragraph (a) if:

(1) The owner or operator of the valve demonstrates that the valve is unsafe to monitor because monitoring personnel would be exposed to an immediate danger as a consequence of complying with paragraph (a); and

(2) The owner or operator of the valve has a written plan that requires monitoring of the valve as frequent as practicable during safe-to-monitor times.

(h) Any valve that is designated, as described in § 61.246(f)(2), as a difficult-to-monitor valve is exempt from the requirements of paragraph (a) if:

(1) The owner or operator of the valve demonstrates that the valve cannot be monitored without elevating the monitoring personnel more than 2 meters above a support surface;

(2) The process unit within which the valve is located is an existing process unit; and

(3) The owner or operator of the valve follows a written plan that requires monitoring of the valve at least once per calendar year.

§ 61.242-8 Standards: Pressure relief services in liquid service and connectors.

(a) If evidence of a potential leak is found by visual, audible, olfactory, or any other detection method at pressure relief devices in liquid service and connectors, the owner or operator shall follow either one of the following procedures, except as provided in § 61.242-1(c):

(1) The owner or operator shall monitor the equipment within 5 days by the method specified in § 61.245(b) and shall comply with the requirements of paragraphs (b) through (d) of this section.

(2) The owner or operator shall eliminate the visual, audible, olfactory, or other indication of a potential leak.

(b) If an instrument reading of 10,000 ppm or greater is measured, a leak is detected.

(c)(1) When a leak is detected, it shall be repaired as soon as practicable, but not later than 15 calendar days after it is detected, except as provided in § 61.242-10.

(2) The first attempt at repair shall be made no later than 5 calendar days after each leak is detected.

(d) First attempts at repair include, but are not limited to, the best practices described under § 61.242-7(e).

[49 FR 23513, June 6, 1984; 49 FR 38946, Oct. 2, 1984, as amended at 65 FR 78282, Dec. 14, 2000]

§ 61.242-9 Standards: Surge control vessels and bottoms receivers.

Each surge control vessel or bottoms receiver that is not routed back to the process and that meets the conditions specified in table 1 or table 2 of this subpart shall be equipped with a closed-vent system capable of capturing and transporting any leakage from the vessel back to the process or to a control device as described in § 61.242-11, except as provided in § 61.242-1(c); or comply with the requirements of 40 CFR 63.119(b) or (c).

[65 FR 78282, Dec. 14, 2000]

§ 61.242-10 Standards: Delay of repair.

(a) Delay of repair of equipment for which leaks have been detected will be allowed if repair within 15 days is technically infeasible without a process unit shutdown. Repair of this equipment shall occur before the end of the next process unit shutdown.

(b) Delay of repair of equipment for which leaks have been detected will be allowed for equipment that is isolated from the process and that does not remain in VHAP service.

(c) Delay of repair for valves will be allowed if:

(1) The owner or operator demonstrates that emissions of purged material resulting from immediate repair are greater than the fugitive emissions likely to result from delay of repair, and

(2) When repair procedures are effected, the purged material is collected and destroyed or recovered in a control device complying with § 61.242-11.

(d) Delay of repair for pumps will be allowed if:

(1) Repair requires the use of a dual mechanical seal system that includes a barrier fluid system, and

(2) Repair is completed as soon as practicable, but not later than 6 months after the leak was detected.

(e) Delay of repair beyond a process unit shutdown will be allowed for a valve if valve assembly replacement is necessary during the process unit shutdown, valve assembly supplies have been depleted, and valve assembly supplies had been sufficiently stocked before the supplies were depleted. Delay of repair beyond the next process unit shutdown will not be allowed unless the next process unit shutdown occurs sooner than 6 months after the first process unit shutdown.

[49 FR 23513, June 6, 1984, as amended at 65 FR 78282, Dec. 14, 2000]

§ 61.242-11 Standards: Closed-vent systems and control devices.

(a) Owners or operators of closed-vent systems and control devices used to comply with provisions of this subpart shall comply with the provisions of this section, except as provided in § 61.242-1(c).

(b) Vapor recovery systems (for example, condensers and absorbers) shall be designed and operated to recover the organic vapors vented to them with an efficiency of 95 percent or greater, or to an exit concentration of 20 parts per million by volume, whichever is less stringent.

(c) Enclosed combustion devices shall be designed and operated to reduce the VHAP emissions vented to them with an efficiency of 95 percent or greater, or to an exit concentration of 20 parts per million by volume, on a dry basis, corrected to 3 percent oxygen, whichever is less stringent, or to provide a minimum residence time of 0.50 seconds at a minimum temperature of 760 °C.

(d) Flares shall used to comply with this subpart shall comply with the requirements of § 60.18.

(e) Owners or operators of control devices that are used to comply with the provisions of this subpart shall monitor these control devices to ensure that they are operated and maintained in conformance with their design.

(f) Except as provided in paragraphs (i) through (k) of this section, each closed vent system shall be inspected according to the procedures and schedule specified in paragraph (f)(1) or (2) of this section, as applicable.

(1) If the vapor collection system or closed vent system is constructed of hard-piping, the owner or operator shall comply with the following requirements:

(i) Conduct an initial inspection according to the procedures in § 61.245(b); and

(ii) Conduct annual visual inspections for visible, audible, or olfactory indications of leaks.

(2) If the vapor collection system or closed vent system is constructed of ductwork, the owner or operator shall:

(i) Conduct an initial inspection according to the procedures in § 61.245(b); and

(ii) Conduct annual inspections according to the procedures in § 61.245(b).

(g) Leaks, as indicated by an instrument reading greater than 500 parts per million by volume above background or by visual inspections, shall be repaired as soon as practicable except as provided in paragraph (h) of this section.

(1) A first attempt at repair shall be made no later than 5 calendar days after the leak is detected.

(2) Repair shall be completed no later than 15 calendar days after the leak is detected.

(h) Delay of repair of a closed vent system for which leaks have been detected is allowed if the repair is technically infeasible without a process unit shutdown, or if the owner or operator determines that emissions resulting from immediate repair would be greater than the fugitive emissions likely to result from delay of repair. Repair of such equipment shall be complete by the end of the next process unit shutdown.

(i) If a vapor collection system or closed vent system is operated under a vacuum, it is exempt from the inspection requirements of paragraphs (f)(1)(i) and (2) of this section.

(j) Any parts of the closed vent system that are designated, as described in paragraph (l)(1) of this section, as unsafe-to-inspect are exempt from the inspection requirements of paragraphs (f)(1)(i) and (2) of this section if they comply with the following requirements:

(1) The owner or operator determines that the equipment is unsafe-to-inspect because inspecting personnel would be exposed to an imminent or potential danger as a consequence of complying with paragraph (f)(1)(i) or (2) of this section; and

(2) The owner or operator has a written plan that requires inspection of the equipment as frequently as practicable during safe-to-inspect times.

(k) Any parts of the closed vent system that are designated, as described in paragraph (l)(2) of this section, as difficult-to-inspect are exempt from the inspection requirements of paragraphs (f)(1)(i) and (2) of this section if they comply with the following requirements:

(1) The owner or operator determines that the equipment cannot be inspected without elevating the inspecting personnel more than 2 meters above a support surface; and

(2) The owner or operator has a written plan that requires inspection of the equipment at least once every 5 years. A closed vent system is exempt from inspection if it is operated under a vacuum.

(l) The owner or operator shall record the following information:

(1) Identification of all parts of the closed vent system that are designated as unsafe-to-inspect, an explanation of why the equipment is unsafe-to-inspect, and the plan for inspecting the equipment.

(2) Identification of all parts of the closed vent system that are designated as difficult-to-inspect, an explanation of why the equipment is difficult-to-inspect, and the plan for inspecting the equipment.

(3) For each inspection during which a leak is detected, a record of the information specified in § 61.246(c).

(4) For each inspection conducted in accordance with § 61.245(b) during which no leaks are detected, a record that the inspection was performed, the date of the inspection, and a statement that no leaks were detected.

(5) For each visual inspection conducted in accordance with paragraph (f)(1)(ii) of this section during which no leaks are detected, a record that the inspection was performed, the date of the inspection, and a statement that no leaks were detected.

(m) Closed vent systems and control devices used to comply with provisions of this subpart shall be operated at all times when emissions may be vented to them.

[49 FR 23513, June 6, 1984; 49 FR 38946, Oct. 2, 1984, as amended at 51 FR 2702, Jan. 21, 1986; 65 FR 62158, Oct. 17, 2000; 65 FR 78282, Dec. 14, 2000]

§ 61.243-1 Alternative standards for valves in VHAP service—allowable percentage of valves leaking.

(a) An owner or operator may elect to have all valves within a process unit to comply with an allowable percentage of valves leaking of equal to or less than 2.0 percent.

(b) The following requirements shall be met if an owner or operator decides to comply with an allowable percentage of valves leaking:

(1) An owner or operator must notify the Administrator that the owner or operator has elected to have all valves within a process unit to comply with the allowable percentage of valves leaking before implementing this alternative standard, as specified in § 61.247(d).

(2) A performance test as specified in paragraph (c) of this section shall be conducted initially upon designation, annually, and at other times requested by the Administrator.

(3) If a valve leak is detected, it shall be repaired in accordance with § 61.242-7(d) and (e).

(c) Performance tests shall be conducted in the following manner:

(1) All valves in VHAP service within the process unit shall be monitored within 1 week by the methods specified in § 61.245(b).

(2) If an instrument reading of 10,000 ppm or greater is measured, a leak is detected.

(3) The leak percentage shall be determined by dividing the number of valves in VHAP service for which leaks are detected by the number of valves in VHAP service within the process unit.

(d) Owner or operators who elect to have all valves comply with this alternative standard shall not have a process unit with a leak percentage greater than 2.0 percent.

(e) If an owner or operator decides no longer to comply with § 61.243-1, the owner or operator must notify the Administrator in writing that the work practice standard described in § 61.242-7(a)-(e) will be followed.

§ 61.243-2 Alternative standards for valves in VHAP service—skip period leak detection and repair.

(a)(1) An owner or operator may elect for all valves within a process unit to comply with one of the alternative work practices specified in paragraphs (b)(2) and (3) of this section.

(2) An owner or operator must notify the Administrator before implementing one of the alternative work practices, as specified in § 61.247(d).

(b)(1) An owner or operator shall comply initially with the requirements for valves, as described in § 61.242-7.

(2) After 2 consecutive quarterly leak detection periods with the percentage of valves leaking equal to or less than 2.0, an owner or operator may begin to skip one of the quarterly leak detection periods for the valves in VHAP service.

(3) After five consecutive quarterly leak detection periods with the percentage of valves leaking equal to or less than 2.0, an owner or operator may begin to skip three of the quarterly leak detection periods for the valves in VHAP service.

(4) If the percentage of valves leaking is greater than 2.0, the owner or operator shall comply with the requirements as described in § 61.242-7 but may again elect to use this section.

[49 FR 23513, June 6, 1984, as amended at 65 FR 62158, Oct. 17, 2000]

§ 61.244 Alternative means of emission limitation.

(a) Permission to use an alternative means of emission limitation under section 112(e)(3) of the Clean Air Act shall be governed by the following procedures:

(b) Where the standard is an equipment, design, or operational requirement:

(1) Each owner or operator applying for permission shall be responsible for collecting and verifying test data for an alternative means of emission limitation to test data for the equipment, design, and operational requirements.

(2) The Administrator may condition the permission on requirements that may be necessary to assure operation and maintenance to achieve the same emission reduction as the equipment, design, and operational requirements.

(c) Where the standard is a work practice:

(1) Each owner or operator applying for permission shall be responsible for collecting and verifying test data for an alternative means of emission limitation.

(2) For each source for which permission is requested, the emission reduction achieved by the required work practices shall be demonstrated for a minimum period of 12 months.

(3) For each source for which permission is requested, the emission reduction achieved by the alternative means of emission limitation shall be demonstrated.

(4) Each owner or operator applying for permission shall commit in writing each source to work practices that provide for emission reductions equal to or greater than the emission reductions achieved by the required work practices.

(5) The Administrator will compare the demonstrated emission reduction for the alternative means of emission limitation to the demonstrated emission reduction for the required work practices and will consider the commitment in paragraph (c)(4).

(6) The Administrator may condition the permission on requirements that may be necessary to assure operation and maintenance to achieve the same emission reduction as the required work practices of this subpart.

(d) An owner or operator may offer a unique approach to demonstrate the alternative means of emission limitation.

(e)(1) Manufacturers of equipment used to control equipment leaks of a VHAP may apply to the Administrator for permission for an alternative means of emission limitation that achieves a reduction in emissions of the VHAP achieved by the equipment, design, and operational requirements of this subpart.

(2) The Administrator will grant permission according to the provisions of paragraphs (b), (c), and (d).

[49 FR 23513, June 6, 1984, as amended at 65 FR 62158, Oct. 17, 2000]

§ 61.245 Test methods and procedures.

(a) Each owner or operator subject to the provisions of this subpart shall comply with the test methods and procedures requirements provided in this section.

(b) Monitoring, as required in §§ 61.242, 61.243, 61.244, and 61.135, shall comply with the following requirements:

(1) Monitoring shall comply with Method 21 of appendix A of 40 CFR part 60.

(2) The detection instrument shall meet the performance criteria of Method 21.

(3) The instrument shall be calibrated before use on each day of its use by the procedures specified in Method 21.

(4) Calibration gases shall be:

(i) Zero air (less than 10 ppm of hydrocarbon in air); and

(ii) A mixture of methane or n-hexane and air at a concentration of approximately, but less than, 10,000 ppm methane or n-hexane.

(5) The instrument probe shall be traversed around all potential leak interfaces as close to the interface as possible as described in Method 21.

(c) When equipment is tested for compliance with or monitored for no detectable emissions, the owner or operator shall comply with the following requirements:

(1) The requirements of paragraphs (b) (1) through (4) shall apply.

(2) The background level shall be determined, as set forth in Method 21.

(3) The instrument probe shall be traversed around all potential leak interfaces as close to the interface as possible as described in Method 21.

(4) The arithmetic difference between the maximum concentration indicated by the instrument and the background level is compared with 500 ppm for determining compliance.

(d)(1) Each piece of equipment within a process unit that can conceivably contain equipment in VHAP service is presumed to be in VHAP service unless an owner or operator demonstrates that the piece of equipment is not in VHAP service. For a piece of equipment to be considered not in VHAP service, it must be determined that the percent VHAP content can be reasonably expected never to exceed 10 percent by weight. For purposes of determining the percent VHAP content of the process fluid that is contained in or contacts equipment, procedures that conform to the methods described in ASTM Method D-2267 (incorporated by the reference as specified in § 61.18) shall be used.

(2)(i) An owner or operator may use engineering judgment rather than the procedures in paragraph (d)(1) of this section to demonstrate that the percent VHAP content does not exceed 10 percent by weight, provided that the engineering judgment demonstrates that the VHAP content clearly does not exceed 10 percent by weight. When an owner or operator and the Administrator do not agree on whether a piece of equipment is not in VHAP service, however, the procedures in paragraph (d)(1) of this section shall be used to resolve the disagreement.

(ii) If an owner or operator determines that a piece of equipment is in VHAP service, the determination can be revised only after following the procedures in paragraph (d)(1) of this section.

(3) Samples used in determining the percent VHAP content shall be representative of the process fluid that is contained in or contacts the equipment or the gas being combusted in the flare.

(e)(1) Method 22 of appendix A of 40 CFR part 60 shall be used to determine compliance of flares with the visible emission provisions of this subpart.

(2) The presence of a flare pilot flame shall be monitored using a thermocouple or any other equivalent device to detect the presence of a flame.

(3) The net heating value of the gas being combusted in a flare shall be calculated using the following equation:

$$H_T = K \left(\sum_{i=1}^n C_i H_i \right)$$

Where:

H_T = Net heating value of the sample, MJ/scm (BTU/scf); where the net enthalpy per mole of offgas is based on combustion at 25 °C and 760 mm Hg (77 °F and 14.7 psi), but the standard temperature for determining the volume corresponding to one mole is 20 °C (68 °F).

K = conversion constant, 1.740×10^{-7} (g-mole) (MJ)/(ppm-scm-kcal) (metric units); or 4.674×10^8 ((g-mole) (Btu)/(ppm-scf-kcal)) (English units)

C_i = Concentration of sample component "i" in ppm, as measured by Method 18 of appendix A to 40 CFR part 60 and ASTM D2504-67, 77, or 88 (Reapproved 1993) (incorporated by reference as specified in § 61.18).

H_i = net heat of combustion of sample component "i" at 25 °C and 760 mm Hg (77 °F and 14.7 psi), kcal/g-mole. The heats of combustion may be determined using ASTM D2382-76 or 88 or D4809-95 (incorporated by reference as specified in § 61.18) if published values are not available or cannot be calculated.

(4) The actual exit velocity of a flare shall be determined by dividing the volumetric flowrate (in units of standard temperature and pressure), as determined by Method 2, 2A, 2C, or 2D, as appropriate, by the unobstructed (free) cross section area of the flare tip.

(5) The maximum permitted velocity, V_{max} , for air-assisted flares shall be determined by the following equation:

$$V_{max} = K_1 + K_2 H_T$$

Where:

V_{max} = Maximum permitted velocity, m/sec (ft/sec).

H_T = Net heating value of the gas being combusted, as determined in paragraph (e)(3) of this section, MJ/scm (Btu/scf).

K_1 = 8.706 m/sec (metric units)
= 28.56 ft/sec (English units)

K_2 = 0.7084 m⁴/(MJ-sec) (metric units)
= 0.087 ft⁴/(Btu-sec) (English units)

[49 FR 23513, June 6, 1984, as amended at 49 FR 38946, Oct. 2, 1984; 49 FR 43647, Oct. 31, 1984; 53 FR 36972, Sept. 23, 1988; 54 FR 38077, Sept. 14, 1989; 65 FR 62158, Oct. 17, 2000]

§ 61.246 Recordkeeping requirements.

(a)(1) Each owner or operator subject to the provisions of this subpart shall comply with the recordkeeping requirements of this section.

(2) An owner or operator of more than one process unit subject to the provisions of this subpart may comply with the recordkeeping requirements for these process units in one recordkeeping system if the system identifies each record by each process unit.

(b) When each leak is detected as specified in §§ 61.242-2, 61.242-3, 61.242-7, 61.242-8, and 61.135, the following requirements apply:

(1) A weatherproof and readily visible identification, marked with the equipment identification number, shall be attached to the leaking equipment.

(2) The identification on a valve may be removed after it has been monitored for 2 successive months as specified in § 61.242-7(c) and no leak has been detected during those 2 months.

(3) The identification on equipment, except on a valve, may be removed after it has been repaired.

(c) When each leak is detected as specified in §§ 61.242-2, 61.242-3, 61.242-7, 61.242-8, and 61.135, the following information shall be recorded in a log and shall be kept for 2 years in a readily accessible location:

(1) The instrument and operator identification numbers and the equipment identification number.

(2) The date the leak was detected and the dates of each attempt to repair the leak.

(3) Repair methods applied in each attempt to repair the leak.

(4) "Above 10,000" if the maximum instrument reading measured by the methods specified in § 61.245(a) after each repair attempt is equal to or greater than 10,000 ppm.

(5) "Repair delayed" and the reason for the delay if a leak is not repaired within 15 calendar days after discovery of the leak.

(6) The signature of the owner or operator (or designate) whose decision it was that repair could not be effected without a process shutdown.

(7) The expected date of successful repair of the leak if a leak is not repaired within 15 calendar days.

(8) Dates of process unit shutdowns that occur while the equipment is unrepaired.

(9) The date of successful repair of the leak.

(d) The following information pertaining to the design requirements for closed-vent systems and control devices described in § 61.242-11 shall be recorded and kept in a readily accessible location:

(1) Detailed schematics, design specifications, and piping and instrumentation diagrams.

(2) The dates and descriptions of any changes in the design specifications.

(3) A description of the parameter or parameters monitored, as required in § 61.242-11(e), to ensure that control devices are operated and maintained in conformance with their design and an explanation of why that parameter (or parameters) was selected for the monitoring.

(4) Periods when the closed-vent systems and control devices required in §§ 61.242-2, 61.242-3, 61.242-4, 61.242-5 and 61.242-9 are not operated as designed, including periods when a flare pilot light does not have a flame.

(5) Dates of startups and shutdowns of the closed-vent systems and control devices required in §§ 61.242-2, 61.242-3, 61.242-4, 61.242-5 and 61.242-9.

(e) The following information pertaining to all equipment to which a standard applies shall be recorded in a log that is kept in a readily accessible location:

(1) A list of identification numbers for equipment (except welded fittings) subject to the requirements of this subpart.

(2)(i) A list of identification numbers for equipment that the owner or operator elects to designate for no detectable emissions as indicated by an instrument reading of less than 500 ppm above background.

(ii) The designation of this equipment for no detectable emissions shall be signed by the owner or operator.

(3) A list of equipment identification numbers for pressure relief devices required to comply with § 61.242-4(a).

(4)(i) The dates of each compliance test required in §§ 61.242-2(e), 61.242-3(i), 61.242-4, 61.242-7(f), and 61.135(g).

(ii) The background level measured during each compliance test.

(iii) The maximum instrument reading measured at the equipment during each compliance test.

(5) A list of identification numbers for equipment in vacuum service.

(f) The following information pertaining to all valves subject to the requirements of § 61.242-7(g) and (h) and to all pumps subject to the requirements of § 61.242-2(g) shall be recorded in a log that is kept in a readily accessible location:

(1) A list of identification numbers for valves and pumps that are designated as unsafe to monitor, an explanation for each valve or pump stating why the valve or pump is unsafe to monitor, and the plan for monitoring each valve or pump.

(2) A list of identification numbers for valves that are designated as difficult to monitor, an explanation for each valve stating why the valve is difficult to monitor, and the planned schedule for monitoring each valve.

(g) The following information shall be recorded for valves complying with § 61.243-2:

(1) A schedule of monitoring.

(2) The percent of valves found leaking during each monitoring period.

(h) The following information shall be recorded in a log that is kept in a readily accessible location:

(1) Design criterion required in §§ 61.242-2(d)(5), 61.242-3(e)(2), and 61.135(e)(4) and an explanation of the design criterion; and

(2) Any changes to this criterion and the reasons for the changes.

(i) The following information shall be recorded in a log that is kept in a readily accessible location for use in determining exemptions as provided in the applicability section of this subpart and other specific subparts:

(1) An analysis demonstrating the design capacity of the process unit, and

(2) An analysis demonstrating that equipment is not in VHAP service.

(j) Information and data used to demonstrate that a piece of equipment is not in VHAP service shall be recorded in a log that is kept in a readily accessible location.

[49 FR 23513, June 6, 1984, as amended at 49 FR 38946, Oct. 2, 1984; 54 FR 38077, Sept. 14, 1989; 65 FR 78283, Dec. 14, 2000]

§ 61.247 Reporting requirements.

(a)(1) An owner or operator of any piece of equipment to which this subpart applies shall submit a statement in writing notifying the Administrator that the requirements of §§ 61.242, 61.245, 61.246, and 61.247 are being implemented.

(2) In the case of an existing source or a new source which has an initial startup date preceding the effective date, the statement is to be submitted within 90 days of the effective date, unless a waiver of compliance is granted under § 61.11, along with the information required under § 61.10. If a waiver of compliance is granted, the statement is to be submitted on a date scheduled by the Administrator.

(3) In the case of new sources which did not have an initial startup date preceding December 14, 2000, the statement required under paragraph (a)(1) of this section shall be submitted with the application for approval of construction, as described in § 61.07.

(4) For owners and operators complying with 40 CFR part 65, subpart C or F, the statement required under paragraph (a)(1) of this section shall notify the Administrator that the requirements of 40 CFR part 65, subpart C or F, are being implemented.

(5) The statement is to contain the following information for each source:

(i) Equipment identification number and process unit identification.

(ii) Type of equipment (for example, a pump or pipeline valve).

(iii) Percent by weight VHAP in the fluid at the equipment.

(iv) Process fluid state at the equipment (gas/vapor or liquid).

(v) Method of compliance with the standard (for example, “monthly leak detection and repair” or “equipped with dual mechanical seals”).

(b) A report shall be submitted to the Administrator semiannually starting 6 months after the initial report required in paragraph (a) of this section, that includes the following information:

(1) Process unit identification.

(2) For each month during the semiannual reporting period,

(i) Number of valves for which leaks were detected as described in § 61.242-7(b) of § 61.243-2.

(ii) Number of valves for which leaks were not repaired as required in § 61.242-7(d).

(iii) Number of pumps for which leaks were detected as described in § 61.242-2 (b) and (d)(6).

(iv) Number of pumps for which leaks were not repaired as required in § 61.242-2 (c) and (d)(6).

(v) Number of compressors for which leaks were detected as described in § 61.242-3(f).

(vi) Number of compressors for which leaks were not repaired as required in § 61.242-3(g).

(vii) The facts that explain any delay of repairs and, where appropriate, why a process unit shutdown was technically infeasible.

(3) Dates of process unit shutdowns which occurred within the semiannual reporting period.

(4) Revisions to items reported according to paragraph (a) if changes have occurred since the initial report or subsequent revisions to the initial report.

NOTE: Compliance with the requirements of § 61.10(c) is not required for revisions documented under this paragraph.

(5) The results of all performance tests and monitoring to determine compliance with no detectable emissions and with §§ 61.243-1 and 61.243-2 conducted within the semiannual reporting period.

(c) In the first report submitted as required in paragraph (a) of this section, the report shall include a reporting schedule stating the months that semiannual reports shall be submitted. Subsequent reports shall be submitted according to that schedule, unless a revised schedule has been submitted in a previous semiannual report.

(d) An owner or operator electing to comply with the provisions of §§ 61.243-1 and 61.243-2 shall notify the Administrator of the alternative standard selected 90 days before implementing either of the provisions.

(e) An application for approval of construction or modification, §§ 61.05(a) and 61.07, will not be required if—

(1) The new source complies with the standard, § 61.242;

(2) The new source is not part of the construction of a process unit; and

(3) In the next semiannual report required by paragraph (b) of this section, the information in paragraph (a)(5) of this section is reported.

(f) For owners or operators choosing to comply with 40 CFR part 65, subpart C or F, an application for approval of construction or modification, as required under §§ 61.05 and 61.07 will not be required if:

(1) The new source complies with 40 CFR 65.106 through 65.115 and with 40 CFR part 65, subpart C, for surge control vessels and bottoms receivers;

(2) The new source is not part of the construction of a process unit; and

(3) In the next semiannual report required by 40 CFR 65.120(b) and 65.48(b), the information in paragraph (a)(5) of this section is reported.

[49 FR 23513, June 6, 1984, as amended at 49 FR 38947, Oct. 2, 1984; 54 FR 38077, Sept. 14, 1989; 65 FR 78283, Dec. 14, 2000]

Table 1 to Subpart V of Part 61—Surge Control Vessels and Bottoms Receivers at Existing Sources

Vessel capacity (cubic meters)	Vapor pressure ¹ (kilopascals)
75 ≤ capacity < 151	≥ 13.1
151 ≤ capacity	≥ 5.2

¹ Maximum true vapor pressure as defined in § 61.241.

[65 FR 78283, Dec. 14, 2000]

Table 2 to Subpart V of Part 61—Surge Control Vessels and Bottoms Receivers at New Sources

Vessel capacity (cubic meters)	Vapor pressure ¹ (kilopascals)
$38 \leq \text{capacity} < 151$	≥ 13.1
$151 \leq \text{capacity}$	≥ 0.7

¹ Maximum true vapor pressure as defined in § 61.241.

[65 FR 78283, Dec. 14, 2000]

For questions or comments regarding e-CFR editorial content, features, or design, email ecfr@nara.gov.
For questions concerning e-CFR programming and delivery issues, email webteam@gpo.gov.

Appendix G – 40 CFR Part 61, Subpart FF

ELECTRONIC CODE OF FEDERAL REGULATIONS

e-CFR Data is current as of August 30, 2013

Title 40: Protection of Environment

PART 61—NATIONAL EMISSION STANDARDS FOR HAZARDOUS AIR POLLUTANTS

Subpart **FF**—National Emission Standard for Benzene Waste Operations

Contents

§ 61.340	Applicability.
§ 61.341	Definitions.
§ 61.342	Standards: General.
§ 61.343	Standards: Tanks.
§ 61.344	Standards: Surface impoundments.
§ 61.345	Standards: Containers.
§ 61.346	Standards: Individual drain systems.
§ 61.347	Standards: Oil-water separators.
§ 61.348	Standards: Treatment processes.
§ 61.349	Standards: Closed-vent systems and control devices.
§ 61.350	Standards: Delay of repair.
§ 61.351	Alternative standards for tanks.
§ 61.352	Alternative standards for oil-water separators.
§ 61.353	Alternative means of emission limitation.
§ 61.354	Monitoring of operations.
§ 61.355	Test methods, procedures, and compliance provisions.
§ 61.356	Recordkeeping requirements.
§ 61.357	Reporting requirements.
§ 61.358	Delegation of authority.
§ 61.359	[Reserved]
Appendix A to Part 61	
Appendix B to Part 61—Test Methods	
Appendix C to Part 61—Quality Assurance Procedures	
Appendix D to Part 61—Methods for Estimating Radionuclide Emissions	
Appendix E to Part 61—Compliance Procedures Methods for Determining Compliance With Subpart I	

SOURCE: 55 FR 8346, Mar. 7, 1990, unless otherwise noted.

§ 61.340 Applicability.

(a) The provisions of this subpart apply to owners and operators of chemical manufacturing plants, coke by-product recovery plants, and petroleum refineries.

(b) The provisions of this subpart apply to owners and operators of hazardous waste treatment, storage, and disposal facilities that treat, store, or dispose of hazardous waste generated by any facility listed in paragraph (a) of this section. The waste streams at hazardous waste treatment, storage, and disposal facilities subject to the provisions of this subpart are the benzene-containing hazardous waste from any facility listed in paragraph (a) of this section. A hazardous waste treatment, storage, and disposal facility is a facility that must obtain a hazardous waste management permit under subtitle C of the Solid Waste Disposal Act.

(c) At each facility identified in paragraph (a) or (b) of this section, the following waste is exempt from the requirements of this subpart:

- (1) Waste in the form of gases or vapors that is emitted from process fluids:
- (2) Waste that is contained in a segregated stormwater sewer system.

(d) At each facility identified in paragraph (a) or (b) of this section, any gaseous stream from a waste management unit, treatment process, or wastewater treatment system routed to a fuel gas system, as defined in § 61.341, is exempt from this subpart. No testing, monitoring, recordkeeping, or reporting is required under this subpart for any gaseous stream from a waste management unit, treatment process, or wastewater treatment unit routed to a fuel gas system.

[55 FR 8346, Mar. 7, 1990, as amended at 55 FR 37231, Sept. 10, 1990; 58 FR 3095, Jan. 7, 1993; 67 FR 68531, Nov. 12, 2002]

§ 61.341 Definitions.

Benzene concentration means the fraction by weight of benzene in a waste as determined in accordance with the procedures specified in § 61.355 of this subpart.

Car-seal means a seal that is placed on a device that is used to change the position of a valve (e.g., from opened to closed) in such a way that the position of the valve cannot be changed without breaking the seal.

Chemical manufacturing plant means any facility engaged in the production of chemicals by chemical, thermal, physical, or biological processes for use as a product, co-product, by-product, or intermediate including but not limited to industrial organic chemicals, organic pesticide products, pharmaceutical preparations, paint and allied products, fertilizers, and agricultural chemicals. Examples of chemical manufacturing plants include facilities at which process units are operated to produce one or more of the following chemicals: benzenesulfonic acid, benzene, chlorobenzene, cumene, cyclohexane, ethylene, ethylbenzene, hydroquinone, linear alkylbenzene, nitrobenzene, resorcinol, sulfolane, or styrene.

Closed-vent system means a system that is not open to the atmosphere and is composed of piping, ductwork, connections, and, if necessary, flow inducing devices that transport gas or vapor from an emission source to a control device.

Coke by-product recovery plant means any facility designed and operated for the separation and recovery of coal tar derivatives (by-products) evolved from coal during the coking process of a coke oven battery.

Container means any portable waste management unit in which a material is stored, transported, treated, or otherwise handled. Examples of containers are drums, barrels, tank trucks, barges, dumpsters, tank cars, dump trucks, and ships.

Control device means an enclosed combustion device, vapor recovery system, or flare.

Cover means a device or system which is placed on or over a waste placed in a waste management unit so that the entire waste surface area is enclosed and sealed to minimize air emissions. A cover may have openings necessary for operation, inspection, and maintenance of the waste management unit such as access hatches, sampling ports, and gauge wells provided that each opening is closed and sealed when not in use. Example of covers include a fixed roof installed on a tank, a lid installed on a container, and an air-supported enclosure installed over a waste management unit.

External floating roof means a pontoon-type or double-deck type cover with certain rim sealing mechanisms that rests on the liquid surface in a waste management unit with no fixed roof.

Facility means all process units and product tanks that generate waste within a stationary source, and all waste management units that are used for waste treatment, storage, or disposal within a stationary source.

Fixed roof means a cover that is mounted on a waste management unit in a stationary manner and that does not move with fluctuations in liquid level.

Floating roof means a cover with certain rim sealing mechanisms consisting of a double deck, pontoon single deck, internal floating cover or covered floating roof, which rests upon and is supported by the liquid being contained, and is equipped with a closure seal or seals to close the space between the roof edge and unit wall.

Flow indicator means a device which indicates whether gas flow is present in a line or vent system.

Fuel gas system means the offsite and onsite piping and control system that gathers gaseous streams generated by facility operations, may blend them with sources of gas, if available, and transports the blended gaseous fuel at suitable pressures for use as fuel in heaters, furnaces, boilers, incinerators, gas turbines, and other combustion devices located within or outside the facility. The fuel is piped directly to each individual combustion device, and the system typically operates at pressures over atmospheric.

Individual drain system means the system used to convey waste from a process unit, product storage tank, or waste management unit to a waste management unit. The term includes all process drains and common junction boxes, together with their associated sewer lines and other junction boxes, down to the receiving waste management unit.

Internal floating roof means a cover that rests or floats on the liquid surface inside a waste management unit that has a fixed roof.

Liquid-mounted seal means a foam or liquid-filled primary seal mounted in contact with the liquid between the waste management unit wall and the floating roof continuously around the circumference.

Loading means the introduction of waste into a waste management unit but not necessarily to complete capacity (also referred to as filling).

Maximum organic vapor pressure means the equilibrium partial pressure exerted by the waste at the temperature equal to the highest calendar-month average of the waste storage temperature for waste stored above or below the ambient temperature or at the local maximum monthly average temperature as reported by the National Weather Service for waste stored at the ambient temperature, as determined:

- (1) In accordance with § 60.17(c); or
- (2) As obtained from standard reference texts; or
- (3) In accordance with § 60.17(a)(37); or
- (4) Any other method approved by the Administrator.

No detectable emissions means less than 500 parts per million by volume (ppmv) above background levels, as measured by a detection instrument reading in accordance with the procedures specified in § 61.355(h) of this subpart.

Oil-water separator means a waste management unit, generally a tank or surface impoundment, used to separate oil from water. An oil-water separator consists of not only the separation unit but also the forebay and other separator basins, skimmers, weirs, grit chambers, sludge hoppers, and bar screens that are located directly after the individual drain system and prior to additional treatment units such as an air flotation unit, clarifier, or biological treatment unit. Examples of an oil-water separator

include an API separator, parallel-plate interceptor, and corrugated-plate interceptor with the associated ancillary equipment.

Petroleum refinery means any facility engaged in producing gasoline, kerosene, distillate fuel oils, residual fuel oils, lubricants, or other products through the distillation of petroleum, or through the redistillation, cracking, or reforming of unfinished petroleum derivatives.

Petroleum means the crude oil removed from the earth and the oils derived from tar sands, shale, and coal.

Point of waste generation means the location where the waste stream exits the process unit component or storage tank prior to handling or treatment in an operation that is not an integral part of the production process, or in the case of waste management units that generate new wastes after treatment, the location where the waste stream exits the waste management unit component.

Process unit means equipment assembled and connected by pipes or ducts to produce intermediate or final products. A process unit can be operated independently if supplied with sufficient fuel or raw materials and sufficient product storage facilities.

Process unit turnaround means the shutting down of the operations of a process unit, the purging of the contents of the process unit, the maintenance or repair work, followed by restarting of the process.

Process unit turnaround waste means a waste that is generated as a result of a process unit turnaround.

Process wastewater means water which comes in contact with benzene during manufacturing or processing operations conducted within a process unit. Process wastewater is not organic wastes, process fluids, product tank drawdown, cooling tower blowdown, steam trap condensate, or landfill leachate.

Process wastewater stream means a waste stream that contains only process wastewater.

Product tank means a stationary unit that is designed to contain an accumulation of materials that are fed to or produced by a process unit, and is constructed primarily of non-earthen materials (e.g., wood, concrete, steel, plastic) which provide structural support.

Product tank drawdown means any material or mixture of materials discharged from a product tank for the purpose of removing water or other contaminants from the product tank.

Safety device means a closure device such as a pressure relief valve, frangible disc, fusible plug, or any other type of device which functions exclusively to prevent physical damage or permanent deformation to a unit or its air emission control equipment by venting gases or vapors directly to the atmosphere during unsafe conditions resulting from an unplanned, accidental, or emergency event. For the purpose of this subpart, a safety device is not used for routine venting of gases or vapors from the vapor headspace underneath a cover such as during filling of the unit or to adjust the pressure in this vapor headspace in response to normal daily diurnal ambient temperature fluctuations. A safety device is designed to remain in a closed position during normal operations and open only when the internal pressure, or another relevant parameter, exceeds the device threshold setting applicable to the air emission control equipment as determined by the owner or operator based on manufacturer recommendations, applicable regulations, fire protection and prevention codes, standard engineering codes and practices, or other requirements for the safe handling of flammable, ignitable, explosive, reactive, or hazardous materials.

Segregated stormwater sewer system means a drain and collection system designed and operated for the sole purpose of collecting rainfall runoff at a facility, and which is segregated from all other individual drain systems.

Sewer line means a lateral, trunk line, branch line, or other enclosed conduit used to convey waste to a downstream waste management unit.

Slop oil means the floating oil and solids that accumulate on the surface of an oil-water separator.

Sour water stream means a stream that:

- (1) Contains ammonia or sulfur compounds (usually hydrogen sulfide) at concentrations of 10 ppm by weight or more;
- (2) Is generated from separation of water from a feed stock, intermediate, or product that contained ammonia or sulfur compounds; and
- (3) Requires treatment to remove the ammonia or sulfur compounds.

Sour water stripper means a unit that:

- (1) Is designed and operated to remove ammonia or sulfur compounds (usually hydrogen sulfide) from sour water streams;
- (2) Has the sour water streams transferred to the stripper through hard piping or other enclosed system; and
- (3) Is operated in such a manner that the offgases are sent to a sulfur recovery unit, processing unit, incinerator, flare, or other combustion device.

Surface impoundment means a waste management unit which is a natural topographic depression, man-made excavation, or diked area formed primarily of earthen materials (although it may be lined with man-made materials), which is designed to hold an accumulation of liquid wastes or waste containing free liquids, and which is not an injection well. Examples of surface impoundments are holding, storage, settling, and aeration pits, ponds, and lagoons.

Tank means a stationary waste management unit that is designed to contain an accumulation of waste and is constructed primarily of nonearthen materials (e.g., wood, concrete, steel, plastic) which provide structural support.

Treatment process means a stream stripping unit, thin-film evaporation unit, waste incinerator, or any other process used to comply with § 61.348 of this subpart.

Vapor-mounted seal means a foam-filled primary seal mounted continuously around the perimeter of a waste management unit so there is an annular vapor space underneath the seal. The annular vapor space is bounded by the bottom of the primary seal, the unit wall, the liquid surface, and the floating roof.

Waste means any material resulting from industrial, commercial, mining or agricultural operations, or from community activities that is discarded or is being accumulated, stored, or physically, chemically, thermally, or biologically treated prior to being discarded, recycled, or discharged.

Waste management unit means a piece of equipment, structure, or transport mechanism used in handling, storage, treatment, or disposal of waste. Examples of a waste management unit include a tank, surface impoundment, container, oil-water separator, individual drain system, steam stripping unit, thin-film evaporation unit, waste incinerator, and landfill.

Waste stream means the waste generated by a particular process unit, product tank, or waste management unit. The characteristics of the waste stream (e.g., flow rate, benzene concentration, water content) are determined at the point of waste generation. Examples of a waste stream include process wastewater, product tank drawdown, sludge and slop oil removed from waste management units, and landfill leachate.

Wastewater treatment system means any component, piece of equipment, or installation that receives, manages, or treats process wastewater, product tank drawdown, or landfill leachate prior to direct or indirect discharge in accordance with the National Pollutant Discharge Elimination System permit regulations under 40 CFR part 122. These systems typically include individual drain systems, oil-water separators, air flotation units, equalization tanks, and biological treatment units.

Water seal controls means a seal pot, p-leg trap, or other type of trap filled with water (e.g., flooded sewers that maintain water levels adequate to prevent air flow through the system) that creates a water barrier between the sewer line and the atmosphere. The water level of the seal must be maintained in the vertical leg of a drain in order to be considered a water seal.

[55 FR 8346, Mar. 7, 1990; 55 FR 12444, Apr. 3, 1990, as amended at 58 FR 3095, Jan. 7, 1993; 67 FR 68531, Nov. 12, 2002]

§ 61.342 Standards: General.

(a) An owner or operator of a facility at which the total annual benzene quantity from facility waste is less than 10 megagrams per year (Mg/yr) (11 ton/yr) shall be exempt from the requirements of paragraphs (b) and (c) of this section. The total annual benzene quantity from facility waste is the sum of the annual benzene quantity for each waste stream at the facility that has a flow-weighted annual average water content greater than 10 percent or that is mixed with water, or other wastes, at any time and the mixture has an annual average water content greater than 10 percent. The benzene quantity in a waste stream is to be counted only once without multiple counting if other waste streams are mixed with or generated from the original waste stream. Other specific requirements for calculating the total annual benzene waste quantity are as follows:

(1) Wastes that are exempted from control under §§ 61.342(c)(2) and 61.342(c)(3) are included in the calculation of the total annual benzene quantity if they have an annual average water content greater than 10 percent, or if they are mixed with water or other wastes at any time and the mixture has an annual average water content greater than 10 percent.

(2) The benzene in a material subject to this subpart that is sold is included in the calculation of the total annual benzene quantity if the material has an annual average water content greater than 10 percent.

(3) Benzene in wastes generated by remediation activities conducted at the facility, such as the excavation of contaminated soil, pumping and treatment of groundwater, and the recovery of product from soil or groundwater, are not included in the calculation of total annual benzene quantity for that facility. If the facility's total annual benzene quantity is 10 Mg/yr (11 ton/yr) or more, wastes generated by remediation activities are subject to the requirements of paragraphs (c) through (h) of this section. If the facility is managing remediation waste generated offsite, the benzene in this waste shall be included in the calculation of total annual benzene quantity in facility waste, if the waste streams have an annual average water content greater than 10 percent, or if they are mixed with water or other wastes at any time and the mixture has an annual average water content greater than 10 percent.

(4) The total annual benzene quantity is determined based upon the quantity of benzene in the waste before any waste treatment occurs to remove the benzene except as specified in § 61.355(c)(1) (i) (A) through (C).

(b) Each owner or operator of a facility at which the total annual benzene quantity from facility waste is equal to or greater than 10 Mg/yr (11 ton/yr) as determined in paragraph (a) of this section shall be in compliance with the requirements of paragraphs (c) through (h) of this section no later than 90 days following the effective date, unless a waiver of compliance has been obtained under § 61.11, or by the initial startup for a new source with an initial startup after the effective date.

(1) The owner or operator of an existing source unable to comply with the rule within the required time may request a waiver of compliance under § 61.10.

(2) As part of the waiver application, the owner or operator shall submit to the Administrator a plan under § 61.10(b)(3) that is an enforceable commitment to obtain environmental benefits to mitigate the benzene emissions that result from extending the compliance date. The plan shall include the following information:

(i) A description of the method of compliance, including the control approach, schedule for installing controls, and quantity of the benzene emissions that result from extending the compliance date;

(ii) If the control approach involves a compliance strategy designed to obtain integrated compliance with multiple regulatory requirements, a description of the other regulations involved and their effective dates; and

(iii) A description of the actions to be taken at the facility to obtain mitigating environmental benefits, including how the benefits will be obtained, the schedule for these actions, and an estimate of the quantifiable benefits that directly result from these actions.

(c) Each owner or operator of a facility at which the total annual benzene quantity from facility waste is equal to or greater than 10 Mg/yr (11 ton/yr) as determined in paragraph (a) of this section shall manage and treat the facility waste as follows:

(1) For each waste stream that contains benzene, including (but not limited to) organic waste streams that contain less than 10 percent water and aqueous waste streams, even if the wastes are not discharged to an individual drain system, the owner or operator shall:

(i) Remove or destroy the benzene contained in the waste using a treatment process or wastewater treatment system that complies with the standards specified in § 61.348 of this subpart.

(ii) Comply with the standards specified in §§ 61.343 through 61.347 of this subpart for each waste management unit that receives or manages the waste stream prior to and during treatment of the waste stream in accordance with paragraph (c)(1)(i) of this section.

(iii) Each waste management unit used to manage or treat waste streams that will be recycled to a process shall comply with the standards specified in §§ 61.343 through 61.347. Once the waste stream is recycled to a process, including to a tank used for the storage of production process feed, product, or product intermediates, unless this tank is used primarily for the storage of wastes, the material is no longer subject to paragraph (c) of this section.

(2) A waste stream is exempt from paragraph (c)(1) of this section provided that the owner or operator demonstrates initially and, thereafter, at least once per year that the flow-weighted annual average benzene concentration for the waste stream is less than 10 ppmw as determined by the procedures specified in § 61.355(c)(2) or § 61.355(c)(3).

(3) A waste stream is exempt from paragraph (c)(1) of this section provided that the owner or operator demonstrates initially and, thereafter, at least once per year that the conditions specified in either paragraph (c)(3)(i) or (c)(3)(ii) of this section are met.

(i) The waste stream is process wastewater that has a flow rate less than 0.02 liters per minute (0.005 gallons per minute) or an annual wastewater quantity of less than 10 Mg/yr (11 ton/yr); or

(ii) All of the following conditions are met:

(A) The owner or operator does not choose to exempt process wastewater under paragraph (c)(3)(i) of this section,

(B) The total annual benzene quantity in all waste streams chosen for exemption in paragraph (c)(3)(ii) of this section does not exceed 2.0 Mg/yr (2.2 ton/yr) as determined in the procedures in § 61.355(j), and

(C) The total annual benzene quantity in a waste stream chosen for exemption, including process unit turnaround waste, is determined for the year in which the waste is generated.

(d) As an alternative to the requirements specified in paragraphs (c) and (e) of this section, an owner or operator of a facility at which the total annual benzene quantity from facility waste is equal to or greater than 10 Mg/yr (11 ton/yr) as determined in paragraph (a) of this section may elect to manage and treat the facility waste as follows:

(1) The owner or operator shall manage and treat facility waste other than process wastewater in accordance with the requirements of paragraph (c)(1) of this section.

(2) The owner or operator shall manage and treat process wastewater in accordance with the following requirements:

(i) Process wastewater shall be treated to achieve a total annual benzene quantity from facility process wastewater less than 1 Mg/yr (1.1 ton/yr). Total annual benzene from facility process wastewater shall be determined by adding together the annual benzene quantity at the point of waste generation for each untreated process wastewater stream plus the annual benzene quantity exiting the treatment process for each process wastewater stream treated in accordance with the requirements of paragraph (c)(1)(i) of this section.

(ii) Each treated process wastewater stream identified in paragraph (d)(2)(i) of this section shall be managed and treated in accordance with paragraph (c)(1) of this section.

(iii) Each untreated process wastewater stream identified in paragraph (d)(2)(i) of this section is exempt from the requirements of paragraph (c)(1) of this section.

(e) As an alternative to the requirements specified in paragraphs (c) and (d) of this section, an owner or operator of a facility at which the total annual benzene quantity from facility waste is equal to or greater than 10 Mg/yr (11 ton/yr) as determined in paragraph (a) of this section may elect to manage and treat the facility waste as follows:

(1) The owner or operator shall manage and treat facility waste with a flow-weighted annual average water content of less than 10 percent in accordance with the requirements of paragraph (c)(1) of this section; and

(2) The owner or operator shall manage and treat facility waste (including remediation and process unit turnaround waste) with a flow-weighted annual average water content of 10 percent or greater, on a volume basis as total water, and each waste stream that is mixed with water or wastes at any time such that the resulting mixture has an annual water content greater than 10 percent, in accordance with the following:

(i) The benzene quantity for the wastes described in paragraph (e)(2) of this section must be equal to or less than 6.0 Mg/yr (6.6 ton/yr), as determined in § 61.355(k). Wastes as described in paragraph (e)(2) of this section that are transferred offsite shall be included in the determination of benzene quantity as provided in § 61.355(k). The provisions of paragraph (f) of this section shall not apply to any owner or operator who elects to comply with the provisions of paragraph (e) of this section.

(ii) The determination of benzene quantity for each waste stream defined in paragraph (e)(2) of this section shall be made in accordance with § 61.355(k).

(f) Rather than treating the waste onsite, an owner or operator may elect to comply with paragraph (c)(1)(i) of this section by transferring the waste offsite to another facility where the waste is treated in accordance with the requirements of paragraph (c)(1)(i) of this section. The owner or operator transferring the waste shall:

(1) Comply with the standards specified in §§ 61.343 through 61.347 of this subpart for each waste management unit that receives or manages the waste prior to shipment of the waste offsite.

(2) Include with each offsite waste shipment a notice stating that the waste contains benzene which is required to be managed and treated in accordance with the provisions of this subpart.

(g) Compliance with this subpart will be determined by review of facility records and results from tests and inspections using methods and procedures specified in § 61.355 of this subpart.

(h) Permission to use an alternative means of compliance to meet the requirements of §§ 61.342 through 61.352 of this subpart may be granted by the Administrator as provided in § 61.353 of this subpart.

[55 FR 8346, Mar. 7, 1990, as amended at 58 FR 3095, Jan. 7, 1993; 65 FR 62159, 62160, Oct. 17, 2000]

§ 61.343 Standards: Tanks.

(a) Except as provided in paragraph (b) of this section and in § 61.351, the owner or operator must meet the standards in paragraph (a)(1) or (2) of this section for each tank in which the waste stream is placed in accordance with § 61.342 (c)(1)(ii). The standards in this section apply to the treatment and storage of the waste stream in a tank, including dewatering.

(1) The owner or operator shall install, operate, and maintain a fixed-roof and closed-vent system that routes all organic vapors vented from the tank to a control device.

(i) The fixed-roof shall meet the following requirements:

(A) The cover and all openings (e.g., access hatches, sampling ports, and gauge wells) shall be designed to operate with no detectable emissions as indicated by an instrument reading of less than 500 ppmv above background, as determined initially and thereafter at least once per year by the methods specified in § 61.355(h) of this subpart.

(B) Each opening shall be maintained in a closed, sealed position (e.g., covered by a lid that is gasketed and latched) at all times that waste is in the tank except when it is necessary to use the opening for waste sampling or removal, or for equipment inspection, maintenance, or repair.

(C) If the cover and closed-vent system operate such that the tank is maintained at a pressure less than atmospheric pressure, then paragraph (a)(1)(i)(B) of this section does not apply to any opening that meets all of the following conditions:

(1) The purpose of the opening is to provide dilution air to reduce the explosion hazard;

(2) The opening is designed to operate with no detectable emissions as indicated by an instrument reading of less than 500 ppmv above background, as determined initially and thereafter at least once per year by the methods specified in § 61.355(h); and

(3) The pressure is monitored continuously to ensure that the pressure in the tank remains below atmospheric pressure.

(ii) The closed-vent system and control device shall be designed and operated in accordance with the requirements of § 61.349 of this subpart.

(2) The owner or operator must install, operate, and maintain an enclosure and closed-vent system that routes all organic vapors vented from the tank, located inside the enclosure, to a control device in accordance with the requirements specified in paragraph (e) of this section.

(b) For a tank that meets all the conditions specified in paragraph (b)(1) of this section, the owner or operator may elect to comply with paragraph (b)(2) of this section as an alternative to the requirements specified in paragraph (a)(1) of this section.

(1) The waste managed in the tank complying with paragraph (b)(2) of this section shall meet all of the following conditions:

(i) Each waste stream managed in the tank must have a flow-weighted annual average water content less than or equal to 10 percent water, on a volume basis as total water.

(ii) The waste managed in the tank either:

(A) Has a maximum organic vapor pressure less than 5.2 kilopascals (kPa) (0.75 pounds per square inch (psi));

(B) Has a maximum organic vapor pressure less than 27.6 kPa (4.0 psi) and is managed in a tank having design capacity less than 151 m³ (40,000 gal); or

(C) Has a maximum organic vapor pressure less than 76.6 kPa (11.1 psi) and is managed in a tank having a design capacity less than 75 m³ (20,000 gal).

(2) The owner or operator shall install, operate, and maintain a fixed roof as specified in paragraph (a)(1)(i).

(3) For each tank complying with paragraph (b) of this section, one or more devices which vent directly to the atmosphere may be used on the tank provided each device remains in a closed, sealed position during normal operations except when the device needs to open to prevent physical damage or permanent deformation of the tank or cover resulting from filling or emptying the tank, diurnal temperature changes, atmospheric pressure changes or malfunction of the unit in accordance with good engineering and safety practices for handling flammable, explosive, or other hazardous materials.

(c) Each fixed-roof, seal, access door, and all other openings shall be checked by visual inspection initially and quarterly thereafter to ensure that no cracks or gaps occur and that access doors and other openings are closed and gasketed properly.

(d) Except as provided in § 61.350 of this subpart, when a broken seal or gasket or other problem is identified, or when detectable emissions are measured, first efforts at repair shall be made as soon as practicable, but not later than 45 calendar days after identification.

(e) Each owner or operator who controls air pollutant emissions by using an enclosure vented through a closed-vent system to a control device must meet the requirements specified in paragraphs (e)(1) through (4) of this section.

(1) The tank must be located inside a total enclosure. The enclosure must be designed and operated in accordance with the criteria for a permanent total enclosure as specified in "Procedure T—Criteria for and Verification of a Permanent or Temporary Total Enclosure" in 40 CFR 52.741, appendix B. The enclosure may have permanent or temporary openings to allow worker access; passage of material into or out of the enclosure by conveyor, vehicles, or other mechanical means; entry of permanent mechanical or electrical equipment; or direct airflow into the enclosure. The owner or operator must perform the verification procedure for the enclosure as specified in section 5.0 of Procedure T initially when the enclosure is first installed and, thereafter, annually. A facility that has conducted an initial compliance demonstration and that performs annual compliance demonstrations in accordance with the requirements for Tank Level 2 control requirements 40 CFR 264.1084(i) or 40 CFR 265(i) is not required to make repeat demonstrations of initial and continuous compliance for the purposes of this subpart.

(2) The enclosure must be vented through a closed-vent system to a control device that is designed and operated in accordance with the standards for control devices specified in § 61.349.

(3) Safety devices, as defined in this subpart, may be installed and operated as necessary on any enclosure, closed-vent system, or control device used to comply with the requirements of paragraphs (e)(1) and (2) of this section.

(4) The closed-vent system must be designed and operated in accordance with the requirements of § 61.349.

[55 FR 8346, Mar. 7, 1990, as amended at 55 FR 18331, May 2, 1990; 58 FR 3096, Jan. 7, 1993; 67 FR 68532, Nov. 12, 2002; 68 FR 6082, Feb. 6, 2003; 68 FR 67935, Dec. 4, 2003]

§ 61.344 Standards: Surface impoundments.

(a) The owner or operator shall meet the following standards for each surface impoundment in which waste is placed in accordance with § 61.342(c)(1)(ii) of this subpart:

(1) The owner or operator shall install, operate, and maintain on each surface impoundment a cover (e.g., air-supported structure or rigid cover) and closed-vent system that routes all organic vapors vented from the surface impoundment to a control device.

(i) The cover shall meet the following requirements:

(A) The cover and all openings (e.g., access hatches, sampling ports, and gauge wells) shall be designed to operate with no detectable emissions as indicated by an instrument reading of less than 500 ppmv above background, initially and thereafter at least once per year by the methods specified in § 61.355(h) of this subpart.

(B) Each opening shall be maintained in a closed, sealed position (e.g., covered by a lid that is gasketed and latched) at all times that waste is in the surface impoundment except when it is necessary to use the opening for waste sampling or removal, or for equipment inspection, maintenance, or repair.

(C) If the cover and closed-vent system operate such that the enclosure of the surface impoundment is maintained at a pressure less than atmospheric pressure, then paragraph (a)(1)(i)(B) of this section does not apply to any opening that meets all of the following conditions:

(1) The purpose of the opening is to provide dilution air to reduce the explosion hazard;

(2) The opening is designed to operate with no detectable emissions as indicated by an instrument reading of less than 500 ppmv above background, as determined initially and thereafter at least once per year by the methods specified in § 61.355(h) of this subpart; and

(3) The pressure is monitored continuously to ensure that the pressure in the enclosure of the surface impoundment remains below atmospheric pressure.

(D) The cover shall be used at all times that waste is placed in the surface impoundment except during removal of treatment residuals in accordance with 40 CFR 268.4 or closure of the surface impoundment in accordance with 40 CFR 264.228. (Note: the treatment residuals generated by these activities may be subject to the requirements of this part.)

(ii) The closed-vent system and control device shall be designed and operated in accordance with § 61.349 of this subpart.

(b) Each cover seal, access hatch, and all other openings shall be checked by visual inspection initially and quarterly thereafter to ensure that no cracks or gaps occur and that access hatches and other openings are closed and gasketed properly.

(c) Except as provided in § 61.350 of this subpart, when a broken seal or gasket or other problem is identified, or when detectable emissions are measured, first efforts at repair shall be made as soon as practicable, but not later than 15 calendar days after identification.

[55 FR 8346, Mar. 7, 1990, as amended at 58 FR 3097, Jan. 7, 1993]

§ 61.345 Standards: Containers.

(a) The owner or operator shall meet the following standards for each container in which waste is placed in accordance with § 61.342(c)(1)(ii) of this subpart:

(1) The owner or operator shall install, operate, and maintain a cover on each container used to handle, transfer, or store waste in accordance with the following requirements:

(i) The cover and all openings (e.g., bungs, hatches, and sampling ports) shall be designed to operate with no detectable emissions as indicated by an instrument reading of less than 500 ppmv above background, initially and thereafter at least once per year by the methods specified in § 61.355 (h) of this subpart.

(ii) Except as provided in paragraph (a)(4) of this section, each opening shall be maintained in a closed, sealed position (e.g., covered by a lid that is gasketed and latched) at all times that waste is in the container except when it is necessary to use the opening for waste loading, removal, inspection, or sampling.

(2) When a waste is transferred into a container by pumping, the owner or operator shall perform the transfer using a submerged fill pipe. The submerged fill pipe outlet shall extend to within two fill pipe diameters of the bottom of the container while the container is being loaded. During loading of the waste, the cover shall remain in place and all openings shall be maintained in a closed, sealed position except for those openings required for the submerged fill pipe, those openings required for venting of the container to prevent physical damage or permanent deformation of the container or cover, and any openings complying with paragraph (a)(4) of this section.

(3) Treatment of a waste in a container, including aeration, thermal or other treatment, must be performed by the owner or operator in a manner such that while the waste is being treated the container meets the standards specified in paragraphs (a)(3)(i) through (iii) of this section, except for covers and closed-vent systems that meet the requirements in paragraph (a)(4) of this section.

(i) The owner or operator must either:

(A) Vent the container inside a total enclosure which is exhausted through a closed-vent system to a control device in accordance with the requirements of paragraphs (a)(3)(ii)(A) and (B) of this section; or

(B) Vent the covered or closed container directly through a closed-vent system to a control device in accordance with the requirements of paragraphs (a)(3)(ii)(B) and (C) of this section.

(ii) The owner or operator must meet the following requirements, as applicable to the type of air emission control equipment selected by the owner or operator:

(A) The total enclosure must be designed and operated in accordance with the criteria for a permanent total enclosure as specified in section 5 of the "Procedure T—Criteria for and Verification of a Permanent or Temporary Total Enclosure" in 40 CFR 52.741, appendix B. The enclosure may have permanent or temporary openings to allow worker access; passage of containers through the enclosure by conveyor or other mechanical means; entry of permanent mechanical or electrical equipment; or direct airflow into the enclosure. The owner or operator must perform the verification procedure for the enclosure as specified in section 5.0 of "Procedure T—Criteria for and Verification of a Permanent or Temporary Total Enclosure" initially when the enclosure is first installed and, thereafter, annually. A facility that has conducted an initial compliance demonstration and that performs annual compliance demonstrations in accordance with the Container Level 3 control requirements in 40 CFR 264.1086(e)(2)(i) or 40 CFR 265.1086(e)(2)(i) is not required to make repeat demonstrations of initial and continuous compliance for the purposes of this subpart.

(B) The closed-vent system and control device must be designed and operated in accordance with the requirements of § 61.349.

(C) For a container cover, the cover and all openings (e.g., doors, hatches) must be designed to operate with no detectable emissions as indicated by an instrument reading of less than 500 ppmv above background, initially and thereafter at least once per year by the methods specified in § 61.355 (h).

(iii) Safety devices, as defined in this subpart, may be installed and operated as necessary on any container, enclosure, closed-vent system, or control device used to comply with the requirements of paragraph (a)(3)(i) of this section.

(4) If the cover and closed-vent system operate such that the container is maintained at a pressure less than atmospheric pressure, the owner or operator may operate the system with an opening that is not sealed and kept closed at all times if the following conditions are met:

(i) The purpose of the opening is to provide dilution air to reduce the explosion hazard;

(ii) The opening is designed to operate with no detectable emissions as indicated by an instrument reading of less than 500 ppmv above background, as determined initially and thereafter at least once per year by methods specified in § 61.355(h); and

(iii) The pressure is monitored continuously to ensure that the pressure in the container remains below atmospheric pressure.

(b) Each cover and all openings shall be visually inspected initially and quarterly thereafter to ensure that they are closed and gasketed properly.

(c) Except as provided in § 61.350 of this subpart, when a broken seal or gasket or other problem is identified, first efforts at repair shall be made as soon as practicable, but not later than 15 calendar days after identification.

[55 FR 8346, Mar. 7, 1990, as amended at 58 FR 3097, Jan. 7, 1993; 67 FR 68532, Nov. 12, 2002; 68 FR 67936, Dec. 4, 2003]

§ 61.346 Standards: Individual drain systems.

(a) Except as provided in paragraph (b) of this section, the owner or operator shall meet the following standards for each individual drain system in which waste is placed in accordance with § 61.342(c)(1)(ii) of this subpart:

(1) The owner or operator shall install, operate, and maintain on each drain system opening a cover and closed-vent system that routes all organic vapors vented from the drain system to a control device.

(i) The cover shall meet the following requirements:

(A) The cover and all openings (e.g., access hatches, sampling ports) shall be designed to operate with no detectable emissions as indicated by an instrument reading of less than 500 ppmv above background, initially and thereafter at least once per year by the methods specified in § 61.355(h) of this subpart.

(B) Each opening shall be maintained in a closed, sealed position (e.g., covered by a lid that is gasketed and latched) at all times that waste is in the drain system except when it is necessary to use the opening for waste sampling or removal, or for equipment inspection, maintenance, or repair.

(C) If the cover and closed-vent system operate such that the individual drain system is maintained at a pressure less than atmospheric pressure, then paragraph (a)(1)(i)(B) of this section does not apply to any opening that meets all of the following conditions:

(1) The purpose of the opening is to provide dilution air to reduce the explosion hazard;

(2) The opening is designed to operate with no detectable emissions as indicated by an instrument reading of less than 500 ppmv above background, as determined initially and thereafter at least once per year by the methods specified in § 61.355(h); and

(3) The pressure is monitored continuously to ensure that the pressure in the individual drain system remains below atmospheric pressure.

(ii) The closed-vent system and control device shall be designed and operated in accordance with § 61.349 of this subpart.

(2) Each cover seal, access hatch, and all other openings shall be checked by visual inspection initially and quarterly thereafter to ensure that no cracks or gaps occur and that access hatches and other openings are closed and gasketed properly.

(3) Except as provided in § 61.350 of this subpart, when a broken seal or gasket or other problem is identified, or when detectable emissions are measured, first efforts at repair shall be made as soon as practicable, but not later than 15 calendar days after identification.

(b) As an alternative to complying with paragraph (a) of this section, an owner or operator may elect to comply with the following requirements:

(1) Each drain shall be equipped with water seal controls or a tightly sealed cap or plug.

(2) Each junction box shall be equipped with a cover and may have a vent pipe. The vent pipe shall be at least 90 cm (3 ft) in length and shall not exceed 10.2 cm (4 in) in diameter.

(i) Junction box covers shall have a tight seal around the edge and shall be kept in place at all times, except during inspection and maintenance.

(ii) One of the following methods shall be used to control emissions from the junction box vent pipe to the atmosphere:

(A) Equip the junction box with a system to prevent the flow of organic vapors from the junction box vent pipe to the atmosphere during normal operation. An example of such a system includes use of water seal controls on the junction box. A flow indicator shall be installed, operated, and maintained on each junction box vent pipe to ensure that organic vapors are not vented from the junction box to the atmosphere during normal operation.

(B) Connect the junction box vent pipe to a closed-vent system and control device in accordance with § 61.349 of this subpart.

(3) Each sewer line shall not be open to the atmosphere and shall be covered or enclosed in a manner so as to have no visual gaps or cracks in joints, seals, or other emission interfaces.

(4) Equipment installed in accordance with paragraphs (b)(1), (b)(2), or (b)(3) of this section shall be inspected as follows:

(i) Each drain using water seal controls shall be checked by visual or physical inspection initially and thereafter quarterly for indications of low water levels or other conditions that would reduce the effectiveness of water seal controls.

(ii) Each drain using a tightly sealed cap or plug shall be visually inspected initially and thereafter quarterly to ensure caps or plugs are in place and properly installed.

(iii) Each junction box shall be visually inspected initially and thereafter quarterly to ensure that the cover is in place and to ensure that the cover has a tight seal around the edge.

(iv) The unburied portion of each sewer line shall be visually inspected initially and thereafter quarterly for indication of cracks, gaps, or other problems that could result in benzene emissions.

(5) Except as provided in § 61.350 of this subpart, when a broken seal, gap, crack or other problem is identified, first efforts at repair shall be made as soon as practicable, but not later than 15 calendar days after identification.

[55 FR 8346, Mar. 7, 1990, as amended at 55 FR 37231, Sept. 10, 1990; 58 FR 3097, Jan. 7, 1993]

§ 61.347 Standards: Oil-water separators.

(a) Except as provided in § 61.352 of this subpart, the owner or operator shall meet the following standards for each oil-water separator in which waste is placed in accordance with § 61.342(c)(1)(ii) of this subpart:

(1) The owner or operator shall install, operate, and maintain a fixed-roof and closed-vent system that routes all organic vapors vented from the oil-water separator to a control device.

(i) The fixed-roof shall meet the following requirements:

(A) The cover and all openings (e.g., access hatches, sampling ports, and gauge wells) shall be designed to operate with no detectable emissions as indicated by an instrument reading of less than 500 ppmv above background, as determined initially and thereafter at least once per year by the methods specified in § 61.355(h) of this subpart.

(B) Each opening shall be maintained in a closed, sealed position (e.g., covered by a lid that is gasketed and latched) at all times that waste is in the oil-water separator except when it is necessary to use the opening for waste sampling or removal, or for equipment inspection, maintenance, or repair.

(C) If the cover and closed-vent system operate such that the oil-water separator is maintained at a pressure less than atmospheric pressure, then paragraph (a)(1)(i)(B) of this section does not apply to any opening that meets all of the following conditions:

(1) The purpose of the opening is to provide dilution air to reduce the explosion hazard;

(2) The opening is designed to operate with no detectable emissions as indicated by an instrument reading of less than 500 ppmv above background, as determined initially and thereafter at least once per year by the methods specified in § 61.355(h); and

(3) The pressure is monitored continuously to ensure that the pressure in the oil-water separator remains below atmospheric pressure.

(ii) The closed-vent system and control device shall be designed and operated in accordance with the requirements of § 61.349 of this subpart.

(b) Each cover seal, access hatch, and all other openings shall be checked by visual inspection initially and quarterly thereafter to ensure that no cracks or gaps occur between the cover and oil-water separator wall and that access hatches and other openings are closed and gasketed properly.

(c) Except as provided in § 61.350 of this subpart, when a broken seal or gasket or other problem is identified, or when detectable emissions are measured, first efforts at repair shall be made as soon as practicable, but not later than 15 calendar days after identification.

[55 FR 8346, Mar. 7, 1990, as amended at 58 FR 3098, Jan. 7, 1993]

§ 61.348 Standards: Treatment processes.

(a) Except as provided in paragraph (a)(5) of this section, the owner or operator shall treat the waste stream in accordance with the following requirements:

(1) The owner or operator shall design, install, operate, and maintain a treatment process that either:

(i) Removes benzene from the waste stream to a level less than 10 parts per million by weight (ppmw) on a flow-weighted annual average basis,

(ii) Removes benzene from the waste stream by 99 percent or more on a mass basis, or

(iii) Destroys benzene in the waste stream by incinerating the waste in a combustion unit that achieves a destruction efficiency of 99 percent or greater for benzene.

(2) Each treatment process complying with paragraphs (a)(1)(i) or (a)(1)(ii) of this section shall be designed and operated in accordance with the appropriate waste management unit standards specified in §§ 61.343 through 61.347 of this subpart. For example, if a treatment process is a tank, then the owner or operator shall comply with § 61.343 of this subpart.

(3) For the purpose of complying with the requirements specified in paragraph (a)(1)(i) of this section, the intentional or unintentional reduction in the benzene concentration of a waste stream by dilution of the waste stream with other wastes or materials is not allowed.

(4) An owner or operator may aggregate or mix together individual waste streams to create a combined waste stream for the purpose of facilitating treatment of waste to comply with the requirements of paragraph (a)(1) of this section except as provided in paragraph (a)(5) of this section.

(5) If an owner or operator aggregates or mixes any combination of process wastewater, product tank drawdown, or landfill leachate subject to § 61.342(c)(1) of this subpart together with other waste streams to create a combined waste stream for the purpose of facilitating management or treatment of waste in a wastewater treatment system, then the wastewater treatment system shall be operated in accordance with paragraph (b) of this section. These provisions apply to above-ground wastewater treatment systems as well as those that are at or below ground level.

(b) Except for facilities complying with § 61.342(e), the owner or operator that aggregates or mixes individual waste streams as defined in paragraph (a)(5) of this section for management and treatment in a wastewater treatment system shall comply with the following requirements:

(1) The owner or operator shall design and operate each waste management unit that comprises the wastewater treatment system in accordance with the appropriate standards specified in §§ 61.343 through 61.347 of this subpart.

(2) The provisions of paragraph (b)(1) of this section do not apply to any waste management unit that the owner or operator demonstrates to meet the following conditions initially and, thereafter, at least once per year:

(i) The benzene content of each waste stream entering the waste management unit is less than 10 ppmw on a flow-weighted annual average basis as determined by the procedures specified in § 61.355(c) of this subpart; and

(ii) The total annual benzene quantity contained in all waste streams managed or treated in exempt waste management units comprising the facility wastewater treatment systems is less than 1 Mg/yr (1.1 ton/yr). For this determination, total annual benzene quantity shall be calculated as follows:

(A) The total annual benzene quantity shall be calculated as the sum of the individual benzene quantities determined at each location where a waste stream first enters an exempt waste management unit. The benzene quantity discharged from an exempt waste management unit shall not be included in this calculation.

(B) The annual benzene quantity in a waste stream managed or treated in an enhanced biodegradation unit shall not be included in the calculation of the total annual benzene quantity, if the enhanced biodegradation unit is the first exempt unit in which the waste is managed or treated. A unit shall be considered enhanced biodegradation if it is a suspended-growth process that generates biomass, uses recycled biomass, and periodically removes biomass from the process. An enhanced biodegradation unit typically operates at a food-to-microorganism ratio in the range of 0.05 to 1.0 kg of biological oxygen demand per kg of biomass per day, a mixed liquor suspended solids ratio in the range of 1 to 8 grams per liter (0.008 to 0.7 pounds per liter), and a residence time in the range of 3 to 36 hours.

(c) The owner and operator shall demonstrate that each treatment process or wastewater treatment system unit, except as provided in paragraph (d) of this section, achieves the appropriate conditions specified in paragraphs (a) or (b) of this section in accordance with the following requirements:

(1) Engineering calculations in accordance with requirements specified in § 61.356(e) of this subpart; or

(2) Performance tests conducted using the test methods and procedures that meet the requirements specified in § 61.355 of this subpart.

(d) A treatment process or waste stream is in compliance with the requirements of this subpart and exempt from the requirements of paragraph (c) of this section provided that the owner or operator documents that the treatment process or waste stream is in compliance with other regulatory requirements as follows:

(1) The treatment process is a hazardous waste incinerator for which the owner or operator has been issued a final permit under 40 CFR part 270 and complies with the requirements of 40 CFR part 264, subpart O;

(2) The treatment process is an industrial furnace or boiler burning hazardous waste for energy recovery for which the owner or operator has been issued a final permit under 40 CFR part 270 and complies with the requirements of 40 CFR part 266, subpart D;

(3) The waste stream is treated by a means or to a level that meets benzene-specific treatment standards in accordance with the Land Disposal Restrictions under 40 CFR part 268, and the treatment process is designed and operated with a closed-vent system and control device meeting the requirements of § 61.349 of this subpart;

(4) The waste stream is treated by a means or to a level that meets benzene-specific effluent limitations or performance standards in accordance with the Effluent Guidelines and Standards under 40 CFR parts 401-464, and the treatment process is designed and operated with a closed-vent system and control device meeting the requirements of § 61.349 of this subpart; or

(5) The waste stream is discharged to an underground injection well for which the owner or operator has been issued a final permit under 40 CFR part 270 and complies with the requirements of 40 CFR part 122.

(e) Except as specified in paragraph (e)(3) of this section, if the treatment process or wastewater treatment system unit has any openings (e.g., access doors, hatches, etc.), all such openings shall be sealed (e.g., gasketed, latched, etc.) and kept closed at all times when waste is being treated, except during inspection and maintenance.

(1) Each seal, access door, and all other openings shall be checked by visual inspections initially and quarterly thereafter to ensure that no cracks or gaps occur and that openings are closed and gasketed properly.

(2) Except as provided in § 61.350 of this subpart, when a broken seal or gasket or other problem is identified, first efforts at repair shall be made as soon as practicable, but not later than 15 calendar days after identification.

(3) If the cover and closed-vent system operate such that the treatment process and wastewater treatment system unit are maintained at a pressure less than atmospheric pressure, the owner or operator may operate the system with an opening that is not sealed and kept closed at all times if the following conditions are met:

(i) The purpose of the opening is to provide dilution air to reduce the explosion hazard;

(ii) The opening is designed to operate with no detectable emissions as indicated by an instrument reading of less than 500 ppmv above background, as determined initially and thereafter at least once per year by the methods specified in § 61.355(h); and

(iii) The pressure is monitored continuously to ensure that the pressure in the treatment process and wastewater treatment system unit remain below atmospheric pressure.

(f) Except for treatment processes complying with paragraph (d) of this section, the Administrator may request at any time an owner or operator demonstrate that a treatment process or wastewater treatment system unit meets the applicable requirements specified in paragraphs (a) or (b) of this section by conducting a performance test using the test methods and procedures as required in § 61.355 of this subpart.

(g) The owner or operator of a treatment process or wastewater treatment system unit that is used to comply with the provisions of this section shall monitor the unit in accordance with the applicable requirements in § 61.354 of this subpart.

[55 FR 8346, Mar. 7, 1990, as amended at 55 FR 37231, Sept. 10, 1990; 58 FR 3098, Jan. 7, 1993; 65 FR 62160, Oct. 17, 2000]

§ 61.349 Standards: Closed-vent systems and control devices.

(a) For each closed-vent system and control device used to comply with standards in accordance with §§ 61.343 through 61.348 of this subpart, the owner or operator shall properly design, install, operate, and maintain the closed-vent system and control device in accordance with the following requirements:

(1) The closed-vent system shall:

(i) Be designed to operate with no detectable emissions as indicated by an instrument reading of less than 500 ppmv above background, as determined initially and thereafter at least once per year by the methods specified in § 61.355(h) of this subpart.

(ii) Vent systems that contain any bypass line that could divert the vent stream away from a control device used to comply with the provisions of this subpart shall install, maintain, and operate according to the manufacturer's specifications a flow indicator that provides a record of vent stream flow away from the control device at least once every 15 minutes, except as provided in paragraph (a) (1)(ii)(B) of this section.

(A) The flow indicator shall be installed at the entrance to any bypass line that could divert the vent stream away from the control device to the atmosphere.

(B) Where the bypass line valve is secured in the closed position with a car-seal or a lock-and-key type configuration, a flow indicator is not required.

(iii) All gauging and sampling devices shall be gas-tight except when gauging or sampling is taking place.

(iv) For each closed-vent system complying with paragraph (a) of this section, one or more devices which vent directly to the atmosphere may be used on the closed-vent system provided each device remains in a closed, sealed position during normal operations except when the device needs to open to prevent physical damage or permanent deformation of the closed-vent system resulting from malfunction of the unit in accordance with good engineering and safety practices for handling flammable, explosive, or other hazardous materials.

(2) The control device shall be designed and operated in accordance with the following conditions:

(i) An enclosed combustion device (e.g., a vapor incinerator, boiler, or process heater) shall meet one of the following conditions:

(A) Reduce the organic emissions vented to it by 95 weight percent or greater;

(B) Achieve a total organic compound concentration of 20 ppmv (as the sum of the concentrations for individual compounds using Method 18) on a dry basis corrected to 3 percent oxygen; or

(C) Provide a minimum residence time of 0.5 seconds at a minimum temperature of 760 °C (1,400 °F). If a boiler or process heater issued as the control device, then the vent stream shall be introduced into the flame zone of the boiler or process heater.

(ii) A vapor recovery system (e.g., a carbon adsorption system or a condenser) shall recover or control the organic emissions vented to it with an efficiency of 95 weight percent or greater, or shall recover or control the benzene emissions vented to it with an efficiency of 98 weight percent or greater.

(iii) A flare shall comply with the requirements of 40 CFR 60.18.

(iv) A control device other than those described in paragraphs (a)(2) (i) through (iii) of this section may be used provided that the following conditions are met:

(A) The device shall recover or control the organic emissions vented to it with an efficiency of 95 weight percent or greater, or shall recover or control the benzene emissions vented to it with an efficiency of 98 weight percent or greater.

(B) The owner or operator shall develop test data and design information that documents the control device will achieve an emission control efficiency of either 95 percent or greater for organic compounds or 98 percent or greater for benzene.

(C) The owner or operator shall identify:

(1) The critical operating parameters that affect the emission control performance of the device;

(2) The range of values of these operating parameters that ensure the emission control efficiency specified in paragraph (a)(2)(iv)(A) of this section is maintained during operation of the device; and

(3) How these operating parameters will be monitored to ensure the proper operation and maintenance of the device.

(D) The owner or operator shall submit the information and data specified in paragraphs (a)(2)(iv) (B) and (C) of this section to the Administrator prior to operation of the alternative control device.

(E) The Administrator will determine, based on the information submitted under paragraph (a)(2) (iv)(D) of this section, if the control device subject to paragraph (a)(2)(iv) of this section meets the requirements of § 61.349. The control device subject to paragraph (a)(2)(iv) of this section may be operated prior to receiving approval from the Administrator. However, if the Administrator determines that the control device does not meet the requirements of § 61.349, the facility may be subject to enforcement action beginning from the time the control device began operation.

(b) Each closed-vent system and control device used to comply with this subpart shall be operated at all times when waste is placed in the waste management unit vented to the control device except when maintenance or repair of the waste management unit cannot be completed without a shutdown of the control device.

(c) An owner and operator shall demonstrate that each control device, except for a flare, achieves the appropriate conditions specified in paragraph (a)(2) of this section by using one of the following methods:

(1) Engineering calculations in accordance with requirements specified in § 61.356(f) of this subpart; or

(2) Performance tests conducted using the test methods and procedures that meet the requirements specified in § 61.355 of this subpart.

(d) An owner or operator shall demonstrate compliance of each flare in accordance with paragraph (a)(2)(iii) of this section.

(e) The Administrator may request at any time an owner or operator demonstrate that a control device meets the applicable conditions specified in paragraph (a)(2) of this section by conducting a performance test using the test methods and procedures as required in § 61.355, and for control devices subject to paragraph (a)(2)(iv) of this section, the Administrator may specify alternative test methods and procedures, as appropriate.

(f) Each closed-vent system and control device shall be visually inspected initially and quarterly thereafter. The visual inspection shall include inspection of ductwork and piping and connections to covers and control devices for evidence of visible defects such as holes in ductwork or piping and loose connections.

(g) Except as provided in § 61.350 of this subpart, if visible defects are observed during an inspection, or if other problems are identified, or if detectable emissions are measured, a first effort to repair the closed-vent system and control device shall be made as soon as practicable but no later than 5 calendar days after detection. Repair shall be completed no later than 15 calendar days after the emissions are detected or the visible defect is observed.

(h) The owner or operator of a control device that is used to comply with the provisions of this section shall monitor the control device in accordance with § 61.354(c) of this subpart.

[55 FR 8346, Mar. 7, 1990; 55 FR 12444, Apr. 3, 1990, as amended at 55 FR 37231, Sept. 10, 1990; 58 FR 3098, Jan. 7, 1993; 65 FR 62160, Oct. 17, 2000]

§ 61.350 Standards: Delay of repair.

(a) Delay of repair of facilities or units that are subject to the provisions of this subpart will be allowed if the repair is technically impossible without a complete or partial facility or unit shutdown.

(b) Repair of such equipment shall occur before the end of the next facility or unit shutdown.

§ 61.351 Alternative standards for tanks.

(a) As an alternative to the standards for tanks specified in § 61.343 of this subpart, an owner or operator may elect to comply with one of the following:

- (1) A fixed roof and internal floating roof meeting the requirements in 40 CFR 60.112b(a)(1);
- (2) An external floating roof meeting the requirements of 40 CFR 60.112b (a)(2); or
- (3) An alternative means of emission limitation as described in 40 CFR 60.114b.

(b) If an owner or operator elects to comply with the provisions of this section, then the owner or operator is exempt from the provisions of § 61.343 of this subpart applicable to the same facilities.

[55 FR 8346, Mar. 7, 1990, as amended at 55 FR 37231, Sept. 10, 1990]

§ 61.352 Alternative standards for oil-water separators.

(a) As an alternative to the standards for oil-water separators specified in § 61.347 of this subpart, an owner or operator may elect to comply with one of the following:

- (1) A floating roof meeting the requirements in 40 CFR 60.693-2(a); or
- (2) An alternative means of emission limitation as described in 40 CFR 60.694.

(b) For portions of the oil-water separator where it is infeasible to construct and operate a floating roof, such as over the weir mechanism, a fixed roof vented to a vapor control device that meets the requirements in §§ 61.347 and 61.349 of this subpart shall be installed and operated.

(c) Except as provided in paragraph (b) of this section, if an owner or operator elects to comply with the provisions of this section, then the owner or operator is exempt from the provisions in § 61.347 of this subpart applicable to the same facilities.

§ 61.353 Alternative means of emission limitation.

(a) If, in the Administrator's judgment, an alternative means of emission limitation will achieve a reduction in benzene emissions at least equivalent to the reduction in benzene emissions from the source achieved by the applicable design, equipment, work practice, or operational requirements in §§ 61.342 through 61.349, the Administrator will publish in the FEDERAL REGISTER a notice permitting the use of the alternative means for purposes of compliance with that requirement. The notice may condition the permission on requirements related to the operation and maintenance of the alternative means.

(b) Any notice under paragraph (a) of this section shall be published only after public notice and an opportunity for a hearing.

(c) Any person seeking permission under this section shall collect, verify, and submit to the Administrator information showing that the alternative means achieves equivalent emission reductions.

[55 FR 8346, Mar. 7, 1990, as amended at 58 FR 3099, Jan. 7, 1993]

§ 61.354 Monitoring of operations.

(a) Except for a treatment process or waste stream complying with § 61.348(d), the owner or operator shall monitor each treatment process or wastewater treatment system unit to ensure the unit is properly operated and maintained by one of the following monitoring procedures:

(1) Measure the benzene concentration of the waste stream exiting the treatment process complying with § 61.348(a)(1)(i) at least once per month by collecting and analyzing one or more samples using the procedures specified in § 61.355(c)(3).

(2) Install, calibrate, operate, and maintain according to manufacturer's specifications equipment to continuously monitor and record a process parameter (or parameters) for the treatment process or wastewater treatment system unit that indicates proper system operation. The owner or operator shall inspect at least once each operating day the data recorded by the monitoring equipment (e.g., temperature monitor or flow indicator) to ensure that the unit is operating properly.

(b) If an owner or operator complies with the requirements of § 61.348(b), then the owner or operator shall monitor each wastewater treatment system to ensure the unit is properly operated and maintained by the appropriate monitoring procedure as follows:

(1) For the first exempt waste management unit in each waste treatment train, other than an enhanced biodegradation unit, measure the flow rate, using the procedures of § 61.355(b), and the benzene concentration of each waste stream entering the unit at least once per month by collecting and analyzing one or more samples using the procedures specified in § 61.355(c)(3).

(2) For each enhanced biodegradation unit that is the first exempt waste management unit in a treatment train, measure the benzene concentration of each waste stream entering the unit at least once per month by collecting and analyzing one or more samples using the procedures specified in § 61.355(c)(3).

(c) An owner or operator subject to the requirements in § 61.349 of this subpart shall install, calibrate, maintain, and operate according to the manufacturer's specifications a device to continuously monitor the control device operation as specified in the following paragraphs, unless alternative monitoring procedures or requirements are approved for that facility by the Administrator.

The owner or operator shall inspect at least once each operating day the data recorded by the monitoring equipment (e.g., temperature monitor or flow indicator) to ensure that the control device is operating properly.

(1) For a thermal vapor incinerator, a temperature monitoring device equipped with a continuous recorder. The device shall have an accuracy of ± 1 percent of the temperature being monitored in $^{\circ}\text{C}$ or ± 0.5 $^{\circ}\text{C}$, whichever is greater. The temperature sensor shall be installed at a representative location in the combustion chamber.

(2) For a catalytic vapor incinerator, a temperature monitoring device equipped with a continuous recorder. The device shall be capable of monitoring temperature at two locations, and have an accuracy of ± 1 percent of the temperature being monitored in $^{\circ}\text{C}$ or ± 0.5 $^{\circ}\text{C}$, whichever is greater. One temperature sensor shall be installed in the vent stream at the nearest feasible point to the catalyst bed inlet and a second temperature sensor shall be installed in the vent stream at the nearest feasible point to the catalyst bed outlet.

(3) For a flare, a monitoring device in accordance with 40 CFR 60.18(f)(2) equipped with a continuous recorder.

(4) For a boiler or process heater having a design heat input capacity less than 44 MW (150×10^6 BTU/hr), a temperature monitoring device equipped with a continuous recorder. The device shall have an accuracy of ± 1 percent of the temperature being monitored in $^{\circ}\text{C}$ or ± 0.5 $^{\circ}\text{C}$, whichever is greater. The temperature sensor shall be installed at a representative location in the combustion chamber.

(5) For a boiler or process heater having a design heat input capacity greater than or equal to 44 MW (150×10^6 BTU/hr), a monitoring device equipped with a continuous recorder to measure a parameter(s) that indicates good combustion operating practices are being used.

(6) For a condenser, either:

(i) A monitoring device equipped with a continuous recorder to measure either the concentration level of the organic compounds or the concentration level of benzene in the exhaust vent stream from the condenser; or

(ii) A temperature monitoring device equipped with a continuous recorder. The device shall be capable of monitoring temperature at two locations, and have an accuracy of ± 1 percent of the temperature being monitored in $^{\circ}\text{C}$ or ± 0.5 $^{\circ}\text{C}$, whichever is greater. One temperature sensor shall be installed at a location in the exhaust stream from the condenser, and a second temperature sensor shall be installed at a location in the coolant fluid exiting the condenser.

(7) For a carbon adsorption system that regenerates the carbon bed directly in the control device such as a fixed-bed carbon adsorber, either:

(i) A monitoring device equipped with a continuous recorder to measure either the concentration level of the organic compounds or the benzene concentration level in the exhaust vent stream from the carbon bed; or

(ii) A monitoring device equipped with a continuous recorder to measure a parameter that indicates the carbon bed is regenerated on a regular, predetermined time cycle.

(8) For a vapor recovery system other than a condenser or carbon adsorption system, a monitoring device equipped with a continuous recorder to measure either the concentration level of the organic compounds or the benzene concentration level in the exhaust vent stream from the control device.

(9) For a control device subject to the requirements of § 61.349(a)(2)(iv), devices to monitor the parameters as specified in § 61.349(a)(2)(iv)(C).

(d) For a carbon adsorption system that does not regenerate the carbon bed directly on site in the control device (e.g., a carbon canister), either the concentration level of the organic compounds or the concentration level of benzene in the exhaust vent stream from the carbon adsorption system shall be monitored on a regular schedule, and the existing carbon shall be replaced with fresh carbon immediately when carbon breakthrough is indicated. The device shall be monitored on a daily basis or at intervals no greater than 20 percent of the design carbon replacement interval, whichever is greater. As an alternative to conducting this monitoring, an owner or operator may replace the carbon in the carbon adsorption system with fresh carbon at a regular predetermined time interval that is less than the carbon replacement interval that is determined by the maximum design flow rate and either the organic concentration or the benzene concentration in the gas stream vented to the carbon adsorption system.

(e) An alternative operation or process parameter may be monitored if it can be demonstrated that another parameter will ensure that the control device is operated in conformance with these standards and the control device's design specifications.

(f) Owners or operators using a closed-vent system that contains any bypass line that could divert a vent stream from a control device used to comply with the provisions of this subpart shall do the following:

(1) Visually inspect the bypass line valve at least once every month, checking the position of the valve and the condition of the car-seal or closure mechanism required under § 61.349(a)(1)(ii) to ensure that the valve is maintained in the closed position and the vent stream is not diverted through the bypass line.

(2) Visually inspect the readings from each flow monitoring device required by § 61.349(a)(1)(ii) at least once each operating day to check that vapors are being routed to the control device as required.

(g) Each owner or operator who uses a system for emission control that is maintained at a pressure less than atmospheric pressure with openings to provide dilution air shall install, calibrate, maintain, and operate according to the manufacturer's specifications a device equipped with a continuous recorder to monitor the pressure in the unit to ensure that it is less than atmospheric pressure.

[55 FR 8346, Mar. 7, 1990, as amended at 58 FR 3099, Jan. 7, 1993; 65 FR 62160, Oct. 17, 2000]

§ 61.355 Test methods, procedures, and compliance provisions.

(a) An owner or operator shall determine the total annual benzene quantity from facility waste by the following procedure:

(1) For each waste stream subject to this subpart having a flow-weighted annual average water content greater than 10 percent water, on a volume basis as total water, or is mixed with water or other wastes at any time and the resulting mixture has an annual average water content greater than 10 percent as specified in § 61.342(a), the owner or operator shall:

(i) Determine the annual waste quantity for each waste stream using the procedures specified in paragraph (b) of this section.

(ii) Determine the flow-weighted annual average benzene concentration for each waste stream using the procedures specified in paragraph (c) of this section.

(iii) Calculate the annual benzene quantity for each waste stream by multiplying the annual waste quantity of the waste stream times the flow-weighted annual average benzene concentration.

(2) Total annual benzene quantity from facility waste is calculated by adding together the annual benzene quantity for each waste stream generated during the year and the annual benzene quantity for each process unit turnaround waste annualized according to paragraph (b)(4) of this section.

(3) If the total annual benzene quantity from facility waste is equal to or greater than 10 Mg/yr (11 ton/yr), then the owner or operator shall comply with the requirements of § 61.342 (c), (d), or (e).

(4) If the total annual benzene quantity from facility waste is less than 10 Mg/yr (11 ton/yr) but is equal to or greater than 1 Mg/yr (1.1 ton/yr), then the owner or operator shall:

(i) Comply with the recordkeeping requirements of § 61.356 and reporting requirements of § 61.357 of this subpart; and

(ii) Repeat the determination of total annual benzene quantity from facility waste at least once per year and whenever there is a change in the process generating the waste that could cause the total annual benzene quantity from facility waste to increase to 10 Mg/yr (11 ton/yr) or more.

(5) If the total annual benzene quantity from facility waste is less than 1 Mg/yr (1.1 ton/yr), then the owner or operator shall:

(i) Comply with the recordkeeping requirements of § 61.356 and reporting requirements of § 61.357 of this subpart; and

(ii) Repeat the determination of total annual benzene quantity from facility waste whenever there is a change in the process generating the waste that could cause the total annual benzene quantity from facility waste to increase to 1 Mg/yr (1.1 ton/yr) or more.

(6) The benzene quantity in a waste stream that is generated less than one time per year, except as provided for process unit turnaround waste in paragraph (b)(4) of this section, shall be included in the determination of total annual benzene quantity from facility waste for the year in which the waste is generated unless the waste stream is otherwise excluded from the determination of total annual benzene quantity from facility waste in accordance with paragraphs (a) through (c) of this section. The benzene quantity in this waste stream shall not be annualized or averaged over the time interval between the activities that resulted in generation of the waste, for purposes of determining the total annual benzene quantity from facility waste.

(b) For purposes of the calculation required by paragraph (a) of this section, an owner or operator shall determine the annual waste quantity at the point of waste generation, unless otherwise provided in paragraphs (b) (1), (2), (3), and (4) of this section, by one of the methods given in paragraphs (b) (5) through (7) of this section.

(1) The determination of annual waste quantity for sour water streams that are processed in sour water strippers shall be made at the point that the water exits the sour water stripper.

(2) The determination of annual waste quantity for wastes at coke by-product plants subject to and complying with the control requirements of § 61.132, 61.133, 61.134, or 61.139 of subpart L of this part shall be made at the location that the waste stream exits the process unit component or waste management unit controlled by that subpart or at the exit of the ammonia still, provided that the following conditions are met:

(i) The transfer of wastes between units complying with the control requirements of subpart L of this part, process units, and the ammonia still is made through hard piping or other enclosed system.

(ii) The ammonia still meets the definition of a sour water stripper in § 61.341.

(3) The determination of annual waste quantity for wastes that are received at hazardous waste treatment, storage, or disposal facilities from offsite shall be made at the point where the waste enters the hazardous waste treatment, storage, or disposal facility.

(4) The determination of annual waste quantity for each process unit turnaround waste generated only at 2 year or greater intervals, may be made by dividing the total quantity of waste generated during the most recent process unit turnaround by the time period (in the nearest tenth of a year) between the turnaround resulting in generation of the waste and the most recent preceding process

turnaround for the unit. The resulting annual waste quantity shall be included in the calculation of the annual benzene quantity as provided in paragraph (a)(1)(iii) of this section for the year in which the turnaround occurs and for each subsequent year until the unit undergoes the next process turnaround. For estimates of total annual benzene quantity as specified in the 90-day report, required under § 61.357(a)(1), the owner or operator shall estimate the waste quantity generated during the most recent turnaround, and the time period between turnarounds in accordance with good engineering practices. If the owner or operator chooses not to annualize process unit turnaround waste, as specified in this paragraph, then the process unit turnaround waste quantity shall be included in the calculation of the annual benzene quantity for the year in which the turnaround occurs.

(5) Select the highest annual quantity of waste managed from historical records representing the most recent 5 years of operation or, if the facility has been in service for less than 5 years but at least 1 year, from historical records representing the total operating life of the facility;

(6) Use the maximum design capacity of the waste management unit; or

(7) Use measurements that are representative of maximum waste generation rates.

(c) For the purposes of the calculation required by §§ 61.355(a) of this subpart, an owner or operator shall determine the flow-weighted annual average benzene concentration in a manner that meets the requirements given in paragraph (c)(1) of this section using either of the methods given in paragraphs (c)(2) and (c)(3) of this section.

(1) The determination of flow-weighted annual average benzene concentration shall meet all of the following criteria:

(i) The determination shall be made at the point of waste generation except for the specific cases given in paragraphs (c)(1)(i)(A) through (D) of this section.

(A) The determination for sour water streams that are processed in sour water strippers shall be made at the point that the water exits the sour water stripper.

(B) The determination for wastes at coke by-product plants subject to and complying with the control requirements of § 61.132, 61.133, 61.134, or 61.139 of subpart L of this part shall be made at the location that the waste stream exits the process unit component or waste management unit controlled by that subpart or at the exit of the ammonia still, provided that the following conditions are met:

(1) The transfer of wastes between units complying with the control requirements of subpart L of this part, process units, and the ammonia still is made through hard piping or other enclosed system.

(2) The ammonia still meets the definition of a sour water stripper in § 61.341.

(C) The determination for wastes that are received from offsite shall be made at the point where the waste enters the hazardous waste treatment, storage, or disposal facility.

(D) The determination of flow-weighted annual average benzene concentration for process unit turnaround waste shall be made using either of the methods given in paragraph (c)(2) or (c)(3) of this section. The resulting flow-weighted annual average benzene concentration shall be included in the calculation of annual benzene quantity as provided in paragraph (a)(1)(iii) of this section for the year in which the turnaround occurs and for each subsequent year until the unit undergoes the next process unit turnaround.

(ii) Volatilization of the benzene by exposure to air shall not be used in the determination to reduce the benzene concentration.

(iii) Mixing or diluting the waste stream with other wastes or other materials shall not be used in the determination—to reduce the benzene concentration.

(iv) The determination shall be made prior to any treatment of the waste that removes benzene, except as specified in paragraphs (c)(1)(i)(A) through (D) of this section.

(v) For wastes with multiple phases, the determination shall provide the weighted-average benzene concentration based on the benzene concentration in each phase of the waste and the relative proportion of the phases.

(2) *Knowledge of the waste.* The owner or operator shall provide sufficient information to document the flow-weighted annual average benzene concentration of each waste stream. Examples of information that could constitute knowledge include material balances, records of chemicals purchases, or previous test results provided the results are still relevant to the current waste stream conditions. If test data are used, then the owner or operator shall provide documentation describing the testing protocol and the means by which sampling variability and analytical variability were accounted for in the determination of the flow-weighted annual average benzene concentration for the waste stream. When an owner or operator and the Administrator do not agree on determinations of the flow-weighted annual average benzene concentration based on knowledge of the waste, the procedures under paragraph (c)(3) of this section shall be used to resolve the disagreement.

(3) Measurements of the benzene concentration in the waste stream in accordance with the following procedures:

(i) Collect a minimum of three representative samples from each waste stream. Where feasible, samples shall be taken from an enclosed pipe prior to the waste being exposed to the atmosphere.

(ii) For waste in enclosed pipes, the following procedures shall be used:

(A) Samples shall be collected prior to the waste being exposed to the atmosphere in order to minimize the loss of benzene prior to sampling.

(B) A static mixer shall be installed in the process line or in a by-pass line unless the owner or operator demonstrates that installation of a static mixer in the line is not necessary to accurately determine the benzene concentration of the waste stream.

(C) The sampling tap shall be located within two pipe diameters of the static mixer outlet.

(D) Prior to the initiation of sampling, sample lines and cooling coil shall be purged with at least four volumes of waste.

(E) After purging, the sample flow shall be directed to a sample container and the tip of the sampling tube shall be kept below the surface of the waste during sampling to minimize contact with the atmosphere.

(F) Samples shall be collected at a flow rate such that the cooling coil is able to maintain a waste temperature less than 10 °C (50 °F).

(G) After filling, the sample container shall be capped immediately (within 5 seconds) to leave a minimum headspace in the container.

(H) The sample containers shall immediately be cooled and maintained at a temperature below 10 °C (50 °F) for transfer to the laboratory.

(iii) When sampling from an enclosed pipe is not feasible, a minimum of three representative samples shall be collected in a manner to minimize exposure of the sample to the atmosphere and loss of benzene prior to sampling.

(iv) Each waste sample shall be analyzed using one of the following test methods for determining the benzene concentration in a waste stream:

(A) Method 8020, Aromatic Volatile Organics, in “Test Methods for Evaluating Solid Waste, Physical/Chemical Methods,” EPA Publication No. SW-846 (incorporation by reference as specified in § 61.18 of this part);

(B) Method 8021, Volatile Organic Compounds in Water by Purge and Trap Capillary Column Gas Chromatography with Photoionization and Electrolytic Conductivity Detectors in Series in “Test Methods for Evaluating Solid Waste, Physical/Chemical Methods,” EPA Publication No. SW-846 (incorporation by reference as specified in § 61.18 of this part);

(C) Method 8240, Gas Chromatography/Mass Spectrometry for Volatile Organics in “Test Methods for Evaluating Solid Waste, Physical/Chemical Methods,” EPA Publication No. SW-846 (incorporation by reference as specified in § 61.18 of this part);

(D) Method 8260, Gas Chromatography/Mass Spectrometry for Volatile Organics: Capillary Column Technique in “Test Methods for Evaluating Solid Waste, Physical/Chemical Methods,” EPA Publication No. SW-846 (incorporation by reference as specified in § 61.18 of this part);

(E) Method 602, Purgeable Aromatics, as described in 40 CFR part 136, appendix A, Test Procedures for Analysis of Organic Pollutants, for wastewaters for which this is an approved EPA methods; or

(F) Method 624, Purgeables, as described in 40 CFR part 136, appendix A, Test Procedures for Analysis of Organic Pollutants, for wastewaters for which this is an approved EPA method.

(v) The flow-weighted annual average benzene concentration shall be calculated by averaging the results of the sample analyses as follows:

$$\bar{C} = \frac{1}{Q_t} \times \sum_{i=1}^n (Q_i)(C_i)$$

Where:

\bar{C} = Flow-weighted annual average benzene concentration for waste stream, ppmw.

Q_t = Total annual waste quantity for waste stream, kg/yr (lb/yr).

n = Number of waste samples (at least 3).

Q_i = Annual waste quantity for waste stream represented by C_i , kg/yr (lb/yr).

C_i = Measured concentration of benzene in waste sample i , ppmw.

(d) An owner or operator using performance tests to demonstrate compliance of a treatment process with § 61.348 (a)(1)(i) shall measure the flow-weighted annual average benzene concentration of the waste stream exiting the treatment process by collecting and analyzing a minimum of three representative samples of the waste stream using the procedures in paragraph (c) (3) of this section. The test shall be conducted under conditions that exist when the treatment process is operating at the highest inlet waste stream flow rate and benzene content expected to occur. Operations during periods of startup, shutdown, and malfunction shall not constitute representative conditions for the purpose of a test. The owner or operator shall record all process information as is necessary to document the operating conditions during the test.

(e) An owner or operator using performance tests to demonstrate compliance of a treatment process with § 61.348(a)(1)(ii) of this subpart shall determine the percent reduction of benzene in the waste stream on a mass basis by the following procedure:

(1) The test shall be conducted under conditions that exist when the treatment process is operating at the highest inlet waste stream flow rate and benzene content expected to occur. Operations during periods of startup, shutdown, and malfunction shall not constitute representative

conditions for the purpose of a test. The owner or operator shall record all process information as is necessary to document the operating conditions during the test.

(2) All testing equipment shall be prepared and installed as specified in the appropriate test methods.

(3) The mass flow rate of benzene entering the treatment process (E_b) shall be determined by computing the product of the flow rate of the waste stream entering the treatment process, as determined by the inlet flow meter, and the benzene concentration of the waste stream, as determined using the sampling and analytical procedures specified in paragraph (c)(2) or (c)(3) of this section. Three grab samples of the waste shall be taken at equally spaced time intervals over a 1-hour period. Each 1-hour period constitutes a run, and the performance test shall consist of a minimum of 3 runs conducted over a 3-hour period. The mass flow rate of benzene entering the treatment process is calculated as follows:

$$E_b = \frac{K}{n \times 10^6} \left[\sum_{i=1}^n V_i C_i \right]$$

Where:

E_b = Mass flow rate of benzene entering the treatment process, kg/hr (lb/hr).

K = Density of the waste stream, kg/m³ (lb/ft³).

V_i = Average volume flow rate of waste entering the treatment process during each run i , m³/hr (ft³/hr).

C_i = Average concentration of benzene in the waste stream entering the treatment process during each run i , ppmw.

n = Number of runs.

10^6 = Conversion factor for ppmw.

(4) The mass flow rate of benzene exiting the treatment process (E_a) shall be determined by computing the product of the flow rate of the waste stream exiting the treatment process, as determined by the outlet flow meter or the inlet flow meter, and the benzene concentration of the waste stream, as determined using the sampling and analytical procedures specified in paragraph (c)(2) or (c)(3) of this section. Three grab samples of the waste shall be taken at equally spaced time intervals over a 1-hour period. Each 1-hour period constitutes a run, and the performance test shall consist of a minimum of 3 runs conducted over the same 3-hour period at which the mass flow rate of benzene entering the treatment process is determined. The mass flow rate of benzene exiting the treatment process is calculated as follows:

$$E_a = \frac{K}{n \times 10^6} \left[\sum_{i=1}^n V_i C_i \right]$$

Where:

E_a = Mass flow rate of benzene exiting the treatment process, kg/hr (lb/hr).

K = Density of the waste stream, kg/m³ (lb/ft³).

V_i = Average volume flow rate of waste exiting the treatment process during each run i , m³/hr (ft³/hr).

C_i = Average concentration of benzene in the waste stream exiting the treatment process during each run i , ppmw.

n = Number of runs.

10^6 = Conversion factor for ppmw.

(f) An owner or operator using performance tests to demonstrate compliance of a treatment process with § 61.348(a)(1)(iii) of this subpart shall determine the benzene destruction efficiency for the combustion unit by the following procedure:

(1) The test shall be conducted under conditions that exist when the combustion unit is operating at the highest inlet waste stream flow rate and benzene content expected to occur. Operations during periods of startup, shutdown, and malfunction shall not constitute representative conditions for the purpose of a test. The owner or operator shall record all process information necessary to document the operating conditions during the test.

(2) All testing equipment shall be prepared and installed as specified in the appropriate test methods.

(3) The mass flow rate of benzene entering the combustion unit shall be determined by computing the product of the flow rate of the waste stream entering the combustion unit, as determined by the inlet flow meter, and the benzene concentration of the waste stream, as determined using the sampling procedures in paragraph (c)(2) or (c)(3) of this section. Three grab samples of the waste shall be taken at equally spaced time intervals over a 1-hour period. Each 1-hour period constitutes a run, and the performance test shall consist of a minimum of 3 runs conducted over a 3-hour period. The mass flow rate of benzene into the combustion unit is calculated as follows:

$$E_b = \frac{K}{n \times 10^6} \left[\sum_{i=1}^n V_i C_i \right]$$

Where:

E_b = Mass flow rate of benzene entering the combustion unit, kg/hr (lb/hr).

K = Density of the waste stream, kg/m³ (lb/ft³).

V_i = Average volume flow rate of waste entering the combustion unit during each run i , m³/hr (ft³/hr).

C_i = Average concentration of benzene in the waste stream entering the combustion unit during each run i , ppmw.

n = Number of runs.

10^6 = Conversion factor for ppmw.

(4) The mass flow rate of benzene exiting the combustion unit exhaust stack shall be determined as follows:

(i) The time period for the test shall not be less than 3 hours during which at least 3 stack gas samples are collected and be the same time period at which the mass flow rate of benzene entering the treatment process is determined. Each sample shall be collected over a 1-hour period (e.g., in a tedlar bag) to represent a time-integrated composite sample and each 1-hour period shall correspond to the periods when the waste feed is sampled.

(ii) A run shall consist of a 1-hour period during the test. For each run:

(A) The reading from each measurement shall be recorded;

(B) The volume exhausted shall be determined using Method 2, 2A, 2C, or 2D from appendix A of 40 CFR part 60, as appropriate.

(C) The average benzene concentration in the exhaust downstream of the combustion unit shall be determined using Method 18 from appendix A of 40 CFR part 60.

(iii) The mass of benzene emitted during each run shall be calculated as follows:

$$M_i = D_b VC(10^{-6})$$

Where:

M_i = Mass of benzene emitted during run i, kg (lb).

V = Volume of air-vapor mixture exhausted at standard conditions, m^3 (ft^3).

C = Concentration of benzene measured in the exhaust, ppmv.

D_b = Density of benzene, $3.24 \text{ kg}/m^3$ ($0.202 \text{ lb}/ft^3$).

10^6 = Conversion factor for ppmv.

(iv) The benzene mass emission rate in the exhaust shall be calculated as follows:

$$E_a = \left(\sum_{i=1}^n M_i \right) / T$$

Where:

E_a = Mass flow rate of benzene emitted from the combustion unit, kg/hr (lb/hr).

M_i = Mass of benzene emitted from the combustion unit during run i, kg (lb).

T = Total time of all runs, hr.

n = Number of runs.

(5) The benzene destruction efficiency for the combustion unit shall be calculated as follows:

$$R = \frac{E_b - E_a}{E_b} \times 100$$

Where:

R = Benzene destruction efficiency for the combustion unit, percent.

E_b = Mass flow rate of benzene entering the combustion unit, kg/hr (lb/hr).

E_a = Mass flow rate of benzene emitted from the combustion unit, kg/hr (lb/hr).

(g) An owner or operator using performance tests to demonstrate compliance of a wastewater treatment system unit with § 61.348(b) shall measure the flow-weighted annual average benzene concentration of the wastewater stream where the waste stream enters an exempt waste management unit by collecting and analyzing a minimum of three representative samples of the waste stream using the procedures in paragraph (c)(3) of this section. The test shall be conducted under conditions that exist when the wastewater treatment system is operating at the highest inlet wastewater stream flow rate and benzene content expected to occur. Operations during periods of startup, shutdown, and malfunction shall not constitute representative conditions for the purpose of a test. The owner or operator shall record all process information as is necessary to document the operating conditions during the test.

(h) An owner or operator shall test equipment for compliance with no detectable emissions as required in §§ 61.343 through 61.347, and § 61.349 of this subpart in accordance with the following requirements:

(1) Monitoring shall comply with Method 21 from appendix A of 40 CFR part 60.

(2) The detection instrument shall meet the performance criteria of Method 21.

(3) The instrument shall be calibrated before use on each day of its use by the procedures specified in Method 21.

(4) Calibration gases shall be:

(i) Zero air (less than 10 ppm of hydrocarbon in air); and

(ii) A mixture of methane or n-hexane and air at a concentration of approximately, but less than, 10,000 ppm methane or n-hexane.

(5) The background level shall be determined as set forth in Method 21.

(6) The instrument probe shall be traversed around all potential leak interfaces as close as possible to the interface as described in Method 21.

(7) The arithmetic difference between the maximum concentration indicated by the instrument and the background level is compared to 500 ppm for determining compliance.

(i) An owner or operator using a performance test to demonstrate compliance of a control device with either the organic reduction efficiency requirement or the benzene reduction efficiency requirement specified under § 61.349(a)(2) shall use the following procedures:

(1) The test shall be conducted under conditions that exist when the waste management unit vented to the control device is operating at the highest load or capacity level expected to occur. Operations during periods of startup, shutdown, and malfunction shall not constitute representative conditions for the purpose of a test. The owner or operator shall record all process information necessary to document the operating conditions during the test.

(2) Sampling sites shall be selected using Method 1 or 1A from appendix A of 40 CFR part 60, as appropriate.

(3) The mass flow rate of either the organics or benzene entering and exiting the control device shall be determined as follows:

(i) The time period for the test shall not be less than 3 hours during which at least 3 stack gas samples are collected. Samples of the vent stream entering and exiting the control device shall be collected during the same time period. Each sample shall be collected over a 1-hour period (e.g., in a tedlar bag) to represent a time-integrated composite sample.

(ii) A run shall consist of a 1-hour period during the test. For each run:

(A) The reading from each measurement shall be recorded;

(B) The volume exhausted shall be determined using Method 2, 2A, 2C, or 2D from appendix A of 40 CFR part 60, as appropriate;

(C) The organic concentration or the benzene concentration, as appropriate, in the vent stream entering and exiting the control shall be determined using Method 18 from appendix A of 40 CFR part 60.

(iii) The mass of organics or benzene entering and exiting the control device during each run shall be calculated as follows:

$$M_{aj} = \frac{K_i V_{aj}}{10^6} \left(\sum_{i=1}^n C_{ai} MW_i \right) \quad M_{bj} = \frac{K_j V_{bj}}{10^6} \left(\sum_{i=1}^n C_{bi} MW_i \right)$$

M_{aj} = Mass of organics or benzene in the vent stream entering the control device during run j, kg (lb).

M_{bj} = Mass of organics or benzene in the vent stream exiting the control device during run j, kg (lb).

V_{aj} = Volume of vent stream entering the control device during run j, at standard conditions, m^3 (ft^3).

V_{bj} = Volume of vent stream exiting the control device during run j, at standard conditions, m^3 (ft^3).

C_{ai} = Organic concentration of compound i or the benzene concentration measured in the vent stream entering the control device as determined by Method 18, ppm by volume on a dry basis.

C_{bi} = Organic concentration of compound i or the benzene concentration measured in the vent stream exiting the control device as determined by Method 18, ppm by volume on a dry basis.

MW_i = Molecular weight of organic compound i in the vent stream, or the molecular weight of benzene, kg/kg-mol (lb/lb-mole).

n = Number of organic compounds in the vent stream; if benzene reduction efficiency is being demonstrated, then n=1.

K_1 = Conversion factor for molar volume at standard conditions (293 K and 760 mm Hg (527 R and 14.7 psia))
= 0.0416 kg-mol/ m^3 (0.00118 lb-mol/ ft^3)

10^{-6} = Conversion factor for ppmv.

(iv) The mass flow rate of organics or benzene entering and exiting the control device shall be calculated as follows:

$$E_a = \left(\sum_{j=1}^n M_{aj} \right) / T$$

$$E_b = \left(\sum_{j=1}^n M_{bj} \right) / T$$

Where:

E_a = Mass flow rate of organics or benzene entering the control device, kg/hr (lb/hr).

E_b = Mass flow rate of organics or benzene exiting the control device, kg/hr (lb/hr).

M_{aj} = Mass of organics or benzene in the vent stream entering the control device during run j, kg (lb).

M_{bj} = Mass of organics or benzene in the vent stream exiting the control device during run j, kg (lb).

T = Total time of all runs, hr.

n = Number of runs.

(4) The organic reduction efficiency or the benzene reduction efficiency for the control device shall be calculated as follows:

$$R = \frac{E_a - E_b}{E_a} \times 100$$

Where:

R = Total organic reduction of efficiency or benzene reduction efficiency for the control device, percent.

E_b = Mass flow rate of organics or benzene entering the control device, kg/hr (lb/hr).

E_a = Mass flow rate of organic or benzene emitted from the control device, kg/hr (lb/hr).

(j) An owner or operator shall determine the benzene quantity for the purposes of the calculation required by § 61.342 (c)(3)(ii)(B) according to the provisions of paragraph (a) of this section, except that the procedures in paragraph (a) of this section shall also apply to wastes with a water content of 10 percent or less.

(k) An owner or operator shall determine the benzene quantity for the purposes of the calculation required by § 61.342(e)(2) by the following procedure:

(1) For each waste stream that is not controlled for air emissions in accordance with § 61.343, 61.344, 61.345, 61.346, 61.347, or 61.348(a), as applicable to the waste management unit that manages the waste, the benzene quantity shall be determined as specified in paragraph (a) of this section, except that paragraph (b)(4) of this section shall not apply, i.e., the waste quantity for process unit turnaround waste is not annualized but shall be included in the determination of benzene quantity for the year in which the waste is generated for the purposes of the calculation required by § 61.342(e)(2).

(2) For each waste stream that is controlled for air emissions in accordance with § 61.343, 61.344, 61.345, 61.346, 61.347, or 61.348(a), as applicable to the waste management unit that manages the waste, the determination of annual waste quantity and flow-weighted annual average benzene concentration shall be made at the first applicable location as described in paragraphs (k)(2)(i), (k)(2)(ii), and (k)(2)(iii) of this section and prior to any reduction of benzene concentration through volatilization of the benzene, using the methods given in (k)(2)(iv) and (k)(2)(v) of this section.

(i) Where the waste stream enters the first waste management unit not complying with §§ 61.343, 61.344, 61.345, 61.346, 61.347, and 61.348(a) that are applicable to the waste management unit,

(ii) For each waste stream that is managed or treated only in compliance with §§ 61.343 through 61.348(a) up to the point of final direct discharge from the facility, the determination of benzene quantity shall be prior to any reduction of benzene concentration through volatilization of the benzene, or

(iii) For wastes managed in units controlled for air emissions in accordance with §§ 61.343, 61.344, 61.345, 61.346, 61.347, and 61.348(a), and then transferred offsite, facilities shall use the first applicable offsite location as described in paragraphs (k)(2)(i) and (k)(2)(ii) of this section if they have documentation from the offsite facility of the benzene quantity at this location. Facilities without this documentation for offsite wastes shall use the benzene quantity determined at the point where the transferred waste leaves the facility.

(iv) Annual waste quantity shall be determined using the procedures in paragraphs (b)(5), (6), or (7) of this section, and

(v) The flow-weighted annual average benzene concentration shall be determined using the procedures in paragraphs (c)(2) or (3) of this section.

(3) The benzene quantity in a waste stream that is generated less than one time per year, including process unit turnaround waste, shall be included in the determination of benzene quantity as determined in paragraph (k)(6) of this section for the year in which the waste is generated. The benzene quantity in this waste stream shall not be annualized or averaged over the time interval between the activities that resulted in generation of the waste for purposes of determining benzene quantity as determined in paragraph (k)(6) of this section.

(4) The benzene in waste entering an enhanced biodegradation unit, as defined in § 61.348(b)(2)(ii)(B), shall not be included in the determination of benzene quantity, determined in paragraph (k)(6) of this section, if the following conditions are met:

(i) The benzene concentration for each waste stream entering the enhanced biodegradation unit is less than 10 ppmw on a flow-weighted annual average basis, and

(ii) All prior waste management units managing the waste comply with §§ 61.343, 61.344, 61.345, 61.346, 61.347 and 61.348(a).

(5) The benzene quantity for each waste stream in paragraph (k)(2) of this section shall be determined by multiplying the annual waste quantity of each waste stream times its flow-weighted annual average benzene concentration.

(6) The total benzene quantity for the purposes of the calculation required by § 61.342(e)(2) shall be determined by adding together the benzene quantities determined in paragraphs (k)(1) and (k)(5) of this section for each applicable waste stream.

(7) If the benzene quantity determined in paragraph (6) of this section exceeds 6.0 Mg/yr (6.6 ton/yr) only because of multiple counting of the benzene quantity for a waste stream, the owner or operator may use the following procedures for the purposes of the calculation required by § 61.342(e)(2):

(i) Determine which waste management units are involved in the multiple counting of benzene;

(ii) Determine the quantity of benzene that is emitted, recovered, or removed from the affected units identified in paragraph (k)(7)(i) of this section, or destroyed in the units if applicable, using either direct measurements or the best available estimation techniques developed or approved by the Administrator.

(iii) Adjust the benzene quantity to eliminate the multiple counting of benzene based on the results from paragraph (k)(7)(ii) of this section and determine the total benzene quantity for the purposes of the calculation required by § 61.342(e)(2).

(iv) Submit in the annual report required under § 61.357(a) a description of the methods used and the resulting calculations for the alternative procedure under paragraph (k)(7) of this section, the benzene quantity determination from paragraph (k)(6) of this section, and the adjusted benzene quantity determination from paragraph (k)(7)(iii) of this section.

[55 FR 8346, Mar. 7, 1990; 55 FR 12444, Apr. 3, 1990, as amended at 55 FR 37231, Sept. 10, 1990; 58 FR 3099, Jan. 7, 1993; 65 FR 62160, Oct. 17, 2000]

§ 61.356 Recordkeeping requirements.

(a) Each owner or operator of a facility subject to the provisions of this subpart shall comply with the recordkeeping requirements of this section. Each record shall be maintained in a readily accessible location at the facility site for a period not less than two years from the date the information is recorded unless otherwise specified.

(b) Each owner or operator shall maintain records that identify each waste stream at the facility subject to this subpart, and indicate whether or not the waste stream is controlled for benzene emissions in accordance with this subpart. In addition the owner or operator shall maintain the following records:

(1) For each waste stream not controlled for benzene emissions in accordance with this subpart, the records shall include all test results, measurements, calculations, and other documentation used to determine the following information for the waste stream: waste stream identification, water content, whether or not the waste stream is a process wastewater stream, annual waste quantity, range of benzene concentrations, annual average flow-weighted benzene concentration, and annual benzene quantity.

(2) For each waste stream exempt from § 61.342(c)(1) in accordance with § 61.342(c)(3), the records shall include:

(i) All measurements, calculations, and other documentation used to determine that the continuous flow of process wastewater is less than 0.02 liters (0.005 gallons) per minute or the annual

waste quantity of process wastewater is less than 10 Mg/yr (11 ton/yr) in accordance with § 61.342(c)(3)(i), or

(ii) All measurements, calculations, and other documentation used to determine that the sum of the total annual benzene quantity in all exempt waste streams does not exceed 2.0 Mg/yr (2.2 ton/yr) in accordance with § 61.342(c)(3)(ii).

(3) For each facility where process wastewater streams are controlled for benzene emissions in accordance with § 61.342(d) of this subpart, the records shall include for each treated process wastewater stream all measurements, calculations, and other documentation used to determine the annual benzene quantity in the process wastewater stream exiting the treatment process.

(4) For each facility where waste streams are controlled for benzene emissions in accordance with § 61.342(e), the records shall include for each waste stream all measurements, including the locations of the measurements, calculations, and other documentation used to determine that the total benzene quantity does not exceed 6.0 Mg/yr (6.6 ton/yr).

(5) For each facility where the annual waste quantity for process unit turnaround waste is determined in accordance with § 61.355(b)(5), the records shall include all test results, measurements, calculations, and other documentation used to determine the following information: identification of each process unit at the facility that undergoes turnarounds, the date of the most recent turnaround for each process unit, identification of each process unit turnaround waste, the water content of each process unit turnaround waste, the annual waste quantity determined in accordance with § 61.355(b)(5), the range of benzene concentrations in the waste, the annual average flow-weighted benzene concentration of the waste, and the annual benzene quantity calculated in accordance with § 61.355(a)(1)(iii) of this section.

(6) For each facility where wastewater streams are controlled for benzene emissions in accordance with § 61.348(b)(2), the records shall include all measurements, calculations, and other documentation used to determine the annual benzene content of the waste streams and the total annual benzene quantity contained in all waste streams managed or treated in exempt waste management units.

(c) An owner or operator transferring waste off-site to another facility for treatment in accordance with § 61.342(f) shall maintain documentation for each offsite waste shipment that includes the following information: Date waste is shipped offsite, quantity of waste shipped offsite, name and address of the facility receiving the waste, and a copy of the notice sent with the waste shipment.

(d) An owner or operator using control equipment in accordance with §§ 61.343 through 61.347 shall maintain engineering design documentation for all control equipment that is installed on the waste management unit. The documentation shall be retained for the life of the control equipment. If a control device is used, then the owner or operator shall maintain the control device records required by paragraph (f) of this section.

(e) An owner or operator using a treatment process or wastewater treatment system unit in accordance with § 61.348 of this subpart shall maintain the following records. The documentation shall be retained for the life of the unit.

(1) A statement signed and dated by the owner or operator certifying that the unit is designed to operate at the documented performance level when the waste stream entering the unit is at the highest waste stream flow rate and benzene content expected to occur.

(2) If engineering calculations are used to determine treatment process or wastewater treatment system unit performance, then the owner or operator shall maintain the complete design analysis for the unit. The design analysis shall include for example the following information: Design specifications, drawings, schematics, piping and instrumentation diagrams, and other documentation necessary to demonstrate the unit performance.

(3) If performance tests are used to determine treatment process or wastewater treatment system unit performance, then the owner or operator shall maintain all test information necessary to demonstrate the unit performance.

(i) A description of the unit including the following information: type of treatment process; manufacturer name and model number; and for each waste stream entering and exiting the unit, the waste stream type (e.g., process wastewater, sludge, slurry, etc.), and the design flow rate and benzene content.

(ii) Documentation describing the test protocol and the means by which sampling variability and analytical variability were accounted for in the determination of the unit performance. The description of the test protocol shall include the following information: sampling locations, sampling method, sampling frequency, and analytical procedures used for sample analysis.

(iii) Records of unit operating conditions during each test run including all key process parameters.

(iv) All test results.

(4) If a control device is used, then the owner or operator shall maintain the control device records required by paragraph (f) of this section.

(f) An owner or operator using a closed-vent system and control device in accordance with § 61.349 of this subpart shall maintain the following records. The documentation shall be retained for the life of the control device.

(1) A statement signed and dated by the owner or operator certifying that the closed-vent system and control device is designed to operate at the documented performance level when the waste management unit vented to the control device is or would be operating at the highest load or capacity expected to occur.

(2) If engineering calculations are used to determine control device performance in accordance with § 61.349(c), then a design analysis for the control device that includes for example:

(i) Specifications, drawings, schematics, and piping and instrumentation diagrams prepared by the owner or operator, or the control device manufacturer or vendor that describe the control device design based on acceptable engineering texts. The design analysis shall address the following vent stream characteristics and control device operating parameters:

(A) For a thermal vapor incinerator, the design analysis shall consider the vent stream composition, constituent concentrations, and flow rate. The design analysis shall also establish the design minimum and average temperature in the combustion zone and the combustion zone residence time.

(B) For a catalytic vapor incinerator, the design analysis shall consider the vent stream composition, constituent concentrations, and flow rate. The design analysis shall also establish the design minimum and average temperatures across the catalyst bed inlet and outlet.

(C) For a boiler or process heater, the design analysis shall consider the vent stream composition, constituent concentrations, and flow rate. The design analysis shall also establish the design minimum and average flame zone temperatures, combustion zone residence time, and description of method and location where the vent stream is introduced into the flame zone.

(D) For a flare, the design analysis shall consider the vent stream composition, constituent concentrations, and flow rate. The design analysis shall also consider the requirements specified in 40 CFR 60.18.

(E) For a condenser, the design analysis shall consider the vent stream composition, constituent concentration, flow rate, relative humidity, and temperature. The design analysis shall also establish

the design outlet organic compound concentration level or the design outlet benzene concentration level, design average temperature of the condenser exhaust vent stream, and the design average temperatures of the coolant fluid at the condenser inlet and outlet.

(F) For a carbon adsorption system that regenerates the carbon bed directly on-site in the control device such as a fixed-bed adsorber, the design analysis shall consider the vent stream composition, constituent concentration, flow rate, relative humidity, and temperature. The design analysis shall also establish the design exhaust vent stream organic compound concentration level or the design exhaust vent stream benzene concentration level, number and capacity of carbon beds, type and working capacity of activated carbon used for carbon beds, design total steam flow over the period of each complete carbon bed regeneration cycle, duration of the carbon bed steaming and cooling/drying cycles, design carbon bed temperature after regeneration, design carbon bed regeneration time, and design service life of carbon.

(G) For a carbon adsorption system that does not regenerate the carbon bed directly on-site in the control device, such as a carbon canister, the design analysis shall consider the vent stream composition, constituent concentration, flow rate, relative humidity, and temperature. The design analysis shall also establish the design exhaust vent stream organic compound concentration level or the design exhaust vent stream benzene concentration level, capacity of carbon bed, type and working capacity of activated carbon used for carbon bed, and design carbon replacement interval based on the total carbon working capacity of the control device and source operating schedule.

(H) For a control device subject to the requirements of § 61.349(a)(2)(iv), the design analysis shall consider the vent stream composition, constituent concentration, and flow rate. The design analysis shall also include all of the information submitted under § 61.349 (a)(2)(iv).

(ii) [Reserved]

(3) If performance tests are used to determine control device performance in accordance with § 61.349(c) of this subpart:

(i) A description of how it is determined that the test is conducted when the waste management unit or treatment process is operating at the highest load or capacity level. This description shall include the estimated or design flow rate and organic content of each vent stream and definition of the acceptable operating ranges of key process and control parameters during the test program.

(ii) A description of the control device including the type of control device, control device manufacturer's name and model number, control device dimensions, capacity, and construction materials.

(iii) A detailed description of sampling and monitoring procedures, including sampling and monitoring locations in the system, the equipment to be used, sampling and monitoring frequency, and planned analytical procedures for sample analysis.

(iv) All test results.

(g) An owner or operator shall maintain a record for each visual inspection required by §§ 61.343 through 61.347 of this subpart that identifies a problem (such as a broken seal, gap or other problem) which could result in benzene emissions. The record shall include the date of the inspection, waste management unit and control equipment location where the problem is identified, a description of the problem, a description of the corrective action taken, and the date the corrective action was completed.

(h) An owner or operator shall maintain a record for each test of no detectable emissions required by §§ 61.343 through 61.347 and § 61.349 of this subpart. The record shall include the following information: date the test is performed, background level measured during test, and maximum concentration indicated by the instrument reading measured for each potential leak interface. If detectable emissions are measured at a leak interface, then the record shall also include the waste management unit, control equipment, and leak interface location where detectable emissions were

measured, a description of the problem, a description of the corrective action taken, and the date the corrective action was completed.

(i) For each treatment process and wastewater treatment system unit operated to comply with § 61.348, the owner or operator shall maintain documentation that includes the following information regarding the unit operation:

(1) Dates of startup and shutdown of the unit.

(2) If measurements of waste stream benzene concentration are performed in accordance with § 61.354(a)(1) of this subpart, the owner or operator shall maintain records that include date each test is performed and all test results.

(3) If a process parameter is continuously monitored in accordance with § 61.354(a)(2) of this subpart, the owner or operator shall maintain records that include a description of the operating parameter (or parameters) to be monitored to ensure that the unit will be operated in conformance with these standards and the unit's design specifications, and an explanation of the criteria used for selection of that parameter (or parameters). This documentation shall be kept for the life of the unit.

(4) If measurements of waste stream benzene concentration are performed in accordance with § 61.354(b), the owner or operator shall maintain records that include the date each test is performed and all test results.

(5) Periods when the unit is not operated as designed.

(j) For each control device, the owner or operator shall maintain documentation that includes the following information regarding the control device operation:

(1) Dates of startup and shutdown of the closed-vent system and control device.

(2) A description of the operating parameter (or parameters) to be monitored to ensure that the control device will be operated in conformance with these standards and the control device's design specifications and an explanation of the criteria used for selection of that parameter (or parameters). This documentation shall be kept for the life of the control device.

(3) Periods when the closed-vent system and control device are not operated as designed including all periods and the duration when:

(i) Any valve car-seal or closure mechanism required under § 61.349(a)(1)(ii) is broken or the bypass line valve position has changed.

(ii) The flow monitoring devices required under § 61.349(a)(1)(ii) indicate that vapors are not routed to the control device as required.

(4) If a thermal vapor incinerator is used, then the owner or operator shall maintain continuous records of the temperature of the gas stream in the combustion zone of the incinerator and records of all 3-hour periods of operation during which the average temperature of the gas stream in the combustion zone is more than 28 °C (50 °F) below the design combustion zone temperature.

(5) If a catalytic vapor incinerator is used, then the owner or operator shall maintain continuous records of the temperature of the gas stream both upstream and downstream of the catalyst bed of the incinerator, records of all 3-hour periods of operation during which the average temperature measured before the catalyst bed is more than 28 °C (50 °F) below the design gas stream temperature, and records of all 3-hour periods of operation during which the average temperature difference across the catalyst bed is less than 80 percent of the design temperature difference.

(6) If a boiler or process heater is used, then the owner or operator shall maintain records of each occurrence when there is a change in the location at which the vent stream is introduced into the flame zone as required by § 61.349(a)(2)(i)(C). For a boiler or process heater having a design heat input capacity less than 44 MW (150 × 106 BTU/hr), the owner or operator shall maintain continuous

records of the temperature of the gas stream in the combustion zone of the boiler or process heater and records of all 3-hour periods of operation during which the average temperature of the gas stream in the combustion zone is more than 28 °C (50 °F) below the design combustion zone temperature. For a boiler or process heater having a design heat input capacity greater than or equal to 44 MW (150 × 106 BTU/hr), the owner or operator shall maintain continuous records of the parameter(s) monitored in accordance with the requirements of § 61.354(c)(5).

(7) If a flare is used, then the owner or operator shall maintain continuous records of the flare pilot flame monitoring and records of all periods during which the pilot flame is absent.

(8) If a condenser is used, then the owner or operator shall maintain records from the monitoring device of the parameters selected to be monitored in accordance with § 61.354(c)(6). If concentration of organics or concentration of benzene in the control device outlet gas stream is monitored, then the owner or operator shall record all 3-hour periods of operation during which the concentration of organics or the concentration of benzene in the exhaust stream is more than 20 percent greater than the design value. If the temperature of the condenser exhaust stream and coolant fluid is monitored, then the owner or operator shall record all 3-hour periods of operation during which the temperature of the condenser exhaust vent stream is more than 6 °C (11 °F) above the design average exhaust vent stream temperature, or the temperature of the coolant fluid exiting the condenser is more than 6 °C (11 °F) above the design average coolant fluid temperature at the condenser outlet.

(9) If a carbon adsorber is used, then the owner or operator shall maintain records from the monitoring device of the concentration of organics or the concentration of benzene in the control device outlet gas stream. If the concentration of organics or the concentration of benzene in the control device outlet gas stream is monitored, then the owner or operator shall record all 3-hour periods of operation during which the concentration of organics or the concentration of benzene in the exhaust stream is more than 20 percent greater than the design value. If the carbon bed regeneration interval is monitored, then the owner or operator shall record each occurrence when the vent stream continues to flow through the control device beyond the predetermined carbon bed regeneration time.

(10) If a carbon adsorber that is not regenerated directly on site in the control device is used, then the owner or operator shall maintain records of dates and times when the control device is monitored, when breakthrough is measured, and shall record the date and time then the existing carbon in the control device is replaced with fresh carbon.

(11) If an alternative operational or process parameter is monitored for a control device, as allowed in § 61.354(e) of this subpart, then the owner or operator shall maintain records of the continuously monitored parameter, including periods when the device is not operated as designed.

(12) If a control device subject to the requirements of § 61.349(a)(2)(iv) is used, then the owner or operator shall maintain records of the parameters that are monitored and each occurrence when the parameters monitored are outside the range of values specified in § 61.349(a)(2)(iv)(C), or other records as specified by the Administrator.

(k) An owner or operator who elects to install and operate the control equipment in § 61.351 of this subpart shall comply with the recordkeeping requirements in 40 CFR 60.115b.

(l) An owner or operator who elects to install and operate the control equipment in § 61.352 of this subpart shall maintain records of the following:

(1) The date, location, and corrective action for each visual inspection required by 40 CFR 60.693-2(a)(5), during which a broken seal, gap, or other problem is identified that could result in benzene emissions.

(2) Results of the seal gap measurements required by 40 CFR 60.693-2(a).

(m) If a system is used for emission control that is maintained at a pressure less than atmospheric pressure with openings to provide dilution air, then the owner or operator shall maintain records of the

monitoring device and records of all periods during which the pressure in the unit is operated at a pressure that is equal to or greater than atmospheric pressure.

(n) Each owner or operator using a total enclosure to comply with control requirements for tanks in § 61.343 or the control requirements for containers in § 61.345 must keep the records required in paragraphs (n)(1) and (2) of this section. Owners or operators may use records as required in 40 CFR 264.1089(b)(2)(iv) or 40 CFR 265.1090(b)(2)(iv) for a tank or as required in 40 CFR 264.1089(d)(1) or 40 CFR 265.1090(d)(1) for a container to meet the recordkeeping requirement in paragraph (n)(1) of this section. The owner or operator must make the records of each verification of a total enclosure available for inspection upon request.

(1) Records of the most recent set of calculations and measurements performed to verify that the enclosure meets the criteria of a permanent total enclosure as specified in "Procedure T—Criteria for and Verification of a Permanent or Temporary Total Enclosure" in 40 CFR 52.741, appendix B;

(2) Records required for a closed-vent system and control device according to the requirements in paragraphs (d) (f), and (j) of this section.

[55 FR 8346, Mar. 7, 1990; 55 FR 12444, Apr. 3, 1990; 55 FR 18331, May 2, 1990, as amended at 58 FR 3103, Jan. 7, 1993; 65 FR 62161, Oct. 17, 2000; 67 FR 68533, Nov. 12, 2002]

§ 61.357 Reporting requirements.

(a) Each owner or operator of a chemical plant, petroleum refinery, coke by-product recovery plant, and any facility managing wastes from these industries shall submit to the Administrator within 90 days after January 7, 1993, or by the initial startup for a new source with an initial startup after the effective date, a report that summarizes the regulatory status of each waste stream subject to § 61.342 and is determined by the procedures specified in § 61.355(c) to contain benzene. Each owner or operator subject to this subpart who has no benzene onsite in wastes, products, by-products, or intermediates shall submit an initial report that is a statement to this effect. For all other owners or operators subject to this subpart, the report shall include the following information:

(1) Total annual benzene quantity from facility waste determined in accordance with § 61.355(a) of this subpart.

(2) A table identifying each waste stream and whether or not the waste stream will be controlled for benzene emissions in accordance with the requirements of this subpart.

(3) For each waste stream identified as not being controlled for benzene emissions in accordance with the requirements of this subpart the following information shall be added to the table:

(i) Whether or not the water content of the waste stream is greater than 10 percent;

(ii) Whether or not the waste stream is a process wastewater stream, product tank drawdown, or landfill leachate;

(iii) Annual waste quantity for the waste stream;

(iv) Range of benzene concentrations for the waste stream;

(v) Annual average flow-weighted benzene concentration for the waste stream; and

(vi) Annual benzene quantity for the waste stream.

(4) The information required in paragraphs (a) (1), (2), and (3) of this section should represent the waste stream characteristics based on current configuration and operating conditions. An owner or operator only needs to list in the report those waste streams that contact materials containing benzene. The report does not need to include a description of the controls to be installed to comply with the standard or other information required in § 61.10(a).

(b) If the total annual benzene quantity from facility waste is less than 1 Mg/yr (1.1 ton/yr), then the owner or operator shall submit to the Administrator a report that updates the information listed in paragraphs (a)(1) through (a)(3) of this section whenever there is a change in the process generating the waste stream that could cause the total annual benzene quantity from facility waste to increase to 1 Mg/yr (1.1 ton/yr) or more.

(c) If the total annual benzene quantity from facility waste is less than 10 Mg/yr (11 ton/yr) but is equal to or greater than 1 Mg/yr (1.1 ton/yr), then the owner or operator shall submit to the Administrator a report that updates the information listed in paragraphs (a)(1) through (a)(3) of this section. The report shall be submitted annually and whenever there is a change in the process generating the waste stream that could cause the total annual benzene quantity from facility waste to increase to 10 Mg/yr (11 ton/yr) or more. If the information in the annual report required by paragraphs (a)(1) through (a)(3) of this section is not changed in the following year, the owner or operator may submit a statement to that effect.

(d) If the total annual benzene quantity from facility waste is equal to or greater than 10 Mg/yr (11 ton/yr), then the owner or operator shall submit to the Administrator the following reports:

(1) Within 90 days after January 7, 1993, unless a waiver of compliance under § 61.11 of this part is granted, or by the date of initial startup for a new source with an initial startup after the effective date, a certification that the equipment necessary to comply with these standards has been installed and that the required initial inspections or tests have been carried out in accordance with this subpart. If a waiver of compliance is granted under § 61.11, the certification of equipment necessary to comply with these standards shall be submitted by the date the waiver of compliance expires.

(2) Beginning on the date that the equipment necessary to comply with these standards has been certified in accordance with paragraph (d)(1) of this section, the owner or operator shall submit annually to the Administrator a report that updates the information listed in paragraphs (a)(1) through (a)(3) of this section. If the information in the annual report required by paragraphs (a)(1) through (a)(3) of this section is not changed in the following year, the owner or operator may submit a statement to that effect.

(3) If an owner or operator elects to comply with the requirements of § 61.342(c)(3)(ii), then the report required by paragraph (d)(2) of this section shall include a table identifying each waste stream chosen for exemption and the total annual benzene quantity in these exempted streams.

(4) If an owner or operator elects to comply with the alternative requirements of § 61.342(d) of this subpart, then he shall include in the report required by paragraph (d)(2) of this section a table presenting the following information for each process wastewater stream:

(i) Whether or not the process wastewater stream is being controlled for benzene emissions in accordance with the requirements of this subpart;

(ii) For each process wastewater stream identified as not being controlled for benzene emissions in accordance with the requirements of this subpart, the table shall report the following information for the process wastewater stream as determined at the point of waste generation: annual waste quantity, range of benzene concentrations, annual average flow-weighted benzene concentration, and annual benzene quantity;

(iii) For each process wastewater stream identified as being controlled for benzene emissions in accordance with the requirements of this subpart, the table shall report the following information for the process wastewater stream as determined at the exit to the treatment process: Annual waste quantity, range of benzene concentrations, annual average flow-weighted benzene concentration, and annual benzene quantity.

(5) If an owner or operator elects to comply with the alternative requirements of § 61.342(e), then the report required by paragraph (d)(2) of this section shall include a table presenting the following information for each waste stream:

(i) For each waste stream identified as not being controlled for benzene emissions in accordance with the requirements of this subpart; the table shall report the following information for the waste stream as determined at the point of waste generation: annual waste quantity, range of benzene concentrations, annual average flow-weighted benzene concentration, and annual benzene quantity;

(ii) For each waste stream identified as being controlled for benzene emissions in accordance with the requirements of this subpart; the table shall report the following information for the waste stream as determined at the applicable location described in § 61.355(k)(2): Annual waste quantity, range of benzene concentrations, annual average flow-weighted benzene concentration, and annual benzene quantity.

(6) Beginning 3 months after the date that the equipment necessary to comply with these standards has been certified in accordance with paragraph (d)(1) of this section, the owner or operator shall submit quarterly to the Administrator a certification that all of the required inspections have been carried out in accordance with the requirements of this subpart.

(7) Beginning 3 months after the date that the equipment necessary to comply with these standards has been certified in accordance with paragraph (d)(1) of this section, the owner or operator shall submit a report quarterly to the Administrator that includes:

(i) If a treatment process or wastewater treatment system unit is monitored in accordance with § 61.354(a)(1) of this subpart, then each period of operation during which the concentration of benzene in the monitored waste stream exiting the unit is equal to or greater than 10 ppmw.

(ii) If a treatment process or wastewater treatment system unit is monitored in accordance with § 61.354(a)(2) of this subpart, then each 3-hour period of operation during which the average value of the monitored parameter is outside the range of acceptable values or during which the unit is not operating as designed.

(iii) If a treatment process or wastewater treatment system unit is monitored in accordance with § 61.354(b), then each period of operation during which the flow-weighted annual average concentration of benzene in the monitored waste stream entering the unit is equal to or greater than 10 ppmw and/or the total annual benzene quantity is equal to or greater than 1.0 mg/yr.

(iv) For a control device monitored in accordance with § 61.354(c) of this subpart, each period of operation monitored during which any of the following conditions occur, as applicable to the control device:

(A) Each 3-hour period of operation during which the average temperature of the gas stream in the combustion zone of a thermal vapor incinerator, as measured by the temperature monitoring device, is more than 28 °C (50 °F) below the design combustion zone temperature.

(B) Each 3-hour period of operation during which the average temperature of the gas stream immediately before the catalyst bed of a catalytic vapor incinerator, as measured by the temperature monitoring device, is more than 28 °C (50 °F) below the design gas stream temperature, and any 3-hour period during which the average temperature difference across the catalyst bed (i.e., the difference between the temperatures of the gas stream immediately before and after the catalyst bed), as measured by the temperature monitoring device, is less than 80 percent of the design temperature difference.

(C) Each 3-hour period of operation during which the average temperature of the gas stream in the combustion zone of a boiler or process heater having a design heat input capacity less than 44 MW (150 × 106 BTU/hr), as measured by the temperature monitoring device, is more than 28 °C (50 °F) below the design combustion zone temperature.

(D) Each 3-hour period of operation during which the average concentration of organics or the average concentration of benzene in the exhaust gases from a carbon adsorber, condenser, or other vapor recovery system is more than 20 percent greater than the design concentration level of organics or benzene in the exhaust gas.

(E) Each 3-hour period of operation during which the temperature of the condenser exhaust vent stream is more than 6 °C (11 °F) above the design average exhaust vent stream temperature, or the temperature of the coolant fluid exiting the condenser is more than 6 °C (11 °F) above the design average coolant fluid temperature at the condenser outlet.

(F) Each period in which the pilot flame of a flare is absent.

(G) Each occurrence when there is a change in the location at which the vent stream is introduced into the flame zone of a boiler or process heater as required by § 61.349(a)(2)(i)(C) of this subpart.

(H) Each occurrence when the carbon in a carbon adsorber system that is regenerated directly on site in the control device is not regenerated at the predetermined carbon bed regeneration time.

(I) Each occurrence when the carbon in a carbon adsorber system that is not regenerated directly on site in the control device is not replaced at the predetermined interval specified in § 61.354(c) of this subpart.

(J) Each 3-hour period of operation during which the parameters monitored are outside the range of values specified in § 61.349(a)(2)(iv)(C), or any other periods specified by the Administrator for a control device subject to the requirements of § 61.349(a)(2)(iv).

(v) For a cover and closed-vent system monitored in accordance with § 61.354(g), the owner or operator shall submit a report quarterly to the Administrator that identifies any period in which the pressure in the waste management unit is equal to or greater than atmospheric pressure.

(8) Beginning one year after the date that the equipment necessary to comply with these standards has been certified in accordance with paragraph (d)(1) of this section, the owner or operator shall submit annually to the Administrator a report that summarizes all inspections required by §§ 61.342 through 61.354 during which detectable emissions are measured or a problem (such as a broken seal, gap or other problem) that could result in benzene emissions is identified, including information about the repairs or corrective action taken.

(e) An owner or operator electing to comply with the provisions of §§ 61.351 or 61.352 of this subpart shall notify the Administrator of the alternative standard selected in the report required under § 61.07 or § 61.10 of this part.

(f) An owner or operator who elects to install and operate the control equipment in § 61.351 of this subpart shall comply with the reporting requirements in 40 CFR 60.115b.

(g) An owner or operator who elects to install and operate the control equipment in § 61.352 of this subpart shall submit initial and quarterly reports that identify all seal gap measurements, as required in 40 CFR 60.693-2(a), that are outside the prescribed limits.

[55 FR 8346, Mar. 7 1990; 55 FR 12444, Apr. 3, 1990, as amended at 55 FR 37231, Sept. 10, 1990; 58 FR 3105, Jan. 7, 1993; 65 FR 62161, Oct. 17, 2000]

§ 61.358 Delegation of authority.

(a) In delegating implementation and enforcement authority to a State under section 112(d) of the Clean Air Act, the authorities contained in paragraph (b) of this section shall be retained by the Administrator and not transferred to a State.

(b) Alternative means of emission limitation under § 61.353 of this subpart will not be delegated to States.

§ 61.359 [Reserved]

Appendix A to Part 61

APPENDIX A

National Emission Standards for Hazardous Air Pollutants
Compliance Status Information

I. SOURCE REPORT

INSTRUCTIONS: Owners or operators of sources of hazardous pollutants subject to the National Emission Standards for Hazardous Air Pollutants are required to submit the information contained in Section I to the appropriate U.S. Environmental Protection Agency Regional Office prior to 90 days after the effective date of any standards or amendments which require the submission of such information.

A list of regional offices is provided in 61.04.

A. SOURCE INFORMATION

1. Identification/Location - Indicate the name and address of each source.

1	2	3	4	5	8	9	13	14	16	17	18	19
Region	State	County	Source Number	NEQS X Ref.	NEQS X Ref.							
20	22	23	26	27	Source Name			46				
Dup 1-18				47	Street Address (Location of Plant)			66	80			
Dup 1-18		19	20	City Name			34	State	35	39		
Dup 1-18				40	State Regis. Number			54	55	58		
Dup 1-18				59	SIC	62	FF	8	77	79		
Dup 1-18				5	30	31	49	80				

2. Contact - Indicate the name and telephone number of the owner or operator or other responsible official whom EPA may contact concerning this report.

[View or download PDF](#)

Dup 1-18	4	1	19	20	21	Name			43					
Dup 1-18		44	46	47	Number	54	80							
Dup 1-18				3	Source Description - Briefly state the nature of the source (e.g., "Chlor-alkali Plant" or "Machine Shop").									
Dup 1-18	4	2	19	20	21	Description			50					
Dup 1-18				61	Continued			79	80					
Dup 1-18				4	3	13	20	21	Number	Street or Box Number	45	80		
Dup 1-18	4	4	19	20	21	City	35	State	37	38	41	Zip	44	80
Dup 1-18				5	Compliance Status - The emissions from this source can/cannot meet the emission limitations contained in the National Emission Standards on or prior to 90 days after the effective date of any standards or amendments which require the submission of such information.									

Signature of Owner, Operator or Other Responsible Official

NOTE: If the emissions from the source will exceed those limits set by the National Emission Standards for Hazardous Air Pollutants, the source will be in violation and subject to Federal enforcement actions unless granted a waiver of compliance by the Administrator of the U.S. Environmental Protection Agency. The information needed for such waivers is listed in Section II of this form.

B. PROCESS INFORMATION. Part B should be completed separately for each point of emission for each hazardous pollutant. [Sources subject to 61.22(1) may omit number 4. below.]

Dup 1-13	14	16	17	18	19	20	SCC	27	28	29	30	31
Dup 1-13				0	0	5	NEQS X Ref.			LS	SIP	

[View or download PDF](#)

1. **Pollutant Emitted** - Indicate the type of hazardous pollutant emitted by the process. Indicate "AS" for asbestos, "BE" for beryllium, or "HG" for mercury.

32	33	Pollutant		34	Regulation			48	49	50
								EC		

2. **Process Description** - Provide a brief description of each process (e.g., "hydrogen end box" in a mercury chlor-alkali plant, "grinding machine" in a beryllium machine shop). Use additional sheets if necessary.

50	Process Description			74	80
Dup 1-18 6 1 19 20 21 _____ 50					
51				79	80
Dup 1-18 6 2 19 20 21 _____ 50					
51				79	80

3. **Amount of Pollutant** - Indicate the average weight of the hazardous material named in Item 1 which enters the process in pounds per month (based on the previous twelve months of operation).

Dup 1-18	6 3	19	20	21	27	lbs./mo.	29	36	80
----------	-----	----	----	----	----	----------	----	----	----

4. **Control Devices**

a. Indicate the type of pollution control devices, if any, used to reduce the emissions from the process (e.g., venturi scrubber, baghouse, wet cyclone) and the estimated percent of the pollutant which the device removes from the process gas stream.

Dup 1-18	6 4	19	20	21	PRIMARY CONTROL DEVICE:			43		
45	Primary Device Name			64	66	70	Percent Removal Efficiency		72	79
									80	

[View or download PDF](#)

Dup 1-18	6 5	19	20	21	SECONDARY CONTROL DEVICES:			45			
47	Secondary Device Name			64	66	70	% EFFIC.		72	79	80

b. **Asbestos Emission Control Devices Only**
 1. If a baghouse is specified in Item 4a, give the following information:

- The air flow permeability in cubic feet per minute per square foot of fabric area.

Air flow permeability = _____ cfm/ft²

- The pressure drop in inches water gauge across the filter at which the baghouse is operated.

Operating pressure drop = _____ inches w.g.

- If the baghouse material contains synthetic fill yarn, check whether this material is / / spun / / or not spun.

- If the baghouse utilizes a felted fabric, give the minimum thickness in inches and the density in ounces per square yard.

Thickness = _____ inches Density = _____ oz/yd²

ii. If a wet collection device is specified in Item 4a, give the designed unit contacting energy in inches water gauge.

- Unit contacting energy = _____ inches w.g.

c. **DISPOSAL OF ASBESTOS-CONTAINING WASTES.** Part C should be completed separately for each asbestos-containing waste generation operation arising from sources subject to §61.22(a), (c), (e), and (h).

Dup 1-13	14	16	17	18	19	20	SCC	27	28	29	30	31
									NEDS X Ref		CS	SIP
A B	Pollutant		34	Regulation			48	49	EC			

[View or download PDF](#)

1. **Waste Generation** - Provide a brief description of each process that generates asbestos-containing waste (e.g. disposal of control device wastes).

50 _____ Process Description _____ 79 80

2. **Asbestos Concentration** - Indicate the average percentage asbestos content of these materials.

Dup 1-18 6 1 _____ ASBESTOS CONCENTRATION: _____ 43 45 _____ 48
19 20 21

50 80

3. **Amount of Wastes** - Indicate the average weight of asbestos-containing wastes disposed of, measured in kg/day.

Dup 1-18 6 2 _____ kg/day _____ 34 80
19 20 21 _____ 27 29

4. **Control Methods** - Indicate the emission control methods used in all stages of waste disposal, from collection, processing, and packaging to transporting and deposition.

Dup 1-18 6 3 _____ Primary Control Method _____ 43
19 20 21

45 _____ 79 80

Dup 1-18 6 4 _____ 50
19 20 21

51 _____ 79 80

5. **Waste Disposal** - Indicate the type of disposal site (sanitary landfill, open, covered) or incineration site (municipal, private) where the waste is disposed of and who operates the site (company, private, municipal). State the name and location of the site (closest city or town, county, state).

Dup 1-18 6 5 _____ TYPE OF SITE: _____ 33 35 _____ 50
19 20 21

51 _____ 79 80

[View or download PDF](#)

Dup 1-18 6 6 _____ OPERATOR: _____ 29 31 _____ 50
19 20 21

51 _____ 79 80

Dup 1-18 6 7 _____ LOCATION: _____ 29
19 20 21

31 _____ 70

71 _____ 79 80

D. **WASTE DISPOSAL SITES**. Part D should be completed separately for each asbestos waste disposal site subject to section 61.22(l).

Dup 1-13 14 16 0 0 5 _____ SEC _____ 27 28 29 30 31
17 18 19 20 NEDS X Ref CS 51P

A	B	Regulation	EC
32	33	48	79
Pollutant			EC

50 _____ WASTE DISPOSAL SITE _____ 68 80

1. **Description** - Provide a brief description of the site, including its size and configuration, and the distance to the closest city or town, closest residence, and closest primary road.

Dup 1-18 6 1 _____ SITE DESCRIPTION _____ 37 39 _____ 50
19 20 21

51 _____ 79 80

Dup 1-18 6 2 _____ DISTANCE: _____ TOWN: _____ K.M
19 20 21 _____ 29 30 34 36 _____ 40 42 43

45 _____ RESIDENCE: _____ K.M _____ ROAD: _____ 69 71 _____ 75
54 56 60 62 63 65

77 78 80

[View or download PDF](#)

2. **Inactivation** - After the site is inactivated, indicate the method or methods used to comply with the standard and send a list of the actions that will be undertaken to maintain the inactivated site.

Dup 1-18 6 8 _____ COMPLIANCE METHOD/INACTIVATION SITE: _____ 52
19 20 21

54 _____ 79 80

[View or download PDF](#)

II. WAIVER REQUESTS

A. Waiver of Compliance. Owners or operators of sources unable to operate in compliance with the National Emission Standards for Hazardous Air Pollutants prior to 90 days after the effective date of any standards or amendments which require the submission of such information may request a waiver of compliance from the Administrator of the U.S. Environmental Protection Agency for the time period necessary to install appropriate control devices or make modifications to achieve compliance. The Administrator may grant a waiver of compliance with the standard for a period not exceeding two years from the effective date of the hazardous pollutant standards, if he finds that such period is necessary for the installation of controls and that steps will be taken during the period of the waiver to assure that the health of persons will be protected from imminent endangerment.

The report information provided in Section I must accompany this application. Applications should be sent to the appropriate EPA regional office.

1. *Processes Involved* —Indicate the process or processes emitting hazardous pollutants to which emission controls are to be applied.

2. Controls

a. Describe the proposed type of control device to be added or modification to be made to the process to reduce the emission of hazardous pollutants to an acceptable level. (Use additional sheets if necessary.)

b. Describe the measures that will be taken during the waiver period to assure that the health of persons will be protected from imminent endangerment. (Use additional sheets if necessary.)

3. *Increments of Progress* —Specify the dates by which the following increments of progress will be met.

Date by which contracts for emission control systems or process modifications will be awarded; or date by which orders will be issued for the purchase of the component parts to accomplish emission control or process modification.

Dup 1-16	0 1 7	17	19	53	54	55	60	61	MO/DY/YR	66	80
	Date of initiation of on-site construction or installation of emission control equipment or process change.										
Dup 1-16	0 2 7	17	19	53	54	55	60	61	MO/DY/YR	66	80
	Date by which on-site construction or installation of emission control equipment or process modification is to be completed.										
Dup 1-16	0 3 7	17	19	53	54	55	60	61	MO/DY/YR	66	80
	Date by which final compliance is to be achieved.										
Dup 1-16	0 4 7	17	19	53	54	55	60	61	MO/DY/YR	66	80

[View or download PDF](#)

B. Waiver of Emission Tests. A waiver of emission testing may be granted to owners or operators of sources subject to emission testing if, in the judgment of the Administrator of the Environmental Protection Agency the emissions from the source comply with the appropriate standard or if the owners or operators of the source have requested a waiver of compliance or have been granted a waiver of compliance.

This application should accompany the report information provided in Section I.

1. *Reason* —State the reasons for requesting a waiver of emission testing. If the reason stated is that the emissions from the source are within the prescribed limits, documentation of this condition must be attached.

Date

Signature of the owner or operator

(Sec. 114, of the Clean Air Act as amended (42 U.S.C. 7414))

[40 FR 48303, Oct. 14, 1975, as amended at 43 FR 8800, Mar. 3, 1978; 50 FR 46295, Sept. 9, 1985]

Appendix B to Part 61—Test Methods

Method 101—Determination of particulate and gaseous mercury emissions from chlor-alkali plants (air streams)

Method 101A—Determination of particulate and gaseous mercury emissions from sewage sludge incinerators

Method 102—Determination of particulate and gaseous mercury emissions from chlor-alkali plants (hydrogen streams)

Method 103—Beryllium screening method

Method 104—Determination of beryllium emissions from stationary sources

Method 105—Determination of mercury in wastewater treatment plant sewage sludges

Method 106—Determination of vinyl chloride emissions from stationary sources

Method 107—Determination of vinyl chloride content of in-process wastewater samples, and vinyl chloride content of polyvinyl chloride resin slurry, wet cake, and latex samples

Method 107A—Determination of vinyl chloride content of solvents, resin-solvent solution, polyvinyl chloride resin, resin slurry, wet resin, and latex samples

Method 108—Determination of particulate and gaseous arsenic emissions

Method 108A—Determination of arsenic content in ore samples from nonferrous smelters

Method 108B—Determination of arsenic content in ore samples from nonferrous smelters

Method 108C—Determination of arsenic content in ore samples from nonferrous smelters (molybdenum blue photometric procedure)

Method 111—Determination of Polonium—210 emissions from stationary sources

METHOD 101—DETERMINATION OF PARTICULATE AND GASEOUS MERCURY EMISSIONS FROM CHLOR-ALKALI PLANTS (AIR STREAMS)

NOTE: This method does not include all of the specifications (e.g., equipment and supplies) and procedures (e.g., sampling and analytical) essential to its performance. Some material is incorporated by reference from methods in appendix A to 40 CFR part 60. Therefore, to obtain reliable results, persons using this method should have a thorough knowledge of at least the following additional test methods: Method 1, Method 2, Method 3, and Method 5.

1.0 Scope and Application

1.1 Analytes.

Analyte	CAS No.	Sensitivity
Mercury (Hg)	7439-97-6	Dependent upon recorder and spectrophotometer.

1.2 Applicability. This method is applicable for the determination of Hg emissions, including both particulate and gaseous Hg, from chlor-alkali plants and other sources (as specified in the regulations) where the carrier-gas stream in the duct or stack is principally air.

1.3 Data Quality Objectives. Adherence to the requirements of this method will enhance the quality of the data obtained from air pollutant sampling methods.

2.0 Summary of Method

Particulate and gaseous Hg emissions are withdrawn isokinetically from the source and collected in acidic iodine monochloride (ICl) solution. The Hg collected (in the mercuric form) is reduced to elemental Hg, which is then aerated from the solution into an optical cell and measured by atomic absorption spectrophotometry.

3.0 Definitions [Reserved]

4.0 Interferences

4.1 Sample Collection. Sulfur dioxide (SO₂) reduces ICl and causes premature depletion of the ICl solution.

4.2 Sample Analysis.

4.2.1 ICl concentrations greater than 10⁻⁴ molar inhibit the reduction of the Hg (II) ion in the aeration cell.

4.2.2 Condensation of water vapor on the optical cell windows causes a positive interference.

5.0 Safety

5.1 Disclaimer. This method may involve hazardous materials, operations, and equipment. This test method does not purport to address all of the safety problems associated with its use. It is the responsibility of the user of this test method to establish appropriate safety and health practices and determine the applicability of regulatory limitations prior to performing this test method.

5.2 Corrosive Reagents. The following reagents are hazardous. Personal protective equipment and safe procedures are useful in preventing chemical splashes. If contact occurs, immediately flush with copious amounts of water for at least 15 minutes. Remove clothing under shower and decontaminate. Treat residual chemical burn as thermal burn.

5.2.1 Hydrochloric Acid (HCl). Highly toxic and corrosive. Causes severe damage to tissues. Vapors are highly irritating to eyes, skin, nose, and lungs, causing severe damage. May cause bronchitis, pneumonia, or edema of lungs. Exposure to concentrations of 0.13 to 0.2 percent can be lethal to humans in a few minutes. Provide ventilation to limit exposure. Reacts with metals, producing hydrogen gas.

5.2.2 Nitric Acid (HNO₃). Highly corrosive to eyes, skin, nose, and lungs. Vapors cause bronchitis, pneumonia, or edema of lungs. Reaction to inhalation may be delayed as long as 30 hours and still be fatal. Provide ventilation to limit exposure. Strong oxidizer. Hazardous reaction may occur with organic materials such as solvents.

5.2.3 Sulfuric Acid (H₂SO₄). Rapidly destructive to body tissue. Will cause third degree burns. Eye damage may result in blindness. Inhalation may be fatal from spasm of the larynx, usually within 30 minutes. 3 mg/m³ will cause lung damage. 1 mg/m³ for 8 hours will cause lung damage or, in

higher concentrations, death. Provide ventilation to limit inhalation. Reacts violently with metals and organics.

6.0 *Equipment and Supplies.*

6.1 **Sample Collection.** A schematic of the sampling train used in performing this method is shown in Figure 101-1; it is similar to the Method 5 sampling train. The following items are required for sample collection:

6.1.1 **Probe Nozzle, Pitot Tube, Differential Pressure Gauge, Metering System, Barometer, and Gas Density Determination Equipment.** Same as Method 5, Sections 6.1.1.1, 6.1.1.3, 6.1.1.4, 6.1.1.9, 6.1.2, and 6.1.3, respectively.

6.1.2 **Probe Liner.** Borosilicate or quartz glass tubing. A heating system capable of maintaining a gas temperature of 120 ± 14 °C (248 ± 25 °F) at the probe exit during sampling may be used to prevent water condensation.

NOTE: Do not use metal probe liners.

6.1.3 **Impingers.** Four Greenburg-Smith impingers connected in series with leak-free ground glass fittings or any similar leak-free noncontaminating fittings. For the first, third, and fourth impingers, impingers that are modified by replacing the tip with a 13-mm ID (0.5-in.) glass tube extending to 13 mm (0.5 in.) from the bottom of the flask may be used.

6.1.4 **Acid Trap.** Mine Safety Appliances air line filter, Catalog number 81857, with acid absorbing cartridge and suitable connections, or equivalent.

6.2 **Sample Recovery.** The following items are needed for sample recovery:

6.2.1 **Glass Sample Bottles.** Leakless, with Teflon-lined caps, 1000- and 100-ml.

6.2.2 **Graduated Cylinder.** 250-ml.

6.2.3 **Funnel and Rubber Policeman.** To aid in transfer of silica gel to container; not necessary if silica gel is weighed in the field.

6.2.4 **Funnel.** Glass, to aid in sample recovery.

6.3 **Sample Preparation and Analysis.** The following items are needed for sample preparation and analysis:

6.3.1 **Atomic Absorption Spectrophotometer.** Perkin-Elmer 303, or equivalent, containing a hollow-cathode mercury lamp and the optical cell described in Section 6.3.2.

6.3.2 **Optical Cell.** Cylindrical shape with quartz end windows and having the dimensions shown in Figure 101-2. Wind the cell with approximately 2 meters (6 ft) of 24-gauge Nichrome wire, or equivalent, and wrap with fiberglass insulation tape, or equivalent; do not let the wires touch each other.

6.3.3 **Aeration Cell.** Constructed according to the specifications in Figure 101-3. Do not use a glass frit as a substitute for the blown glass bubbler tip shown in Figure 101-3.

6.3.4 **Recorder.** Matched to output of the spectrophotometer described in Section 6.3.1.

6.3.5 **Variable Transformer.** To vary the voltage on the optical cell from 0 to 40 volts.

6.3.6 **Hood.** For venting optical cell exhaust.

6.3.7 **Flow Metering Valve.**

6.3.8 Rate Meter. Rotameter, or equivalent, capable of measuring to within 2 percent a gas flow of 1.5 liters/min (0.053 cfm).

6.3.9 Aeration Gas Cylinder. Nitrogen or dry, Hg-free air, equipped with a single-stage regulator.

6.3.10 Tubing. For making connections. Use glass tubing (ungreased ball and socket connections are recommended) for all tubing connections between the solution cell and the optical cell; do not use Tygon tubing, other types of flexible tubing, or metal tubing as substitutes. Teflon, steel, or copper tubing may be used between the nitrogen tank and flow metering valve (Section 6.3.7), and Tygon, gum, or rubber tubing between the flow metering valve and the aeration cell.

6.3.11 Flow Rate Calibration Equipment. Bubble flow meter or wet-test meter for measuring a gas flow rate of 1.5 ± 0.1 liters/min (0.053 ± 0.0035 cfm).

6.3.12 Volumetric Flasks. Class A with penny head standard taper stoppers; 100-, 250-, 500-, and 1000-ml.

6.3.13 Volumetric Pipets. Class A; 1-, 2-, 3-, 4-, and 5-ml.

6.3.14 Graduated Cylinder. 50-ml.

6.3.15 Magnetic Stirrer. General-purpose laboratory type.

6.3.16 Magnetic Stirring Bar. Teflon-coated.

6.3.17 Balance. Capable of weighing to ± 0.5 g.

6.3.18 Alternative Analytical Apparatus. Alternative systems are allowable as long as they meet the following criteria:

6.3.18.1 A linear calibration curve is generated and two consecutive samples of the same aliquot size and concentration agree within 3 percent of their average.

6.3.18.2 A minimum of 95 percent of the spike is recovered when an aliquot of a source sample is spiked with a known concentration of Hg (II) compound.

6.3.18.3 The reducing agent should be added after the aeration cell is closed.

6.3.18.4 The aeration bottle bubbler should not contain a frit.

6.3.18.5 Any Tygon tubing used should be as short as possible and conditioned prior to use until blanks and standards yield linear and reproducible results.

6.3.18.6 If manual stirring is done before aeration, it should be done with the aeration cell closed.

6.3.18.7 A drying tube should not be used unless it is conditioned as the Tygon tubing above.

7.0 Reagents and Standards

Unless otherwise indicated, all reagents must conform to the specifications established by the Committee on Analytical Reagents of the American Chemical Society; where such specifications are not available, use the best available grade.

7.1 Sample Collection. The following reagents are required for sample collection:

7.1.1 Water. Deionized distilled, to conform to ASTM D 1193-77 or 91 (incorporated by reference—see § 61.18), Type 1. If high concentrations of organic matter are not expected to be present, the analyst may eliminate the KMnO_4 test for oxidizable organic matter. Use this water in all dilutions and solution preparations.

7.1.2 Nitric Acid, 50 Percent (v/v). Mix equal volumes of concentrated HNO₃ and water, being careful to add the acid to the water slowly.

7.1.3 Silica Gel. Indicating type, 6- to 16-mesh. If previously used, dry at 175 °C (350 °F) for 2 hours. The tester may use new silica gel as received.

7.1.4 Potassium Iodide (KI) Solution, 25 Percent. Dissolve 250 g of KI in water, and dilute to 1 liter.

7.1.5 Iodine Monochloride Stock Solution, 1.0 M. To 800 ml of 25 percent KI solution, add 800 ml of concentrated HCl. Cool to room temperature. With vigorous stirring, slowly add 135 g of potassium iodate (KIO₃), and stir until all free iodine has dissolved. A clear orange-red solution occurs when all the KIO₃ has been added. Cool to room temperature, and dilute to 1800 ml with water. Keep the solution in amber glass bottles to prevent degradation.

7.1.6 Absorbing Solution, 0.1 M ICl. Dilute 100 ml of the 1.0 M ICl stock solution to 1 liter with water. Keep the solution in amber glass bottles and in darkness to prevent degradation. This reagent is stable for at least two months.

7.2 Sample Preparation and Analysis. The following reagents and standards are required for sample preparation and analysis:

7.2.1 Reagents.

7.2.1.1 Tin (II) Solution. Prepare fresh daily, and keep sealed when not being used. Completely dissolve 20 g of tin (II) chloride (or 25 g of tin (II) sulfate) crystals (Baker Analyzed reagent grade or any other brand that will give a clear solution) in 25 ml of concentrated HCl. Dilute to 250 ml with water. Do not substitute HNO₃, H₂SO₄, or other strong acids for the HCl.

7.2.1.2 Sulfuric Acid, 5 Percent (v/v). Dilute 25 ml of concentrated H₂SO₄ to 500 ml with water.

7.2.2 Standards

7.2.2.1 Hg Stock Solution, 1 mg Hg/ml. Prepare and store all Hg standard solutions in borosilicate glass containers. Completely dissolve 0.1354 g of Hg (II) chloride in 75 ml of water in a 100-ml glass volumetric flask. Add 10 ml of concentrated HNO₃, and adjust the volume to exactly 100 ml with water. Mix thoroughly. This solution is stable for at least one month.

7.2.2.2 Intermediate Hg Standard Solution, 10 µg Hg/ml. Prepare fresh weekly. Pipet 5.0 ml of the Hg stock solution (Section 7.2.2.1) into a 500-ml glass volumetric flask, and add 20 ml of the 5 percent H₂SO₄ solution. Dilute to exactly 500 ml with water. Thoroughly mix the solution.

7.2.2.3 Working Hg Standard Solution, 200 ng Hg/ml. Prepare fresh daily. Pipet 5.0 ml of the intermediate Hg standard solution (Section 7.2.2.2) into a 250-ml volumetric glass flask. Add 10 ml of the 5 percent H₂SO₄ and 2 ml of the 0.1 M ICl absorbing solution taken as a blank (Section 8.7.4.3), and dilute to 250 ml with water. Mix thoroughly.

8.0 Sample Collection, Preservation, Transport, and Storage

Because of the complexity of this method, testers should be trained and experienced with the test procedures to ensure reliable results. Since the amount of Hg that is collected generally is small, the method must be carefully applied to prevent contamination or loss of sample.

8.1 Pretest Preparation. Follow the general procedure outlined in Method 5, Section 8.1, except omit Sections 8.1.2 and 8.1.3.

8.2 Preliminary Determinations. Follow the general procedure outlined in Method 5, Section 8.2, with the exception of the following:

8.2.1 Select a nozzle size based on the range of velocity heads to assure that it is not necessary to change the nozzle size in order to maintain isokinetic sampling rates below 28 liters/min (1.0 cfm).

8.2.2 Perform test runs such that samples are obtained over a period or periods that accurately determine the maximum emissions that occur in a 24-hour period. In the case of cyclic operations, run sufficient tests for the accurate determination of the emissions that occur over the duration of the cycle. A minimum sample time of 2 hours is recommended. In some instances, high Hg or high SO₂ concentrations make it impossible to sample for the desired minimum time. This is indicated by reddening (liberation of free iodine) in the first impinger. In these cases, the sample run may be divided into two or more subruns to ensure that the absorbing solution is not depleted.

8.3 Preparation of Sampling Train.

8.3.1 Clean all glassware (probe, impingers, and connectors) by rinsing with 50 percent HNO₃, tap water, 0.1 M ICI, tap water, and finally deionized distilled water. Place 100 ml of 0.1 M ICI in each of the first three impingers. Take care to prevent the absorbing solution from contacting any greased surfaces. Place approximately 200 g of preweighed silica gel in the fourth impinger. More silica gel may be used, but care should be taken to ensure that it is not entrained and carried out from the impinger during sampling. Place the silica gel container in a clean place for later use in the sample recovery. Alternatively, determine and record the weight of the silica gel plus impinger to the nearest 0.5 g.

8.3.2 Install the selected nozzle using a Viton A O-ring when stack temperatures are less than 260 °C (500 °F). Use a fiberglass string gasket if temperatures are higher. See APTD-0576 (Reference 3 in Method 5) for details. Other connecting systems using either 316 stainless steel or Teflon ferrules may be used. Mark the probe with heat-resistant tape or by some other method to denote the proper distance into the stack or duct for each sampling point.

8.3.3 Assemble the train as shown in Figure 101-1, using (if necessary) a very light coat of silicone grease on all ground glass joints. Grease only the outer portion (see APTD-0576) to avoid the possibility of contamination by the silicone grease.

NOTE: An empty impinger may be inserted between the third impinger and the silica gel to remove excess moisture from the sample stream.

8.3.4 After the sampling train has been assembled, turn on and set the probe heating system, if applicable, at the desired operating temperature. Allow time for the temperatures to stabilize. Place crushed ice around the impingers.

8.4 Leak-Check Procedures. Follow the leak-check procedures outlined in Method 5, Section 8.4.

8.5 Sampling Train Operation. Follow the general procedure outlined in Method 5, Section 8.5. For each run, record the data required on a data sheet such as the one shown in Figure 101-4.

8.6 Calculation of Percent Isokinetic. Same as Method 5, Section 8.6.

8.7 Sample Recovery. Begin proper cleanup procedure as soon as the probe is removed from the stack at the end of the sampling period.

8.7.1 Allow the probe to cool. When it can be safely handled, wipe off any external particulate matter near the tip of the probe nozzle, and place a cap over it. Do not cap off the probe tip tightly while the sampling train is cooling. Capping would create a vacuum and draw liquid out from the impingers.

8.7.2 Before moving the sampling train to the cleanup site, remove the probe from the train, wipe off the silicone grease, and cap the open outlet of the probe. Be careful not to lose any condensate that might be present. Wipe off the silicone grease from the impinger. Use either ground-glass stoppers, plastic caps, or serum caps to close these openings.

8.7.3 Transfer the probe and impinger assembly to a cleanup area that is clean, protected from the wind, and free of Hg contamination. The ambient air in laboratories located in the immediate vicinity of Hg-using facilities is not normally free of Hg contamination.

8.7.4 Inspect the train before and during disassembly, and note any abnormal conditions. Treat the samples as follows.

8.7.4.1 Container No. 1 (Impingers and Probe).

8.7.4.1.1 Using a graduated cylinder, measure the liquid in the first three impingers to within 1 ml. Record the volume of liquid present (e.g., see Figure 5-6 of Method 5). This information is needed to calculate the moisture content of the effluent gas. (Use only glass storage bottles and graduated cylinders that have been precleaned as in Section 8.3.1) Place the contents of the first three impingers into a 1000-ml glass sample bottle.

8.7.4.1.2 Taking care that dust on the outside of the probe or other exterior surfaces does not get into the sample, quantitatively recover the Hg (and any condensate) from the probe nozzle, probe fitting, and probe liner as follows: Rinse these components with two 50-ml portions of 0.1 M ICI. Next, rinse the probe nozzle, fitting and liner, and each piece of connecting glassware between the probe liner and the back half of the third impinger with a maximum of 400 ml of water. Add all washings to the 1000-ml glass sample bottle containing the liquid from the first three impingers.

8.7.4.1.3 After all washings have been collected in the sample container, tighten the lid on the container to prevent leakage during shipment to the laboratory. Mark the height of the liquid to determine later whether leakage occurred during transport. Label the container to identify clearly its contents.

8.7.4.2 Container No. 2 (Silica Gel). Same as Method 5, Section 8.7.6.3.

8.7.4.3 Container No. 3 (Absorbing Solution Blank). Place 50 ml of the 0.1 M ICI absorbing solution in a 100-ml sample bottle. Seal the container. Use this blank to prepare the working Hg standard solution (Section 7.2.2.3).

9.0 Quality Control

9.1 Miscellaneous Quality Control Measures.

Section	Quality control measure	Effect
8.4 10.2	Sampling equipment leak-checks and calibration	Ensure accuracy and precision of sampling measurements.
10.5, 10.6	Spectrophotometer calibration	Ensure linearity of spectrophotometer response to standards.
11.3.3	Check for matrix effects	Eliminate matrix effects.

9.2 Volume Metering System Checks. Same as Method 5, Section 9.2.

10.0 Calibration and Standardizations

NOTE: Maintain a laboratory log of all calibrations.

10.1 Before use, clean all glassware, both new and used, as follows: brush with soap and tap water, liberally rinse with tap water, soak for 1 hour in 50 percent HNO₃, and then rinse with deionized distilled water.

10.2 Sampling Equipment. Calibrate the sampling equipment according to the procedures outlined in the following sections of Method 5: Section 10.1 (Probe Nozzle), Section 10.2 (Pitot Tube Assembly), Section 10.3 (Metering System), Section 10.5 (Temperature Sensors), Section 10.6 (Barometer).

10.3 Aeration System Flow Rate Meter. Assemble the aeration system as shown in Figure 101-5. Set the outlet pressure on the aeration gas cylinder regulator to a minimum pressure of 500 mm Hg (10 psi), and use the flow metering valve and a bubble flowmeter or wet-test meter to obtain a flow rate of 1.5 ± 0.1 liters/min (0.053 ± 0.0035 cfm) through the aeration cell. After the calibration of the aeration system flow rate meter is complete, remove the bubble flowmeter from the system.

10.4 Optical Cell Heating System. Using a 50-ml graduated cylinder, add 50 ml of water to the bottle section of the aeration cell, and attach the bottle section to the bubbler section of the cell. Attach the aeration cell to the optical cell and while aerating at 1.5 ± 0.1 liters/min (0.053 ± 0.0035 cfm), determine the minimum variable transformer setting necessary to prevent condensation of moisture in the optical cell and in the connecting tubing. (This setting should not exceed 20 volts.)

10.5 Spectrophotometer and Recorder.

10.5.1 The Hg response may be measured by either peak height or peak area.

NOTE: The temperature of the solution affects the rate at which elemental Hg is released from a solution and, consequently, it affects the shape of the absorption curve (area) and the point of maximum absorbance (peak height). Therefore, to obtain reproducible results, bring all solutions to room temperature before use.

10.5.2 Set the spectrophotometer wavelength at 253.7 nm, and make certain the optical cell is at the minimum temperature that will prevent water condensation. Then set the recorder scale as follows: Using a 50-ml graduated cylinder, add 50 ml of water to the aeration cell bottle. Add three drops of Antifoam B to the bottle, and then pipet 5.0 ml of the working Hg standard solution into the aeration cell.

NOTE: Always add the Hg-containing solution to the aeration cell after the 50 ml of water.

10.5.3 Place a Teflon-coated stirring bar in the bottle. Before attaching the bottle section to the bubbler section of the aeration cell, make certain that (1) the aeration cell exit arm stopcock (Figure 101-3) is closed (so that Hg will not prematurely enter the optical cell when the reducing agent is being added) and (2) there is no flow through the bubbler. If conditions (1) and (2) are met, attach the bottle section to the bubbler section of the aeration cell. Pipet 5 ml of tin (II) reducing solution into the aeration cell through the side arm, and immediately stopper the side arm. Stir the solution for 15 seconds, turn on the recorder, open the aeration cell exit arm stopcock, and immediately initiate aeration with continued stirring. Determine the maximum absorbance of the standard, and set this value to read 90 percent of the recorder full scale.

10.6 Calibration Curve.

10.6.1 After setting the recorder scale, repeat the procedure in Section 10.5 using 0.0-, 1.0-, 2.0-, 3.0-, 4.0-, and 5.0-ml aliquots of the working standard solution (final amount of Hg in the aeration cell is 0, 200, 400, 600, 800, and 1000 ng, respectively). Repeat this procedure on each aliquot size until two consecutive peaks agree within 3 percent of their average value.

NOTE: To prevent Hg carryover from one sample to another, do not close the aeration cell from the optical cell until the recorder pen has returned to the baseline.)

10.6.2 It should not be necessary to disconnect the aeration gas inlet line from the aeration cell when changing samples. After separating the bottle and bubbler sections of the aeration cell, place the bubbler section into a 600-ml beaker containing approximately 400 ml of water. Rinse the bottle section of the aeration cell with a stream of water to remove all traces of the tin (II) reducing agent. Also, to prevent the loss of Hg before aeration, remove all traces of the reducing agent between samples by washing with water. It will be necessary, however, to wash the aeration cell parts with concentrated HCl if any of the following conditions occur: (1) A white film appears on any inside surface of the aeration cell, (2) the calibration curve changes suddenly, or (3) the replicate samples do not yield reproducible results.

10.6.3 Subtract the average peak height (or peak area) of the blank (0.0-ml aliquot)—which must be less than 2 percent of recorder full scale—from the averaged peak heights of the 1.0-, 2.0-, 3.0-,

4.0-, and 5.0-ml aliquot standards. If the blank absorbance is greater than 2 percent of full-scale, the probable cause is Hg contamination of a reagent or carry-over of Hg from a previous sample. Prepare the calibration curve by plotting the corrected peak height of each standard solution versus the corresponding final total Hg weight in the aeration cell (in ng), and draw the best fit straight line. This line should either pass through the origin or pass through a point no further from the origin than ± 2 percent of the recorder full scale. If the line does not pass through or very near to the origin, check for nonlinearity of the curve and for incorrectly prepared standards.

11.0 Analytical Procedure

11.1 Sample Loss Check. Check the liquid level in each container to see whether liquid was lost during transport. If a noticeable amount of leakage occurred, either void the sample or use methods subject to the approval of the Administrator to account for the losses.

11.2 Sample Preparation. Treat each sample as follows:

11.2.1 Container No. 1 (Impingers and Probe). Carefully transfer the contents of Container No. 1 into a 1000-ml volumetric flask, and adjust the volume to exactly 1000 ml with water.

11.2.2 Dilutions. Pipet a 2-ml aliquot from the diluted sample from Section 11.2.1 into a 250-ml volumetric flask. Add 10 ml of 5 percent H_2SO_4 , and adjust the volume to exactly 250 ml with water. This solution is stable for at least 72 hours.

NOTE: The dilution factor will be 250/2 for this solution.

11.3 Analysis. Calibrate the analytical equipment and develop a calibration curve as outlined in Sections 10.3 through 10.6.

11.3.1 Mercury Samples. Repeat the procedure used to establish the calibration curve with an appropriately sized aliquot (1 to 5 ml) of the diluted sample (from Section 11.2.2) until two consecutive peak heights agree within 3 percent of their average value. The peak maximum of an aliquot (except the 5-ml aliquot) must be greater than 10 percent of the recorder full scale. If the peak maximum of a 1.0-ml aliquot is off scale on the recorder, further dilute the original source sample to bring the Hg concentration into the calibration range of the spectrophotometer.

11.3.2 Run a blank and standard at least after every five samples to check the spectrophotometer calibration. The peak height of the blank must pass through a point no further from the origin than ± 2 percent of the recorder full scale. The difference between the measured concentration of the standard (the product of the corrected peak height and the reciprocal of the least squares slope) and the actual concentration of the standard must be less than 7 percent, or recalibration of the analyzer is required.

11.3.3 Check for Matrix Effects (optional). Use the Method of Standard Additions as follows to check at least one sample from each source for matrix effects on the Hg results. The Method of Standard Additions procedures described on pages 9-4 and 9-5 of the section entitled "General Information" of the Perkin Elmer Corporation Atomic Absorption Spectrophotometry Manual, Number 303-0152 (Reference 16 in Section 16.0) are recommended. If the results of the Method of Standard Additions procedure used on the single source sample do not agree to within ± 5 percent of the value obtained by the routine atomic absorption analysis, then reanalyze all samples from the source using the Method of Standard Additions procedure.

11.4 Container No. 2 (Silica Gel). Weigh the spent silica gel (or silica gel plus impinger) to the nearest 0.5 g using a balance. (This step may be conducted in the field.)

12.0 Data Analysis and Calculations

Carry out calculations, retaining at least one extra decimal significant figure beyond that of the acquired data. Round off figures only after the final calculation. Other forms of the equations may be used as long as they give equivalent results.

12.1 Average Dry Gas Meter Temperature and Average Orifice Pressure Drop, Dry Gas Volume, Volume of Water Vapor Condensed, Moisture Content, and Isokinetic Variation. Same as Method 5, Sections 12.2 through 12.5 and 12.11, respectively.

12.2 Stack Gas Velocity. Using the data from this test and Equation 2-9 of Method 2, calculate the average stack gas velocity v_s .

12.3 Total Mercury.

12.3.1 For each source sample, correct the average maximum absorbance of the two consecutive samples whose peak heights agree within 3 percent of their average for the contribution of the solution blank (see Section 10.6.3). Use the calibration curve and these corrected averages to determine the final total weight of Hg in ng in the aeration cell for each source sample.

12.3.2 Correct for any dilutions made to bring the sample into the working range of the spectrophotometer. Then calculate the Hg in the original solution, m_{Hg} , as follows:

$$m_{\text{Hg}} = \left[C_{\text{Hg(AC)}} (DF) (V_f) (10^{-3}) \right] / S \quad \text{Eq. 101-1}$$

Where:

$C_{\text{Hg(AC)}}$ = Total ng of Hg in aliquot analyzed (reagent blank subtracted).

DF = Dilution factor for the Hg-containing solution (before adding to the aeration cell; e.g., DF = 250/2 if the source samples were diluted as described in Section 11.2.2).

V_f = Solution volume of original sample, 1000 ml for samples diluted as described in Section 11.2.1.

10^{-3} = Conversion factor, $\mu\text{g}/\text{ng}$.

S = Aliquot volume added to aeration cell, ml.

12.4 Mercury Emission Rate. Calculate the daily Hg emission rate, R, using Equation 101-2. For continuous operations, the operating time is equal to 86,400 seconds per day. For cyclic operations, use only the time per day each stack is in operation. The total Hg emission rate from a source will be the summation of results from all stacks.

$$R = \frac{K m_{\text{Hg}} V_s A_s (86,400 \times 10^{-6})}{\left[V_{\text{m(std)}} + V_{\text{w(std)}} \right] (T_s / P_s)} \quad \text{Eq. 101-2}$$

Where:

K_1 = 0.3858 °K/mm Hg for metric units.

K_1 = 17.64 °R/in. Hg for English units.

K_3 = 10^{-6} g/ μg for metric units.

= 2.2046 " $\times 10^{-9}$ lb/ μg for English units.

P_s = Absolute stack gas pressure, mm Hg (in. Hg).

t = Daily operating time, sec/day.

T_s = Absolute average stack gas temperature, °K (°R).

$V_{\text{m(std)}}$ = Dry gas sample volume at standard conditions, scm (scf).

$V_{w(\text{std})}$ = Volume of water vapor at standard conditions, scm (scf).

12.5 Determination of Compliance. Each performance test consists of three repetitions of the applicable test method. For the purpose of determining compliance with an applicable national emission standard, use the average of the results of all repetitions.

13.0 Method Performance

The following estimates are based on collaborative tests, wherein 13 laboratories performed duplicate analyses on two Hg-containing samples from a chlor-alkali plant and on one laboratory-prepared sample of known Hg concentration. The sample concentrations ranged from 2 to 65 µg Hg/ml.

13.1 Precision. The estimated intra-laboratory and inter-laboratory standard deviations are 1.6 and 1.8 µg Hg/ml, respectively.

13.2 Accuracy. The participating laboratories that analyzed a 64.3 µg Hg/ml (in 0.1 M ICI) standard obtained a mean of 63.7 µg Hg/ml.

13.3 Analytical Range. After initial dilution, the range of this method is 0.5 to 120 µg Hg/ml. The upper limit can be extended by further dilution of the sample.

14.0 Pollution Prevention. [Reserved]

15.0 Waste Management. [Reserved]

16.0 References

Same as Method 5, Section 17.0, References 1-3, 5, and 6, with the addition of the following:

1. Determining Dust Concentration in a Gas Stream. ASME Performance Test Code No. 27. New York, NY. 1957.
2. DeVorkin, Howard, *et al.* Air Pollution Source Testing Manual. Air Pollution Control District. Los Angeles, CA. November 1963.
3. Hatch, W.R., and W.I. Ott. Determination of Sub-Microgram Quantities of Mercury by Atomic Absorption Spectrophotometry. *Anal. Chem.* 40:2085-87. 1968.
4. Mark, L.S. Mechanical Engineers' Handbook. McGraw-Hill Book Co., Inc. New York, NY. 1951.
5. Western Precipitation Division of Joy Manufacturing Co. Methods for Determination of Velocity, Volume, Dust and Mist Content of Gases. Bulletin WP-50. Los Angeles, CA. 1968.
6. Perry, J.H. Chemical Engineers' Handbook. McGraw-Hill Book Co., Inc. New York, NY. 1960.
7. Shigehara, R.T., W.F. Todd, and W.S. Smith. Significance of Errors in Stack Sampling Measurements. *Stack Sampling News.* 1 (3):6-18. September 1973.
8. Smith, W.S., R.T. Shigehara, and W.F. Todd. A Method of Interpreting Stack Sampling Data. *Stack Sampling News.* 1 (2):8-17. August 1973.
9. Standard Method for Sampling Stacks for Particulate Matter. In: 1971 Annual Book of ASTM Standards, Part 23. ASTM Designation D 2928-71. Philadelphia, PA 1971.
10. Vennard, J.K. Elementary Fluid Mechanics. John Wiley and Sons, Inc. New York. 1947.
11. Mitchell, W.J. and M.R. Midgett. Improved Procedure for Determining Mercury Emissions from Mercury Cell Chlor-Alkali Plants. *J. APCA.* 26 :674-677. July 1976.

12. Shigehara, R.T. Adjustments in the EPA Nomograph for Different Pitot Tube Coefficients and Dry Molecular Weights. *Stack Sampling News*. 2 :4-11. October 1974.

13. Vollaro, R.F. Recommended Procedure for Sample Traverses in Ducts Smaller than 12 Inches in Diameter. U.S. Environmental Protection Agency, Emission Measurement Branch. Research Triangle Park, NC. November 1976.

14. Klein, R. and C. Hach. Standard Additions: Uses and Limitation in Spectrophotometric Measurements. *Amer. Lab.* 9 :21. 1977.

15. Perkin Elmer Corporation. Analytical Methods for Atomic Absorption Spectrophotometry. Norwalk, Connecticut. September 1976.

17.0 Tables, Diagrams, Flowcharts, and Validation Data

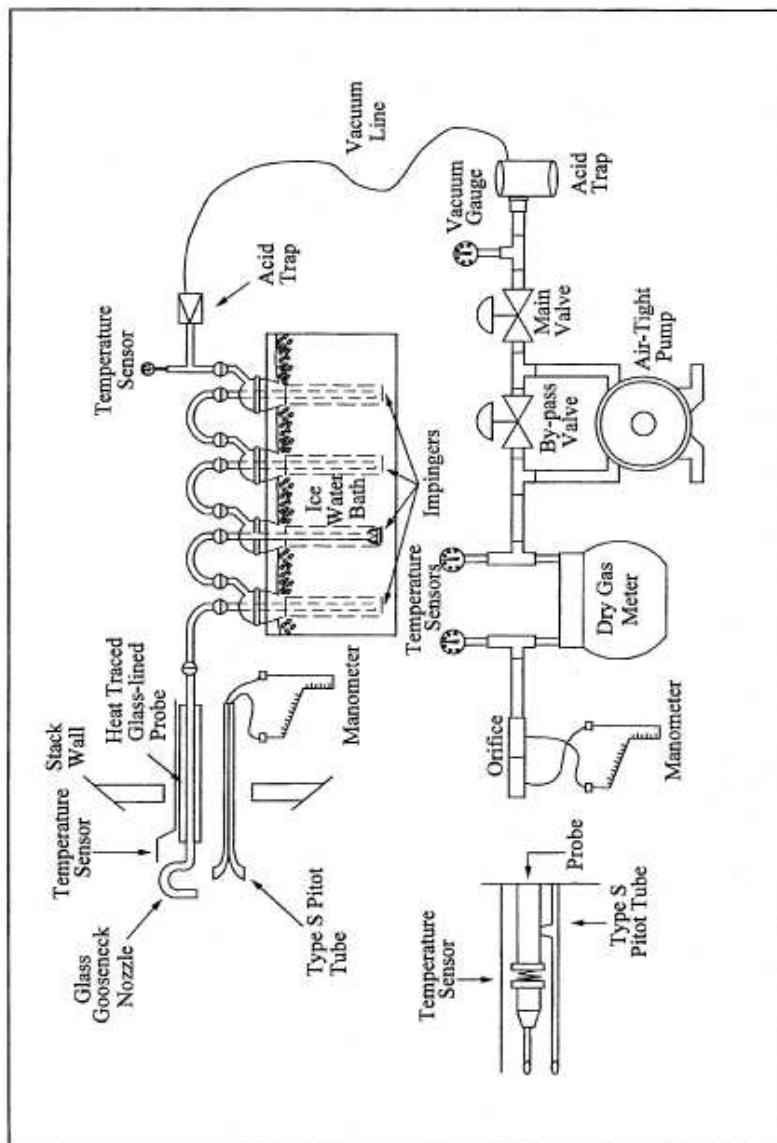

Figure 101-1. Mercury Sampling Train.

[View or download PDF](#)

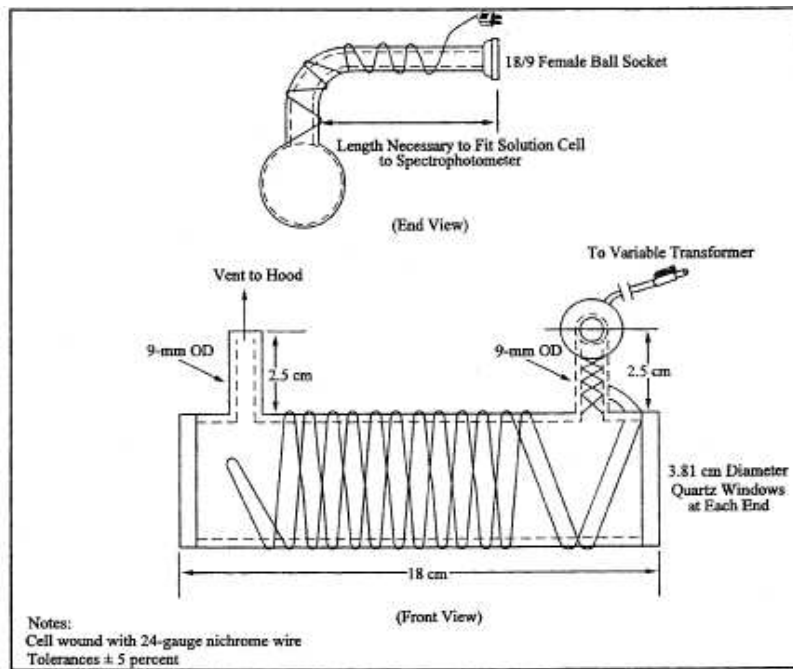

Figure 101-2. Optical Cell.

[View or download PDF](#)

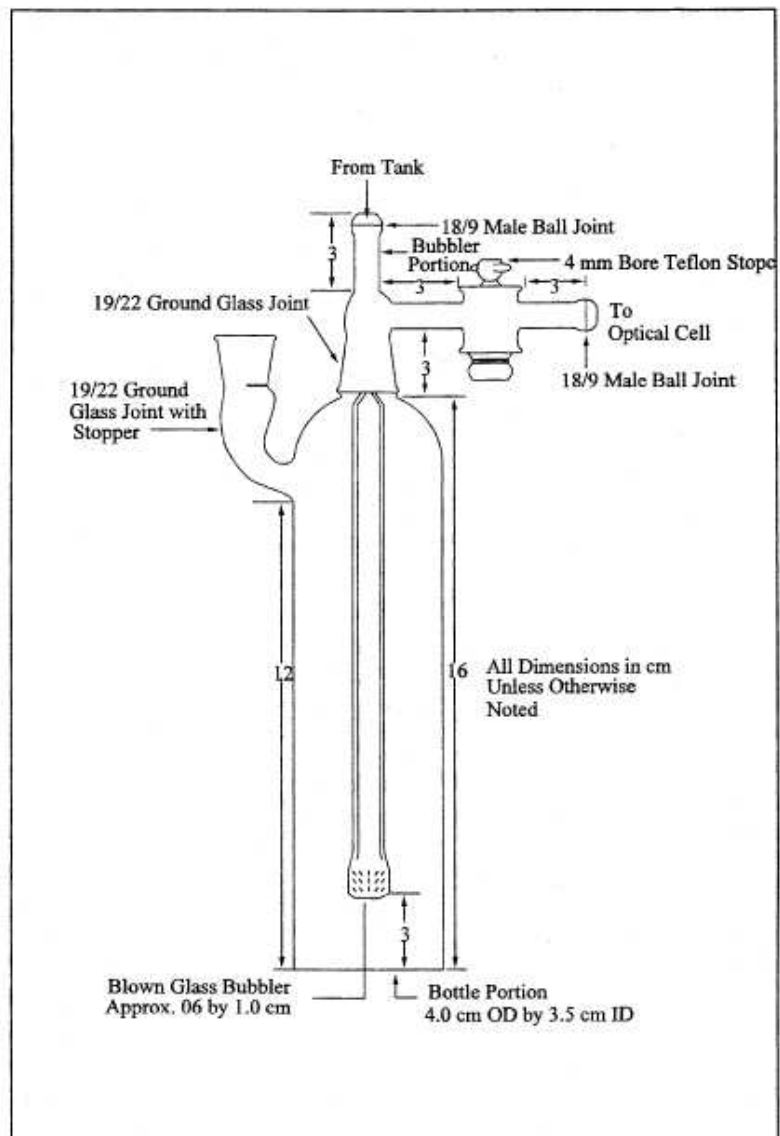

Figure 101-3. Aeration Cell.

[View or download PDF](#)

Plant _____ Location _____ Operator _____ Date _____ Run No. _____ Sample box No. _____ Filter box No. _____ Meter Hg _____ C factor _____ Pitot tube coefficient, C_p _____	Ambient temperature _____ Barometric pressure _____ Assumed moisture, % _____ Probe length, (ft.) _____ Nozzle identification No. _____ Average calibrated nozzle diameter, (in.) _____ Probe heater setting _____ Leak rate, (cfm) _____ Probe liner material _____ Static pressure, (in. Hg) _____ Filter No. _____	SCHEMATIC OF STACK CROSS SECTION 	Gas meter reading _____ (ft ³) Pressure differential across orifice meter _____ (in. H ₂ O) Velocity head _____ (ft H ₂ O) Stack temperature _____ (°F) Vacuum _____ (in. Hg) Sampling time _____ min.	Gas sample temperature at dry gas meter Inlet _____ (°F) Outlet _____ (°F) Avg. _____ Avg. _____	Temperature of gas in the impinger _____ (°F) Filter inlet temperature* _____ (°F) Avg. _____ Avg. _____
Traverse point number					
Total					
Average					

Figure 101-4. Mercury Field Data.

[View or download PDF](#)

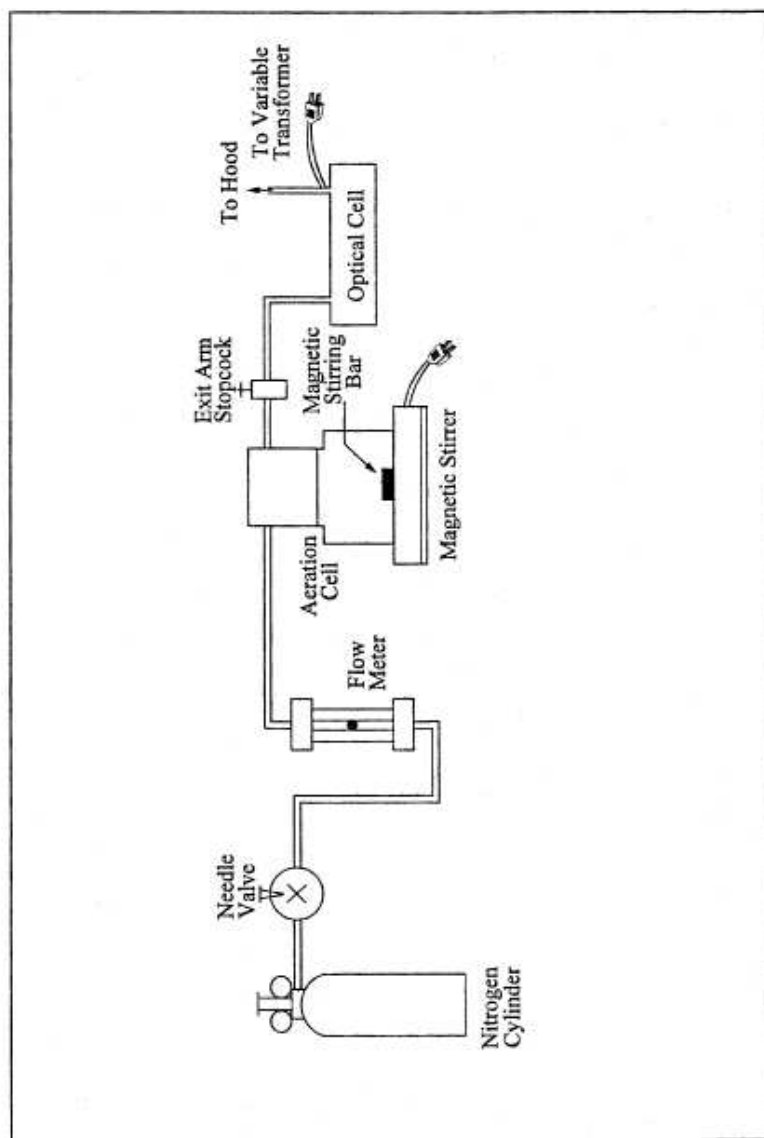

Figure 101-5. Schematic of Aeration System.

[View or download PDF](#)

METHOD 101A—DETERMINATION OF PARTICULATE AND GASEOUS MERCURY EMISSIONS FROM SEWAGE SLUDGE INCINERATORS

NOTE: This method does not include all of the specifications (e.g., equipment and supplies) and procedures (e.g., sampling and analytical) essential to its performance. Some material is incorporated by reference from methods in appendix A to 40 CFR part 60 and in this part. Therefore, to obtain reliable results, persons using this method should also have a thorough knowledge of at least the following additional test methods: Methods 1, Method 2, Method 3, and Method 5 of part 60 (appendix A), and Method 101 part 61 (appendix B).

1.0 Scope and Application

1.1 Analytes.

Analyte	CAS No.	Sensitivity
Mercury (Hg)	7439-97-6	Dependent upon spectrophotometer and recorder.

1.2 Applicability. This method is applicable for the determination of Hg emissions from sewage sludge incinerators and other sources as specified in an applicable subpart of the regulations.

1.3 Data Quality Objectives. Adherence to the requirements of this method will enhance the quality of the data obtained from air pollutant sampling methods.

2.0 Summary of Method

2.1 Particulate and gaseous Hg emissions are withdrawn isokinetically from the source and are collected in acidic potassium permanganate (KMnO_4) solution. The Hg collected (in the mercuric form) is reduced to elemental Hg, which is then aerated from the solution into an optical cell and measured by atomic absorption spectrophotometry.

3.0 Definitions. [Reserved]

4.0 Interferences

4.1 Sample Collection. Excessive oxidizable organic matter in the stack gas prematurely depletes the KMnO_4 solution and thereby prevents further collection of Hg.

4.2 Analysis. Condensation of water vapor on the optical cell windows causes a positive interference.

5.0 Safety

5.1 Disclaimer. This method may involve hazardous materials, operations, and equipment. This test method may not address all of the safety problems associated with its use. It is the responsibility of the user of this test method to establish appropriate safety and health practices and determine the applicability of regulatory limitations prior to performing this test method.

5.2 Corrosive Reagents. The following reagents are hazardous. Personal protective equipment and safe procedures are useful in preventing chemical splashes. If contact occurs, immediately flush with copious amounts of water for at least 15 minutes. Remove clothing under shower and decontaminate. Treat residual chemical burns as thermal burns.

5.2.1 Hydrochloric Acid (HCl). Highly toxic. Vapors are highly irritating to eyes, skin, nose, and lungs, causing severe damage. May cause bronchitis, pneumonia, or edema of lungs. Exposure to concentrations of 0.13 to 0.2 percent can be lethal to humans in a few minutes. Provide ventilation to limit exposure. Reacts with metals, producing hydrogen gas.

5.2.2 Nitric Acid (HNO_3). Highly corrosive to eyes, skin, nose, and lungs. Vapors cause bronchitis, pneumonia, or edema of lungs. Reaction to inhalation may be delayed as long as 30 hours and still be fatal. Provide ventilation to limit exposure. Strong oxidizer. Hazardous reaction may occur with organic materials such as solvents.

5.2.3 Sulfuric acid (H_2SO_4). Rapidly destructive to body tissue. Will cause third degree burns. Eye damage may result in blindness. Inhalation may be fatal from spasm of the larynx, usually within 30 minutes. May cause lung tissue damage with edema. 3 mg/m^3 will cause lung damage in uninitiated. 1 mg/m^3 for 8 hours will cause lung damage or, in higher concentrations, death. Provide ventilation to limit inhalation. Reacts violently with metals and organics.

5.3 Chlorine Evolution. Hydrochloric acid reacts with KMnO_4 to liberate chlorine gas. Although this is a minimal concern when small quantities of HCl (5-10 ml) are used in the impinger rinse, a potential safety hazard may still exist. At sources that emit higher concentrations of oxidizable materials (e.g., power plants), more HCl may be required to remove the larger amounts of brown deposit formed in the impingers. In such cases, the potential safety hazards due to sample container pressurization are greater, because of the larger volume of HCl rinse added to the recovered sample. These hazards are eliminated by storing and analyzing the HCl impinger wash separately from the permanganate impinger sample.

6.0 Equipment and Supplies

6.1 Sample Collection and Sample Recovery. Same as Method 101, Sections 6.1 and 6.2, respectively, with the following exceptions:

6.1.1 Probe Liner. Same as in Method 101, Section 6.1.2, except that if a filter is used ahead of the impingers, the probe heating system must be used to minimize the condensation of gaseous Hg.

6.1.2 Filter Holder (Optional). Borosilicate glass with a rigid stainless-steel wire-screen filter support (do not use glass frit supports) and a silicone rubber or Teflon gasket, designed to provide a positive seal against leakage from outside or around the filter. The filter holder must be equipped with a filter heating system capable of maintaining a temperature around the filter holder of 120 ± 14 °C (248 ± 25 °F) during sampling to minimize both water and gaseous Hg condensation. A filter may also be used in cases where the stream contains large quantities of particulate matter.

6.2 Sample Analysis. Same as Method 101, Section 6.3, with the following additions and exceptions:

6.2.1 Volumetric Pipets. Class A; 1-, 2-, 3-, 4-, 5-, 10-, and 20-ml.

6.2.2 Graduated Cylinder. 25-ml.

6.2.3 Steam Bath.

6.2.4 Atomic Absorption Spectrophotometer or Equivalent. Any atomic absorption unit with an open sample presentation area in which to mount the optical cell is suitable. Instrument settings recommended by the particular manufacturer should be followed. Instruments designed specifically for the measurement of mercury using the cold-vapor technique are commercially available and may be substituted for the atomic absorption spectrophotometer.

6.2.5 Optical Cell. Alternatively, a heat lamp mounted above the cell or a moisture trap installed upstream of the cell may be used.

6.2.6 Aeration Cell. Alternatively, aeration cells available with commercial cold vapor instrumentation may be used.

6.2.7 Aeration Gas Cylinder. Nitrogen, argon, or dry, Hg-free air, equipped with a single-stage regulator. Alternatively, aeration may be provided by a peristaltic metering pump. If a commercial cold vapor instrument is used, follow the manufacturer's recommendations.

7.0 Reagents and Standards

Unless otherwise indicated, it is intended that all reagents conform to the specifications established by the Committee on Analytical Reagents of the American Chemical Society, where such specifications are available; otherwise, use the best available grade.

7.1 Sample Collection and Recovery. The following reagents are required for sample collection and recovery:

7.1.1 Water. Deionized distilled, to conform to ASTM D 1193-77 or 91 Type 1. If high concentrations of organic matter are not expected to be present, the analyst may eliminate the KMnO_4 test for oxidizable organic matter. Use this water in all dilutions and solution preparations.

7.1.2 Nitric Acid, 50 Percent (V/V). Mix equal volumes of concentrated HNO_3 and water, being careful to add the acid to the water slowly.

7.1.3 Silica Gel. Indicating type, 6 to 16 mesh. If previously used, dry at 175 °C (350 °F) for 2 hours. New silica gel may be used as received.

7.1.4 Filter (Optional). Glass fiber filter, without organic binder, exhibiting at least 99.95 percent efficiency on 0.3- μm dioctyl phthalate smoke particles. The filter in cases where the gas stream contains large quantities of particulate matter, but blank filters should be analyzed for Hg content.

7.1.5 Sulfuric Acid, 10 Percent (V/V). Carefully add and mix 100 ml of concentrated H_2SO_4 to 900 ml of water.

7.1.6 Absorbing Solution, 4 Percent KMnO_4 (W/V). Prepare fresh daily. Dissolve 40 g of KMnO_4 in sufficient 10 percent H_2SO_4 to make 1 liter. Prepare and store in glass bottles to prevent degradation.

7.1.7 Hydrochloric Acid, 8 N. Carefully add and mix 67 ml of concentrated HCl to 33 ml of water.

7.2 Sample Analysis. The following reagents and standards are required for sample analysis:

7.2.1 Water. Same as in Section 7.1.1.

7.2.2 Tin (II) Solution. Prepare fresh daily, and keep sealed when not being used. Completely dissolve 20 g of tin (II) chloride (or 25 g of tin (II) sulfate) crystals (Baker Analyzed reagent grade or any other brand that will give a clear solution) in 25 ml of concentrated HCl. Dilute to 250 ml with water. Do not substitute HNO_3 , H_2SO_4 , or other strong acids for the HCl.

7.2.3 Sodium Chloride-Hydroxylamine Solution. Dissolve 12 g of sodium chloride and 12 g of hydroxylamine sulfate (or 12 g of hydroxylamine hydrochloride) in water and dilute to 100 ml.

7.2.4 Hydrochloric Acid, 8 N. Same as Section 7.1.7.

7.2.5 Nitric Acid, 15 Percent (V/V). Carefully add 15 ml HNO_3 to 85 ml of water.

7.2.6 Antifoam B Silicon Emulsion. J.T. Baker Company (or equivalent).

7.2.7 Mercury Stock Solution, 1 mg Hg/ml. Prepare and store all Hg standard solutions in borosilicate glass containers. Completely dissolve 0.1354 g of Hg (II) chloride in 75 ml of water. Add 10 ml of concentrated HNO_3 , and adjust the volume to exactly 100 ml with water. Mix thoroughly. This solution is stable for at least one month.

7.2.8 Intermediate Hg Standard Solution, 10 $\mu\text{g}/\text{ml}$. Prepare fresh weekly. Pipet 5.0 ml of the Hg stock solution (Section 7.2.7) into a 500 ml volumetric flask, and add 20 ml of 15 percent HNO_3 solution. Adjust the volume to exactly 500 ml with water. Thoroughly mix the solution.

7.2.9 Working Hg Standard Solution, 200 ng Hg/ml. Prepare fresh daily. Pipet 5.0 ml from the "Intermediate Hg Standard Solution" (Section 7.2.8) into a 250-ml volumetric flask. Add 5 ml of 4 percent KMnO_4 absorbing solution and 5 ml of 15 percent HNO_3 . Adjust the volume to exactly 250 ml with water. Mix thoroughly.

7.2.10 Potassium Permanganate, 5 Percent (W/V). Dissolve 5 g of KMnO_4 in water and dilute to 100 ml.

7.2.11 Filter. Whatman No. 40, or equivalent.

8.0 Sample Collection, Preservation, Transport, and Storage

Same as Method 101, Section 8.0, with the exception of the following:

8.1 Preliminary Determinations. Same as Method 101, Section 8.2, except that the liberation of free iodine in the first impinger due to high Hg or sulfur dioxide concentrations is not applicable. In this method, high oxidizable organic content may make it impossible to sample for the desired minimum time. This problem is indicated by the complete bleaching of the purple color of the KMnO_4 solution. In cases where an excess of water condensation is encountered, collect two runs to make one sample, or add an extra impinger in front of the first impinger (also containing acidified KMnO_4 solution).

8.2 Preparation of Sampling Train. Same as Method 101, Section 8.3, with the exception of the following:

8.2.1 In this method, clean all the glass components by rinsing with 50 percent HNO₃, tap water, 8 N HCl, tap water, and finally with deionized distilled water. Then place 50 ml of absorbing solution in the first impinger and 100 ml in each of the second and third impingers.

8.2.2 If a filter is used, use a pair of tweezers to place the filter in the filter holder. Be sure to center the filter, and place the gasket in the proper position to prevent the sample gas stream from bypassing the filter. Check the filter for tears after assembly is completed. Be sure also to set the filter heating system at the desired operating temperature after the sampling train has been assembled.

8.3 Sampling Train Operation. In addition to the procedure outlined in Method 101, Section 8.5, maintain a temperature around the filter (if applicable) of 120 ±14 °C (248 ±25 °F).

8.4 Sample Recovery. Same as Method 101, Section 8.7, with the exception of the following:

8.4.1 Transfer the probe, impinger assembly, and (if applicable) filter assembly to the cleanup area.

8.4.2 Treat the sample as follows:

8.4.2.1 Container No. 1 (Impinger, Probe, and Filter Holder) and, if applicable, Container No. 1A (HCl rinse).

8.4.2.1.1 Using a graduated cylinder, measure the liquid in the first three impingers to within 1 ml. Record the volume of liquid present (e.g., see Figure 5-6 of Method 5). This information is needed to calculate the moisture content of the effluent gas. (Use only graduated cylinder and glass storage bottles that have been precleaned as in Section 8.2.1.) Place the contents of the first three impingers (four if an extra impinger was added as described in Section 8.1) into a 1000-ml glass sample bottle labeled Container No. 1.

NOTE: If a filter is used, remove the filter from its holder as outlined under Section 8.4.3.

8.4.2.1.2 Taking care that dust on the outside of the probe or other exterior surfaces does not get into the sample, quantitatively recover the Hg (and any condensate) from the probe nozzle, probe fitting, probe liner, front half of the filter holder (if applicable), and impingers as follows: Rinse these components with a total of 400 ml (350 ml if an extra impinger was added as described in Section 8.1) of fresh absorbing solution, carefully assuring removal of all loose particulate matter from the impingers; add all washings to the 1000 ml glass sample bottle. To remove any residual brown deposits on the glassware following the permanganate rinse, rinse with approximately 100 ml of water, carefully assuring removal of all loose particulate matter from the impingers. Add this rinse to Container No. 1.

8.4.2.1.3 If no visible deposits remain after this water rinse, do not rinse with 8 N HCl. If deposits do remain on the glassware after the water rinse, wash impinger walls and stems with 25 ml of 8 N HCl, and place the wash in a separate container labeled Container No. 1A as follows: Place 200 ml of water in a sample container labeled Container No. 1A. Wash the impinger walls and stem with the HCl by turning the impinger on its side and rotating it so that the HCl contacts all inside surfaces. Pour the HCl wash carefully with stirring into Container No. 1A.

8.4.2.1.4 After all washings have been collected in the appropriate sample container(s), tighten the lid(s) on the container(s) to prevent leakage during shipment to the laboratory. Mark the height of the fluid level to allow subsequent determination of whether leakage has occurred during transport. Label each container to identify its contents clearly.

8.4.3 Container No. 2 (Silica Gel). Same as Method 5, Section 8.7.6.3.

8.4.4 Container No. 3 (Filter). If a filter was used, carefully remove it from the filter holder, place it in a 100-ml glass sample bottle, and add 20 to 40 ml of absorbing solution. If it is necessary to fold the

filter, be sure that the particulate cake is inside the fold. Carefully transfer to the 100-ml sample bottle any particulate matter and filter fibers that adhere to the filter holder gasket by using a dry Nylon bristle brush and a sharp-edged blade. Seal the container. Label the container to identify its contents clearly. Mark the height of the fluid level to allow subsequent determination of whether leakage has occurred during transport.

8.4.5 Container No. 4 (Filter Blank). If a filter was used, treat an unused filter from the same filter lot as that used for sampling according to the procedures outlined in Section 8.4.4.

8.4.6 Container No. 5 (Absorbing Solution Blank). Place 650 ml of 4 percent KMnO_4 absorbing solution in a 1000-ml sample bottle. Seal the container.

8.4.7 Container No. 6 (HCl Rinse Blank). Place 200 ml of water in a 1000-ml sample bottle, and add 25 ml of 8 N HCl carefully with stirring. Seal the container. Only one blank sample per 3 runs is required.

9.0 Quality Control

9.1 Miscellaneous Quality Control Measures.

Section	Quality control measure	Effect
8.0, 10.0	Sampling equipment leak-checks and calibration	Ensure accuracy and precision of sampling measurements.
10.2	Spectrophotometer calibration	Ensure linearity of spectrophotometer response to standards.
11.3.3	Check for matrix effects	Eliminate matrix effects.

9.2 Volume Metering System Checks. Same as Method 5, Section 9.2.

10.0 Calibration and Standardization

Same as Method 101, Section 10.0, with the following exceptions:

10.1 Optical Cell Heating System Calibration. Same as in Method 101, Section 10.4, except use a-25 ml graduated cylinder to add 25 ml of water to the bottle section of the aeration cell.

10.2 Spectrophotometer and Recorder Calibration.

10.2.1 The Hg response may be measured by either peak height or peak area.

NOTE: The temperature of the solution affects the rate at which elemental Hg is released from a solution and, consequently, it affects the shape of the absorption curve (area) and the point of maximum absorbance (peak height). To obtain reproducible results, all solutions must be brought to room temperature before use.

10.2.2 Set the spectrophotometer wave length at 253.7 nm, and make certain the optical cell is at the minimum temperature that will prevent water condensation. Then set the recorder scale as follows: Using a 25-ml graduated cylinder, add 25 ml of water to the aeration cell bottle. Add three drops of Antifoam B to the bottle, and then pipet 5.0 ml of the working Hg standard solution into the aeration cell.

NOTE: Always add the Hg-containing solution to the aeration cell after the 25 ml of water.

10.2.3 Place a Teflon-coated stirring bar in the bottle. Add 5 ml of absorbing solution to the aeration bottle, and mix well. Before attaching the bottle section to the bubbler section of the aeration cell, make certain that (1) the aeration cell exit arm stopcock (Figure 101-3 of Method 101) is closed (so that Hg will not prematurely enter the optical cell when the reducing agent is being added) and (2) there is no flow through the bubbler. If conditions (1) and (2) are met, attach the bottle section to the bubbler section of the aeration cell. Add sodium chloride-hydroxylamine in 1 ml increments until the solution is colorless. Now add 5 ml of tin (II) solution to the aeration bottle through the side arm, and

immediately stopper the side arm. Stir the solution for 15 seconds, turn on the recorder, open the aeration cell exit arm stopcock, and immediately initiate aeration with continued stirring. Determine the maximum absorbance of the standard, and set this value to read 90 percent of the recorder full scale.

11.0 Analytical Procedure

11.1 Sample Loss Check. Check the liquid level in each container to see if liquid was lost during transport. If a noticeable amount of leakage occurred, either void the sample or use methods subject to the approval of the Administrator to account for the losses.

11.2 Sample Preparation. Treat sample containers as follows:

11.2.1 Containers No. 3 and No. 4 (Filter and Filter Blank).

11.2.1.1 If a filter is used, place the contents, including the filter, of Containers No. 3 and No. 4 in separate 250-ml beakers, and heat the beakers on a steam bath until most of the liquid has evaporated. Do not heat to dryness. Add 20 ml of concentrated HNO₃ to the beakers, cover them with a watch glass, and heat on a hot plate at 70 °C (160 °F) for 2 hours. Remove from the hot plate.

11.2.1.2 Filter the solution from digestion of the Container No. 3 contents through Whatman No. 40 filter paper, and save the filtrate for addition to the Container No. 1 filtrate as described in Section 11.2.2. Discard the filter paper.

11.2.1.3 Filter the solution from digestion of the Container No. 4 contents through Whatman No. 40 filter paper, and save the filtrate for addition to Container No. 5 filtrate as described in Section 11.2.3 below. Discard the filter paper.

11.2.2 Container No. 1 (Impingers, Probe, and Filter Holder) and, if applicable, No. 1A (HCl rinse).

11.2.2.1 Filter the contents of Container No. 1 through Whatman No. 40 filter paper into a 1 liter volumetric flask to remove the brown manganese dioxide (MnO₂) precipitate. Save the filter for digestion of the brown MnO₂ precipitate. Add the sample filtrate from Container No. 3 to the 1-liter volumetric flask, and dilute to volume with water. If the combined filtrates are greater than 1000 ml, determine the volume to the nearest ml and make the appropriate corrections for blank subtractions. Mix thoroughly. Mark the filtrate as analysis Sample No. A.1 and analyze for Hg within 48 hr of the filtration step. Place the saved filter, which was used to remove the brown MnO₂ precipitate, into an appropriate sized container. In a laboratory hood, add 25 ml of 8 N HCl to the filter and allow to digest for a minimum of 24 hours at room temperature.

11.2.2.2 Filter the contents of Container 1A through Whatman No. 40 filter paper into a 500-ml volumetric flask. Then filter the digestate of the brown MnO₂ precipitate from Container No. 1 through Whatman No. 40 filter paper into the same 500-ml volumetric flask, and dilute to volume with water. Mark this combined 500 ml dilute solution as analysis Sample No. A.2. Discard the filters.

11.2.3 Container No. 5 (Absorbing Solution Blank) and No. 6 (HCl Rinse Blank).

11.2.3.1 Treat Container No. 5 as Container No. 1 (as described in Section 11.2.2), except substitute the filter blank filtrate from Container No. 4 for the sample filtrate from Container No. 3, and mark as Sample A.1 Blank.

11.2.3.2 Treat Container No. 6 as Container No. 1A, (as described in Section 11.2.2, except substitute the filtrate from the digested blank MnO₂ precipitate for the filtrate from the digested sample MnO₂ precipitate, and mark as Sample No. A.2 Blank.

NOTE: When analyzing samples A.1 Blank and HCl A.2 Blank, always begin with 10 ml aliquots. This applies specifically to blank samples.

11.3 Analysis. Calibrate the analytical equipment and develop a calibration curve as outlined in Section 10.0.

11.3.1 Mercury Samples. Then repeat the procedure used to establish the calibration curve with appropriately sized aliquots (1 to 10 ml) of the samples (from Sections 11.2.2 and 11.2.3) until two consecutive peak heights agree within 3 percent of their average value. If the 10 ml sample is below the detectable limit, use a larger aliquot (up to 20 ml), but decrease the volume of water added to the aeration cell accordingly to prevent the solution volume from exceeding the capacity of the aeration bottle. If the peak maximum of a 1.0 ml aliquot is off scale, further dilute the original sample to bring the Hg concentration into the calibration range of the spectrophotometer. If the Hg content of the absorbing solution and filter blank is below the working range of the analytical method, use zero for the blank.

11.3.2 Run a blank and standard at least after every five samples to check the spectrophotometer calibration; recalibrate as necessary.

11.3.3 Check for Matrix Effects (optional). Same as Method 101, Section 11.3.3.

12.0 Data Analysis and Calculations

NOTE: Carry out calculations, retaining at least one extra decimal significant figure beyond that of the acquired data. Round off figures only after the final calculation. Other forms of the equations may be used as long as they give equivalent results.

12.1 Nomenclature.

$C_{(\text{ftr})\text{Hg}}$ = Total ng of Hg in aliquot of KMnO_4 filtrate and HNO_3 digestion of filter analyzed (aliquot of analysis Sample No. A.1).

$C_{(\text{ftr blk})\text{Hg}}$ = Total ng of Hg in aliquot of KMnO_4 blank and HNO_3 digestion of blank filter analyzed (aliquot of analysis Sample No. A.1 blank).

$C_{(\text{HCl blk})\text{Hg}}$ = Total ng of Hg analyzed in aliquot of the 500-ml analysis Sample No. HCl A.2 blank.

$C_{(\text{HCl})\text{Hg}}$ = Total ng of Hg analyzed in the aliquot from the 500-ml analysis Sample No. HCl A.2.

DF = Dilution factor for the HCl-digested Hg-containing solution, Analysis Sample No. "HCl A.2."

DF_{blk} = Dilution factor for the HCl-digested Hg containing solution, Analysis Sample No. "HCl A.2 blank." (Refer to sample No. "HCl A.2" dilution factor above.)

$m_{(\text{ftr})\text{Hg}}$ = Total blank corrected μg of Hg in KMnO_4 filtrate and HNO_3 digestion of filter sample.

$m_{(\text{HCl})\text{Hg}}$ = Total blank corrected μg of Hg in HCl rinse and HCl digestate of filter sample.

m_{Hg} = Total blank corrected Hg content in each sample, μg .

S = Aliquot volume of sample added to aeration cell, ml.

S_{blk} = Aliquot volume of blank added to aeration cell, ml.

V_{f(blk)} = Solution volume of blank sample, 1000 ml for samples diluted as described in Section 11.2.2.

V_{f(ftr)} = Solution volume of original sample, normally 1000 ml for samples diluted as described in Section 11.2.2.

V_{f(HCl)} = Solution volume of original sample, 500 ml for samples diluted as described in Section 11.2.1.

10^{-3} = Conversion factor, $\mu\text{g}/\text{ng}$.

12.2 Average Dry Gas Meter Temperature and Average Orifice Pressure Drop, Dry Gas Volume, Volume of Water Vapor Condensed, Moisture Content, Isokinetic Variation, and Stack Gas Velocity and Volumetric Flow Rate. Same as Method 5, Sections 12.2 through 12.5, 12.11, and 12.12, respectively.

12.3 Total Mercury.

12.3.1 For each source sample, correct the average maximum absorbance of the two consecutive samples whose peak heights agree within 3 percent of their average for the contribution of the blank. Use the calibration curve and these corrected averages to determine the final total weight of Hg in ng in the aeration cell for each source sample.

12.3.2 Correct for any dilutions made to bring the sample into the working range of the spectrophotometer.

$$m_{(\text{HCl})\text{Hg}} = \frac{[C_{(\text{HCl})\text{Hg}} \text{DF}]}{S} - \frac{[C_{(\text{HCl}b\text{k})\text{Hg}} \text{DF}_{b\text{k}}]}{S_{b\text{k}}} V_{f(\text{HCl})} (10^{-3}) \quad \text{Eq. 101A-1}$$

NOTE: This dilution factor applies only to the intermediate dilution steps, since the original sample volume $[(V_f)_{\text{HCl}}]$ of "HCl A.2" has been factored out in the equation along with the sample aliquot (S). In Eq. 101A-1, the sample aliquot, S, is introduced directly into the aeration cell for analysis according to the procedure outlined in Section 11.3.1. A dilution factor is required only if it is necessary to bring the sample into the analytical instrument's calibration range.

NOTE: The maximum allowable blank subtraction for the HCl is the lesser of the two following values: (1) the actual blank measured value (analysis Sample No. HCl A.2 blank), or (2) 5% of the Hg content in the combined HCl rinse and digested sample (analysis Sample No. HCl A.2).

$$m_{(\text{ftr})\text{Hg}} = \frac{[C_{(\text{ftr})\text{Hg}} \text{DF} V_{f(\text{ftr})}]}{S} - \frac{[C_{(\text{ftr}b\text{k})\text{Hg}} \text{DF}_{b\text{k}} V_{f(b\text{k})}]}{S_{b\text{k}}} \quad \text{Eq. 101A-2}$$

NOTE: The maximum allowable blank subtraction for the HCl is the lesser of the two following values: (1) the actual blank measured value (analysis Sample No. "A.1 blank"), or (2) 5% of the Hg content in the filtrate (analysis Sample No. "A.1").

$$m_{\text{Hg}} = m_{(\text{HCl})\text{Hg}} + m_{(\text{ftr})\text{Hg}} \quad \text{Eq. 101A-3}$$

12.3 Mercury Emission Rate. Same as Method 101, Section 12.3.

12.4 Determination of Compliance. Same as Method 101, Section 12.4.

13.0 Method Performance

13.1 Precision. Based on eight paired-train tests, the intra-laboratory standard deviation was estimated to be 4.8 $\mu\text{g}/\text{ml}$ in the concentration range of 50 to 130 $\mu\text{g}/\text{m}^3$.

13.2 Bias. [Reserved]

13.3 Range. After initial dilution, the range of this method is 20 to 800 ng Hg/ml. The upper limit can be extended by further dilution of the sample.

14.0 Pollution Prevention [Reserved]

15.0 Waste Management [Reserved]

16.0 References

Same as Section 16.0 of Method 101, with the addition of the following:

1. Mitchell, W.J., *et al.* Test Methods to Determine the Mercury Emissions from Sludge Incineration Plants. U.S. Environmental Protection Agency. Research Triangle Park, NC. Publication No. EPA-600/4-79-058. September 1979.

2. Wilshire, Frank W., *et al.* Reliability Study of the U.S. EPA's Method 101A—Determination of Particulate and Gaseous Mercury Emissions. U.S. Environmental Protection Agency. Research Triangle Park, NC. Report No. 600/D-31/219 AREAL 367, NTIS Acc No. PB91-233361.

3. Memorandum from William J. Mitchell to Roger T. Shigehara discussing the potential safety hazard in Section 7.2 of Method 101A. February 28, 1990.

17.0 Tables, Diagrams, Flowcharts, And Validation Data [Reserved]

METHOD 102—DETERMINATION OF PARTICULATE AND GASEOUS MERCURY EMISSIONS FROM CHLOR-ALKALI PLANTS (HYDROGEN STREAMS)

NOTE: This method does not include all of the specifications (*e.g.*, equipment and supplies) and procedures (*e.g.*, sampling and analytical) essential to its performance. Some material is incorporated by reference from other methods in this part and in appendix A to 40 CFR part 60. Therefore, to obtain reliable results, persons using this method should have a thorough knowledge of at least the following additional test methods: Method 1, Method 2, Method 3, Method 5, and Method 101.

1.0 Scope and Application

1.1 Analytes.

Analyte	CAS No.	Sensitivity
Mercury (Hg)	7439-97-6	Dependent upon recorder and spectrophotometer.

1.2 Applicability. This method is applicable for the determination of Hg emissions, including both particulate and gaseous Hg, from chlor-alkali plants and other sources (as specified in the regulations) where the carrier-gas stream in the duct or stack is principally hydrogen.

1.3 Data Quality Objectives. Adherence to the requirements of this method will enhance the quality of the data obtained from air pollutant sampling methods.

2.0 Summary of Method

2.1 Particulate and gaseous Hg emissions are withdrawn isokinetically from the source and collected in acidic iodine monochloride (ICI) solution. The Hg collected (in the mercuric form) is reduced to elemental Hg, which is then aerated from the solution into an optical cell and measured by atomic absorption spectrophotometry.

3.0 Definitions [Reserved]

4.0 Interferences

Same as Method 101, Section 4.2.

5.0 Safety

5.1 Disclaimer. This method may involve hazardous materials, operations, and equipment. This test method may not address all of the safety problems associated with its use. It is the responsibility of the user of this test method to establish appropriate safety and health practices and determine the applicability of regulatory limitations prior to performing this test method.

5.2 Corrosive Reagents. Same as Method 101, Section 5.2.

5.3 Explosive Mixtures. The sampler must conduct the source test under conditions of utmost safety because hydrogen and air mixtures are explosive. Since the sampling train essentially is

leakless, attention to safe operation can be concentrated at the inlet and outlet. If a leak does occur, however, remove the meter box cover to avoid a possible explosive mixture. The following specific precautions are recommended:

5.3.1 Operate only the vacuum pump during the test. The other electrical equipment, e.g., heaters, fans, and timers, normally are not essential to the success of a hydrogen stream test.

5.3.2 Seal the sample port to minimize leakage of hydrogen from the stack.

5.3.3 Vent sampled hydrogen at least 3 m (10 ft) away from the train. This can be accomplished by attaching a 13-mm (0.50-in.) ID Tygon tube to the exhaust from the orifice meter.

NOTE: A smaller ID tubing may cause the orifice meter calibration to be erroneous. Take care to ensure that the exhaust line is not bent or pinched.

6.0 Equipment and Supplies

Same as Method 101, Section 6.0, with the exception of the following:

6.1 Probe Heating System. Do not use, unless otherwise specified.

6.2 Glass Fiber Filter. Do not use, unless otherwise specified.

7.0 Reagents and Standards

Same as Method 101, Section 7.0.

8.0 Sample Collection, Preservation, Transport, and Storage

Same as Method 101, Section 8.0, with the exception of the following:

8.1 Setting of Isokinetic Rates.

8.1.1 If a nomograph is used, take special care in the calculation of the molecular weight of the stack gas and in the setting of the nomograph to maintain isokinetic conditions during sampling (Sections 8.1.1.1 through 8.1.1.3 below).

8.1.1.1 Calibrate the meter box orifice. Use the techniques described in APTD-0576 (see Reference 9 in Section 17.0 of Method 5). Calibration of the orifice meter at flow conditions that simulate the conditions at the source is suggested. Calibration should either be done with hydrogen or with some other gas having similar Reynolds Number so that there is similarity between the Reynolds Numbers during calibration and during sampling.

8.1.1.2 The nomograph described in APTD-0576 cannot be used to calculate the C factor because the nomograph is designed for use when the stack gas dry molecular weight is 29 ± 4 . Instead, the following calculation should be made to determine the proper C factor:

$$C = 0.00154 \Delta H @ C_p^2 T_m (P_s / P_m) \frac{(1 - B_{ws})^2}{(1 - B_{ws}) + 18 B_{ws}} \quad \text{Eq. 102-1}$$

Where:

B_{ws} = Fraction by volume of water vapor in the stack gas.

C_p = Pitot tube calibration coefficient, dimensionless.

M_d = Dry molecular weight of stack gas, lb/lb-mole.

P_s = Absolute pressure of stack gas, in. Hg.

P_m = Absolute pressure of gas at the meter, in. Hg.

T_m = Absolute temperature of gas at the orifice, °R.

$\Delta H_{@}$ = Meter box calibration factor obtained in Section 8.1.1.1, in. H₂ O.

0.00154 = (in. H₂ O/°R).

NOTE: This calculation is left in English units, and is not converted to metric units because nomographs are based on English units.

8.1.1.3 Set the calculated C factor on the operating nomograph, and select the proper nozzle diameter and K factor as specified in APTD-0576. If the C factor obtained in Section 8.1.1.2 exceeds the values specified on the existing operating nomograph, expand the C scale logarithmically so that the values can be properly located.

8.1.2 If a calculator is used to set isokinetic rates, it is suggested that the isokinetic equation presented in Reference 13 in Section 17.0 of Method 101 be consulted.

8.2 Sampling in Small (<12-in. Diameter) Stacks. When the stack diameter (or equivalent diameter) is less than 12 inches, conventional pitot tube-probe assemblies should not be used. For sampling guidelines, see Reference 14 in Section 17.0 of Method 101.

9.0 Quality Control

Same as Method 101, Section 9.0.

10.0 Calibration and Standardizations

Same as Method 101, Section 10.0.

11.0 Analytical Procedure

Same as Method 101, Section 11.0.

12.0 Data Analysis and Calculations

Same as Method 101, Section 12.0.

13.0 Method Performance

Same as Method 101, Section 13.0.

13.1 Analytical Range. After initial dilution, the range of this method is 0.5 to 120 µg Hg/ml. The upper limit can be extended by further dilution of the sample.

14.0 Pollution Prevention. [Reserved]

15.0 Waste Management. [Reserved]

16.0 References

Same as Method 101, Section 16.0.

17.0 Tables, Diagrams, Flowcharts, and Validation Data. [Reserved]

METHOD 103—BERYLLIUM SCREENING METHOD

1.0 Scope and Application

1.1 Analytes.

Analyte	CAS No.	Sensitivity
Beryllium (Be)	7440-41-7	Dependent upon analytical procedure used.

1.2 **Applicability.** This procedure details guidelines and requirements for methods acceptable for use in determining Be emissions in ducts or stacks at stationary sources.

1.3 **Data Quality Objectives.** Adherence to the requirements of this method will enhance the quality of the data obtained from air pollutant sampling methods.

2.0 Summary of Method

2.1 **Particulate Be emissions** are withdrawn isokinetically from three points in a duct or stack and are collected on a filter. The collected sample is analyzed for Be using an appropriate technique.

3.0 Definitions. [Reserved]

4.0 Interferences. [Reserved]

5.0 Safety

5.1 **Disclaimer.** This method may involve hazardous materials, operations, and equipment. This test method may not address all of the safety problems associated with its use. It is the responsibility of the user of this test method to establish appropriate safety and health practices and determine the applicability of regulatory limitations prior to performing this test method.

5.2 **Hydrochloric Acid (HCl).** Highly corrosive and toxic. Vapors are highly irritating to eyes, skin, nose, and lungs, causing severe damage. May cause bronchitis, pneumonia, or edema of lungs. Exposure to concentrations of 0.13 to 0.2 percent can be lethal to humans in a few minutes. Provide ventilation to limit exposure. Reacts with metals, producing hydrogen gas. Personal protective equipment and safe procedures are useful in preventing chemical splashes. If contact occurs, immediately flush with copious amounts of water at least 15 minutes. Remove clothing under shower and decontaminate. Treat residual chemical burn as thermal burn.

6.0 Equipment and Supplies

6.1 **Sample Collection.** A schematic of the required sampling train configuration is shown in Figure 103-1 in Section 17.0. The essential components of the train are as follows:

6.1.1 **Nozzle.** Stainless steel, or equivalent, with sharp, tapered leading edge.

6.1.2 **Probe.** Sheathed borosilicate or quartz glass tubing.

6.1.3 **Filter.** Millipore AA, or equivalent, with appropriate filter holder that provides a positive seal against leakage from outside or around the filter. It is suggested that a Whatman 41, or equivalent, be placed immediately against the back side of the Millipore filter as a guard against breakage of the Millipore. Include the backup filter in the analysis. To be equivalent, other filters shall exhibit at least 99.95 percent efficiency (0.05 percent penetration) on 0.3 micron dioctyl phthalate smoke particles, and be amenable to the Be analysis procedure. The filter efficiency tests shall be conducted in accordance with ASTM D 2986-71, 78, 95a (incorporated by reference—see § 61.18). Test data from the supplier's quality control program are sufficient for this purpose.

6.1.4 **Meter-Pump System.** Any system that will maintain isokinetic sampling rate, determine sample volume, and is capable of a sampling rate of greater than 14 lpm (0.5 cfm).

6.2 **Measurement of Stack Conditions.** The following equipment is used to measure stack conditions:

6.2.1 **Pitot Tube.** Type S, or equivalent, with a constant coefficient (± 5 percent) over the working range.

6.2.2 Inclined Manometer, or Equivalent. To measure velocity head to ± 10 percent of the minimum value.

6.2.3 Temperature Measuring Device. To measure stack temperature to ± 1.5 percent of the minimum absolute stack temperature.

6.2.4 Pressure Measuring Device. To measure stack pressure to ± 2.5 mm Hg (0.1 in. Hg).

6.2.5 Barometer. To measure atmospheric pressure to ± 2.5 mm Hg (0.1 in. Hg).

6.2.6 Wet and Dry Bulb Thermometers, Drying Tubes, Condensers, or Equivalent. To determine stack gas moisture content to ± 1 percent.

6.3 Sample Recovery.

6.3.1 Probe Cleaning Equipment. Probe brush or cleaning rod at least as long as probe, or equivalent. Clean cotton balls, or equivalent, should be used with the rod.

6.3.2 Leakless Glass Sample Bottles. To contain sample.

6.4 Analysis. All equipment necessary to perform an atomic absorption, spectrographic, fluorometric, chromatographic, or equivalent analysis.

7.0 Reagents and Standards

7.1 Sample Recovery.

7.1.1 Water. Deionized distilled, to conform to ASTM D 1193-77, 91 (incorporated by reference—see § 61.18), Type 3.

7.1.2 Acetone. Reagent grade.

7.1.3 Wash Acid, 50 Percent (V/V) Hydrochloric Acid (HCl). Mix equal volumes of concentrated HCl and water, being careful to add the acid slowly to the water.

7.2 Analysis. Reagents and standards as necessary for the selected analytical procedure.

8.0 Sample Collection, Preservation, Transport, and Storage

Guidelines for source testing are detailed in the following sections. These guidelines are generally applicable; however, most sample sites differ to some degree and temporary alterations such as stack extensions or expansions often are required to insure the best possible sample site. Further, since Be is hazardous, care should be taken to minimize exposure. Finally, since the total quantity of Be to be collected is quite small, the test must be carefully conducted to prevent contamination or loss of sample.

8.1 Selection of a Sampling Site and Number of Sample Runs. Select a suitable sample site that is as close as practicable to the point of atmospheric emission. If possible, stacks smaller than one foot in diameter should not be sampled.

8.1.1 Ideal Sampling Site. The ideal sampling site is at least eight stack or duct diameters downstream and two diameters upstream from any flow disturbance such as a bend, expansion or contraction. For rectangular cross sections, use Equation 103-1 in Section 12.2 to determine an equivalent diameter, D_e .

8.1.2 Alternate Sampling Site. Some sampling situations may render the above sampling site criteria impractical. In such cases, select an alternate site no less than two diameters downstream and one-half diameter upstream from any point of flow disturbance. Additional sample runs are recommended at any sample site not meeting the criteria of Section 8.1.1.

8.1.3 Number of Sample Runs Per Test. Three sample runs constitute a test. Conduct each run at one of three different points. Select three points that proportionately divide the diameter, or are located at 25, 50, and 75 percent of the diameter from the inside wall. For horizontal ducts, sample on a vertical line through the centroid. For rectangular ducts, sample on a line through the centroid and parallel to a side. If additional sample runs are performed per Section 8.1.2, proportionately divide the duct to accommodate the total number of runs.

8.2 Measurement of Stack Conditions. Using the equipment described in Section 6.2, measure the stack gas pressure, moisture, and temperature to determine the molecular weight of the stack gas. Sound engineering estimates may be made in lieu of direct measurements. Describe the basis for such estimates in the test report.

8.3 Preparation of Sampling Train.

8.3.1 Assemble the sampling train as shown in Figure 103-1. It is recommended that all glassware be precleaned by soaking in wash acid for two hours.

8.3.2 Leak check the sampling train at the sampling site. The leakage rate should not be in excess of 1 percent of the desired sample rate.

8.4 Sampling Train Operation.

8.4.1 For each run, measure the velocity at the selected sampling point. Determine the isokinetic sampling rate. Record the velocity head and the required sampling rate. Place the nozzle at the sampling point with the tip pointing directly into the gas stream. Immediately start the pump and adjust the flow to isokinetic conditions. At the conclusion of the test, record the sampling rate. Again measure the velocity head at the sampling point. The required isokinetic rate at the end of the period should not have deviated more than 20 percent from that originally calculated. Describe the reason for any deviation beyond 20 percent in the test report.

8.4.2 Sample at a minimum rate of 14 liters/min (0.5 cfm). Obtain samples over such a period or periods of time as are necessary to determine the maximum emissions which would occur in a 24-hour period. In the case of cyclic operations, perform sufficient sample runs so as to allow determination or calculation of the emissions that occur over the duration of the cycle. A minimum sampling time of two hours per run is recommended.

8.5 Sample Recovery.

8.5.1 It is recommended that all glassware be precleaned as in Section 8.3. Sample recovery should also be performed in an area free of possible Be contamination. When the sampling train is moved, exercise care to prevent breakage and contamination. Set aside a portion of the acetone used in the sample recovery as a blank for analysis. The total amount of acetone used should be measured for accurate blank correction. Blanks can be eliminated if prior analysis shows negligible amounts.

8.5.2 Remove the filter (and backup filter, if used) and any loose particulate matter from filter holder, and place in a container.

8.5.3 Clean the probe with acetone and a brush or long rod and cotton balls. Wash into the container with the filter. Wash out the filter holder with acetone, and add to the same container.

9.0 Quality Control. [Reserved]

10.0 Calibration and Standardization

10.1 Sampling Train. As a procedural check, compare the sampling rate regulation with a dry gas meter, spirometer, rotameter (calibrated for prevailing atmospheric conditions), or equivalent, attached to the nozzle inlet of the complete sampling train.

10.2 Analysis. Perform the analysis standardization as suggested by the manufacturer of the instrument, or the procedures for the analytical method in use.

11.0 Analytical Procedure

Make the necessary preparation of samples and analyze for Be. Any currently acceptable method (e.g., atomic absorption, spectrographic, fluorometric, chromatographic) may be used.

12.0 Data Analysis and Calculations

12.1 Nomenclature.

A_s (avg) = Stack area, m^2 (ft^2).

L = Length.

R = Be emission rate, g/day.

V_s (avg) = Average stack gas velocity, m/sec (ft/sec).

V_{total} = Total volume of gas sampled, m^3 (ft^3).

W = Width.

W_t = Total weight of Be collected, mg.

10^{-6} = Conversion factor, g/ μ g.

86,400 = Conversion factor, sec/day.

12.2 Calculate the equivalent diameter, D_e , for a rectangular cross section as follows:

$$D_e = \frac{2 \cdot L \cdot W}{L + W} \quad \text{Eq. 103-1}$$

12.3 Calculate the Be emission rate, R, in g/day for each stack using Equation 103-2. For cyclic operations, use only the time per day each stack is in operation. The total Be emission rate from a source is the summation of results from all stacks.

$$R = \frac{W_t V_{s(\text{avg})} A_s (86,400) (10^{-6})}{V_{total}} \quad \text{Eq. 103-2}$$

12.4 Test Report. Prepare a test report that includes as a minimum: A detailed description of the sampling train used, results of the procedural check described in Section 10.1 with all data and calculations made, all pertinent data taken during the test, the basis for any estimates made, isokinetic sampling calculations, and emission results. Include a description of the test site, with a block diagram and brief description of the process, location of the sample points in the stack cross section, and stack dimensions and distances from any point of disturbance.

13.0 Method Performance. [Reserved]

14.0 Pollution Prevention. [Reserved]

15.0 Waste Management. [Reserved]

16.0 References. [Reserved]

17.0 Tables, Diagrams, Flow Charts, and Validation Data

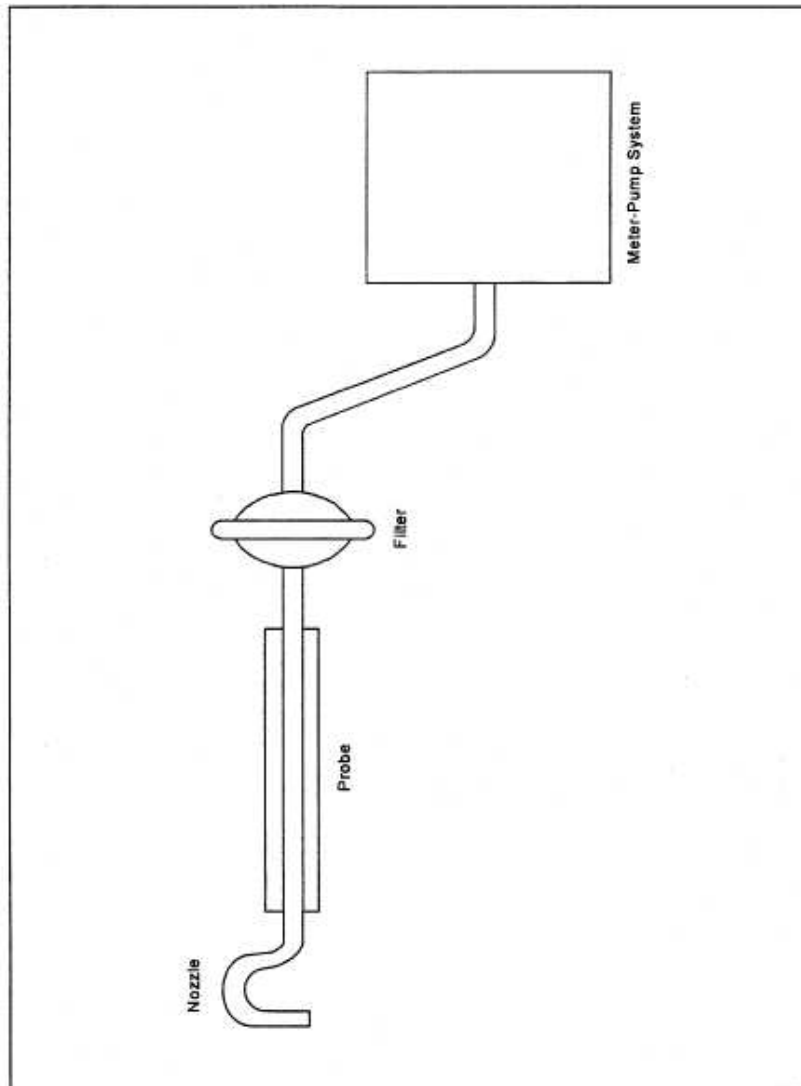

Figure 103-1. Beryllium Screening Method Sampling Train Schematic.

[View or download PDF](#)

METHOD 104—DETERMINATION OF BERYLLIUM EMISSIONS FROM STATIONARY SOURCES

NOTE: This method does not include all of the specifications (e.g., equipment and supplies) and procedures (e.g., sampling and analytical) essential to its performance. Some material is incorporated by reference from methods in appendix A to 40 CFR part 60. Therefore, to obtain reliable results, persons using this method should have a thorough knowledge of at least the following additional test methods: Method 1, Method 2, Method 3, and Method 5 in appendix A, part 60.

1.0 Scope and Application

1.1 Analytes.

Analyte	CAS No.	Sensitivity
Beryllium (Be)	7440-41-7	Dependent upon recorder and spectrophotometer.

1.2 Applicability. This method is applicable for the determination of Be emissions in ducts or stacks at stationary sources. Unless otherwise specified, this method is not intended to apply to gas streams other than those emitted directly to the atmosphere without further processing.

1.3 Data Quality Objectives. Adherences to the requirements of this method will enhance the quality of the data obtained from air pollutant sampling methods.

2.0 Summary of Method

2.1 Particulate and gaseous Be emissions are withdrawn isokinetically from the source and are collected on a glass fiber filter and in water. The collected sample is digested in an acid solution and is analyzed by atomic absorption spectrophotometry.

3.0 Definitions [Reserved]

4.0 Interferences

4.1 Matrix Effects. Analysis for Be by flame atomic absorption spectrophotometry is sensitive to the chemical composition and to the physical properties (e.g., viscosity, pH) of the sample. Aluminum and silicon in particular are known to interfere when present in appreciable quantities. The analytical procedure includes (optionally) the use of the Method of Standard Additions to check for these matrix effects, and sample analysis using the Method of Standard Additions if significant matrix effects are found to be present (see Reference 2 in Section 16.0).

5.0 Safety

5.1 Disclaimer. This method may involve hazardous materials, operations, and equipment. This test method may not address all of the safety problems associated with its use. It is the responsibility of the user of this test method to establish appropriate safety and health practices and determine the applicability of regulatory limitations prior to performing this test method.

5.2 Corrosive reagents. The following reagents are hazardous. Personal protective equipment and safe procedures are useful in preventing chemical splashes. If contact occurs, immediately flush with copious amounts of water at least 15 minutes. Remove clothing under shower and decontaminate. Treat residual chemical burn as thermal burn.

5.2.1 Hydrochloric Acid (HCl). Highly toxic. Vapors are highly irritating to eyes, skin, nose, and lungs, causing severe damage. May cause bronchitis, pneumonia, or edema of lungs. Exposure to concentrations of 0.13 to 0.2 percent can be lethal to humans in a few minutes. Provide ventilation to limit exposure. Reacts with metals, producing hydrogen gas.

5.2.2 Hydrogen Peroxide (H₂O₂). Irritating to eyes, skin, nose, and lungs.

5.2.3 Nitric Acid (HNO₃). Highly corrosive to eyes, skin, nose, and lungs. Vapors cause bronchitis, pneumonia, or edema of lungs. Reaction to inhalation may be delayed as long as 30 hours and still be fatal. Provide ventilation to limit exposure. Strong oxidizer. Hazardous reaction may occur with organic materials such as solvents.

5.2.4 Sodium Hydroxide (NaOH). Causes severe damage to eyes and skin. Inhalation causes irritation to nose, throat, and lungs. Reacts exothermically with limited amounts of water.

5.3 Beryllium is hazardous, and precautions should be taken to minimize exposure.

6.0 Equipment and Supplies

6.1 Sample Collection. Same as Method 5, Section 6.1, with the exception of the following:

6.1.1 Sampling Train. Same as Method 5, Section 6.1.1, with the exception of the following:

6.1.2 Probe Liner. Borosilicate or quartz glass tubing. A heating system capable of maintaining a gas temperature of 120 ± 14 °C (248 ± 25 °F) at the probe exit during sampling to prevent water condensation may be used.

NOTE: Do not use metal probe liners.

6.1.3 Filter Holder. Borosilicate glass, with a glass frit filter support and a silicone rubber gasket. Other materials of construction (e.g., stainless steel, Teflon, Viton) may be used, subject to the approval of the Administrator. The holder design shall provide a positive seal against leakage from the outside or around the filter. The holder shall be attached immediately at the outlet of the probe. A heating system capable of maintaining the filter at a minimum temperature in the range of the stack temperature may be used to prevent condensation from occurring.

6.1.4 Impingers. Four Greenburg-Smith impingers connected in series with leak-free ground glass fittings or any similar leak-free noncontaminating fittings. For the first, third, and fourth impingers, use impingers that are modified by replacing the tip with a 13 mm-ID (0.5 in.) glass tube extending to 13 mm (0.5 in.) from the bottom of the flask may be used.

6.2 Sample Recovery. The following items are needed for sample recovery:

6.2.1 Probe Cleaning Rod. At least as long as probe.

6.2.2 Glass Sample Bottles. Leakless, with Teflon-lined caps, 1000 ml.

6.2.3 Petri Dishes. For filter samples, glass or polyethylene, unless otherwise specified by the Administrator.

6.2.4 Graduated Cylinder. 250 ml.

6.2.5 Funnel and Rubber Policeman. To aid in transfer of silica gel to container; not necessary if silica gel is weighed in the field.

6.2.6 Funnel. Glass, to aid in sample recovery.

6.2.7 Plastic Jar. Approximately 300 ml.

6.3 Analysis. The following items are needed for sample analysis:

6.3.1 Atomic Absorption Spectrophotometer. Perkin-Elmer 303, or equivalent, with nitrous oxide/acetylene burner.

6.3.2 Hot Plate.

6.3.3 Perchloric Acid Fume Hood.

7.0 Reagents and Standards

NOTE: Unless otherwise indicated, it is intended that all reagents conform to the specifications established by the Committee on Analytical Reagents of the American Chemical Society, where such specifications are available; otherwise, use the best available grade.

7.1 Sample Collection. Same as Method 5, Section 7.1, including deionized distilled water conforming to ASTM D 1193-77 or 91 (incorporated by reference—see § 61.18), Type 3. The Millipore AA filter is recommended.

7.2 Sample Recovery. Same as Method 5 in appendix A, part 60, Section 7.2, with the addition of the following:

7.2.1 Wash Acid, 50 Percent (V/V) Hydrochloric Acid (HCl). Mix equal volumes of concentrated HCl and water, being careful to add the acid slowly to the water.

7.3 Sample Preparation and Analysis. The following reagents and standards and standards are needed for sample preparation and analysis:

7.3.1 Water. Same as in Section 7.1.

7.3.2. Perchloric Acid (HClO_4). Concentrated (70 percent V/V).

7.3.3 Nitric Acid (HNO_3). Concentrated.

7.3.4 Beryllium Powder. Minimum purity 98 percent.

7.3.5 Sulfuric Acid (H_2SO_4) Solution, 12 N. Dilute 33 ml of concentrated H_2SO_4 to 1 liter with water.

7.3.6 Hydrochloric Acid Solution, 25 Percent HCl (V/V).

7.3.7 Stock Beryllium Standard Solution, 10 μg Be/ml. Dissolve 10.0 mg of Be in 80 ml of 12 N H_2SO_4 in a 1000-ml volumetric flask. Dilute to volume with water. This solution is stable for at least one month. Equivalent strength Be stock solutions may be prepared from Be salts such as BeCl_2 and $\text{Be}(\text{NO}_3)_2$ (98 percent minimum purity).

7.3.8 Working Beryllium Standard Solution, 1 μg Be/ml. Dilute a 10 ml aliquot of the stock beryllium standard solution to 100 ml with 25 percent HCl solution to give a concentration of 1 mg/ml. Prepare this dilute stock solution fresh daily.

8.0 Sample Collection, Preservation, Transport, and Storage

The amount of Be that is collected is generally small, therefore, it is necessary to exercise particular care to prevent contamination or loss of sample.

8.1 Pretest Preparation. Same as Method 5, Section 8.1, except omit Section 8.1.3.

8.2 Preliminary Determinations. Same as Method 5, Section 8.2, with the exception of the following:

8.2.1 Select a nozzle size based on the range of velocity heads to assure that it is not necessary to change the nozzle size in order to maintain isokinetic sampling rates below 28 liters/min (1.0 cfm).

8.2.2 Obtain samples over a period or periods of time that accurately determine the maximum emissions that occur in a 24-hour period. In the case of cyclic operations, perform sufficient sample runs for the accurate determination of the emissions that occur over the duration of the cycle. A minimum sample time of 2 hours per run is recommended.

8.3 Preparation of Sampling Train. Same as Method 5, Section 8.3, with the exception of the following:

8.3.1 Prior to assembly, clean all glassware (probe, impingers, and connectors) by first soaking in wash acid for 2 hours, followed by rinsing with water.

8.3.2 Save a portion of the water for a blank analysis.

8.3.3 Procedures relating to the use of metal probe liners are not applicable.

8.3.4 Probe and filter heating systems are needed only if water condensation is a problem. If this is the case, adjust the heaters to provide a temperature at or above the stack temperature. However, membrane filters such as the Millipore AA are limited to about 107 °C (225 °F). If the stack gas is in excess of about 93 °C (200 °F), consideration should be given to an alternate procedure such as moving the filter holder downstream of the first impinger to insure that the filter does not exceed its temperature limit. After the sampling train has been assembled, turn on and set the probe heating system, if applicable, at the desired operating temperature. Allow time for the temperatures to stabilize. Place crushed ice around the impingers.

NOTE: An empty impinger may be inserted between the third impinger and the silica gel to remove excess moisture from the sample stream.

8.4 Leak Check Procedures, Sampling Train Operation, and Calculation of Percent Isokinetic. Same as Method 5, Sections 8.4, 8.5, and 8.6, respectively.

8.5 Sample Recovery. Same as Method 5, Section 8.7, except treat the sample as follows: Transfer the probe and impinger assembly to a cleanup area that is clean, protected from the wind, and free of Be contamination. Inspect the train before and during this assembly, and note any abnormal conditions. Treat the sample as follows: Disconnect the probe from the impinger train.

8.5.1 Container No. 1. Same as Method 5, Section 8.7.6.1.

8.5.2 Container No. 2. Place the contents (measured to 1 ml) of the first three impingers into a glass sample bottle. Use the procedures outlined in Section 8.7.6.2 of Method 5, where applicable, to rinse the probe nozzle, probe fitting, probe liner, filter holder, and all glassware between the filter holder and the back half of the third impinger with water. Repeat this procedure with acetone. Place both water and acetone rinse solutions in the sample bottle with the contents of the impingers.

8.5.3 Container No. 3. Same as Method 5, Section 8.7.6.3.

8.6 Blanks.

8.6.1 Water Blank. Save a portion of the water as a blank. Take 200 ml directly from the wash bottle being used and place it in a plastic sample container labeled "H₂O blank."

8.6.2 Filter. Save two filters from each lot of filters used in sampling. Place these filters in a container labeled "filter blank."

8.7 Post-test Glassware Rinsing. If an additional test is desired, the glassware can be carefully double rinsed with water and reassembled. However, if the glassware is out of use more than 2 days, repeat the initial acid wash procedure.

9.0 QUALITY CONTROL

Section	Quality control measure	Effect
8.4, 10.1	Sampling equipment leak checks and calibration	Ensure accuracy and precision of sampling measurements.
10.2	Spectrophotometer calibration	Ensure linearity of spectrophotometer response to standards.
11.5	Check for matrix effects	Eliminate matrix effects.

10.0 Calibration and Standardization

NOTE: Maintain a laboratory log of all calibrations.

10.1 Sampling Equipment. Same as Method 5, Section 10.0.

10.2 Preparation of Standard Solutions. Pipet 1, 3, 5, 8, and 10 ml of the 1.0 µg Be/ml working standard solution into separate 100 ml volumetric flasks, and dilute to the mark with water. The total amounts of Be in these standards are 1, 3, 5, 8, and 10 µg, respectively.

10.3 Spectrophotometer and Recorder. The Be response may be measured by either peak height or peak area. Analyze an aliquot of the 10-µg standard at 234.8 nm using a nitrous oxide/acetylene flame. Determine the maximum absorbance of the standard, and set this value to read 90 percent of the recorder full scale.

10.4 Calibration Curve.

10.4.1 After setting the recorder scale, analyze an appropriately sized aliquot of each standard and the BLANK (see Section 11) until two consecutive peaks agree within 3 percent of their average value.

10.4.3 Subtract the average peak height (or peak area) of the blank—which must be less than 2 percent of recorder full scale—from the averaged peak heights of the standards. If the blank absorbance is greater than 2 percent of full-scale, the probable cause is Be contamination of a reagent or carry-over of Be from a previous sample. Prepare the calibration curve by plotting the corrected peak height of each standard solution versus the corresponding total Be weight in the standard (in µg).

10.5 Spectrophotometer Calibration Quality Control. Calculate the least squares slope of the calibration curve. The line must pass through the origin or through a point no further from the origin than ±2 percent of the recorder full scale. Multiply the corrected peak height by the reciprocal of the least squares slope to determine the distance each calibration point lies from the theoretical calibration line. The difference between the calculated concentration values and the actual concentrations (i.e., 1, 3, 5, 8, and 10 µg Be) must be less than 7 percent for all standards.

11.0 Analytical Procedure

11.1 Sample Loss Check. Prior to analysis, check the liquid level in Container No. 2. Note on the analytical data sheet whether leakage occurred during transport. If a noticeable amount of leakage occurred, either void the sample or take steps, subject to the approval of the Administrator, to adjust the final results.

11.2 Glassware Cleaning. Before use, clean all glassware according to the procedure of Section 8.3.1.

11.3 Sample Preparation. The digestion of Be samples is accomplished in part in concentrated HClO₄.

NOTE: The sample must be heated to light brown fumes after the initial HNO₃ addition; otherwise, dangerous perchlorates may result from the subsequent HClO₄ digestion. HClO₄ should be used only under a hood.

11.3.1 Container No. 1. Transfer the filter and any loose particulate matter from Container No. 1 to a 150-ml beaker. Add 35 ml concentrated HNO₃. To oxidize all organic matter, heat on a hotplate until light brown fumes are evident. Cool to room temperature, and add 5 ml 12 N H₂ SO₄ and 5 ml concentrated HClO₄.

11.3.2 Container No. 2. Place a portion of the water and acetone sample into a 150 ml beaker, and put on a hotplate. Add portions of the remainder as evaporation proceeds and evaporate to dryness. Cool the residue, and add 35 ml concentrated HNO₃. To oxidize all organic matter, heat on a hotplate until light brown fumes are evident. Cool to room temperature, and add 5 ml 12 N H₂ SO₄ and 5 ml concentrated HClO₄. Then proceed with step 11.3.4.

11.3.3 Final Sample Preparation. Add the sample from Section 11.3.2 to the 150-ml beaker from Section 11.3.1. Replace on a hotplate, and evaporate to dryness in a HClO₄ hood. Cool the residue to room temperature, add 10.0 ml of 25 percent V/V HCl, and mix to dissolve the residue.

11.3.4 Filter and Water Blanks. Cut each filter into strips, and treat each filter individually as directed in Section 11.3.1. Treat the 200-ml water blank as directed in Section 11.3.2. Combine and treat these blanks as directed in Section 11.3.3.

11.4 Spectrophotometer Preparation. Turn on the power; set the wavelength, slit width, and lamp current; and adjust the background corrector as instructed by the manufacturer's manual for the particular atomic absorption spectrophotometer. Adjust the burner and flame characteristics as necessary.

11.5 Analysis. Calibrate the analytical equipment and develop a calibration curve as outlined in Sections 10.4 and 10.5.

11.5.1 Beryllium Samples. Repeat the procedure used to establish the calibration curve with an appropriately sized aliquot of each sample (from Section 11.3.3) until two consecutive peak heights agree within 3 percent of their average value. The peak height of each sample must be greater than 10 percent of the recorder full scale. If the peak height of the sample is off scale on the recorder, further dilute the original source sample to bring the Be concentration into the calibration range of the spectrophotometer.

11.5.2 Run a blank and standard at least after every five samples to check the spectrophotometer calibration. The peak height of the blank must pass through a point no further from the origin than ± 2 percent of the recorder full scale. The difference between the measured concentration of the standard (the product of the corrected peak height and the reciprocal of the least squares slope) and the actual concentration of the standard must be less than 7 percent, or recalibration of the analyzer is required.

11.5.3 Check for Matrix Effects (optional). Use the Method of Standard Additions (see Reference 2 in Section 16.0) to check at least one sample from each source for matrix effects on the Be results. If the results of the Method of Standard Additions procedure used on the single source sample do not agree to within 5 percent of the value obtained by the routine atomic absorption analysis, then reanalyze all samples from the source using the Method of Standard Additions procedure.

11.6 Container No. 2 (Silica Gel). Weigh the spent silica gel (or silica gel plus impinger) to the nearest 0.5 g using a balance. (This step may be conducted in the field.)

12.0 Data Analysis and Calculations

Carry out calculations, retaining at least one extra decimal significant figure beyond that of the acquired data. Round off figures only after the final calculation. Other forms of the equations may be used as long as they give equivalent results.

12.1 Nomenclature.

$K_1 = 0.3858$ °K/mm Hg for metric units.

= 17.64 °R/in. Hg for English units.

$K_3 = 10^{-6}$ g/ μ g for metric units.

= 2.2046×10^{-9} lb/ μ g for English units.

m_{Be} = Total weight of beryllium in the source sample.

P_s = Absolute stack gas pressure, mm Hg (in. Hg).

t = Daily operating time, sec/day.

T_s = Absolute average stack gas temperature, °K (°R).

$V_{\text{m(std)}}$ = Dry gas sample volume at standard conditions, scm (scf).

$V_{w(\text{std})}$ = Volume of water vapor at standard conditions, scm (scf).

12.2 Average Dry Gas Meter Temperature and Average Orifice Pressure Drop, Dry Gas Volume, Volume of Water Vapor Condensed, Moisture Content, Isokinetic Variation, and Stack Gas Velocity and Volumetric Flow Rate. Same as Method 5, Sections 12.2 through 12.5, 12.11, and 12.12, respectively.

12.3 Total Beryllium. For each source sample, correct the average maximum absorbance of the two consecutive samples whose peak heights agree within 3 percent of their average for the contribution of the solution blank (see Sections 11.3.4 and 11.5.2). Correcting for any dilutions if necessary, use the calibration curve and these corrected averages to determine the total weight of Be in each source sample.

12.4 Beryllium Emission Rate. Calculate the daily Hg emission rate, R, using Equation 104-1. For continuous operations, the operating time is equal to 86,400 seconds per day. For cyclic operations, use only the time per day each stack is in operation. The total Hg emission rate from a source will be the summation of results from all stacks.

$$R = \frac{K_1 K_2 t m_{Be} P_3 V_3 A_3}{T_3 (V_{m(\text{std})} + V_{w(\text{std})})} \quad \text{Eq. 104-1}$$

12.5 Determination of Compliance. Each performance test consists of three sample runs. For the purpose of determining compliance with an applicable national emission standard, use the average of the results of all sample runs.

13.0 Method Performance. [Reserved]

14.0 Pollution Prevention. [Reserved]

15.0 Waste Management. [Reserved]

16.0 References

Same as References 1, 2, and 4-11 of Section 16.0 of Method 101 with the addition of the following:

1. Amos, M.D., and J.B. Willis. Use of High-Temperature Pre-Mixed Flames in Atomic Absorption Spectroscopy. Spectrochim. Acta. 22:1325. 1966.

2. Fleet, B., K.V. Liberty, and T. S. West. A Study of Some Matrix Effects in the Determination of Beryllium by Atomic Absorption Spectroscopy in the Nitrous Oxide-Acetylene Flame. Talanta 17:203. 1970.

17.0 Tables, Diagrams, Flowcharts, And Validation Data [Reserved]

METHOD 105—DETERMINATION OF MERCURY IN WASTEWATER TREATMENT PLANT SEWAGE SLUDGES

NOTE: This method does not include all of the specifications (e.g., equipment and supplies) and procedures (e.g., sampling and analytical) essential to its performance. Some material is incorporated by reference from other methods in this part. Therefore, to obtain reliable results, persons using this method should also have a thorough knowledge of at least the following additional test methods: Method 101 and Method 101A.

1.0 Scope and Application

1.1 Analytes.

Analyte	CAS No.	Sensitivity
Mercury (Hg)	7439-97-6	Dependent upon spectrophotometer and recorder.

1.2 **Applicability.** This method is applicable for the determination of total organic and inorganic Hg content in sewage sludges.

1.3 **Data Quality Objectives.** Adherence to the requirements of this method will enhance the quality of the data obtained from air pollutant sampling methods.

2.0 *Summary of Method*

2.1 Time-composite sludge samples are withdrawn from the conveyor belt subsequent to dewatering and before incineration or drying. A weighed portion of the sludge is digested in aqua regia and is oxidized by potassium permanganate (KMnO_4). Mercury in the digested sample is then measured by the conventional spectrophotometric cold-vapor technique.

3.0 *Definitions [Reserved]*

4.0 *Interferences [Reserved]*

5.0 *Safety*

5.1 **Disclaimer.** This method may involve hazardous materials, operations, and equipment. This test method may not address all of the safety problems associated with its use. It is the responsibility of the user of this test method to establish appropriate safety and health practices and determine the applicability of regulatory limitations prior to performing this test method.

5.2 **Corrosive Reagents.** The following reagents are hazardous. Personal protective equipment and safe procedures are useful in preventing chemical splashes. If contact occurs, immediately flush with copious amounts of water at least 15 minutes. Remove clothing under shower and decontaminate. Treat residual chemical burn as thermal burn.

5.2.1 **Hydrochloric Acid (HCl).** Highly toxic. Vapors are highly irritating to eyes, skin, nose, and lungs, causing severe damage. May cause bronchitis, pneumonia, or edema of lungs. Exposure to concentrations of 0.13 to 0.2 percent can be lethal to humans in a few minutes. Provide ventilation to limit exposure. Reacts with metals, producing hydrogen gas.

5.2.2 **Nitric Acid (HNO_3).** Highly corrosive to eyes, skin, nose, and lungs. Vapors cause bronchitis, pneumonia, or edema of lungs. Reaction to inhalation may be delayed as long as 30 hours and still be fatal. Provide ventilation to limit exposure. Strong oxidizer. Hazardous reaction may occur with organic materials such as solvents.

6.0 *Equipment and Supplies*

6.1 **Sample Collection and Mixing.** The following items are required for collection and mixing of the sludge samples:

6.1.1 Container. Plastic, 50-liter.

6.1.2 Scoop. To remove 950-ml (1 quart.) sludge sample.

6.1.3 Mixer. Mortar mixer, wheelbarrow-type, 57-liter (or equivalent) with electricity-driven motor.

6.1.4 Blender. Waring-type, 2-liter.

6.1.5 Scoop. To remove 100-ml and 20-ml samples of blended sludge.

6.1.6 Erlenmeyer Flasks. Four, 125-ml.

6.1.7 Beakers. Glass beakers in the following sizes: 50 ml (1), 200 ml (1), 400 ml (2).

6.2 **Sample Preparation and Analysis.** Same as Method 101, Section 6.3, with the addition of the following:

6.2.1 Hot Plate.

6.2.2 Desiccator.

6.2.3 Filter Paper. S and S No. 588 (or equivalent).

6.2.4 Beakers. Glass beakers, 200 ml and 400 ml (2 each).

7.0 Reagents and Standards

NOTE: Unless otherwise indicated, it is intended that all reagents conform to the specifications established by the Committee on Analytical Reagents of the American Chemical Society, where such specifications are available; otherwise, use the best available grade.

7.1 Sample Analysis. Same as Method 101A, Section 7.2, with the following additions and exceptions:

7.1.1 Hydrochloric Acid. The concentrated HCl specified in Method 101A, Section 7.2.4, is not required.

7.1.2 Aqua Regia. Prepare immediately before use. Carefully add one volume of concentrated HNO₃ to three volumes of concentrated HCl.

8.0 Sample Collection, Preservation, Storage, and Transport

8.1 Sludge Sampling. Withdraw equal volume increments of sludge [for a total of at least 15 liters (16 quarts)] at intervals of 30 min over an 8-hr period, and combine in a rigid plastic container.

8.2 Sludge Mixing. Transfer the entire 15-liter sample to a mortar mixer. Mix the sample for a minimum of 30 min at 30 rpm. Take six 100-ml portions of sludge, and combine in a 2-liter blender. Blend sludge for 5 min; add water as necessary to give a fluid consistency. Immediately after stopping the blender, withdraw four 20-ml portions of blended sludge, and place them in separate, tared 125-ml Erlenmeyer flasks. Reweigh each flask to determine the exact amount of sludge added.

8.3 Sample Holding Time. Samples shall be analyzed within the time specified in the applicable subpart of the regulations.

9.0 Quality Control

Section	Quality control measure	Effect
10.0	Spectrophotometer calibration	Ensure linearity of spectrophotometer response to standards.
11.0	Check for matrix effects	Eliminate matrix effects.

10.0 Calibration and Standardization

Same as Method 101A, Section 10.2.

11.0 Analytical Procedures

11.1 Solids Content of Blended Sludge. Dry one of the 20-ml blended samples from Section 8.2 in an oven at 105 °C (221 °F) to constant weight. Cool in a desiccator, weigh and record the dry weight of the sample.

11.2 Aqua Regia Digestion of Blended Samples.

11.2.1 To each of the three remaining 20-ml samples from Section 8.2 add 25 ml of aqua regia, and digest the on a hot plate at low heat (do not boil) for 30 min, or until samples are a pale yellow-brown color and are void of the dark brown color characteristic of organic matter. Remove from hotplate and allow to cool.

11.2.2 Filter each digested sample separately through an S and S No. 588 filter or equivalent, and rinse the filter contents with 50 ml of water. Transfer the filtrate and filter washing to a 100-ml volumetric flask, and carefully dilute to volume with water.

11.3 Solids Content of the Sludge Before Blending. Remove two 100-ml portions of mixed sludge from the mortar mixer and place in separate, tared 400-ml beakers. Reweigh each beaker to determine the exact amount of sludge added. Dry in oven at 105 °C (221 °F) and cool in a desiccator to constant weight.

11.4 Analysis for Mercury. Analyze the three aqua regia-digested samples using the procedures outlined in Method 101A, Section 11.0.

12.0 Data Analysis and Calculations

12.1 Nomenclature.

C_m = Concentration of Hg in the digested sample, $\mu\text{g/g}$.

F_{sb} = Weight fraction of solids in the blended sludge.

F_{sm} = Weight fraction of solids in the collected sludge after mixing.

M = Hg content of the sewage sludge (on a dry basis), $\mu\text{g/g}$.

m = Mass of Hg in the aliquot of digested sample analyzed, μg .

n = number of digested samples (specified in Section 11.2 as three).

V_a = Volume of digested sample analyzed, ml.

V_s = Volume of digested sample, ml.

W_b = Weight of empty sample beaker, g.

W_{bs} = Weight of sample beaker and sample, g.

W_{bd} = Weight of sample beaker and sample after drying, g.

W_f = Weight of empty sample flask, g.

W_{fd} = Weight of sample flask and sample after drying, g.

W_{fs} = Weight of sample flask and sample, g.

12.2 Mercury Content of Digested Sample (Wet Basis).

12.2.1 For each sample analyzed for Hg content, calculate the arithmetic mean maximum absorbance of the two consecutive samples whose peak heights agree ± 3 percent of their average. Correct this average value for the contribution of the blank. Use the calibration curve and these corrected averages to determine the final Hg concentration in the solution cell for each sludge sample.

12.2.2 Calculate the average Hg concentration of the digested samples by correcting for any dilutions made to bring the sample into the working range of the spectrophotometer and for the weight of the sludge portion digested, using Equation 105-1.

$$\bar{C}_m = \sum_{i=1}^n \left[\frac{mV_s}{V_a(W_{bs} - W_f)} \right]_i \quad \text{Eq. 105-1}$$

12.3 Solids Content of Blended Sludge. Determine the solids content of the blended sludge using Equation 105-2.

$$F_{sb} = 1 - \frac{W_{fs} - W_{fd}}{W_{fs} - W_f} \quad \text{Eq. 105-2}$$

12.4 Solids Content of Bulk Sample (before blending but, after mixing in mortar mixer). Determine the solids content of each 100 ml aliquot (Section 11.3), and average the results.

$$F_{sm} = 1 - \frac{W_{bs} - W_{bd}}{W_{bs} - W_b} \quad \text{Eq. 105-3}$$

12.5 Mercury Content of Bulk Sample (Dry Basis). Average the results from the three samples from each 8-hr composite sample, and calculate the Hg concentration of the composite sample on a dry basis.

$$M = \frac{\bar{C}_m}{F_{sb}} \quad \text{Eq. 105-4}$$

13.0 Method Performance

13.1 Range. The range of this method is 0.2 to 5 micrograms per gram; it may be extended by increasing or decreasing sample size.

14.0 *Pollution Prevention.* [Reserved]

15.0 *Waste Management.* [Reserved]

16.0 References

1. Bishop, J.N. Mercury in Sediments. Ontario Water Resources Commission. Toronto, Ontario, Canada. 1971.
2. Salma, M. Private Communication. EPA California/Nevada Basin Office. Alameda, California.
3. Hatch, W.R. and W.L. Ott. Determination of Sub-Microgram Quantities of Mercury by Atomic Absorption Spectrophotometry. Analytical Chemistry. 40:2085. 1968.
4. Bradenberger, H., and H. Bader. The Determination of Nanogram Levels of Mercury in Solution by a Flameless Atomic Absorption Technique. Atomic Absorption Newsletter. 6:101. 1967.
5. Analytical Quality Control Laboratory (AQCL). Mercury in Sediment (Cold Vapor Technique) (Provisional Method). U.S. Environmental Protection Agency. Cincinnati, Ohio. April 1972.
6. Kopp, J.F., M.C. Longbottom, and L.B. Lobring. "Cold Vapor" Method for Determining Mercury. Journal AWWA. 64(1):20-25. 1972.
7. Manual of Methods for Chemical Analysis of Water and Wastes. U.S. Environmental Protection Agency. Cincinnati, Ohio. Publication No. EPA-624/2-74-003. December 1974. pp. 118-138.
8. Mitchell, W.J., M.R. Midgett, J. Suggs, R.J. Velton, and D. Albrink. Sampling and Homogenizing Sewage for Analysis. Environmental Monitoring and Support Laboratory, Office of Research and Development, U.S. Environmental Protection Agency. Research Triangle Park, N.C. March 1979. p. 7.

17.0 *Tables, Diagrams, Flowcharts, and Validation Data.* [Reserved]

METHOD 106—DETERMINATION OF VINYL CHLORIDE EMISSIONS FROM STATIONARY SOURCES

1.0 Scope and Application

1.1 Analytes.

Analyte	CAS No.	Sensitivity
Vinyl Chloride (CH ₂ :CHCl)	75-01-4	Dependent upon analytical equipment.

1.2 **Applicability.** This method is applicable for the determination of vinyl chloride emissions from ethylene dichloride, vinyl chloride, and polyvinyl chloride manufacturing processes. This method does not measure vinyl chloride contained in particulate matter.

1.3 **Data Quality Objectives.** Adherence to the requirements of this method will enhance the quality of the data obtained from air pollutant sampling methods.

2.0 Summary of Method

2.1 An integrated bag sample of stack gas containing vinyl chloride is subjected to GC analysis using a flame ionization detector (FID).

3.0 Definitions. [Reserved]

4.0 Interferences

4.1 Resolution interferences of vinyl chloride may be encountered on some sources. Therefore, the chromatograph operator should select the column and operating parameters best suited to the particular analysis requirements. The selection made is subject to approval of the Administrator. Approval is automatic, provided that confirming data are produced through an adequate supplemental analytical technique, and that the data are available for review by the Administrator. An example of this would be analysis with a different column or GC/mass spectroscopy.

5.0 Safety

5.1 **Disclaimer.** This method may involve hazardous materials, operations, and equipment. This test method may not address all of the safety problems associated with its use. It is the responsibility of the user of this test method to establish appropriate safety and health practices and determine the applicability of regulatory limitations prior to performing this test method.

5.2 **Toxic Analyte.** Care must be exercised to prevent exposure of sampling personnel to vinyl chloride, which is a carcinogen.

6.0 Equipment and Supplies

6.1 **Sample Collection** (see Figure 106-1). The sampling train consists of the following components:

6.1.1 **Probe.** Stainless steel, borosilicate glass, Teflon tubing (as stack temperature permits), or equivalent, equipped with a glass wool plug to remove particulate matter.

6.1.2 **Sample Lines.** Teflon, 6.4-mm outside diameter, of sufficient length to connect probe to bag. Use a new unused piece for each series of bag samples that constitutes an emission test, and discard upon completion of the test.

6.1.3 **Quick Connects.** Stainless steel, male (2) and female (2), with ball checks (one pair without), located as shown in Figure 106-1.

6.1.4 **Tedlar Bags.** 50- to 100-liter capacity, to contain sample. Aluminized Mylar bags may be used if the samples are analyzed within 24 hours of collection.

6.1.5 **Bag Containers.** Rigid leak-proof containers for sample bags, with covering to protect contents from sunlight.

6.1.6 **Needle Valve.** To adjust sample flow rates.

6.1.7 Pump. Leak-free, with minimum of 2-liter/min capacity.

6.1.8 Charcoal Tube. To prevent admission of vinyl chloride and other organics to the atmosphere in the vicinity of samplers.

6.1.9 Flowmeter. For observing sampling flow rate; capable of measuring a flow range from 0.10 to 1.00 liter/min.

6.1.10 Connecting Tubing. Teflon, 6.4-mm outside diameter, to assemble sampling train (Figure 106-1).

6.1.11 Tubing Fittings and Connectors. Teflon or stainless steel, to assemble sampling training.

6.2 Sample Recovery. Teflon tubing, 6.4-mm outside diameter, to connect bag to GC sample loop. Use a new unused piece for each series of bag samples that constitutes an emission test, and discard upon conclusion of analysis of those bags.

6.3 Analysis. The following equipment is required:

6.3.1 Gas Chromatograph. With FID potentiometric strip chart recorder and 1.0 to 5.0-ml heated sampling loop in automatic sample valve. The chromatographic system shall be capable of producing a response to 0.1-ppmv vinyl chloride that is at least as great as the average noise level. (Response is measured from the average value of the base line to the maximum of the wave form, while standard operating conditions are in use.)

6.3.2 Chromatographic Columns. Columns as listed below. Other columns may be used provided that the precision and accuracy of the analysis of vinyl chloride standards are not impaired and that information is available for review confirming that there is adequate resolution of vinyl chloride peak. (Adequate resolution is defined as an area overlap of not more than 10 percent of the vinyl chloride peak by an interferent peak. Calculation of area overlap is explained in Procedure 1 of appendix C to this part: "Determination of Adequate Chromatographic Peak Resolution.")

6.3.2.1 Column A. Stainless steel, 2.0 m by 3.2 mm, containing 80/100-mesh Chromasorb 102.

6.3.2.2 Column B. Stainless steel, 2.0 m by 3.2 mm, containing 20 percent GE SF-96 on 60/100-mesh Chromasorb P AW; or stainless steel, 1.0 m by 3.2 mm containing 80/100-mesh Porapak T. Column B is required as a secondary column if acetaldehyde is present. If used, column B is placed after column A. The combined columns should be operated at 120 °C (250 °F).

6.3.3 Rate Meters (2). Rotameter , or equivalent, 100-ml/min capacity, with flow control valves.

6.3.4 Gas Regulators. For required gas cylinders.

6.3.5 Temperature Sensor. Accurate to ± 1 °C (± 2 °F), to measure temperature of heated sample loop at time of sample injection.

6.3.6 Barometer. Accurate to ± 5 mm Hg, to measure atmospheric pressure around GC during sample analysis.

6.3.7 Pump. Leak-free, with minimum of 100-ml/min capacity.

6.3.8 Recorder. Strip chart type, optionally equipped with either disc or electronic integrator.

6.3.9 Planimeter. Optional, in place of disc or electronic integrator on recorder, to measure chromatograph peak areas.

6.4 Calibration and Standardization.

6.4.1 Tubing. Teflon, 6.4-mm outside diameter, separate pieces marked for each calibration concentration.

NOTE: The following items are required only if the optional standard gas preparation procedures (Section 10.1) are followed.

6.4.2 Tedlar Bags. Sixteen-inch-square size, with valve; separate bag marked for each calibration concentration.

6.4.3 Syringes. 0.5-ml and 50- μ l, gas tight, individually calibrated to dispense gaseous vinyl chloride.

6.4.4 Dry Gas Meter with Temperature and Pressure Gauges. Singer Model DTM-115 with 802 index, or equivalent, to meter nitrogen in preparation of standard gas mixtures, calibrated at the flow rate used to prepare standards.

7.0 Reagents and Standards

7.1 Analysis. The following reagents are required for analysis.

7.1.1 Helium or Nitrogen. Purity 99.9995 percent or greater, for chromatographic carrier gas.

7.1.2 Hydrogen. Purity 99.9995 percent or greater.

7.1.3 Oxygen or Air. Either oxygen (purity 99.99 percent or greater) or air (less than 0.1 ppmv total hydrocarbon content), as required by detector.

7.2 Calibration. Use one of the following options: either Sections 7.2.1 and 7.2.2, or Section 7.2.3.

7.2.1 Vinyl Chloride. Pure vinyl chloride gas certified by the manufacturer to contain a minimum of 99.9 percent vinyl chloride. If the gas manufacturer maintains a bulk cylinder supply of 99.9+ percent vinyl chloride, the certification analysis may have been performed on this supply, rather than on each gas cylinder prepared from this bulk supply. The date of gas cylinder preparation and the certified analysis must have been affixed to the cylinder before shipment from the gas manufacturer to the buyer.

7.2.2 Nitrogen. Same as described in Section 7.1.1.

7.2.3 Cylinder Standards. Gas mixture standards (50-, 10-, and 5 ppmv vinyl chloride) in nitrogen cylinders may be used to directly prepare a chromatograph calibration curve as described in Section 10.3 if the following conditions are met: (a) The manufacturer certifies the gas composition with an accuracy of ± 3 percent or better. (b) The manufacturer recommends a maximum shelf life over which the gas concentration does not change by greater than ± 5 percent from the certified value. (c) The manufacturer affixes the date of gas cylinder preparation, certified vinyl chloride concentration, and recommended maximum shelf to the cylinder before shipment to the buyer.

7.2.3.1 Cylinder Standards Certification. The manufacturer shall certify the concentration of vinyl chloride in nitrogen in each cylinder by (a) directly analyzing each cylinder and (b) calibrating his analytical procedure on the day of cylinder analysis. To calibrate his analytical procedure, the manufacturer shall use as a minimum, a three point calibration curve. It is recommended that the manufacturer maintain (1) a high concentration calibration standard (between 50 and 100 ppmv) to prepare his calibration curve by an appropriate dilution technique and (2) a low-concentration calibration standard (between 5 and 10 ppmv) to verify the dilution technique used. If the difference between the apparent concentration read from the calibration curve and the true concentration assigned to the low-concentration calibration standard exceeds 5 percent of the true concentration, the manufacturer shall determine the source of error and correct it, then repeat the three-point calibration.

7.2.3.2 Verification of Manufacturer's Calibration Standards. Before using a standard, the manufacturer shall verify each calibration standard (a) by comparing it to gas mixtures prepared (with 99 mole percent vinyl chloride) in accordance with the procedure described in Section 7.2.1 or (b) calibrating it against vinyl chloride cylinder Standard Reference Materials (SRM's) prepared by the National Institute of Standards and Technology, if such SRM's are available. The agreement between

the initially determined concentration value and the verification concentration value must be ± 5 percent. The manufacturer must reverify all calibration standards on a time interval consistent with the shelf life of the cylinder standards sold.

8.0 Sample Collection, Preservation, Storage, and Transport

NOTE: Performance of this method should not be attempted by persons unfamiliar with the operation of a gas chromatograph (GC) nor by those who are unfamiliar with source sampling, because knowledge beyond the scope of this presentation is required.

8.1 Bag Leak-Check. The following leak-check procedure is recommended, but not required, prior to sample collection. The post-test leak-check procedure is mandatory. Connect a water manometer and pressurize the bag to 5 to 10 cm H₂O (2 to 4 in. H₂O). Allow to stand for 10 min. Any displacement in the water manometer indicates a leak. Also, check the rigid container for leaks in this manner.

NOTE: An alternative leak-check method is to pressurize the bag to 5 to 10 cm H₂O and allow it to stand overnight. A deflated bag indicates a leak. For each sample bag in its rigid container, place a rotameter in line between the bag and the pump inlet. Evacuate the bag. Failure of the rotameter to register zero flow when the bag appears to be empty indicates a leak.

8.2 Sample Collection. Assemble the sample train as shown in Figure 106-1. Join the quick connects as illustrated, and determine that all connection between the bag and the probe are tight. Place the end of the probe at the centroid of the stack and start the pump with the needle valve adjusted to yield a flow that will fill over 50 percent of bag volume in the specific sample period. After allowing sufficient time to purge the line several times, change the vacuum line from the container to the bag and evacuate the bag until the rotameter indicates no flow. Then reposition the sample and vacuum lines and begin the actual sampling, keeping the rate proportional to the stack velocity. At all times, direct the gas exiting the rotameter away from sampling personnel. At the end of the sample period, shut off the pump, disconnect the sample line from the bag, and disconnect the vacuum line from the bag container. Protect the bag container from sunlight.

8.3 Sample Storage. Keep the sample bags out of direct sunlight. When at all possible, analysis is to be performed within 24 hours, but in no case in excess of 72 hours of sample collection. Aluminized Mylar bag samples must be analyzed within 24 hours.

8.4 Post-test Bag Leak-Check. Subsequent to recovery and analysis of the sample, leak-check the sample bag according to the procedure outlined in Section 8.1.

9.0 QUALITY CONTROL

Section	Quality control measure	Effect
10.3	Chromatograph calibration	Ensure precision and accuracy of chromatograph.

10.0 Calibration and Standardization

NOTE: Maintain a laboratory log of all calibrations.

10.1 Preparation of Vinyl Chloride Standard Gas Mixtures. (Optional Procedure-delete if cylinder standards are used.) Evacuate a 16-inch square Tedlar bag that has passed a leak-check (described in Section 8.1) and meter in 5.0 liters of nitrogen. While the bag is filling, use the 0.5-ml syringe to inject 250 μ l of 99.9+ percent vinyl chloride gas through the wall of the bag. Upon withdrawing the syringe, immediately cover the resulting hole with a piece of adhesive tape. The bag now contains a vinyl chloride concentration of 50 ppmv. In a like manner use the 50 μ l syringe to prepare gas mixtures having 10- and 5-ppmv vinyl chloride concentrations. Place each bag on a smooth surface and alternately depress opposite sides of the bag 50 times to further mix the gases. These gas mixture standards may be used for 10 days from the date of preparation, after which time new gas mixtures must be prepared. (Caution: Contamination may be a problem when a bag is reused if the new gas mixture standard is a lower concentration than the previous gas mixture standard.)

10.2 Determination of Vinyl Chloride Retention Time. (This section can be performed simultaneously with Section 10.3.) Establish chromatograph conditions identical with those in Section 11.3. Determine proper attenuator position. Flush the sampling loop with helium or nitrogen and activate the sample valve. Record the injection time, sample loop temperature, column temperature, carrier gas flow rate, chart speed, and attenuator setting. Record peaks and detector responses that occur in the absence of vinyl chloride. Maintain conditions with the equipment plumbing arranged identically to Section 11.2, and flush the sample loop for 30 seconds at the rate of 100 ml/min with one of the vinyl chloride calibration mixtures. Then activate the sample valve. Record the injection time. Select the peak that corresponds to vinyl chloride. Measure the distance on the chart from the injection time to the time at which the peak maximum occurs. This quantity divided by the chart speed is defined as the retention time. Since other organics may be present in the sample, positive identification of the vinyl chloride peak must be made.

10.3 Preparation of Chromatograph Calibration Curve. Make a GC measurement of each gas mixture standard (described in Section 7.2.3 or 10.1) using conditions identical to those listed in Sections 11.2 and 11.3. Flush the sampling loop for 30 seconds at the rate of 100 ml/min with one of the standard mixtures, and activate the sample valve. Record the concentration of vinyl chloride injected (C_c), attenuator setting, chart speed, peak area, sample loop temperature, column temperature, carrier gas flow rate, and retention time. Record the barometric pressure. Calculate A_c , the peak area multiplied by the attenuator setting. Repeat until two consecutive injection areas are within 5 percent, then plot the average of those two values versus C_c . When the other standard gas mixtures have been similarly analyzed and plotted, draw a straight line through the points derived by the least squares method. Perform calibration daily, or before and after the analysis of each emission test set of bag samples, whichever is more frequent. For each group of sample analyses, use the average of the two calibration curves which bracket that group to determine the respective sample concentrations. If the two calibration curves differ by more than 5 percent from their mean value, then report the final results by both calibration curves.

11.0 Analytical Procedure

11.2 Sample Recovery. With a new piece of Teflon tubing identified for that bag, connect a bag inlet valve to the gas chromatograph sample valve. Switch the valve to receive gas from the bag through the sample loop. Arrange the equipment so the sample gas passes from the sample valve to 100-ml/min rotameter with flow control valve followed by a charcoal tube and a 1-in. H_2O pressure gauge. Maintain the sample flow either by a vacuum pump or container pressurization if the collection bag remains in the rigid container. After sample loop purging is ceased, allow the pressure gauge to return to zero before activating the gas sampling valve.

11.3 Analysis.

11.3.1 Set the column temperature to 100 °C (210 °F) and the detector temperature to 150 °C (300 °F). When optimum hydrogen and oxygen (or air) flow rates have been determined, verify and maintain these flow rates during all chromatography operations. Using helium or nitrogen as the carrier gas, establish a flow rate in the range consistent with the manufacturer's requirements for satisfactory detector operation. A flow rate of approximately 40 ml/min should produce adequate separations. Observe the base line periodically and determine that the noise level has stabilized and that base line drift has ceased. Purge the sample loop for 30 seconds at the rate of 100 ml/min, shut off flow, allow the sample loop pressure to reach atmospheric pressure as indicated by the H_2O manometer, then activate the sample valve. Record the injection time (the position of the pen on the chart at the time of sample injection), sample number, sample loop temperature, column temperature, carrier gas flow rate, chart speed, and attenuator setting. Record the barometric pressure. From the chart, note the peak having the retention time corresponding to vinyl chloride as determined in Section 10.2. Measure the vinyl chloride peak area, A_m , by use of a disc integrator, electronic integrator, or a planimeter. Measure and record the peak heights, H_m . Record A_m and retention time. Repeat the injection at least two times or until two consecutive values for the total area of the vinyl chloride peak agree within 5 percent of their average. Use the average value for these two total areas to compute the bag concentration.

11.3.2 Compare the ratio of H_m to A_m for the vinyl chloride sample with the same ratio for the standard peak that is closest in height. If these ratios differ by more than 10 percent, the vinyl chloride peak may not be pure (possibly acetaldehyde is present) and the secondary column should be employed (see Section 6.3.2.2).

11.4 Determination of Bag Water Vapor Content. Measure the ambient temperature and barometric pressure near the bag. From a water saturation vapor pressure table, determine and record the water vapor content of the bag, B_{wb} , as a decimal figure. (Assume the relative humidity to be 100 percent unless a lesser value is known.)

12.0 Calculations and Data Analysis

12.1 Nomenclature.

A_m = Measured peak area.

A_f = Attenuation factor.

B_{wb} = Water vapor content of the bag sample, as analyzed, volume fraction.

C_b = Concentration of vinyl chloride in the bag, ppmv.

C_c = Concentration of vinyl chloride in the standard sample, ppmv.

P_i = Laboratory pressure at time of analysis, mm Hg.

P_r = Reference pressure, the laboratory pressure recorded during calibration, mm Hg.

T_i = Absolute sample loop temperature at the time of analysis, °K (°R).

T_r = Reference temperature, the sample loop temperature recorded during calibration, °K (°R).

12.2 Sample Peak Area. Determine the sample peak area, A_c , as follows:

$$A_c = A_m A_f \quad \text{Eq. 106-1}$$

12.3 Vinyl Chloride Concentration. From the calibration curves prepared in Section 10.3, determine the average concentration value of vinyl chloride, C_c , that corresponds to A_c , the sample peak area. Calculate the concentration of vinyl chloride in the bag, C_b , as follows:

$$C_b = \frac{C_c P_r T_i}{P_i T_r (1 - B_{wb})} \quad \text{Eq. 106-2}$$

13.0 Method Performance

13.1 Analytical Range. This method is designed for the 0.1 to 50 parts per million by volume (ppmv) range. However, common gas chromatograph (GC) instruments are capable of detecting 0.02 ppmv vinyl chloride. With proper calibration, the upper limit may be extended as needed.

14.0 Pollution Prevention, [Reserved]

15.0 Waste Management, [Reserved]

16.0 References

1. Brown D.W., E.W. Loy, and M.H. Stephenson. Vinyl Chloride Monitoring Near the B. F. Goodrich Chemical Company in Louisville, KY. Region IV, U.S. Environmental Protection Agency, Surveillance and Analysis Division, Athens, GA. June 24, 1974.

2. G.D. Clayton and Associates. Evaluation of a Collection and Analytical Procedure for Vinyl Chloride in Air. U.S. Environmental Protection Agency, Research Triangle Park, N.C. EPA Contract No. 68-02-1408, Task Order No. 2, EPA Report No. 75-VCL-1. December 13, 1974.

3. Midwest Research Institute. Standardization of Stationary Source Emission Method for Vinyl Chloride. U.S. Environmental Protection Agency, Research Triangle Park, N.C. Publication No. EPA-600/4-77-026. May 1977.

4. Scheil, G. and M.C. Sharp. Collaborative Testing of EPA Method 106 (Vinyl Chloride) that Will Provide for a Standardized Stationary Source Emission Measurement Method. U.S. Environmental Protection Agency, Research Triangle Park, N.C. Publication No. EPA 600/4-78-058. October 1978.

17.0 Tables, Diagrams Flowcharts, and Validation Data.

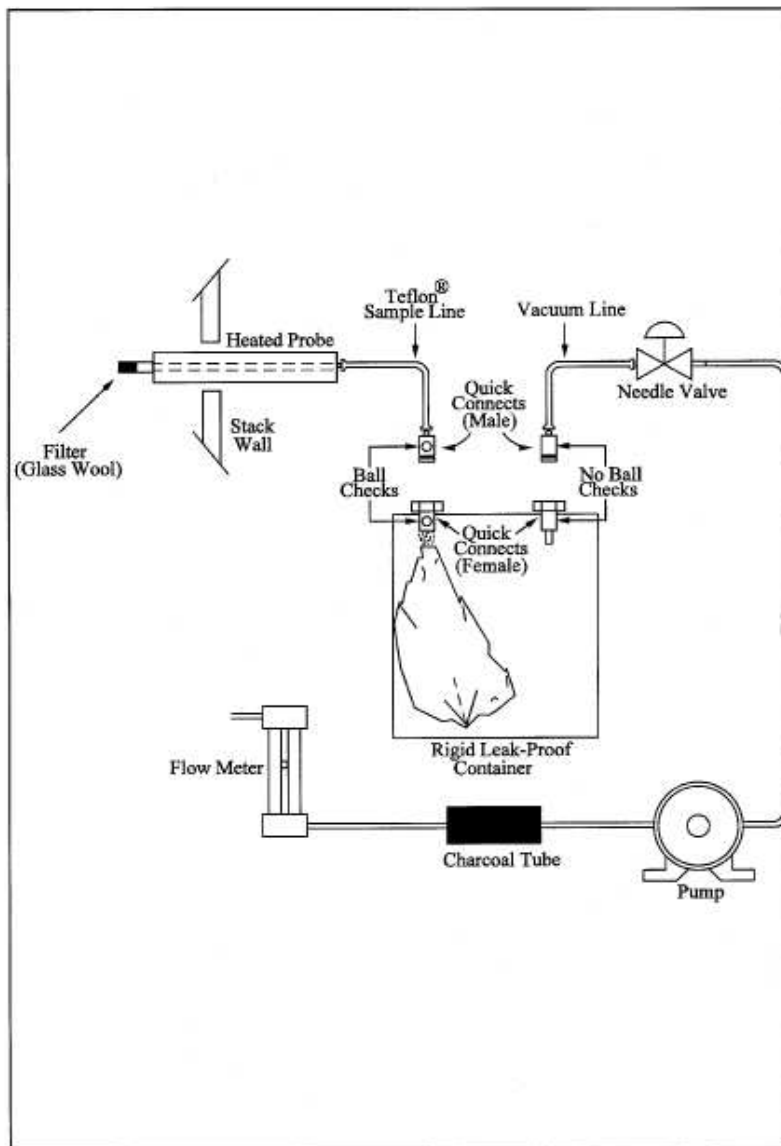

Figure 106-1. Integrated-bag sampling train.

[View or download PDF](#)

METHOD 107—DETERMINATION OF VINYL CHLORIDE CONTENT OF IN-PROCESS WASTEWATER SAMPLES, AND VINYL CHLORIDE CONTENT OF POLYVINYL CHLORIDE RESIN SLURRY, WET CAKE, AND LATEX SAMPLES

NOTE: Performance of this method should not be attempted by persons unfamiliar with the operation of a gas chromatograph (GC) nor by those who are unfamiliar with source sampling, because knowledge beyond the scope of this presentation is required. This method does not include all of the specifications (*e.g.*, equipment and supplies) and procedures (*e.g.*, sampling and analytical) essential to its performance. Some material is incorporated by reference from other methods in this part. Therefore, to obtain reliable results, persons using this method should have a thorough knowledge of at least the following additional test methods: Method 106.

1.0 Scope and Application

1.1 Analytes.

Analyte	CAS No.	Sensitivity
Vinyl Chloride (CH ₂ :CHCl)	75-01-4	Dependent upon analytical equipment.

1.2 Applicability. This method is applicable for the determination of the vinyl chloride monomer (VCM) content of in-process wastewater samples, and the residual vinyl chloride monomer (RCVM) content of polyvinyl chloride (PVC) resins, wet, cake, slurry, and latex samples. It cannot be used for polymer in fused forms, such as sheet or cubes. This method is not acceptable where methods from section 304(h) of the Clean Water Act, 33 U.S.C. 1251 *et seq.* (the Federal Water Pollution Control Amendments of 1972 as amended by the Clean Water Act of 1977) are required.

1.3 Data Quality Objectives. Adherence to the requirements of this method will enhance the quality of the data obtained from air pollutant sampling methods.

2.0 Summary of Method

2.1 The basis for this method relates to the vapor equilibrium that is established at a constant known temperature in a closed system between RVCM, PVC resin, water, and air. The RVCM in a PVC resin will equilibrate rapidly in a closed vessel, provided that the temperature of the PVC resin is maintained above the glass transition temperature of that specific resin.

2.2 A sample of PVC or in-process wastewater is collected in a vial or bottle and is conditioned. The headspace in the vial or bottle is then analyzed for vinyl chloride using gas chromatography with a flame ionization detector.

3.0 Definitions [Reserved]

4.0 Interferences

4.1 The chromatograph columns and the corresponding operating parameters herein described normally provide an adequate resolution of vinyl chloride; however, resolution interferences may be encountered on some sources. Therefore, the chromatograph operator shall select the column and operating parameters best suited to his particular analysis requirements, subject to the approval of the Administrator. Approval is automatic provided that confirming data are produced through an adequate supplemental analytical technique, such as analysis with a different column or GC/mass spectroscopy, and that these data are made available for review by the Administrator.

5.0 Safety

5.1 Disclaimer. This method may involve hazardous materials, operations, and equipment. This test method may not address all of the safety problems associated with its use. It is the responsibility of the user of this test method to establish appropriate safety and health practices and determine the applicability of regulatory limitations prior to performing this test method.

5.2 Toxic Analyte. Care must be exercised to prevent exposure of sampling personnel to vinyl chloride, which is a carcinogen. Do not release vinyl chloride to the laboratory atmosphere during preparation of standards. Venting or purging with VCM/air mixtures must be held to a minimum. When they are required, the vapor must be routed to outside air. Vinyl chloride, even at low ppm levels, must never be vented inside the laboratory. After vials have been analyzed, the gas must be vented prior to

removal of the vial from the instrument turntable. Vials must be vented through a hypodermic needle connected to an activated charcoal tube to prevent release of vinyl chloride into the laboratory atmosphere. The charcoal must be replaced prior to vinyl chloride breakthrough.

6.0 *Equipment and Supplies*

6.1 Sample Collection. The following equipment is required:

6.1.1 Glass bottles. 60-ml (2-oz) capacity, with wax-lined screw-on tops, for PVC samples.

6.1.2 Glass Vials. Headspace vials, with Teflon-faced butyl rubber sealing discs, for water samples.

6.1.3 Adhesive Tape. To prevent loosening of bottle tops.

6.2 Sample Recovery. The following equipment is required:

6.2.1 Glass Vials. Headspace vials, with butyl rubber septa and aluminum caps. Silicone rubber is not acceptable.

6.2.2 Analytical Balance. Capable of determining sample weight within an accuracy of ± 1 percent.

6.2.3 Vial Sealer. To seal headspace vials.

6.2.4 Syringe. 100-ml capacity.

6.3 Analysis. The following equipment is required:

6.3.1 Headspace Sampler and Chromatograph. Capable of sampling and analyzing a constant amount of headspace gas from a sealed vial, while maintaining that vial at a temperature of $90\text{ }^{\circ}\text{C} \pm 0.5\text{ }^{\circ}\text{C}$ ($194\text{ }^{\circ}\text{F} \pm 0.9\text{ }^{\circ}\text{F}$). The chromatograph shall be equipped with a flame ionization detector (FID). Perkin-Elmer Corporation Models F-40, F-42, F-45, HS-6, and HS-100, and Hewlett-Packard Corporation Model 19395A have been found satisfactory. Chromatograph backflush capability may be required.

6.3.2 Chromatographic Columns. Stainless steel 1 m by 3.2 mm and 2 m by 3.2 mm, both containing 50/80-mesh Porapak Q. Other columns may be used provided that the precision and accuracy of the analysis of vinyl chloride standards are not impaired and information confirming that there is adequate resolution of the vinyl chloride peak are available for review. (Adequate resolution is defined as an area overlap of not more than 10 percent of the vinyl chloride peak by an interferant peak. Calculation of area overlap is explained in Procedure 1 of appendix C to this part: "Determination of Adequate Chromatographic Peak Resolution.") Two 1.83 m columns, each containing 1 percent Carbowax 1500 on Carbopak B, have been found satisfactory for samples containing acetaldehyde.

6.3.3 Temperature Sensor. Range 0 to $100\text{ }^{\circ}\text{C}$ (32 to $212\text{ }^{\circ}\text{F}$) accurate to $0.1\text{ }^{\circ}\text{C}$.

6.3.4 Integrator-Recorder. To record chromatograms.

6.3.5 Barometer. Accurate to 1 mm Hg.

6.3.6 Regulators. For required gas cylinders.

6.3.7 Headspace Vial Pre-Pressurizer. Nitrogen pressurized hypodermic needle inside protective shield.

7.0 *Reagents and Standards*

7.1 Analysis. Same as Method 106, Section 7.1, with the addition of the following:

7.1.1 Water. Interference-free.

7.2 Calibration. The following items are required for calibration:

7.2.1 Cylinder Standards (4). Gas mixture standards (50-, 500-, 2000- and 4000-ppm vinyl chloride in nitrogen cylinders). Cylinder standards may be used directly to prepare a chromatograph calibration curve as described in Section 10.3, if the following conditions are met: (a) The manufacturer certifies the gas composition with an accuracy of ± 3 percent or better (see Section 7.2.1.1). (b) The manufacturer recommends a maximum shelf life over which the gas concentration does not change by greater than ± 5 percent from the certified value. (c) The manufacturer affixes the date of gas cylinder preparation, certified vinyl chloride concentration, and recommended maximum shelf life to the cylinder before shipment to the buyer.

7.2.1.1 Cylinder Standards Certification. The manufacturer shall certify the concentration of vinyl chloride in nitrogen in each cylinder by (a) directly analyzing each cylinder and (b) calibrating the analytical procedure on the day of cylinder analysis. To calibrate the analytical procedure, the manufacturer shall use, as a minimum, a 3-point calibration curve. It is recommended that the manufacturer maintain (1) a high-concentration calibration standard (between 4000 and 8000 ppm) to prepare the calibration curve by an appropriate dilution technique and (2) a low-concentration calibration standard (between 50 and 500 ppm) to verify the dilution technique used. If the difference between the apparent concentration read from the calibration curve and the true concentration assigned to the low-concentration calibration standard exceeds 5 percent of the true concentration, the manufacturer shall determine the source of error and correct it, then repeat the 3-point calibration.

7.2.1.2 Verification of Manufacturer's Calibration Standards. Before using, the manufacturer shall verify each calibration standard by (a) comparing it to gas mixtures prepared (with 99 mole percent vinyl chloride) in accordance with the procedure described in Section 10.1 of Method 106 or by (b) calibrating it against vinyl chloride cylinder Standard Reference Materials (SRMs) prepared by the National Institute of Standards and Technology, if such SRMs are available. The agreement between the initially determined concentration value and the verification concentration value must be within 5 percent. The manufacturer must reverify all calibration standards on a time interval consistent with the shelf life of the cylinder standards sold.

8.0 Sample Collection, Preservation, Storage, and Transport

8.1 Sample Collection.

8.1.1 PVC Sampling. Allow the resin or slurry to flow from a tap on the tank or silo until the tap line has been well purged. Extend and fill a 60-ml sample bottle under the tap, and immediately tighten a cap on the bottle. Wrap adhesive tape around the cap and bottle to prevent the cap from loosening. Place an identifying label on each bottle, and record the date, time, and sample location both on the bottles and in a log book.

8.1.2 Water Sampling. At the sampling location fill the vials bubble-free to overflowing so that a convex meniscus forms at the top. The excess water is displaced as the sealing disc is carefully placed, with the Teflon side down, on the opening of the vial. Place the aluminum seal over the disc and the neck of the vial, and crimp into place. Affix an identifying label on the bottle, and record the date, time, and sample location both on the vials and in a log book.

8.2 Sample Storage. All samples must be analyzed within 24 hours of collection, and must be refrigerated during this period.

9.0 Quality Control

Section	Quality control measure	Effect
10.3	Chromatograph calibration	Ensure precision and accuracy of chromatograph.

10.0 Calibration and Standardization

NOTE: Maintain a laboratory log of all calibrations.

10.1 Preparation of Standards. Calibration standards are prepared as follows: Place 100 µl or about two equal drops of distilled water in the sample vial, then fill the vial with the VCM/nitrogen standard, rapidly seat the septum, and seal with the aluminum cap. Use a 1/8 -in. stainless steel line from the cylinder to the vial. Do not use rubber or Tygon tubing. The sample line from the cylinder must be purged (into a properly vented hood) for several minutes prior to filling the vials. After purging, reduce the flow rate to between 500 and 1000 cc/min. Place end of tubing into vial (near bottom). Position a septum on top of the vial, pressing it against the 1/8 -in. filling tube to minimize the size of the vent opening. This is necessary to minimize mixing air with the standard in the vial. Each vial is to be purged with standard for 90 seconds, during which time the filling tube is gradually slid to the top of the vial. After the 90 seconds, the tube is removed with the septum, simultaneously sealing the vial. Practice will be necessary to develop good technique. Rubber gloves should be worn during the above operations. The sealed vial must then be pressurized for 60 seconds using the vial prepressurizer. Test the vial for leakage by placing a drop of water on the septum at the needle hole. Prepressurization of standards is not required unless samples have been prepressurized.

10.2 Analyzer Calibration. Calibration is to be performed each 8-hour period the chromatograph is used. Alternatively, calibration with duplicate 50-, 500-, 2,000-, and 4,000-ppm standards (hereafter described as a four-point calibration) may be performed on a monthly basis, provided that a calibration confirmation test consisting of duplicate analyses of an appropriate standard is performed once per plant shift, or once per chromatograph carousel operation (if the chromatograph operation is less frequent than once per shift). The criterion for acceptance of each calibration confirmation test is that both analyses of 500-ppm standards [2,000-ppm standards if dispersion resin (excluding latex resin) samples are being analyzed] must be within 5 percent of the most recent four-point calibration curve. If this criterion is not met, then a complete four-point calibration must be performed before sample analyses can proceed.

10.3 Preparation of Chromatograph Calibration Curve. Prepare two vials each of 50-, 500-, 2,000-, and 4,000-ppm standards. Run the calibration samples in exactly the same manner as regular samples. Plot A_s , the integrator area counts for each standard sample, versus C_c , the concentration of vinyl chloride in each standard sample. Draw a straight line through the points derived by the least squares method.

11.0 Analytical Procedure

11.1 Preparation of Equipment. Install the chromatographic column and condition overnight at 160 °C (320 °F). In the first operation, Porapak columns must be purged for 1 hour at 230 °C (450 °F).

Do not connect the exit end of the column to the detector while conditioning. Hydrogen and air to the detector must be turned off while the column is disconnected.

11.2 Flow Rate Adjustments. Adjust flow rates as follows:

11.2.1. Nitrogen Carrier Gas. Set regulator on cylinder to read 50 psig. Set regulator on chromatograph to produce a flow rate of 30.0 cc/min. Accurately measure the flow rate at the exit end of the column using the soap film flowmeter and a stopwatch, with the oven and column at the analysis temperature. After the instrument program advances to the "B" (backflush) mode, adjust the nitrogen pressure regulator to exactly balance the nitrogen flow rate at the detector as was obtained in the "A" mode.

11.2.2. Vial Prepressurizer Nitrogen.

11.2.2.1 After the nitrogen carrier is set, solve the following equation and adjust the pressure on the vial prepressurizer accordingly.

$$P = \frac{T_1}{T_2} \left[P_1 - \frac{P_{w1} - P_{w2}}{7.50} \right] - 10kPa \quad \text{Eq. 107-1}$$

Where:

T_1 = Ambient temperature, °K (°R).

T_2 = Conditioning bath temperature, °K (°R).

P_1 = Gas chromatograph absolute dosing pressure (analysis mode), k Pa.

P_{w1} = Water vapor pressure 525.8 mm Hg @ 90 °C.

P_{w2} = Water vapor pressure 19.8 mm Hg @ 22 °C.

7.50 = mm Hg per k Pa.

10 kPa = Factor to adjust the prepressurized pressure to slightly less than the dosing pressure.

11.2.2.2 Because of gauge errors, the apparatus may over-pressurize the vial. If the vial pressure is at or higher than the dosing pressure, an audible double injection will occur. If the vial pressure is too low, errors will occur on resin samples because of inadequate time for head-space gas equilibrium. This condition can be avoided by running several standard gas samples at various pressures around the calculated pressure, and then selecting the highest pressure that does not produce a double injection. All samples and standards must be pressurized for 60 seconds using the vial prepressurizer. The vial is then placed into the 90 °C conditioning bath and tested for leakage by placing a drop of water on the septum at the needle hole. A clean, burr-free needle is mandatory.

11.2.3. Burner Air Supply. Set regulator on cylinder to read 50 psig. Set regulator on chromatograph to supply air to burner at a rate between 250 and 300 cc/min. Check with bubble flowmeter.

11.2.4. Hydrogen Supply. Set regulator on cylinder to read 30 psig. Set regulator on chromatograph to supply approximately 35 ±5 cc/min. Optimize hydrogen flow to yield the most sensitive detector response without extinguishing the flame. Check flow with bubble meter and record this flow.

11.3 Temperature Adjustments. Set temperatures as follows:

11.3.1. Oven (chromatograph column), 140 °C (280 °F).

11.3.2. Dosing Line, 150 °C (300 °F).

11.3.3. Injection Block, 170 °C (340 °F).

11.3.4. Sample Chamber, Water Temperature, 90 °C ±1.0 °C (194 °F ±1.8 °F).

11.4 Ignition of Flame Ionization Detector. Ignite the detector according to the manufacturer's instructions.

11.5 Amplifier Balance. Balance the amplifier according to the manufacturer's instructions.

11.6 Programming the Chromatograph. Program the chromatograph as follows:

11.6.1. I—Dosing or Injection Time. The normal setting is 2 seconds.

11.6.2. A—Analysis Time. The normal setting is approximately 70 percent of the VCM retention time. When this timer terminates, the programmer initiates backflushing of the first column.

11.6.3. B—Backflushing Time. The normal setting is double the analysis time.

11.6.4. W—Stabilization Time. The normal setting is 0.5 min to 1.0 min.

11.6.5. X—Number of Analyses Per Sample. The normal setting is one.

11.7. Sample Treatment. All samples must be recovered and analyzed within 24 hours after collection.

11.7.1 Resin Samples. The weight of the resin used must be between 0.1 and 4.5 grams. An exact weight must be obtained (within ± 1 percent) for each sample. In the case of suspension resins, a volumetric cup can be prepared for holding the required amount of sample. When the cup is used, open the sample bottle, and add the cup volume of resin to the tared sample vial (tared, including septum and aluminum cap). Obtain the exact sample weight, add 100 ml or about two equal drops of water, and immediately seal the vial. Report this value on the data sheet; it is required for calculation of RVCM. In the case of dispersion resins, the cup cannot be used. Weigh the sample in an aluminum dish, transfer the sample to the tared vial, and accurately weigh it in the vial. After prepressurization of the samples, condition them for a minimum of 1 hour in the 90 °C (190 °F) bath. Do not exceed 5 hours. Prepressurization is not required if the sample weight, as analyzed, does not exceed 0.2 gram. It is also not required if solution of the prepressurization equation yields an absolute prepressurization value that is within 30 percent of the atmospheric pressure.

NOTE: Some aluminum vial caps have a center section that must be removed prior to placing into sample tray. If the cap is not removed, the injection needle will be damaged.

11.7.2 Suspension Resin Slurry and Wet Cake Samples. Decant the water from a wet cake sample, and turn the sample bottle upside down onto a paper towel. Wait for the water to drain, place approximately 0.2 to 4.0 grams of the wet cake sample in a tared vial (tared, including septum and aluminum cap) and seal immediately. Then determine the sample weight (1 percent). All samples weighing over 0.2 gram, must be prepressurized prior to conditioning for 1 hour at 90 °C (190 °F), except as noted in Section 11.7.1. A sample of wet cake is used to determine total solids (TS). This is required for calculating the RVCM.

11.7.3 Dispersion Resin Slurry and Geon Latex Samples. The materials should not be filtered. Sample must be thoroughly mixed. Using a tared vial (tared, including septum and aluminum cap) add approximately eight drops (0.25 to 0.35 g) of slurry or latex using a medicine dropper. This should be done immediately after mixing. Seal the vial as soon as possible. Determine sample weight (1 percent). Condition the vial for 1 hour at 90 °C (190 °F) in the analyzer bath. Determine the TS on the slurry sample (Section 11.10).

11.7.4 In-process Wastewater Samples. Using a tared vial (tared, including septum and aluminum cap) quickly add approximately 1 cc of water using a medicine dropper. Seal the vial as soon as possible. Determine sample weight (1 percent). Condition the vial for 1 hour at 90 °C (190 °F) in the analyzer bath.

11.8 Preparation of Sample Turntable.

11.8.1 Before placing any sample into turntable, be certain that the center section of the aluminum cap has been removed. The numbered sample vials should be placed in the corresponding numbered positions in the turntable. Insert samples in the following order:

11.8.1.1 Positions 1 and 2. Old 2000-ppm standards for conditioning. These are necessary only after the analyzer has not been used for 24 hours or longer.

11.8.1.2 Position 3. 50-ppm standard, freshly prepared.

11.8.1.3 Position 4. 500-ppm standard, freshly prepared.

11.8.1.4 Position 5. 2000-ppm standard, freshly prepared.

11.8.1.5 Position 6. 4000-ppm standard, freshly prepared.

11.8.1.6 Position 7. Sample No. 7 (This is the first sample of the day, but is given as 7 to be consistent with the turntable and the integrator printout.)

11.8.2 After all samples have been positioned, insert the second set of 50-, 500-, 2000-, and 4000-ppm standards. Samples, including standards, must be conditioned in the bath of 90 °C (190 °F) for a minimum of one hour and a maximum of five hours.

11.9 Start Chromatograph Program. When all samples, including standards, have been conditioned at 90 °C (190 °F) for at least one hour, start the analysis program according to the manufacturer's instructions. These instructions must be carefully followed when starting and stopping a program to prevent damage to the dosing assembly.

11.10 Determination of Total Solids. For wet cake, slurry, resin solution, and PVC latex samples, determine TS for each sample by accurately weighing approximately 3 to 4 grams of sample in an aluminum pan before and after placing in a draft oven (105 to 110 °C (221 to 230 °F)). Samples must be dried to constant weight. After first weighing, return the pan to the oven for a short period of time, and then reweigh to verify complete dryness. The TS are then calculated as the final sample weight divided by initial sample weight.

12.0 Calculations and Data Analysis

12.1 Nomenclature.

A_s = Chromatogram area counts of vinyl chloride for the sample, area counts.

A_s = Chromatogram area counts of vinyl chloride for the sample.

C_c = Concentration of vinyl chloride in the standard sample, ppm.

K_p = Henry's Law Constant for VCM in PVC 90 °C, 6.52×10^{-6} g/g/mm Hg.

K_w = Henry's Law Constant for VCM in water 90 °C, 7×10^{-7} g/g/mm Hg.

M_v = Molecular weight of VCM, 62.5 g/mole.

m = Sample weight, g.

P_a = Ambient atmospheric pressure, mm Hg.

R = Gas constant, (62360³ ml) (mm Hg)/(mole)(°K).

R_f = Response factor in area counts per ppm VCM.

R_s = Response factor, area counts/ppm.

T_1 = Ambient laboratory temperature, °K.

TS = Total solids expressed as a decimal fraction.

T_2 = Equilibrium temperature, °K.

V_g = Volume of vapor phase, ml.

$$= V_v - \frac{m(TS)}{1.36} - \frac{m(1-TS)}{0.9653}$$

V_v = Vial volume,³ ml.

1.36 = Density of PVC at 90 °C, g/³ ml.

0.9653 = Density of water at 90 °C, g/³ ml.

12.2 Response Factor. If the calibration curve described in Section 10.3 passes through zero, an average response factor, R_f , may be used to facilitate computation of vinyl chloride sample concentrations.

12.2.1 To compute R_f , first compute a response factor, R_s , for each sample as follows:

$$R_s = \frac{A}{C_c} \quad \text{Eq. 107-2}$$

12.2.2 Sum the individual response factors, and calculate R_f . If the calibration curve does not pass through zero, use the calibration curve to determine each sample concentration.

12.3 Residual Vinyl Chloride Monomer Concentration, (C_{rvc}) or Vinyl Chloride Monomer Concentration. Calculate C_{rvc} in ppm or mg/kg as follows:

$$C_{rvc} = \frac{A_s P_2}{R_f T_1} \left[\frac{M_v V_g}{Rm} + K_p (TS) T_2 K_w (1 - TS) T_2 \right] \quad \text{Eq. 107-3}$$

NOTE: Results calculated using these equations represent concentration based on the total sample. To obtain results based on dry PVC content, divide by TS.

13.0 Method Performance

13.1 Range and Sensitivity. The lower limit of detection of vinyl chloride will vary according to the sampling and chromatographic system. The system should be capable of producing a measurement for a 50-ppm vinyl chloride standard that is at least 10 times the standard deviation of the system background noise level.

13.2 An interlaboratory comparison between seven laboratories of three resin samples, each split into three parts, yielded a standard deviation of 2.63 percent for a sample with a mean of 2.09 ppm, 4.16 percent for a sample with a mean of 1.66 ppm, and 5.29 percent for a sample with a mean of 62.66 ppm.

14.0 Pollution Prevention [Reserved]

15.0 Waste Management [Reserved]

16.0 References

1. B.F. Goodrich, Residual Vinyl Chloride Monomer Content of Polyvinyl Chloride Resins, Latex, Wet Cake, Slurry and Water Samples. B.F. Goodrich Chemical Group Standard Test Procedure No. 1005-E. B.F. Goodrich Technical Center, Avon Lake, Ohio. October 8, 1979.
2. Berens, A.R. The Diffusion of Vinyl Chloride in Polyvinyl Chloride. ACS-Division of Polymer Chemistry, Polymer Preprints 15 (2):197. 1974.
3. Berens, A.R. The Diffusion of Vinyl Chloride in Polyvinyl Chloride. ACS-Division of Polymer Chemistry, Polymer Preprints 15 (2):203. 1974.
4. Berens, A.R., *et. al.* Analysis for Vinyl Chloride in PVC Powders by Head-Space Gas Chromatography. Journal of Applied Polymer Science. 19:3169-3172. 1975.
5. Mansfield, R.A. The Evaluation of Henry's Law Constant (K_p) and Water Enhancement in the Perkin-Elmer Multifract F-40 Gas Chromatograph. B.F. Goodrich. Avon Lake, Ohio. February 10, 1978.

17.0 Tables, Diagrams, Flowcharts, and Validation Data [Reserved]

METHOD 107A—DETERMINATION OF VINYL CHLORIDE CONTENT OF SOLVENTS, RESIN-SOLVENT SOLUTION, POLYVINYL CHLORIDE RESIN, RESIN SLURRY, WET RESIN, AND LATEX SAMPLES

Introduction

Performance of this method should not be attempted by persons unfamiliar with the operation of a gas chromatograph (GC) or by those who are unfamiliar with source sampling because knowledge beyond the scope of this presentation is required. Care must be exercised to prevent exposure of sampling personnel to vinyl chloride, a carcinogen.

1. *Applicability and Principle*

1.1 *Applicability.* This is an alternative method and applies to the measurement of the vinyl chloride content of solvents, resin solvent solutions, polyvinyl chloride (PVC) resin, wet cake slurries, latex, and fabricated resin samples. This method is not acceptable where methods from Section 304 (h) of the Clean Water Act, 33 U.S.C. 1251 *et seq.*, (the Federal Water Pollution Control Act Amendments of 1972 as amended by the Clean Water Act of 1977) are required.

1.2 *Principle.* The basis for this method lies in the direct injection of a liquid sample into a chromatograph and the subsequent evaporation of all volatile material into the carrier gas stream of the chromatograph, thus permitting analysis of all volatile material including vinyl chloride.

2. *Range and Sensitivity*

The lower limit of detection of vinyl chloride in dry PVC resin is 0.2 ppm. For resin solutions, latexes, and wet resin, this limit rises inversely as the nonvolatile (resin) content decreases.

With proper calibration, the upper limit may be extended as needed.

3. *Interferences*

The chromatograph columns and the corresponding operating parameters herein described normally provide an adequate resolution of vinyl chloride. In cases where resolution interferences are encountered, the chromatograph operator shall select the column and operating parameters best suited to his particular analysis problem, subject to the approval of the Administrator. Approval is automatic, provided that the tester produces confirming data through an adequate supplemental analytical technique, such as analysis with a different column or GC/mass spectroscopy, and has the data available for review by the Administrator.

4. *Precision and Reproducibility*

A standard sample of latex containing 181.8 ppm vinyl chloride analyzed 10 times by the alternative method showed a standard deviation of 7.5 percent and a mean error of 0.21 percent.

A sample of vinyl chloride copolymer resin solution was analyzed 10 times by the alternative method and showed a standard deviation of 6.6 percent at a level of 35 ppm.

5. *Safety*

Do not release vinyl chloride to the laboratory atmosphere during preparation of standards. Venting or purging with vinyl chloride monomer (VCM) air mixtures must be held to minimum. When purging is required, the vapor must be routed to outside air. Vinyl chloride, even at low-ppm levels, must never be vented inside the laboratory.

6. *Apparatus*

6.1 *Sampling.* The following equipment is required:

6.1.1 *Glass Bottles.* 16-oz wide mouth wide polyethylene-lined, screw-on tops.

6.1.2 Adhesive Tape. To prevent loosening of bottle tops.

6.2 Sample Recovery. The following equipment is required:

6.2.1 Glass Vials. 20-ml capacity with polycone screw caps.

6.2.2 Analytical Balance. Capable of weighing to ± 0.01 gram.

6.2.3 Syringe. 50-microliter size, with removable needle.

6.2.4 Fritted Glass Sparger. Fine porosity.

6.2.5 Aluminum Weighing Dishes.

6.2.6 Sample Roller or Shaker. To help dissolve sample.

6.3 Analysis. The following equipment is required:

6.3.1 Gas Chromatograph. Hewlett Packard Model 5720A or equivalent.

6.3.2 Chromatograph Column. Stainless steel, 6.1 m by 3.2 mm, packed with 20 percent Tergitol E-35 on Chromosorb W AW 60/80 mesh. The analyst may use other columns provided that the precision and accuracy of the analysis of vinyl chloride standards are not impaired and that he has available for review information confirming that there is adequate resolution of the vinyl chloride peak. (Adequate resolution is defined as an area overlap of not more than 10 percent of the vinyl chloride peak by an interfering peak. Calculation of area overlap is explained in Appendix C, Procedure 1: "Determination of Adequate Chromatographic Peak Resolution.")

6.3.3 Valco Instrument Six-Port Rotary Valve. For column back flush.

6.3.4 Septa. For chromatograph injection port.

6.3.5 Injection Port Liners. For chromatograph used.

6.3.6 Regulators. For required gas cylinders.

6.3.7 Soap Film Flowmeter. Hewlett Packard No. 0101-0113 or equivalent.

6.4 Calibration. The following equipment is required:

6.4.1 Analytical Balance. Capable of weighing to ± 0.0001 g.

6.4.2 Erlenmeyer Flask With Glass Stopper. 125 ml.

6.4.3 Pipets. 0.1, 0.5, 1, 5, 10, and 50 ml.

6.4.4 Volumetric Flasks. 10 and 100 ml.

7. Reagents

Use only reagents that are of chromatograph grade.

7.1 Analysis. The following items are required:

7.1.1 Hydrogen Gas. Zero grade.

7.1.2 Nitrogen Gas. Zero grade.

7.1.3 Air. Zero grade.

7.1.4 Tetrahydrofuran (THF). Reagent grade.

Analyze the THF by injecting 10 microliters into the prepared gas chromatograph. Compare the THF chromatogram with that shown in Figure 107A-1. If the chromatogram is comparable to A, the THF should be sparged with pure nitrogen for approximately 2 hours using the fritted glass sparger to attempt to remove the interfering peak. Reanalyze the sparged THF to determine whether the THF is acceptable for use. If the scan is comparable to B, the THF should be acceptable for use in the analysis.

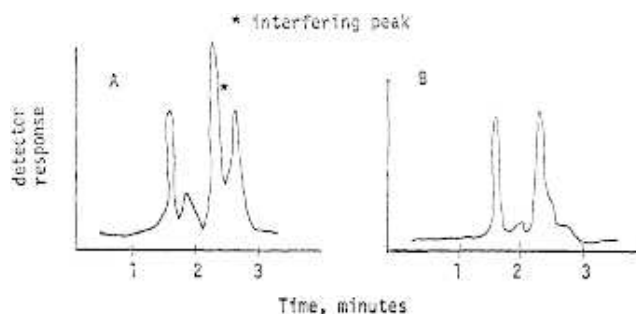

Figure 107A-1

7.1.5 N, N-Dimethylacetamide (DMAC). Spectrographic grade. For use in place of THF.

7.2 Calibration. The following item is required:

7.2.1 Vinyl Chloride 99.9 Percent. Ideal Gas Products lecture bottle, or equivalent. For preparation of standard solutions.

8. Procedure

8.1 Sampling. Allow the liquid or dried resin to flow from a tap on the tank, silo, or pipeline until the tap has been purged. Fill a wide-mouth pint bottle, and immediately tightly cap the bottle. Place an identifying label on each bottle and record the date, time, sample location, and material.

8.2 Sample Treatment. Sample must be run within 24 hours.

8.2.1 Resin Samples. Weigh 9.00 ± 0.01 g of THF or DMAC in a tared 20-ml vial. Add 1.00 ± 0.01 g of resin to the tared vial containing the THF or DMAC. Close the vial tightly with the screw cap, and shake or otherwise agitate the vial until complete solution of the resin is obtained. Shaking may require several minutes to several hours, depending on the nature of the resin.

8.2.2 Suspension Resin Slurry and Wet Resin Sample. Slurry must be filtered using a small Buchner funnel with vacuum to yield a wet resin sample. The filtering process must be continued only as long as a steady stream of water is exiting from the funnel. Excessive filtration time could result in some loss of VCM. The wet resin sample is weighed into a tared 20-ml vial with THF or DMAC as described earlier for resin samples (8.2.1) and treated the same as the resin sample. A sample of the wet resin is used to determine total solids as required for calculating the residual VCM (Section 8.3.4).

8.2.3 Latex and Resin Solvent Solutions. Samples must be thoroughly mixed. Weigh 1.00 ± 0.01 g of the latex or resin-solvent solution into a 20-ml vial containing 9.00 ± 0.01 g of THF or DMAC as for the resin samples (8.2.1). Cap and shake until complete solution is obtained. Determine the total solids of the latex or resin solution sample (Section 8.3.4).

8.2.4 Solvents and Non-viscous Liquid Samples. No preparation of these samples is required. The neat samples are injected directly into the GC.

8.3 Analysis.

8.3.1 Preparation of GC. Install the chromatographic column, and condition overnight at 70°C . Do not connect the exit end of the column to the detector while conditioning.

8.3.1.1 Flow Rate Adjustments. Adjust the flow rate as follows:

- a. Nitrogen Carrier Gas. Set regulator on cylinder to read 60 psig. Set column flow controller on the chromatograph using the soap film flowmeter to yield a flow rate of 40 cc/min.
- b. Burner Air Supply. Set regulator on the cylinder at 40 psig. Set regulator on the chromatograph to supply air to the burner to yield a flow rate of 250 to 300 cc/min using the flowmeter.
- c. Hydrogen. Set regulator on cylinder to read 60 psig. Set regulator on the chromatograph to supply 30 to 40 cc/min using the flowmeter. Optimize hydrogen flow to yield the most sensitive detector response without extinguishing the flame. Check flow with flowmeter and record this flow.
- d. Nitrogen Back Flush Gas. Set regulator on the chromatograph using the soap film flowmeter to yield a flow rate of 40 cc/min.

8.3.1.2 Temperature Adjustments. Set temperature as follows:

- a. Oven (chromatographic column) at 70 °C.
- b. Injection Port at 100 °C.
- c. Detector at 300 °C.

8.3.1.3 Ignition of Flame Ionization Detector. Ignite the detector according to the manufacturer's instructions. Allow system to stabilize approximately 1 hour.

8.3.1.4 Recorder. Set pen at zero and start chart drive.

8.3.1.5 Attenuation. Set attenuation to yield desired peak height depending on sample VCM content.

8.3.2 Chromatographic Analyses.

a. Sample Injection. Remove needle from 50-microliter syringe. Open sample vial and draw 50-microliters of THF or DMAC sample recovery solution into the syringe. Recap sample vial. Attach needle to the syringe and while holding the syringe vertically (needle uppermost), eject 40 microliters into an absorbent tissue. Wipe needle with tissue. Now inject 10 microliters into chromatograph system. Repeat the injection until two consecutive values for the height of the vinyl chloride peak do not vary more than 5 percent. Use the average value for these two peak heights to compute the sample concentration.

b. Back Flush. After 4 minutes has elapsed after sample injection, actuate the back flush valve to purge the first 4 feet of the chromatographic column of solvent and other high boilers.

c. Sample Data. Record on the chromatograph strip chart the data from the sample label.

d. Elution Time. Vinyl chloride elutes at 2.8 minutes. Acetaldehyde elutes at 3.7 minutes. Analysis is considered complete when chart pen becomes stable. After 5 minutes, reset back flush valve and inject next sample.

8.3.3 Chromatograph Servicing.

- a. Septum. Replace after five sample injections.
- b. Sample Port Liner. Replace the sample port liner with a clean spare after five sample injections.
- c. Chromatograph Shutdown. If the chromatograph has been shut down overnight, rerun one or more samples from the preceding day to test stability and precision prior to starting on the current day's work.

8.3.4 Determination of Total Solids (TS). For wet resin, resin solution, and PVC latex samples, determine the TS for each sample by accurately weighing approximately 3 to 5 grams of sample into a tared aluminum pan. The initial procedure is as follows:

a. Where water is the major volatile component: Tare the weighing dish, and add 3 to 5 grams of sample to the dish. Weigh to the nearest milligram.

b. Where volatile solvent is the major volatile component: Transfer a portion of the sample to a 20-ml screw cap vial and cap immediately. Weigh the vial to the nearest milligram. Uncap the vial and transfer a 3- to 5-gram portion of the sample to a tared aluminum weighing dish. Recap the vial and reweigh to the nearest milligram. The vial weight loss is the sample weight.

To continue, place the weighing pan in a 130 °C oven for 1 hour. Remove the dish and allow to cool to room temperature in a desiccator. Weigh the pan to the nearest 0.1 mg. Total solids is the weight of material in the aluminum pan after heating divided by the net weight of sample added to the pan originally times 100.

9. Calibration of the Chromatograph

9.1 Preparation of Standards. Prepare a 1 percent by weight (approximate) solution of vinyl chloride in THF or DMAC by bubbling vinyl chloride gas from a cylinder into a tared 125-ml glass-stoppered flask containing THF or DMAC. The weight of vinyl chloride to be added should be calculated prior to this operation, i.e., 1 percent of the weight of THF or DMAC contained in the tared flask. This must be carried out in a laboratory hood. Adjust the vinyl chloride flow from the cylinder so that the vinyl chloride dissolves essentially completely in the THF or DMAC and is not blown to the atmosphere. Take particular care not to volatilize any of the solution. Stopper the flask and swirl the solution to effect complete mixing. Weigh the stoppered flask to nearest 0.1 mg to determine the exact amount of vinyl chloride added.

Pipet 10 ml of the approximately 1 percent solution into a 100-ml glass-stoppered volumetric flask, and add THF or DMAC to fill to the mark. Cap the flask and invert 10 to 20 times. This solution contains approximately 1,000 ppm by weight of vinyl chloride (note the exact concentration).

Pipet 50-, 10-, 5-, 1-, 0.5-, and 0.1-ml aliquots of the approximately 1,000 ppm solution into 10 ml glass stoppered volumetric flasks. Dilute to the mark with THF or DMAC, cap the flasks and invert each 10 to 20 times. These solutions contain approximately 500, 100, 50, 10, 5, and 1 ppm vinyl chloride. Note the exact concentration of each one. These standards are to be kept under refrigeration in stoppered bottles, and must be renewed every 3 months.

9.2 Preparation of Chromatograph Calibration Curve.

Obtain the GC for each of the six final solutions prepared in Section 9.1 by using the procedure in Section 8.3.2. Prepare a chart plotting peak height obtained from the chromatogram of each solution versus the known concentration. Draw a straight line through the points derived by the least squares method.

10. Calculations

10.1 Response Factor. From the calibration curve described in Section 9.2, select the value of C_c that corresponds to H_c for each sample. Compute the response factor, R_f , for each sample as follows:

$$R_f = \frac{C_c}{H_c} \quad \text{Eq. 107A-1}$$

where:

R_f = Chromatograph response factor, ppm/mm.

C_c =Concentration of vinyl chloride in the standard sample, ppm.

H_c =Peak height of the standard sample, mm.

10.2 Residual vinyl chloride monomer concentration (C_{rvc}) or vinyl chloride monomer concentration in resin:

$$C_{rvc} = 10H_s R_f \quad \text{Eq. 107A-2}$$

Where:

C_{rvc} =Concentration of residual vinyl chloride monomer, ppm.

H_s =Peak height of sample, mm.

R_f =Chromatograph response factor.

10.3 Samples containing volatile material, i.e., resin solutions, wet resin, and latexes:

$$C_{rvc} = \frac{H_s R_f (1,000)}{TS} \quad \text{Eq. 107A-3}$$

where:

TS=Total solids in the sample, weight fraction.

10.4 Samples of solvents and in process wastewater:

$$C_{rvc} = \frac{H_s R_f}{0.888} \quad \text{Eq. 107A-4}$$

Where:

0.888=Specific gravity of THF.

11. Bibliography

1. Communication from R. N. Wheeler, Jr.; Union Carbide Corporation. Part 61 National Emissions Standards for Hazardous Air Pollutants appendix B, Method 107—Alternate Method, September 19, 1977.

METHOD 108—DETERMINATION OF PARTICULATE AND GASEOUS ARSENIC EMISSIONS

NOTE: This method does not include all of the specifications (e.g., equipment and supplies) and procedures (e.g., sampling and analytical) essential to its performance. Some material is incorporated by reference from other methods in appendix A to 40 CFR part 60. Therefore, to obtain reliable results, persons using this method should have a thorough knowledge of at least the following additional test methods: Method 1, Method 2, Method 3, Method 5, and Method 12.

1.0 Scope and Application.

1.1 Analytes.

Analyte	CAS No.	Sensitivity
Arsenic compounds as arsenic (As)	7440-38-2	Lower limit 10 µg/ml or less.

1.2 Applicability. This method is applicable for the determination of inorganic As emissions from stationary sources as specified in an applicable subpart of the regulations.

1.3 Data Quality Objectives. Adherence to the requirements of this method will enhance the quality of the data obtained from air pollutant sampling methods.

2.0 Summary of Method

Particulate and gaseous As emissions are withdrawn isokinetically from the source and are collected on a glass mat filter and in water. The collected arsenic is then analyzed by means of atomic absorption spectrophotometry (AAS).

3.0 Definitions. [Reserved]

4.0 Interferences

Analysis for As by flame AAS is sensitive to the chemical composition and to the physical properties (e.g., viscosity, pH) of the sample. The analytical procedure includes a check for matrix effects (Section 11.5).

5.0 Safety

5.1 This method may involve hazardous materials, operations, and equipment. This test method may not address all of the safety problems associated with its use. It is the responsibility of the user to establish appropriate safety and health practices and determine the applicability of regulatory limitations prior to performing this test method.

5.2 Corrosive reagents. The following reagents are hazardous. Personal protective equipment and safe procedures that prevent chemical splashes are recommended. If contact occurs, immediately flush with copious amounts of water for at least 15 minutes. Remove clothing under shower and decontaminate. Treat residual chemical burns as thermal burns.

5.2.1 Hydrochloric Acid (HCl). Highly corrosive liquid with toxic vapors. Vapors are highly irritating to eyes, skin, nose, and lungs, causing severe damage. May cause bronchitis, pneumonia, or edema of lungs. Exposure to concentrations of 0.13 to 0.2 percent can be lethal to humans in a few minutes. Provide ventilation to limit exposure. Reacts with metals, producing hydrogen gas.

5.2.2 Hydrogen Peroxide (H₂ O₂). Very harmful to eyes. 30% H₂ O₂ can burn skin, nose, and lungs.

5.2.3 Nitric Acid (HNO₃). Highly corrosive to eyes, skin, nose, and lungs. Vapors are highly toxic and can cause bronchitis, pneumonia, or edema of lungs. Reaction to inhalation may be delayed as long as 30 hours and still be fatal. Provide ventilation to limit exposure. Strong oxidizer. Hazardous reaction may occur with organic materials such as solvents.

5.2.4 Sodium Hydroxide (NaOH). Causes severe damage to eyes and skin. Inhalation causes irritation to nose, throat, and lungs. Reacts exothermically with small amounts of water.

6.0 Equipment and Supplies

6.1 Sample Collection. A schematic of the sampling train used in performing this method is shown in Figure 108-1; it is similar to the Method 5 sampling train of 40 CFR part 60, appendix A. The following items are required for sample collection:

6.1.1 Probe Nozzle, Probe Liner, Pitot Tube, Differential Pressure Gauge, Filter Holder, Filter Heating System, Temperature Sensor, Metering System, Barometer, and Gas Density Determination Equipment. Same as Method 5, Sections 6.1.1.1 to 6.1.1.7, 6.1.1.9, 6.1.2, and 6.1.3, respectively.

6.1.2 Impingers. Four impingers connected in series with leak-free ground-glass fittings or any similar leak-free noncontaminating fittings. For the first, third, and fourth impingers, use the Greenburg-Smith design, modified by replacing the tip with a 1.3-cm ID (0.5-in.) glass tube extending to about 1.3 cm (0.5 in.) from the bottom of the flask. For the second impinger, use the Greenburg-Smith design with the standard tip. Modifications (e.g., flexible connections between the impingers, materials other

than glass, or flexible vacuum lines to connect the filter holder to the condenser) are subject to the approval of the Administrator.

6.1.3 Temperature Sensor. Place a temperature sensor, capable of measuring temperature to within 1 °C (2 °F), at the outlet of the fourth impinger for monitoring purposes.

6.2 Sample Recovery. The following items are required for sample recovery:

6.2.1 Probe-Liner and Probe-Nozzle Brushes, Petri Dishes, Graduated Cylinder and/or Balance, Plastic Storage Containers, and Funnel and Rubber Policeman. Same as Method 5, Sections 6.2.1 and 6.2.4 to 6.2.8, respectively.

6.2.2 Wash Bottles. Polyethylene (2).

6.2.3 Sample Storage Containers. Chemically resistant, polyethylene or polypropylene for glassware washes, 500- or 1000-ml.

6.3 Analysis. The following items are required for analysis:

6.3.1 Spectrophotometer. Equipped with an electrodeless discharge lamp and a background corrector to measure absorbance at 193.7 nanometers (nm). For measuring samples having less than 10 µg As/ml, use a vapor generator accessory or a graphite furnace.

6.3.2 Recorder. To match the output of the spectrophotometer.

6.3.3 Beakers. 150 ml.

6.3.4 Volumetric Flasks. Glass 50-, 100-, 200-, 500-, and 1000-ml; and polypropylene, 50-ml.

6.3.5 Balance. To measure within 0.5 g.

6.3.6 Volumetric Pipets. 1-, 2-, 3-, 5-, 8-, and 10-ml.

6.3.7 Oven.

6.3.8 Hot Plate.

7.0 Reagents and Standards

Unless otherwise indicated, it is intended that all reagents conform to the specifications established by the Committee on Analytical Reagents of the American Chemical Society, where such specifications are available; otherwise, use the best available grade.

7.1 The following reagents are required for sample collection:

7.1.1 Filters. Same as Method 5, Section 7.1.1, except that the filters need not be unreactive to SO₂.

7.1.2 Silica Gel, Crushed Ice, and Stopcock Grease. Same as Method 5, Sections 7.1.2, 7.1.4, and 7.1.5, respectively.

7.1.3 Water. Deionized distilled to meet ASTM D 1193-77 or 91 (incorporated by reference-see § 61.18), Type 3. When high concentrations of organic matter are not expected to be present, the KMnO₄ test for oxidizable organic matter may be omitted.

7.2 Sample Recovery.

7.2.1 0.1 N NaOH. Dissolve 4.00 g of NaOH in about 500 ml of water in a 1-liter volumetric flask. Then, dilute to exactly 1.0 liter with water.

7.3 Analysis. The following reagents and standards are required for analysis:

7.3.1 Water. Same as Section 7.1.3.

7.3.2 Sodium Hydroxide, 0.1 N. Same as in Section 7.2.1.

7.3.3 Sodium Borohydride (NaBH_4), 5 Percent Weight by Volume (W/V). Dissolve 50.0 g of NaBH_4 in about 500 ml of 0.1 N NaOH in a 1-liter volumetric flask. Then, dilute to exactly 1.0 liter with 0.1 N NaOH.

7.3.4 Hydrochloric Acid, Concentrated.

7.3.5 Potassium Iodide (KI), 30 Percent (W/V). Dissolve 300 g of KI in 500 ml of water in a 1 liter volumetric flask. Then, dilute to exactly 1.0 liter with water.

7.3.6 Nitric Acid, Concentrated.

7.3.7 Nitric Acid, 0.8 N. Dilute 52 ml of concentrated HNO_3 to exactly 1.0 liter with water.

7.3.8 Nitric Acid, 50 Percent by Volume (V/V). Add 50 ml concentrated HNO_3 to 50 ml water.

7.3.9 Stock Arsenic Standard, 1 mg As/ml. Dissolve 1.3203 g of primary standard grade As_2O_3 in 20 ml of 0.1 N NaOH in a 150 ml beaker. Slowly add 30 ml of concentrated HNO_3 . Heat the resulting solution and evaporate just to dryness. Transfer the residue quantitatively to a 1-liter volumetric flask, and dilute to 1.0 liter with water.

7.3.10 Arsenic Working Solution, 1.0 μg As/ml. Pipet exactly 1.0 ml of stock arsenic standard into an acid-cleaned, appropriately labeled 1-liter volumetric flask containing about 500 ml of water and 5 ml of concentrated HNO_3 . Dilute to exactly 1.0 liter with water.

7.3.11 Air. Suitable quality for AAS analysis.

7.3.12 Acetylene. Suitable quality for AAS analysis.

7.3.13 Nickel Nitrate, 5 Percent Ni (W/V). Dissolve 24.780 g of nickel nitrate hexahydrate [$\text{Ni}(\text{NO}_3)_2 \cdot 6\text{H}_2\text{O}$] in water in a 100-ml volumetric flask, and dilute to 100 ml with water.

7.3.14 Nickel Nitrate, 1 Percent Ni (W/V). Pipet 20 ml of 5 percent nickel nitrate solution into a 100-ml volumetric flask, and dilute to exactly 100 ml with water.

7.3.15 Hydrogen Peroxide, 3 Percent by Volume. Pipet 50 ml of 30 percent H_2O_2 into a 500-ml volumetric flask, and dilute to exactly 500 ml with water.

8.0 Sample Collection, Preservation, Transport, and Storage

8.1 Pretest Preparation. Follow the general procedure given in Method 5, Section 8.1, except the filter need not be weighed, and the 200 ml of 0.1N NaOH and Container 4 should be tared to within 0.5 g.

8.2 Preliminary Determinations. Follow the general procedure given in Method 5, Section 8.2, except select the nozzle size to maintain isokinetic sampling rates below 28 liters/min (1.0 cfm).

8.3 Preparation of Sampling Train. Follow the general procedure given in Method 5, Section 8.3.

8.4 Leak-Check Procedures. Same as Method 5, Section 8.4.

8.5 Sampling Train Operation. Follow the general procedure given in Method 5, Section 8.5, except maintain isokinetic sampling flow rates below 28 liters/min (1.0 cfm). For each run, record the data required on a data sheet similar to the one shown in Figure 108-2.

8.6 Calculation of Percent Isokinetic. Same as Method 5, Section 8.6.

8.7 Sample Recovery. Same as Method 5, Section 8.7, except that 0.1 N NaOH is used as the cleanup solvent instead of acetone and that the impinger water is treated as follows:

8.7.1 Container Number 4 (Impinger Water). Clean each of the first three impingers and connecting glassware in the following manner:

8.7.1.1 Wipe the impinger ball joints free of silicone grease, and cap the joints.

8.7.1.2 Rotate and agitate each of the first two impingers, using the impinger contents as a rinse solution.

8.7.1.3 Transfer the liquid from the first three impingers to Container Number 4. Remove the outlet ball-joint cap, and drain the contents through this opening. Do not separate the impinger parts (inner and outer tubes) while transferring their contents to the container.

8.7.1.4 Weigh the contents of Container No. 4 to within 0.5 g. Record in the log the weight of liquid along with a notation of any color or film observed in the impinger catch. The weight of liquid is needed along with the silica gel data to calculate the stack gas moisture content.

NOTE: Measure and record the total amount of 0.1 N NaOH used for rinsing under Sections 8.7.1.5 and 8.7.1.6.

8.7.1.5 Pour approximately 30 ml of 0.1 NaOH into each of the first two impingers, and agitate the impingers. Drain the 0.1 N NaOH through the outlet arm of each impinger into Container Number 4. Repeat this operation a second time; inspect the impingers for any abnormal conditions.

8.7.1.6 Wipe the ball joints of the glassware connecting the impingers and the back half of the filter holder free of silicone grease, and rinse each piece of glassware twice with 0.1 N NaOH; transfer this rinse into Container Number 4. (DO NOT RINSE or brush the glass-fritted filter support.) Mark the height of the fluid level to determine whether leakage occurs during transport. Label the container to identify clearly its contents.

8.8 Blanks.

8.8.1 Sodium Hydroxide. Save a portion of the 0.1 N NaOH used for cleanup as a blank. Take 200 ml of this solution directly from the wash bottle being used and place it in a plastic sample container labeled "NaOH blank."

8.8.2 Water. Save a sample of the water, and place it in a container labeled "H₂O blank."

8.8.3 Filter. Save two filters from each lot of filters used in sampling. Place these filters in a container labeled "filter blank."

9.0 Quality Control

9.1 MISCELLANEOUS QUALITY CONTROL MEASURES.

Section	Quality control measure	Effect
8.4, 10.1	Sampling equipment leak-checks and calibration	Ensures accuracy and precision of sampling measurements.
10.4	Spectrophotometer calibration	Ensures linearity of spectrophotometer response to standards.
11.5	Check for matrix effects	Eliminates matrix effects.

9.2 Volume Metering System Checks. Same as Method 5, Section 9.2.

10.0 Calibration and Standardization

NOTE: Maintain a laboratory log of all calibrations.

10.1 Sampling Equipment. Same as Method 5, Section 10.0.

10.2 Preparation of Standard Solutions.

10.2.1 For the high level procedure, pipet 1, 3, 5, 8, and 10 ml of the 1.0 mg As/ml stock solution into separate 100 ml volumetric flasks, each containing 5 ml of concentrated HNO₃. Dilute to the mark with water.

10.2.2 For the low level vapor generator procedure, pipet 1, 2, 3, and 5 ml of 1.0 µg As/ml standard solution into separate reaction tubes. Dilute to the mark with water.

10.2.3 For the low level graphite furnace procedure, pipet 1, 5, 10 and 15 ml of 1.0 µg As/ml standard solution into separate flasks along with 2 ml of the 5 percent nickel nitrate solution and 10 ml of the 3 percent H₂O₂ solution. Dilute to the mark with water.

10.3 Calibration Curve. Analyze a 0.8 N HNO₃ blank and each standard solution according to the procedures outlined in section 11.4.1. Repeat this procedure on each standard solution until two consecutive peaks agree within 3 percent of their average value. Subtract the average peak height (or peak area) of the blank—which must be less than 2 percent of recorder full scale—from the averaged peak height of each standard solution. If the blank absorbance is greater than 2 percent of full-scale, the probable cause is As contamination of a reagent or carry-over of As from a previous sample. Prepare the calibration curve by plotting the corrected peak height of each standard solution versus the corresponding final total As weight in the solution.

10.4 Spectrophotometer Calibration Quality Control. Calculate the least squares slope of the calibration curve. The line must pass through the origin or through a point no further from the origin than ±2 percent of the recorder full scale. Multiply the corrected peak height by the reciprocal of the least squares slope to determine the distance each calibration point lies from the theoretical calibration line. The difference between the calculated concentration values and the actual concentrations (e.g., 1, 3, 5, 8, and 10 mg As for the high-level procedure) must be less than 7 percent for all standards.

NOTE: For instruments equipped with direct concentration readout devices, preparation of a standard curve will not be necessary. In all cases, follow calibration and operational procedures in the manufacturers' instruction manual.

11.0 Analytical Procedure

11.1 Sample Loss Check. Prior to analysis, check the liquid level in Containers Number 2 and Number 4. Note on the analytical data sheet whether leakage occurred during transport. If a noticeable amount of leakage occurred, either void the sample or take steps, subject to the approval of the Administrator, to adjust the final results.

11.2 Sample Preparation.

11.2.1 Container Number 1 (Filter). Place the filter and loose particulate matter in a 150 ml beaker. Also, add the filtered solid material from Container Number 2 (see Section 11.2.2). Add 50 ml of 0.1 N NaOH. Then stir and warm on a hot plate at low heat (do not boil) for about 15 minutes. Add 10 ml of concentrated HNO₃, bring to a boil, then simmer for about 15 minutes. Filter the solution through a glass fiber filter. Wash with hot water, and catch the filtrate in a clean 150 ml beaker. Boil the filtrate, and evaporate to dryness. Cool, add 5 ml of 50 percent HNO₃, and then warm and stir. Allow to cool. Transfer to a 50-ml volumetric flask, dilute to volume with water, and mix well.

11.2.2 Container Number 2 (Probe Wash).

11.2.2.1 Filter (using a glass fiber filter) the contents of Container Number 2 into a 200 ml volumetric flask. Combine the filtered (solid) material with the contents of Container Number 1 (Filter).

11.2.2.2 Dilute the filtrate to exactly 200 ml with water. Then pipet 50 ml into a 150 ml beaker. Add 10 ml of concentrated HNO₃, bring to a boil, and evaporate to dryness. Allow to cool, add 5 ml of

50 percent HNO_3 , and then warm and stir. Allow the solution to cool, transfer to a 50-ml volumetric flask, dilute to volume with water, and mix well.

11.2.3 Container Number 4 (Impinger Solution). Transfer the contents of Container Number 4 to a 500 ml volumetric flask, and dilute to exactly 500-ml with water. Pipet 50 ml of the solution into a 150-ml beaker. Add 10 ml of concentrated HNO_3 , bring to a boil, and evaporate to dryness. Allow to cool, add 5 ml of 50 percent HNO_3 , and then warm and stir. Allow the solution to cool, transfer to a 50-ml volumetric flask, dilute to volume with water, and mix well.

11.2.4 Filter Blank. Cut each filter into strips, and treat each filter individually as directed in Section 11.2.1, beginning with the sentence, "Add 50 ml of 0.1 N NaOH."

11.2.5 Sodium Hydroxide and Water Blanks. Treat separately 50 ml of 0.1 N NaOH and 50 ml water, as directed under Section 11.2.3, beginning with the sentence, "Pipet 50 ml of the solution into a 150-ml beaker."

11.3 Spectrophotometer Preparation. Turn on the power; set the wavelength, slit width, and lamp current. Adjust the background corrector as instructed by the manufacturer's manual for the particular atomic absorption spectrophotometer. Adjust the burner and flame characteristics as necessary.

11.4 Analysis. Calibrate the analytical equipment and develop a calibration curve as outlined in Sections 10.2 through 10.4.

11.4.1 Arsenic Samples. Analyze an appropriately sized aliquot of each diluted sample (from Sections 11.2.1 through 11.2.3) until two consecutive peak heights agree within 3 percent of their average value. If applicable, follow the procedures outlined in Section 11.4.1.1. If the sample concentration falls outside the range of the calibration curve, make an appropriate dilution with 0.8 N HNO_3 so that the final concentration falls within the range of the curve. Using the calibration curve, determine the arsenic concentration in each sample fraction.

NOTE: Because instruments vary between manufacturers, no detailed operating instructions will be given here. Instead, the instrument manufacturer's detailed operating instructions should be followed.

11.4.1.1 Arsenic Determination at Low Concentration. The lower limit of flame AAS is 10 μg As/ml. If the arsenic concentration of any sample is at a lower level, use the graphite furnace or vapor generator which is available as an accessory component. Flame, graphite furnace, or vapor generators may be used for samples whose concentrations are between 10 and 30 $\mu\text{g}/\text{ml}$. Follow the manufacturer's instructions in the use of such equipment.

11.4.1.1.1 Vapor Generator Procedure. Place a sample containing between 0 and 5 μg of arsenic in the reaction tube, and dilute to 15 ml with water. Since there is some trial and error involved in this procedure, it may be necessary to screen the samples by conventional atomic absorption until an approximate concentration is determined. After determining the approximate concentration, adjust the volume of the sample accordingly. Pipet 15 ml of concentrated HCl into each tube. Add 1 ml of 30 percent KI solution. Place the reaction tube into a 50 °C (120 °F) water bath for 5 minutes. Cool to room temperature. Connect the reaction tube to the vapor generator assembly. When the instrument response has returned to baseline, inject 5.0 ml of 5 percent NaBH_4 , and integrate the resulting spectrophotometer signal over a 30-second time period.

11.4.1.1.2 Graphite Furnace Procedure. Dilute the digested sample so that a 5 ml aliquot contains less than 1.5 μg of arsenic. Pipet 5 ml of this digested solution into a 10-ml volumetric flask. Add 1 ml of the 1 percent nickel nitrate solution, 0.5 ml of 50 percent HNO_3 , and 1 ml of the 3 percent hydrogen peroxide and dilute to 10 ml with water. The sample is now ready for analysis.

11.4.1.2 Run a blank (0.8 N HNO_3) and standard at least after every five samples to check the spectrophotometer calibration. The peak height of the blank must pass through a point no further from the origin than ± 2 percent of the recorder full scale. The difference between the measured concentration of the standard (the product of the corrected average peak height and the reciprocal of

the least squares slope) and the actual concentration of the standard must be less than 7 percent, or recalibration of the analyzer is required.

11.4.1.3 Determine the arsenic concentration in the filter blank (i.e., the average of the two blank values from each lot).

11.4.2 Container Number 3 (Silica Gel). This step may be conducted in the field. Weigh the spent silica gel (or silica gel plus impinger) to the nearest 0.5 g; record this weight.

11.5 Check for matrix effects on the arsenic results. Same as Method 12, Section 11.5.

12.0 Data Analysis and Calculations

12.1 NOMENCLATURE

B_{ws} = Water in the gas stream, proportion by volume.

C_a = Concentration of arsenic as read from the standard curve, $\mu\text{g/ml}$.

C_s = Arsenic concentration in stack gas, dry basis, converted to standard conditions, g/dsm^3 (gr/dscf).

E_a = Arsenic mass emission rate, g/hr (lb/hr).

F_d = Dilution factor (equals 1 if the sample has not been diluted).

I = Percent of isokinetic sampling.

m_{bi} = Total mass of all four impingers and contents before sampling, g.

m_{fi} = Total mass of all four impingers and contents after sampling, g.

m_n = Total mass of arsenic collected in a specific part of the sampling train, μg .

m_t = Total mass of arsenic collected in the sampling train, μg .

T_m = Absolute average dry gas meter temperature (see Figure 108-2), $^{\circ}\text{K}$ ($^{\circ}\text{R}$).

V_m = Volume of gas sample as measured by the dry gas meter, dry basis, m^3 (ft^3).

$V_{m(\text{std})}$ = Volume of gas sample as measured by the dry gas meter, corrected to standard conditions, m^3 (ft^3).

V_n = Volume of solution in which the arsenic is contained, ml.

$V_{w(\text{std})}$ = Volume of water vapor collected in the sampling train, corrected to standard conditions, m^3 (ft^3).

ΔH = Average pressure differential across the orifice meter (see Figure 108-2), mm H_2O (in. H_2O).

12.2 Average Dry Gas Meter Temperatures (T_m) and Average Orifice Pressure Drop (ΔH). See data sheet (Figure 108-2).

12.3 Dry Gas Volume. Using data from this test, calculate $V_{m(\text{std})}$ according to the procedures outlined in Method 5, Section 12.3.

12.4 Volume of Water Vapor.

$$V_{w(\text{std})} = K_2 (m_{fi} - m_{bi}) \quad \text{Eq. 108-1}$$

Where:

$K_2 = 0.001334 \text{ m}^3/\text{g}$ for metric units.
 $= 0.047012 \text{ ft}^3/\text{g}$ for English units.

12.5 Moisture Content.

$$B_{ws} = \frac{V_{w(std)}}{V_{m(std)} + V_{w(std)}} \quad \text{Eq. 108-2}$$

12.6 Amount of Arsenic Collected.

12.6.1 Calculate the amount of arsenic collected in each part of the sampling train, as follows:

$$m_x = C_a F_d V_x \quad \text{Eq. 108-3}$$

12.6.2 Calculate the total amount of arsenic collected in the sampling train as follows:

$$m_t = m_{\text{filters}} + m_{\text{probe}} + m_{\text{impingers}} - m_{\text{filter blank}} - m_{\text{NaOH blank}} - m_{\text{water blank}} \quad \text{Eq. 108-4}$$

12.7 Calculate the arsenic concentration in the stack gas (dry basis, adjusted to standard conditions) as follows:

$$C_s = K_3 \left(m_t / V_{m(std)} \right) \quad \text{Eq. 108-5}$$

Where:

$K_3 = 10^{-6} \text{ g}/\mu\text{g}$ for metric units

$= 1.54 \times 10^{-5} \text{ gr}/\mu\text{g}$ for English units

12.8 Stack Gas Velocity and Volumetric Flow Rate. Calculate the average stack gas velocity and volumetric flow rate using data obtained in this method and the equations in Sections 12.2 and 12.3 of Method 2.

12.9 Pollutant Mass Rate. Calculate the arsenic mass emission rate as follows:

$$E_a = C_s Q_{std} \quad \text{Eq. 108-6}$$

12.10 Isokinetic Variation. Same as Method 5, Section 12.11.

13.0 Method Performance

13.1 Sensitivity. The lower limit of flame AAS $10 \mu\text{g As/ml}$. The analytical procedure includes provisions for the use of a graphite furnace or vapor generator for samples with a lower arsenic concentration.

14.0 Pollution Prevention. [Reserved]

15.0 Waste Management. [Reserved]

16.0 References.

Same as References 1 through 9 of Method 5, Section 17.0, with the addition of the following:

1. Perkin Elmer Corporation. Analytical Methods for Atomic Absorption Spectrophotometry. 303-0152. Norwalk, Connecticut. September 1976. pp. 5-6.

2. Standard Specification for Reagent Water. In: Annual Book of American Society for Testing and Materials Standards. Part 31: Water, Atmospheric Analysis. American Society for Testing and Materials. Philadelphia, PA. 1974. pp. 40-42.

3. Stack Sampling Safety Manual (Draft). U.S. Environmental Protection Agency, Office of Air Quality Planning and Standard, Research Triangle Park, NC. September 1978.

17.0 Tables, Diagrams, Flowcharts, and Validation Data

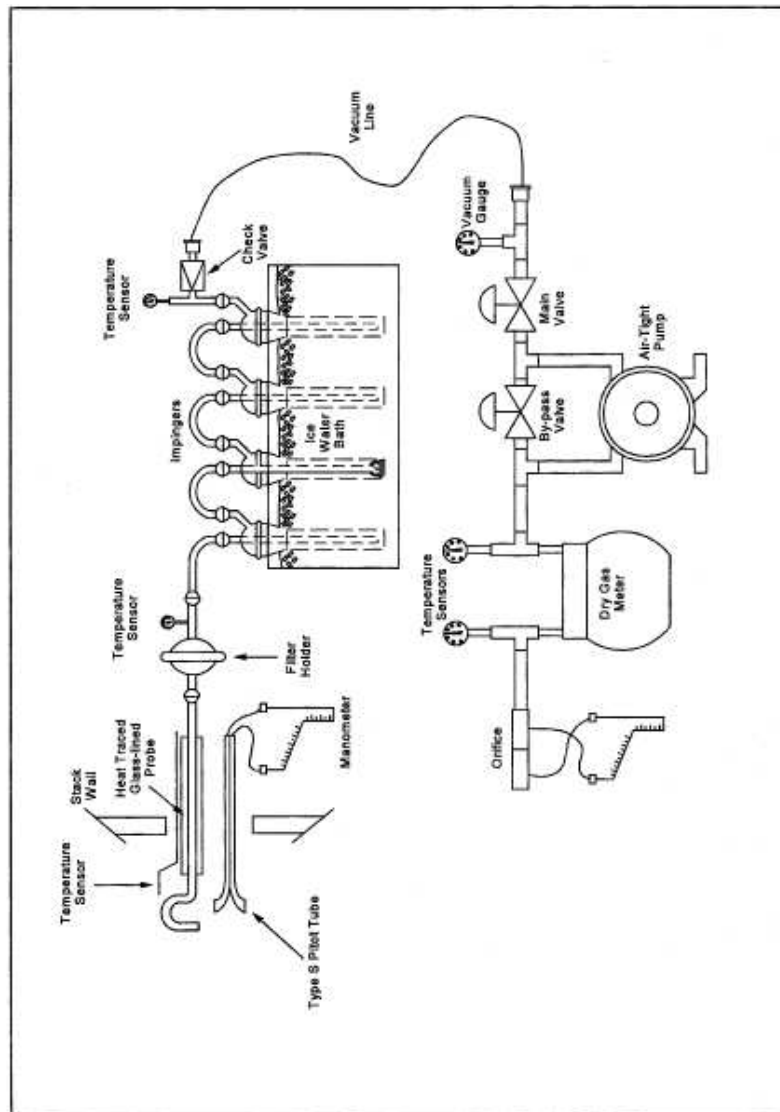

Figure 108-1. Arsenic Sampling Train

[View or download PDF](#)

1.2 **Applicability.** This method applies to the determination of inorganic As content of process ore and reverberatory matte samples from nonferrous smelters and other sources as specified in an applicable subpart of the regulations.

1.3 **Data Quality Objectives.** Adherence to the requirements of this method will enhance the quality of the data obtained from air pollutant sampling methods.

2.0 *Summary of Method*

Arsenic bound in ore samples is liberated by acid digestion and analyzed by flame atomic absorption spectrophotometry (AAS).

3.0 *Definitions [Reserved]*

4.0 *Interferences*

Analysis for As by flame AAS is sensitive to the chemical composition and to the physical properties (e.g., viscosity, pH) of the sample. The analytical procedure includes a check for matrix effects (section 11.5).

5.0 *Safety*

5.1 **Disclaimer.** This method may involve hazardous materials, operations, and equipment. This test method may not address all of the safety problems associated with its use. It is the responsibility of the user to establish appropriate safety and health practices and determine the applicability of regulatory limitations prior to performing this test method.

5.2 **Corrosive Reagents.** The following reagents are hazardous. Personal protective equipment and safe procedures that prevent chemical splashes are recommended. If contact occurs, immediately flush with copious amounts of water for at least 15 minutes. Remove clothing under shower and decontaminate. Treat residual chemical burns as thermal burns.

5.2.1 **Hydrochloric Acid (HCl).** Highly corrosive liquid with toxic vapors. Vapors are highly irritating to eyes, skin, nose, and lungs, causing severe damage. May cause bronchitis, pneumonia, or edema of lungs. Exposure to concentrations of 0.13 to 0.2 percent can be lethal to humans in a few minutes. Provide ventilation to limit exposure. Reacts with metals, producing hydrogen gas.

5.2.2 **Hydrofluoric Acid (HF).** Highly corrosive to eyes, skin, nose, throat, and lungs. Reaction to exposure may be delayed by 24 hours or more. Provide ventilation to limit exposure.

5.2.3 **Hydrogen Peroxide (H₂ O₂).** Very harmful to eyes. 30% H₂ O₂ can burn skin, nose, and lungs.

5.2.4 **Nitric Acid (HNO₃).** Highly corrosive to eyes, skin, nose, and lungs. Vapors are highly toxic and can cause bronchitis, pneumonia, or edema of lungs. Reaction to inhalation may be delayed as long as 30 hours and still be fatal. Provide ventilation to limit exposure. Strong oxidizer. Hazardous reaction may occur with organic materials such as solvents.

5.2.5 **Sodium Hydroxide (NaOH).** Causes severe damage to eyes and skin. Inhalation causes irritation to nose, throat, and lungs. Reacts exothermically with limited amounts of water.

6.0 *Equipment and Supplies*

6.1 **Sample Collection and Preparation.** The following items are required for sample collection and preparation:

6.1.1 **Parr Acid Digestion Bomb.** Stainless steel with vapor-tight Teflon cup and cover.

6.1.2 **Volumetric Pipets.** 2- and 5-ml sizes.

6.1.3 Volumetric Flask. 50-ml polypropylene with screw caps, (one needed per standard).

6.1.4 Funnel. Polyethylene or polypropylene.

6.1.5 Oven. Capable of maintaining a temperature of approximately 105 °C (221 °F).

6.1.6 Analytical Balance. To measure to within 0.1 mg.

6.2 Analysis. The following items are required for analysis:

6.2.1 Spectrophotometer and Recorder. Equipped with an electrodeless discharge lamp and a background corrector to measure absorbance at 193.7 nm. For measuring samples having less than 10 µg As/ml, use a graphite furnace or vapor generator accessory. The recorder shall match the output of the spectrophotometer.

6.2.2 Volumetric Flasks. Class A, 50-ml (one needed per sample and blank), 500-ml, and 1-liter.

6.2.3 Volumetric Pipets. Class A, 1-, 5-, 10-, and 25-ml sizes.

7.0 Reagents and Standards.

Unless otherwise indicated, it is intended that all reagents conform to the specifications established by the Committee on Analytical Reagents of the American Chemical Society, where such specifications are available; otherwise, use the best available grade.

7.1 Sample Collection and Preparation. The following reagents are required for sample collection and preparation:

7.1.1 Water. Deionized distilled to meet ASTM D 1193-77 or 91 Type 3 (incorporated by reference—See § 61.18). When high concentrations of organic matter are not expected to be present, the KMnO_4 test for oxidizable organic matter may be omitted. Use in all dilutions requiring water.

7.1.2 Nitric Acid Concentrated.

7.1.3 Nitric Acid, 0.5 N. In a 1-liter volumetric flask containing water, add 32 ml of concentrated HNO_3 and dilute to volume with water.

7.1.4 Hydrofluoric Acid, Concentrated.

7.1.5 Potassium Chloride (KCl) Solution, 10 percent weight by volume (W/V). Dissolve 10 g KCl in water, add 3 ml concentrated HNO_3 , and dilute to 100 ml.

7.1.6 Filter. Teflon filters, 3-micron porosity, 47-mm size. (Available from Millipore Co., type FS, Catalog Number FSLW04700.)

7.1.7 Sodium Borohydride (NaBH_4), 5 Percent (W/V). Dissolve 50.0 g of NaBH_4 in about 500 ml of 0.1 N NaOH in a 1-liter volumetric flask. Then, dilute to exactly 1.0 liter with 0.1 N NaOH.

7.1.8 Nickel Nitrate, 5 Percent Ni (W/V). Dissolve 24.780 g of nickel nitrate hexahydrate [$\text{Ni}(\text{NO}_3)_2 \cdot 6\text{H}_2\text{O}$] in water in a 100-ml volumetric flask, and dilute to 100 ml with water.

7.1.9 Nickel Nitrate, 1 Percent Ni (W/V). Pipet 20 ml of 5 percent nickel nitrate solution into a 100-ml volumetric flask, and dilute to 100 ml with water.

7.2 Analysis. The following reagents and standards are required for analysis:

7.2.2 Sodium Hydroxide, 0.1 N. Dissolve 2.00 g of NaOH in water in a 500-ml volumetric flask. Dilute to volume with water.

7.2.3 Nitric Acid, 0.5 N. Same as in Section 7.1.3.

7.2.4 Potassium Chloride Solution, 10 percent. Same as in Section 7.1.5.

7.2.5 Hydrochloric Acid, Concentrated.

7.2.6 Potassium Iodide (KI), 30 Percent (W/V). Dissolve 300 g of KI in about 500 ml of water in a 1-liter volumetric flask. Then, dilute to exactly 1.0 liter with water.

7.2.7 Hydrogen Peroxide, 3 Percent by Volume. Pipet 50 ml of 30 percent H₂O₂ into a 500-ml volumetric flask, and dilute to exactly 500 ml with water.

7.2.8 Stock Arsenic Standard, 1 mg As/ml. Dissolve 1.3203 g of primary grade As₂O₃ in 20 ml of 0.1 N NaOH. Slowly add 30 ml of concentrated HNO₃, and heat in an oven at 105 °C (221 °F) for 2 hours. Allow to cool, and dilute to 1 liter with deionized distilled water.

7.2.9 Nitrous Oxide. Suitable quality for AAS analysis.

7.2.10 Acetylene. Suitable quality for AAS analysis.

7.2.11 Quality Assurance Audit Samples. When making compliance determinations, and upon availability, audit samples may be obtained from the appropriate EPA regional Office or from the responsible enforcement authority.

NOTE: The responsible enforcement authority should be notified at least 30 days prior to the test date to allow sufficient time for sample delivery.

8.0 Sample Collection, Preservation, Transport, and Storage

8.1 Sample Collection. A sample that is representative of the ore lot to be tested must be taken prior to analysis. (A portion of the samples routinely collected for metals analysis may be used provided the sample is representative of the ore being tested.)

8.2 Sample Preparation. The sample must be ground into a finely pulverized state.

9.0 QUALITY CONTROL

Section	Quality control measure	Effect
10.2	Spectrophotometer calibration	Ensure linearity of spectrophotometer response to standards.
11.5	Check for matrix effects	Eliminate matrix effects.

10.0 Calibration and Standardizations

NOTE: Maintain a laboratory log of all calibrations.

10.1 Preparation of Standard Solutions. Pipet 1, 5, 10, and 25 ml of the stock As solution into separate 100-ml volumetric flasks. Add 10 ml KCl solution and dilute to the mark with 0.5 N HNO₃. This will give standard concentrations of 10, 50, 100, and 250 µg As/ml. For low-level arsenic samples that require the use of a graphite furnace or vapor generator, follow the procedures in Section 11.3:1. Dilute 10 ml of KCl solution to 100 ml with 0.5 N HNO₃ and use as a reagent blank.

10.2 Calibration Curve. Analyze the reagent blank and each standard solution according to the procedures outlined in Section 11.3. Repeat this procedure on each standard solution until two consecutive peaks agree within 3 percent of their average value. Subtract the average peak height (or peak area) of the blank—which must be less than 2 percent of recorder full scale—from the averaged peak heights of each standard solution. If the blank absorbance is greater than 2 percent of full-scale, the probable cause is Hg contamination of a reagent or carry-over of As from a previous sample. Prepare the calibration curve by plotting the corrected peak height of each standard solution versus the corresponding final total As weight in the solution.

10.3 Spectrophotometer Calibration Quality Control. Calculate the least squares slope of the calibration curve. The line must pass through the origin or through a point no further from the origin

than ± 2 percent of the recorder full scale. Multiply the corrected peak height by the reciprocal of the least squares slope to determine the distance each calibration point lies from the theoretical calibration line. The difference between the calculated concentration values and the actual concentrations must be less than 7 percent for all standards.

NOTE: For instruments equipped with direct concentration readout devices, preparation of a standard curve will not be necessary. In all cases, follow calibration and operational procedures in the manufacturer's instruction manual.

11.0 Analytical Procedure

11.1 Sample Preparation. Weigh 50 to 500 mg of finely pulverized sample to the nearest 0.1 mg. Transfer the sample into the Teflon cup of the digestion bomb, and add 2 ml each of concentrated HNO_3 and HF. Seal the bomb immediately to prevent the loss of any volatile arsenic compounds that may form. Heat in an oven at $105\text{ }^\circ\text{C}$ ($221\text{ }^\circ\text{F}$) for 2 hours. Remove the bomb from the oven and allow to cool. Using a Teflon filter, quantitatively filter the digested sample into a 50-ml polypropylene volumetric flask. Rinse the bomb three times with small portions of 0.5 N HNO_3 , and filter the rinses into the flask. Add 5 ml of KCl solution to the flask, and dilute to 50 ml with 0.5 N HNO_3 .

11.2 Spectrophotometer Preparation.

11.2.1 Turn on the power; set the wavelength, slit width, and lamp current. Adjust the background corrector as instructed by the manufacturer's manual for the particular atomic absorption spectrophotometer. Adjust the burner and flame characteristics as necessary.

11.2.2 Develop a spectrophotometer calibration curve as outlined in Sections 10.2 and 10.3.

11.3 Arsenic Determination. Analyze an appropriately sized aliquot of each diluted sample (from Section 11.1) until two consecutive peak heights agree within 3 percent of their average value. If applicable, follow the procedures outlined in Section 11.3.1. If the sample concentration falls outside the range of the calibration curve, make an appropriate dilution with 0.5 N HNO_3 so that the final concentration falls within the range of the curve. Using the calibration curve, determine the As concentration in each sample.

NOTE: Because instruments vary between manufacturers, no detailed operating instructions will be given here. Instead, the instrument manufacturer's detailed operating instructions should be followed.

11.3.1 Arsenic Determination at Low Concentration. The lower limit of flame AAS is $10\text{ }\mu\text{g As/ml}$. If the arsenic concentration of any sample is at a lower level, use the vapor generator or graphite furnace which is available as an accessory component. Flame, graphite furnace, or vapor generators may be used for samples whose concentrations are between 10 and $30\text{ }\mu\text{g/ml}$. Follow the manufacturer's instructions in the use of such equipment.

11.3.1.1 Vapor Generator Procedure. Place a sample containing between 0 and $5\text{ }\mu\text{g}$ of arsenic in the reaction tube, and dilute to 15 ml with water. Since there is some trial and error involved in this procedure, it may be necessary to screen the samples by conventional AAS until an approximate concentration is determined. After determining the approximate concentration, adjust the volume of the sample accordingly. Pipet 15 ml of concentrated HCl into each tube. Add 1 ml of 30 percent KI solution. Place the reaction tube into a $50\text{ }^\circ\text{C}$ ($120\text{ }^\circ\text{F}$) water bath for 5 minutes. Cool to room temperature. Connect the reaction tube to the vapor generator assembly. When the instrument response has returned to baseline, inject 5.0 ml of 5 percent NaBH_4 and integrate the resulting spectrophotometer signal over a 30-second time period.

11.3.1.2 Graphite Furnace Procedure. Pipet 5 ml of the digested solution into a 10-ml volumetric flask. Add 1 ml of the 1 percent nickel nitrate solution, 0.5 ml of 50 percent HNO_3 , and 1 ml of the 3 percent H_2O_2 , and dilute to 10 ml with water. The sample is now ready to inject in the furnace for analysis.

11.4 Run a blank and standard at least after every five samples to check the spectrophotometer calibration. The peak height of the blank must pass through a point no further from the origin than ± 2 percent of the recorder full scale. The difference between the measured concentration of the standard (the product of the corrected average peak height and the reciprocal of the least squares slope) and the actual concentration of the standard must be less than 7 percent, or recalibration of the analyzer is required.

11.5 Mandatory Check for Matrix Effects on the Arsenic Results. Same as Method 12, Section 11.5.

12.0 Data Analysis and Calculations

12.1 Calculate the percent arsenic in the ore sample as follows:

$$\% \text{ As} = \frac{5C_a F_d}{W} \quad \text{Eq. 108A-1}$$

Where:

C_a = Concentration of As as read from the standard curve, $\mu\text{g/ml}$.

F_d = Dilution factor (equals to 1 if the sample has not been diluted).

W = Weight of ore sample analyzed, mg.

5 = (50 ml sample " 100)/(10³ $\mu\text{g/mg}$).

13.0 Method Performance

13.1 Sensitivity. The lower limit of flame AAS is 10 $\mu\text{g As/ml}$. The analytical procedure includes provisions for the use of a graphite furnace or vapor generator for samples with a lower arsenic concentration.

14.0 Pollution Prevention. [Reserved]

15.0 Waste Management. [Reserved]

16.0 References

Same as References 1 through 9 of Section 17.0 of Method 5, with the addition of the following:

1. Perkin Elmer Corporation. Analytical Methods of Atomic Absorption Spectrophotometry. 303-0152. Norwalk, Connecticut. September 1976. pp 5-6.

2. Ringwald, D. Arsenic Determination on Process Materials from ASARCO's Copper Smelter in Tacoma, Washington. Unpublished Report. Prepared for Emission Measurement Branch, Emission Standards and Engineering Division, U.S. Environmental Protection Agency, Research Triangle Park, North Carolina. August 1980. 35 pp.

3. Stack Sampling Safety Manual (Draft). U.S. Environmental Protection Agency, Office of Air Quality Planning and Standard, Research Triangle Park, NC. September 1978.

17.0 Tables, Diagrams, Flowcharts, and Validation Data. [Reserved]

METHOD 108B—DETERMINATION OF ARSENIC CONTENT IN ORE SAMPLES FROM NONFERROUS SMELTERS

NOTE: This method does not include all of the specifications (e.g., equipment and supplies) and procedures (e.g., sampling and analytical) essential to its performance. Some material is incorporated by reference from other methods in this appendix and in appendix A to 40 CFR part 60. Therefore, to obtain reliable results,

persons using this method should have a thorough knowledge of at least the following additional test methods: Method 12 and Method 108A.

1.0 Scope and Application

1.1 Analytes.

Analyte	CAS No.	Sensitivity
Arsenic compounds as arsenic (As)	7440-38-2	Lower limit 10 µg/ml.

1.2 Applicability. This method applies to the determination of inorganic As content of process ore and reverberatory matte samples from nonferrous smelters and other sources as specified in an applicable subpart of the regulations. Samples resulting in an analytical concentration greater than 10 µg As/ml may be analyzed by this method. For lower level arsenic samples, Method 108C should be used.

1.3 Data Quality Objectives. Adherence to the requirements of this method will enhance the quality of the data obtained from air pollutant sampling methods.

2.0 Summary of Method

Arsenic bound in ore samples is liberated by acid digestion and analyzed by flame atomic absorption spectrophotometry (AAS).

3.0 Definitions [Reserved]

4.0 Interferences

Analysis for As by flame AAS is sensitive to the chemical composition and to the physical properties (e.g., viscosity, pH) of the sample. The analytical procedure includes a check for matrix effects (Section 11.4).

5.0 Safety

5.1 Disclaimer. This method may involve hazardous materials, operations, and equipment. This test method may not address all of the safety problems associated with its use. It is the responsibility of the user to establish appropriate safety and health practices and determine the applicability of regulatory limitations prior to performing this test method.

5.2 Corrosive Reagents. The following reagents are hazardous. Personal protective equipment and safe procedures that prevent chemical splashes are recommended. If contact occurs, immediately flush with copious amounts of water for at least 15 minutes. Remove clothing under shower and decontaminate. Treat residual chemical burns as thermal burns.

5.2.1 Hydrochloric acid (HCl). Highly corrosive liquid with toxic vapors. Vapors are highly irritating to eyes, skin, nose, and lungs, causing severe damage. May cause bronchitis, pneumonia, or edema of lungs. Exposure to concentrations of 0.13 to 0.2 percent can be lethal to humans in a few minutes. Provide ventilation to limit exposure. Reacts with metals, producing hydrogen gas.

5.2.2 Hydrofluoric Acid (HF). Highly corrosive to eyes, skin, nose, throat, and lungs. Reaction to exposure may be delayed by 24 hours or more. Provide ventilation to limit exposure.

5.2.3 Nitric Acid (HNO₃). Highly corrosive to eyes, skin, nose, and lungs. Vapors are highly toxic and can cause bronchitis, pneumonia, or edema of lungs. Reaction to inhalation may be delayed as long as 30 hours and still be fatal. Provide ventilation to limit exposure. Strong oxidizer. Hazardous reaction may occur with organic materials such as solvents.

5.2.4 Perchloric Acid (HClO₄). Corrosive to eyes, skin, nose, and throat. Provide ventilation to limit exposure. Very strong oxidizer. Keep separate from water and oxidizable materials to prevent

vigorous evolution of heat, spontaneous combustion, or explosion. Heat solutions containing HClO_4 only in hoods specifically designed for HClO_4 .

6.0 *Equipment and Supplies*

6.1 Sample Preparation. The following items are required for sample preparation:

- 6.1.1 Teflon Beakers. 150-ml.
- 6.1.2 Graduated Pipets. 5-ml disposable.
- 6.1.3 Graduated Cylinder. 50-ml.
- 6.1.4 Volumetric Flask. 100-ml.
- 6.1.5 Analytical Balance. To measure within 0.1 mg.
- 6.1.6 Hot Plate.
- 6.1.7 Perchloric Acid Fume Hood.

6.2 Analysis. The following items are required for analysis:

- 6.2.1 Spectrophotometer. Equipped with an electrodeless discharge lamp and a background corrector to measure absorbance at 193.7 nm.
- 6.2.2 Beaker and Watch Glass. 400-ml.
- 6.2.3 Volumetric Flask. 1-liter.
- 6.2.4 Volumetric Pipets. 1-, 5-, 10-, and 25-ml.

7.0 *Reagents and Standards*

Unless otherwise indicated, it is intended that all reagents conform to the specifications established by the Committee on Analytical Reagents of the American Chemical Society, where such specifications are available; otherwise, use the best available grade.

7.1 Sample Preparation. The following reagents are required for sample preparation:

- 7.1.1 Water. Deionized distilled to meet ASTM D 1193-77 or 91 Type 3 (incorporated by reference—see § 61.18).
- 7.1.2 Nitric Acid, Concentrated.
- 7.1.3 Hydrofluoric Acid, Concentrated.
- 7.1.4 Perchloric Acid, 70 Percent.
- 7.1.5 Hydrochloric Acid, Concentrated.

7.2 Analysis. The following reagents and standards are required for analysis:

- 7.2.1 Water. Same as in Section 7.1.1.
- 7.2.2 Stock Arsenic Standard, 1.0 mg As/ml. Dissolve 1.3203 g of primary grade As_2O_3 [dried at 105°C (221°F)] in a 400-ml beaker with 10 ml of HNO_3 and 5 ml of HCl . Cover with a watch glass, and heat gently until dissolution is complete. Add 10 ml of HNO_3 and 25 ml of HClO_4 , evaporate to strong fumes of HClO_4 , and reduce to about 20 ml volume. Cool, add 100 ml of water and 100 ml of HCl , and transfer quantitatively to a 1-liter volumetric flask. Dilute to volume with water and mix.

7.2.3 Acetylene. Suitable quality for AAS analysis.

7.2.4 Air. Suitable quality for AAS analysis.

8.0 Sample Collection, Preservation, Transport, and Storage

Same as in Method 108A, Sections 8.1 and 8.2.

9.0 QUALITY CONTROL

Section	Quality control measure	Effect
10.2	Spectrophotometer calibration	Ensure linearity of spectrophotometer response to standards.
11.4	Check for matrix effects	Eliminate matrix effects.

10.0 Calibration and Standardization

NOTE: Maintain a laboratory log of all calibrations.

10.1 Preparation of Standard Solutions. Pipet 1, 5, 10, and 25 ml of the stock As solution into separate 100-ml volumetric flasks. Add 2 ml of HClO₄, 10 ml of HCl, and dilute to the mark with water. This will provide standard concentrations of 10, 50, 100, and 250 µg As/ml.

10.2 Calibration Curve and Spectrophotometer Calibration Quality Control. Same as Method 108A, Sections 10.2 and 10.3

11.0 Analytical Procedure

11.1 Sample Preparation. Weigh 100 to 1000 mg of finely pulverized sample to the nearest 0.1 mg. Transfer the sample to a 150-ml Teflon beaker. Dissolve the sample by adding 15 ml of HNO₃, 10 ml of HCl, 10 ml of HF, and 10 ml of HClO₄ in the exact order as described, and let stand for 10 minutes. In a HClO₄ fume hood, heat on a hot plate until 2-3 ml of HClO₄ remain, then cool. Add 20 ml of water and 10 ml of HCl. Cover and warm until the soluble salts are in solution. Cool, and transfer quantitatively to a 100-ml volumetric flask. Dilute to the mark with water.

11.2 Spectrophotometer Preparation. Same as in Method 108A, Section 11.2.

11.3 Arsenic Determination. If the sample concentration falls outside the range of the calibration curve, make an appropriate dilution with 2 percent HClO₄ /10 percent HCl (prepared by diluting 2 ml concentrated HClO₄ and 10 ml concentrated HCl to 100 ml with water) so that the final concentration falls within the range of the curve. Using the calibration curve, determine the As concentration in each sample.

NOTE: Because instruments vary between manufacturers, no detailed operating instructions will be given here. Instead, the instrument manufacturer's detailed operating instructions should be followed.

Run a blank and standard at least after every five samples to check the spectrophotometer calibration. The peak height of the blank must pass through a point no further from the origin than ±2 percent of the recorder full scale. The difference between the measured concentration of the standard (the product of the corrected average peak height and the reciprocal of the least squares slope) and the actual concentration of the standard must be less than 7 percent, or recalibration of the analyzer is required.

11.4 Mandatory Check for Matrix Effects on the Arsenic Results. Same as Method 12, Section 11.5.

12.0 Data Analysis and Calculations

Same as in Method 108A, Section 12.0.

13.0 Method Performance

13.1 Sensitivity. The lower limit of flame AAS is 10 µg As/ml.

14.0 Pollution Prevention [Reserved]

15.0 Waste Management [Reserved]

16.0 References

Same as in Method 108A, Section 16.0.

17.0 Tables, Diagrams, Flowcharts, and Validation Data [Reserved]

METHOD 108C—DETERMINATION OF ARSENIC CONTENT IN ORE SAMPLES FROM NONFERROUS SMELTERS (MOLYBDENUM BLUE PHOTOMETRIC PROCEDURE)

NOTE: This method does not include all of the specifications (e.g., equipment and supplies) and procedures (e.g., sampling and analytical) essential to its performance. Some material is incorporated by reference from other methods in this part. Therefore, to obtain reliable results, persons using this method should have a thorough knowledge of at least Method 108A.

1.0 Scope and Application

1.1 Analytes.

Analyte	CAS No.	Sensitivity
Arsenic compounds as arsenic (As)	7440-38-2	Lower limit 0.0002 percent As by weight.

1.2 Applicability. This method applies to the determination of inorganic As content of process ore and reverberatory matte samples from nonferrous smelters and other sources as specified in an applicable subpart of the regulations.

1.3 Data Quality Objectives. Adherence to the requirements of this method will enhance the quality of the data obtained from air pollutant sampling methods.

2.0 Summary of Method

Arsenic bound in ore samples is liberated by acid digestion and analyzed by the molybdenum blue photometric procedure.

3.0 Definitions. [Reserved]

4.0 Interferences. [Reserved]

5.0 Safety

5.1 Disclaimer. This method may involve hazardous materials, operations, and equipment. This test method may not address all of the safety problems associated with its use. It is the responsibility of the user to establish appropriate safety and health practices and determine the applicability of regulatory limitations prior to performing this test method.

5.2 Corrosive Reagents. The following reagents are hazardous. Personal protective equipment and safe procedures that prevent chemical splashes are recommended. If contact occurs, immediately flush with copious amounts of water for at least 15 minutes. Remove clothing under shower and decontaminate. Treat residual chemical burns as thermal burns.

5.2.1 Hydrochloric Acid (HCl). Highly corrosive liquid with toxic vapors. Vapors are highly irritating to eyes, skin, nose, and lungs, causing severe damage. May cause bronchitis, pneumonia, or edema of lungs. Exposure to concentrations of 0.13 to 0.2 percent can be lethal to humans in a few minutes. Provide ventilation to limit exposure. Reacts with metals, producing hydrogen gas.

5.2.2 Hydrofluoric Acid (HF). Highly corrosive to eyes, skin, nose, throat, and lungs. Reaction to exposure may be delayed by 24 hours or more. Provide ventilation to limit exposure.

5.2.3 Nitric Acid (HNO₃). Highly corrosive to eyes, skin, nose, and lungs. Vapors are highly toxic and can cause bronchitis, pneumonia, or edema of lungs. Reaction to inhalation may be delayed as long as 30 hours and still be fatal. Provide ventilation to limit exposure. Strong oxidizer. Hazardous reaction may occur with organic materials such as solvents.

5.2.4 Perchloric Acid (HClO₄). Corrosive to eyes, skin, nose, and throat. Provide ventilation to limit exposure. Very strong oxidizer. Keep separate from water and oxidizable materials to prevent vigorous evolution of heat, spontaneous combustion, or explosion. Heat solutions containing HClO₄ only in hoods specifically designed for HClO₄.

5.2.5 Sulfuric acid (H₂SO₄). Rapidly destructive to body tissue. Will cause third degree burns. Eye damage may result in blindness. Inhalation may be fatal from spasm of the larynx, usually within 30 minutes. May cause lung tissue damage with edema. 3 mg/m³ will cause lung damage in uninitiated. 1 mg/m³ for 8 hours will cause lung damage or, in higher concentrations, death. Provide ventilation to limit inhalation. Reacts violently with metals and organics.

6.0 Equipment and Supplies

6.1 Sample Preparation. The following items are required for sample preparation:

6.1.1 Analytical Balance. To measure to within 0.1 mg.

6.1.2 Erlenmeyer Flask. 300-ml.

6.1.3 Hot Plate.

6.1.4 Distillation Apparatus. No. 6, in ASTM E 50-82, 86, or 90 (Reapproved 1995)(incorporated by reference—see § 61.18); detailed in Figure 108C-1.

6.1.5 Graduated Cylinder. 50-ml.

6.1.6 Perchloric Acid Fume Hood.

6.2 Analysis. The following items are required for analysis:

6.2.1 Spectrophotometer. Capable of measuring at 660 nm.

6.2.2 Volumetric Flasks. 50- and 100-ml.

7.0 Reagents and Standards

Unless otherwise indicated, it is intended that all reagents conform to the specifications established by the Committee on Analytical Reagents of the American Chemical Society, where such specifications are available; otherwise, use the best available grade.

7.1 Sample Preparation. The following reagents are required for sample preparation:

7.1.1 Water. Deionized distilled to meet ASTM D 1193-77 or 91 Type 3 (incorporated by reference—see § 61.18). When high concentrations of organic matter are not expected to be present, the KMnO₄ test for oxidizable organic matter may be omitted. Use in all dilutions requiring water.

7.1.2 Nitric Acid, Concentrated.

7.1.3 Hydrofluoric Acid, Concentrated.

7.1.4 Sulfuric Acid, Concentrated.

7.1.5 Perchloric Acid, 70 Percent.

7.1.6 Hydrochloric Acid, Concentrated.

7.1.7 Dilute Hydrochloric Acid. Add one part concentrated HCl to nine parts water.

7.1.8 Hydrazine Sulfate $((\text{NH}_2)_2 \cdot \text{H}_2 \text{SO}_4)$.

7.1.9 Potassium Bromide (KBr).

7.1.10 Bromine Water, Saturated.

7.2 Analysis. The following reagents and standards are required for analysis:

7.2.1 Water. Same as in Section 7.1.1.

7.2.2 Methyl Orange Solution, 1 g/liter.

7.2.3 Ammonium Molybdate Solution, 5 g/liter. Dissolve 0.5 g $(\text{NH}_4)_2 \text{Mo}_7 \text{O}_{24} \cdot 4\text{H}_2 \text{O}$ in water in a 100-ml volumetric flask, and dilute to the mark. This solution must be freshly prepared.

7.2.4 Standard Arsenic Solution, 10 μg As/ml. Dissolve 0.13203 g of $\text{As}_2 \text{O}_3$ in 100 ml HCl in a 1-liter volumetric flask. Add 200 ml of water, cool, dilute to the mark with water, and mix. Transfer 100 ml of this solution to a 1-liter volumetric flask, add 40 ml HCl, cool, dilute to the mark, and mix.

7.2.5 Hydrazine Sulfate Solution, 1 g/liter. Dissolve 0.1 g of $[(\text{NH}_2)_2 \cdot \text{H}_2 \text{SO}_4]$ in water, and dilute to 100 ml in a volumetric flask. This solution must be freshly prepared.

7.2.6 Potassium Bromate (KBrO_3) Solution, 0.03 Percent Weight by Volume (W/V). Dissolve 0.3 g KBrO_3 in water, and dilute to 1 liter with water.

7.2.7 Ammonium Hydroxide ($\text{NH}_4 \text{OH}$), Concentrated.

7.2.8 Boiling Granules.

7.2.9 Hydrochloric Acid, 50 percent by volume. Dilute equal parts concentrated HCl with water.

8.0 Sample Collection, Preservation, Transport, and Storage

Same as in Method 108A, Sections 8.1 and 8.2.

9.0 QUALITY CONTROL

Section	Quality control measure	Effect
10.2	Calibration curve preparation	Ensure linearity of spectrophotometric response to standards.

10.0 Calibration and Standardizations

NOTE: Maintain a laboratory log of all calibrations.

10.1 Preparation of Standard Solutions. Transfer 1.0, 2.0, 4.0, 8.0, 12.0, 16.0, and 20.0 ml of standard arsenic solution (10 $\mu\text{g}/\text{ml}$) to each of seven 50-ml volumetric flasks. Dilute to 20 ml with dilute HCl. Add one drop of methyl orange solution and neutralize to the yellow color with dropwise addition of $\text{NH}_4 \text{OH}$. Just bring back to the red color by dropwise addition of dilute HCl, and add 10 ml in excess. Proceed with the color development as described in Section 11.2.

10.2 Calibration Curve. Plot the spectrophotometric readings of the calibration solutions against μg As per 50 ml of solution. Use this curve to determine the As concentration of each sample.

10.3 Spectrophotometer Calibration Quality Control. Calculate the least squares slope of the calibration curve. The line must pass through the origin or through a point no further from the origin than ± 2 percent of the recorder full scale. Multiply the corrected peak height by the reciprocal of the least squares slope to determine the distance each calibration point lies from the theoretical calibration line. The difference between the calculated concentration values and the actual concentrations must be less than 7 percent for all standards.

11.0 Analytical Procedure

11.1 Sample Preparation.

11.1.1 Weigh 1.0 g of finely pulverized sample to the nearest 0.1 mg. Transfer the sample to a 300 ml Erlenmeyer flask and add 15 ml of HNO_3 , 4 ml HCl , 2 ml HF , 3 ml HClO_4 , and 15 ml H_2SO_4 , in the order listed. In a HClO_4 fume hood, heat on a hot plate to decompose the sample. Then heat while swirling over an open flame until dense white fumes evolve. Cool, add 15 ml of water, swirl to hydrate the H_2SO_4 completely, and add several boiling granules. Cool to room temperature.

11.1.2 Add 1 g of KBr , 1 g hydrazine sulfate, and 50 ml HCl . Immediately attach the distillation head with thermometer and dip the side arm into a 50-ml graduated cylinder containing 25 ml of water and 2 ml of bromine water. Keep the graduated cylinder immersed in a beaker of cold water during distillation. Distill until the temperature of the vapor in the flask reaches 107°C (225°F). When distillation is complete, remove the flask from the hot plate, and simultaneously wash down the side arm with water as it is removed from the cylinder.

11.1.3 If the expected arsenic content is in the range of 0.0020 to 0.10 percent, dilute the distillate to the 50-ml mark of the cylinder with water, stopper, and mix. Transfer a 5.0-ml aliquot to a 50-ml volumetric flask. Add 10 ml of water and a boiling granule. Place the flask on a hot plate, and heat gently until the bromine is expelled and the color of methyl orange indicator persists upon the addition of 1 to 2 drops. Cool the flask to room temperature. Neutralize just to the yellow color of the indicator with dropwise additions of NH_4OH . Bring back to the red color by dropwise addition of dilute HCl , and add 10 ml excess. Proceed with the molybdenum blue color development as described in Section 11.2.

11.1.4 If the expected arsenic content is in the range of 0.0002 to 0.0010 percent As, transfer either the entire initial distillate or the measured remaining distillate from Section 11.1.2 to a 250-ml beaker. Wash the cylinder with two successive portions of concentrated HNO_3 , adding each portion to the distillate in the beaker. Add 4 ml of concentrated HClO_4 , a boiling granule, and cover with a flat watch glass placed slightly to one side. Boil gently on a hot plate until the volume is reduced to approximately 10 ml. Add 3 ml of HNO_3 , and continue the evaporation until HClO_4 is refluxing on the beaker cover. Cool briefly, rinse the underside of the watch glass and the inside of the beaker with about 3-5 ml of water, cover, and continue the evaporation to expel all but 2 ml of the HClO_4 .

NOTE: If the solution appears cloudy due to a small amount of antimony distilling over, add 4 ml of 50 percent HCl and 5 ml of water, cover, and warm gently until clear. If cloudiness persists, add 5 ml of HNO_3 and 2 ml H_2SO_4 . Continue the evaporation of volatile acids to solubilize the antimony until dense white fumes of H_2SO_4 appear. Retain at least 1 ml of the H_2SO_4 .

11.1.5 To the 2 ml of HClO_4 solution or 1 ml of H_2SO_4 solution, add 15 ml of water, boil gently for 2 minutes, and then cool. Proceed with the molybdenum blue color development by neutralizing the solution directly in the beaker just to the yellow indicator color by dropwise addition of NH_4OH . Obtain the red color by dropwise addition of dilute HCl . Transfer the solution to a 50-ml volumetric flask. Rinse the beaker successively with 10 ml of dilute HCl , followed by several small portions of water. At this point the volume of solution in the flask should be no more than 40 ml. Continue with the color development as described in Section 11.2.

11.2 Analysis.

11.2.1 Add 1 ml of KBrO_3 solution to the flask and heat on a low-temperature hot plate to about 50°C (122°F) to oxidize the arsenic and methyl orange. Add 5.0 ml of ammonium molybdate solution

to the warm solution and mix. Add 2.0 ml of hydrazine sulfate solution, dilute until the solution comes within the neck of the flask, and mix. Place the flask in a 400 ml beaker, 80 percent full of boiling water, for 10 minutes. Enough heat must be supplied to prevent the water bath from cooling much below the boiling point upon inserting the volumetric flask. Remove the flask, cool to room temperature, dilute to the mark, and mix.

11.2.2 Transfer a suitable portion of the reference solution to an absorption cell, and adjust the spectrophotometer to the initial setting using a light band centered at 660 nm. While maintaining this spectrophotometer adjustment, take the readings of the calibration solutions followed by the samples.

12.0 Data Analysis and Calculations

Same as in Method 108A, Section 12.0.

13.0 Method Performance. [Reserved]

14.0 Pollution Prevention. [Reserved]

15.0 Waste Management. [Reserved]

16.0 References

1. Ringwald, D. Arsenic Determination on Process Materials from ASARCO's Copper Smelter in Tacoma, Washington. Unpublished Report. Prepared for the Emission Measurement Branch, Technical Support Division, U.S. Environmental Protection Agency, Research Triangle Park, North Carolina. August 1980. 35 pp.

17.0 TABLES, DIAGRAMS, FLOWCHARTS, AND VALIDATION DATA

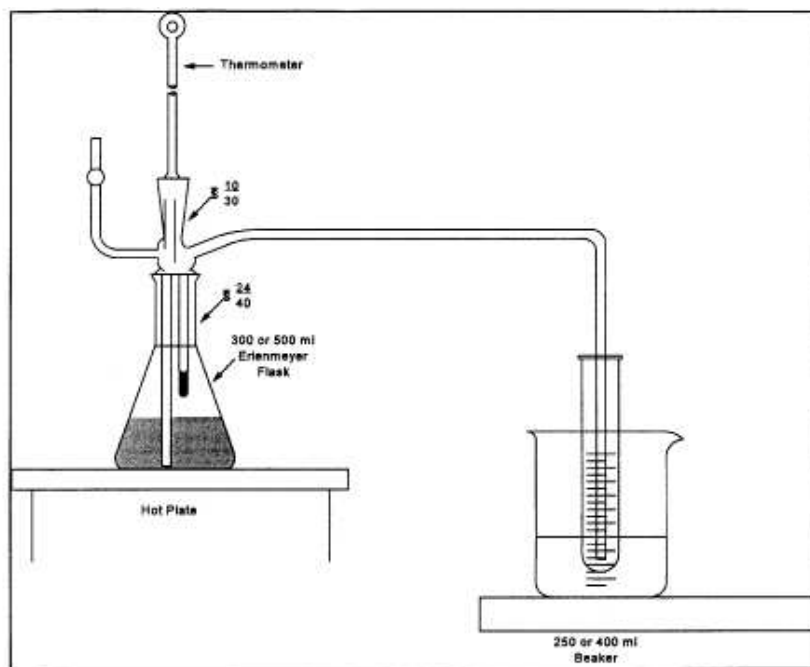

Figure 108C-1. Distillation Apparatus.

[View or download PDF](#)

METHOD 111—DETERMINATION OF POLONIUM-210 EMISSIONS FROM STATIONARY SOURCES

NOTE: This method does not include all of the specifications (e.g., equipment and supplies) and procedures (e.g., sampling and analytical) essential to its performance. Some material is incorporated by reference from methods in appendix A to 40 CFR part 60. Therefore, to obtain reliable results, persons using this method should

have a thorough knowledge of at least the following additional test methods: Method 1, Method 2, Method 3, and Method 5.

1.0 Scope and Application

1.1 Analytes.

Analyte	CAS No.	Sensitivity
Polonium	7440-08-6	Not specified.

1.2 Applicability. This method is applicable for the determination of the polonium-210 content of particulate matter samples collected from stationary source exhaust stacks, and for the use of these data to calculate polonium-210 emissions from individual sources and from all affected sources at a facility.

1.3 Data Quality Objectives. Adherence to the requirements of this method will enhance the quality of the data obtained from air pollutant sampling methods.

2.0 Summary of Method

A particulate matter sample, collected according to Method 5, is analyzed for polonium-210 content: the polonium-210 in the sample is put in solution, deposited on a metal disc, and the radioactive disintegration rate measured. Polonium in acid solution spontaneously deposits on surfaces of metals that are more electropositive than polonium. This principle is routinely used in the radiochemical analysis of polonium-210. Data reduction procedures are provided, allowing the calculation of polonium-210 emissions from individual sources and from all affected sources at a facility, using data obtained from Methods 2 and 5 and from the analytical procedures herein.

3.0 Definitions [Reserved]

4.0 Interferences [Reserved]

5.0 Safety

5.1 Disclaimer. This method may involve hazardous materials, operations, and equipment. This test method may not address all of the safety problems associated with its use. It is the responsibility of the user of this test method to establish appropriate safety and health practices and determine the applicability of regulatory limitations prior to performing this test method.

5.2 Corrosive Reagents. The following reagents are hazardous. Personal protective equipment and safe procedures are useful in preventing chemical splashes. If contact occurs, immediately flush with copious amounts of water at least 15 minutes. Remove clothing under shower and decontaminate. Treat residual chemical burns as thermal burns.

5.2.1 Hydrochloric Acid (HCl). Highly corrosive liquid with toxic vapors. Vapors are highly irritating to eyes, skin, nose, and lungs, causing severe damage. May cause bronchitis, pneumonia, or edema of lungs. Exposure to concentrations of 0.13 to 0.2 percent can be lethal to humans in a few minutes. Provide ventilation to limit exposure. Reacts with metals, producing hydrogen gas.

5.2.2 Hydrofluoric Acid (HF). Highly corrosive to eyes, skin, nose, throat, and lungs. Reaction to exposure may be delayed by 24 hours or more. Provide ventilation to limit exposure.

5.2.3 Nitric Acid (HNO₃). Highly corrosive to eyes, skin, nose, and lungs. Vapors cause bronchitis, pneumonia, or edema of lungs. Reaction to inhalation may be delayed as long as 30 hours and still be fatal. Provide ventilation to limit exposure. Strong oxidizer. Hazardous reaction may occur with organic materials such as solvents.

5.2.4 Perchloric Acid (HClO₄). Corrosive to eyes, skin, nose, and throat. Provide ventilation to limit exposure. Keep separate from water and oxidizable materials to prevent vigorous evolution of

heat, spontaneous combustion, or explosion. Heat solutions containing HClO₄ only in hoods specifically designed for HClO₄.

6.0 *Equipment and Supplies*

6.1 Alpha Spectrometry System. Consisting of a multichannel analyzer, biasing electronics, silicon surface barrier detector, vacuum pump and chamber.

6.2 Constant Temperature Bath at 85 °C (185 °F).

6.3 Polished Silver Discs. 3.8 cm diameter, 0.4 mm thick with a small hole near the edge.

6.4 Glass Beakers. 400 ml, 150 ml.

6.5 Hot Plate, Electric.

6.6 Fume Hood.

6.7 Teflon Beakers, 150 ml.

6.8 Magnetic Stirrer.

6.9 Stirring Bar.

6.10 Hooks. Plastic or glass, to suspend plating discs.

6.11 Internal Proportional Counter. For measuring alpha particles.

6.12 Nucleopore Filter Membranes. 25 mm diameter, 0.2 micrometer pore size or equivalent.

6.13 Planchets. Stainless steel, 32 mm diameter with 1.5 mm lip.

6.14 Transparent Plastic Tape. 2.5 cm wide with adhesive on both sides.

6.15 Epoxy Spray Enamel.

6.16 Suction Filter Apparatus. For 25 mm diameter filter.

6.17 Wash Bottles, 250 ml capacity.

6.18 Graduated Cylinder, plastic, 25 ml capacity.

6.19 Volumetric Flasks, 100 ml, 250 ml.

7.0 *Reagents and Standards*

Unless otherwise indicated, it is intended that all reagents conform to the specifications established by the Committee on Analytical Reagents of the American Chemical Society, where such specifications are available; otherwise, use the best available grade.

7.1 Ascorbic Acid.

7.2 Ammonium Hydroxide (NH₄ OH), 15 M.

7.3 Water. Deionized distilled, to conform to ASTM D 1193-77 or 91 (incorporated by reference—see § 61.18), Type 3. Use in all dilutions requiring water.

7.4 Ethanol (C₂ H₅ OH), 95 percent.

7.5 Hydrochloric Acid, 12 M.

7.6 Hydrochloric Acid, 1 M. Dilute 83 ml of the 12 M HCl to 1 liter with distilled water.

7.7 Hydrofluoric Acid, 29 M.

7.8 Hydrofluoric Acid, 3 M. Dilute 52 ml of the 29 M HF to 500 ml with distilled water. Use a plastic graduated cylinder and storage bottle.

7.9 Lanthanum Carrier, 0.1 mg La^{+3} /ml. Dissolve 0.078 gram lanthanum nitrate, $\text{La}(\text{NO}_3)_3 \cdot 6\text{H}_2\text{O}$ in 250 ml of 1 M HCl.

7.10 Nitric Acid, 16 M.

7.11 Perchloric Acid, 12 M.

7.12 Polonium-209 Solution.

7.13 Silver Cleaner. Any mild abrasive commercial silver cleaner.

7.14 Degreaser.

7.15 Standard Solution. Standardized solution of an alpha-emitting actinide element, such as plutonium-239 or americium-241.

8.0 Sample Collection, Preservation, Transport, and Storage. [Reserved]

9.0 Quality Control

9.1 General Requirement.

9.1.1 All analysts using this method are required to demonstrate their ability to use the method and to define their respective accuracy and precision criteria.

9.2 MISCELLANEOUS QUALITY CONTROL MEASURES

Section	Quality control measure	Effect
10.1	Standardization of alpha spectrometry system	Ensure precision of sample analyses.
10.3	Standardization of internal proportional counter	Ensure precise sizing of sample aliquot.
11.1, 11.2	Determination of procedure background and instrument background	Minimize background effects.

10.0 Calibration and Standardization

10.1 Standardization of Alpha Spectrometry System.

10.1.1 Add a quantity of the actinide standard solution to a 100 ml volumetric flask so that the final concentration when diluted to a volume of 100 ml will be approximately 1_p Ci/ml.

10.1.2 Add 10 ml of 16 M HNO_3 and dilute to 100 ml with water.

10.1.3 Add 20 ml of 1 M HCl to each of six 150 ml beakers. Add 1.0 ml of lanthanum carrier, 0.1 mg lanthanum per ml, to the acid solution in each beaker.

10.1.4 Add 1.0 ml of the 1 pCi/ml working solution (from Section 10.1.1) to each beaker. Add 5.0 ml of 3 M HF to each beaker.

10.1.5 Cover beakers and allow solutions to stand for a minimum of 30 minutes. Filter the contents of each beaker through a separate filter membrane using the suction filter apparatus. After

each filtration, wash the filter membrane with 10 ml of distilled water and 5 ml of ethanol, and allow the filter membrane to air dry on the filter apparatus.

10.1.6 Carefully remove the filter membrane and mount it, filtration side up, with double-side tape on the inner surface of a planchet. Place planchet in an alpha spectrometry system and count each planchet for 1000 minutes.

10.1.7 Calculate the counting efficiency of the detector for each aliquot of the 1 pCi/ml actinide working solution using Eq. 111-1 in Section 12.2.

10.1.8 Determine the average counting efficiency of the detector, E_c , by calculating the average of the six determinations.

10.2 Preparation of Standardized Solution of Polonium-209.

10.2.1 Add a quantity of the Po-209 solution to a 100 ml volumetric flask so that the final concentration when diluted to a 100 ml volume will be approximately 1 pCi/ml.

10.2.2 Follow the procedures outlined in Sections 10.1.2 through 10.1.6, except substitute 1.0 ml of polonium-209 tracer solution (Section 10.2.1) and 3.0 ml of 15 M ammonium hydroxide for the 1 pCi/ml actinide working solution and the 3 M HF, respectively.

10.2.3 Calculate the activity of each aliquot of the polonium-209 tracer solution using Eq. 111-2 in Section 12.3.

10.2.4 Determine the average activity of the polonium-209 tracer solution, F , by averaging the results of the six determinations.

10.3 Standardization of Internal Proportional Counter

10.3.1 Add a quantity of the actinide standard solution to a 100 ml volumetric flask so that the final concentration when diluted to a 100 ml volume will be approximately 100 pCi/ml.

10.3.2 Follow the procedures outlined in Sections 10.1.2 through 10.1.6, except substitute the 100 pCi/ml actinide working solution for the 1 pCi/ml solution, place the planchet in an internal proportional counter (instead of an alpha spectrometry system), and count for 100 minutes (instead of 1000 minutes).

10.3.3 Calculate the counting efficiency of the internal proportional counter for each aliquot of the 100 pCi/ml actinide working solution using Eq. 111-3 in 12.4.

10.3.4 Determine the average counting efficiency of the internal proportional counter, E_i , by averaging the results of the six determinations.

11.0 ANALYTICAL PROCEDURE

NOTE: Perform duplicate analyses of all samples, including background counts and Method 5 samples. Duplicate measurements are considered acceptable when the difference between them is less than two standard deviations as described in EPA 600/4-77-001 or subsequent revisions.

11.1 Determination of Procedure Background. Background counts used in all equations are determined by performing the specific analysis required using the analytical reagents only. All procedure background counts and sample counts for the internal proportional counter should utilize a counting time of 100 minutes; for the alpha spectrometry system, 1000 minutes. These background counts should be performed no less frequently than once per 10 sample analyses.

11.2 Determination of Instrument Background. Instrument backgrounds of the internal proportional counter and the alpha spectrometry system should be determined on a weekly basis. Instrument background should not exceed procedure background. If this occurs, it may be due to a malfunction or contamination, and should be corrected before use.

11.4 Sample Preparation. Treat the Method 5 samples [*i.e.*, the glass fiber filter (Container No. 1) and the acetone rinse (Container No. 2)] as follows:

11.4.1 Container No. 1. Transfer the filter and any loose particulate matter from the sample container to a 150-ml Teflon beaker.

11.4.2 Container No. 2. Note the level of liquid in the container, and confirm on the analysis sheet whether leakage occurred during transport. If a noticeable amount of leakage has occurred, either void the sample or use methods, subject to the approval of the Administrator, to correct the final results. Transfer the contents to a 400-ml glass beaker. Add polonium-209 tracer solution to the glass beaker in an amount approximately equal to the amount of polonium-210 expected in the total particulate sample. Record the activity of the tracer solution added. Add 16 M nitric acid to the beaker to digest and loosen the residue.

11.4.3 Transfer the contents of the glass beaker to the Teflon beaker containing the glass fiber filter. Rinse the glass beaker with 16 M HNO₃. If necessary, reduce the volume in the beaker by evaporation until all of the nitric acid HNO₃ from the glass beaker has been transferred to the Teflon beaker.

11.4.4 Add 30 ml of 29 M HF to the Teflon beaker and evaporate to near dryness on a hot plate in a properly operating hood.

NOTE: Do not allow the residue to go to dryness and overheat; this will result in loss of polonium.

11.4.5 Repeat step 11.4.4 until the filter is dissolved.

11.4.6 Add 100 ml of 16 M HNO₃ to the residue in the Teflon beaker and evaporate to near dryness.

NOTE: Do not allow the residue to go to dryness.

11.4.7 Add 50 ml of 16 M HNO₃ and 10 ml of 12 M perchloric acid to the Teflon beaker and heat until dense fumes of perchloric acid are evolved.

11.4.8 Repeat steps 11.4.4 to 11.4.7 as necessary until sample is completely dissolved.

11.4.9 Add 10 ml of 12 M HCl to the Teflon beaker and evaporate to dryness. Repeat additions and evaporations several times.

11.4.10 Transfer the sample to a 250-ml volumetric flask and dilute to volume with 3 M HCl.

11.5 Sample Screening. To avoid contamination of the alpha spectrometry system, check each sample as follows:

11.5.1 Add 20 ml of 1 M HCl, 1 ml of the lanthanum carrier solution (0.1 mg La/ml), a 1 ml aliquot of the sample solution from Section 11.4.10, and 3 ml of 15 M ammonium hydroxide to a 250-ml beaker in the order listed. Allow this solution to stand for a minimum of 30 minutes.

11.5.2 Filter the solution through a filter membrane using the suction filter apparatus. Wash the filter membrane with 10 ml of water and 5 ml of ethanol, and allow the filter membrane to air dry on the filter apparatus.

11.5.3 Carefully remove the filter membrane and mount it, filtration side up, with double-side tape on the inner surface of a planchet. Place the planchet in an internal proportional counter, and count for 100 minutes.

11.5.4 Calculate the activity of the sample using Eq. 111-4 in Section 12.5.

11.5.5 Determine the aliquot volume of the sample solution from Section 11.4.10 to be analyzed for polonium-210, such that the aliquot contains an activity between 1 and 4 picocuries. Use Eq. 111-5 in Section 12.6.

11.6 Preparation of Silver Disc for Spontaneous Electrodeposition.

11.6.1 Clean both sides of the polished silver disc with silver cleaner and with degreaser.

11.6.2 Place disc on absorbent paper and spray one side with epoxy spray enamel. This should be carried out in a well-ventilated area, with the disc lying flat to keep paint on one side only. Allow paint to dry for 24 hours before using disc for deposition.

11.7 Sample Analysis.

11.7.1 Add the aliquot of sample solution from Section 11.4.10 to be analyzed for polonium-210, the volume of which was determined in Section 11.5.5, to a suitable 200-ml container to be placed in a constant temperature bath.

NOTE: Aliquot volume may require a larger container.

11.7.2 If necessary, bring the volume to 100 ml with 1 M HCl. If the aliquot volume exceeds 100 ml, use total aliquot.

11.7.3 Add 200 mg of ascorbic acid and heat solution to 85 °C (185 °F) in a constant temperature bath.

11.7.4 Suspend a silver disc in the heated solution using a glass or plastic rod with a hook inserted through the hole in the disc. The disc should be totally immersed in the solution, and the solution must be stirred constantly, at all times during the plating operation. Maintain the disc in solution for 3 hours.

11.7.5 Remove the silver disc, rinse with deionized distilled water, and allow to air dry at room temperature.

11.7.6 Place the disc, with deposition side (unpainted side) up, on a planchet and secure with double-side plastic tape. Place the planchet with disc in alpha spectrometry system and count for 1000 minutes.

12.0 Data Analysis and Calculations.

12.1 Nomenclature.

A = Picocuries of polonium-210 in the Method 5 sample (from Section 12.8).

A_A = Picocuries of actinide added.

A_L = Volume of sample aliquot used, in ml (specified in Section 11.5.1 as 1 ml).

A_S = Aliquot to be analyzed, in ml.

B_B = Procedure background counts measured in polonium-209 spectral region.

B_T = Polonium-209 tracer counts in sample.

C_T = Total counts in polonium-210 spectral region.

D = Decay correction for time "t" (in days) from sample collection to sample counting, given by:

$$D = e^{-0.005t}$$

E_C = Average counting efficiency of detector (from Section 10.1.8), as counts per disintegration.

E_{Ci} = Counting efficiency of the detector for aliquot i of the actinide working solution, counts per disintegration.

E_i = Average counting efficiency of the internal proportional counter, as determined in Section 10.3.4, counts per disintegration.

E_{ii} = Counting efficiency of the internal proportional counter for aliquot i of the 100 pCi/ml actinide working solution, counts per disintegration.

E_Y = The fraction of polonium-209 recovered on the planchet (from Section 12.7).

F = Average activity of polonium-209 in sample (from Section 10.2.4), in pCi.

F_i = activity of aliquot i of the polonium-209 tracer solution, in pCi.

L = Dilution factor (unitless). This is the volume of sample solution prepared (specified as 250 ml in Section 11.1.10) divided by the volume of the aliquot of sample solution analyzed for polonium-210 (from Section 11.7.1).

M_i = Phosphorous rock processing rate of the source being tested, during run i , Mg/hr.

M_k = Phosphate rock processed annually by source k , in Mg/yr.

n = Number of calciners at the elemental phosphorus plant.

P = Total activity of sample solution from Section 11.4.10, in pCi (see Eq. 111-4).

Q_{sd} = Volumetric flow rate of effluent stream, as determined by Method 2, in dscm/hr.

S = Annual polonium-210 emissions from the entire facility, in curies/yr.

$V_{m(std)}$ = Volume of air sample, as determined by Method 5, in dscm.

X_k = Emission rate from source k , from Section 12.10, in curies/Mg.

10^{-12} = Curies per picocurie.

2.22 = Disintegrations per minute per picocurie.

250 = Volume of solution from Section 11.4.10, in ml.

12.2 Counting Efficiency. Calculate the counting efficiency of the detector for each aliquot of the 1 pCi/ml actinide working solution using Eq. 111-1.

$$E_{Ci} = \frac{C_S - C_B}{2.22 A_i T} \quad \text{Eq. 111-1}$$

Where:

C_B = Background counts in same peak area as C_S .

C_S = Gross counts in actinide peak.

T = Counting time in minutes, specified in Section 10.1.6 as 1000 minutes.

12.3 Polonium-209 Tracer Solution Activity. Calculate the activity of each aliquot of the polonium-209 tracer solution using Eq. 111-2.

$$F_i = \frac{C_S - C_B}{2.22 E_{Ci} T} \quad \text{Eq. 111-2}$$

Where:

C_B = Background counts in the 4.88 MeV region of spectrum the in the counting time T.

C_S = Gross counts of polonium-209 in the 4.88 MeV region of the spectrum in the counting time T.

T = Counting time, specified in Section 10.1.6 as 1000 minutes.

12.4 Control Efficiency of Internal Proportional Counter. Calculate the counting efficiency of the internal proportional counter for each aliquot of the 100 pCi/ml actinide working solution using Eq. 111-3.

$$E_R = \frac{C_S - C_B}{2.22 A_A T} \quad \text{Eq. 111-3}$$

Where:

C_B = Gross counts of procedure background.

C_S = Gross counts of standard.

T = Counting time in minutes, specified in Section 10.3.2 as 100 minutes.

12.5 Calculate the activity of the sample using Eq. 111-4.

$$P = \frac{250 (C_S - C_B)}{2.22 \bar{E}_I A_I T} \quad \text{Eq. 111-4}$$

Where:

C_B = Total counts of procedure background. (See Section 11.1).

C_S = Total counts of screening sample.

T = Counting time for sample and background (which must be equal), in minutes (specified in Section 11.5.3 as 100 minutes).

12.6 Aliquot Volume. Determine the aliquot volume of the sample solution from Section 11.4.10 to be analyzed for polonium-210, such that the aliquot contains an activity between 1 and 4 picocuries using Eq. 111-5.

$$A_s = \frac{250 (\text{desired picocuries in aliquot})}{P} \quad \text{Eq. 111-5}$$

12.7 Polonium-209 Recovery. Calculate the fraction of polonium-209 recovered on the planchet, E_Y , using Eq. 111-6.

$$E_Y = \frac{B_T - B_B}{2.22 \bar{F} \bar{E}_C T} \quad \text{Eq. 111-6}$$

Where:

T = Counting time, specified in Section 11.1 as 1000 minutes.

12.8 Polonium-210 Activity. Calculate the activity of polonium-210 in the Method 5 sample (including glass fiber filter and acetone rinse) using Eq. 111-7.

$$A = \frac{(C_T - C_B) L}{2.22 E_y \overline{E_C} T D} \quad \text{Eq. 111-7}$$

Where:

C_B = Procedure background counts in polonium-210 spectral region.

T = Counting time, specified in Section 11.1 as 1000 minutes for all alpha spectrometry sample and background counts.

12.9 Emission Rate from Each Stack.

12.9.1 For each test run, i , on a stack, calculate the measured polonium-210 emission rate, R_{Si} , using Eq. 111-8.

$$R_{Si} = \frac{(10^{-12}) A Q_{sd}}{V_{m(stk)} M_i} \quad \text{Eq. 111-8}$$

12.9.2 Determine the average polonium-210 emission rate from the stack, R_S , by taking the sum of the measured emission rates for all runs, and dividing by the number of runs performed.

12.9.3 Repeat steps 12.9.1 and 12.9.2 for each stack of each calciner.

12.10 Emission Rate from Each Source. Determine the total polonium-210 emission rate, X_k , from each source, k , by taking the sum of the average emission rates from all stacks to which the source exhausts.

12.11 Annual Polonium-210 Emission Rate from Entire Facility. Determine the annual elemental phosphorus plant emissions of polonium-210, S , using Eq. 111-9.

$$S = \frac{\sum_{k=1}^n (X_k M_k)}{n} \quad \text{Eq. 111-9}$$

13.0 Method Performance. [Reserved]

14.0 Pollution Prevention. [Reserved]

15.0 Waste Management. [Reserved]

16.0 References

1. Blanchard, R.L. "Rapid Determination of Lead-210 and Polonium-210 in Environmental Samples by Deposition on Nickel." *Anal. Chem.*, 38 :189, pp. 189-192. February 1966.

17.0 Tables, Diagrams, Flowcharts, and Validation Data [Reserved]

METHOD 114—TEST METHODS FOR MEASURING RADIONUCLIDE EMISSIONS FROM STATIONARY SOURCES

1. Purpose and Background

This method provides the requirements for: (1) Stack monitoring and sample collection methods appropriate for radionuclides; (2) radiochemical methods which are used in determining the amounts of radionuclides collected by the stack sampling and; (3) quality assurance methods which are conducted in conjunction with these measurements. These methods are appropriate for emissions for stationary sources. A list of references is provided.

Many different types of facilities release radionuclides into air. These radionuclides differ in the chemical and physical forms, half-lives and type of radiation emitted. The appropriate combination of sample extraction, collection and analysis for an individual radionuclide is dependent upon many interrelated factors including the mixture of other radionuclides present. Because of this wide range of conditions, no single method for monitoring or sample collection and analysis of a radionuclide is applicable to all types of facilities. Therefore, a series of methods based on “principles of measurement” are described for monitoring and sample collection and analysis which are applicable to the measurement of radionuclides found in effluent streams at stationary sources. This approach provides the user with the flexibility to choose the most appropriate combination of monitoring and sample collection and analysis methods which are applicable to the effluent stream to be measured.

2. Stack Monitoring and Sample Collection Methods

Monitoring and sample collection methods are described based on “principles of monitoring and sample collection” which are applicable to the measurement of radionuclides from effluent streams at stationary sources. Radionuclides of most elements will be in the particulate form in these effluent streams and can be readily collected using a suitable filter media. Radionuclides of hydrogen, oxygen, carbon, nitrogen, the noble gases and in some circumstances iodine will be in the gaseous form. Radionuclides of these elements will require either the use of an in-line or off-line monitor to directly measure the radionuclides, or suitable sorbers, condensers or bubblers to collect the radionuclides.

2.1 Radionuclides as Particulates. The extracted effluent stream is passed through a filter media to remove the particulates. The filter must have a high efficiency for removal of sub-micron particles. The guidance in ANSI/HPS N13.1-1999 (section 6.6.2 Filter media) shall be followed in using filter media to collect particulates (incorporated by reference—see § 61.18 of this part).

2.2 Radionuclides as Gases.

2.2.1 The Radionuclide Tritium (H-3). Tritium in the form of water vapor is collected from the extracted effluent sample by sorption, condensation or dissolution techniques. Appropriate collectors may include silica gel, molecular sieves, and ethylene glycol or water bubblers.

Tritium in the gaseous form may be measured directly in the sample stream using Method B-1, collected as a gas sample or may be oxidized using a metal catalyst to tritiated water and collected as described above.

2.2.2 Radionuclides of Iodine. Iodine is collected from an extracted sample by sorption or dissolution techniques. Appropriate collectors may include charcoal, impregnated charcoal, metal zeolite and caustic solutions.

2.2.3 Radionuclides of Argon, Krypton and Xenon. Radionuclides of these elements are either measured directly by an in-line or off-line monitor, or are collected from the extracted sample by low temperature sorption techniques. Appropriate sorbers may include charcoal or metal zeolite.

2.2.4 Radionuclides of Oxygen, Carbon, Nitrogen and Radon. Radionuclides of these elements are measured directly using an in-line or off-line monitor. Radionuclides of carbon in the form of carbon dioxide may be collected by dissolution in caustic solutions.

2.3 Definition of Terms

In-line monitor means a continuous measurement system in which the detector is placed directly in or adjacent to the effluent stream. This may involve either gross radioactivity measurements or specific radionuclide measurements. Gross measurements shall be made in conformance with the conditions specified in Methods A-4, B-2 and G-4.

Off-line monitor means a measurement system in which the detector is used to continuously measure an extracted sample of the effluent stream. This may involve either gross radioactivity measurements or specific radionuclide measurements. Gross measurements shall be made in conformance with the conditions specified in Methods A-4, B-2 and G-4.

Sample collection means a procedure in which the radionuclides are removed from an extracted sample of the effluent using a collection media. These collection media include filters, absorbers, bubblers and condensers. The collected sample is analyzed using the methods described in Section 3.

3. Radionuclide Analysis Methods

A series of methods based on “principles of measurement” are described which are applicable to the analysis of radionuclides collected from airborne effluent streams at stationary sources. These methods are applicable only under the conditions stated and within the limitations described. Some methods specify that only a single radionuclide be present in the sample or the chemically separated sample. This condition should be interpreted to mean that no other radionuclides are present in quantities which would interfere with the measurement.

Also identified (Table 1) are methods for a selected list of radionuclides. The listed radionuclides are those which are most commonly used and which have the greatest potential for causing dose to members of the public. Use of methods based on principles of measurement other than those described in this section must be approved in advance of use by the Administrator. For radionuclides not listed in Table 1, any of the described methods may be used provided the user can demonstrate that the applicability conditions of the method have been met.

The type of method applicable to the analysis of a radionuclide is dependent upon the type of radiation emitted, i.e., alpha, beta or gamma. Therefore, the methods described below are grouped according to principles of measurements for the analysis of alpha, beta and gamma emitting radionuclides.

3.1 Methods for Alpha Emitting Radionuclides

3.1.1 Method A-1, Radiochemistry-Alpha Spectrometry.

Principle: The element of interest is separated from other elements, and from the sample matrix using radiochemical techniques. The procedure may involve precipitation, ion exchange, or solvent extraction. Carriers (elements chemically similar to the element of interest) may be used. The element is deposited on a planchet in a very thin film by electrodeposition or by coprecipitation on a very small amount of carrier, such as lanthanum fluoride. The deposited element is then counted with an alpha spectrometer. The activity of the nuclide of interest is measured by the number of alpha counts in the appropriate energy region. A correction for chemical yield and counting efficiency is made using a standardized radioactive nuclide (tracer) of the same element. If a radioactive tracer is not available for the element of interest, a predetermined chemical yield factor may be used.

Applicability: This method is applicable for determining the activity of any alpha-emitting radionuclide, regardless of what other radionuclides are present in the sample provided the chemical separation step produces a very thin sample and removes all other radionuclides which could interfere in the spectral region of interest. APHA-605(2), ASTM-D-3972(13).

3.1.2 Method A-2, Radiochemistry-Alpha Counting.

Principle: The element of interest is separated from other elements, and from the sample matrix using radiochemistry. The procedure may involve precipitation, ion exchange, or solvent extraction. Carriers (elements chemically similar to the element of interest) may be used. The element is deposited on a planchet in a thin film and counted with an alpha counter. A correction for chemical yield (if necessary) is made. The alpha count rate measures the total activity of all emitting radionuclides of the separated element.

Applicability: This method is applicable for the measurement of any alpha-emitting radionuclide, provided no other alpha emitting radionuclide is present in the separated sample. It may also be applicable for determining compliance, when other radionuclides of the separated element are present, provided that the calculated emission rate is assigned to the radionuclide which could be present in the sample that has the highest dose conversion factor. IDO-12096(18).

3.1.3 Method A-3, Direct Alpha Spectrometry.

Principle: The sample, collected on a suitable filter, is counted directly on an alpha spectrometer. The sample must be thin enough and collected on the surface of the filter so that any absorption of alpha particle energy in the sample or the filter, which would degrade the spectrum, is minimal.

Applicability: This method is applicable to simple mixtures of alpha emitting radionuclides and only when the amount of particulates collected on the filter paper are relatively small and the alpha spectra is adequately resolved. Resolutions should be 50 keV (FWHM) or better, ASTM-D-3084(16).

3.1.4 Method A-4, Direct Alpha Counting (Gross alpha determination).

Principle: The sample, collected on a suitable filter, is counted with an alpha counter. The sample must be thin enough so that self-absorption is not significant and the filter must be of such a nature that the particles are retained on the surface.

Applicability: Gross alpha determinations may be used to measure emissions of specific radionuclides only (1) when it is known that the sample contains only a single radionuclide, or the identity and isotopic ratio of the radionuclides in the sample are well-known, and (2) measurements using either Method A-1, A-2 or A-5 have shown that this method provides a reasonably accurate measurement of the emission rate. Gross alpha measurements are applicable to unidentified mixtures of radionuclides only for the purposes and under the conditions described in section 3.7. APHA-601 (3), ASTM-D-1943(10).

3.1.5 Method A-5, Chemical Determination of Uranium.

Principle: Uranium may be measured chemically by either colorimetry or fluorometry. In both procedures, the sample is dissolved, the uranium is oxidized to the hexavalent form and extracted into a suitable solvent. Impurities are removed from the solvent layer. For colorimetry, dibenzoylmethane is added, and the uranium is measured by the absorbance in a colorimeter. For fluorometry, a portion of the solution is fused with a sodium fluoride-lithium fluoride flux and the uranium is determined by the ultraviolet activated fluorescence of the fused disk in a fluorometer.

Applicability: This method is applicable to the measurements of emission rates of uranium when the isotopic ratio of the uranium radionuclides is well known. ASTM-E-318(15), ASTM-D-2907(14).

3.1.6 Method A-6, Radon-222—Continuous Gas Monitor.

Principle: Radon-222 is measured directly in a continuously extracted sample stream by passing the air stream through a calibrated scintillation cell. Prior to the scintillation cell, the air stream is treated to remove particulates and excess moisture. The alpha particles from radon-222 and its decay products strike a zinc sulfide coating on the inside of the scintillation cell producing light pulses. The light pulses are detected by a photomultiplier tube which generates electrical pulses. These pulses are processed by the system electronics and the read out is in pCi/l of radon-222.

Applicability: This method is applicable to the measurement of radon-222 in effluent streams which do not contain significant quantities of radon-220. Users of this method should calibrate the monitor in a radon calibration chamber at least twice per year. The background of the monitor should also be checked periodically by operating the instrument in a low radon environment. EPA 520/1-89-009(24).

3.1.7 Method A-7, Radon-222-Alpha Track Detectors

Principle: Radon-222 is measured directly in the effluent stream using alpha track detectors (ATD). The alpha particles emitted by radon-222 and its decay products strike a small plastic strip and produce submicron damage tracks. The plastic strip is placed in a caustic solution that accentuates the damage tracks which are counted using a microscope or automatic counting system. The number of tracks per unit area is correlated to the radon concentration in air using a conversion factor derived from data generated in a radon calibration facility.

Applicability: Prior approval from EPA is required for use of this method. This method is only applicable to effluent streams which do not contain significant quantities of radon-220, unless special detectors are used to discriminate against radon-220. This method may be used only when ATDs have been demonstrated to produce data comparable to data obtained with Method A-6. Such data should be submitted to EPA when requesting approval for the use of this method. EPA 520/1-89-009 (24).

3.2 Methods for Gaseous Beta Emitting Radionuclides.

3.2.1 Method B-1, Direct Counting in Flow-Through Ionization Chambers.

Principle: An ionization chamber containing a specific volume of gas which flows at a given flow rate through the chamber is used. The sample (effluent stream sample) acts as the counting gas for the chamber. The activity of the radionuclide is determined from the current measured in the ionization chamber.

Applicability: This method is applicable for measuring the activity of a gaseous beta-emitting radionuclide in an effluent stream that is suitable as a counting gas, when no other beta-emitting nuclides are present. DOE/EP-0096(17), NCRP-58(23).

3.2.2 Method B-2, Direct Counting With In-line or Off-line Beta Detectors.

Principle: The beta detector is placed directly in the effluent stream (in-line) or an extracted sample of the effluent stream is passed through a chamber containing a beta detector (off-line). The activities of the radionuclides present in the effluent stream are determined from the beta count rate, and a knowledge of the radionuclides present and the relationship of the gross beta count rate and the specific radionuclide concentration.

Applicability: This method is applicable only to radionuclides with maximum beta particle energies greater than 0.2 MeV. This method may be used to measure emissions of specific radionuclides only when it is known that the sample contains only a single radionuclide or the identity and isotopic ratio of the radionuclides in the effluent stream are well known. Specific radionuclide analysis of periodic grab samples may be used to identify the types and quantities of radionuclides present and to establish the relationship between specific radionuclide analyses and gross beta count rates.

This method is applicable to unidentified mixtures of gaseous radionuclides only for the purposes and under the conditions described in section 3.7.

3.3 Methods for Non-Gaseous Beta Emitting Radionuclides.

3.3.1 Method B-3, Radiochemistry-Beta Counting.

Principle: The element of interest is separated from other elements, and from the sample matrix by radiochemistry. This may involve precipitation, distillation, ion exchange, or solvent extraction. Carriers (elements chemically similar to the element of interest) may be used. The element is deposited on a planchet, and counted with a beta counter. Corrections for chemical yield, and decay (if necessary) are made. The beta count rate determines the total activity of all radionuclides of the separated element. This method may also involve the radiochemical separation and counting of a daughter element, after a suitable period of ingrowth, in which case it is specific for the parent nuclide.

Applicability: This method is applicable for measuring the activity of any beta-emitting radionuclide, with a maximum energy greater than 0.2 MeV, provided no other radionuclide is present in the separated sample. APHA-608(5).

3.3.2 Method B-4, Direct Beta Counting (Gross beta determination).

Principle: The sample, collected on a suitable filter, is counted with a beta counter. The sample must be thin enough so that self-absorption corrections can be made.

Applicability: Gross beta measurements are applicable only to radionuclides with maximum beta particle energies greater than 0.2 MeV. Gross beta measurements may be used to measure emissions of specific radionuclides only (1) when it is known that the sample contains only a single radionuclide, and (2) measurements made using Method B-3 show reasonable agreement with the gross beta measurement. Gross beta measurements are applicable to mixtures of radionuclides only for the purposes and under the conditions described in section 3.7. APHA-602(4), ASTM-D-1890(11).

3.3.3 Method B-5, Liquid Scintillation Spectrometry.

Principle: An aliquot of a collected sample or the result of some other chemical separation or processing technique is added to a liquid scintillation “cocktail” which is viewed by photomultiplier tubes in a liquid scintillation spectrometer. The spectrometer is adjusted to establish a channel or “window” for the pulse energy appropriate to the nuclide of interest. The activity of the nuclide of interest is measured by the counting rate in the appropriate energy channel. Corrections are made for chemical yield where separations are made.

Applicability: This method is applicable to any beta-emitting nuclide when no other radionuclide is present in the sample or the separated sample provided that it can be incorporated in the scintillation cocktail. This method is also applicable for samples which contain more than one radionuclide but only when the energies of the beta particles are sufficiently separated so that they can be resolved by the spectrometer. This method is most applicable to the measurement of low-energy beta emitters such as tritium and carbon-14. APHA-609(6), EML-LV-539-17(19).

3.4 Gamma Emitting Radionuclides

3.4.1 Method G-1, High Resolution Gamma Spectrometry.

Principle: The sample is counted with a high resolution gamma detector, usually either a Ge(Li) or a high purity Ge detector, connected to a multichannel analyzer or computer. The gamma emitting radionuclides in the sample are measured from the gamma count rates in the energy regions characteristic of the individual radionuclide. Corrections are made for counts contributed by other radionuclides to the spectral regions of the radionuclides of interest. Radiochemical separations may be made prior to counting but are usually not necessary.

Applicability: This method is applicable to the measurement of any gamma emitting radionuclide with gamma energies greater than 20 keV. It can be applied to complex mixtures of radionuclides. The samples counted may be in the form of particulate filters, absorbers, liquids or gases. The method may also be applied to the analysis of gaseous gamma emitting radionuclides directly in an effluent stream by passing the stream through a chamber or cell containing the detector. ASTM-3649(9), IDO-12096 (18).

3.4.2 Method G-2, Low Resolution Gamma Spectrometry.

Principle: The sample is counted with a low resolution gamma detector, a thallium activated sodium iodide crystal. The detector is coupled to a photomultiplier tube and connected to a multichannel analyzer. The gamma emitting radionuclides in the sample are measured from the gamma count rates in the energy regions characteristic of the individual radionuclides. Corrections are made for counts contributed by other radionuclides to the spectral regions of the radionuclides of interest. Radiochemical separation may be used prior to counting to obtain less complex gamma spectra if needed.

Applicability: This method is applicable to the measurement of gamma emitting radionuclides with energies greater than 100 keV. It can be applied only to relatively simple mixtures of gamma emitting radionuclides. The samples counted may be in the form of particulate filters, absorbers, liquids or gas. The method can be applied to the analysis of gaseous radionuclides directly in an effluent stream by passing the gas stream through a chamber or cell containing the detector. ASTM-D-2459(12), EMSL-LV-0539-17(19).

3.4.3 Method G-3, Single Channel Gamma Spectrometry.

Principle: The sample is counted with a thallium activated sodium iodide crystal. The detector is coupled to a photomultiplier tube connected to a single channel analyzer. The activity of a gamma emitting radionuclide is determined from the gamma counts in the energy range for which the counter is set.

Applicability: This method is applicable to the measurement of a single gamma emitting radionuclide. It is not applicable to mixtures of radionuclides. The samples counted may be in the form of particulate filters, absorbers, liquids or gas. The method can be applied to the analysis of gaseous radionuclides directly in an effluent stream by passing the gas stream through a chamber or cell containing the detector.

3.4.4 Method G-4, Gross Gamma Counting.

Principle: The sample is counted with a gamma detector usually a thallium activated sodium iodine crystal. The detector is coupled to a photomultiplier tube and gamma rays above a specific threshold energy level are counted.

Applicability: Gross gamma measurements may be used to measure emissions of specific radionuclides only when it is known that the sample contains a single radionuclide or the identity and isotopic ratio of the radionuclides in the effluent stream are well known. When gross gamma measurements are used to determine emissions of specific radionuclides periodic measurements using Methods G-1 or G-2 should be made to demonstrate that the gross gamma measurements provide reliable emission data. This method may be applied to analysis of gaseous radionuclides directly in an effluent stream by placing the detector directly in or adjacent to the effluent stream or passing an extracted sample of the effluent stream through a chamber or cell containing the detector.

3.5 Counting Methods. All of the above methods with the exception of Method A-5 involve counting the radiation emitted by the radionuclide. Counting methods applicable to the measurement of alpha, beta and gamma radiations are listed below. The equipment needed and the counting principles involved are described in detail in ASTM-3648(8).

3.5.1 Alpha Counting:

- *Gas Flow Proportional Counters.* The alpha particles cause ionization in the counting gas and the resulting electrical pulses are counted. These counters may be windowless or have very thin windows.
- *Scintillation Counters.* The alpha particles transfer energy to a scintillator resulting in a production of light photons which strike a photomultiplier tube converting the light photons to electrical pulses which are counted. The counters may involve the use of solid scintillation materials such as zinc sulfide or liquid scintillation solutions.
- *Solid-State Counters.* Semiconductor materials, such as silicon surface-barrier p-n junctions, act as solid ionization chambers. The alpha particles interact with the detector producing electron hole pairs. The charged pair is collected by an applied electrical field and the resulting electrical pulses are counted.
- *Alpha Spectrometers.* Semiconductor detectors used in conjunction with multichannel analyzers for energy discrimination.

3.5.2 Beta Counting:

- *Ionization Chambers.* These chambers contain the beta-emitting nuclide in gaseous form. The ionization current produced is measured.
- *Geiger-Muller (GM) Counters-or Gas Flow Proportional Counters.* The beta particles cause ionization in the counting gas and the resulting electrical pulses are counted. Proportional gas flow counters which are heavily shielded by lead or other metal, and provided with an anti-coincidence shield to reject cosmic rays, are called low background beta counters.

- *Scintillation Counters.* The beta particles transfer energy to a scintillator resulting in a production of light photons, which strike a photomultiplier tube converting the light photon to electrical pulses which are counted. This may involve the use of anthracene crystals, plastic scintillator, or liquid scintillation solutions with organic phosphors.

- *Liquid Scintillation Spectrometers.* Liquid scintillation counters which use two photomultiplier tubes in coincidence to reduce background counts. This counter may also electronically discriminate among pulses of a given range of energy.

3.5.3 Gamma Counting:

- *Low-Resolution Gamma Spectrometers.* The gamma rays interact with thallium activated sodium iodide or cesium iodide crystal resulting in the release of light photons which strike a photomultiplier tube converting the light pulses to electrical pulses proportional to the energy of the gamma ray. Multi-channel analyzers are used to separate and store the pulses according to the energy absorbed in the crystal.

- *High-Resolution gamma Spectrometers.* Gamma rays interact with a lithium-drifted (Ge(Li)) or high-purity germanium (HPGe) semiconductor detectors resulting in a production of electron-hole pairs. The charged pair is collected by an applied electrical field. A very stable low noise preamplifier amplifies the pulses of electrical charge resulting from the gamma photon interactions. Multichannel analyzers or computers are used to separate and store the pulses according to the energy absorbed in the crystal.

- *Single Channel Analyzers.* Thallium activated sodium iodide crystals used with a single window analyzer. Pulses from the photomultiplier tubes are separated in a single predetermined energy range.

3.5.4 Calibration of Counters. Counters are calibrated for specific radionuclide measurements using a standard of the radionuclide under either identical or very similar conditions as the sample to be counted. For gamma spectrometers a series of standards covering the energy range of interest may be used to construct a calibration curve relating gamma energy to counting efficiency.

In those cases where a standard is not available for a radionuclide, counters may be calibrated using a standard with energy characteristics as similar as possible to the radionuclide to be measured. For gross alpha and beta measurements of the unidentified mixtures of radionuclides, alpha counters are calibrated with a natural uranium standard and beta counters with a cesium-137 standard. The standard must contain the same weight and distribution of solids as the samples, and be mounted in an identical manner. If the samples contain variable amounts of solids, calibration curves relating weight of solids present to counting efficiency are prepared. Standards other than those prescribed may be used provided it can be shown that such standards are more applicable to the radionuclide mixture measured.

3.6 Radiochemical Methods for Selected Radionuclides. Methods for a selected list of radionuclides are listed in Table 1. The radionuclides listed are those which are most commonly used and which have the greatest potential for causing doses to members of the public. For radionuclides not listed in Table 1, methods based on any of the applicable "principles of measurement" described in section 3.1 through 3.4 may be used.

3.7 Applicability of Gross Alpha and Beta Measurements to Unidentified Mixtures of Radionuclides. Gross alpha and beta measurements may be used as a screening measurement as a part of an emission measurement program to identify the need to do specific radionuclide analyses or to confirm or verify that unexpected radionuclides are not being released in significant quantities.

Gross alpha (Method A-4) or gross beta (Methods B-2 or B-4) measurements may also be used for the purpose of comparing the measured concentrations in the effluent stream with the limiting "Concentration Levels for Environmental Compliance" in table 2 of appendix E. For unidentified mixtures, the measured concentration value shall be compared with the lowest environmental concentration limit for any radionuclide which is not known to be absent from the effluent stream.

TABLE 1—LIST OF APPROVED METHODS FOR SPECIFIC RADIONUCLIDES

Radionuclide	Approved methods of analysis
Am-241	A-1, A-2, A-3, A-4
Ar-41	B-1, B-2, G-1, G-2, G-3, G-4
Ba-140	G-1, G-2, G-3, G-4
Br-82	G-1, G-2, G-3, G-4
C-11	B-1, B-2, G-1, G-2, G-3, G-4
C-14	B-5
Ca-45	B-3, B-4, B-5
Ce-144	G-1, G-2, G-3, G-4
Cm-244	A-1, A-2, A-3, A-4
Co-60	G-1, G-2, G-3, G-4
Cr-51	G-1, G-2, G-3, G-4
Cs-134	G-1, G-2, G-3, G-4
Cs-137	G-1, G-2, G-3, G-4
Fe-55	B-5, G-1
Fe-59	G-1, G-2, G-3, G-4
Ga-67	G-1, G-2, G-3, G-4
H-3 (H ₂ O)	B-5
H-3 (gas)	B-1
I-123	G-1, G-2, G-3, G-4
I-125	G-1
I-131	G-1, G-2, G-3, G-4
In-113m	G-1, G-2, G-3, G-4
Ir-192	G-1, G-2, G-3, G-4
Kr-85	B-1, B-2, B-5, G-1, G-2, G-3, G-4
Kr-87	B-1, B-2, G-1, G-2, G-3, G-4
Kr-88	B-1, B-2, G-1, G-2, G-3, G-4
Mn-54	G-1, G-2, G-3, G-4
Mo-99	G-1, G-2, G-3, G-4
N-13	B-1, B-2, G-1, G-2, G-3, G-4
O-15	B-1, B-2, G-1, G-2, G-3, G-4
P-32	B-3, B-4, B-5
Pm-147	B-3, B-4, B-5
Po-210	A-1, A-2, A-3, A-4
Pu-238	A-1, A-2, A-3, A-4
Pu-239	A-1, A-2, A-3, A-4
Pu-240	A-1, A-2, A-3, A-4
Ra-226	A-1, A-2, G-1, G-2
S-35	B-5
Se-75	G-1, G-2, G-3, G-4
Sr-90	B-3, B-4, B-5
Tc-99	B-3, B-4, B-5
Te-201	G-1, G-2, G-3, G-4
Uranium (total alpha)	A-1, A-2, A-3, A-4
Uranium (Isotopic)	A-1, A-3
Uranium (Natural)	A-5

Xe-133	G-1
Yb-169	G-1, G-2, G-3, G-4
Zn-65	G-1, G-2, G-3, G-4

4. *Quality Assurance Methods*

Each facility required to measure their radionuclide emissions shall conduct a quality assurance program in conjunction with the radionuclide emission measurements. This program shall assure that the emission measurements are representative, and are of known precision and accuracy and shall include administrative controls to assure prompt response when emission measurements indicate unexpectedly large emissions. The program shall consist of a system of policies, organizational responsibilities, written procedures, data quality specifications, audits, corrective actions and reports. This quality assurance program shall include the following program elements:

4.1 The organizational structure, functional responsibilities, levels of authority and lines of communications for all activities related to the emissions measurement program shall be identified and documented.

4.2 Administrative controls shall be prescribed to ensure prompt response in the event that emission levels increase due to unplanned operations.

4.3 The sample collection and analysis procedures used in measuring the emissions shall be described including where applicable:

4.3.1 Identification of sampling sites and number of sampling points, including the rationale for site selections.

4.3.2 A description of sampling probes and representativeness of the samples.

4.3.3 A description of any continuous monitoring system used to measure emissions, including the sensitivity of the system, calibration procedures and frequency of calibration.

4.3.4 A description of the sample collection systems for each radionuclide measured, including frequency of collection, calibration procedures and frequency of calibration.

4.3.5 A description of the laboratory analysis procedures used for each radionuclide measured, including frequency of analysis, calibration procedures and frequency of calibration.

4.3.6 A description of the sample flow rate measurement systems or procedures, including calibration procedures and frequency of calibration.

4.3.7 A description of the effluent flow rate measurement procedures, including frequency of measurements, calibration procedures and frequency of calibration.

4.4 The objectives of the quality assurance program shall be documented and shall state the required precision, accuracy and completeness of the emission measurement data including a description of the procedures used to assess these parameters. Accuracy is the degree of agreement of a measurement with a true or known value. Precision is a measure of the agreement among individual measurements of the same parameters under similar conditions. Completeness is a measure of the amount of valid data obtained compared to the amount expected under normal conditions.

4.5 A quality control program shall be established to evaluate and track the quality of the emissions measurement data against preset criteria. The program should include where applicable a system of replicates, spiked samples, split samples, blanks and control charts. The number and frequency of such quality control checks shall be identified.

4.6 A sample tracking system shall be established to provide for positive identification of samples and data through all phases of the sample collection, analysis and reporting system. Sample

handling and preservation procedures shall be established to maintain the integrity of samples during collection, storage and analysis.

4.7 Regular maintenance, calibration and field checks shall be performed for each sampling system in use by satisfying the requirements found in Table 2: Maintenance, Calibration and Field Check Requirements.

TABLE 2—MAINTENANCE, CALIBRATION AND FIELD CHECK REQUIREMENTS

Sampling system components	Frequency of activity
Cleaning of thermal anemometer elements	As required by application.
Inspect pitot tubes for contaminant deposits	At least annually.
Inspect pitot tube systems for leaks	At least annually.
Inspect sharp-edged nozzles for damage	At least annually or after maintenance that could cause damage.
Check nozzles for alignment, presence of deposits, or other potentially degrading factors	Annually.
Check transport lines of HEPA-filtered applications to determine if cleaning is required	Annually.
Clean transport lines	Visible deposits for HEPA-filtered applications. Mean mass of deposited material exceeds 1g/m ² for other applications.
Inspect or test the sample transport system for leaks	At least annually.
Check mass flow meters of sampling systems with a secondary or transfer standard	At least quarterly.
Inspect rotameters of sampling systems for presence of foreign matter	At the start of each sampling period.
Check response of stack flow rate systems	At least quarterly.
Calibration of flow meters of sampling systems	At least annually.
Calibration of effluent flow measurement devices	At least annually.
Calibration of timing devices	At least annually.

4.8 Periodic internal and external audits shall be performed to monitor compliance with the quality assurance program. These audits shall be performed in accordance with written procedures and conducted by personnel who do not have responsibility for performing any of the operations being audited.

4.9 A corrective action program shall be established including criteria for when corrective action is needed, what corrective actions will be taken and who is responsible for taking the corrective action.

4.10 Periodic reports to responsible management shall be prepared on the performance of the emissions measurements program. These reports should include assessment of the quality of the data, results of audits and description of corrective actions.

4.11 The quality assurance program should be documented in a quality assurance project plan that should address each of the above requirements.

5. References

(1) American National Standards Institute “Guide to Sampling Airborne Radioactive Materials in Nuclear Facilities”, ANSI-N13.1-1969, American National Standards Institute, New York, New York (1969).

(2) American Public Health Association, “Methods of Air Sampling”, 2nd Edition, Method 605, “Tentative Method of Analysis for Plutonium Content of Atmospheric Particulate Matter”. American Public Health Association, New York, NY (1977).

(3) Ibid, Method 601, “Tentative Method of Analysis for Gross Alpha Radioactivity Content of the Atmosphere”.

(4) Ibid, Method 602, “Tentative Method of the Analysis for Gross Beta Radioactivity Content of the Atmosphere”.

(5) Ibid, Method 608, “Tentative Method of Analysis for Strontium-90 Content of Atmospheric Particulate Matter”.

(6) Ibid, Method 609, “Tentative Method of Analysis for Tritium Content of the Atmosphere”.

(7) Ibid, Method 603, “Tentative Method of Analysis for Iodine-131 Content of the Atmosphere”.

(8) American Society for Testing and Materials, 1986 Annual Book ASTM Standards, Designation D-3648-78, “Standard Practices for the Measurement of Radioactivity”. American Society for Testing and Materials, Philadelphia, PA (1986).

(9) Ibid, Designation D-3649-85, “Standard Practice for High Resolution Gamma Spectrometry”.

(10) Ibid, Designation D-1943-81, “Standard Test Method for Alpha Particle Radioactivity of Water”.

(11) Ibid, Designation D-1890-81, “Standard Test Method for Beta Particle Radioactivity of Water”.

(12) Ibid, Designation D-2459-72, “Standard Test Method for Gamma Spectrometry of Water”.

(13) Ibid, Designation D-3972-82, “Standard Test Method for Isotopic Uranium in Water by Radiochemistry”.

(14) Ibid, Designation D-2907-83, “Standard Test Methods for Microquantities of Uranium in Water by Fluorometry”.

(15) Ibid, Designation E-318, “Standard Test Method for Uranium in Aqueous Solutions by Colorimetry”.

(16) Ibid, Designation D-3084-75, “Standard Practice for Alpha Spectrometry of Water”.

(17) Corley, J.P. and C.D. Corbit, “A Guide for Effluent Radiological Measurements at DOE Installations”, DOE/EP-0096, Pacific Northwest Laboratories, Richland, Washington (1983).

(18) Department of Energy, “RESL Analytical Chemistry Branch Procedures Manual”, IDO-12096, U.S. Department of Energy, Idaho Falls, Idaho (1982).

(19) Environmental Protection Agency, “Radiochemical Analytical Procedures for Analysis of Environmental Samples”, EMSL-LV-0539-17, U.S. Environmental Protection Agency, Environmental Monitoring and Support Laboratory, Las Vegas, Nevada (1979).

(20) Environmental Protection Agency, “Radiochemistry Procedures Manual”, EPA 520/5-84-006, Eastern Environmental Radiation Facility, Montgomery, Alabama (1984).

(21) National Council on Radiation Protection and Measurements, NCRP Report No. 50, "Environmental Radiation Measurements", National Council on Radiation Protection and Measurement, Bethesda, Maryland (1976).

(22) Ibid, Report No. 47, "Tritium Measurement Techniques". (1976).

(23) Ibid, Report No. 58 "A Handbook of Radioactivity Measurement Procedures" (1985).

(24) Environmental Protection Agency, "Indoor Radon and Radon Decay Product Measurement Protocols", EPA 520/1-89-009, U.S. Environmental Protection Agency, Washington, DC (1989).

METHOD 115—MONITORING FOR RADON-222 EMISSIONS

This appendix describes the monitoring methods which must be used in determining the radon-222 emissions from underground uranium mines, uranium mill tailings piles, phosphogypsum stacks, and other piles of waste material emitting radon.

1. Radon-222 Emissions from Underground Uranium Mine Vents

1.1 Sampling Frequency and Calculation of Emissions. Radon-222 emissions from underground uranium mine vents shall be determined using one of the following methods:

1.1.1 Continuous Measurement. These measurements shall be made and the emissions calculated as follows:

(a) The radon-222 concentration shall be continuously measured at each mine vent whenever the mine ventilation system is operational.

(b) Each mine vent exhaust flow rate shall be measured at least 4 times per year.

(c) A weekly radon-222 emission rate for the mine shall be calculated and recorded weekly as follows:

$$A_w = C_1 Q_1 T_1 + C_2 Q_2 T_2 + \dots + C_i Q_i T_i$$

Where:

A_w = Total radon-222 emitted from the mine during week (C_i)

C_i = Average radon-222 concentration in mine vent i (C_i/m^3)

Q_i = Volumetric flow rate from mine vent i (m^3/hr)

T_i = Hours of mine ventilation system operation during week for mine vent i (hr)

(d) The annual radon-222 emission rate is the sum of the weekly emission rates during a calendar year.

1.1.2 Periodic Measurement. This method is applicable only to mines that continuously operate their ventilation system except for extended shutdowns. Mines which start up and shut down their ventilation system frequently must use the continuous measurement method describe in Section 1.1.1 above. Emission rates determined using periodic measurements shall be measured and calculated as follows:

(a) The radon-222 shall be continuously measured at each mine vent for at least one week every three months.

(b) Each mine vent exhaust flow rate shall be measured at least once during each of the radon-222 measurement periods.

(c) A weekly radon-222 emission rate shall be calculated for each weekly period according to the method described in Section 1.1.1. In this calculation T=168 hr.

(d) The annual radon-222 emission rate from the mine should be calculated as follows:

$$A_y = \frac{52 - W_s}{n} (A_{w1} + A_{w2} + \dots + A_{wn})$$

Where:

A_y =Annual radon-222 emission rate from the mine(Ci)

A_{wi} =Weekly radon-222 emission rate during the measurement period i (Ci)

n=Number of weekly measurement periods per year

W_s =Number of weeks during the year that the mine ventilation system is shut down in excess of 7 consecutive days, i.e. the sum of the number of weeks each shut down exceeds 7 days

1.2 Test Methods and Procedures

Each underground mine required to test its emissions, unless an equivalent or alternative method has been approved by the Administrator, shall use the following test methods:

1.2.1 Test Method 1 of appendix A to part 60 shall be used to determine velocity traverses. The sampling point in the duct shall be either the centroid of the cross section or the point of average velocity.

1.2.2 Test Method 2 of appendix A to part 60 shall be used to determine velocity and volumetric flow rates.

1.2.3 Test Methods A-6 or A-7 of appendix B, Method 114 to part 61 shall be used for the analysis of radon-222. Use of Method A-7 requires prior approval of EPA based on conditions described in appendix B.

1.2.4 A quality assurance program shall be conducted in conformance with the programs described for Continuous Radon Monitors and Alpha Track Detectors in EPA 520/1-89-009. (2)

2. Radon-222 Emissions from Uranium Mill Tailings Piles

2.1 Measurement and Calculation of Radon Flux from Uranium Mill Tailings Piles.

2.1.1 Frequency of Flux Measurement. A single set of radon flux measurements may be made, or if the owner or operator chooses, more frequent measurements may be made over a one year period. These measurements may involve quarterly, monthly or weekly intervals. All radon measurements shall be made as described in paragraphs 2.1.2 through 2.1.6 except that for measurements made over a one year period, the requirement of paragraph 2.1.4(c) shall not apply. The mean radon flux from the pile shall be the arithmetic mean of the mean radon flux for each measurement period. The weather conditions, moisture content of the tailings and area of the pile covered by water existing at the time of the measurement shall be chosen so as to provide measurements representative of the long term radon flux from the pile and shall be subject to EPA review and approval.

2.1.2 Distribution of Flux Measurements. The distribution and number of radon flux measurements required on a pile will depend on clearly defined areas of the pile (called regions) that can have significantly different radon fluxes due to surface conditions. The mean radon flux shall be determined for each individual region of the pile. Regions that shall be considered for operating mill tailings piles are:

(a) Water covered areas,

- (b) Water saturated areas (beaches),
- (c) Dry top surface areas, and
- (d) Sides, except where earthen material is used in dam construction.

For mill tailings after disposal the pile shall be considered to consist of only one region.

2.1.3 Number of Flux Measurements. Radon flux measurements shall be made within each region on the pile, except for those areas covered with water. Measurements shall be made at regularly spaced locations across the surface of the region, realizing that surface roughness will prohibit measurements in some areas of a region. The minimum number of flux measurements considered necessary to determine a representative mean radon flux value for each type of region on an operating pile is:

- (a) Water covered area—no measurements required as radon flux is assumed to be zero,
- (b) Water saturated beaches—100 radon flux measurements,
- (c) Loose and dry top surface—100 radon flux measurements,
- (d) Sides—100 radon flux measurements, except where earthen material is used in dam construction.

For a mill tailings pile after disposal which consists of only one region a minimum of 100 measurements are required.

2.1.4 Restrictions to Radon Flux Measurements. The following restrictions are placed on making radon flux measurements:

- (a) Measurements shall not be initiated within 24 hours of a rainfall.
- (b) If a rainfall occurs during the 24 hour measurements period, the measurement is invalid if the seal around the lip of the collector has washed away or if the collector is surrounded by water.
- (c) Measurements shall not be performed if the ambient temperature is below 35 °F or if the ground is frozen.

2.1.5 Areas of Pile Regions. The approximate area of each region of the pile shall be determined in units of square meters.

2.1.6 Radon Flux Measurement. Measuring radon flux involves the adsorption of radon on activated charcoal in a large-area collector. The radon collector is placed on the surface of the pile area to be measured and allowed to collect radon for a time period of 24 hours. The radon collected on the charcoal is measured by gamma-ray spectroscopy. The detailed measurement procedure provided in appendix A of EPA 520/5-85-0029(1) shall be used to measure the radon flux on uranium mill tailings, except the surface of the tailings shall not be penetrated by the lip of the radon collector as directed in the procedure, rather the collector shall be carefully positioned on a flat surface with soil or tailings used to seal the edge.

2.1.7 Calculations. The mean radon flux for each region of the pile and for the total pile shall be calculated and reported as follows:

- (a) The individual radon flux calculations shall be made as provided in appendix A EPA 86 (1). The mean radon flux for each region of the pile shall be calculated by summing all individual flux measurements for the region and dividing by the total number of flux measurements for the region.
- (b) The mean radon flux for the total uranium mill tailings pile shall be calculated as follows.

$$J_s = \frac{J_1 A_1 + \dots + J_2 A_2 + \dots + J_i A_i}{A_t}$$

Where:

J_s = Mean flux for the total pile (pCi/m² -s)

J_i = Mean flux measured in region i (pCi/m² -s)

A_i = Area of region i (m²)

A_t = Total area of the pile (m²)

2.1.8 Reporting. The results of individual flux measurements, the approximate locations on the pile, and the mean radon flux for each region and the mean radon flux for the total stack shall be included in the emission test report. Any condition or unusual event that occurred during the measurements that could significantly affect the results should be reported.

3.0 Radon-222 Emissions from Phosphogypsum Stacks.

3.1 Measurement and Calculation of the Mean Radon Flux. Radon flux measurements shall be made on phosphogypsum stacks as described below:

3.1.1 Frequency of Measurements. A single set of radon flux measurements may be made after the phosphogypsum stack becomes inactive, or if the owner or operator chooses, more frequent measurements may be made over a one year period. These measurements may involve quarterly, monthly or weekly intervals. All radon measurements shall be made as described in paragraphs 3.1.2 through 3.1.6 except that for measurements made over a one year period, the requirement of paragraph 3.1.4(c) shall not apply. For measurements made over a one year period, the radon flux shall be the arithmetic mean of the mean radon flux for each measurement period.

3.1.2 Distribution and Number of Flux Measurements. The distribution and number of radon flux measurements required on a stack will depend on clearly defined areas of the stack (called regions) that can have significantly different radon fluxes due to surface conditions. The mean radon flux shall be determined for each individual region of the stack. Regions that shall be considered are:

- (a) Water covered areas,
- (b) Water saturated areas (beaches),
- (c) Loose and dry top surface areas,
- (d) Hard-packed roadways, and
- (e) Sides.

3.1.3 Number of Flux Measurements. Radon flux measurements shall be made within each region on the phosphogypsum stack, except for those areas covered with water. Measurements shall be made at regularly spaced locations across the surface of the region, realizing that surface roughness will prohibit measurements in some areas of a region. The minimum number of flux measurements considered necessary to determine a representative mean radon flux value for each type of region is:

- (a) Water covered area—no measurements required as radon flux is assumed to be zero,
- (b) Water saturated beaches—50 radon flux measurements,
- (c) Loose and dry top surface—100 radon flux measurements,

(d) Hard-packed roadways—50 radon flux measurements, and

(e) Sides—100 radon flux measurements.

A minimum of 300 measurements are required. A stack that has no water cover can be considered to consist of two regions, top and sides, and will require a minimum of only 200 measurements.

3.1.4 Restrictions to Radon Flux Measurements. The following restrictions are placed on making radon flux measurements:

(a) Measurements shall not be initiated within 24 hours of a rainfall.

(b) If a rainfall occurs during the 24 hour measurement period, the measurement is invalid if the seal around the lip of the collector has washed away or if the collector is surrounded by water.

(c) Measurements shall not be performed if the ambient temperature is below 35 °F or if the ground is frozen.

3.1.5 Areas of Stack Regions. The approximate area of each region of the stack shall be determined in units of square meters.

3.1.6 Radon Flux Measurements. Measuring radon flux involves the adsorption of radon on activated charcoal in a large-area collector. The radon collector is placed on the surface of the stack area to be measured and allowed to collect radon for a time period of 24 hours. The radon collected on the charcoal is measured by gamma-ray spectroscopy. The detailed measurement procedure provided in appendix A of EPA 520/5-85-0029(1) shall be used to measure the radon flux on phosphogypsum stacks, except the surface of the phosphogypsum shall not be penetrated by the lip of the radon collector as directed in the procedure, rather the collector shall be carefully positioned on a flat surface with soil or phosphogypsum used to seal the edge.

3.1.7 Calculations. The mean radon flux for each region of the phosphogypsum stack and for the total stack shall be calculated and reported as follows:

(a) The individual radon flux calculations shall be made as provided in appendix A EPA 86 (1).

The mean radon flux for each region of the stack shall be calculated by summing all individual flux measurements for the region and dividing by the total number of flux measurements for the region.

(b) The mean radon flux for the total phosphogypsum stack shall be calculated as follows.

$$J_s = \frac{J_1 A_1 + J_2 A_2 + \dots + J_i A_i}{A_t}$$

Where:

J_s = Mean flux for the total stack (pCi/m² -s)

J_i = Mean flux measured in region i (pCi/m² -s)

A_i = Area of region i (m²)

A_t = Total area of the stack

3.1.8 Reporting. The results of individual flux measurements, the approximate locations on the stack, and the mean radon flux for each region and the mean radon flux for the total stack shall be included in the emission test report. Any condition or unusual event that occurred during the measurements that could significantly affect the results should be reported.

4.0 Quality Assurance Procedures for Measuring Rn-222 Flux

A. SAMPLING PROCEDURES

Records of field activities and laboratory measurements shall be maintained. The following information shall be recorded for each charcoal canister measurement:

- (a) Site
- (b) Name of pile
- (c) Sample location
- (d) Sample ID number
- (e) Date and time on
- (f) Date and time off
- (g) Observations of meteorological conditions and comments

Records shall include all applicable information associated with determining the sample measurement, calculations, observations, and comments.

B. SAMPLE CUSTODY

Custodial control of all charcoal samples exposed in the field shall be maintained in accordance with EPA chain-of-custody field procedures. A control record shall document all custody changes that occur between the field and laboratory personnel.

C. CALIBRATION PROCEDURES AND FREQUENCY

The radioactivity of two standard charcoal sources, each containing a carefully determined quantity of radium-226 uniformly distributed through 180g of activated charcoal, shall be measured. An efficiency factor is computed by dividing the average measured radioactivity of the two standard charcoal sources, minus the background, in cpm by the known radioactivity of the charcoal sources in dpm. The same two standard charcoal sources shall be counted at the beginning and at the end of each day's counting as a check of the radioactivity counting equipment. A background count using unexposed charcoal should also be made at the beginning and at the end of each counting day to check for inadvertent contamination of the detector or other changes affecting the background. The unexposed charcoal comprising the blank is changed with each new batch of charcoal used.

D. INTERNAL QUALITY CONTROL CHECKS AND FREQUENCY

The charcoal from every tenth exposed canister shall be recounted. Five percent of the samples analyzed shall be either blanks (charcoal having no radioactivity added) or samples spiked with known quantities of radium-226.

E. DATA PRECISION, ACCURACY, AND COMPLETENESS

The precision, accuracy, and completeness of measurements and analyses shall be within the following limits for samples measuring greater than 1.0 pCi/m² -s.

- (a) Precision: 10%
- (b) Accuracy: ±10%
- (c) Completeness: at least 85% of the measurements must yield useable results.

5.0 REFERENCES

(1) Hartley, J.N. and Freeman, H.D., "Radon Flux Measurements on Gardinier and Royster phosphogypsum Piles Near Tampa and Mulberry, Florida," U.S. Environmental Protection Agency Report, EPA 520/5-85-029, January 1986.

(2) Environmental Protection Agency, "Indoor Radon and Radon Decay Product Measurement Protocols", EPA 520/1-89-009, U.S. Environmental Protection Agency, Washington, DC. (1989).

[38 FR 8826, Apr. 6, 1973]

EDITORIAL NOTES: 1. For FEDERAL REGISTER citations to appendix B see the List of CFR Sections Affected, which appears in the Finding Aids section of the printed volume and at www.fdsys.gov.

2. At 65 FR 62161, Oct. 17, 2000, appendix B to part 61 was amended by revising Methods 101, 101A, 102, 103, 104, 105, 106, 107, 107A, 108, 108A, 108B, 108C, and 111. However, because the amendment contains no revised text for Method 107A, this part of the revision could not be incorporated.

Appendix C to Part 61—Quality Assurance Procedures

Procedure 1—Determination of Adequate Chromatographic Peak Resolution

In this method of dealing with resolution, the extent to which one chromatographic peak overlaps another is determined.

For convenience, consider the range of the elution curve of each compound as running from -2σ to $+2\sigma$. This range is used in other resolution criteria, and it contains 95.45 percent of the area of a normal curve. If two peaks are separated by a known distance, b , one can determine the fraction of the area of one curve that lies within the range of the other. The extent to which the elution curve of a contaminant compound overlaps the curve of a compound that is under analysis is found by integrating the contaminant curve over the limits $b-2\sigma_s$ to $b+2\sigma_s$, where σ_s is the standard deviation of the sample curve.

This calculation can be simplified in several ways. Overlap can be determined for curves of unit area; then actual areas can be introduced. Desired integration can be resolved into two integrals of the normal distribution function for which there are convenient calculation programs and tables. An example would be Program 15 in Texas Instruments Program Manual ST1, 1975, Texas Instruments, Inc., Dallas, Texas 75222.

$$\frac{1}{\sqrt{2\pi}\sigma_c} \int_{b-2\sigma_s}^{b+2\sigma_s} e^{-\frac{(x-t_c)^2}{2\sigma_c^2}} dx = \frac{1}{\sqrt{2\pi}} \int_{\frac{b-2\sigma_s-t_c}{\sigma_c}}^{\frac{b+2\sigma_s-t_c}{\sigma_c}} e^{-\frac{y^2}{2}} dy = \frac{1}{\sqrt{2\pi}} \int_{\frac{b-2\sigma_s}{\sigma_c}}^{\frac{b+2\sigma_s}{\sigma_c}} e^{-\frac{y^2}{2}} dy$$

The following calculation steps are required:^a

1. $2\sigma_s = t_s/\sqrt{2 \ln 2}$
2. $\sigma_c = t_c/\sqrt{2 \ln 2}$
3. $x_1 = (b-2\sigma_s)/\sigma_c$
4. $x_2 = (b+2\sigma_s)/\sigma_c$

$$5. Q(x_1) = \frac{1}{\sqrt{2\pi}} \int_{x_1}^{\infty} e^{-\frac{y^2}{2}} dy$$

$$6. Q(x_2) = \frac{1}{\sqrt{2\pi}} \int_{x_2}^{\infty} e^{-\frac{y^2}{2}} dy$$

$$7. I_o = Q(x_1) - Q(x_2)$$

$$8. A_o = I_o A_s / A_s$$

$$9. \text{Percentage overlap} = A_o \times 100$$

where:

- A_s = Area of the sample peak of interest determined by electronic integration or by the formula $A_s = t_s^2 h_s$
- A_c = Area of the contaminant peak, determined in the same manner as A_s
- b = Distance on the chromatographic chart that separates the maxima of the two peaks.
- h_s = Peak height of the sample compound of interest, measured from the average value of the baseline to the maximum of the curve.
- t_s = Width of sample peak of interest at 1/2 peak height.
- t_c = Width of the contaminant peak at 1/2 of peak height.
- σ_s = Standard deviation of the sample compound of interest elution curve.
- σ_c = Standard deviation of the contaminant elution curve.
- $Q(x_1)$ = Integral of the normal distribution function from x_1 to infinity.
- $Q(x_2)$ = Integral of the normal distribution function from x_2 to infinity.
- I_o = Overlap integral
- A_o = Area overlap fraction

^aIn most instances, $Q(x_2)$ is very small and may be neglected.

[View or download PDF](#)

In judging the suitability of alternate GC columns or the effects of altering chromatographic conditions, one can employ the area overlap as the resolution parameter with a specific maximum permissible value.

The use of Gaussian functions to describe chromatographic elution curves is widespread. However, some elution curves are highly asymmetric. In cases where the sample peak is followed by a contaminant that has a leading edge that rises sharply but the curve then tails off, it may be possible to define an effective width for t_c as "twice the distance from the leading edge to a perpendicular line through the maxim of the contaminant curve, measured along a perpendicular bisection of that line."

Procedure 2—Procedure for Field Auditing GC Analysis

Responsibilities of audit supervisor and analyst at the source sampling site include the following:

A. The audit supervisor verifies that audit cylinders are stored in a safe location both before and after the audit to prevent vandalism.

B. At the beginning and conclusion of the audit, the analyst records each cylinder number and pressure. An audit cylinder is never analyzed when the pressure drops below 200 psi.

C. During the audit, the analyst performs a minimum of two consecutive analyses of each audit cylinder gas. The audit must be conducted to coincide with the analysis of source test samples, normally immediately after GC calibration and prior to sample analyses.

D. At the end of audit analyses, the audit supervisor requests the calculated concentrations from the analyst and compares the results with the actual audit concentrations. If each measured concentration agrees with the respective actual concentration within ± 10 percent, he directs the analyst to begin analyzing source samples. Audit supervisor judgment and/or supervisory policy determine action when agreement is not within ± 10 percent. When a consistent bias in excess of 10 percent is found, it may be possible to proceed with the sample analysis, with a corrective factor to be applied to the results at a later time. However, every attempt should be made to locate the cause of the discrepancy, as it may be misleading. The audit supervisor records each cylinder number, cylinder pressure (at the end of the audit), and all calculated concentrations. The individual being audited must not under any circumstance be told actual audit concentrations until calculated concentrations have been submitted to the audit supervisor.

FIELD AUDIT REPORT

Part A— To be filled out by organization supplying audit cylinders.

1. Organization supplying audit sample(s) and shipping address

2. Audit supervisor, organization, and phone number

3. Shipping instructions: Name, Address, Attention

4. Guaranteed arrival date for cylinders

5. Planned shipping date for cylinders

6. Details on audit cylinders from last analysis

	Low conc.	High conc.
a. Date of last analysis		
b. Cylinder number		
c. Cylinder pressure, psi		
d. Audit gas(es)/balance gas		
e. Audit gas(es), ppm		
f. Cylinder construction		

Part B—To be filled out by audit supervisor.

1. Process sampled

2. Audit location

4. Audit date

5. Audit results:

	Low conc. cylinder	High conc. cylinder
a. Cylinder number		
b. Cylinder pressure before audit, psi		
c. Cylinder pressure after audit, psi		
d. Measured concentration, ppm Injection #1* Injection #2* Average		
e. Actual audit concentration, ppm (Part A, 6e)		
f. Audit accuracy: ¹		
Low Conc. Cylinder		
High Conc. Cylinder		
Percent ¹ accuracy=		
Measured Conc. - Actual Conc.		
_____ ×100		
Actual Conc.		
g. Problems detected (if any)		

¹ Results of two consecutive injections that meet the sample analysis criteria of the test method.

[47 FR 39178, Sept. 7, 1982]

Appendix D to Part 61—Methods for Estimating Radionuclide Emissions

1. Purpose and Background

Facility owners or operators may estimate radionuclide emissions to the atmosphere for dose calculations instead of measuring emissions. Particulate emissions from mill tailings piles should be estimated using the procedures listed in reference re #2. All other emissions may be estimated by using the "Procedures" listed below, or using the method described in reference #1.

2. Procedure

To estimate emissions to the atmosphere:

(a) Determine the amount (in curies) used at facilities for the period under consideration. Radioactive materials in sealed packages that remain unopened, and have not leaked during the assessment period should not be included in the calculation.

(b) Multiply the amount used by the following factors which depend on the physical state of the radionuclide. They are:

- (i) 1 for gases;
- (ii) 10^{-3} for liquids or particulate solids; and
- (iii) 10^{-6} for solids.

If any nuclide is heated to a temperature of 100 degrees Celsius or more, boils at a temperature of 100 degrees Celsius or less, or is intentionally dispersed into the environment, it must be considered to be a gas.

(c) If a control device is installed between the place of use and the point of release, multiply emissions from (b) by an adjustment factor. These are presented in Table 1.

TABLE 1—ADJUSTMENT TO EMISSION FACTORS FOR EFFLUENT CONTROLS

Controls	Types of radionuclides controlled	Adjustment factor to emissions	Comments and conditions
HEPA filters	Particulates	0.01	Not applicable to gaseous radionuclides; periodic testing is prudent to ensure high removal efficiency.
Fabric filter	Particulates	0.1	Monitoring would be prudent to guard against tears in filter.
Sintered metal	Particulates	1	Insufficient data to make recommendation.
Activated carbon filters	Iodine gas	0.1	Efficiency is time dependent; monitoring is necessary to ensure effectiveness.
Douglas bags: Held one week or longer for decay	Xenon	0.5/wk	Based on xenon half-life of 5.3 days;
Douglas bags: Released within one week	Xenon	1	Provides no reduction of exposure to general public.
Venturi scrubbers	Particulates Gases	0.05 1	Although venturis may remove gases, variability in gaseous removal efficiency dictates adjustment factor for particulates only.
Packed bed scrubbers	Gases	0.1	Not applicable to particulates.
Electrostatic precipitators	Particulates	0.05	Not applicable for gaseous radionuclides
Xenon traps	Xenon	0.1	Efficiency is time dependent; monitoring is necessary to ensure effectiveness.
Fume hoods	All	1	Provides no reduction to general public exposures.
Vent stacks	All	1	Generally provides no reduction of exposure to general public.

References

(1) Environmental Protection Agency, "A Guide for Determining Compliance with the Clean Air Act Standards for Radionuclides Emissions from NRC-Licensed and Non-DOE Federal Facilities", EPA 520/1-89-002, January 1989.

(2) Nuclear Regulatory Commission, "Methods for Estimating Radioactive and Toxic Airborne Source Terms for Uranium Milling Operations", U.S. Nuclear Regulatory Commission Regulatory Guide 3.59, March 1987.

[54 FR 51711, Dec. 15, 1989]

Appendix E to Part 61—Compliance Procedures Methods for Determining Compliance With Subpart I

1. Purpose and Background

This Appendix provides simplified procedures to reduce the burden on Nuclear Regulatory Commission (NRC) licensees, and non-Department of Energy Federal facilities in determining compliance with 40 CFR part 61, subpart I. The procedures consist of a series of increasingly more stringent steps, depending on the facility's potential to exceed the standard.

First, a facility can be found in compliance if the quantity of radioactive material possessed during the year is less than that listed in a table of annual possession quantities. A facility will also be in compliance if the average annual radionuclide emission concentration is less than that listed in a table of air concentration levels. If the facility is not in compliance by these tables, it can establish compliance by estimating a dose using screening procedure developed by the National Council on Radiation Protection and Measurements with a radiological source term derived using EPA approved emission factors. These procedures are described in a "Guide for Determining Compliance with the Clean Air Act Standards for Radionuclide Emissions From NRC-Licensed and Non-DOE Federal Facilities."

A user-friendly computer program called COMPLY has been developed to reduce the burden on the regulated community. The Agency has also prepared a "User's Guide for the COMPLY Code" to assist the regulated community in using the code, and in handling more complex situations such as multiple release points. The basis for these compliance procedures are provided in "Background Information Document: Procedures Approved for Demonstrating Compliance with 40 CFR Part 61, Subpart I". The compliance model is the highest level in the COMPLY computer code and provides for the most realistic assessment of dose by allowing the use of site-specific information.

2. Table of Annual Possession Quantity

(a) Table 1 may be used for determining if facilities are in compliance with the standard. The possession table can only be used if the following conditions are met:

- (i) No person lives within 10 meters of any release point; and
- (ii) No milk, meat, or vegetables are produced within 100 meters of any release point.

(b) Procedures described in Reference (1) shall be used to determine compliance or exemption from reporting by use of Table 2.

TABLE 1—ANNUAL POSSESSION QUANTITIES FOR ENVIRONMENTAL COMPLIANCE

[Annual Possession Quantities (Ci/yr)]

Radionuclide	Gaseous form*	Liquid/powder forms	Solid form*
Ac-225	9.6E-05	9.6E-02	9.6E+01
Ac-227	1.6E-07	1.6E-04	1.6E-01
Ac-228	3.4E-03	3.4E+00	3.4E+03
Ag-106	1.6E+00	1.6E+03	1.6E+06
Ag-106m	2.6E-03	2.6E+00	2.6E+03
Ag-108m	6.5E-06	6.5E-03	6.5E+00
Ag-110m	9.4E-05	9.4E-02	9.4E+01
Ag-111	6.7E-02	6.7E+01	6.7E+04
Al-26	4.0E-06	4.0E-03	4.0E+00
Am-241	2.3E-06	2.3E-03	2.3E+00
Am-242	1.8E-02	1.8E+01	1.8E+04
Am-242m	2.5E-06	2.5E-03	2.5E+00
Am-243	2.3E-06	2.3E-03	2.3E+00
Am-244	4.6E-02	4.6E+01	4.6E+04
Am-245	7.0E+00	7.0E+03	7.0E+06

Am-246	9.8E-01	9.8E+02	9.8E+05
Ar-37	1.4E+06		
Ar-41	1.4E+00		
As-72	2.9E-02	2.9E+01	2.9E+04
As-73	6.0E-02	6.0E+01	6.0E+04
As-74	4.3E-03	4.3E+00	4.3E+03
As-76	8.8E-02	8.8E+01	8.8E+04
As-77	7.9E-01	7.9E+02	7.9E+05
At-211	1.0E-02	1.0E+01	1.0E+04
Au-193	4.2E-01	4.2E+02	4.2E+05
Au-194	3.5E-02	3.5E+01	3.5E+04
Au-195	3.3E-03	3.3E+00	3.3E+03
Au-198	4.6E-02	4.6E+01	4.6E+04
Au-199	1.5E-01	1.5E+02	1.5E+05
Ba-131	1.0E-02	1.0E+01	1.0E+04
Ba-133	4.9E-05	4.9E-02	4.9E+01
Ba-133m	9.3E-02	9.3E+01	9.3E+04
Ba-135m	5.8E-01	5.8E+02	5.8E+05
Ba-139	4.7E+00	4.7E+03	4.7E+06
Ba-140	2.1E-03	2.1E+00	2.1E+03
Ba-141	1.3E+00	1.3E+03	1.3E+06
Ba-142	1.1E+00	1.1E+03	1.1E+06
Be-7	2.3E-02	2.3E+01	2.3E+04
Be-10	3.0E-03	3.0E+00	3.0E+03
Bi-206	3.1E-03	3.1E+00	3.1E+03
Bi-207	8.4E-06	8.4E-03	8.4E+00
Bi-210	4.2E-03	4.2E+00	4.2E+03
Bi-212	4.7E-02	4.7E+01	4.7E+04
Bi-213	6.0E-02	6.0E+01	6.0E+04
Bi-214	1.4E-01	1.4E+02	1.4E+05
Bk-249	7.0E-04	7.0E-01	7.0E+02
Bk-250	1.0E-01	1.0E+02	1.0E+05
Br-77	7.5E-02	7.5E+01	7.5E+04
Br-80	1.2E+01	1.2E+04	1.2E+07
Br-80m	1.5E+00	1.5E+03	1.5E+06
Br-82	1.6E-02	1.6E+01	1.6E+04
Br-83	9.9E+00	9.9E+03	9.9E+06
Br-84	5.6E-01	5.6E+02	5.6E+05
C-11	1.3E+00	1.3E+03	1.3E+06
C-14	2.9E-01	2.9E+02	2.9E+05
Ca-41	2.7E-02	2.7E+01	2.7E+04
Ca-45	5.8E-02	5.8E+01	5.8E+04
Ca-47	1.1E-02	1.1E+01	1.1E+04
Cd-109	5.0E-03	5.0E+00	5.0E+03
Cd-113	3.3E-04	3.3E-01	3.3E+02
Cd-113m	4.4E-04	4.4E-01	4.4E+02
Cd-115	5.4E-02	5.4E+01	5.4E+04
Cd-115m	1.0E-02	1.0E+01	1.0E+04

Cd-117	5.6E-02	5.6E+01	5.6E+04
Cd-117m	1.3E-01	1.3E+02	1.3E+05
Ce-139	2.6E-03	2.6E+00	2.6E+03
Ce-141	1.8E-02	1.8E+01	1.8E+04
Ce-143	1.0E-01	1.0E+02	1.0E+05
Ce-144	1.7E-03	1.7E+00	1.7E+03
Cf-248	2.0E-05	2.0E-02	2.0E+01
Cf-249	1.7E-06	1.7E-03	1.7E+00
Cf-250	4.0E-06	4.0E-03	4.0E+00
Cf-251	1.7E-06	1.7E-03	1.7E+00
Cf-252	6.4E-06	6.4E-03	6.4E+00
Cf-253	3.3E-04	3.3E-01	3.3E+02
Cf-254	3.6E-06	3.6E-03	3.6E+00
Cl-36	1.9E-04	1.9E-01	1.9E+02
Cl-38	6.5E-01	6.5E+02	6.5E+05
Cm-242	6.0E-05	6.0E-02	6.0E+01
Cm-243	3.3E-06	3.3E-03	3.3E+00
Cm-244	4.2E-06	4.2E-03	4.2E+00
Cm-245	2.3E-06	2.3E-03	2.3E+00
Cm-246	2.3E-06	2.3E-03	2.3E+00
Cm-247	2.3E-06	2.3E-03	2.3E+00
Cm-248	6.4E-07	6.4E-04	6.4E-01
Cm-249	4.6E+00	4.6E+03	4.6E+06
Cm-250	1.1E-07	1.1E-04	1.1E-01
Co-56	2.4E-04	2.4E-01	2.4E+02
Co-57	1.6E-03	1.6E+00	1.6E+03
Co-58	9.0E-04	9.0E-01	9.0E+02
Co-58m	1.7E-01	1.7E+02	1.7E+05
Co-60	1.6E-05	1.6E-02	1.6E+01
Co-60m	4.0E+00	4.0E+03	4.0E+06
Co-61	3.8E+00	3.8E+03	3.8E+06
Cr-49	9.0E-01	9.0E+02	9.0E+05
Cr-51	6.3E-02	6.3E+01	6.3E+04
Cs-129	1.5E-01	1.5E+02	1.5E+05
Cs-131	2.8E-01	2.8E+02	2.8E+05
Cs-132	1.3E-02	1.3E+01	1.3E+04
Cs-134	5.2E-05	5.2E-02	5.2E+01
Cs-134m	3.2E-01	3.2E+02	3.2E+05
Cs-135	2.4E-02	2.4E+01	2.4E+04
Cs-136	2.1E-03	2.1E+00	2.1E+03
Cs-137	2.3E-05	2.3E-02	2.3E+01
Cs-138	4.4E-01	4.4E+02	4.4E+05
Cu-61	4.0E-01	4.0E+02	4.0E+05
Cu-64	5.2E-01	5.2E+02	5.2E+05
Cu-67	1.5E-01	1.5E+02	1.5E+05
Dy-157	4.4E-01	4.4E+02	4.4E+05
Dy-165	5.6E+00	5.6E+03	5.6E+06
Dy-166	8.1E-02	8.1E+01	8.1E+04

Er-169	4.0E-01	4.0E+02	4.0E+05
Er-171	3.6E-01	3.6E+02	3.6E+05
Es-253	2.6E-04	2.6E-01	2.6E+02
Es-254	2.3E-05	2.3E-02	2.3E+01
Es-254m	1.8E-03	1.8E+00	1.8E+03
Eu-152	1.6E-05	1.6E-02	1.6E+01
Eu-152m	3.5E-01	3.5E+02	3.5E+05
Eu-154	2.0E-05	2.0E-02	2.0E+01
Eu-155	5.2E-04	5.2E-01	5.2E+02
Eu-156	3.2E-03	3.2E+00	3.2E+03
F-18	5.6E-01	5.6E+02	5.6E+05
Fe-52	4.9E-02	4.9E+01	4.9E+04
Fe-55	1.4E-01	1.4E+02	1.4E+05
Fe-59	1.3E-03	1.3E+00	1.3E+03
Fm-254	1.8E-02	1.8E+01	1.8E+04
Fm-255	4.0E-03	4.0E+00	4.0E+03
Fr-223	1.4E-01	1.4E+02	1.4E+05
Ga-66	5.6E-02	5.6E+01	5.6E+04
Ga-67	1.1E-01	1.1E+02	1.1E+05
Ga-68	7.6E-01	7.6E+02	7.6E+05
Ga-72	3.6E-02	3.6E+01	3.6E+04
Gd-152	4.4E-06	4.4E-03	4.4E+00
Gd-153	2.0E-03	2.0E+00	2.0E+03
Gd-159	6.8E-01	6.8E+02	6.8E+05
Ge-68	2.3E-04	2.3E-01	2.3E+02
Ge-71	2.6E+00	2.6E+03	2.6E+06
Ge-77	1.0E-01	1.0E+02	1.0E+05
H-3	1.5E+01	1.5E+04	1.5E+07
Hf-181	2.5E-03	2.5E+00	2.5E+03
Hg-193m	9.5E-02	9.5E+01	9.5E+04
Hg-197	2.4E-01	2.4E+02	2.4E+05
Hg-197m	2.5E-01	2.5E+02	2.5E+05
Hg-203	5.2E-03	5.2E+00	5.2E+03
Ho-166	2.8E-01	2.8E+02	2.8E+05
Ho-166m	6.0E-06	6.0E-03	6.0E+00
I-123	4.9E-01	4.9E+02	4.9E+05
I-124	9.3E-03	9.3E+00	9.3E+03
I-125	6.2E-03	6.2E+00	6.2E+03
I-126	3.7E-03	3.7E+00	3.7E+03
I-128	9.3E+00	9.3E+03	9.3E+06
I-129	2.6E-04	2.6E-01	2.6E+02
I-130	4.6E-02	4.6E+01	4.6E+04
I-131	6.7E-03	6.7E+00	6.7E+03
I-132	2.0E-01	2.0E+02	2.0E+05
I-133	6.7E-02	6.7E+01	6.7E+04
I-134	3.2E-01	3.2E+02	3.2E+05
I-135	1.2E-01	1.2E+02	1.2E+05
In-111	4.9E-02	4.9E+01	4.9E+04

In-113m	2.1E+00	2.1E+03	2.1E+06
In-114m	4.9E-03	4.9E+00	4.9E+03
In-115	2.7E-04	2.7E-01	2.7E+02
In-115m	1.4E+00	1.4E+03	1.4E+06
In-116m	3.5E-01	3.5E+02	3.5E+05
In-117	1.3E+00	1.3E+03	1.3E+06
In-117m	7.6E-02	7.6E+01	7.6E+04
Ir-190	3.5E-03	3.5E+00	3.5E+03
Ir-192	9.7E-04	9.7E-01	9.7E+02
Ir-194	2.5E-01	2.5E+02	2.5E+05
Ir-194m	1.5E-04	1.5E-01	1.5E+02
K-40	6.8E-05	6.8E-02	6.8E+01
K-42	2.9E-01	2.9E+02	2.9E+05
K-43	6.0E-02	6.0E+01	6.0E+04
K-44	4.9E-01	4.9E+02	4.9E+05
Kr-79	7.0E+00		
Kr-81	1.8E+02		
Kr-83m	2.0E+04		
Kr-85	8.4E+02		
Kr-85m	1.1E+01		
Kr-87	2.0E+00		
Kr-88	4.2E-01		
La-140	1.6E-02	1.6E+01	1.6E+04
La-141	1.1E+00	1.1E+03	1.1E+06
La-142	2.3E-01	2.3E+02	2.3E+05
Lu-177	1.4E-01	1.4E+02	1.4E+05
Lu-177m	3.5E-04	3.5E-01	3.5E+02
Mg-28	2.1E-02	2.1E+01	2.1E+04
Mn-52	3.5E-03	3.5E+00	3.5E+03
Mn-52m	5.2E-01	5.2E+02	5.2E+05
Mn-53	5.7E-02	5.7E+01	5.7E+04
Mn-54	2.5E-04	2.5E-01	2.5E+02
Mn-56	2.5E-01	2.5E+02	2.5E+05
Mo-93	1.5E-03	1.5E+00	1.5E+03
Mo-99**	5.7E-02	5.7E+01	5.7E+04
Mo-101	8.4E-01	8.4E+02	8.4E+05
Na-22	3.2E-05	3.2E-02	3.2E+01
Na-24	2.6E-02	2.6E+01	2.6E+04
Nb-90	2.5E-02	2.5E+01	2.5E+04
Nb-93m	1.2E-02	1.2E+01	1.2E+04
Nb-94	6.0E-06	6.0E-03	6.0E+00
Nb-95	2.3E-03	2.3E+00	2.3E+03
Nb-95m	2.0E-02	2.0E+01	2.0E+04
Nb-96	2.5E-02	2.5E+01	2.5E+04
Nb-97	1.0E+00	1.0E+03	1.0E+06
Nd-147	3.0E-02	3.0E+01	3.0E+04
Nd-149	1.1E+00	1.1E+03	1.1E+06
Ni-56	2.0E-03	2.0E+00	2.0E+03

Ni-57	2.1E-02	2.1E+01	2.1E+04
Ni-59	2.2E-02	2.2E+01	2.2E+04
Ni-63	1.4E-01	1.4E+02	1.4E+05
Ni-65	7.0E-01	7.0E+02	7.0E+05
Np-235	3.0E-02	3.0E+01	3.0E+04
Np-237	1.8E-06	1.8E-03	1.8E+00
Np-238	1.9E-02	1.9E+01	1.9E+04
Np-239	1.0E-01	1.0E+02	1.0E+05
Np-240	6.5E-01	6.5E+02	6.5E+05
Np-240m	4.7E+00	4.7E+03	4.7E+06
Os-185	9.2E-04	9.2E-01	9.2E+02
Os-191m	9.0E-01	9.0E+02	9.0E+05
Os-191	3.8E-02	3.8E+01	3.8E+04
Os-193	2.9E-01	2.9E+02	2.9E+05
P-32	1.7E-02	1.7E+01	1.7E+04
P-33	1.2E-01	1.2E+02	1.2E+05
Pa-230	6.3E-04	6.3E-01	6.3E+02
Pa-231	8.3E-07	8.3E-04	8.3E-01
Pa-233	9.3E-03	9.3E+00	9.3E+03
Pa-234	9.3E-02	9.3E+01	9.3E+04
Pb-203	8.3E-02	8.3E+01	8.3E+04
Pb-205	1.2E-02	1.2E+01	1.2E+04
Pb-209	1.1E+01	1.1E+04	1.1E+07
Pb-210	5.5E-05	5.5E-02	5.5E+01
Pb-211	1.2E-01	1.2E+02	1.2E+05
Pb-212	6.0E-03	6.0E+00	6.0E+03
Pb-214	1.2E-01	1.2E+02	1.2E+05
Pd-103	2.1E-01	2.1E+02	2.1E+05
Pd-107	8.2E-02	8.2E+01	8.2E+04
Pd-109	9.4E-01	9.4E+02	9.4E+05
Pm-143	7.6E-04	7.6E-01	7.6E+02
Pm-144	1.1E-04	1.1E-01	1.1E+02
Pm-145	5.2E-04	5.2E-01	5.2E+02
Pm-146	4.4E-05	4.4E-02	4.4E+01
Pm-147	2.6E-02	2.6E+01	2.6E+04
Pm-148	1.7E-02	1.7E+01	1.7E+04
Pm-148m	7.6E-04	7.6E-01	7.6E+02
Pm-149	2.8E-01	2.8E+02	2.8E+05
Pm-151	1.2E-01	1.2E+02	1.2E+05
Po-210	9.3E-05	9.3E-02	9.3E+01
Pr-142	2.8E-01	2.8E+02	2.8E+05
Pr-143	1.0E-01	1.0E+02	1.0E+05
Pr-144	1.5E+01	1.5E+04	1.5E+07
Pt-191	6.4E-02	6.4E+01	6.4E+04
Pt-193	2.1E-02	2.1E+01	2.1E+04
Pt-193m	4.8E-01	4.8E+02	4.8E+05
Pt-195m	1.4E-01	1.4E+02	1.4E+05
Pt-197	1.1E+00	1.1E+03	1.1E+06

Pt-197m	3.6E+00	3.6E+03	3.6E+06
Pu-236	7.0E-06	7.0E-03	7.0E+00
Pu-237	2.3E-02	2.3E+01	2.3E+04
Pu-238	2.7E-06	2.7E-03	2.7E+00
Pu-239	2.5E-06	2.5E-03	2.5E+00
Pu-240	2.5E-06	2.5E-03	2.5E+00
Pu-241	1.3E-04	1.3E-01	1.3E+02
Pu-242	2.5E-06	2.5E-03	2.5E+00
Pu-243	3.8E+00	3.8E+03	3.8E+06
Pu-244	2.4E-06	2.4E-03	2.4E+00
Pu-245	2.1E-01	2.1E+02	2.1E+05
Pu-246	4.8E-03	4.8E+00	4.8E+03
Ra-223	1.3E-04	1.3E-01	1.3E+02
Ra-224	3.2E-04	3.2E-01	3.2E+02
Ra-225	1.3E-04	1.3E-01	1.3E+02
Ra-226	5.5E-06	5.5E-03	5.5E+00
Ra-228	1.3E-05	1.3E-02	1.3E+01
Rb-81	4.2E-01	4.2E+02	4.2E+05
Rb-83	1.4E-03	1.4E+00	1.4E+03
Rb-84	2.0E-03	2.0E+00	2.0E+03
Rb-86	1.7E-02	1.7E+01	1.7E+04
Rb-87	1.0E-02	1.0E+01	1.0E+04
Rb-88	1.7E+00	1.7E+03	1.7E+06
Rb-89	6.4E-01	6.4E+02	6.4E+05
Re-184	1.8E-03	1.8E+00	1.8E+03
Re-184m	3.6E-04	3.6E-01	3.6E+02
Re-186	1.9E-01	1.9E+02	1.9E+05
Re-187	9.3E+00	9.3E+03	9.3E+06
Re-188	3.7E-01	3.7E+02	3.7E+05
Rh-103m	1.7E+02	1.7E+05	1.7E+08
Rh-105	3.4E-01	3.4E+02	3.4E+05
Ru-97	8.3E-02	8.3E+01	8.3E+04
Ru-103	3.1E-03	3.1E+00	3.1E+03
Ru-105	2.9E-01	2.9E+02	2.9E+05
Ru-106	5.9E-04	5.9E-01	5.9E+02
S-35	7.5E-02	7.5E+01	7.5E+04
Sb-117	2.0E+00	2.0E+03	2.0E+06
Sb-122	3.9E-02	3.9E+01	3.9E+04
Sb-124	6.0E-04	6.0E-01	6.0E+02
Sb-125	1.4E-04	1.4E-01	1.4E+02
Sb-126	1.8E-03	1.8E+00	1.8E+03
Sb-126m	7.6E-01	7.6E+02	7.6E+05
Sb-127	2.0E-02	2.0E+01	2.0E+04
Sb-129	1.8E-01	1.8E+02	1.8E+05
Sc-44	1.4E-01	1.4E+02	1.4E+05
Sc-46	4.0E-04	4.0E-01	4.0E+02
Sc-47	1.1E-01	1.1E+02	1.1E+05
Sc-48	1.1E-02	1.1E+01	1.1E+04

Sc-49	1.0E+01	1.0E+04	1.0E+07
Se-73	1.6E-01	1.6E+02	1.6E+05
Se-75	1.1E-03	1.1E+00	1.1E+03
Se-79	6.9E-03	6.9E+00	6.9E+03
Si-31	4.7E+00	4.7E+03	4.7E+06
Si-32	7.2E-04	7.2E-01	7.2E+02
Sm-147	1.4E-05	1.4E-02	1.4E+01
Sm-151	3.5E-02	3.5E+01	3.5E+04
Sm-153	2.4E-01	2.4E+02	2.4E+05
Sn-113	1.9E-03	1.9E+00	1.9E+03
Sn-117m	2.3E-02	2.3E+01	2.3E+04
Sn-119m	2.8E-02	2.8E+01	2.8E+04
Sn-123	1.8E-02	1.8E+01	1.8E+04
Sn-125	7.2E-03	7.2E+00	7.2E+03
Sn-126	4.7E-06	4.7E-03	4.7E+00
Sr-82	1.9E-03	1.9E+00	1.9E+03
Sr-85	1.9E-03	1.9E+00	1.9E+03
Sr-85m	1.5E+00	1.5E+03	1.5E+06
Sr-87m	1.2E+00	1.2E+03	1.2E+06
Sr-89	2.1E-02	2.1E+01	2.1E+04
Sr-90	5.2E-04	5.2E-01	5.2E+02
Sr-91	1.2E-01	1.2E+02	1.2E+05
Sr-92	2.5E-01	2.5E+02	2.5E+05
Ta-182	4.4E-04	4.4E-01	4.4E+02
Tb-157	2.2E-03	2.2E+00	2.2E+03
Tb-160	8.4E-04	8.4E-01	8.4E+02
Tc-95	9.0E-02	9.0E+01	9.0E+04
Tc-95m	1.4E-03	1.4E+00	1.4E+03
Tc-96	5.6E-03	5.6E+00	5.6E+03
Tc-96m	7.0E-01	7.0E+02	7.0E+05
Tc-97	1.5E-03	1.5E+00	1.5E+03
Tc-97m	7.2E-02	7.2E+01	7.2E+04
Tc-98	6.4E-06	6.4E-03	6.4E+00
Tc-99	9.0E-03	9.0E+00	9.0E+03
Tc-99m	1.4E+00	1.4E+03	1.4E+06
Tc-101	3.8E+00	3.8E+03	3.8E+06
Te-121	6.0E-03	6.0E+00	6.0E+03
Te-121m	5.3E-04	5.3E-01	5.3E+02
Te-123	1.2E-03	1.2E+00	1.2E+03
Te-123m	2.7E-03	2.7E+00	2.7E+03
Te-125m	1.5E-02	1.5E+01	1.5E+04
Te-127	2.9E+00	2.9E+03	2.9E+06
Te-127m	7.3E-03	7.3E+00	7.3E+03
Te-129	6.5E+00	6.5E+03	6.5E+06
Te-129m	6.1E-03	6.1E+00	6.1E+03
Te-131	9.4E-01	9.4E+02	9.4E+05
Te-131m	1.8E-02	1.8E+01	1.8E+04
Te-132	6.2E-03	6.2E+00	6.2E+03

Te-133	1.2E+00	1.2E+03	1.2E+06
Te-133m	2.9E-01	2.9E+02	2.9E+05
Te-134	4.4E-01	4.4E+02	4.4E+05
Th-226	3.0E-02	3.0E+01	3.0E+04
Th-227	6.4E-05	6.4E-02	6.4E+01
Th-228	2.9E-06	2.9E-03	2.9E+00
Th-229	4.9E-07	4.9E-04	4.9E-01
Th-230	3.2E-06	3.2E-03	3.2E+00
Th-231	8.4E-01	8.4E+02	8.4E+05
Th-232	6.0E-07	6.0E-04	6.0E-01
Th-234	2.0E-02	2.0E+01	2.0E+04
Ti-44	5.2E-06	5.2E-03	5.2E+00
Ti-45	4.0E-01	4.0E+02	4.0E+05
Tl-200	4.4E-02	4.4E+01	4.4E+04
Tl-201	1.8E-01	1.8E+02	1.8E+05
Tl-202	1.0E-02	1.0E+01	1.0E+04
Tl-204	2.5E-02	2.5E+01	2.5E+04
Tm-170	2.4E-02	2.4E+01	2.4E+04
Tm-171	5.9E-02	5.9E+01	5.9E+04
U-230	5.0E-05	5.0E-02	5.0E+01
U-231	1.4E-01	1.4E+02	1.4E+05
U-232	1.3E-06	1.3E-03	1.3E+00
U-233	7.6E-06	7.6E-03	7.6E+00
U-234	7.6E-06	7.6E-03	7.6E+00
U-235	7.0E-06	7.0E-03	7.0E+00
U-236	8.4E-06	8.4E-03	8.4E+00
U-237	4.7E-02	4.7E+01	4.7E+04
U-238	8.6E-06	8.6E-03	8.6E+00
U-239	8.3E+00	8.3E+03	8.3E+06
U-240	1.8E-01	1.8E+02	1.8E+05
V-48	1.4E-03	1.4E+00	1.4E+03
V-49	1.3E+00	1.3E+03	1.3E+06
W-181	1.1E-02	1.1E+01	1.1E+04
W-185	1.6E-01	1.6E+02	1.6E+05
W-187	1.1E-01	1.1E+02	1.1E+05
W-188	1.0E-02	1.0E+01	1.0E+04
Xe-122	7.6E-02	7.6E+01	7.6E+04
Xe-123	1.6E+00	1.6E+03	1.6E+06
Xe-125	6.0E-01		
Xe-127	7.0E+00		
Xe-129m	7.6E+01		
Xe-131m	2.2E+02		
Xe-133	5.2E+01		
Xe-133m	6.0E+01		
Xe-135	7.6E+00		
Xe-135m	4.2E+00		
Xe-138	9.9E-01		
Y-86	2.8E-02	2.8E+01	2.8E+04

Y-87	2.3E-02	2.3E+01	2.3E+04
Y-88	2.5E-04	2.5E-01	2.5E+02
Y-90	1.1E-01	1.1E+02	1.1E+05
Y-90m	4.3E-01	4.3E+02	4.3E+05
Y-91	1.8E-02	1.8E+01	1.8E+04
Y-91m	1.6E+00	1.6E+03	1.6E+06
Y-92	7.0E-01	7.0E+02	7.0E+05
Y-93	3.8E-01	3.8E+02	3.8E+05
Yb-169	5.5E-03	5.5E+00	5.5E+03
Yb-175	2.1E-01	2.1E+02	2.1E+05
Zn-62	8.6E-02	8.6E+01	8.6E+04
Zn-65	4.4E-04	4.4E-01	4.4E+02
Zn-69	2.7E+01	2.7E+04	2.7E+07
Zn-69m	2.0E-01	2.0E+02	2.0E+05
Zr-86	2.4E-02	2.4E+01	2.4E+04
Zr-88	2.7E-04	2.7E-01	2.7E+02
Zr-89	1.6E-02	1.6E+01	1.6E+04
Zr-93	2.8E-03	2.8E+00	2.8E+03
Zr-95	6.4E-04	6.4E-01	6.4E+02
Zr-97	4.6E-02	4.6E+01	4.6E+04

* Radionuclides boiling at 100 °C or less, or exposed to a temperature of 100 °C, must be considered a gas. Capsules containing radionuclides in liquid or powder form can be considered to be solids.

** Mo-99 contained in a generator to produce Technetium-99 can be assumed to be a solid.

3. Table of Concentration Levels

(a) Table 2 may be used for determining if facilities are in compliance with the standard.

1. The concentration table as applied to emission estimates can only be used if all releases are from point sources and concentrations have been measured at the stack or vent using EPA-approved methods, and the distance between each stack or vent and the nearest resident is greater than 3 times the diameter of the stack or vent. Procedures provided in Ref. (1) shall be used to determine compliance or exemption from reporting by use of Table 2.

2. The concentration table may be used to determine compliance with the standard based on environmental measurements provided these measurements are made in conformance with the requirements of § 61.107(b)(5).

4. NCRP Screening Model

The procedures described in Reference (4) may be used to determine doses to members of the general public from emissions of radionuclides to the atmosphere. Both the total dose from all radionuclides emitted, and the dose caused by radioactive iodine must be considered in accordance with the procedures in Ref. (1).

5. The COMPLY Computer Code

The COMPLY computer code may be used to determine compliance with subpart I. The compliance model in the COMPLY computer code may be used to determine the dose to members of the general public from emissions of radionuclides to the atmosphere. The EPA may add radionuclides to all or any part of COMPLY to cover radionuclides that may be used by the regulated community.

TABLE 2—CONCENTRATION LEVELS FOR ENVIRONMENTAL COMPLIANCE

Radionuclide	Concentration (Ci/m ³)	Radionuclide	Concentration (Ci/m ³)
Ac-225	9.1E-14	Bi-207	1.0E-14
Ac-227	1.6E-16	Bi-210	2.9E-13
Ac-228	3.7E-12	Bi-212	5.6E-11
Ag-106	1.9E-09	Bi-213	7.1E-11
Ag-106m	1.2E-12	Bi-214	1.4E-10
Ag-108m	7.1E-15	Bk-249	5.6E-13
Ag-110m	9.1E-14	Bk-250	9.1E-11
Ag-111	2.5E-12	Br-77	4.2E-11
Al-26	4.8E-15	Br-80	1.4E-08
Am-241	1.9E-15	Br-80m	1.8E-09
Am-242	1.5E-11	Br-82	1.2E-11
Am-242m	2.0E-15	Br-83	1.2E-08
Am-243	1.8E-15	Br-84	6.7E-10
Am-244	4.0E-11	C-11	1.5E-09
Am-245	8.3E-09	C-14	1.0E-11
Am-246	1.2E-09	Ca-41	4.2E-13
Ar-37	1.6E-03	Ca-45	1.3E-12
Ar-41	1.7E-09	Ca-47	2.4E-12
As-72	2.4E-11	Cd-109	5.9E-13
As-73	1.1E-11	Cd-113	9.1E-15
As-74	2.2E-12	Cd-113m	1.7E-14
As-76	5.0E-11	Cd-115	1.6E-11
As-77	1.6E-10	Cd-115m	8.3E-13
At-211	1.1E-11	Cd-117	6.7E-11
Au-193	3.8E-10	Cd-117m	1.6E-10
Au-194	3.2E-11	Ce-139	2.6E-12
Au-195	3.1E-12	Ce-141	6.3E-12
Au-198	2.1E-11	Ce-143	3.0E-11
Au-199	4.8E-11	Ce-144	6.2E-13
Ba-131	7.1E-12	Cf-248	1.8E-14
Ba-133	5.9E-14	Cf-249	1.4E-15
Ba-133m	5.9E-11	Cf-250	3.2E-15
Ba-135m	1.8E-10	Cf-251	1.4E-15
Ba-139	5.6E-09	Cf-252	5.6E-15
Ba-140	1.3E-12	Cf-253	3.1E-13
Ba-141	1.4E-09	Cf-254	3.0E-15
Ba-142	1.3E-09	Cl-36	2.7E-15
Be-7	2.3E-11	Cl-38	7.7E-10
Be-10	1.6E-12	Cm-242	5.3E-14
Bi-206	2.3E-12	Cm-243	2.6E-15
Cm-244	3.3E-15	Eu-156	1.9E-12
Cm-245	1.8E-15	F-18	6.7E-10
Cm-246	1.9E-15	Fe-52	5.6E-11
Cm-247	1.9E-15	Fe-55	9.1E-12
Cm-248	5.0E-16	Fe-59	6.7E-13

Cm-249	3.7E-09	Fm-254	2.0E-11
Cm-250	9.1E-17	Fm-255	4.3E-12
Co-56	1.8E-13	Fr-223	3.3E-11
Co-57	1.3E-12	Ga-66	6.2E-11
Co-58	6.7E-13	Ga-67	7.1E-11
Co-58m	1.2E-10	Ga-68	9.1E-10
Co-60	1.7E-14	Ga-72	3.8E-11
Co-60m	4.3E-09	Gd-152	5.0E-15
Co-61	4.5E-09	Gd-153	2.1E-12
Cr-49	1.1E-09	Gd-159	2.9E-10
Cr-51	3.1E-11	Ge-68	2.0E-13
Cs-129	1.4E-10	Ge-71	2.4E-10
Cs-131	3.3E-11	Ge-77	1.0E-10
Cs-132	4.8E-12	H-3	1.5E-09
Cs-134	2.7E-14	Hf-181	1.9E-12
Cs-134m	1.7E-10	Hg-193m	1.0E-10
Cs-135	4.0E-13	Hg-197	8.3E-11
Cs-136	5.3E-13	Hg-197m	1.1E-10
Cs-137	1.9E-14	Hg-203	1.0E-12
Cs-138	5.3E-10	Ho-166	7.1E-11
Cu-61	4.8E-10	Ho-166m	7.1E-15
Cu-64	5.3E-10	I-123	4.3E-10
Cu-67	5.0E-11	I-124	6.2E-13
Dy-157	5.0E-10	I-125	1.2E-13
Dy-165	6.7E-09	I-126	1.1E-13
Dy-166	1.1E-11	I-128	1.1E-08
Er-169	2.9E-11	I-129	9.1E-15
Er-171	4.0E-10	I-130	4.5E-11
Es-253	2.4E-13	I-131	2.1E-13
Es-254	2.0E-14	I-132	2.3E-10
Es-254m	1.8E-12	I-133	2.0E-11
Eu-152	2.0E-14	I-134	3.8E-10
Eu-152m	3.6E-10	I-135	1.2E-10
Eu-154	2.3E-14	In-111	3.6E-11
Eu-155	5.9E-13	In-113m	2.5E-09
In-114m	9.1E-13	Nb-95	2.2E-12
In-115	7.1E-14	Nb-95m	1.4E-11
In-115m	1.6E-09	Nb-96	2.4E-11
In-116m	4.2E-10	Nb-97	1.2E-09
In-117	1.6E-09	Nd-147	7.7E-12
In-117m	9.1E-11	Nd-149	7.1E-10
Ir-190	2.6E-12	Ni-56	1.7E-12
Ir-192	9.1E-13	Ni-57	1.8E-11
Ir-194	1.1E-10	Ni-59	1.5E-11
Ir-194m	1.7E-13	Ni-63	1.4E-11
K-40	2.7E-14	Ni-65	8.3E-10
K-42	2.6E-10	Np-235	2.5E-11
K-43	6.2E-11	Np-237	1.2E-15

K-44	5.9E-10	Np-238	1.4E-11
Kr-79	8.3E-09	Np-239	3.8E-11
Kr-81	2.1E-07	Np-240	7.7E-10
Kr-83m	2.3E-05	Np-240m	5.6E-09
Kr-85	1.0E-06	Os-185	1.0E-12
Kr-85m	1.3E-08	Os-191m	2.9E-10
Kr-87	2.4E-09	Os-191	1.1E-11
Kr-88	5.0E-10	Os-193	9.1E-11
La-140	1.2E-11	P-32	3.3E-13
La-141	7.7E-10	P-33	2.4E-12
La-142	2.7E-10	Pa-230	3.2E-13
Lu-177	2.4E-11	Pa-231	5.9E-16
Lu-177m	3.6E-13	Pa-233	4.8E-12
Mg-28	1.5E-11	Pa-234	1.1E-10
Mn-52	2.8E-12	Pb-203	6.2E-11
Mn-52m	6.2E-10	Pb-205	5.6E-12
Mn-53	1.5E-11	Pb-209	1.3E-08
Mn-54	2.8E-13	Pb-210	2.8E-15
Mn-56	2.9E-10	Pb-211	1.4E-10
Mo-93	1.1E-12	Pb-212	6.3E-12
Mo-99	1.4E-11	Pb-214	1.2E-10
Mo-101	1.0E-09	Pd-103	3.8E-11
Na-22	2.6E-14	Pd-107	3.1E-11
Na-24	2.6E-11	Pd-109	4.8E-10
Nb-90	2.6E-11	Pm-143	9.1E-13
Nb-93m	1.0E-11	Pm-144	1.3E-13
Nb-94	7.1E-15	Pm-145	6.2E-13
Pm-146	5.3E-14	Re-184m	3.7E-13
Pm-147	1.1E-11	Re-186	1.8E-11
Pm-148	5.0E-12	Re-187	2.6E-10
Pm-148m	6.7E-13	Re-188	1.7E-10
Pm-149	4.2E-11	Rh-103m	2.1E-07
Pm-151	7.1E-11	Rh-105	1.3E-10
Po-210	7.1E-15	Ru-97	6.7E-11
Pr-142	1.1E-10	Ru-103	2.6E-12
Pr-143	7.1E-12	Ru-105	2.8E-10
Pr-144	1.8E-08	Ru-106	3.4E-13
Pt-191	4.3E-11	S-35	1.3E-12
Pt-193	1.8E-11	Sb-117	2.4E-09
Pt-193m	4.8E-11	Sb-122	1.4E-11
Pt-195m	3.2E-11	Sb-124	5.3E-13
Pt-197	4.0E-10	Sb-125	1.6E-13
Pt-197m	2.6E-09	Sb-126	1.4E-12
Pu-236	5.9E-15	Sb-126m	9.1E-10
Pu-237	1.9E-11	Sb-127	7.1E-12
Pu-238	2.1E-15	Sb-129	7.7E-11
Pu-239	2.0E-15	Sc-44	1.7E-10
Pu-240	2.0E-15	Sc-46	4.2E-13

Pu-241	1.0E-13	Sc-47	3.8E-11
Pu-242	2.0E-15	Sc-48	9.1E-12
Pu-243	4.2E-09	Sc-49	1.2E-08
Pu-244	2.0E-15	Se-73	1.7E-10
Pu-245	2.1E-10	Se-75	1.7E-13
Pu-246	2.2E-12	Se-79	1.1E-13
Ra-223	4.2E-14	Si-31	5.6E-09
Ra-224	1.5E-13	Si-32	3.4E-14
Ra-225	5.0E-14	Sm-147	1.4E-14
Ra-226	3.3E-15	Sm-151	2.1E-11
Ra-228	5.9E-15	Sm-153	5.9E-11
Rb-81	5.0E-10	Sn-113	1.4E-12
Rb-83	3.4E-13	Sn-117m	5.6E-12
Rb-84	3.6E-13	Sn-119m	5.3E-12
Rb-86	5.6E-13	Sn-123	1.1E-12
Rb-87	1.6E-13	Sn-125	1.7E-12
Rb-88	2.1E-09	Sn-126	5.3E-15
Rb-89	7.1E-10	Sr-82	6.2E-13
Re-184	1.5E-12	Sr-85	1.8E-12
Sr-85m	1.6E-09	Th-232	6.2E-16
Sr-87m	1.4E-09	Th-234	2.2E-12
Sr-89	1.8E-12	Ti-44	6.2E-15
Sr-90	1.9E-14	Ti-45	4.8E-10
Sr-91	9.1E-11	Tl-200	4.5E-11
Sr-92	2.9E-10	Tl-201	1.0E-10
Ta-182	4.5E-13	Tl-202	5.0E-12
Tb-157	2.5E-12	Tl-204	1.2E-12
Tb-160	7.7E-13	Tm-170	3.3E-12
Tc-95	1.0E-10	Tm-171	2.6E-11
Tc-95m	1.4E-12	U-230	1.5E-14
Tc-96	5.6E-12	U-231	4.2E-11
Tc-96m	6.7E-10	U-232	1.3E-15
Tc-97	7.1E-13	U-233	7.1E-15
Tc-97m	7.1E-12	U-234	7.7E-15
Tc-98	6.7E-15	U-235	7.1E-15
Tc-99	1.4E-13	U-236	7.7E-15
Tc-99m	1.7E-09	U-237	1.0E-11
Tc-101	4.5E-09	U-238	8.3E-15
Te-121	1.0E-12	U-239	4.3E-09
Te-121m	1.2E-13	U-240	1.3E-10
Te-123	1.4E-13	V-48	1.0E-12
Te-123m	2.0E-13	V-49	1.6E-10
Te-125m	3.6E-13	W-181	6.7E-12
Te-127	1.0E-09	W-185	2.6E-12
Te-127m	1.5E-13	W-187	7.7E-11
Te-129	7.7E-09	W-188	5.3E-13
Te-129m	1.4E-13	Xe-122	9.1E-11
Te-131	9.1E-11	Xe-123	1.6E-09

Te-131m	1.0E-12	Xe-125	1.1E-11
Te-132	7.1E-13	Xe-127	8.3E-09
Te-133	9.1E-10	Xe-129m	9.1E-08
Te-133m	2.2E-10	Xe-131m	2.6E-07
Te-134	5.3E-10	Xe-133	6.2E-08
Th-226	3.4E-11	Xe-133m	7.1E-08
Th-227	3.8E-14	Xe-135	9.1E-09
Th-228	3.1E-15	Xe-135m	5.0E-09
Th-229	5.3E-16	Xe-138	1.2E-09
Th-230	3.4E-15	Y-86	3.0E-11
Th-231	2.9E-10	Y-87	1.7E-11
Y-88	2.7E-13	Zn-65	9.1E-14
Y-90	1.3E-11	Zn-69	3.2E-08
Y-90m	1.9E-10	Zn-69m	1.7E-10
Y-91	2.1E-12	Zr-86	2.4E-11
Y-91m	1.3E-09	Zr-88	3.1E-13
Y-92	8.3E-10	Zr-89	1.3E-11
Y-93	2.9E-10	Zr-93	2.6E-12
Yb-169	3.7E-12	Zr-95	6.7E-13
Yb-175	4.3E-11	Zr-97	3.8E-11
Zn-62	9.1E-11		

6. References

(1) Environmental Protection Agency, "A Guide for Determining Compliance with the Clean Air Act Standards for Radionuclides Emissions from NRC-Licensed and Non-DOE Federal Facilities", EPA 520/1-89-002, October 1989.

(2) Environmental Protection Agency, "User's Guide for the COMPLY Code", EPA 520/1-89-003, October 1989.

(3) Environmental Protection Agency, "Background Information Document: Procedures Approved for Demonstrating Compliance with 40 CFR Part 61, Subpart I", EPA 520/1-89-001, January 1989.

(4) National Council on Radiation Protection and Measurement, "Screening Techniques for Determining Compliance with Environmental Standards" NCRP Commentary No. 3, Revision of January 1989 with addendum of October, 1989.

[54 FR 51711, Dec. 15, 1989]

For questions or comments regarding e-CFR editorial content, features, or design, email ecfr@nara.gov.
For questions concerning e-CFR programming and delivery issues, email webteam@gpo.gov.

Appendix H – 40 CFR Part 63, Subpart DD

ELECTRONIC CODE OF FEDERAL REGULATIONS

e-CFR Data is current as of August 30, 2013

Title 40: Protection of Environment

PART 63—NATIONAL EMISSION STANDARDS FOR HAZARDOUS AIR POLLUTANTS FOR SOURCE CATEGORIES (CONTINUED)

Subpart **DD**—National Emission Standards for Hazardous Air Pollutants from Off-Site Waste and Recovery Operations

Contents

- § 63.680 Applicability and designation of affected sources.
- § 63.681 Definitions.
- § 63.682 [Reserved]
- § 63.683 Standards: General.
- § 63.684 Standards: Off-site material treatment.
- § 63.685 Standards: Tanks.
- § 63.686 Standards: Oil-water and organic-water separators.
- § 63.687 Standards: Surface impoundments.
- § 63.688 Standards: Containers.
- § 63.689 Standards: Transfer systems.
- § 63.690 Standards: Process vents.
- § 63.691 Standards: Equipment leaks.
- § 63.692 [Reserved]
- § 63.693 Standards: Closed-vent systems and control devices.
- § 63.694 Testing methods and procedures.
- § 63.695 Inspection and monitoring requirements.
- § 63.696 Recordkeeping requirements.
- § 63.697 Reporting requirements.
- § 63.698 Implementation and enforcement.
- Table 1 to Subpart **DD** of Part 63—List of Hazardous Air Pollutants (HAP) for Subpart **DD**
- Table 2 to Subpart **DD** of Part 63—Applicability of Paragraphs in Subpart A of This Part 63—General Provisions to Subpart **DD**
- Table 3 to Subpart **DD** of Part 63—Tank Control Levels for Tanks at Existing Affected Sources as Required by 40 CFR 63.685(b)(1)
- Table 4 to Subpart **DD** of Part 63—Tank Control Levels for Tanks at New Affected Sources as Required by 40 CFR 63.685(b)(2)

SOURCE: 61 FR 34158, July 1, 1996, unless otherwise noted.

§ 63.680 Applicability and designation of affected sources.

(a) The provisions of this subpart apply to the owner and operator of a plant site for which both of the conditions specified in paragraphs (a)(1) and (a)(2) of this section are applicable. If either one of these conditions does not apply to the plant site, then the owner and operator of the plant site are not subject to the provisions of this subpart.

(1) The plant site is a major source of hazardous air pollutant (HAP) emissions as defined in 40 CFR 63.2.

(2) At the plant site is located one or more of operations that receives off-site materials as specified in paragraph (b) of this section and the operations is one of the following waste management operations or recovery operations as specified in paragraphs (a)(2)(i) through (a)(2)(vi) of this section.

(i) A waste management operation that receives off-site material and the operation is regulated as a hazardous waste treatment, storage, and disposal facility (TSDF) under either 40 CFR part 264 or part 265.

(ii) A waste management operation that treats wastewater which is an off-site material and the operation is exempted from regulation as a hazardous waste treatment, storage, and disposal facility under 40 CFR 264.1(g)(6) or 40 CFR 265.1(c)(10).

(iii) A waste management operation that treats wastewater which is an off-site material and the operation meets both of the following conditions:

(A) The operation is subject to regulation under either section 402 or 307(b) of the Clean Water Act but is not owned by a “state” or “municipality” as defined by section 502(3) and 502(4), respectively, of the Clean Water Act; and

(B) The treatment of wastewater received from off-site is the predominant activity performed at the plant site.

(iv) A recovery operation that recycles or reprocesses hazardous waste which is an off-site material and the operation is exempted from regulation as a hazardous waste treatment, disposal, and storage facility under 40 CFR 264.1(g)(2) or 40 CFR 265.1(c)(6).

(v) A recovery operation that recycles or reprocesses used solvent which is an off-site material and the operation is not part of a chemical, petroleum, or other manufacturing process that is required to use air emission controls by another subpart of 40 CFR part 63 or 40 CFR part 61.

(vi) A recovery operation that re-refines or reprocesses used oil which is an off-site material and the operation is regulated under 40 CFR 279 subpart F—Standards for Used Oil Processors and Refiners.

(b) For the purpose of implementing this subpart, an off-site material is a material that meets all of the criteria specified in paragraph (b)(1) of this section but is not one of the materials specified in paragraph (b)(2) of this section.

(1) An off-site material is a material that meets all of the criteria specified in paragraphs (b)(1)(i) through (b)(1)(iii) of this section. If any one of these criteria do not apply to the material, then the material is not an off-site material subject to this subpart.

(i) The material is a waste, used oil, or used solvent as defined in § 63.681 of this subpart;

(ii) The waste, used oil, or used solvent is not produced or generated within the plant site, but the material is delivered, transferred, or otherwise moved to the plant site from a location outside the boundaries of the plant site; and

(iii) The waste, used oil, or used solvent contains one or more of the hazardous air pollutants (HAP) listed in Table 1 of this subpart based on the composition of the material at the point-of-delivery, as defined in § 63.681 of this subpart.

(2) For the purpose of implementing this subpart, the following materials are not off-site materials:

(i) Household waste as defined in 40 CFR 258.2.

(ii) Radioactive mixed waste managed in accordance with all applicable regulations under Atomic Energy Act and Nuclear Waste Policy Act authorities.

(iii) Waste that is generated as a result of implementing remedial activities required under the Resource Conservation and Recovery Act (RCRA) corrective action authorities (RCRA sections 3004(u), 3004(v), or 3008(h)), Comprehensive Environmental Response, Compensation, and Liability Act (CERCLA) authorities, or similar Federal or State authorities.

(iv) Waste containing HAP that is generated by residential households (e.g., old paint, home garden pesticides) and subsequently is collected as a community service by government agencies, businesses, or other organizations for the purpose of promoting the proper disposal of this waste.

(v) Waste that is transferred from a chemical manufacturing plant or other facility for which both of the following conditions apply to the waste:

(A) The management of the waste at the facility is required either under part 63 subpart F—National Emission Standards for Organic Hazardous Air Pollutants from the Synthetic Organic Chemical Manufacturing Industry or under another subpart in 40 CFR part 63 to meet the air emission control standards for process wastewater specified in 40 CFR 63.132 through 63.147; and

(B) The owner or operator of the facility from which the waste is transferred has complied with the provisions of 40 CFR 63.132(g)(1)(ii) and (g)(2).

(vi) Waste that is transferred from a chemical manufacturing plant, petroleum refinery, or coke by-product recovery plant which is subject to 40 CFR part 61, subpart FF—National Emission Standards for Benzene Waste Operations, and for which both of the following conditions apply to the waste:

(A) The waste is generated at a facility that is not exempted under the provisions of 40 CFR 61.342(a) from meeting the air emission control standards of 40 CFR part 61, subpart FF; and

(B) The owner or operator of the facility from which the waste is transferred has complied with the provisions of 40 CFR 61.342(f)(2).

(vii) Ship ballast water pumped from a ship to an onshore wastewater treatment facility.

(viii) Hazardous waste that is stored for 10 days or less at a transfer facility in compliance with the provisions of 40 CFR 263.12.

(c) *Affected sources* —(1) *Off-site material management units*. For each operation specified in paragraphs (a)(2)(i) through (a)(2)(vi) of this section that is located at the plant site, the affected source is the entire group of off-site material management units associated with the operation. An off-site material management unit is a tank, container, surface impoundment, oil-water separator, organic-water separator, or transfer system used to manage off-site material. For the purpose of implementing the standards under this subpart, a unit that meets the definition of a tank or container but also is equipped with a vent that serves as a process vent for any of the processes listed in paragraphs (c)(2)(i) through (c)(2)(vi) of this section is not an off-site material management unit but instead is a process vent and is to be included in the appropriate affected source group under paragraph (c)(2) of this section. Examples of such a unit may include, but are not limited to, a distillate receiver vessel, a primary condenser, a bottoms receiver vessel, a surge control tank, a separator tank, and a hot well.

(2) *Process vents*. For each operation specified in paragraphs (a)(2)(i) through (a)(2)(vi) of this section that is located at the plant site, the affected source is the entire group of process equipment associated with the process vents for the processes listed in paragraphs (c)(2)(i) through (c)(2)(vi) of this section.

(i) Distillation process used for the treatment, recycling, or recovery of off-site material. Distillation means a process, either batch or continuous, separating one or more off-site material feed streams into two or more exit streams having different component concentrations from those in the feed stream or streams. The separation is achieved by the redistribution of the components between the liquid and vapor phases as they approach equilibrium within the distillation unit.

(ii) Fractionation process used for the treatment, recycling, or recovery of off-site material. Fractionation means a liquid mixture separation process or method used to separate a mixture of several volatile components of different boiling points in successive stages, each stage removing from the mixture some proportion of one of the components.

(iii) Thin-film evaporation process used for the treatment, recycling, or recovery of off-site material. Thin-film evaporation means a liquid mixture separation process or method that uses a heating surface consisting of a large diameter tube that may be either straight or tapered, horizontal or vertical. Liquid is spread on the tube wall by a rotating assembly of blades that maintain a close clearance from the wall or actually ride on the film of liquid on the wall.

(iv) Solvent extraction process used for the treatment, recycling, or recovery of off-site material. Solvent extraction means a separation process or method in which a solid or a solution is contacted with a liquid solvent (the material and the solvent being relatively insoluble in each other) to preferentially dissolve and transfer one or more components into the solvent.

(v) Steam stripping process used for the treatment, recycling, or recovery of off-site material. Steam stripping means a liquid mixture separation process or method in which vaporization of the volatile components of a liquid mixture occurs by the introduction of steam directly into the process.

(vi) Gas stripping process used for the treatment, recycling, or recovery of off-site material. Gas stripping means a desorption process or method used to transfer one or more volatile components from a liquid mixture into a gas stream either with or without the application of heat to the liquid. Packed towers, spray towers, and bubble-cap, sieve, or valve-type plate towers are examples of the process configurations used for contacting the gas and a liquid.

(3) *Equipment leaks.* For each operation specified in paragraphs (a)(2)(i) through (a)(2)(vi) of this section that is located at the plant site, the affected source is the entire group of equipment components for which each component meets all of the conditions specified in paragraphs (c)(3)(i) through (c)(3)(iii) of this section. If any one of these conditions do not apply to an equipment component, then that component is not part of the affected source for equipment leaks.

(i) The equipment component is a pump, compressor, agitator, pressure relief device, sampling connection system, open-ended valve or line, valve, connector, or instrumentation system;

(ii) The equipment component contains or contacts off-site material having a total HAP concentration equal to or greater than 10 percent by weight; and

(iii) The equipment component is intended to operate for 300 hours or more during a calendar year in off-site material service, as defined in § 63.681 of this subpart.

(d) *Facility-wide exemption.* The owner or operator of affected sources subject to this subpart is exempted from the requirements of §§ 63.682 through 63.699 of this subpart in situations when the total annual quantity of the HAP that is contained in the off-site material received at the plant site is less than 1 megagram per year. For a plant site to be exempted under the provisions of this paragraph (d), the owner or operator must meet the requirements in paragraphs (d)(1) through (d)(3) of this section.

(1) The owner or operator must prepare an initial determination of the total annual HAP quantity in the off-site material received at the plant site. This determination is based on the total quantity of the HAP listed in Table 1 of this subpart as determined at the point-of-delivery for each off-site material stream.

(2) The owner or operator must prepare a new determination whenever the extent of changes to the quantity or composition of the off-site material received at the plant site could cause the total annual HAP quantity in the off-site material received at the plant site to exceed the limit of 1 megagram per year.

(3) The owner or operator must maintain documentation to support the owner's or operator's determination of the total annual HAP quantity in the off-site material received at the plant site. This documentation must include the basis and data used for determining the HAP content of the off-site material.

(e) *Compliance dates* —(1) *Existing sources*. The owner or operator of an affected source that commenced construction or reconstruction before October 13, 1994, must achieve compliance with the provisions of this subpart on or before the date specified in paragraph (e)(1)(i) or (e)(1)(ii) of this section as applicable to the affected source.

(i) For an affected source that commenced construction or reconstruction before October 13, 1994 and receives off-site material for the first time before February 1, 2000, the owner or operator of this affected source must achieve compliance with the provisions of the subpart on or before February 1, 2000 unless an extension has been granted by the Administrator as provided in 40 CFR 63.6(i).

(ii) For an affected source that commenced construction or reconstruction before October 13, 1994, but receives off-site material for the first time on or after February 1, 2000, the owner or operator of the affected source must achieve compliance with the provisions of this subpart upon the first date that the affected source begins to manage off-site material.

(2) *New sources*. The owner or operator of an affected source for which construction or reconstruction commences on or after October 13, 1994, must achieve compliance with the provisions of this subpart on or before July 1, 1996, or upon initial startup of operations, whichever date is later as provided in 40 CFR 63.6(b).

(f) The provisions of 40 CFR part 63, subpart A—General Provisions that apply and those that do not apply to this subpart are specified in Table 2 of this subpart.

[61 FR 34158, July 1, 1996, as amended at 65 FR 38963, July 20, 1999]

§ 63.681 Definitions.

All terms used in this subpart shall have the meaning given to them in this section, 40 CFR 63.2 of this part, and the Act.

Boiler means an enclosed combustion device that extracts useful energy in the form of steam and is not an incinerator or a process heater.

Closed-vent system means a system that is not open to the atmosphere and is composed of hard-piping, ductwork, connections, and, if necessary, fans, blowers, or other flow-inducing devices that conveys gas or vapor from an emission point to a control device.

Closure device means a cap, hatch, lid, plug, seal, valve, or other type of fitting that prevents or reduces air pollutant emissions to the atmosphere by blocking an opening in a cover when the device is secured in the closed position. Closure devices include devices that are detachable from the cover (e.g., a sampling port cap), manually operated (e.g., a hinged access lid or hatch), or automatically operated (e.g., a spring-loaded pressure relief valve).

Container means a portable unit used to hold material. Examples of containers include but are not limited to drums, dumpsters, roll-off boxes, bulk cargo containers commonly known as “portable tanks” or “totes”, cargo tank trucks, and tank rail cars.

Continuous record means documentation of data values measured at least once every 15 minutes and recorded at the frequency specified in this subpart.

Continuous recorder means a data recording device that either records an instantaneous data value at least once every 15 minutes or records 15-minute or more frequent block averages.

Continuous seal means a seal that forms a continuous closure that completely covers the space between the edge of the floating roof and the wall of a tank. A continuous seal may be a vapor-

mounted seal, liquid-mounted seal, or metallic shoe seal. A continuous seal may be constructed of fastened segments so as to form a continuous seal.

Control device means equipment used for recovering, removing, oxidizing, or destroying organic vapors. Examples of such equipment include but are not limited to carbon adsorbers, condensers, vapor incinerators, flares, boilers, and process heaters.

Cover means a device or system that provides a continuous barrier over the material managed in an off-site material management unit to prevent or reduce air pollutant emissions to the atmosphere. A cover may have openings needed for operation, inspection, sampling, maintenance, and repair of the unit provided that each opening is closed when not in use (e.g., access hatches, sampling ports). A cover may be a separate piece of equipment which can be detached and removed from the unit or a cover may be formed by structural features permanently integrated into the design of the unit.

Emission point means an individual tank, surface impoundment, container, oil-water or organic-water separator, transfer system, process vent, or enclosure.

Enclosure means a structure that surrounds a tank or container, captures organic vapors emitted from the tank or container, and vents the captured vapor through a closed vent system to a control device.

External floating roof means a pontoon-type or double-deck type cover that rests on the liquid surface in a tank with no fixed roof.

Fixed roof means a cover that is mounted on a unit in a stationary position and does not move with fluctuations in the level of the liquid managed in the unit.

Flame zone means the portion of the combustion chamber in a boiler or process heater occupied by the flame envelope.

Floating roof means a cover consisting of a double deck, pontoon single deck, or internal floating cover which rests upon and is supported by the liquid being contained, and is equipped with a continuous seal.

Flow indicator means a device that indicates whether gas is flowing, or whether the valve position would allow gas to flow in a bypass line.

Hard-piping means pipe or tubing that is manufactured and properly installed in accordance with relevant standards and good engineering practices.

Hazardous air pollutants or *HAP* means the specific organic chemical compounds, isomers, and mixtures listed in Table 1 of this subpart.

Hazardous waste means a waste that is determined to be hazardous under the Resource Conservation and Recovery Act (PL 94-580) (RCRA), as implemented by 40 CFR parts 260 and 261.

Individual drain system means a stationary system used to convey wastewater streams or residuals to a waste management unit or to discharge or disposal. The term includes hard-piping, all drains and junction boxes, together with their associated sewer lines and other junction boxes (e.g., manholes, sumps, and lift stations) conveying wastewater streams or residuals. For the purpose of this subpart, an individual drain system is not a drain and collection system that is designed and operated for the sole purpose of collecting rainfall runoff (e.g., stormwater sewer system) and is segregated from all other individual drain systems.

Internal floating roof means a cover that rests or floats on the liquid surface (but not necessarily in complete contact with it inside a tank that has a fixed roof).

Light-material service means the container is used to manage an off-site material for which both of the following conditions apply: the vapor pressure of one or more of the organic constituents in the off-site material is greater than 0.3 kilopascals (kPa) at 20 °C; and the total concentration of the pure

organic constituents having a vapor pressure greater than 0.3 kPa at 20 °C is equal to or greater than 20 percent by weight.

Liquid-mounted seal means a foam- or liquid-filled continuous seal mounted in contact with the liquid in a unit.

Maximum HAP vapor pressure means the sum of the individual HAP equilibrium partial pressure exerted by an off-site material at the temperature equal to either: the local maximum monthly average temperature as reported by the National Weather Service when the off-site material is stored or treated at ambient temperature; or the highest calendar-month average temperature of the off-site material when the off-site material is stored at temperatures above the ambient temperature or when the off-site material is stored or treated at temperatures below the ambient temperature. For the purpose of this subpart, maximum HAP vapor pressure is determined using the procedures specified in § 63.694(j) of this subpart.

Metallic shoe seal means a continuous seal that is constructed of metal sheets which are held vertically against the wall of the tank by springs, weighted levers, or other mechanisms and is connected to the floating roof by braces or other means. A flexible coated fabric (envelope) spans the annular space between the metal sheet and the floating roof.

No detectable organic emissions means no escape of organics to the atmosphere as determined using the procedure specified in § 63.694(k) of this subpart.

Off-site material means a material that meets all of the criteria specified in paragraph § 63.680(b)(1) of this subpart but is not one of the materials specified in § 63.680(b)(2) of this subpart.

Off-site material management unit means a tank, container, surface impoundment, oil-water separator, organic-water separator, or transfer system used to manage off-site material.

Off-site material service means any time when a pump, compressor, agitator, pressure relief device, sampling connection system, open-ended valve or line, valve, connector, or instrumentation system contains or contacts off-site material.

Off-site material stream means an off-site material produced or generated by a particular process or source such that the composition and form of the material comprising the stream remain consistent. An off-site material stream may be delivered, transferred, or otherwise moved to the plant site in a continuous flow of material (e.g., wastewater flowing through a pipeline) or in a series of discrete batches of material (e.g., a truckload of drums all containing the same off-site material or multiple bulk truck loads of an off-site material produced by the same process).

Oil-water separator means a separator as defined for this subpart that is used to separate oil from water.

Operating parameter value means a minimum or maximum value established for a control device or treatment process parameter which, if achieved by itself or in combination with one or more other operating parameter values, determines that an owner or operator has complied with an applicable emission limitation or standard.

Organic-water separator means a separator as defined for this subpart that is used to separate organics from water.

Plant site means all contiguous or adjoining property that is under common control including properties that are separated only by a road or other public right-of-way. Common control includes properties that are owned, leased, or operated by the same entity, parent entity, subsidiary, or any combination thereof. A unit or group of units within a contiguous property that are not under common control (e.g., a wastewater treatment unit or solvent recovery unit located at the site but is sold to a different company) is a different plant site.

Point-of-delivery means the point at the boundary or within the plant site where the owner or operator first accepts custody, takes possession, or assumes responsibility for the management of an off-site material stream managed in a waste management operation or recovery operation specified in § 63.680 (a)(2)(i) through (a)(2)(vi) of this subpart. The characteristics of an off-site material stream are determined prior to combining the off-site material stream with other off-site material streams or with any other materials.

Point-of-treatment means a point after the treated material exits the treatment process but before the first point downstream of the treatment process exit where the organic constituents in the treated material have the potential to volatilize and be released to the atmosphere. For the purpose of applying this definition to this subpart, the first point downstream of the treatment process exit is not a fugitive emission point due to an equipment leak from any of the following equipment components: pumps, compressors, valves, connectors, instrumentation systems, or safety devices.

Process heater means an enclosed combustion device that transfers heat released by burning fuel directly to process streams or to heat transfer liquids other than water.

Process vent means an open-ended pipe, stack, or duct through which a gas stream containing HAP is continuously or intermittently discharged to the atmosphere from any of the processes listed in § 63.680(c)(2)(i) through (c)(2)(vi) of this section. For the purpose of this subpart, a process vent is none of the following: a pressure-relief vent or other vent that is used as a safety device (as defined in this section); an open-ended line or other vent that is subject to the equipment leak control requirements under § 63.691 of this subpart; or a stack or other vent that is used to exhaust combustion products from a boiler, furnace, process heater, incinerator, or other combustion device.

Recovery operation means the collection of off-site material management units, process vents, and equipment components used at a plant site to manage an off-site material stream from the point-of-delivery through the point where the material has been recycled, reprocessed, or re-refined to obtain the intended product or to remove the physical and chemical impurities of concern.

Safety device means a closure device such as a pressure relief valve, frangible disc, fusible plug, or any other type of device which functions to prevent physical damage or permanent deformation to equipment by venting gases or vapors during unsafe conditions resulting from an unplanned, accidental, or emergency event. For the purpose of this subpart, a safety device is not used for routine venting of gases or vapors from the vapor headspace underneath a cover such as during filling of the unit or to adjust the pressure in this vapor headspace in response to normal daily diurnal ambient temperature fluctuations. A safety device is designed to remain in a closed position during normal operations and open only when the internal pressure, or another relevant parameter, exceeds the device threshold setting applicable to the equipment as determined by the owner or operator based on manufacturer recommendations, applicable regulations, fire protection and prevention codes, standard engineering codes and practices, or other requirements for the safe handling of flammable, combustible, explosive, reactive, or hazardous materials.

Separator means a waste management unit, generally a tank, used to separate oil or organics from water. A separator consists of not only the separation unit but also the forebay and other separator basins, skimmers, weirs, grit chambers, sludge hoppers, and bar screens that are located directly after the individual drain system and prior to any additional treatment units such as an air flotation unit clarifier or biological treatment unit. Examples of a separator include, but are not limited to, an API separator, parallel-plate interceptor, and corrugated-plate interceptor with the associated ancillary equipment.

Single-seal system means a floating roof having one continuous seal. This seal may be vapor-mounted, liquid-mounted, or a metallic shoe seal.

Surface impoundment means a unit that is a natural topographical depression, man-made excavation, or diked area formed primarily of earthen materials (although it may be lined with man-made materials), which is designed to hold an accumulation of liquids. Examples of surface impoundments include holding, storage, settling, and aeration pits, ponds, and lagoons.

Tank means a stationary unit that is constructed primarily of nonearthen materials (such as wood, concrete, steel, fiberglass, or plastic) which provide structural support and is designed to hold an accumulation of liquids or other materials.

Transfer system means a stationary system for which the predominant function is to convey liquids or solid materials from one point to another point within a waste management operation or recovery operation. For the purpose of this subpart, the conveyance of material using a container (as defined for this subpart) or a self-propelled vehicle (e.g., a front-end loader) is not a transfer system. Examples of a transfer system include but are not limited to a pipeline, an individual drain system, a gravity-operated conveyor (such as a chute), and a mechanically-powered conveyor (such as a belt or screw conveyor).

Temperature monitoring device means a piece of equipment used to monitor temperature and having an accuracy of ± 1 percent of the temperature being monitored expressed in degrees Celsius ($^{\circ}$ C) or ± 1.2 degrees $^{\circ}$ C, whichever value is greater.

Treatment process means a process in which an off-site material stream is physically, chemically, thermally, or biologically treated to destroy, degrade, or remove hazardous air pollutants contained in the off-site material. A treatment process can be composed of a single unit (e.g., a steam stripper) or a series of units (e.g., a wastewater treatment system). A treatment process can be used to treat one or more off-site material streams at the same time.

Used oil means any oil refined from crude oil or any synthetic oil that has been used and as a result of such use is contaminated by physical or chemical impurities. This definition is the same definition of "used oil" in 40 CFR 279.1.

Used solvent means a mixture of aliphatic hydrocarbons or a mixture of one and two ring aromatic hydrocarbons that has been used as a solvent and as a result of such use is contaminated by physical or chemical impurities.

Vapor-mounted seal means a continuous seal that is mounted such that there is a vapor space between the liquid in the unit and the bottom of the seal.

Volatile organic hazardous air pollutant concentration or *VOHAP concentration* means the fraction by weight of those compounds listed in Table 1 of this subpart that are in an off-site material as measured using Method 305 in appendix A of this part and expressed in terms of parts per million (ppm). As an alternative to using Method 305, an owner or operator may determine the HAP concentration of an off-site material using any one of the other test methods specified in § 63.694(b)(2)(ii) of this subpart. When a test method specified in § 63.694(b)(2)(ii) of this subpart other than Method 305 is used to determine the speciated HAP concentration of an off-site material, the individual compound concentration may be adjusted by the corresponding f_{m305} value listed in Table 1 of this subpart to determine a VOHAP concentration.

Waste means a material generated from industrial, commercial, mining, or agricultural operations or from community activities that is discarded, discharged, or is being accumulated, stored, or physically, chemically, thermally, or biologically treated prior to being discarded or discharged.

Waste management operation means the collection of off-site material management units, process vents, and equipment components used at a plant site to manage an off-site material stream from the point-of-delivery to the point where the waste exits or is discharged from the plant site or the waste is placed for on-site disposal in a unit not subject to this subpart (e.g., a waste incinerator, a land disposal unit).

Waste stabilization process means any physical or chemical process used to either reduce the mobility of hazardous constituents in a waste or eliminate free liquids as determined by Test Method 9095—Paint Filter Liquids Test in "Test Methods for Evaluating Solid Waste, Physical/Chemical Methods," EPA Publication No. SW-846, Third Edition, September 1986, as amended by Update I, November 15, 1992. (As an alternative, an owner or operator may use any more recent, updated version of Method 9095 approved by the EPA.) A waste stabilization process includes mixing the

waste with binders or other materials and curing the resulting waste and binder mixture. Other synonymous terms used to refer to this process are “waste fixation” or “waste solidification.” A waste stabilization process does not include the adding of absorbent materials to the surface of a waste, without mixing, agitation, or subsequent curing, to absorb free liquid.

[61 FR 34158, July 1, 1996, as amended at 64 FR 38964, July 20, 1999]

§ 63.682 [Reserved]

§ 63.683 Standards: General.

(a) The general standards under this section apply to owners and operators of affected sources as designated in § 63.680(c) of this subpart.

(b) *Off-site material management units.* (1) For each off-site material management unit that is part of an affected source, the owner or operator must meet the requirements in either paragraph (b)(1)(i), (b)(1)(ii), or (b)(1)(iii) of this section except for those off-site material management units exempted under paragraph (b)(2) of this section.

(i) The owner or operator controls air emissions from the off-site material management unit in accordance with the applicable standards specified in §§ 63.685 through 63.689 of this subpart.

(ii) The owner or operator removes or destroys HAP in the off-site material before placing the material in the off-site material management unit by treating the material in accordance with the standards specified in § 63.684 of this subpart.

(iii) The owner or operator determines before placing off-site material in the off-site material management unit that the average VOHAP concentration of the off-site material is less than 500 parts per million by weight (ppmw) at the point-of-delivery. The owner or operator must perform an initial determination of the average VOHAP concentration of the off-site material using the procedures specified in § 63.694(b) of this subpart. This initial determination must be performed either before the first time any portion of the off-site material stream is placed in the unit or by the compliance date, whichever date is later. Thereafter, the owner or operator must review and update, as necessary, this determination at least once every calendar year following the date of the initial determination for the off-site material stream.

(2) An off-site material management unit is exempted from the requirements in paragraph (b)(1) of this section when the owner or operator meets one of the exemptions provided in paragraphs (b)(2)(i) through (b)(2)(iv) of this section as applicable to the unit.

(i) An off-site material management unit is exempted from the requirements in paragraph (b)(1) of this section if the off-site material management unit is also subject to another subpart under 40 CFR part 63 or 40 CFR part 61, and the owner or operator is controlling the HAP listed in Table 1 of this subpart that are emitted from the unit in compliance with the provisions specified in the other applicable subpart under part 61 or part 63.

(ii) At the discretion of the owner or operator, one or a combination of off-site material management units may be exempted from the requirements in paragraph (b)(1) of this section when these units meet the condition that the total annual quantity of HAP contained in the off-site material placed in the units exempted under this paragraph (b)(2)(ii) is less than 1 megagram per year. For the off-site material management units selected by the owner or operator to be exempted from the requirements in paragraph (b)(1) of this section, the owner or operator must meet the requirements in paragraphs (b)(2)(ii)(A) and (b)(2)(ii)(B) of this section. An owner or operator may change the off-site material management units selected to be exempted under this paragraph (b)(2)(ii) by preparing a new designation for the exempt-units as required by paragraph (b)(2)(ii)(A) of this section and performing a new determination as required by paragraph (b)(2)(ii)(B) of this section.

(A) The owner or operator must designate each of the off-site material management units selected by the owner or operator to be exempt under paragraph (b)(2)(ii) of this section by either

submitting to the Administrator a written notification identifying the exempt-units or permanently marking the exempt-units at the plant site. If an owner or operator chooses to prepare and submit a written notification, this notification must include a site plan, process diagram, or other appropriate documentation identifying each of the exempt-units. If an owner or operator chooses to permanently mark the exempt-units, each exempt-unit must be marked in such a manner that it can be readily identified as an exempt-unit from the other off-site material management units located at the plant site.

(B) The owner or operator must prepare an initial determination of the total annual HAP quantity in the off-site material placed in the units exempted under this paragraph (b)(2)(ii). This determination is based on the total quantity of the HAP listed in Table 1 of this subpart as determined at the point where the off-site material is placed in each exempted unit. The owner or operator must perform a new determination whenever the extent of changes to the quantity or composition of the off-site material placed in the exempted units could cause the total annual HAP content in the off-site material to exceed 1 megagram per year. The owner or operator must maintain documentation to support the most recent determination of the total annual HAP quantity. This documentation must include the basis and data used for determining the HAP content of the off-site material.

(iii) A tank or surface impoundment is exempted from the requirements in paragraph (b)(1) of this section if the unit is used for a biological treatment process that meets the requirements in either paragraph (b)(2)(iii)(A) or (b)(2)(iii)(B) of this section and the owner or operator complies with the monitoring requirements in § 63.684(e)(4) of this subpart.

(A) The HAP biodegradation efficiency (R_{bio}) for the biological treatment process is equal to or greater than 95 percent. The HAP biodegradation efficiency (R_{bio}) shall be determined in accordance with the requirements of § 63.694(h) of this subpart.

(B) The total actual HAP mass removal rate (MR_{bio}) for the off-site material treated by the biological treatment process is equal to or greater than the required HAP mass removal rate (RMR) for the off-site material. The total actual HAP mass removal rate (MR_{bio}) must be determined in accordance with the requirements of § 63.694(i) of this subpart. The required HAP mass removal rate (RMR) must be determined in accordance with the requirements of § 63.694(e) of this subpart.

(iv) An off-site material management unit is exempted from the requirements in paragraph (b)(1) of this section if the off-site material placed in the unit is a hazardous waste that meets the conditions specified in either paragraph (b)(2)(iv)(A) or (b)(2)(iv)(B) of this section.

(A) The hazardous waste meets the numerical organic concentration limits, applicable to the hazardous waste, as specified in 40 CFR part 268—Land Disposal Restrictions, listed in the table, “Treatment Standards for Hazardous Waste” in 40 CFR 268.40.

(B) The organic hazardous constituents in the hazardous waste have been treated by the treatment technology established by the EPA for the hazardous waste in 40 CFR 268.42(a), or have been removed or destroyed by an equivalent method of treatment approved by the EPA under 40 CFR 268.42(b).

(v) A tank used for bulk feed of off-site material to a waste incinerator is exempted from the requirements specified in paragraph (b)(1) of this section if the tank meets all of the conditions specified in paragraphs (b)(2)(v)(A) through (b)(2)(v)(C) of this section.

(A) The tank is located inside an enclosure vented to a control device that is designed and operated in accordance with all applicable requirements specified under 40 CFR part 61, subpart FF—National Emission Standards for Benzene Waste Operations for a facility at which the total annual benzene quantity from the facility waste is equal to or greater than 10 megagrams per year;

(B) The enclosure and control device serving the tank were installed and began operation prior to July 1, 1996; and

(C) The enclosure is designed and operated in accordance with the criteria for a permanent total enclosure as specified in “Procedure T—Criteria for and Verification of a Permanent or Temporary

Total Enclosure” under 40 CFR 52.741, appendix B. The enclosure may have permanent or temporary openings to allow worker access; passage of material into or out of the enclosure by conveyor, vehicles, or other mechanical or electrical equipment; or to direct air flow into the enclosure. The owner or operator must annually perform the verification procedure for the enclosure as specified in Section 5.0 to “Procedure T—Criteria for and Verification of a Permanent or Temporary Total Enclosure.”

(c) *Process vents.* (1) For each process vent that is part of an affected source, the owner or operator must meet the requirements in either paragraph (c)(1)(i) or (c)(1)(ii) of this section except for those process vents exempted under paragraph (c)(2) of this section.

(i) The owner or operator controls air emissions from the process vent in accordance with the standards specified in § 63.690 of this subpart.

(ii) The owner or operator determines before placing off-site material in the process equipment associated with the process vent that the average VOHAP concentration of the off-site material is less than ppmw at the point-of-delivery. The owner or operator must perform an initial determination of the average VOHAP concentration of the off-site material using the procedures specified in § 63.694(b) of this subpart before any portion of the off-site material stream is placed in the unit. Thereafter, the owner or operator must review and update, as necessary, this determination at least once every calendar year following the date of the initial determination for the off-site material stream.

(2) A process vent is exempted from the requirements of paragraph (c)(1) of this section when the owner or operator meets one of the exemptions provided in paragraphs (c)(2)(i) through (c)(2)(iii) of this section.

(i) A process vent is exempted from the requirements in paragraph (c)(1) of this section if the process vent is also subject to another subpart under part 63 or 40 CFR part 61, and the owner or operator is controlling the HAP listed in Table 1 of this subpart that are emitted from the process vent in compliance with the provisions specified in the other applicable subpart under part 61 or part 63.

(ii) A process vent is exempted from the requirements specified in paragraph (c)(1) of this section if the owner or operator determines that the process vent stream flow rate is less than 0.005 cubic meters per minute (m^3/min) at standard conditions (as defined in 40 CFR 63.2). The process vent stream flow rate shall be determined in accordance with the procedures specified in § 63.694(m) of this subpart. Documentation must be prepared by the owner or operator and maintained at the plant site to support the determination of the process vent stream flow rate. This documentation must include identification of each process vent exempted under this paragraph and the test results used to determine the process vent stream flow rate.

(iii) A process vent is exempted from the requirements specified in paragraph (c)(1) of this section if the owner or operator determines that the process vent stream flow rate is less than $6.0 \text{ m}^3/\text{min}$ at standard conditions (as defined in 40 CFR 63.2) and the total HAP concentration is less than 20 ppmv. The process vent stream flow rate and total HAP concentration shall be determined in accordance with the procedures specified in § 63.694(m) of this subpart. Documentation must be prepared by the owner or operator and maintained at the plant site to support the determination of the process vent stream flow rate and total HAP concentration. This documentation must include identification of each process vent exempted under this paragraph (c)(2)(iii) and the test results used to determine the process vent stream flow rate and total HAP concentration. The owner or operator must perform a new determination of the process vent stream flow rate and total HAP concentration when the extent of changes to operation of the unit on which the process vent is used could cause either the process vent stream flow rate to exceed the limit of $6.0 \text{ m}^3/\text{min}$ or the total HAP concentration to exceed the limit of 20 ppmv.

(d) *Equipment leaks.* The owner or operator must control equipment leaks from each equipment component that is part of the affected source specified in § 63.680(c)(3) of this subpart by implementing leak detection and control measures in accordance with the standards specified in § 63.691 of this subpart.

[64 FR 38965, July 20, 1999]

§ 63.684 Standards: Off-site material treatment.

(a) The provisions of this section apply to the treatment of off-site material to remove or destroy HAP for which § 63.683(b)(1)(ii) of this subpart references the requirements of this section for such treatment.

(b) The owner or operator shall remove or destroy the HAP contained in off-site material streams to be managed in the off-site material management unit in accordance with § 63.683(b)(1)(ii) of this subpart using a treatment process that continuously achieves, under normal operations, one or more of the performance levels specified in paragraphs (b)(1) through (b)(5) of this section (as applicable to the type of treatment process) for the range of off-site material stream compositions and quantities expected to be treated.

(1) *VOHAP concentration.* The treatment process shall reduce the VOHAP concentration of the off-site material using a means, other than by dilution, to achieve one of the following performance levels, as applicable:

(i) In the case when every off-site material stream entering the treatment process has an average VOHAP concentration equal to or greater than 500 ppmw at the point-of-delivery, then the VOHAP concentration of the off-site material shall be reduced to a level that is less than 500 ppmw at the point-of-treatment.

(ii) In the case when off-site material streams entering the treatment process are a mixture of off-site material streams having an average VOHAP concentration equal to or greater than 500 ppmw at the point-of-delivery with off-site material streams having average VOHAP concentrations less than 500 ppmw at the point-of-delivery, then the VOHAP concentration of the off-site material must be reduced to a level at the point-of-treatment that meets the performance level specified in either paragraph (b)(1)(ii)(A) or (B) of this section.

(A) Less than the VOHAP concentration limit (C_R) established for the treatment process using the procedure specified in § 63.694(d); or

(B) Less than the lowest VOHAP concentration determined for each of the off-site material streams entering the treatment process as determined by the VOHAP concentration of the off-site material at the point-of-delivery.

(2) *HAP mass removal.* The treatment process shall achieve a performance level such that the total quantity of HAP actually removed from the off-site material stream (MR) is equal to or greater than the required mass removal (RMR) established for the off-site material stream using the procedure specified in § 63.694(e) of this subpart. The MR for the off-site material streams shall be determined using the procedures specified in § 63.694(f) of this subpart.

(3) *HAP reduction efficiency.* For any treatment process except a treatment process that uses biological degradation and is performed in an open tank or surface impoundment, the treatment process must achieve the applicable performance level specified in either paragraph (b)(3)(i) or (b)(3)(ii) of this section.

(i) In the case when the owner or operator determines that off-site material stream entering the treatment process has an average VOHAP concentration less than 10,000 ppmw at the point-of-delivery, then the treatment process shall achieve a performance level such that the total quantity of HAP in the off-site material stream is reduced by 95 percent or more. The HAP reduction efficiency (R) for the treatment process shall be determined using the procedure specified in § 63.694(g) of this subpart. The average VOHAP concentration of the off-site material stream at the point-of-delivery shall be determined using the procedure specified in § 63.694(b) of this subpart.

(ii) In the case when the off-site material stream entering the treatment process has an average VOHAP concentration equal to or greater than 10,000 ppmw at the point-of-delivery, then the

treatment process shall achieve a performance level such that the total quantity of HAP in the off-site material stream is reduced by 95 percent or more, and the average VOHAP concentration of the off-site material at the point-of-treatment is less than 100 parts per million by weight (ppmw). The HAP reduction efficiency (R) for the treatment process shall be determined using the procedure specified in § 63.694(g) of this subpart. The average VOHAP concentration of the off-site material stream at the point-of-treatment shall be determined using the procedure specified in § 63.694(c) of this subpart.

(4) *Biological degradation performed in an open tank or surface impoundment.* A treatment process using biological degradation and performed in an open tank or surface impoundment must achieve the performance level specified in either paragraph (b)(4)(i) or (b)(4)(ii) of this section.

(i) The HAP reduction efficiency (R) for the treatment process is equal to or greater than 95 percent, and the HAP biodegradation efficiency (R_{bio}) for the treatment process is equal to or greater than 95 percent. The HAP reduction efficiency (R) shall be determined using the procedure specified in § 63.694(g) of this subpart. The HAP biodegradation efficiency (R_{bio}) shall be determined in accordance with the requirements of § 63.694(h) of this subpart.

(ii) The total quantity of HAP actually removed from the off-site material stream by biological degradation (MR_{bio}) shall be equal to or greater than the required mass removal (RMR) established for the off-site material stream using the procedure specified in § 63.694(e) of this subpart. The MR_{bio} of the off-site material stream shall be determined using the procedures specified in § 63.694(i) of this subpart.

(5) *Incineration.* The treatment process must destroy the HAP contained in the off-site material stream using one of the combustion devices specified in paragraphs (b)(5)(i) through (b)(5)(iv) of this section.

(i) An incinerator for which the owner or operator has been issued a final permit under 40 CFR part 270, and the incinerator is designed and operated in accordance with the requirements of 40 CFR part 264, subpart O—Incinerators, or

(ii) An incinerator for which the owner or operator has certified compliance with the interim status requirements of 40 CFR part 265, subpart O—Incinerators.

(iii) A boiler or industrial furnace for which the owner or operator has been issued a final permit under 40 CFR part 270, and the combustion unit is designed and operated in accordance with the requirements of 40 CFR part 266, subpart H—Hazardous Waste Burned in Boilers and Industrial Furnaces.

(iv) A boiler or industrial furnace for which the owner or operator has certified compliance with the interim status requirements of 40 CFR part 266, subpart H Hazardous Waste Burned in Boilers and Industrial Furnaces.

(c) For a treatment process that removes the HAP from the off-site material by a means other than thermal destruction or biological degradation to achieve one of the performances levels specified in paragraph (b)(1), (b)(2), or (b)(3) of this section, the owner or operator shall manage the HAP removed from the off-site material in such a manner to minimize release of these HAP to the atmosphere, to the extent practical. Examples of HAP emission control measures that meet the requirements of this paragraph include managing the HAP removed from the off-site material in units that use air emission controls in accordance with the standards specified in §§ 63.685 through 63.689 of this subpart, as applicable to the unit.

(d) When the owner or operator treats the off-site material to meet one of the performance levels specified in paragraphs (b)(1) through (b)(4) of this section, the owner or operator shall demonstrate that the treatment process achieves the selected performance level for the range of expected off-site material stream compositions expected to be treated. An initial demonstration shall be performed as soon as possible but no later than 30 days after first time an owner or operator begins using the treatment process to manage off-site material streams in accordance with the requirements of either § 63.683(b)(1)(ii) or § 63.683(b)(2)(ii) of this subpart as applicable to the affected off-site material

management unit or process equipment. Thereafter, the owner or operator shall review and update, as necessary, this demonstration at least once every calendar year following the date of the initial demonstration.

(e) When the owner or operator treats the off-site material to meet one of the performance levels specified in paragraphs (b)(1) through (b)(4) of this section, the owner or operator shall ensure that the treatment process is achieving the applicable performance requirements by continuously monitoring the operation of the process when it is used to treat off-site material by complying with paragraphs (e) (1) through (e)(3) or, for biological treatment units, paragraph (e)(4) of this section:

(1) A continuous monitoring system shall be installed and operated for each treatment that measures operating parameters appropriate for the treatment process technology. This system shall include a continuous recorder that records the measured values of the selected operating parameters. The monitoring equipment shall be installed, calibrated, and maintained in accordance with the equipment manufacturer's specifications. The continuous recorder shall be a data recording device that is capable of recording either an instantaneous data value at least once every 15 minutes or an average value for intervals of 15 minutes or less.

(2) For each monitored operating parameter, the owner or operator shall establish a minimum operating parameter value or a maximum operating parameter value, as appropriate, to define the range of conditions at which the treatment process must be operated to continuously achieve the applicable performance requirements of this section.

(3) When the treatment process is operating to treat off-site material, the owner or operator shall inspect the data recorded by the continuous monitoring system on a routine basis and operate the treatment process such that the actual value of each monitored operating parameter is greater than the minimum operating parameter value or less than the maximum operating parameter value, as appropriate, established for the treatment process.

(4) When the treatment process is a biological treatment process that is complying with paragraph (b)(4) of this section, the owner or operator must establish and implement a written procedure to monitor the appropriate parameters that demonstrate proper operation of the biological treatment unit in accordance with the evaluation required in § 63.694(h) of this subpart. The written procedure must list the operating parameters that will be monitored and state the frequency of monitoring to ensure that the biological treatment unit is operating between the minimum operating parameter values and maximum operating parameter values to establish that the biological treatment unit is continuously achieving the performance requirement.

(f) The owner or operator must maintain records for each treatment process in accordance with the requirements of § 63.696(a) of this subpart.

(g) The owner or operator must prepare and submit reports for each treatment process in accordance with the requirements of § 63.697(a) of this subpart.

(h) The Administrator may at any time conduct or request that the owner or operator conduct testing necessary to demonstrate that a treatment process is achieving the applicable performance requirements of this section. The testing shall be conducted in accordance with the applicable requirements of this section. The Administrator may elect to have an authorized representative observe testing conducted by the owner or operator.

[61 FR 34158, July 1, 1996, as amended at 64 FR 38967, July 20, 1999; 66 FR 1266, Jan. 8, 2001; 68 FR 37351, June 23, 2003]

§ 63.685 Standards: Tanks.

(a) The provisions of this section apply to the control of air emissions from tanks for which § 63.683(b)(1)(i) of this subpart references the use of this section for such air emission control.

(b) The owner or operator shall control air emissions from each tank subject to this section in accordance with the following applicable requirements:

(1) For a tank that is part of an existing affected source but the tank is not used to manage off-site material having a maximum HAP vapor pressure kilopascal (kPa) that is equal to or greater than 76.6 kPa nor is the tank used for a waste stabilization process as defined in § 63.681 of this subpart, the owner or operator shall determine whether the tank is required to use either Tank Level 1 controls or Tank Level 2 controls as specified for the tank by Table 3 of this subpart based on the off-site material maximum HAP vapor pressure and the tank's design capacity. The owner or operator shall control air emissions from a tank required by Table 3 to use Tank Level 1 controls in accordance with the requirements of paragraph (c) of this section. The owner or operator shall control air emissions from a tank required by Table 3 to use Tank Level 2 controls in accordance with the requirements of paragraph (d) of this section.

(2) For a tank that is part of a new affected source but the tank is not used to manage off-site material having a maximum HAP vapor pressure that is equal to or greater than 76.6 kPa nor is the tank used for a waste stabilization process as defined in § 63.681 of this subpart, the owner or operator shall determine whether the tank is required to use either Tank Level 1 controls or Tank Level 2 controls as specified for the tank by Table 4 of this subpart based on the off-site material maximum HAP vapor pressure and the tank's design capacity. The owner or operator shall control air emissions from a tank required by Table 4 to use Tank Level 1 controls in accordance with the requirements of paragraph (c) of this section. The owner or operator shall control air emissions from a tank required by Table 4 to use Tank Level 2 controls in accordance with the requirements of paragraph (d) of this section.

(3) For a tank that is used for a waste stabilization process, the owner or operator shall control air emissions from the tank by using Tank Level 2 controls in accordance with the requirements of paragraph (d) of this section.

(4) For a tank that manages off-site material having a maximum HAP vapor pressure that is equal to or greater than 76.6 kPa, the owner or operator must control air emissions by using one of the tanks specified in paragraphs (b)(4)(i) through (b)(4)(iii) of this section.

(i) A tank vented through a closed-vent system to a control device in accordance with the requirements specified in paragraph (g) of this section;

(ii) A pressure tank designed and operated in accordance with the requirements specified in paragraph (h) of this section; or

(iii) A tank located inside an enclosure that is vented through a closed-vent system to an enclosed combustion control device in accordance with the requirements specified in paragraph (i) of this section.

(c) Owners and operators controlling air emissions from a tank using Tank Level 1 controls shall meet the following requirements:

(1) The owner or operator shall determine the maximum HAP vapor pressure for an off-site material to be managed in the tank using Tank Level 1 controls before the first time the off-site material is placed in the tank. The maximum HAP vapor pressure shall be determined using the procedures specified in § 63.694(j) of this subpart. Thereafter, the owner or operator shall perform a new determination whenever changes to the off-site material managed in the tank could potentially cause the maximum HAP vapor pressure to increase to a level that is equal to or greater than the maximum HAP vapor pressure limit for the tank design capacity category specified in Table 3 or Table 4 of this subpart, as applicable to the tank.

(2) The owner or operator must control air emissions from the tank in accordance with the requirements in either paragraph (c)(2)(i), (c)(2)(ii), or (c)(2)(iii) of this section, as applicable to the tank.

(i) The owner or operator controls air emissions from the tank in accordance with the provisions specified in subpart 00 of 40 CFR part 63—National Emission Standards for Tanks—Level 1.

(ii) As an alternative to meeting the requirements in paragraph (c)(2)(i) of this section, an owner or operator may control air emissions from the tank in accordance with the provisions for Tank Level 2 controls as specified in paragraph (d) of this section.

(iii) As an alternative to meeting the requirements in paragraph (c)(2)(i) of this section when a tank is used as an interim transfer point to transfer off-site material from containers to another off-site material management unit, an owner or operator may control air emissions from the tank in accordance with the requirements in paragraphs (c)(2)(iii)(A) and (c)(2)(iii)(B) of this section. An example of such a tank is an in-ground tank into which organic-contaminated debris is dumped from roll-off boxes or dump trucks, and then this debris is promptly transferred from the tank to a macroencapsulation unit by a backhoe.

(A) During those periods of time when the material transfer activity is occurring, the tank may be operated without a cover.

(B) At all other times, air emissions from the tank must be controlled in accordance with the provisions specified in 40 CFR part 67, subpart 00—National Emission Standards for Tanks—Level 1.

(d) Owners and operators controlling air emissions from a tank using Tank Level 2 controls shall use one of the following tanks:

(1) A fixed-roof tank equipped with an internal floating roof in accordance with the requirements specified in paragraph (e) of this section;

(2) A tank equipped with an external floating roof in accordance with the requirements specified in paragraph (f) of this section;

(3) A tank vented through a closed-vent system to a control device in accordance with the requirements specified in paragraph (g) of this section;

(4) A pressure tank designed and operated in accordance with the requirements specified in paragraph (h) of this section; or

(5) A tank located inside an enclosure that is vented through a closed-vent system to an enclosed combustion control device in accordance with the requirements specified in paragraph (i) of this section.

(e) The owner or operator who elects to control air emissions from a tank using a fixed-roof with an internal floating roof shall meet the requirements specified in paragraphs (e)(1) through (e)(3) of this section.

(1) The tank shall be equipped with a fixed roof and an internal floating roof in accordance with the following requirements:

(i) The internal floating roof shall be designed to float on the liquid surface except when the floating roof must be supported by the leg supports.

(ii) The internal floating roof shall be equipped with a continuous seal between the wall of the tank and the floating roof edge that meets either of the following requirements:

(A) A single continuous seal that is either a liquid-mounted seal or a metallic shoe seal, as defined in § 63.681 of this subpart; or

(B) Two continuous seals mounted one above the other. The lower seal may be a vapor-mounted seal.

(iii) The internal floating roof shall meet the following specifications:

(A) Each opening in a noncontact internal floating roof except for automatic bleeder vents (vacuum breaker vents) and the rim space vents is to provide a projection below the liquid surface.

(B) Each opening in the internal floating roof shall be equipped with a gasketed cover or a gasketed lid except for leg sleeves, automatic bleeder vents, rim space vents, column wells, ladder wells, sample wells, and stub drains.

(C) Each penetration of the internal floating roof for the purpose of sampling shall have a slit fabric cover that covers at least 90 percent of the opening.

(D) Each automatic bleeder vent and rim space vent shall be gasketed.

(E) Each penetration of the internal floating roof that allows for passage of a ladder shall have a gasketed sliding cover.

(F) Each penetration of the internal floating roof that allows for passage of a column supporting the fixed roof shall have a flexible fabric sleeve seal or a gasketed sliding cover.

(2) The owner or operator shall operate the tank in accordance with the following requirements:

(i) When the floating roof is resting on the leg supports, the process of filling, emptying, or refilling shall be continuous and shall be accomplished as soon as practical.

(ii) Automatic bleeder vents are to be set closed at all times when the roof is floating, except when the roof is being floated off or is being landed on the leg supports.

(iii) Prior to filling the tank, each cover, access hatch, gauge float well or lid on any opening in the internal floating roof shall be bolted or fastened closed (i.e., no visible gaps). Rim spaces vents are to be set to open only when the internal floating roof is not floating or when the pressure beneath the rim exceeds the manufacturer's recommended setting.

(3) The owner or operator shall inspect the internal floating roof in accordance with the procedures specified in § 63.695(b) of this subpart.

(f) The owner or operator who elects to control tank emissions by using an external floating roof shall meet the requirements specified in paragraphs (f)(1) through (f)(3) of this section.

(1) The owner or operator shall design the external floating roof in accordance with the following requirements:

(i) The external floating roof shall be designed to float on the liquid surface except when the floating roof must be supported by the leg supports.

(ii) The floating roof shall be equipped with two continuous seals, one above the other, between the wall of the tank and the roof edge. The lower seal is referred to as the primary seal, and the upper seal is referred to as the secondary seal.

(A) The primary seal shall be a liquid-mounted seal or a metallic shoe seal, as defined in § 63.681 of this subpart. The total area of the gaps between the tank wall and the primary seal shall not exceed 212 square centimeters (cm²) per meter of tank diameter, and the width of any portion of these gaps shall not exceed 3.8 centimeters (cm). If a metallic shoe seal is used for the primary seal, the metallic shoe seal shall be designed so that one end extends into the liquid in the tank and the other end extends a vertical distance of at least 61 centimeters (24 inches) above the liquid surface.

(B) The secondary seal shall be mounted above the primary seal and cover the annular space between the floating roof and the wall of the tank. The total area of the gaps between the tank wall and the secondary seal shall not exceed 21.2 square centimeters (cm²) per meter of tank diameter, and the width of any portion of these gaps shall not exceed 1.3 centimeters (cm).

(iii) The external floating roof shall be meet the following specifications:

(A) Except for automatic bleeder vents (vacuum breaker vents) and rim space vents, each opening in a noncontact external floating roof shall provide a projection below the liquid surface.

(B) Except for automatic bleeder vents, rim space vents, roof drains, and leg sleeves, each opening in the roof shall be equipped with a gasketed cover, seal, or lid.

(C) Each access hatch and each gauge float wells shall be equipped with covers designed to be bolted or fastened when the cover is secured in the closed position.

(D) Each automatic bleeder vent and each rim space vents shall be equipped with a gasket.

(E) Each roof drain that empties into the liquid managed in the tank shall be equipped with a slotted membrane fabric cover that covers at least 90 percent of the area of the opening.

(F) Each unslotted and slotted guide pole well shall be equipped with a gasketed sliding cover or a flexible fabric sleeve seal.

(G) Each unslotted guide pole shall be equipped with a gasketed cap on the end of the pole.

(H) Each slotted guide pole shall be equipped with a gasketed float or other device which closes off the surface from the atmosphere.

(I) Each gauge hatch and each sample well shall be equipped with a gasketed cover.

(2) The owner or operator shall operate the tank in accordance with the following requirements:

(i) When the floating roof is resting on the leg supports, the process of filling, emptying, or refilling shall be continuous and shall be accomplished as soon as practical.

(ii) Except for automatic bleeder vents, rim space vents, roof drains, and leg sleeves, each opening in the roof shall be secured and maintained in a closed position at all times except when the closure device must be open for access.

(iii) Covers on each access hatch and each gauge float well shall be bolted or fastened when secured in the closed position.

(iv) Automatic bleeder vents shall be set closed at all times when the roof is floating, except when the roof is being floated off or is being landed on the leg supports.

(v) Rim space vents shall be set to open only at those times that the roof is being floated off the roof leg supports or when the pressure beneath the rim seal exceeds the manufacturer's recommended setting.

(vi) The cap on the end of each unslotted guide pole shall be secured in the closed position at all times except when measuring the level or collecting samples of the liquid in the tank.

(vii) The cover on each gauge hatch or sample well shall be secured in the closed position at all times except when the hatch or well must be opened for access.

(viii) Both the primary seal and the secondary seal shall completely cover the annular space between the external floating roof and the wall of the tank in a continuous fashion except during inspections.

(3) The owner or operator shall inspect the external floating roof in accordance with the procedures specified in § 63.695(b) of this subpart.

(g) The owner or operator who controls tank air emissions by venting to a control device shall meet the requirements specified in paragraphs (g)(1) through (g)(3) of this section.

(1) The tank shall be covered by a fixed roof and vented directly through a closed-vent system to a control device in accordance with the following requirements:

(i) The fixed roof and its closure devices shall be designed to form a continuous barrier over the entire surface area of the liquid in the tank.

(ii) Each opening in the fixed roof not vented to the control device shall be equipped with a closure device. If the pressure in the vapor headspace underneath the fixed roof is less than atmospheric pressure when the control device is operating, the closure devices shall be designed to operate such that when the closure device is secured in the closed position there are no visible cracks, holes, gaps, or other open spaces in the closure device or between the perimeter of the cover opening and the closure device. If the pressure in the vapor headspace underneath the fixed roof is equal to or greater than atmospheric pressure when the control device is operating, the closure device shall be designed to operate with no detectable organic emissions.

(iii) The fixed roof and its closure devices shall be made of suitable materials that will minimize exposure of the off-site material to the atmosphere, to the extent practical, and will maintain the integrity of the equipment throughout its intended service life. Factors to be considered when selecting the materials for and designing the fixed roof and closure devices shall include: organic vapor permeability, the effects of any contact with the liquid and its vapor managed in the tank; the effects of outdoor exposure to wind, moisture, and sunlight; and the operating practices used for the tank on which the fixed roof is installed.

(iv) The closed-vent system and control device shall be designed and operated in accordance with the requirements of § 63.693 of this subpart.

(2) Whenever an off-site material is in the tank, the fixed roof shall be installed with each closure device secured in the closed position and the vapor headspace underneath the fixed roof vented to the control device except as follows:

(i) Venting to the control device is not required, and opening of closure devices or removal of the fixed roof is allowed at the following times:

(A) To provide access to the tank for performing routine inspection, maintenance, or other activities needed for normal operations. Examples of such activities include those times when a worker needs to open a port to sample liquid in the tank, or when a worker needs to open a hatch to maintain or repair equipment. Following completion of the activity, the owner or operator shall promptly secure the closure device in the closed position or reinstall the cover, as applicable, to the tank.

(B) To remove accumulated sludge or other residues from the bottom of the tank.

(ii) Opening of a safety device, as defined in § 63.681 of this subpart, is allowed at any time conditions require it to do so to avoid an unsafe condition.

(3) The owner or operator shall inspect and monitor the air emission control equipment in accordance with the procedures specified in § 63.695 of this subpart.

(h) The owner or operator who elects to control tank air emissions by using a pressure tank shall meet the following requirements.

(1) The tank shall be designed not to vent to the atmosphere as a result of compression of the vapor headspace in the tank during filling of the tank to its design capacity.

(2) All tank openings shall be equipped with closure devices designed to operate with no detectable organic emissions as determined using the procedure specified in § 63.694(k) of this subpart.

(3) Whenever an off-site material is in the tank, the tank shall be operated as a closed system that does not vent to the atmosphere except under either of the following conditions as specified in paragraph (h)(3)(i) or (h)(3)(ii) of this section.

(i) At those times when opening of a safety device, as defined in § 63.681 of this subpart, is required to avoid an unsafe condition.

(ii) At those times when purging of inerts from the tank is required and the purge stream is routed to a closed-vent system and control device designed and operated in accordance with the requirements of § 63.693 of this subpart.

(i) The owner or operator who elects to control air emissions by using an enclosure vented through a closed-vent system to an enclosed combustion control device shall meet the requirements specified in paragraphs (i)(1) through (4) of this section.

(1) The tank shall be located inside an enclosure. The enclosure shall be designed and operated in accordance with the criteria for a permanent total enclosure as specified in "Procedure T—Criteria for and Verification of a Permanent or Temporary Total Enclosure" under 40 CFR 52.741, appendix B. The enclosure may have permanent or temporary openings to allow worker access; passage of material into or out of the enclosure by conveyor, vehicles, or other mechanical means; entry of permanent mechanical or electrical equipment; or to direct airflow into the enclosure. The owner or operator shall perform the verification procedure for the enclosure as specified in Section 5.0 to "Procedure T—Criteria for and Verification of a Permanent or Temporary Total Enclosure" initially when the enclosure is first installed and, thereafter, annually.

(2) The enclosure shall be vented through a closed-vent system to an enclosed combustion control device that is designed and operated in accordance with the standards for either a vapor incinerator, boiler, or process heater specified in § 63.693 of this subpart.

(3) Opening of a safety device, as defined in § 63.681 of this subpart, is allowed at any time conditions require it to do so to avoid an unsafe condition.

(4) The owner or operator shall inspect and monitor the closed-vent system and control device as specified in § 63.693.

[61 FR 34158, July 1, 1996, as amended at 64 FR 38968, July 20, 1999; 66 FR 1266, Jan. 8, 2001]

§ 63.686 Standards: Oil-water and organic-water separators.

(a) The provisions of this section apply to the control of air emissions from oil-water separators and organic-water separators for which § 63.683(b)(1)(i) of this subpart references the use of this section for such air emission control.

(b) The owner or operator shall control air emissions from each separator subject to this section by using one of the following:

(1) A floating roof in accordance with all applicable provisions specified in 40 CFR 63 subpart VV—National Emission Standards for Oil-Water Separators and Organic-Water Separators. For portions of the separator where it is infeasible to install and operate a floating roof, such as over a weir mechanism, the owner or operator shall comply with the requirements specified in paragraph (b)(2) of this section.

(2) A fixed-roof that is vented through a closed-vent system to a control device in accordance with all applicable provisions specified in 40 CFR 63 subpart VV—National Emission Standards for Oil-Water Separators and Organic-Water Separators.

(3) A pressurized separator that operates as a closed system in accordance with all applicable provisions specified in 40 CFR part 63, subpart VV—National Emission Standards for Oil-Water Separators and Organic-Water Separators.

[61 FR 34158, July 1, 1996, as amended at 64 FR 38969, July 20, 1999]

§ 63.687 Standards: Surface impoundments.

(a) The provisions of this section apply to the control of air emissions from surface impoundments for which § 63.683(b)(1)(i) of this subpart references the use of this section for such air emission control.

(b) The owner or operator shall control air emissions from each surface impoundment subject to this section by using one of the following:

(1) A floating membrane cover in accordance with the applicable provisions specified in 40 CFR 63 subpart QQ—National Emission Standards for Surface Impoundments; or

(2) A cover that is vented through a closed-vent system to a control device in accordance with all applicable provisions specified in 40 CFR 63 subpart QQ—National Emission Standards for Surface Impoundments.

[61 FR 34158, July 1, 1996, as amended at 64 FR 38969, July 20, 1999]

§ 63.688 Standards: Containers.

(a) The provisions of this section apply to the control of air emissions from containers for which § 63.683(b)(1)(i) of this subpart references the use of this section for such air emission control.

(b) The owner or operator shall control air emissions from each container subject to this section in accordance with the following requirements, as applicable to the container, except when the special provisions for waste stabilization processes specified in paragraph (c) of this section apply to the container.

(1) For a container having a design capacity greater than 0.1 m³ and less than or equal to 0.46 m³, the owner or operator must control air emissions from the container in accordance with the requirements in either paragraph (b)(1)(i) or (b)(1)(ii) of this section.

(i) The owner or operator controls air emissions from the container in accordance with the standards for Container Level 1 controls as specified in 40 CFR part 63, subpart PP—National Emission Standards for Containers.

(ii) As an alternative to meeting the requirements in paragraph (b)(1)(i) of this section, an owner or operator may choose to control air emissions from the container in accordance with the standards for either Container Level 2 controls or Container Level 3 controls as specified in subpart PP of this part 63—National Emission Standards for Containers.

(2) For a container having a design capacity greater than 0.46 m³ and the container is not in light-material service as defined in § 63.681 of this subpart, the owner or operator must control air emissions from the container in accordance with the requirements in either paragraph (b)(1)(i) or (b)(1)(ii) of this section.

(3) For a container having a design capacity greater than 0.46 m³ and the container is in light-material service as defined in § 63.681 of this subpart, the owner or operator must control air emissions from the container in accordance with the requirements in either paragraph (b)(3)(i) or (b)(3)(ii) of this section.

(i) The owner or operator controls air emissions from the container in accordance with the standards for Container Level 2 controls as specified in 40 CFR part 63, subpart PP—National Emission Standards for Containers.

(ii) As an alternative to meeting the requirements in paragraph (b)(3)(i) of this section, an owner or operator may choose to control air emissions from the container in accordance with the standards for

Container Level 3 controls as specified in 40 CFR part 63, subpart PP—National Emission Standards for Containers.

(c) When a container subject to this subpart and having a design capacity greater than 0.1 m³ is used for treatment of an off-site material by a waste stabilization process as defined in § 63.681 of this subpart, the owner or operator shall control air emissions from the container at those times during the process when the off-site material in the container is exposed to the atmosphere in accordance with the standards for Container Level 3 controls as specified in 40 CFR part 63, subpart PP—National Emission Standards for Containers.

[61 FR 34158, July 1, 1996, as amended at 64 FR 38969, July 20, 1999]

§ 63.689 Standards: Transfer systems.

(a) The provisions of this section apply to the control of air emissions from transfer systems for which § 63.683(b)(1)(i) of this subpart references the use of this section for such air emission control.

(b) For each transfer system that is subject to this section and is an individual drain system, the owner or operator shall control air emissions in accordance with the standards specified in 40 CFR part 63, subpart RR—National Emission Standards for Individual Drain Systems.

(c) For each transfer system that is subject to this section but is not an individual drain system, the owner or operator shall control air emissions by using one of the transfer systems specified in paragraphs (c)(1) through (c)(3) of this section.

(1) A transfer system that uses covers in accordance with the requirements specified in paragraph (d) of this section.

(2) A transfer system that consists of continuous hard-piping. All joints or seams between the pipe sections shall be permanently or semi-permanently sealed (e.g., a welded joint between two sections of metal pipe or a bolted and gasketed flange).

(3) A transfer system that is enclosed and vented through a closed-vent system to a control device in accordance with the requirements specified in paragraphs (c)(3)(i) and (c)(3)(ii) of this section.

(i) The transfer system is designed and operated such that an internal pressure in the vapor headspace in the enclosure is maintained at a level less than atmospheric pressure when the control device is operating, and

(ii) The closed-vent system and control device are designed and operated in accordance with the requirements of § 63.693 of this subpart.

(d) Owners and operators controlling air emissions from a transfer system using covers in accordance with the provisions of paragraph (c)(1) of this section shall meet the requirements specified in paragraphs (d)(1) through (d)(6) of this section.

(1) The cover and its closure devices shall be designed to form a continuous barrier over the entire surface area of the off-site material as it is conveyed by the transfer system except for the openings at the inlet and outlet to the transfer system through which the off-site material passes. The inlet and outlet openings used for passage of the off-site material through the transfer system shall be the minimum size required for practical operation of the transfer system.

(2) The cover shall be installed in a manner such that there are no visible cracks, holes, gaps, or other open spaces between cover section joints or between the interface of the cover edge and its mounting.

(3) Except for the inlet and outlet openings to the transfer system through which the off-site material passes, each opening in the cover shall be equipped with a closure device designed to operate such that when the closure device is secured in the closed position there are no visible cracks,

holes, gaps, or other open spaces in the closure device or between the perimeter of the opening and the closure device.

(4) The cover and its closure devices shall be made of suitable materials that will minimize exposure of the off-site material to the atmosphere, to the extent practical, and will maintain the integrity of the equipment throughout its intended service life. Factors to be considered when selecting the materials for and designing the cover and closure devices shall include: organic vapor permeability; the effects of any contact with the material or its vapors conveyed in the transfer system; the effects of outdoor exposure to wind, moisture, and sunlight; and the operating practices used for the transfer system on which the cover is installed.

(5) Whenever an off-site material is in the transfer system, the cover shall be installed with each closure device secured in the closed position except as specified in paragraph (d)(5)(i) or (d)(5)(ii) of this section.

(i) Opening of closure devices or removal of the cover is allowed to provide access to the transfer system for performing routine inspection, maintenance, repair, or other activities needed for normal operations. Examples of such activities include those times when a worker needs to open a hatch or remove the cover to repair conveyance equipment mounted under the cover or to clear a blockage of material inside the system. Following completion of the activity, the owner or operator shall promptly secure the closure device in the closed position or reinstall the cover, as applicable.

(ii) Opening of a safety device, as defined in § 63.681 of this subpart, is allowed at any time conditions require it to do so to avoid an unsafe condition.

(6) The owner or operator shall inspect the air emission control equipment in accordance with the requirements specified in § 63.695 of this subpart.

[61 FR 34158, July 1, 1996, as amended at 64 FR 38970, July 20, 1999]

§ 63.690 Standards: Process vents.

(a) The provisions of this section apply to the control of air emissions from process vents for which § 63.683(c)(1)(i) of this subpart references the use of this section for such air emission control.

(b) The owner or operator must route the vent stream from each affected process vent through a closed-vent system to a control device that meets the standards specified in § 63.693 of this subpart. For the purpose of complying with this paragraph (b), a primary condenser is not a control device; however, a second condenser or other organic recovery device that is operated downstream of the primary condenser is considered a control device.

[64 FR 38970, July 20, 1999]

§ 63.691 Standards: Equipment leaks.

(a) The provisions of this section apply to the control of air emissions from equipment leaks for which § 63.683(d) references the use of this section for such air emissions control.

(b) The owner or operator shall control the HAP emitted from equipment leaks in accordance with the applicable provisions specified in either paragraph (b)(1) or (b)(2) of this section.

(1) The owner or operator controls the HAP emitted from equipment leaks in accordance with § 61.242 through § 61.247 in 40 CFR part 61, subpart V—National Emission Standards for Equipment Leaks; or

(2) The owner or operator controls the HAP emitted from equipment leaks in accordance with § 63.162 through § 63.182 in subpart H—National Emission Standards for Organic Hazardous Air Pollutants from Equipment Leaks.

[64 FR 38970, July 20, 1999, as amended at 66 FR 1266, Jan. 8, 2001]

§ 63.692 [Reserved]**§ 63.693 Standards: Closed-vent systems and control devices.**

(a) The provisions of this section apply to closed-vent systems and control devices used to control air emissions for which another standard references the use of this section for such air emission control.

(b) For each closed-vent system and control device used to comply with this section, the owner or operator shall meet the following requirements:

(1) The owner or operator must use a closed-vent system that meets the requirements specified in paragraph (c) of this section.

(2) The owner or operator must use a control device that meets the requirements specified in paragraphs (d) through (h) of this section as applicable to the type and design of the control device selected by the owner or operator to comply with the provisions of this section.

(3) Whenever gases or vapors containing HAP are vented through a closed-vent system connected to a control device used to comply with this section, the control device must be operating except at those times listed in either paragraph (b)(3)(i) or (b)(3)(ii) of this section.

(i) The control device may be bypassed for the purpose of performing planned routine maintenance of the closed-vent system or control device in situations when the routine maintenance cannot be performed during periods that the emission point vented to the control device is shutdown. On an annual basis, the total time that the closed-vent system or control device is bypassed to perform routine maintenance shall not exceed 240 hours per each calendar year.

(ii) The control device may be bypassed for the purpose of correcting a malfunction of the closed-vent system or control device. The owner or operator shall perform the adjustments or repairs necessary to correct the malfunction as soon as practicable after the malfunction is detected.

(4) The owner or operator must inspect and monitor each closed-vent system in accordance with the requirements specified in either paragraph (b)(4)(i) or (b)(4)(ii) of this section.

(i) The owner or operator inspects and monitors the closed-vent system in accordance with the requirements specified in § 63.695(c) of this subpart, and complies with the applicable recordkeeping requirements in § 63.696 of this subpart and the applicable reporting requirements in § 63.697 of this subpart.

(ii) As an alternative to meeting the requirements specified in paragraph (b)(4)(i) of this section, the owner or operator may choose to inspect and monitor the closed-vent system in accordance with the requirements under 40 CFR part 63, subpart H—National Emission Standards for Organic Hazardous Air Pollutants for Equipment Leaks as specified in 40 CFR 63.172(f) through (h), and complies with the applicable recordkeeping requirements in 40 CFR 63.181 and the applicable reporting requirements in 40 CFR 63.182.

(5) The owner or operator must monitor the operation of each control device in accordance with the requirements specified in paragraphs (d) through (h) of this section as applicable to the type and design of the control device selected by the owner or operator to comply with the provisions of this section.

(6) The owner or operator shall maintain records for each control device in accordance with the requirements of § 63.696 of this subpart.

(7) The owner or operator shall prepare and submit reports for each control device in accordance with the requirements of § 63.697 of this subpart.

(8) In the case when an owner or operator chooses to use a design analysis to demonstrate compliance of a control device with the applicable performance requirements specified in this section

as provided for in paragraphs (d) through (g) of this section, the Administrator may request that the design analysis be revised or amended by the owner or operator to correct any deficiencies identified by the Administrator. If the owner or operator and the Administrator do not agree on the acceptability of using the design analysis (including any changes requested by the Administrator) to demonstrate that the control device achieves the applicable performance requirements, then the disagreement must be resolved using the results of a performance test conducted by the owner or operator in accordance with the requirements of § 63.694(l) of this subpart. The Administrator may choose to have an authorized representative observe the performance test conducted by the owner or operator. Should the results of this performance test not agree with the determination of control device performance based on the design analysis, then the results of the performance test will be used to establish compliance with this subpart.

(c) Closed-vent system requirements.

(1) The vent stream required to be controlled shall be conveyed to the control device by either of the following closed-vent systems:

(i) A closed-vent system that is designed to operate with no detectable organic emissions using the procedure specified in § 63.694(k) of this subpart; or

(ii) A closed-vent system that is designed to operate at a pressure below atmospheric pressure. The system shall be equipped with at least one pressure gage or other pressure measurement device that can be read from a readily accessible location to verify that negative pressure is being maintained in the closed-vent system when the control device is operating.

(2) In situations when the closed-vent system includes bypass devices that could be used to divert a vent stream from the closed-vent system to the atmosphere at a point upstream of the control device inlet, each bypass device must be equipped with either a flow indicator as specified in paragraph (c)(2)(i) of this section or a seal or locking device as specified in paragraph (c)(2)(ii) of this section. For the purpose of complying with this paragraph (c)(2), low leg drains, high point bleeds, analyzer vents, open-ended valves or lines, or pressure relief valves needed for safety reasons are not subject to the requirements of this paragraph (c)(2).

(i) If a flow indicator is used, the indicator must be installed at the entrance to the bypass line used to divert the vent stream from the closed-vent system to the atmosphere. The flow indicator must indicate a reading at least once every 15 minutes. The owner or operator must maintain records of the following information: hourly records of whether the flow indicator was operating and whether flow was detected at any time during the hour; and records of all periods when flow is detected or the flow indicator is not operating.

(ii) If a seal or locking device is used to comply with paragraph (c)(2) of this section, the device shall be placed on the mechanism by which the bypass device position is controlled (e.g., valve handle, damper lever) when the bypass device is in the closed position such that the bypass device cannot be opened without breaking the seal or removing the lock. Examples of such devices include, but are not limited to, a car-seal or a lock-and-key configuration valve.

(d) Carbon adsorption control device requirements.

(1) The carbon adsorption system must achieve the performance specifications in either paragraph (d)(1)(i) or (d)(1)(ii) of this section.

(i) Recover 95 percent or more, on a weight-basis, of the total organic compounds (TOC), less methane and ethane, contained in the vent stream entering the carbon adsorption system; or

(ii) Recover 95 percent or more, on a weight-basis, of the total HAP listed in Table 1 of this subpart contained in the vent stream entering the carbon adsorption system.

(2) The owner or operator must demonstrate that the carbon adsorption system achieves the performance requirements in paragraph (d)(1) of this section by either performing a performance test

as specified in paragraph (d)(2)(i) of this section or a design analysis as specified in paragraph (d)(2)(ii) of this section.

(i) An owner or operator choosing to use a performance test to demonstrate compliance must conduct the test in accordance with the requirements of § 63.694(l) of this subpart.

(ii) An owner or operator choosing to use a design analysis to demonstrate compliance must include as part of this design analysis the information specified in either paragraph (d)(2)(ii)(A) or (d)(2)(ii)(B) of this section as applicable to the carbon adsorption system design.

(A) For a regenerable carbon adsorption system, the design analysis shall address the vent stream composition, constituent concentrations, flow rate, relative humidity, and temperature and shall establish the design exhaust vent stream organic compound concentration, adsorption cycle time, number and capacity of carbon beds, type and working capacity of activated carbon used for carbon beds, design total regeneration steam flow over the period of each complete carbon bed regeneration cycle, design carbon bed temperature after regeneration, design carbon bed regeneration time, and design service life of the carbon.

(B) For a nonregenerable carbon adsorption system (e.g., a carbon canister), the design analysis shall address the vent stream composition, constituent concentrations, flow rate, relative humidity, and temperature and shall establish the design exhaust vent stream organic compound concentration, carbon bed capacity, activated carbon type and working capacity, and design carbon replacement interval based on the total carbon working capacity of the control device and emission point operating schedule.

(3) The owner or operator must monitor the operation of the carbon adsorption system in accordance with the requirements of § 63.695(e) using one of the continuous monitoring systems specified in paragraphs (d)(3)(i) through (iii) of this section. Monitoring the operation of a nonregenerable carbon adsorption system (e.g., a carbon canister) using a continuous monitoring system is not required when the carbon canister or the carbon in the control device is replaced on a regular basis according to the requirements in paragraph (d)(4)(iii) of this section.

(i) For a regenerative-type carbon adsorption system:

(A) A continuous parameter monitoring system to measure and record the average total regeneration stream mass flow or volumetric flow during each carbon bed regeneration cycle. The integrating regenerating stream flow monitoring device must have an accuracy of ± 10 percent; and

(B) A continuous parameter monitoring system to measure and record the average carbon bed temperature for the duration of the carbon bed steaming cycle and to measure the actual carbon bed temperature after regeneration and within 15 minutes of completing the cooling cycle. The accuracy of the temperature monitoring device must be ± 1 percent of the temperature being measured, expressed in degrees Celsius or ± 5 °C, whichever is greater.

(ii) A continuous monitoring system to measure and record the daily average concentration level of organic compounds in the exhaust gas stream from the control device. The organic monitoring system must comply either with Performance Specification 8 or 9 in 40 CFR part 60, appendix B. The relative accuracy provision of Performance Specification 8, Sections 2.4 and 3 need not be conducted.

(iii) A continuous monitoring system that measures other alternative operating parameters upon approval of the Administrator as specified in 40 CFR 63.8(f)(1) through (f)(5) of this part.

(4) The owner or operator shall manage the carbon used for the carbon adsorption system, as follows:

(i) Following the initial startup of the control device, all carbon in the control device shall be replaced with fresh carbon on a regular, predetermined time interval that is no longer than the carbon service life established for the carbon adsorption system. The provisions of this paragraph (d)(4)(i) do not apply to a nonregenerable carbon adsorption system (e.g., a carbon canister) for which the

carbon canister or the carbon in the control device is replaced on a regular basis according to the requirements in paragraph (d)(4)(iii) of this section.

(ii) The spent carbon removed from the carbon adsorption system must be either regenerated, reactivated, or burned in one of the units specified in paragraphs (d)(4)(ii)(A) through (d)(4)(ii)(G) of this section.

(A) Regenerated or reactivated in a thermal treatment unit for which the owner or operator has been issued a final permit under 40 CFR part 270 that implements the requirements of 40 CFR part 264, subpart X.

(B) Regenerated or reactivated in a thermal treatment unit equipped with and operating air emission controls in accordance with this section.

(C) Regenerated or reactivated in a thermal treatment unit equipped with and operating organic air emission controls in accordance with a national emission standard for hazardous air pollutants under another subpart in 40 CFR part 63 or 40 CFR part 61.

(D) Burned in a hazardous waste incinerator for which the owner or operator has been issued a final permit under 40 CFR part 270 that implements the requirements of 40 CFR part 264, subpart O.

(E) Burned in a hazardous waste incinerator for which the owner or operator has designed and operates the incinerator in accordance with the interim status requirements of 40 CFR part 265, subpart O.

(F) Burned in a boiler or industrial furnace for which the owner or operator has been issued a final permit under 40 CFR part 270 that implements the requirements of 40 CFR part 266, subpart H.

(G) Burned in a boiler or industrial furnace for which the owner or operator has designed and operates the unit in accordance with the interim status requirements of 40 CFR part 266, subpart H.

(iii) As an alternative to meeting the requirements in paragraphs (d)(3) and (d)(4)(i) of this section, an owner or operator of a nonregenerable carbon adsorption system may choose to replace on a regular basis the carbon canister or the carbon in the control device using the procedures in either paragraph (d)(4)(iii)(A) or (d)(4)(iii)(B) of this section. For the purpose of complying with this paragraph (d)(4)(iii), a nonregenerable carbon adsorption system means a carbon adsorption system that does not regenerate the carbon bed directly onsite in the control device, such as a carbon canister. The spent carbon removed from the nonregenerable carbon adsorption system must be managed according to the requirements in paragraph (d)(4)(ii) of this section.

(A) Monitor the concentration level of the organic compounds in the exhaust vent from the carbon adsorption system on a regular schedule, and when carbon breakthrough is indicated, immediately replace either the existing carbon canister with a new carbon canister or replace the existing carbon in the control device with fresh carbon. Measurement of the concentration level of the organic compounds in the exhaust vent stream must be made with a detection instrument that is appropriate for the composition of organic constituents in the vent stream and is routinely calibrated to measure the organic concentration level expected to occur at breakthrough. The monitoring frequency must be daily or at an interval no greater than 20 percent of the time required to consume the total carbon working capacity established as a requirement of paragraph (d)(2)(ii)(B) of this section, whichever is longer.

(B) Replace either the existing carbon canister with a new carbon canister or replace the existing carbon in the control device with fresh carbon at a regular, predetermined time interval that is less than the design carbon replacement interval established as a requirement of paragraph (d)(2)(ii)(B) of this section.

(e) Condenser control device requirements.

(1) The condenser must achieve the performance specifications in either paragraph (e)(1)(i) or (e)(1)(ii) of this section.

(i) Recover 95 percent or more, on a weight-basis, of the total organic compounds (TOC), less methane and ethane, contained in the vent stream entering the condenser; or

(ii) Recover 95 percent or more, on a weight-basis, of the total HAP, listed in Table 1 of this subpart, contained in the vent stream entering the condenser.

(2) The owner or operator must demonstrate that the condenser achieves the performance requirements in paragraph (e)(1) of this section by either performing a performance test as specified in paragraph (e)(2)(i) of this section or a design analysis as specified in paragraph (e)(2)(ii) of this section.

(i) An owner or operator choosing to use a performance tests to demonstrate compliance must conduct the test in accordance with the requirements of § 63.694(l) of this subpart.

(ii) An owner or operator choosing to use a design analysis to demonstrate compliance must include as part of this design analysis the following information: description of the vent stream composition, constituent concentrations, flow rate, relative humidity, and temperature; and specification of the design outlet organic compound concentration level, design average temperature of the condenser exhaust vent stream, and the design average temperatures of the coolant fluid at the condenser inlet and outlet.

(3) The owner or operator must monitor the operation of the condenser in accordance with the requirements of § 63.695(e) of this subpart using one of the continuous monitoring systems specified in paragraphs (e)(3)(i) through (e)(3)(iii) of this section.

(i) A continuous parameter monitoring system to measure and record the daily average temperature of the exhaust gases from the control device. The accuracy of the temperature monitoring device shall be ± 1 percent of the temperature being measured, expressed in degrees Celsius or ± 5 ° C, whichever is greater.

(ii) A continuous monitoring system to measure and record the daily average concentration level of organic compounds in the exhaust gas stream from the control device. The organic monitoring system must comply either with Performance Specification 8 or 9 in 40 CFR part 60, appendix B. The relative accuracy provision of Performance Specification 8, Sections 2.4 and 3 need not be conducted.

(iii) A continuous monitoring system that measures other alternative operating parameters upon approval of the Administrator as specified in 40 CFR 63.8(f)(1) through (f)(5) of this part.

(f) Vapor incinerator control device requirements.

(1) The vapor incinerator must achieve the performance specifications in either paragraph (f)(1)(i), (f)(1)(ii), or (f)(1)(iii) of this section.

(i) Destroy the total organic compounds (TOC), less methane and ethane, contained in the vent stream entering the vapor incinerator either:

(A) By 95 percent or more, on a weight-basis, or

(B) To achieve a total incinerator outlet concentration for the TOC, less methane and ethane, of less than or equal to ppmv on a dry basis corrected to 3 percent oxygen.

(ii) Destroy the HAP listed in Table 1 of this subpart contained in the vent stream entering the vapor incinerator either:

(A) By 95 percent or more, on a total HAP weight-basis, or

(B) To achieve a total incinerator outlet concentration for the HAP, listed in Table 1 of this subpart, of less than or equal to ppmv on a dry basis corrected to 3 percent oxygen.

(iii) Maintain the conditions in the vapor incinerator combustion chamber at a residence time of 0.5 seconds or longer and at a temperature of 760°C or higher.

(2) The owner or operator must demonstrate that the vapor incinerator achieves the performance requirements in paragraph (f)(1) of this section by either performing a performance test as specified in paragraph (f)(2)(i) of this section or a design analysis as specified in paragraph (f)(2)(ii) of this section.

(i) An owner or operator choosing to use a performance test to demonstrate compliance must conduct the test in accordance with the requirements of § 63.694(l) of this subpart.

(ii) An owner or operator choosing to use a design analysis to demonstrate compliance must include as part of this design analysis the information specified in either paragraph (f)(2)(ii)(A) or (f)(2)(ii)(B) of this section as applicable to the vapor incinerator design.

(A) For a thermal vapor incinerator, the design analysis shall address the vent stream composition, constituent concentrations, and flow rate and shall establish the design minimum and average temperatures in the combustion chamber and the combustion chamber residence time.

(B) For a catalytic vapor incinerator, the design analysis shall address the vent stream composition, constituent concentrations, and flow rate and shall establish the design minimum and average temperatures across the catalyst bed inlet and outlet, and the design service life of the catalyst.

(3) The owner or operator must monitor the operation of the vapor incinerator in accordance with the requirements of § 63.695(e) of this subpart using one of the continuous monitoring systems specified in paragraphs (f)(3)(i) through (f)(3)(iv) of this section as applicable to the type of vapor incinerator used.

(i) For a thermal vapor incinerator, a continuous parameter monitoring system to measure and record the daily average temperature of the exhaust gases from the control device. The accuracy of the temperature monitoring device must be ± 1 percent of the temperature being measured, expressed in degrees Celsius of ± 0.5 °C, whichever is greater.

(ii) For a catalytic vapor incinerator, a temperature monitoring device capable of monitoring temperature at two locations equipped with a continuous recorder. One temperature sensor shall be installed in the vent stream at the nearest feasible point to the catalyst bed inlet and a second temperature sensor shall be installed in the vent stream at the nearest feasible point to the catalyst bed outlet.

(iii) For either type of vapor incinerator, a continuous monitoring system to measure and record the daily average concentration of organic compounds in the exhaust vent stream from the control device. The organic monitoring system must comply either with Performance Specification 8 or 9 in 40 CFR part 60, appendix B. The relative accuracy provision of Performance Specification 8, Sections 2.4 and 3 need not be conducted.

(iv) For either type of vapor incinerator, a continuous monitoring system that measures alternative operating parameters other than those specified in paragraph (f)(3)(i) or (f)(3)(ii) of this section upon approval of the Administrator as specified in 40 CFR 63.8(f)(1) through (f)(5) of this part.

(g) Boilers and process heaters control device requirements.

(1) The boiler or process heater must achieve the performance specifications in either paragraph (g)(1)(i), (g)(1)(ii), (g)(1)(iii), (g)(1)(iv), or (g)(1)(v) of this section.

(i) Destroy the total organic compounds (TOC), less methane and ethane, contained in the vent stream introduced into the flame zone of the boiler or process heater either:

(A) By 95 percent or more, on a weight-basis, or

(B) To achieve in the exhausted combustion gases a total concentration for the TOC, less methane and ethane, of less than or equal to 20 parts ppmv on a dry basis corrected to 3 percent oxygen.

(ii) Destroy the HAP listed in Table 1 of this subpart contained in the vent stream entering the vapor incinerator either:

(A) By 95 percent or more, on a total HAP weight-basis, or

(B) To achieve in the exhausted combustion gases a total concentration for the HAP, listed in Table 1 of the subpart, of less than or equal to 20 ppmv on a dry basis corrected to 3 percent oxygen.

(iii) Introduce the vent stream into the flame zone of the boiler or process heater and maintain the conditions in the combustion chamber at a residence time of 0.5 seconds or longer and at a temperature of 760°C or higher.

(iv) Introduce the vent stream with the fuel that provides the predominate heat input to the boiler or process heater (i.e., the primary fuel); or

(v) Introduce the vent stream to a boiler or process heater for which the owner or operator either has been issued a final permit under 40 CFR part 270 and complies with the requirements of 40 CFR part 266, subpart H of this chapter; or has certified compliance with the interim status requirements of 40 CFR part 266, subpart H of this chapter.

(2) The owner or operator must demonstrate that the boiler or process heater achieves the performance specifications in paragraph (g)(1) of this section chosen by the owner or operator using the applicable method specified in paragraph (g)(2)(i) or (g)(2)(ii) of this section.

(i) If an owner or operator chooses to comply with the performance specifications in either paragraph (g)(1)(i), (g)(1)(ii), or (g)(1)(iii) of this section, the owner or operator must demonstrate compliance with the applicable performance specifications by either performing a performance test as specified in paragraph (g)(2)(i)(A) of this section or a design analysis as specified in paragraph (g)(2)(i)(B) of this section.

(A) An owner or operator choosing to use a performance test to demonstrate compliance must conduct the test in accordance with the requirements of § 63.694(l) of this subpart.

(B) An owner or operator choosing to use a design analysis to demonstrate compliance must include as part of this design analysis the following information: description of the vent stream composition, constituent concentrations, and flow rate; specification of the design minimum and average flame zone temperatures and combustion zone residence time; and description of the method and location by which the vent stream is introduced into the flame zone.

(ii) If an owner or operator chooses to comply with the performance specifications in either paragraph (g)(1)(iv) or (g)(1)(v) of this section, the owner or operator must demonstrate compliance by maintaining the records that document that the boiler or process heater is designed and operated in accordance with the applicable requirements of this section.

(3) For a boiler or process heater complying with the performance specifications in either paragraph (g)(1)(i), (g)(1)(ii), or (g)(1)(iii) of this section, the owner or operator must monitor the operation of a boiler or process heater in accordance with the requirements of § 63.695(e) of this subpart using one of the continuous monitoring systems specified in paragraphs (g)(3)(i) through (g)(3)(iii) of this section.

(i) A continuous parameter monitoring system to measure and record the daily average combustion zone temperature. The accuracy of the temperature sensor must be ± 1 percent of the temperature being measured, expressed in degrees Celsius or ± 0.5 °C, whichever is greater;

(ii) A continuous monitoring system to measure and record the daily average concentration of organic compounds in the exhaust vent stream from the control device. The organic monitoring system must comply either with Performance Specification 8 or 9 in 40 CFR part 60, appendix B. The relative accuracy provision of Performance Specification 8, Sections 2.4 and 3 need not be conducted.

(iii) A continuous monitoring system that measures alternative operating parameters other than those specified in paragraph (g)(3)(i) or (g)(3)(ii) of this section upon approval of the Administrator as specified in 40 CFR 63.8(f)(1) through (f)(5) of this part.

(h) Flare control device requirements.

(1) The flare must be designed and operated in accordance with the requirements in 40 CFR 63.11(b).

(2) The owner or operator must demonstrate that the flare achieves the requirements in paragraph (h)(1) of this section by performing the procedures specified in paragraph (h)(2)(i) of this section. A previous compliance demonstration for the flare that meets all of the conditions specified in paragraph (h)(2)(ii) of this section may be used by an owner or operator to demonstrate compliance with this paragraph (h)(2).

(i) To demonstrate that a flare achieves the requirements in paragraph (h)(1) of this section, the owner or operator performs all of the procedures specified in paragraphs (h)(2)(i)(A) through (h)(2)(i)(C) of this section.

(A) The owner or operator conducts a visible emission test for the flare in accordance with the requirements specified in 40 CFR 63.11(b)(4).

(B) The owner or operator determines the net heating value of the gas being combusted in the flare in accordance with the requirements specified in 40 CFR 63.11(b)(6); and

(C) The owner or operator determines the flare exit velocity in accordance with the requirements applicable to the flare design as specified in 40 CFR 63.11(b)(7) or 40 CFR 63.11(b)(8).

(ii) A previous compliance demonstration for the flare may be used by an owner or operator to demonstrate compliance with paragraph (h)(2) of this section provided that all conditions for the compliance determination and subsequent flare operation are met as specified in paragraphs (h)(2)(i)(A) and (h)(2)(ii)(B) of this section.

(A) The owner or operator conducted the compliance determination using the procedures specified in paragraph (h)(2)(i) of this section.

(B) No flare operating parameter or process changes have occurred since completion of the compliance determination which could affect the compliance determination results.

(3) The owner or operator must monitor the operation of the flare using a heat sensing monitoring device (including but not limited to a thermocouple, ultraviolet beam sensor, or infrared sensor) that continuously detects the presence of a pilot flame. The owner or operator must record, for each 1-hour period, whether the monitor was continuously operating and whether a pilot flame was continuously present during each hour as required in § 63.696(b)(3) of this subpart.

[64 FR 38970, July 20, 1999, as amended at 66 FR 1266, Jan. 8, 2001; 68 FR 37351, June 23, 2003]

§ 63.694 Testing methods and procedures.

(a) This section specifies the testing methods and procedures required for this subpart to perform the following:

(1) To determine the average VOHAP concentration for off-site material streams at the point-of-delivery for compliance with standards specified § 63.683 of this subpart, the testing methods and procedures are specified in paragraph (b) of this section.

(2) To determine the average VOHAP concentration for treated off-site material streams at the point-of-treatment for compliance with standards specified § 63.684 of this subpart, the testing methods and procedures are specified in paragraph (c) of this section.

(3) To determine the treatment process VOHAP concentration limit (C_R) for compliance with standards specified § 63.684 of this subpart, the testing methods and procedures are specified in paragraph (d) of this section.

(4) To determine treatment process required HAP removal rate (RMR) for compliance with standards specified § 63.684 of this subpart, the testing methods and procedures are specified in paragraph (e) of this section.

(5) To determine treatment process actual HAP removal rate (MR) for compliance with standards specified § 63.684 of this subpart, the testing methods and procedures are specified in paragraph (f) of this section.

(6) To determine treatment process required HAP reduction efficiency (R) for compliance with standards specified in § 63.684 of this subpart, the testing methods and procedures are specified in paragraph (g) of this section.

(7) To determine treatment process required HAP biodegradation efficiency (R_{bio}) for compliance with standards specified in § 63.684 of this subpart, the testing methods and procedures are specified in paragraph (h) of this section.

(8) To determine treatment process required actual HAP mass removal rate (MR_{bio}) for compliance with standards specified in § 63.684 of this subpart, the testing methods and procedures are specified in paragraph (i) of this section.

(9) To determine maximum organic HAP vapor pressure of off-site materials in tanks for compliance with the standards specified in § 63.685 of this subpart, the testing methods and procedures are specified in paragraph (j) of this section.

(10) To determine no detectable organic emissions, the testing methods and procedures are specified in paragraph (k) of this section.

(11) To determine closed-vent system and control device performance for compliance with the standards specified in § 63.693 of this subpart, the testing methods and procedures are specified in paragraph (l) of this section.

(12) To determine process vent stream flow rate and total organic HAP concentration for compliance with the standards specified in § 63.693 of this subpart, the testing methods and procedures are specified in paragraph (m) of this section.

(b) Testing methods and procedures to determine average VOHAP concentration of an off-site material stream at the point-of-delivery.

(1) The average VOHAP concentration of an off-site material at the point-of-delivery shall be determined using either direct measurement as specified in paragraph (b)(2) of this section or by knowledge as specified in paragraph (b)(3) of this section.

(2) *Direct measurement to determine VOHAP concentration*— (i) *Sampling*. Samples of the off-site material stream shall be collected from the container, pipeline, or other device used to deliver the off-site material stream to the plant site in a manner such that volatilization of organics contained in the sample is minimized and an adequately representative sample is collected and maintained for analysis by the selected method.

(A) The averaging period to be used for determining the average VOHAP concentration for the off-site material stream on a mass-weighted average basis shall be designated and recorded. The

averaging period can represent any time interval that the owner or operator determines is appropriate for the off-site material stream but shall not exceed 1 year.

(B) A sufficient number of samples, but no less than four samples, shall be collected to represent the complete range of HAP compositions and HAP quantities that occur in the off-site material stream during the entire averaging period due to normal variations in the operating conditions for the source or process generating the off-site material stream. Examples of such normal variations are seasonal variations in off-site material quantity or fluctuations in ambient temperature.

(C) All samples shall be collected and handled in accordance with written procedures prepared by the owner or operator and documented in a site sampling plan. This plan shall describe the procedure by which representative samples of the off-site material stream are collected such that a minimum loss of organics occurs throughout the sample collection and handling process and by which sample integrity is maintained. A copy of the written sampling plan shall be maintained on-site in the plant site operating records. An example of an acceptable sampling plan includes a plan incorporating sample collection and handling procedures in accordance with the requirements specified in "Test Methods for Evaluating Solid Waste, Physical/Chemical Methods," EPA Publication No. SW-846 or Method 25D in 40 CFR part 60, appendix A.

(ii) *Analysis*. Each collected sample must be prepared and analyzed in accordance with one of the following methods as applicable to the sampled off-site material for the purpose of measuring the HAP listed in Table 1 of this subpart:

(A) Method 305 in 40 CFR part 63, appendix A.

(B) Method 25D in 40 CFR part 60, appendix A.

(C) Method 624 in 40 CFR part 136, appendix A. If this method is used to analyze one or more compounds that are not on the method's published list of approved compounds, the Alternative Test Procedure specified in 40 CFR 136.4 and 40 CFR 136.5 must be followed.

(D) Method 625 in 40 CFR part 136, appendix A. For the purpose of using this method to comply with this subpart, the owner or operator must perform corrections to these compounds based on the "accuracy as recovery" using the factors in Table 7 of the method. If this method is used to analyze one or more compounds that are not on the method's published list of approved compounds, the Alternative Test Procedure specified in 40 CFR 136.4 and 40 CFR 136.5 must be followed.

(E) Method 1624 in 40 CFR part 136, appendix A.

(F) Method 1625 in 40 CFR part 136, appendix A.

(G) Method 8260 in "Test Methods for Evaluating Solid Waste, Physical/Chemical Methods," EPA Publication No. SW-846, Third Edition, September 1986, as amended by Update I, November 15, 1992. As an alternative, an owner or operator may use any more recent, updated version of Method 8260 approved by the EPA. For the purpose of using Method 8260 to comply with this subpart, the owner or operator must maintain a formal quality assurance program consistent with section 8 of Method 8260, and this program must include the following elements related to measuring the concentrations of volatile compounds:

(1) Documentation of site-specific procedures to minimize the loss of compounds due to volatilization, biodegradation, reaction, or sorption during the sample collection, storage, and preparation steps.

(2) Documentation of specific quality assurance procedures followed during sampling, sample preparation, sample introduction, and analysis.

(3) Measurement of the average accuracy and precision of the specific procedures, including field duplicates and field spiking of the off-site material source before or during sampling with compounds having similar chemical characteristics to the target analytes.

(H) Method 8270 in "Test Methods for Evaluating Solid Waste, Physical/Chemical Methods," EPA Publication No. SW-846, Third Edition, September 1986, as amended by Update I, November 15, 1992. As an alternative, an owner or operator may use any more recent, updated version of Method 8270 approved by the EPA. For the purpose of using Method 8270 to comply with this subpart, the owner or operator must maintain a formal quality assurance program consistent with Method 8270, and this program must include the following elements related to measuring the concentrations of volatile compounds:

(1) Documentation of site-specific procedures to minimize the loss of compounds due to volatilization, biodegradation, reaction, or sorption during the sample collection, storage, and preparation steps.

(2) Documentation of specific quality assurance procedures followed during sampling, sample preparation, sample introduction, and analysis.

(3) Measurement of the average accuracy and precision of the specific procedures, including field duplicates and field spiking of the off-site material source before or during sampling with compounds having similar chemical characteristics to the target analytes.

(I) Any other analysis method that has been validated in accordance with the procedures specified in section 5.1 and section 5.3 and the corresponding calculations in section 6.1 or section 6.3 of Method 301 in appendix A in 40 CFR part 63. The data are acceptable if they meet the criteria specified in section 6.1.5 or section 6.3.3 of Method 301. If correction is required under section 6.3.3 of Method 301, the data are acceptable if the correction factor is within the range of 0.7 to 1.30. Other sections of Method 301 are not required.

(iii) *Calculations.* The average VOHAP concentration (C) on a mass-weighted basis shall be calculated by using the results for all samples analyzed in accordance with paragraph (b)(2)(ii) of this section and the following equation. An owner or operator using a test method that provides species-specific chemical concentrations may adjust the measured concentrations to the corresponding concentration values which would be obtained had the off-site material samples been analyzed using Method 305. To adjust these data, the measured concentration for each individual HAP chemical species contained in the off-site material is multiplied by the appropriate species-specific adjustment factor (f_{m305}) listed in Table 1 of this subpart.

$$C = \frac{1}{Q_T} \times \sum_{i=1}^n (Q_i \times C_i)$$

Where:

C = Average VOHAP concentration of the off-site material at the point-of-delivery on a mass-weighted basis, ppmw.

i = Individual sample "i" of the off-site material.

n = Total number of samples of the off-site material collected (at least 4) for the averaging period (not to exceed 1 year).

Q_i = Mass quantity of off-site material stream represented by C_i , kg/hr.

Q_T = Total mass quantity of off-site material during the averaging period, kg/hr.

C_i = Measured VOHAP concentration of sample "i" as determined in accordance with the requirements of § 63.694(a), ppmw.

(3) Knowledge of the off-site material to determine VOHAP concentration.

(i) Documentation shall be prepared that presents the information used as the basis for the owner's or operator's knowledge of the off-site material stream's average VOHAP concentration. Examples of information that may be used as the basis for knowledge include: material balances for

the source or process generating the off-site material stream; species-specific chemical test data for the off-site material stream from previous testing that are still applicable to the current off-site material stream; previous test data for other locations managing the same type of off-site material stream; or other knowledge based on information in documents such as manifests, shipping papers, or waste certification notices.

(ii) If test data are used as the basis for knowledge, then the owner or operator shall document the test method, sampling protocol, and the means by which sampling variability and analytical variability are accounted for in the determination of the average VOHAP concentration. For example, an owner or operator may use HAP concentration test data for the off-site material stream that are validated in accordance with Method 301 in 40 CFR part 63, appendix A of this part as the basis for knowledge of the off-site material.

(iii) An owner or operator using species-specific chemical concentration test data as the basis for knowledge of the off-site material may adjust the test data to the corresponding average VOHAP concentration value which would be obtained had the off-site material samples been analyzed using Method 305. To adjust these data, the measured concentration for each individual HAP chemical species contained in the off-site material is multiplied by the appropriate species-specific adjustment factor (f_{m305}) listed in Table 1 of this subpart.

(iv) In the event that the Administrator and the owner or operator disagree on a determination of the average VOHAP concentration for an off-site material stream using knowledge, then the results from a determination of VOHAP concentration using direct measurement as specified in paragraph (b) (2) of this section shall be used to establish compliance with the applicable requirements of this subpart. The Administrator may perform or request that the owner or operator perform this determination using direct measurement.

(c) Determination of average VOHAP concentration of an off-site material stream at the point-of-treatment.

(1) *Sampling.* Samples of the off-site material stream shall be collected at the point-of-treatment in a manner such that volatilization of organics contained in the sample is minimized and an adequately representative sample is collected and maintained for analysis by the selected method.

(i) The averaging period to be used for determining the average VOHAP concentration for the off-site material stream on a mass-weighted average basis shall be designated and recorded. The averaging period can represent any time interval that the owner or operator determines is appropriate for the off-site material stream but shall not exceed 1 year.

(ii) A sufficient number of samples, but no less than four samples, shall be collected to represent the complete range of HAP compositions and HAP quantities that occur in the off-site material stream during the entire averaging period due to normal variations in the operating conditions for the treatment process. Examples of such normal variations are seasonal variations in off-site material quantity or fluctuations in ambient temperature.

(iii) All samples shall be collected and handled in accordance with written procedures prepared by the owner or operator and documented in a site sampling plan. This plan shall describe the procedure by which representative samples of the off-site material stream are collected such that a minimum loss of organics occurs throughout the sample collection and handling process and by which sample integrity is maintained. A copy of the written sampling plan shall be maintained on-site in the plant site operating records. An example of an acceptable sampling plan includes a plan incorporating sample collection and handling procedures in accordance with the requirements specified in "Test Methods for Evaluating Solid Waste, Physical/Chemical Methods," EPA Publication No. SW-846 or Method 25D in 40 CFR part 60, appendix A.

(2) *Analysis.* Each collected sample must be prepared and analyzed in accordance with one of the methods specified in paragraphs (b)(2)(ii)(A) through (b)(2)(ii)(I) of this section, as applicable to the sampled off-site material, for the purpose of measuring the HAP listed in Table 1 of this subpart.

(3) *Calculations.* The average VOHAP concentration (\bar{C}) on a mass-weighted basis shall be calculated by using the results for all samples analyzed in accordance with paragraph (c)(2) of this section and the following equation. An owner or operator using a test method that provides species-specific chemical concentrations may adjust the measured concentrations to the corresponding concentration values which would be obtained had the off-site material samples been analyzed using Method 305. To adjust these data, the measured concentration for each individual HAP chemical species contained in the off-site material is multiplied by the appropriate species-specific adjustment factor (f_{m305}) listed in Table 1 of this subpart.

$$\bar{C} = \frac{1}{Q_T} \times \sum_{i=1}^n (Q_i \times C_i)$$

Where:

\bar{C} = Average VOHAP concentration of the off-site material on a mass-weighted basis, ppmw.

i = Individual sample "i" of the off-site material.

n = Total number of samples of the off-site material collected (at least 4) for the averaging period (not to exceed 1 year).

Q_i = Mass quantity of off-site material stream represented by C_i , kg/hr.

Q_T = Total mass quantity of off-site material during the averaging period, kg/hr.

C_i = Measured VOHAP concentration of sample "i" as determined in accordance with the requirements of § 63.694(a), ppmw.

(d) *Determination of treatment process VOHAP concentration limit (C_R).* (1) All of the off-site material streams entering the treatment process shall be identified.

(2) The average VOHAP concentration of each off-site material stream at the point-of-delivery shall be determined using the procedures specified in paragraph (b) of this section.

(3) The VOHAP concentration limit (C_R) shall be calculated by using the results determined for each individual off-site material stream and the following equation:

$$C_R = \frac{\sum_{x=1}^m (Q_x \times \bar{C}_x) + \sum_{y=1}^n (Q_y \times 500 \text{ ppmw})}{\sum_{x=1}^m Q_x + \sum_{y=1}^n Q_y}$$

where:

C_R = VOHAP concentration limit, ppmw.

x = Individual off-site material stream "x" that has a VOHAP concentration less than 500 ppmw at the point-of-delivery.

y = Individual off-site material stream "y" that has a VOHAP concentration equal to or greater than 500 ppmw at the point-of-delivery.

m = Total number of "x" off-site material streams treated by process.

n = Total number of "y" off-site material streams treated by process.

Q_x = Total mass quantity of off-site material stream "x", kg/yr.

Q_y = Total mass quantity of off-site material stream "y", kg/yr.

\bar{C}_x = VOHAP concentration of off-site material stream "x" at the point-of-delivery, ppmw.

(e) Determination of required HAP mass removal rate (RMR).

(1) Each individual stream containing HAP that enters the treatment process shall be identified.

(2) The average VOHAP concentration at the point-of-delivery for each stream identified in paragraph (e)(1) of this section shall be determined using the test methods and procedures specified in paragraph (b) of this section.

(3) For each stream identified in paragraph (e)(1) of this section that has an average VOHAP concentration equal to or greater than 500 ppmw at the point-of-delivery, the average volumetric flow rate and the density of the off-site material stream at the point-of-delivery shall be determined.

(4) The required HAP mass removal rate (RMR) shall be calculated by using the average VOHAP concentration, average volumetric flow rate, and density determined in paragraph (e)(3) of this section for each stream and the following equation:

$$\text{RMR} = \sum_{y=1}^n \left[V_y \times k_y \times \frac{(\bar{C}_y - 500 \text{ ppmw})}{10^6} \right]$$

Where:

RMR = Required HAP mass removal rate, kg/hr.

y = Individual stream "y" that has a VOHAP concentration equal to or greater than 500 ppmw at the point-of-delivery as determined in § 63.694(b).

n = Total number of "y" streams treated by process.

V_y = Average volumetric flow rate of stream "y" at the point-of-delivery, m^3/hr .

k_y = Density of stream "y", kg/m^3 .

\bar{C}_y = Average VOHAP concentration of stream "y" at the point-of-delivery as determined in § 63.694(b)(2), ppmw.

(f) Determination of actual HAP mass removal rate (MR).

(1) The actual HAP mass removal rate (MR) shall be determined based on results for a minimum of three consecutive runs. The sampling time for each run shall be 1 hour.

(2) The HAP mass flow entering the process (E_b) and the HAP mass flow exiting the process (E_a) shall be determined using the test methods and procedures specified in paragraphs (g)(2) through (g)(4) of this section.

(3) The actual mass removal rate shall be calculated using the HAP mass flow rates determined in paragraph (f)(2) of this section and the following equation:

$$\text{MR} = E_b - E_a$$

where:

MR = Actual HAP mass removal rate, kg/hr.

E_b = HAP mass flow entering process as determined in paragraph (f)(2) of this section, kg/hr.

E_a = HAP mass flow exiting process as determined in paragraph (f)(2) of this section, kg/hr.

(g) Determination of treatment process HAP reduction efficiency (R).

(1) The HAP reduction efficiency (R) for a treatment process shall be determined based on results for a minimum of three consecutive runs.

(2) Each individual stream containing HAP that enters the treatment process shall be identified. Each individual stream containing HAP that exits the treatment process shall be identified. The owner or operator shall prepare a sampling plan for measuring the identified streams that accurately reflects the retention time of the material in the process.

(3) For each run, information shall be determined for each stream identified in paragraph (g)(2) of this section as specified in paragraphs (g)(3)(i) through (g)(3)(iii) of this section.

(i) The mass quantity shall be determined for each stream identified in paragraph (g)(2) of this section as entering the process (Q_b). The mass quantity shall be determined for each stream identified in paragraph (g)(2) of this section as exiting the process (Q_a).

(ii) The average VOHAP concentration at the point-of-delivery shall be determined for each stream entering the process (C_b) (as identified in paragraph (g)(2) of this section) using the test methods and procedures specified in paragraph (b) of this section.

(iii) The average VOHAP concentration at the point-of-treatment shall be determined for each stream exiting the process (C_a) (as identified in paragraph (g)(2) of this section) using the test methods and procedures specified in paragraph (c) of this section.

(4) The HAP mass flow entering the process (E_b) and the HAP mass flow exiting the process (E_a) shall be calculated using the results determined in paragraph (g)(3) of this section and the following equations:

$$E_a = \frac{1}{10^6} \sum_{j=1}^m (Q_{aj} \times \overline{C_{aj}})$$

$$E_b = \frac{1}{10^6} \sum_{j=1}^m (Q_{bj} \times \overline{C_{bj}})$$

Where:

E_b = HAP mass flow entering process, kg/hr.

E_a = HAP mass flow exiting process, kg/hr.

m = Total number of runs (at least 3)

j = Individual run "j"

Q_{bj} = Mass quantity of material entering process during run "j", kg/hr.

Q_{aj} = Average mass quantity of material exiting process during run "j", kg/hr.

C_{aj} = Average VOHAP concentration of material exiting process during run "j" as determined in § 63.694(c), ppmw.

C_{bj} = Average VOHAP concentration of material entering process during run "j" as determined in § 63.694(b)(2), ppmw.

(5) The HAP reduction efficiency (R) shall be calculated using the HAP mass flow rates determined in paragraph (g)(4) of this section and the following equation:

$$R = \frac{E_b - E_a}{E_b} \times 100$$

Where:

R = HAP reduction efficiency, percent.

E_b = HAP mass flow entering process as determined in paragraph (g)(4) of this section, kg/hr.

E_a = HAP mass flow exiting process as determined in accordance with the requirements of paragraph (g)(4) of this section, kg/hr.

(h) Determination of HAP biodegradation efficiency (R_{bio}).

(1) The fraction of HAP biodegraded (F_{bio}) shall be determined using one of the procedures specified in appendix C of this part 63.

(2) The HAP biodegradation efficiency (R_{bio}) shall be calculated by using the following equation:

$$R_{bio} = F_{bio} \times 100$$

where:

R_{bio} = HAP biodegradation efficiency, percent.

F_{bio} = Fraction of HAP biodegraded as determined in paragraph (h)(1) of this section.

(i) Determination of actual HAP mass removal rate (MR_{bio}).

(1) The actual HAP mass removal rate (MR_{bio}) shall be determined based on results for a minimum of three consecutive runs. The sampling time for each run shall be 1 hour.

(2) The HAP mass flow entering the process (E_b) shall be determined using the test methods and procedures specified in paragraphs (g)(2) through (g)(4) of this section.

(3) The fraction of HAP biodegraded (F_{bio}) shall be determined using the procedure specified in 40 CFR part 63, appendix C of this part.

(4) The actual mass removal rate shall be calculated by using the HAP mass flow rates and fraction of HAP biodegraded determined in paragraphs (i)(2) and (i)(3), respectively, of this section and the following equation:

$$MR_{bio} = E_b \times F_{bio}$$

Where:

MR_{bio} = Actual HAP mass removal rate, kg/hr.

E_b = HAP mass flow entering process, kg/hr.

F_{bio} = Fraction of HAP biodegraded.

(j) *Determination of maximum HAP vapor pressure for off-site material in a tank.* (1) The maximum HAP vapor pressure of the off-site material composition managed in a tank shall be determined using either direct measurement as specified in paragraph (j)(2) of this section or by knowledge of the off-site material as specified by paragraph (j)(3) of this section.

(2) Direct measurement to determine the maximum HAP vapor pressure of an off-site material.

(i) Sampling. A sufficient number of samples shall be collected to be representative of the off-site material contained in the tank. All samples shall be collected and handled in accordance with written procedures prepared by the owner or operator and documented in a site sampling plan. This plan shall describe the procedure by which representative samples of the off-site material is collected such that a minimum loss of organics occurs throughout the sample collection and handling process and by which sample integrity is maintained. A copy of the written sampling plan shall be maintained on-site in the

plant site operating records. An example of an acceptable sampling plan includes a plan incorporating sample collection and handling procedures in accordance with the requirements specified in "Test Methods for Evaluating Solid Waste, Physical/Chemical Methods," EPA Publication No. SW-846 or Method 25D in 40 CFR part 60, appendix A.

(ii) Analysis. Any one of the following methods may be used to analyze the samples and compute the maximum HAP vapor pressure of the off-site material:

(A) Method 25E in 40 CFR part 60 appendix A;

(B) Methods described in American Petroleum Institute Bulletin 2517, "Evaporation Loss from External Floating Roof Tanks,";

(C) Methods obtained from standard reference texts;

(D) ASTM Method 2879-83; or

(E) Any other method approved by the Administrator.

(3) Use of knowledge to determine the maximum HAP vapor pressure of the off-site material. Documentation shall be prepared and recorded that presents the information used as the basis for the owner's or operator's knowledge that the maximum HAP vapor pressure of the off-site material is less than the maximum vapor pressure limit listed in Table 3 or Table 4 of this subpart for the applicable tank design capacity category. Examples of information that may be used include: the off-site material is generated by a process for which at other locations it previously has been determined by direct measurement that the off-site material maximum HAP vapor pressure is less than the maximum vapor pressure limit for the appropriate tank design capacity category.

(k) Procedure for determining no detectable organic emissions for the purpose of complying with this subpart.

(1) The test shall be conducted in accordance with the procedures specified in Method 21 of 40 CFR part 60, appendix A. Each potential leak interface (i.e., a location where organic vapor leakage could occur) on the cover and associated closure devices shall be checked. Potential leak interfaces that are associated with covers and closure devices include, but are not limited to: the interface of the cover and its foundation mounting; the periphery of any opening on the cover and its associated closure device; and the sealing seat interface on a spring-loaded pressure-relief valve.

(2) The test shall be performed when the unit contains a material having a total organic concentration representative of the range of concentrations for the materials expected to be managed in the unit. During the test, the cover and closure devices shall be secured in the closed position.

(3) The detection instrument shall meet the performance criteria of Method 21 of 40 CFR part 60, appendix A, except the instrument response factor criteria in section 3.1.2(a) of Method 21 shall be for the average composition of the organic constituents in the material placed in the unit, not for each individual organic constituent.

(4) The detection instrument shall be calibrated before use on each day of its use by the procedures specified in Method 21 of 40 CFR part 60, appendix A.

(5) Calibration gases shall be as follows:

(i) Zero air (less than 10 ppmv hydrocarbon in air); and

(ii) A mixture of methane or n-hexane in air at a concentration of approximately, but less than, 10,000 ppmv.

(6) An owner or operator may choose to adjust or not adjust the detection instrument readings to account for the background organic concentration level. If an owner or operator chooses to adjust the

instrument readings for the background level, the background level value must be determined according to the procedures in Method 21 of 40 CFR part 60, appendix A.

(7) Each potential leak interface shall be checked by traversing the instrument probe around the potential leak interface as close to the interface as possible, as described in Method 21. In the case when the configuration of the cover or closure device prevents a complete traverse of the interface, all accessible portions of the interface shall be sampled. In the case when the configuration of the closure device prevents any sampling at the interface and the device is equipped with an enclosed extension or horn (e.g., some pressure relief devices), the instrument probe inlet shall be placed at approximately the center of the exhaust area to the atmosphere.

(8) An owner or operator must determine if a potential leak interface operates with no detectable emissions using the applicable procedure specified in paragraph (k)(8)(i) or (k)(8)(ii) of this section.

(i) If an owner or operator chooses not to adjust the detection instrument readings for the background organic concentration level, then the maximum organic concentration value measured by the detection instrument is compared directly to the applicable value for the potential leak interface as specified in paragraph (k)(9) of this section.

(ii) If an owner or operator chooses to adjust the detection instrument readings for the background organic concentration level, the value of the arithmetic difference between the maximum organic concentration value measured by the instrument and the background organic concentration value as determined in paragraph (k)(6) of this section is compared with the applicable value for the potential leak interface as specified in paragraph (k)(9) of this section.

(9) A potential leak interface is determined to operate with no detectable emissions using the applicable criteria specified in paragraphs (k)(9)(i) and (k)(9)(ii) of this section.

(i) For a potential leak interface other than a seal around a shaft that passes through a cover opening, the potential leak interface is determined to operate with no detectable organic emissions if the organic concentration value determined in paragraph (k)(8) is less than 500 ppmv.

(ii) For a seal around a shaft that passes through a cover opening, the potential leak interface is determined to operate with no detectable organic emissions if the organic concentration value determined in paragraph (k)(8) is less than 10,000 ppmv.

(l) Control device performance test procedures.

(1) Method 1 or 1A of 40 CFR part 60, appendix A, as appropriate, shall be used for selection of the sampling sites at the inlet and outlet of the control device.

(i) To determine compliance with a control device percent reduction requirement, sampling sites shall be located at the inlet of the control device as specified in paragraphs (l)(1)(i)(A) and (l)(1)(i)(B) of this section, and at the outlet of the control device.

(A) The control device inlet sampling site shall be located after the final product recovery device.

(B) If a vent stream is introduced with the combustion air or as an auxiliary fuel into a boiler or process heater, the location of the inlet sampling sites shall be selected to ensure that the measurement of total HAP concentration or TOC concentration, as applicable, includes all vent streams and primary and secondary fuels introduced into the boiler or process heater.

(ii) To determine compliance with an enclosed combustion device concentration limit, the sampling site shall be located at the outlet of the device.

(2) The gas volumetric flow rate shall be determined using Method 2, 2A, 2C, or 2D of 40 CFR part 60, appendix A, as appropriate.

(3) To determine compliance with the control device percent reduction requirement, the owner or operator shall use Method 18 of 40 CFR part 60, appendix A of this chapter; alternatively, any other

method or data that has been validated according to the applicable procedures in Method 301 in 40 CFR part 63, appendix A of this part may be used. The following procedures shall be used to calculate percent reduction efficiency:

(i) The minimum sampling time for each run shall be 1 hour in which either an integrated sample or a minimum of four grab samples shall be taken. If grab sampling is used, then the samples shall be taken at approximately equal intervals in time such as 15 minute intervals during the run.

(ii) The mass rate of either TOC (minus methane and ethane) or total HAP (E_i and E_o , respectively) shall be computed.

(A) The following equations shall be used:

$$E_i = K_2 \times Q_i \times \sum_{j=1}^n (C_{ij} \times M_{ij})$$

$$E_o = K_2 \times Q_o \times \sum_{j=1}^n (C_{oj} \times M_{oj})$$

Where:

C_{ij} , C_{oj} = Concentration of sample component j of the gas stream at the inlet and outlet of the control device, respectively, dry basis, parts per million by volume.

E_i , E_o = Mass rate of TOC (minus methane and ethane) or total HAP at the inlet and outlet of the control device, respectively, dry basis, kilogram per hour.

M_{ij} , M_{oj} = Molecular weight of sample component j of the gas stream at the inlet and outlet of the control device, respectively, gram/gram-mole.

Q_i , Q_o = Flow rate of gas stream at the inlet and outlet of the control device, respectively, dry standard cubic meter per minute.

K_2 = Constant, 2.494×10^{-6} (parts per million)⁻¹ (gram-mole per standard cubic meter) (kilogram/gram) (minute/hour), where standard temperature (gram-mole per standard cubic meter) is 20 °C.

(B) When the TOC mass rate is calculated, all organic compounds (minus methane and ethane) measured by Method 18 of 40 CFR part 60, appendix A shall be summed using the equation in paragraph (I)(3)(ii)(A) of this section.

(C) When the total HAP mass rate is calculated, only the HAP constituents shall be summed using the equation in paragraph (I)(3)(ii)(A) of this section.

(iii) The percent reduction in TOC (minus methane and ethane) or total HAP shall be calculated as follows:

$$R_{cd} = \frac{E_i - E_o}{E_i} \times 100$$

where:

R_{cd} = Control efficiency of control device, percent.

E_i = Mass rate of TOC (minus methane and ethane) or total HAP at the inlet to the control device as calculated under paragraph (I)(3)(ii) of this section, kilograms TOC per hour or kilograms HAP per hour.

E_o = Mass rate of TOC (minus methane and ethane) or total HAP at the outlet of the control device, as calculated under paragraph (I)(3)(ii) of this section, kilograms TOC per hour or kilograms HAP per hour.

(iv) If the vent stream entering a boiler or process heater is introduced with the combustion air or as a secondary fuel, the weight-percent reduction of total HAP or TOC (minus methane and ethane) across the device shall be determined by comparing the TOC (minus methane and ethane) or total HAP in all combusted vent streams and primary and secondary fuels with the TOC (minus methane and ethane) or total HAP exiting the device, respectively.

(4) To determine compliance with the enclosed combustion device total HAP concentration limit of this subpart, the owner or operator shall use Method 18 of 40 CFR part 60, appendix A to measure either TOC (minus methane and ethane) or total HAP. Alternatively, any other method or data that has been validated according to Method 301 in appendix A of this part, may be used. The following procedures shall be used to calculate parts per million by volume concentration, corrected to 3 percent oxygen:

(i) The minimum sampling time for each run shall be 1 hour in which either an integrated sample or a minimum of four grab samples shall be taken. If grab sampling is used, then the samples shall be taken at approximately equal intervals in time, such as 15 minute intervals during the run.

(ii) The TOC concentration or total HAP concentration shall be calculated according to paragraph (m)(4)(ii)(A) or (m)(4)(ii)(B) of this section.

(A) The TOC concentration (C_{TOC}) is the sum of the concentrations of the individual components and shall be computed for each run using the following equation:

$$C_{\text{TOC}} = \sum_{i=1}^x \frac{\sum_{j=1}^n C_{ji}}{x}$$

where:

C_{TOC} = Concentration of total organic compounds minus methane and ethane, dry basis, parts per million by volume.

C_{ji} = Concentration of sample components j of sample i , dry basis, parts per million by volume.

n = Number of components in the sample.

x = Number of samples in the sample run.

(B) The total HAP concentration (C_{HAP}) shall be computed according to the equation in paragraph (l)(4)(ii)(A) of this section except that only HAP constituents shall be summed.

(iii) The measured TOC concentration or total HAP concentration shall be corrected to 3 percent oxygen as follows:

(A) The emission rate correction factor or excess air, integrated sampling and analysis procedures of Method 3B of 40 CFR part 60, appendix A shall be used to determine the oxygen concentration (% $O_{2\text{dry}}$). The samples shall be collected during the same time that the samples are collected for determining TOC concentration or total HAP concentration.

(B) The concentration corrected to 3 percent oxygen (C_c) shall be computed using the following equation:

$$C_c = C_m \left(\frac{17.9}{20.9 - \%O_{2\text{dry}}} \right)$$

where:

C_c = TOC concentration or total HAP concentration corrected to 3 percent oxygen, dry basis, parts per million by volume.

C_m = Measured TOC concentration or total HAP concentration, dry basis, parts per million by volume.

$\%O_{2dry}$ = Concentration of oxygen, dry basis, percent by volume.

(m) Determination of process vent stream flow rate and total HAP concentration.

(1) Method 1 or 1A of 40 CFR part 60, appendix A, as appropriate, must be used for selection of the sampling site.

(2) No traverse site selection method is needed for vents smaller than 0.10 meter in diameter.

(3) Process vent stream gas volumetric flow rate must be determined using Method 2, 2A, 2C, or 2D of 40 CFR part 60, appendix A, as appropriate.

(4) Process vent stream total HAP concentration must be measured using the following procedures:

(i) Method 18 of 40 CFR part 60, appendix A, must be used to measure the total HAP concentration. Alternatively, any other method or data that has been validated according to the protocol in Method 301 of appendix A of this part may be used.

(ii) Where Method 18 of 40 CFR part 60, appendix A, is used, the following procedures must be used to calculate parts per million by volume concentration:

(A) The minimum sampling time for each run must be 1 hour in which either an integrated sample or four grab samples must be taken. If grab sampling is used, then the samples must be taken at approximately equal intervals in time, such as 15 minute intervals during the run.

(B) The total HAP concentration (C_{HAP}) must be computed according to the following equation:

$$C_{HAP} = \frac{\sum_{i=1}^x \left(\sum_{j=1}^n C_{ji} \right)}{X}$$

Where:

C_{HAP} = Total concentration of HAP compounds listed in Table 1 of this subpart, dry basis, parts per million by volume.

C_{ji} = Concentration of sample component j of the sample i, dry basis, parts per million by volume.

n = Number of components in the sample.

x = Number of samples in the sample run.

[61 FR 34158, July 1, 1996, as amended at 64 FR 38974, July 20, 1999; 66 FR 1267, Jan. 8, 2001]

§ 63.695 Inspection and monitoring requirements.

(a) This section specifies the inspection and monitoring procedures required to perform the following:

(1) To inspect tank fixed roofs and floating roofs for compliance with the Tank Level 2 controls standards specified in § 63.685 of this subpart, the inspection procedures are specified in paragraph (b) of this section.

(2) To inspect and monitor closed-vent systems for compliance with the standards specified in § 63.693 of this subpart, the inspection and monitoring procedures are specified in paragraph (c) of this section.

(3) To inspect and monitor transfer system covers for compliance with the standards specified in § 63.689(c)(1) of this subpart, the inspection and monitoring procedures are specified in paragraph (d) of this section.

(4) To monitor and record off-site material treatment processes for compliance with the standards specified in 63.684(e), the monitoring procedures are specified in paragraph (e) of this section.

(b) Tank Level 2 fixed roof and floating roof inspection requirements.

(1) Owners and operators that use a tank equipped with an internal floating roof in accordance with the provisions of § 63.685(e) of this subpart shall meet the following inspection requirements:

(i) The floating roof and its closure devices shall be visually inspected by the owner or operator to check for defects that could result in air emissions. Defects include, but are not limited to, the internal floating roof is not floating on the surface of the liquid inside the tank; liquid has accumulated on top of the internal floating roof; any portion of the roof seals have detached from the roof rim; holes, tears, or other openings are visible in the seal fabric; the gaskets no longer close off the waste surfaces from the atmosphere; or the slotted membrane has more than 10 percent open area.

(ii) The owner or operator shall inspect the internal floating roof components as follows except as provided for in paragraph (b)(1)(iii) of this section:

(A) Visually inspect the internal floating roof components through openings on the fixed-roof (e.g., manholes and roof hatches) at least once every calendar year after initial fill, and

(B) Visually inspect the internal floating roof, primary seal, secondary seal (if one is in service), gaskets, slotted membranes, and sleeve seals (if any) each time the tank is emptied and degassed and at least every 10 years. Prior to each inspection, the owner or operator shall notify the Administrator in accordance with the reporting requirements specified in § 63.697 of this subpart.

(iii) As an alternative to performing the inspections specified in paragraph (b)(1)(ii) of this section for an internal floating roof equipped with two continuous seals mounted one above the other, the owner or operator may visually inspect the internal floating roof, primary and secondary seals, gaskets, slotted membranes, and sleeve seals (if any) each time the tank is emptied and degassed and at least every 5 years. Prior to each inspection, the owner or operator shall notify the Administrator in accordance with the reporting requirements specified in § 63.697 of this subpart.

(iv) In the event that a defect is detected, the owner or operator shall repair the defect in accordance with the requirements of paragraph (b)(4) of this section.

(v) The owner or operator shall maintain a record of the inspection in accordance with the requirements specified in § 63.696 of this subpart.

(2) Owners and operators that use a tank equipped with an external floating roof in accordance with the provisions of § 63.685(f) of this subpart shall meet the following requirements:

(i) The owner or operator shall measure the external floating roof seal gaps in accordance with the following requirements:

(A) The owner or operator shall perform measurements of gaps between the tank wall and the primary seal within 60 days after initial operation of the tank following installation of the floating roof and, thereafter, at least once every 5 years. Prior to each inspection, the owner or operator shall notify the Administrator in accordance with the reporting requirements specified in § 63.697 of this subpart.

(B) The owner or operator shall perform measurements of gaps between the tank wall and the secondary seal within 60 days after initial operation of the separator following installation of the floating

roof and, thereafter, at least once every year. Prior to each inspection, the owner or operator shall notify the Administrator in accordance with the reporting requirements specified in § 63.697 of this subpart.

(C) If a tank ceases to hold off-site material for a period of 1 year or more, subsequent introduction of off-site material into the tank shall be considered an initial operation for the purposes of paragraphs (b)(2)(i)(A) and (b)(2)(i)(B) of this section.

(D) The owner shall determine the total surface area of gaps in the primary seal and in the secondary seal individually using the following procedure.

(1) The seal gap measurements shall be performed at one or more floating roof levels when the roof is floating off the roof supports.

(2) Seal gaps, if any, shall be measured around the entire perimeter of the floating roof in each place where a 0.32-centimeter (cm) ($\frac{1}{8}$ -inch) diameter uniform probe passes freely (without forcing or binding against the seal) between the seal and the wall of the tank and measure the circumferential distance of each such location.

(3) For a seal gap measured under paragraph (b)(2) of this section, the gap surface area shall be determined by using probes of various widths to measure accurately the actual distance from the tank wall to the seal and multiplying each such width by its respective circumferential distance.

(4) The total gap area shall be calculated by adding the gap surface areas determined for each identified gap location for the primary seal and the secondary seal individually, and then dividing the sum for each seal type by the nominal diameter of the tank. These total gap areas for the primary seal and secondary seal are then compared to the respective standards for the seal type as specified in § 63.685(f)(1) of this subpart.

(E) In the event that the seal gap measurements do not conform to the specifications in § 63.685 (f)(1) of this subpart, the owner or operator shall repair the defect in accordance with the requirements of paragraph (b)(4) of this section.

(F) The owner or operator shall maintain a record of the inspection in accordance with the requirements specified in § 63.696 of this subpart.

(ii) The owner or operator shall visually inspect the external floating roof in accordance with the following requirements:

(A) The floating roof and its closure devices shall be visually inspected by the owner or operator to check for defects that could result in air emissions. Defects include, but are not limited to: holes, tears, or other openings in the rim seal or seal fabric of the floating roof; a rim seal detached from the floating roof; all or a portion of the floating roof deck being submerged below the surface of the liquid in the tank; broken, cracked, or otherwise damaged seals or gaskets on closure devices; and broken or missing hatches, access covers, caps, or other closure devices.

(B) The owner or operator shall perform the inspections following installation of the external floating roof and, thereafter, at least once every year.

(C) In the event that a defect is detected, the owner or operator shall repair the defect in accordance with the requirements of paragraph (b)(4) of this section.

(D) The owner or operator shall maintain a record of the inspection in accordance with the requirements specified in § 63.696(d) of this subpart.

(3) Owners and operators that use a tank equipped with a fixed roof in accordance with the provisions of § 63.685(g) of this subpart shall meet the following requirements:

(i) The fixed roof and its closure devices shall be visually inspected by the owner or operator to check for defects that could result in air emissions. Defects include, but are not limited to, visible cracks, holes, or gaps in the roof sections or between the roof and the separator wall; broken, cracked, or otherwise damaged seals or gaskets on closure devices; and broken or missing hatches, access covers, caps, or other closure devices. In the case when a tank is buried partially or entirely underground, inspection is required only for those portions of the cover that extend to or above the ground surface, and those connections that are on such portions of the cover (e.g., fill ports, access hatches, gauge wells, etc.) and can be opened to the atmosphere.

(ii) The owner or operator must perform an initial inspection following installation of the fixed roof. Thereafter, the owner or operator must perform the inspections at least once every calendar year except as provided for in paragraph (f) of this section.

(iii) In the event that a defect is detected, the owner or operator shall repair the defect in accordance with the requirements of paragraph (b)(4) of this section.

(iv) The owner or operator shall maintain a record of the inspection in accordance with the requirements specified in § 63.696(e) of this subpart.

(4) The owner or operator shall repair each defect detected during an inspection performed in accordance with the requirements of paragraph (b)(1), (b)(2), or (b)(3) of this section in the following manner:

(i) The owner or operator shall within 45 calendar days of detecting the defect either repair the defect or empty the tank and remove it from service. If within this 45-day period the defect cannot be repaired or the tank cannot be removed from service without disrupting operations at the plant site, the owner or operator is allowed two 30-day extensions. In cases when an owner or operator elects to use a 30-day extension, the owner or operator shall prepare and maintain documentation describing the defect, explaining why alternative storage capacity is not available, and specify a schedule of actions that will ensure that the control equipment will be repaired or the tank emptied as soon as possible.

(ii) When a defect is detected during an inspection of a tank that has been emptied and degassed, the owner or operator shall repair the defect before refilling the tank.

(c) Owners and operators that use a closed-vent system in accordance with the provisions of § 63.693 of this subpart shall meet the following inspection and monitoring requirements:

(1) Each closed-vent system that is used to comply with § 63.693(c)(1)(i) of this subpart shall be inspected and monitored in accordance with the following requirements:

(i) At initial startup, the owner or operator shall monitor the closed-vent system components and connections using the procedures specified in § 63.694(k) of this subpart to demonstrate that the closed-vent system operates with no detectable organic emissions.

(ii) After initial startup, the owner or operator shall inspect and monitor the closed-vent system as follows:

(A) Closed-vent system joints, seams, or other connections that are permanently or semi-permanently sealed (e.g., a welded joint between two sections of hard piping or a bolted and gasketed ducting flange) shall be visually inspected at least once per year to check for defects that could result in air emissions. The owner or operator shall monitor a component or connection using the procedures specified in § 63.694(k) of this subpart to demonstrate that it operates with no detectable organic emissions following any time the component is repaired or replaced (e.g., a section of damaged hard piping is replaced with new hard piping) or the connection is unsealed (e.g., a flange is unbolted).

(B) Closed-vent system components or connections other than those specified in paragraph (c)(1)(ii)(A) of this section, shall be monitored at least once per year using the procedures specified in § 63.694(k) of this subpart to demonstrate that components or connections operate with no detectable organic emissions.

(C) The continuous monitoring system required by § 63.693(b)(4)(i) shall monitor and record either an instantaneous data value at least once every 15 minutes or an average value for intervals of 15 minutes or less.

(D) The owner or operator shall visually inspect the seal or closure mechanism required by § 63.693(c)(2)(ii) at least once every month to verify that the bypass mechanism is maintained in the closed position.

(iii) In the event that a defect or leak is detected, the owner or operator shall repair the defect or leak in accordance with the requirements of paragraph (c)(3) of this section.

(iv) The owner or operator shall maintain a record of the inspection and monitoring in accordance with the requirements specified in § 63.696 of this subpart.

(2) Each closed-vent system that is used to comply with § 63.693(c)(1)(ii) of this subpart shall be inspected and monitored in accordance with the following requirements:

(i) The closed-vent system shall be visually inspected by the owner or operator to check for defects that could result in air emissions. Defects include, but are not limited to, visible cracks, holes, or gaps in ductwork or piping; loose connections; or broken or missing caps or other closure devices.

(ii) The owner or operator must perform an initial inspection following installation of the closed-vent system. Thereafter, the owner or operator must perform the inspections at least once every calendar year except as provided for in paragraph (f) of this section.

(iii) In the event that a defect is detected, the owner or operator shall repair the defect in accordance with the requirements of paragraph (c)(3) of this section.

(iv) The owner or operator shall maintain a record of the inspection in accordance with the requirements specified in § 63.696 of this subpart.

(3) The owner or operator shall repair all detected defects as follows:

(i) The owner or operator shall make first efforts at repair of the defect no later than 5 calendar days after detection and repair shall be completed as soon as possible but no later than 45 calendar days after detection.

(ii) Repair of a defect may be delayed beyond 45 calendar days if either of the conditions specified in paragraph (c)(3)(ii)(A) or (c)(3)(ii)(B) occurs. In this case, the owner or operator must repair the defect the next time the process or unit that vents to the closed-vent system is shutdown. Repair of the defect must be completed before the process or unit resumes operation.

(A) Completion of the repair is technically infeasible without the shutdown of the process or unit that vents to the closed-vent system.

(B) The owner or operator determines that the air emissions resulting from the repair of the defect within the specified period would be greater than the fugitive emissions likely to result by delaying the repair until the next time the process or unit that vents to the closed-vent system is shutdown.

(iii) The owner or operator shall maintain a record of the defect repair in accordance with the requirements specified in § 63.696 of this subpart.

(d) Owners and operators that use a transfer system equipped with a cover in accordance with the provisions of § 63.689(c)(1) of this subpart shall meet the following inspection requirements:

(1) The cover and its closure devices shall be visually inspected by the owner or operator to check for defects that could result in air emissions. Defects include, but are not limited to, visible cracks, holes, or gaps in the cover sections or between the cover and its mounting; broken, cracked, or otherwise damaged seals or gaskets on closure devices; and broken or missing hatches, access covers, caps, or other closure devices. In the case when a transfer system is buried partially or entirely

underground, inspection is required only for those portions of the cover that extend to or above the ground surface, and those connections that are on such portions of the cover (e.g., access hatches, etc.) and can be opened to the atmosphere.

(2) The owner or operator must perform an initial inspection following installation of the cover. Thereafter, the owner or operator must perform the inspections at least once every calendar year except as provided for in paragraph (f) of this section.

(3) In the event that a defect is detected, the owner or operator shall repair the defect in accordance with the requirements of paragraph (d)(5) of this section.

(4) The owner or operator shall maintain a record of the inspection in accordance with the requirements specified in § 63.696 of this subpart.

(5) The owner or operator shall repair all detected defects as follows:

(i) The owner or operator shall make first efforts at repair of the defect no later than 5 calendar days after detection and repair shall be completed as soon as possible but no later than 45 calendar days after detection except as provided in paragraph (d)(5)(ii) of this section.

(ii) Repair of a defect may be delayed beyond 45 calendar days if the owner or operator determines that repair of the defect requires emptying or temporary removal from service of the transfer system and no alternative transfer system is available at the site to accept the material normally handled by the system. In this case, the owner or operator shall repair the defect the next time the process or unit that is generating the material handled by the transfer system stops operation. Repair of the defect must be completed before the process or unit resumes operation.

(iii) The owner or operator shall maintain a record of the defect repair in accordance with the requirements specified in § 63.696 of this subpart.

(e) *Control device monitoring requirements.* For each control device required under § 63.693 of this subpart to be monitored in accordance with the provisions of this paragraph (e), the owner or operator must ensure that each control device operates properly by monitoring the control device in accordance with the requirements specified in paragraphs (e)(1) through (e)(7) of this section.

(1) A continuous parameter monitoring system must be used to measure the operating parameter or parameters specified for the control device in § 63.693(d) through § 63.693(g) of this subpart as applicable to the type and design of the control device. The continuous parameter monitoring system must meet the following specifications and requirements:

(i) The continuous parameter monitoring system must measure either an instantaneous value at least once every 15 minutes or an average value for intervals of 15 minutes or less and continuously record either:

(A) Each measured data value; or

(B) Each block average value for each 1-hour period or shorter periods calculated from all measured data values during each period. If values are measured more frequently than once per minute, a single value for each minute may be used to calculate the hourly (or shorter period) block average instead of all measured values.

(ii) The monitoring system must be installed, calibrated, operated, and maintained in accordance with the manufacturer's specifications or other written procedures that provide reasonable assurance that the monitoring equipment is operating properly.

(2) Using the data recorded by the monitoring system, the owner or operator must calculate the daily average value for each monitored operating parameter for each operating day. If operation of the control device is continuous, the operating day is a 24-hour period. If control device operation is not continuous, the operating day is the total number of hours of control device operation per 24-hour

period. Valid data points must be available for 75 percent of the operating hours in an operating day to compute the daily average.

(3) For each monitored operating parameter, the owner or operator must establish a minimum operating parameter value or a maximum operating parameter value, as appropriate, to define the range of conditions at which the control device must be operated to continuously achieve the applicable performance requirements specified in § 63.693(b)(2) of this subpart. Each minimum or maximum operating parameter value must be established in accordance with the requirements in paragraphs (e)(3)(i) and (e)(3)(ii) of this section.

(i) If the owner or operator conducts a performance test to demonstrate control device performance, then the minimum or maximum operating parameter value must be established based on values measured during the performance test and supplemented, as necessary, by the control device design specifications, manufacturer recommendations, or other applicable information.

(ii) If the owner or operator uses a control device design analysis to demonstrate control device performance, then the minimum or maximum operating parameter value must be established based on the control device design analysis and supplemented, as necessary, by the control device manufacturer recommendations or other applicable information.

(4) An excursion for a given control device is determined to have occurred when the monitoring data or lack of monitoring data result in any one of the criteria specified in paragraphs (e)(4)(i) through (e)(4)(iii) of this section being met. When multiple operating parameters are monitored for the same control device and during the same operating day more than one of these operating parameters meets an excursion criterion specified in paragraphs (e)(4)(i) through (e)(4)(iii) of this section, then a single excursion is determined to have occurred for the control device for that operating day.

(i) An excursion occurs when the daily average value of a monitored operating parameter is less than the minimum operating parameter limit (or, if applicable, greater than the maximum operating parameter limit) established for the operating parameter in accordance with the requirements of paragraph (e)(3) of this section.

(ii) An excursion occurs when the period of control device operation is 4 hours or greater in an operating day and the monitoring data are insufficient to constitute a valid hour of data for at least 75 percent of the operating hours. Monitoring data are insufficient to constitute a valid hour of data if measured values are unavailable for any of the 15-minute periods within the hour.

(iii) An excursion occurs when the period of control device operation is less than 4 hours in an operating day and more than 1 of the hours during the period does not constitute a valid hour of data due to insufficient monitoring data. Monitoring data are insufficient to constitute a valid hour of data if measured values are unavailable for any of the 15-minute periods within the hour.

(5) For each excursion, except as provided for in paragraph (e)(6) of this section, the owner or operator shall be deemed to have failed to have applied control in a manner that achieves the required operating parameter limits. Failure to achieve the required operating parameter limits is a violation of this standard.

(6) An excursion is not a violation of this standard under any one of the conditions specified in paragraphs (e)(6)(i) and (e)(6)(ii) of this section.

(i) An excursion is not a violation nor does it count toward the number of excused excursions allowed under paragraph (e)(6)(ii) of this section when the excursion occurs during any one of the following periods:

(A) During a period of startup, shutdown, or malfunction when the affected facility is operated during such period in accordance with § 63.6(e)(1); or

(B) During periods of non-operation of the unit or the process that is vented to the control device (resulting in cessation of HAP emissions to which the monitoring applies).

(ii) For each control device, one excused excursion is allowed per semiannual period for any reason. The initial semiannual period is the 6-month reporting period addressed by the first semiannual report submitted by the owner or operator in accordance with § 63.697(b)(4) of this subpart.

(7) Nothing in paragraphs (e)(1) through (e)(6) of this section shall be construed to allow or excuse a monitoring parameter excursion caused by any activity that violates other applicable provisions of this subpart.

(f) *Alternative inspection and monitoring interval.* Following the initial inspection and monitoring of a piece of air pollution control equipment in accordance with the applicable provisions of this section, subsequent inspection and monitoring of the equipment may be performed at intervals longer than 1 year when an owner or operator determines that performing the required inspection or monitoring procedures would expose a worker to dangerous, hazardous, or otherwise unsafe conditions and the owner or operator complies with the requirements specified in paragraphs (f)(1) and (f)(2) of this section.

(1) The owner or operator must prepare and maintain at the plant site written documentation identifying the specific air pollution control equipment designated as “unsafe to inspect and monitor.” The documentation must include for each piece of air pollution control equipment designated as such a written explanation of the reasons why the equipment is unsafe to inspect or monitor using the applicable procedures under this section.

(2) The owner or operator must develop and implement a written plan and schedule to inspect and monitor the air pollution control equipment using the applicable procedures specified in this section during times when a worker can safely access the air pollution control equipment. The required inspections and monitoring must be performed as frequently as practicable but do not need to be performed more frequently than the periodic schedule that would be otherwise applicable to the air pollution control equipment under the provisions of this section. A copy of the written plan and schedule must be maintained at the plant site.

[64 FR 38977, July 20, 1999, as amended at 68 FR 37352, June 23, 2003; 71 FR 20457, Apr. 20, 2006]

§ 63.696 Recordkeeping requirements.

(a) The owner or operator subject to this subpart shall comply with the recordkeeping requirements in § 63.10 under 40 CFR 63 subpart A—General Provisions that are applicable to this subpart as specified in Table 2 of this subpart.

(b) The owner or operator of a control device subject to this subpart shall maintain the records in accordance with the requirements of 40 CFR 63.10 of this part.

(c) [Reserved]

(d) Each owner or operator using an internal floating roof to comply with the tank control requirements specified in § 63.685(e) of this subpart or using an external floating roof to comply with the tank control requirements specified in § 63.685(f) of this subpart shall prepare and maintain the following records:

(1) Documentation describing the floating roof design and the dimensions of the tank.

(2) A record for each inspection required by § 63.695(b) of this subpart, as applicable to the tank, that includes the following information: a tank identification number (or other unique identification description as selected by the owner or operator) and the date of inspection.

(3) The owner or operator shall record for each defect detected during inspections required by § 63.695(b) of this subpart the following information: the location of the defect, a description of the defect, the date of detection, and corrective action taken to repair the defect. In the event that repair of the defect is delayed in accordance with the provisions of § 63.695(b)(4) of this section, the owner or

operator shall also record the reason for the delay and the date that completion of repair of the defect is expected.

(4) Owners and operators that use a tank equipped with an external floating roof in accordance with the provisions of § 63.685(f) of this subpart shall prepare and maintain records for each seal gap inspection required by § 63.695(b) describing the results of the seal gap measurements. The records shall include the date of that the measurements are performed, the raw data obtained for the measurements, and the calculations of the total gap surface area. In the event that the seal gap measurements do not conform to the specifications in § 63.695(b) of this subpart, the records shall include a description of the repairs that were made, the date the repairs were made, and the date the separator was emptied, if necessary.

(e) Each owner or operator using a fixed roof to comply with the tank control requirements specified in § 63.685(g) of this subpart shall prepare and maintain the following records:

(1) A record for each inspection required by § 63.695(b) of this subpart, as applicable to the tank, that includes the following information: a tank identification number (or other unique identification description as selected by the owner or operator) and the date of inspection.

(2) The owner or operator shall record for each defect detected during inspections required by § 63.695(b) of this subpart the following information: the location of the defect, a description of the defect, the date of detection, and corrective action taken to repair the defect. In the event that repair of the defect is delayed in accordance with the provisions of § 63.695(b)(4) of this section, the owner or operator shall also record the reason for the delay and the date that completion of repair of the defect is expected.

(f) Each owner or operator using an enclosure to comply with the tank control requirements specified in § 63.685(i) of this subpart shall prepare and maintain records for the most recent set of calculations and measurements performed by the owner or operator to verify that the enclosure meets the criteria of a permanent total enclosure as specified in "Procedure T—Criteria for and Verification of a Permanent or Temporary Total Enclosure" under 40 CFR 52.741, appendix B.

(g) An owner or operator shall record, on a semiannual basis, the information specified in paragraphs (g)(1) and (g)(2) of this section for those planned routine maintenance operations that would require the control device not to meet the requirements of § 63.693(d) through (h) of this subpart, as applicable.

(1) A description of the planned routine maintenance that is anticipated to be performed for the control device during the next 6 months. This description shall include the type of maintenance necessary, planned frequency of maintenance, and lengths of maintenance periods.

(2) A description of the planned routine maintenance that was performed for the control device during the previous 6 months. This description shall include the type of maintenance performed and the total number of hours during these 6 months that the control device did not meet the requirement of § 63.693 (d) through (h) of this subpart, as applicable, due to planned routine maintenance.

(h) An owner or operator shall record the information specified in paragraphs (h)(1) through (h)(3) of this section for those unexpected control device system malfunctions that would require the control device not to meet the requirements of § 63.693 (d) through (h) of this subpart, as applicable.

(1) The occurrence and duration of each malfunction of the control device system.

(2) The duration of each period during a malfunction when gases, vapors, or fumes are vented from the waste management unit through the closed-vent system to the control device while the control device is not properly functioning.

(3) Actions taken during periods of malfunction to restore a malfunctioning control device to its normal or usual manner of operation.

§ 63.697 Reporting requirements.

(a) Each owner or operator of an affected source subject to this subpart must comply with the notification requirements specified in paragraph (a)(1) of this section and the reporting requirements specified in paragraph (a)(2) of this section.

(1) The owner or operator of an affected source must submit notices to the Administrator in accordance with the applicable notification requirements in 40 CFR 63.9 as specified in Table 2 of this subpart. For the purpose of this subpart, an owner or operator subject to the initial notification requirements under 40 CFR 63.9(b)(2) must submit the required notification on or before October 19, 1999.

(2) The owner or operator of an affected source must submit reports to the Administrator in accordance with the applicable reporting requirements in 40 CFR 63.10 as specified in Table 2 of this subpart.

(b) The owner or operator of a control device used to meet the requirements of § 63.693 of this subpart shall submit the following notifications and reports to the Administrator:

(1) A Notification of Performance Tests specified in § 63.7 and § 63.9(g) of this part,

(2) Performance test reports specified in § 63.10(d)(2) of this part, and

(3) Startup, shutdown, and malfunction reports specified in § 63.10(d)(5) of this part.

(i) If actions taken by an owner or operator during a startup, shutdown, or malfunction of an affected source (including actions taken to correct a malfunction) are not completely consistent with the procedures specified in the source's startup, shutdown, and malfunction plan specified in § 63.6(e)(3) of this part, the owner or operator shall state such information in the report. The startup, shutdown, or malfunction report shall consist of a letter, containing the name, title, and signature of the responsible official who is certifying its accuracy, that shall be submitted to the Administrator, and

(ii) Separate startup, shutdown, or malfunction reports are not required if the information is included in the summary report specified in paragraph (b)(4) of this section.

(4) A summary report specified in § 63.10(e)(3) of this part shall be submitted on a semiannual basis (i.e., once every 6-month period). The summary report must include a description of all excursions as defined in § 63.695(e) of this subpart that have occurred during the 6-month reporting period. For each excursion caused when the daily average value of a monitored operating parameter is less than the minimum operating parameter limit (or, if applicable, greater than the maximum operating parameter limit), the report must include the daily average values of the monitored parameter, the applicable operating parameter limit, and the date and duration of the period that the exceedance occurred. For each excursion caused by lack of monitoring data, the report must include the date and duration of period when the monitoring data were not collected and the reason why the data were not collected.

(c) Each owner or operator using an internal floating roof or external floating roof to comply with the Tank Level 2 control requirements specified in § 63.685(d) of this subpart shall notify the Administrator in advance of each inspection required under § 63.695(b) of this subpart to provide the Administrator with the opportunity to have an observer present during the inspection. The owner or operator shall notify the Administrator of the date and location of the inspection as follows:

(1) Prior to each inspection to measure external floating roof seal gaps as required under § 63.695(b) of this subpart, written notification shall be prepared and sent by the owner or operator so that it is received by the Administrator at least 30 calendar days before the date the measurements are scheduled to be performed.

(2) Prior to each visual inspection of an internal floating roof or external floating roof in a tank that has been emptied and degassed, written notification shall be prepared and sent by the owner or

operator so that it is received by the Administrator at least 30 calendar days before refilling the tank except when an inspection is not planned as provided for in paragraph (c)(3) of this section.

(3) When a visual inspection is not planned and the owner or operator could not have known about the inspection 30 calendar days before refilling the tank, the owner or operator shall notify the Administrator as soon as possible, but no later than 7 calendar days before refilling of the tank. This notification may be made by telephone and immediately followed by a written explanation for why the inspection is unplanned. Alternatively, written notification, including the explanation for the unplanned inspection, may be sent so that it is received by the Administrator at least 7 calendar days before refilling the tank.

[61 FR 34158, July 1, 1996, as amended at 64 FR 38981, July 20, 1999]

§ 63.698 Implementation and enforcement.

(a) This subpart can be implemented and enforced by the U.S. EPA, or a delegated authority such as the applicable State, local, or Tribal agency. If the U.S. EPA Administrator has delegated authority to a State, local, or Tribal agency, then that agency, in addition to the U.S. EPA, has the authority to implement and enforce this subpart. Contact the applicable U.S. EPA Regional Office to find out if this subpart is delegated to a State, local, or Tribal agency.

(b) In delegating implementation and enforcement authority of this subpart to a State, local, or Tribal agency under subpart E of this part, the authorities contained in paragraph (c) of this section are retained by the Administrator of U.S. EPA and cannot be transferred to the State, local, or Tribal agency.

(c) The authorities that cannot be delegated to State, local, or Tribal agencies are as specified in paragraphs (c)(1) through (4) of this section.

(1) Approval of alternatives to the requirements in §§ 63.680, 63.683 through 63.691, and 63.693. Where these standards reference another subpart, the cited provisions will be delegated according to the delegation provisions of the referenced subpart.

(2) Approval of major alternatives to test methods under § 63.7(e)(2)(ii) and (f), as defined in § 63.90, and as required in this subpart.

(3) Approval of major alternatives to monitoring under § 63.8(f), as defined in § 63.90, and as required in this subpart.

(4) Approval of major alternatives to recordkeeping and reporting under § 63.10(f), as defined in § 63.90, and as required in this subpart.

[68 FR 37352, June 23, 2003]

Table 1 to Subpart DD of Part 63—List of Hazardous Air Pollutants (HAP) for Subpart DD

CAS No. ^a	Chemical name	f _m 305
75-07-0	Acetaldehyde	1.000
75-05-8	Acetonitrile	0.989
98-86-2	Acetophenone	0.314
107-02-8	Acrolein	1.000
107-13-1	Acrylonitrile	0.999
107-05-1	Allyl chloride	1.000
71-43-2	Benzene (includes benzene in gasoline)	1.000

98-07-7	Benzotrichloride (isomers and mixture)	0.958
100-44-7	Benzyl chloride	1.000
92-52-4	Biphenyl	0.864
542-88-1	Bis(chloromethyl)ether ^b	0.999
75-25-2	Bromoform	0.998
106-99-0	1,3-Butadiene	1.000
75-15-0	Carbon disulfide	1.000
56-23-5	Carbon tetrachloride	1.000
43-58-1	Carbonyl sulfide	1.000
133-90-4	Chloramben	0.633
108-90-7	Chlorobenzene	1.000
67-66-3	Chloroform	1.000
107-30-2	Chloromethyl methyl ether ^b	1.000
126-99-8	Chloroprene	1.000
98-82-8	Cumene	1.000
94-75-7	2,4-D, salts and esters	0.167
334-88-3	Diazomethane ^c	0.999
132-64-9	Dibenzofurans	0.967
96-12-8	1,2-Dibromo-3-chloropropane	1.000
106-46-7	1,4-Dichlorobenzene(p)	1.000
107-06-2	Dichloroethane (Ethylene dichloride)	1.000
111-44-4	Dichloroethyl ether (Bis(2-chloroethyl ether)	0.757
542-75-6	1,3-Dichloropropene	1.000
79-44-7	Dimethyl carbamoyl chloride ^c	0.150
64-67-5	Diethyl sulfate	0.0025
77-78-1	Dimethyl sulfate	0.086
121-69-7	N,N-Dimethylaniline	0.0008
51-28-5	2,4-Dinitrophenol	0.0077
121-14-2	2,4-Dinitrotoluene	0.0848
123-91-1	1,4-Dioxane (1,4-Diethyleneoxide)	0.869
106-89-8	Epichlorohydrin (1-Chloro-2,3-epoxypropane)	0.939
106-88-7	1,2-Epoxybutane	1.000
	Ethyl acrylate	1.000

140-88-5		
100-41-4	Ethyl benzene	1.000
75-00-3	Ethyl chloride (Chloroethane)	1.000
106-93-4	Ethylene dibromide (Dibromoethane)	0.999
107-06-2	Ethylene dichloride (1,2-Dichloroethane)	1.000
151-56-4	Ethylene imine (Aziridine)	0.867
75-21-8	Ethylene oxide	1.000
75-34-3	Ethylidene dichloride (1,1-Dichloroethane)	1.000
	Glycol ethers ^d that have a Henry's Law constant value equal to or greater than 0.1 Y/X (1.8×10^{-6} atm/gm-mole/m ³) at 25°C	^(e)
118-74-1	Hexachlorobenzene	0.97
87-68-3	Hexachlorobutadiene	0.88
67-72-1	Hexachloroethane	0.499
110-54-3	Hexane	1.000
78-59-1	Isophorone	0.506
58-89-9	Lindane (all isomers)	1.000
67-56-1	Methanol	0.855
74-83-9	Methyl bromide (Bromomethane)	1.000
74-87-3	Methyl chloride (Chloromethane)	1.000
71-55-6	Methyl chloroform (1,1,1-Trichloroethane)	1.000
78-93-3	Methyl ethyl ketone (2-Butanone)	0.990
74-88-4	Methyl iodide (Iodomethane)	1.0001
108-10-1	Methyl isobutyl ketone (Hexone)	0.9796
624-83-9	Methyl isocyanate	1.000
80-62-6	Methyl methacrylate	0.916
1634-04-4	Methyl tert butyl ether	1.000
75-09-2	Methylene chloride (Dichloromethane)	1.000
91-20-3	Naphthalene	0.994
98-95-3	Nitrobenzene	0.394
79-46-9	2-Nitropropane	0.989
82-68-8	Pentachloronitrobenzene (Quintobenzene)	0.839
87-86-5	Pentachlorophenol	0.0898
75-44-5	Phosgene ^c	1.000
123-38-6	Propionaldehyde	0.999
78-87-5	Propylene dichloride (1,2-Dichloropropane)	1.000
75-56-9	Propylene oxide	1.000
75-55-8	1,2-Propylenimine (2-Methyl aziridine)	0.945
100-42-5	Styrene	1.000

96-09-3	Styrene oxide	0.830
79-34-5	1,1,2,2-Tetrachloroethane	0.999
127-18-4	Tetrachloroethylene (Perchloroethylene)	1.000
108-88-3	Toluene	1.000
95-53-4	o-Toluidine	0.152
120-82-1	1,2,4-Trichlorobenzene	1.000
71-55-6	1,1,1-Trichloroethane (Methyl chlorform)	1.000
79-00-5	1,1,2-Trichloroethane (Vinyl trichloride)	1.000
79-01-6	Trichloroethylene	1.000
95-95-4	2,4,5-Trichlorophenol	0.108
88-06-2	2,4,6-Trichlorophenol	0.132
121-44-8	Triethylamine	1.000
540-84-1	2,2,4-Trimethylpentane	1.000
108-05-4	Vinyl acetate	1.000
593-60-2	Vinyl bromide	1.000
75-01-4	Vinyl chloride	1.000
75-35-4	Vinylidene chloride (1,1-Dichloroethylene)	1.000
1330-20-7	Xylenes (isomers and mixture)	1.000
95-47-6	o-Xylenes	1.000
108-38-3	m-Xylenes	1.000
106-42-3	p-Xylenes	1.000

Notes:

$f_{m\ 305}$ = Method 305 fraction measure factor.

a. CAS numbers refer to the Chemical Abstracts Services registry number assigned to specific compounds, isomers, or mixtures of compounds.

b. Denotes a HAP that hydrolyzes quickly in water, but the hydrolysis products are also HAP chemicals.

c. Denotes a HAP that may react violently with water, exercise caustic is an expected analyte.

d. Denotes a HAP that hydrolyzes slowly in water.

e. The $f_{m\ 305}$ factors for some of the more common glycol ethers can be obtained by contacting the Waste and Chemical Processes Group, Office of Air Quality Planning and Standards, Research Triangle Park, NC 27711.

[64 FR 38981, July 20, 1999]

Table 2 to Subpart DD of Part 63—Applicability of Paragraphs in Subpart A of This Part 63—General Provisions to Subpart DD

--	--	--

Subpart A reference	Applies to Subpart DD	Explanation
63.1(a)(1)	Yes	
63.1(a)(2)	Yes	
63.1(a)(3)	Yes	
63.1(a)(4)	No	Subpart DD (this table) specifies applicability of each paragraph in subpart A to subpart DD.
63.1(a)(5)-63.1(a)(9)	No	
63.1(a)(10)	Yes	
63.1(a)(11)	Yes	
63.1(a)(12)	Yes	
63.1(a)(13)	Yes	
63.1(a)(14)	Yes	
63.1(b)(1)	No	Subpart DD specifies its own applicability.
63.1(b)(2)	Yes	
63.1(b)(3)	No	
63.1(c)(1)	No	Subpart DD explicitly specifies requirements that apply.
63.1(c)(2)	No	Area sources are not subject to subpart DD.
63.1(c)(3)	No	
63.1(c)(4)	Yes	
63.1(c)(5)	Yes	Except that sources are not required to submit notifications overridden by this table.
63.1(d)	No	
63.1(e)	No	
63.2	Yes	§ 63.681 of subpart DD specifies that if the same term is defined in subparts A and DD, it shall have the meaning given in subpart DD.
63.3	Yes	
63.4(a)(1)-63.4(a)(3)	Yes	
63.4(a)(4)	No	Reserved.
63.4(a)(5)	Yes	
63.4(b)	Yes	
63.4(c)	Yes	
63.5(a)(1)	Yes	Except replace term “source” and “stationary source” in § 63.5(a)(1) of subpart A with “affected source.”
63.5(a)(2)	Yes	
63.5(b)(1)	Yes	
63.5(b)(2)	No	Reserved.
63.5(b)(3)	Yes	
63.5(b)(4)	Yes	Except the cross-reference to § 63.9(b) is changed to § 63.9(b)(4) and (5). Subpart DD overrides § 63.9(b)(2) and (b)(3).
63.5(b)(5)	Yes	
63.5(b)(6)	Yes	
63.5(c)	No	Reserved.
63.5(d)(1)(i)	Yes	
63.5(d)(1)(ii)	Yes	
63.5(d)(1)(iii)	Yes	
63.5(d)(2)	No	

63.5(d)(3)	Yes	
63.5(d)(4)	Yes	
63.5(e)	Yes	
63.5(f)(1)	Yes	
63.5(f)(2)	Yes	
63.6(a)	Yes	
63.6(b)(1)	No	Subpart DD specifies compliance dates for sources subject to subpart DD.
63.6(b)(2)	No	
63.6(b)(3)	Yes	
63.6(b)(4)	No	May apply when standards are proposed under section 112(f) of the Clean Air Act.
63.6(b)(5)	No	§ 63.697 of subpart DD includes notification requirements.
63.6(b)(6)	No	
63.6(b)(7)	No	
63.6(c)(1)	No	§ 63.680 of subpart DD specifies the compliance date.
63.6(c)(2)-63.6(c)(4)	No	
63.6(c)(5)	Yes	
63.6(d)	No	
63.6(e)	Yes	
63.6(f)(1)	Yes	
63.6(f)(2)(i)	Yes	
63.6(f)(2)(ii)	Yes	Subpart DD specifies the use of monitoring data in determining compliance with subpart DD.
63.6(f)(2)(iii) (A), (B), and (C)	Yes	
63.6(f)(2)(iii) (D)	No	
63.6(f)(2)(iv)	Yes	
63.6(f)(2)(v)	Yes	
63.6(f)(3)	Yes	
63.6(g)	Yes	
63.6(h)	No	Subpart DD does not require opacity and visible emission standards.
63.6(i)	Yes	Except for § 63.6(i)(15), which is reserved.
63.6(j)	Yes	
63.7(a)(1)	No	Subpart DD specifies required testing and compliance demonstration procedures.
63.7(a)(2)	Yes	
63.7(a)(3)	Yes	
63.7(b)	No	
63.7(c)	No	
63.7(d)	Yes	
63.7(e)(1)	Yes	
63.7(e)(2)	Yes	
63.7(e)(3)	No	Subpart DD specifies test methods and procedures.
63.7(e)(4)	Yes	
63.7(f)	No	Subpart DD specifies applicable methods and provides alternatives.
63.7(g)	Yes	

63.7(h)(1)	Yes	
63.7(h)(2)	Yes	
63.7(h)(3)	Yes	
63.7(h)(4)	No	
63.7(h)(5)	Yes	
63.8(a)	No	
63.8(b)(1)	Yes	
63.8(b)(2)	No	Subpart DD specifies locations to conduct monitoring.
63.8(b)(3)	Yes	
63.8(c)(1)(i)	Yes	
63.8(c)(1)(ii)	Yes	
63.8(c)(1)(iii)	Yes	
63.8(c)(2)	Yes	
63.8(c)(3)	Yes	
63.8(c)(4)	No	Subpart DD specifies monitoring frequency
63.8(c)(5)-63.8(c)(8)	No	
63.8(d)	No	
63.8(e)	No	
63.8(f)(1)	Yes	
63.8(f)(2)	Yes	
63.8(f)(3)	Yes	
63.8(f)(4)(i)	Yes	
63.8(f)(4)(ii)	Yes	
63.8(f)(4)(iii)	No	
63.8(f)(5)(i)	Yes	
63.8(f)(5)(ii)	No	
63.8(f)(5)(iii)	Yes	
63.8(f)(6)	Yes	
63.8(g)	Yes	
63.9(a)	Yes	
63.9(b)(1)(i)	Yes	
63.9(b)(1)(ii)	No	
63.9(b)(2)	Yes	
63.9(b)(3)	No	
63.9(b)(4)	Yes	
63.9(b)(5)	Yes	
63.9(c)	Yes	
63.9(d)	Yes	
63.9(e)	No	
63.9(f)	No	
63.9(g)	No	
63.9(h)	Yes	
63.9(i)	Yes	
63.9(j)	No	
63.10(a)	Yes	
63.10(b)(1)	Yes	
63.10(b)(2)(i)	Yes	

63.10(b)(2)(ii)	Yes	
63.10(b)(2)(iii)	No	
63.10(b)(2)(iv)	Yes	
63.10(b)(2)(v)	Yes	
63.10(b)(2)(vi)-(ix)	Yes	
63.10(b)(2)(x)-(xi)	Yes	
63.10(b)(2)(xii)-(xiv)	No	
63.10(b)(3)	Yes	
63.10(c)	No	
63.10(d)(1)	No	
63.10(d)(2)	Yes	
63.10(d)(3)	No	
63.10(d)(4)	Yes	
63.10(d)(5)(i)	Yes	
63.10(d)(5)(ii)	Yes	
63.10(e)	No	
63.10(f)	Yes	
63.11-63.15	Yes	

^a Wherever subpart A specifies “postmark” dates, submittals may be sent by methods other than the U.S. Mail (e.g., by fax or courier). Submittals shall be sent by the specified dates, but a postmark is not required.

[64 FR 38983, July 20, 1999, as amended at 66 FR 1267, Jan. 8, 2001]

Table 3 to Subpart DD of Part 63—Tank Control Levels for Tanks at Existing Affected Sources as Required by 40 CFR 63.685(b)(1)

Tank design capacity (cubic meters)	Maximum HAP vapor pressure of off-site material managed in tank (kilopascals)	Tank control level
Design capacity less than 75 m ³	Maximum HAP vapor pressure less than 76.6 kPa	Level 1.
Design capacity equal to or greater than 75 m ³ and less than 151 m ³	Maximum HAP vapor pressure less than 27.6 kPa	Level 1.
	Maximum HAP vapor pressure equal to or greater than 27.6 kPa	Level 2.
Design capacity equal to or greater than 151 m ³	Maximum HAP vapor pressures less than 5.2 kPa	Level 1.
	Maximum HAP vapor pressure equal to or greater than 5.2 kPa	Level 2.

Table 4 to Subpart DD of Part 63—Tank Control Levels for Tanks at New Affected Sources as Required by 40 CFR 63.685(b)(2)

Tank design capacity (cubic meters)	Maximum HAP vapor pressure of off-site material managed in tank (kilopascals)	Tank control level
Design capacity less than 38 m ³	Maximum HAP vapor pressure less than 76.6 kPa	Level 1.
Design capacity equal to or greater than 38 m ³ and less than 151 m ³	Maximum HAP vapor pressure less than 13.1 kPa	Level 1.

	Maximum HAP vapor pressure equal to or greater than 13.1 kPa	Level 2.
Design capacity equal to or greater than 151 m ³	Maximum HAP vapor pressure less than 0.7 kPa	Level 1.
	Maximum HAP vapor pressure equal to or greater than 0.7 kPa	Level 2.

For questions or comments regarding e-CFR editorial content, features, or design, email ecfr@nara.gov.

For questions concerning e-CFR programming and delivery issues, email webteam@gpo.gov.

Appendix I – 40 CFR Part 63, Subpart OO

ELECTRONIC CODE OF FEDERAL REGULATIONS

e-CFR Data is current as of August 30, 2013

Title 40: Protection of Environment

PART 63—NATIONAL EMISSION STANDARDS FOR HAZARDOUS AIR POLLUTANTS FOR SOURCE CATEGORIES (CONTINUED)

Subpart 00—National Emission Standards for Tanks—Level 1

Contents

- § 63.900 Applicability.
 - § 63.901 Definitions.
 - § 63.902 Standards—Tank fixed roof.
 - §§ 63.903-63.904 [Reserved]
 - § 63.905 Test methods and procedures.
 - § 63.906 Inspection and monitoring requirements.
 - § 63.907 Recordkeeping requirements.
 - § 63.908 Implementation and enforcement.
-

SOURCE: 61 FR 34184, July 1, 1996, unless otherwise noted.

§ 63.900 Applicability.

The provisions of this subpart apply to the control of air emissions from tanks for which another subpart of 40 CFR parts 60, 61, or 63 references the use of this subpart for such air emission control. These air emission standards for tanks are placed here for administrative convenience and only apply to those owners and operators of facilities subject to the other subparts that reference this subpart. The provisions of 40 CFR part 63, subpart A—General Provisions do not apply to this subpart except as noted in the subpart that references this subpart.

§ 63.901 Definitions.

All terms used in this subpart shall have the meaning given to them in the Act and in this section. If a term is defined in both this section and in another subpart that references the use of this subpart, then the definition in this subpart shall take precedence when implementing this subpart.

Closure device means a cap, hatch, lid, plug, seal, valve, or other type of fitting that, when the device is secured in the closed position, prevents or reduces air emissions to the atmosphere by blocking an opening in a fixed roof. Closure devices include devices that are detachable from the cover (e.g., a sampling port cap), manually operated (e.g., a hinged access lid or hatch), or automatically operated (e.g., a spring-loaded pressure relief valve).

Fixed roof means a cover that is mounted on a tank in a stationary position and does not move with fluctuations in the level of the liquid managed in the tank.

No detectable organic emissions means no escape of organics to the atmosphere as determined using the procedure specified in § 63.905(a) of this subpart.

Regulated-material means the material (e.g. waste, wastewater, off-site material) required to be managed in tanks using air emission controls in accordance with the standards specified in this subpart.

Safety device means a closure device such as a pressure relief valve, frangible disc, fusible plug, or any other type of device which functions to prevent physical damage or permanent deformation to equipment by venting gases or vapors during unsafe conditions resulting from an unplanned, accidental, or emergency event. For the purpose of this subpart, a safety device is not used for routine venting of gases or vapors from the vapor headspace underneath a cover such as during filling of the unit or to adjust the pressure in this vapor headspace in response to normal daily diurnal ambient temperature fluctuations. A safety device is designed to remain in a closed position during normal operations and open only when the internal pressure, or another relevant parameter, exceeds the device threshold setting applicable to the equipment as determined by the owner or operator based on manufacturer recommendations, applicable regulations, fire protection and prevention codes, standard engineering codes and practices, or other requirements for the safe handling of flammable, combustible, explosive, reactive, or hazardous materials.

Tank means a stationary unit that is constructed primarily of nonearthen materials (such as wood, concrete, steel, fiberglass, or plastic) which provide structural support and is designed to hold an accumulation of liquids or other materials.

[61 FR 34184, July 1, 1996, as amended at 64 FR 38985, July 20, 1999]

§ 63.902 Standards—Tank fixed roof.

(a) This section applies to owners and operators subject to this subpart and controlling air emissions from a tank using a fixed roof. This section does not apply to a fixed-roof tank that is also equipped with an internal floating roof.

(b) The tank shall be equipped with a fixed roof designed to meet the following specifications:

(1) The fixed roof and its closure devices shall be designed to form a continuous barrier over the entire surface area of the liquid in the tank. The fixed roof may be a separate cover installed on the tank (e.g., a removable cover mounted on an open-top tank) or may be an integral part of the tank structural design (e.g., a horizontal cylindrical tank equipped with a hatch).

(2) The fixed roof shall be installed in a manner such that there are no visible cracks, holes, gaps, or other open spaces between roof section joints or between the interface of the roof edge and the tank wall.

(3) Each opening in the fixed roof, and any manifold system associated with the fixed roof, shall be either:

(i) equipped with a closure device designed to operate such that when the closure device is secured in the closed position there are no visible cracks, holes, gaps, or other open spaces in the closure device or between the perimeter of the opening and the closure device; or

(ii) connected by a closed-vent system that is vented to a control device. The control device shall remove or destroy organics in the vent stream, and shall be operating whenever regulated material is managed in the tank.

(4) The fixed roof and its closure devices shall be made of suitable materials that will minimize exposure of the regulated-material to the atmosphere, to the extent practical, and will maintain the integrity of the equipment throughout its intended service life. Factors to be considered when selecting the materials for and designing the fixed roof and closure devices shall include: organic vapor permeability, the effects of any contact with the liquid or its vapors managed in the tank; the effects of outdoor exposure to wind, moisture, and sunlight; and the operating practices used for the tank on which the fixed roof is installed.

(c) Whenever a regulated-material is in the tank, the fixed roof shall be installed with each closure device secured in the closed position except as follows:

(1) Opening of closure devices or removal of the fixed roof is allowed at the following times:

(i) To provide access to the tank for performing routine inspection, maintenance, or other activities needed for normal operations. Examples of such activities include those times when a worker needs to open a port to sample the liquid in the tank, or when a worker needs to open a hatch to maintain or repair equipment. Following completion of the activity, the owner or operator shall promptly secure the closure device in the closed position or reinstall the cover, as applicable, to the tank.

(ii) To remove accumulated sludge or other residues from the bottom of tank.

(2) Opening of a spring-loaded pressure-vacuum relief valve, conservation vent, or similar type of pressure relief device which vents to the atmosphere is allowed during normal operations for the purpose of maintaining the tank internal pressure in accordance with the tank design specifications. The device shall be designed to operate with no detectable organic emissions when the device is secured in the closed position. The settings at which the device opens shall be established such that the device remains in the closed position whenever the tank internal pressure is within the internal pressure operating range determined by the owner or operator based on the tank manufacturer recommendations, applicable regulations, fire protection and prevention codes, standard engineering codes and practices, or other requirements for the safe handling of flammable, combustible, explosive, reactive, or hazardous materials. Examples of normal operating conditions that may require these devices to open are during those times when the container internal pressure exceeds the internal pressure operating range for the tank as a result of loading operations or diurnal ambient temperature fluctuations.

(3) Opening of a safety device, as defined in § 63.901 of this subpart, is allowed at any time conditions require it to do so to avoid an unsafe condition.

(d) The owner or operator shall inspect the air emission control equipment in accordance with the requirements specified in § 63.906(a) of this subpart.

[61 FR 34184, July 1, 1996, as amended at 64 FR 38986, July 20, 1999]

§§ 63.903-63.904 [Reserved]

§ 63.905 Test methods and procedures.

(a) Procedure for determining no detectable organic emissions for the purpose of complying with this subpart.

(1) The test shall be conducted in accordance with the procedures specified in Method 21 of 40 CFR part 60, appendix A. Each potential leak interface (i.e., a location where organic vapor leakage could occur) on the cover and associated closure devices shall be checked. Potential leak interfaces that are associated with covers and closure devices include, but are not limited to: the interface of the cover and its foundation mounting; the periphery of any opening on the cover and its associated closure device; and the sealing seat interface on a spring-loaded pressure-relief valve.

(2) The test shall be performed when the unit contains a material having a total organic concentration representative of the range of concentrations for the materials expected to be managed in the unit. During the test, the cover and closure devices shall be secured in the closed position.

(3) The detection instrument shall meet the performance criteria of Method 21 of 40 CFR part 60, appendix A, except the instrument response factor criteria in section 3.1.2(a) of Method 21 shall be for the average composition of the organic constituents in the material placed in the unit, not for each individual organic constituent.

(4) The detection instrument shall be calibrated before use on each day of its use by the procedures specified in Method 21 of 40 CFR part 60, appendix A.

(5) Calibration gases shall be as follows:

(i) Zero air (less than 10 ppmv hydrocarbon in air); and

(ii) A mixture of methane or n-hexane in air at a concentration of approximately, but less than 10,000 ppmv.

(6) An owner or operator may choose to adjust or not adjust the detection instrument readings to account for the background organic concentration level. If an owner or operator chooses to adjust the instrument readings for the background level, the background level value must be determined according to the procedures in Method 21 of 40 CFR part 60, appendix A.

(7) Each potential leak interface shall be checked by traversing the instrument probe around the potential leak interface as close to the interface as possible, as described in Method 21. In the case when the configuration of the cover or closure device prevents a complete traverse of the interface, all accessible portions of the interface shall be sampled. In the case when the configuration of the closure device prevents any sampling at the interface and the device is equipped with an enclosed extension or horn (e.g., some pressure relief devices), the instrument probe inlet shall be placed at approximately the center of the exhaust area to the atmosphere.

(8) An owner or operator must determine if a potential leak interface operates with no detectable emissions using the applicable procedure specified in paragraph (a)(8)(i) or (a)(8)(ii) of this section.

(i) If an owner or operator chooses not to adjust the detection instrument readings for the background organic concentration level, then the maximum organic concentration value measured by the detection instrument is compared directly to the applicable value for the potential leak interface as specified in paragraph (a)(9) of this section.

(ii) If an owner or operator chooses to adjust the detection instrument readings for the background organic concentration level, the value of the arithmetic difference between the maximum organic concentration value measured by the instrument and the background organic concentration value as determined in paragraph (a)(6) of this section is compared with the applicable value for the potential leak interface as specified in paragraph (a)(9) of this section.

(9) A potential leak interface is determined to operate with no detectable emissions using the applicable criteria specified in paragraphs (a)(9)(i) and (a)(9)(ii) of this section.

(i) For a potential leak interface other than a seal around a shaft that passes through a cover opening, the potential leak interface is determined to operate with no detectable organic emissions if the organic concentration value determined in paragraph (a)(8) is less than 500 ppmv.

(ii) For a seal around a shaft that passes through a cover opening, the potential leak interface is determined to operate with no detectable organic emissions if the organic concentration value determined in paragraph (a)(8) is less than 10,000 ppmv.

(b) [Reserved]

[64 FR 38986, July 20, 1999]

§ 63.906 Inspection and monitoring requirements.

(a) Owners and operators that use a tank equipped with a fixed roof in accordance with the provisions of § 63.902 of this subpart shall meet the following requirements:

(1) The fixed roof and its closure devices shall be visually inspected by the owner or operator to check for defects that could result in air emissions. Defects include, but are not limited to, visible cracks, holes, or gaps in the roof sections or between the roof and the tank wall; broken, cracked, or otherwise damaged seals or gaskets on closure devices; and broken or missing hatches, access covers, caps, or other closure devices.

(2) The owner or operator must perform an initial inspection following installation of the fixed roof. Thereafter, the owner or operator must perform the inspections at least once every calendar year except as provided for in paragraph (d) of this section.

(3) In the event that a defect is detected, the owner or operator shall repair the defect in accordance with the requirements of paragraph (b) of this section.

(4) The owner or operator shall maintain a record of the inspection in accordance with the requirements specified in § 63.907 (a) of this subpart.

(b) The owner or operator shall repair all detected defects as follows:

(1) The owner or operator shall make first efforts at repair of the defect no later than 5 calendar days after detection and repair shall be completed as soon as possible but no later than 45 calendar days after detection except as provided in paragraph (b)(2) of this section.

(2) Repair of a defect may be delayed beyond 45 calendar days if the owner or operator determines that repair of the defect requires emptying or temporary removal from service of the tank and no alternative tank capacity is available at the site to accept the regulated material normally managed in the tank. In this case, the owner or operator shall repair the defect the next time alternative tank capacity becomes available and the tank can be emptied or temporarily removed from service, as necessary to complete the repair.

(c) The owner or operator shall maintain a record of the defect repair in accordance with the requirements specified in § 63.907(b) of this subpart.

(d) *Alternative inspection and monitoring interval.* Following the initial inspection and monitoring of a fixed roof in accordance with this section, subsequent inspection and monitoring of the equipment may be performed at intervals longer than 1 year when an owner or operator determines that performing the required inspection or monitoring procedures would expose a worker to dangerous, hazardous, or otherwise unsafe conditions and the owner or operator complies with the requirements specified in paragraphs (d)(1) and (d)(2) of this section.

(1) The owner or operator must prepare and maintain at the plant site written documentation identifying the specific air pollution control equipment designated as “unsafe to inspect and monitor.” The documentation must include for each piece of air pollution control equipment designated as such a written explanation of the reasons why the equipment is unsafe to inspect or monitor using the applicable procedures under this section.

(2) The owner or operator must develop and implement a written plan and schedule to inspect and monitor the air pollution control equipment using the applicable procedures specified in this section during times when a worker can safely access the air pollution control equipment. The required inspections and monitoring must be performed as frequently as practicable but do not need to be performed more frequently than the periodic schedule that would be otherwise applicable to the air pollution control equipment under the provisions of this section. A copy of the written plan and schedule must be maintained at the plant site.

[61 FR 34184, July 1, 1996, as amended at 64 FR 38986, July 20, 1999]

§ 63.907 Recordkeeping requirements.

(a) Each owner or operator shall prepare and maintain a record for each tank that includes the following information:

(1) A tank identification number (or other unique identification description as selected by the owner or operator).

(2) A description of the tank dimensions and the tank design capacity.

(3) The date that each inspection required by § 63.906 of this subpart is performed.

(b) The owner or operator shall record the following information for each defect detected during inspections required by § 63.906 of this subpart: the location of the defect, a description of the defect, the date of detection, and corrective action taken to repair the defect. In the event that repair of the

defect is delayed in accordance with the provisions of § 63.907(b)(2) of this section, the owner or operator shall also record the reason for the delay and the date that completion of repair of the defect is expected.

§ 63.908 Implementation and enforcement.

(a) This subpart can be implemented and enforced by the U.S. EPA, or a delegated authority such as the applicable State, local, or Tribal agency. If the U.S. EPA Administrator has delegated authority to a State, local, or Tribal agency, then that agency, in addition to the U.S. EPA, has the authority to implement and enforce this subpart. Contact the applicable U.S. EPA Regional Office to find out if this subpart is delegated to a State, local, or Tribal agency.

(b) In delegating implementation and enforcement authority of this subpart to a State, local, or Tribal agency under subpart E of this part, the authorities contained in paragraph (c) of this section are retained by the Administrator of U.S. EPA and cannot be transferred to the State, local, or Tribal agency.

(c) The authorities that cannot be delegated to State, local, or Tribal agencies are as specified in paragraphs (c)(1) through (4) of this section.

(1) Approval of alternatives to the requirements in §§ 63.900 and 63.902.

(2) Approval of major alternatives to test methods under § 63.7(e)(2)(ii) and (f), as defined in § 63.90, and as required in this subpart.

(3) Approval of major alternatives to monitoring under § 63.8(f), as defined in § 63.90, and as required in this subpart.

(4) Approval of major alternatives to recordkeeping and reporting under § 63.10(f), as defined in § 63.90, and as required in this subpart.

[68 FR 37354, June 23, 2003]

For questions or comments regarding e-CFR editorial content, features, or design, email ecfr@nara.gov.
For questions concerning e-CFR programming and delivery issues, email webteam@gpo.gov.

Appendix J – 40 CFR Part 63, Subpart PP

ELECTRONIC CODE OF FEDERAL REGULATIONS

e-CFR Data is current as of August 30, 2013

Title 40: Protection of Environment

PART 63—NATIONAL EMISSION STANDARDS FOR HAZARDOUS AIR POLLUTANTS FOR SOURCE CATEGORIES (CONTINUED)

Subpart **PP**—National Emission Standards for Containers

Contents

- § 63.920 Applicability.
 - § 63.921 Definitions.
 - § 63.922 Standards—Container Level 1 controls.
 - § 63.923 Standards—Container Level 2 controls.
 - § 63.924 Standards—Container Level 3 controls.
 - § 63.925 Test methods and procedures.
 - § 63.926 Inspection and monitoring requirements.
 - § 63.927 Recordkeeping requirements.
 - § 63.928 Reporting requirements.
 - § 63.929 Implementation and enforcement.
-

SOURCE: 61 FR 34186, July 1, 1996, unless otherwise noted.

§ 63.920 Applicability.

The provisions of this subpart apply to the control of air emissions from containers for which another subpart of 40 CFR parts 60, 61, or 63 references the use of this subpart for such air emission control. These air emission standards for containers are placed here for administrative convenience and only apply to those owners and operators of facilities subject to the other subparts that reference this subpart. The provisions of 40 CFR Part 63, subpart A—General Provisions do not apply to this subpart except as noted in the subpart that references this subpart.

§ 63.921 Definitions.

All terms used in this subpart shall have the meaning given to them in the Act and in this section. If a term is defined in both this section and in another subpart that references the use of this subpart, then the definition in this subpart shall take precedence when implementing this subpart.

Container means a portable unit in which a material can be stored, transported, treated, disposed of, or otherwise handled. Examples of containers include but are not limited to drums, dumpsters, roll-off boxes, bulk cargo containers commonly known as “portable tanks” or “totes,” cargo tank trucks, and tank railcars.

Closure device means a cover, cap, hatch, lid, plug, seal, valve, or other type of fitting that prevents or reduces air emissions to the atmosphere by blocking an opening in a container or its cover when the device is secured in the closed position. Closure devices include devices that are detachable from the container (e.g., a drum head, a threaded plug), manually operated (e.g., a hinged dumpster lid, a truck tank hatch), or automatically operated (e.g., a spring loaded pressure relief valve).

Empty container means a container for which either of the following conditions exists: the container meets the conditions for an empty container specified in 40 CFR 261.7(b); or all regulated-

material has been removed from the container except for any regulated-material that remains on the interior surfaces of the container as clingage or in pools on the container bottom due to irregularities in the container.

No detectable organic emissions means no escape of organics to the atmosphere as determined using the procedure specified in § 63.925(a) of this subpart.

Regulated-material means the material (e.g. waste, wastewater, off-site material) required to be managed in containers using air emission controls in accordance with the standards specified in this subpart.

Safety device means a closure device such as a pressure relief valve, frangible disc, fusible plug, or any other type of device which functions to prevent physical damage or permanent deformation to equipment by venting gases or vapors during unsafe conditions resulting from an unplanned, accidental, or emergency event. For the purpose of this subpart, a safety device is not used for routine venting of gases or vapors from the vapor headspace underneath a cover such as during filling of the unit or to adjust the pressure in this vapor headspace in response to normal daily diurnal ambient temperature fluctuations. A safety device is designed to remain in a closed position during normal operations and open only when the internal pressure, or another relevant parameter, exceeds the device threshold setting applicable to the equipment as determined by the owner or operator based on manufacturer recommendations, applicable regulations, fire protection and prevention codes, standard engineering codes and practices, or other requirements for the safe handling of flammable, combustible, explosive, reactive, or hazardous materials.

[61 FR 34186, July 1, 1996, as amended at 64 FR 38987, July 20, 1999]

§ 63.922 Standards—Container Level 1 controls.

(a) This section applies to owners and operators subject to this subpart and required to control air emissions from containers using Container Level 1 controls.

(b) A container using Container Level 1 controls is one of the following:

(1) A container that meets the applicable U.S. Department of Transportation (DOT) regulations on packaging hazardous materials for transportation as specified in paragraph (f) of this section.

(2) A container equipped with a cover and closure devices that form a continuous barrier over the container openings such that when the cover and closure devices are secured in the closed position there are no visible holes, gaps, or other open spaces into the interior of the container. The cover may be a separate cover installed on the container (e.g., a lid on a drum, a suitably secured tarp on a roll-off box) or may be an integral part of the container structural design (e.g., a bulk cargo container equipped with a screw-type cap).

(3) An open-top container in which an organic vapor-suppressing barrier is placed on or over the regulated-material in the container such that no regulated-material is exposed to the atmosphere. One example of such a barrier is application of a suitable organic-vapor suppressing foam.

(c) A container used to meet the requirements of either paragraph (b)(2) or (b)(3) of this section shall be equipped with covers and closure devices, as applicable to the container, that are composed of suitable materials to minimize exposure of the regulated-material to the atmosphere and to maintain the equipment integrity for as long as it is in service. Factors to be considered when selecting the materials for and designing the cover and closure devices shall include: organic vapor permeability, the effects of contact with the material or its vapor managed in the container; the effects of outdoor exposure to wind, moisture, and sunlight; and the operating practices used for container on which the cover is installed.

(d) Whenever a regulated-material is in a container using Container Level 1 controls, the owner or operator shall install all covers and closure devices for the container, and secure and maintain each closure device in the closed position except as follows:

(1) Opening of a closure device or cover is allowed for the purpose of adding material to the container as follows:

(i) In the case when the container is filled to the intended final level in one continuous operation, the owner or operator shall promptly secure the closure devices in the closed position and install the covers, as applicable to the container, upon conclusion of the filling operation.

(ii) In the case when discrete quantities or batches of material intermittently are added to the container over a period of time, the owner or operator shall promptly secure the closure devices in the closed position and install covers, as applicable to the container, upon either: the container being filled to the intended final level; the completion of a batch loading after which no additional material will be added to the container within 15 minutes; the person performing the loading operation leaves the immediate vicinity of the container; or the shutdown of the process generating the material being added to the container, whichever condition occurs first.

(2) Opening of a closure device or cover is allowed for the purpose of removing material from the container as follows:

(i) For the purpose of meeting the requirements of this section, an empty container as defined in § 63.921 of this subpart may be open to the atmosphere at any time (e.g., covers and closure devices are not required to be secured in the closed position on an empty container).

(ii) In the case when discrete quantities or batches of material are removed from the container but the container does not meet the conditions to be an empty container as defined in § 63.921 of this subpart, the owner or operator shall promptly secure the closure devices in the closed position and install covers, as applicable to the container, upon the completion of a batch removal after which no additional material will be removed from the container within 15 minutes, or the person performing the unloading operation leaves the immediate vicinity of the container, whichever condition occurs first.

(3) Opening of a closure device or cover is allowed when access inside the container is needed to perform routine activities other than transfer of regulated-material. Examples of such activities include those times when a worker needs to open a port to measure the depth of or sample the material in the container, or when a worker needs to open a manhole hatch to access equipment inside the container. Following completion of the activity, the owner or operator shall promptly secure the closure device in the closed position or reinstall the cover, as applicable to the container.

(4) Opening of a spring-loaded pressure-vacuum relief valve, conservation vent, or similar type of pressure relief device which vents to the atmosphere is allowed during normal operations for the purpose of maintaining the container internal pressure in accordance with the container design specifications. The device shall be designed to operate with no detectable organic emissions when the device is secured in the closed position. The settings at which the device opens shall be established such that the device remains in the closed position whenever the container internal pressure is within the internal pressure operating range determined by the owner or operator based on container manufacturer recommendations, applicable regulations, fire protection and prevention codes, standard engineering codes and practices, or other requirements for the safe handling of flammable, ignitable, explosive, reactive, or hazardous materials. Examples of normal operating conditions that may require these devices to open are during those times when the container internal pressure exceeds the internal pressure operating range for the container as a result of loading operations or diurnal ambient temperature fluctuations.

(5) Opening of a safety device, as defined in § 63.921 of this subpart, is allowed at any time conditions require it to do so to avoid an unsafe condition.

(e) The owner or operator shall inspect containers using Container Level 1 controls in accordance with the procedures specified in § 63.926(a) of this subpart.

(f) For the purpose of compliance with paragraph (b)(1) of this section, containers shall be used that meet the applicable U.S. DOT regulations on packaging hazardous materials for transportation as follows:

(1) The container meets the applicable requirements specified in 49 CFR part 178—Specifications for Packagings or 49 CFR part 179—Specifications for Tank Cars.

(2) Regulated-material is managed in the container in accordance with the applicable requirements specified in 49 CFR part 107 subpart B—Exemptions; 49 CFR part 172—Hazardous Materials Table, Special Provisions, Hazardous Materials Communications, Emergency Response Information, and Training Requirements; 49 CFR part 173—Shippers—General Requirements for Shipments and Packaging; and 49 CFR part 180—Continuing Qualification and Maintenance of Packagings.

(3) For the purpose of complying with this subpart, no exceptions to the 49 CFR part 178 or part 179 regulations are allowed except as provided for in paragraph (f)(4) of this section.

(4) For a lab pack that is managed in accordance with the requirements of 49 CFR part 178 for the purpose of complying with this subpart, an owner or operator may comply with the exceptions for those packagings specified in 49 CFR 173.12(b).

§ 63.923 Standards—Container Level 2 controls.

(a) This section applies to owners and operators subject to this subpart and required to control air emissions from containers using Container Level 2 controls.

(b) A container using Container Level 2 controls is one of the following:

(1) A container that meets the applicable U.S. Department of Transportation (DOT) regulations on packaging hazardous materials for transportation as specified in paragraph (f) of this section.

(2) A container that has been demonstrated to operate with no detectable organic emissions as defined in § 63.921 of this subpart.

(3) A container that has been demonstrated within the preceding 12 months to be vapor-tight by using Method 27 in appendix A of 40 CFR part 60 in accordance with the procedure specified in § 63.925(b) of this subpart.

(c) Transfer of regulated-material in to or out of a container using Container Level 2 controls shall be conducted in such a manner as to minimize exposure of the regulated-material to the atmosphere, to the extent practical, considering the physical properties of the regulated-material and good engineering and safety practices for handling flammable, ignitable, explosive, or other hazardous materials. Examples of container loading procedures that meet the requirements of this paragraph include using any one of the following: a submerged-fill pipe or other submerged-fill method to load liquids into the container; a vapor-balancing system or a vapor-recovery system to collect and control the vapors displaced from the container during filling operations; or a fitted opening in the top of a container through which the regulated-material is filled, with subsequent purging of the transfer line before removing it from the container opening.

(d) Whenever a regulated-material is in a container using Container Level 2 controls, the owner or operator shall install all covers and closure devices for the container, and secure and maintain each closure device in the closed position except as follows:

(1) Opening of a closure device or cover is allowed for the purpose of adding material to the container as follows:

(i) In the case when the container is filled to the intended final level in one continuous operation, the owner or operator shall promptly secure the closure devices in the closed position and install the covers, as applicable to the container, upon conclusion of the filling operation.

(ii) In the case when discrete quantities or batches of material intermittently are added to the container over a period of time, the owner or operator shall promptly secure the closure devices in the closed position and install covers, as applicable to the container, upon either the container being filled

to the intended final level, the completion of a batch loading after which no additional material will be added to the container within 15 minutes, the person performing the loading operation leaves the immediate vicinity of the container, or the shutdown of the process generating the material being added to the container, whichever condition occurs first.

(2) Opening of a closure device or cover is allowed for the purpose of removing material from the container as follows:

(i) For the purpose of meeting the requirements of this section, an empty container as defined in § 63.921 of this subpart may be open to the atmosphere at any time (e.g., covers and closure devices are not required to be secured in the closed position on an empty container).

(ii) In the case when discrete quantities or batches of material are removed from the container but the container does not meet the conditions to be an empty container as defined in § 63.921 of this subpart, the owner or operator shall promptly secure the closure devices in the closed position and install covers, as applicable to the container, upon the completion of a batch removal after which no additional material will be removed from the container within 15 minutes or the person performing the unloading operation leaves the immediate vicinity of the container, whichever condition occurs first.

(3) Opening of a closure device or cover is allowed when access inside the container is needed to perform routine activities other than transfer of regulated-material. Examples of such activities include those times when a worker needs to open a port to measure the depth of or sample the material in the container, or when a worker needs to open a manhole hatch to access equipment inside the container. Following completion of the activity, the owner or operator shall promptly secure the closure device in the closed position or reinstall the cover, as applicable to the container.

(4) Opening of a spring-loaded pressure-vacuum relief valve, conservation vent, or similar type of pressure relief device which vents to the atmosphere is allowed during normal operations for the purpose of maintaining the container internal pressure in accordance with the container design specifications. The device shall be designed to operate with no detectable organic emissions when the device is secured in the closed position. The settings at which the device opens shall be established such that the device remains in the closed position whenever the container internal pressure is within the internal pressure operating range determined by the owner or operator based on container manufacturer recommendations, applicable regulations, fire protection and prevention codes, standard engineering codes and practices, or other requirements for the safe handling of flammable, combustible, explosive, reactive, or hazardous materials. Examples of normal operating conditions that may require these devices to open are during those times when the container internal pressure exceeds the internal pressure operating range for the container as a result of loading operations or diurnal ambient temperature fluctuations.

(5) Opening of a safety device, as defined in § 63.921 of this subpart, is allowed at any time conditions require it to do so to avoid an unsafe condition.

(e) The owner or operator shall inspect containers using Container Level 2 controls in accordance with the procedures specified in § 63.926(a) of this subpart.

(f) For the purpose of compliance with paragraph (b)(1) of this section, containers shall be used that meet the applicable U.S. DOT regulations on packaging hazardous materials for transportation as follows:

(1) The container meets the applicable requirements specified in 49 CFR part 178—Specifications for Packagings or 49 CFR part 179—Specifications for Tank Cars.

(2) Regulated-material is managed in the container in accordance with the applicable requirements specified in 49 CFR part 107 subpart B—Exemptions; 49 CFR part 172—Hazardous Materials Table, Special Provisions, Hazardous Materials Communications, Emergency Response Information, and Training Requirements; 49 CFR part 173—Shippers—General Requirements for Shipments and Packaging; and 49 CFR part 180—Continuing Qualification and Maintenance of Packagings.

(3) For the purpose of complying with this subpart, no exceptions to the 49 CFR part 178 or part 179 regulations are allowed except as provided for in paragraph (f)(4) of this section.

(4) For a lab pack that is managed in accordance with the requirements of 49 CFR part 178 for the purpose of complying with this subpart, an owner or operator may comply with the exceptions for those packagings specified in 49 CFR 173.12(b).

§ 63.924 Standards—Container Level 3 controls.

(a) This section applies to owners and operators subject to this subpart and required to control air emissions from containers using Container Level 3 controls.

(b) A container using Container Level 3 controls is one of the following:

(1) A container that is vented directly through a closed-vent system to a control device in accordance with the requirements of paragraphs (c)(2) of this section.

(2) A container that is vented inside an enclosure which is exhausted through a closed-vent system to a control device in accordance with the requirements of paragraphs (c)(1) and (c)(2) of this section.

(c) The owner or operator shall meet the following requirements as applicable to the type of air emission control equipment selected by the owner or operator:

(1) The enclosure shall be designed and operated in accordance with the criteria for a permanent total enclosure as specified in “Procedure T—Criteria for and Verification of a Permanent or Temporary Total Enclosure” under 40 CFR 52.741, appendix B. The enclosure may have permanent or temporary openings to allow worker access; passage of containers through the enclosure by conveyor or other mechanical means; entry of permanent mechanical or electrical equipment; or to direct airflow into the enclosure. The owner or operator shall perform the verification procedure for the enclosure as specified in Section 5.0 to “Procedure T—Criteria for and Verification of a Permanent or Temporary Total Enclosure” initially when the enclosure is first installed and, thereafter, annually.

(2) The closed-vent system and control device shall be designed and operated in accordance with the requirements of § 63.693.

(d) Safety devices, as defined in § 63.921 of this subpart, may be installed and operated as necessary on any container, enclosure, closed-vent system, or control device used to comply with this section.

[61 FR 34184, July 1, 1996, as amended at 66 FR 1267, Jan. 8, 2001]

§ 63.925 Test methods and procedures.

(a) Procedures for determining no detectable organic emissions for the purpose of complying with this subpart.

(1) The test shall be conducted in accordance with the procedures specified in Method 21 of 40 CFR part 60, appendix A. Each potential leak interface (i.e., a location where organic vapor leakage could occur) on the cover and associated closure devices shall be checked. Potential leak interfaces that are associated with covers and closure devices include, but are not limited to: the interface of the cover and its foundation mounting; the periphery of any opening on the cover and its associated closure device; and the sealing seat interface on a spring-loaded pressure-relief valve.

(2) The test shall be performed when the unit contains a material having a total organic concentration representative of the range of concentrations for the materials expected to be managed in the unit. During the test, the cover and closure devices shall be secured in the closed position.

(3) The detection instrument shall meet the performance criteria of Method 21 of 40 CFR part 60, appendix A, except the instrument response factor criteria in section 3.1.2(a) of Method 21 shall be for

the average composition of the organic constituents in the material placed in the unit, not for each individual organic constituent.

(4) The detection instrument shall be calibrated before use on each day of its use by the procedures specified in Method 21 of 40 CFR part 60, appendix A.

(5) Calibration gases shall be as follows:

(i) Zero air (less than 10 ppmv hydrocarbon in air); and

(ii) A mixture of methane or n-hexane in air at a concentration of approximately, but less than 10,000 ppmv.

(6) An owner or operator may choose to adjust or not adjust the detection instrument readings to account for the background organic concentration level. If an owner or operator chooses to adjust the instrument readings for the background level, the background level value must be determined according to the procedures in Method 21 of 40 CFR part 60, appendix A.

(7) Each potential leak interface shall be checked by traversing the instrument probe around the potential leak interface as close to the interface as possible, as described in Method 21. In the case when the configuration of the cover or closure device prevents a complete traverse of the interface, all accessible portions of the interface shall be sampled. In the case when the configuration of the closure device prevents any sampling at the interface and the device is equipped with an enclosed extension or horn (e.g., some pressure relief devices), the instrument probe inlet shall be placed at approximately the center of the exhaust area to the atmosphere.

(8) An owner or operator must determine if a potential leak interface operates with no detectable emissions using the applicable procedure specified in paragraph (a)(8)(i) or (a)(8)(ii) of this section.

(i) If an owner or operator chooses not to adjust the detection instrument readings for the background organic concentration level, then the maximum organic concentration value measured by the detection instrument is compared directly to the applicable value for the potential leak interface as specified in paragraph (a)(9) of this section.

(ii) If an owner or operator chooses to adjust the detection instrument readings for the background organic concentration level, the value of the arithmetic difference between the maximum organic concentration value measured by the instrument and the background organic concentration value as determined in paragraph (a)(6) of this section is compared with the applicable value for the potential leak interface as specified in paragraph (a)(9) of this section.

(9) A potential leak interface is determined to operate with no detectable emissions using the applicable criteria specified in paragraphs (a)(9)(i) and (a)(9)(ii) of this section.

(i) For a potential leak interface other than a seal around a shaft that passes through a cover opening, the potential leak interface is determined to operate with no detectable organic emissions if the organic concentration value determined in paragraph (a)(8) is less than 500 ppmv.

(ii) For a seal around a shaft that passes through a cover opening, the potential leak interface is determined to operate with no detectable organic emissions if the organic concentration value determined in paragraph (a)(8) is less than 10,000 ppmv.

(b) Procedure for determining a container to be vapor-tight for the purpose of complying with this subpart.

(1) The test shall be performed in accordance with Method 27 of 40 CFR part 60, appendix A of this chapter.

(2) A pressure measurement device shall be used that has a precision of ± 2.5 mm water and that is capable of measuring above the pressure at which the container is to be tested for vapor tightness.

(3) If the test results determined by Method 27 indicate that the container sustains a pressure change less than or equal to 750 Pascals within 5 minutes after it is pressurized to a minimum of 4,500 Pascals, then the container is determined to be vapor-tight.

[61 FR 34186, July 1, 1996, as amended at 64 FR 38987, July 20, 1999]

§ 63.926 Inspection and monitoring requirements.

(a) Owners and operators of containers using either Container Level 1 or Container Level 2 controls in accordance with the provisions of § 63.922 and § 63.923 of this subpart, respectively, shall inspect the container and its cover and closure devices as follows:

(1) In the case when a regulated-material already is in the container at the time the owner or operator first accepts possession of the container at the facility site and the container is not emptied (i.e., does not meet the conditions for an empty container as defined in § 63.921 of this subpart) within 24 hours after the container has been accepted at the facility site, the container and its cover and closure devices shall be visually inspected by the owner or operator to check for visible cracks, holes, gaps, or other open spaces into the interior of the container when the cover and closure devices are secured in the closed position. This inspection of the container must be conducted on or before the date that the container is accepted at the facility (i.e., the date that the container becomes subject to the standards under this subpart). For the purpose of this requirement, the date of acceptance is the date of signature of the facility owner or operator on the manifest or shipping papers accompanying the container. If a defect is detected, the owner or operator shall repair the defect in accordance with the requirements of paragraph (a)(3) of this section.

(2) In the case when a container filled or partially filled with regulated-material remains unopened at the facility site for a period of 1 year or more, the container and its cover and closure devices shall be visually inspected by the owner or operator initially and thereafter, at least once every calendar year, to check for visible cracks, holes, gaps, or other open spaces into the interior of the container when the cover and closure devices are secured in the closed position. If a defect is detected, the owner or operator shall repair the defect in accordance with the requirements of paragraph (a)(3) of this section.

(3) When a defect is detected for the container, cover, or closure devices, the owner or operator must either empty the regulated-material from the defective container in accordance with paragraph (a)(3)(i) of this section or repair the defective container in accordance with paragraph (a)(3)(ii) of this section.

(i) If the owner or operator elects to empty the regulated-material from the defective container, the owner or operator must remove the regulated-material from the defective container to meet the conditions for an empty container (as defined in § 63.921 of this subpart) and transfer the removed regulated-material to either a container that meets the applicable standards under this subpart or to a tank, process, or treatment unit that meets the applicable standards under the subpart referencing this subpart. Transfer of the regulated-material must be completed no later than 5 calendar days after detection of the defect. The emptied defective container must be either repaired, destroyed, or used for purposes other than management of regulated-material.

(ii) If the owner or operator elects not to empty the regulated-material from the defective container, the owner or operator must repair the defective container. First efforts at repair of the defect must be made no later than 24 hours after detection and repair must be completed as soon as possible but no later than 5 calendar days after detection. If repair of a defect cannot be completed within 5 calendar days, then the regulated-material must be emptied from the container and the container must not be used to manage regulated-material until the defect is repaired.

(b) Owners and operators using Container Level 3 controls in accordance with the provisions of § 63.924 of this subpart shall inspect and monitor the closed-vent systems and control devices in accordance with the requirements of § 63.693 in 40 CFR part 63, Subpart DD—National Emission Standards for Hazardous Air Pollutants from Off-Site Waste and Recovery Operations.

[61 FR 34186, July 1, 1996, as amended at 64 FR 38988, July 20, 1999]

§ 63.927 Recordkeeping requirements.

(a) Owners and operators that use Container Level 3 controls in accordance with the provisions of § 63.924 of this subpart shall prepare and maintain the following records:

(1) Records for the most recent set of calculations and measurements performed by the owner or operator to verify that the enclosure meets the criteria of a permanent total enclosure as specified in “Procedure T—Criteria for and Verification of a Permanent or Temporary Total Enclosure” under 40 CFR 52.741, appendix B.

(2) Records required for the closed-vent system and control device in accordance with the requirements of § 63.693 in 40 CFR part 63, Subpart DD—National Emission Standards for Hazardous Air Pollutants from Off-Site Waste and Recovery Operations.

(b) [Reserved]

§ 63.928 Reporting requirements.

(a) For owners and operators that use Container Level 3 controls in accordance with the provisions of § 63.924 of this subpart, the owner or operator shall prepare and submit to the Administrator the reports required for closed-vent systems and control devices in accordance with the requirements of § 63.693 in 40 CFR part 63, Subpart DD—National Emission Standards for Hazardous Air Pollutant Standards from Off-Site Waste and Recovery Operations.

(b) [Reserved]

§ 63.929 Implementation and enforcement.

(a) This subpart can be implemented and enforced by the U.S. EPA, or a delegated authority such as the applicable State, local, or Tribal agency. If the U.S. EPA Administrator has delegated authority to a State, local, or Tribal agency, then that agency, in addition to the U.S. EPA, has the authority to implement and enforce this subpart. Contact the applicable U.S. EPA Regional Office to find out if this subpart is delegated to a State, local, or Tribal agency.

(b) In delegating implementation and enforcement authority of this subpart to a State, local, or Tribal agency under subpart E of this part, the authorities contained in paragraph (c) of this section are retained by the Administrator of U.S. EPA and cannot be transferred to the State, local, or Tribal agency.

(c) The authorities that cannot be delegated to State, local, or Tribal agencies are as specified in paragraphs (c)(1) through (4) of this section.

(1) Approval of alternatives to the requirements in §§ 63.920 and 63.922 through 63.924. Where these standards reference another subpart, the cited provisions will be delegated according to the delegation provisions of the referenced subpart.

(2) Approval of major alternatives to test methods under § 63.7(e)(2)(ii) and (f), as defined in § 63.90, and as required in this subpart.

(3) Approval of major alternatives to monitoring under § 63.8(f), as defined in § 63.90, and as required in this subpart.

(4) Approval of major alternatives to recordkeeping and reporting under § 63.10(f), as defined in § 63.90, and as required in this subpart.

[68 FR 37355, June 23, 2003]

For questions or comments regarding e-CFR editorial content, features, or design, email ecfr@nara.gov.
For questions concerning e-CFR programming and delivery issues, email webteam@gpo.gov.

Appendix K – 40 CFR Part 63, Subpart EEE

ELECTRONIC CODE OF FEDERAL REGULATIONS

e-CFR Data is current as of August 30, 2013

Title 40: Protection of Environment

PART 63—NATIONAL EMISSION STANDARDS FOR HAZARDOUS AIR POLLUTANTS FOR SOURCE CATEGORIES (CONTINUED)

Subpart **EEE**—National Emission Standards for Hazardous Air Pollutants from Hazardous Waste Combustors

Contents

GENERAL

- § 63.1200 Who is subject to these regulations?
- § 63.1201 Definitions and acronyms used in this subpart.
- § 63.1202 [Reserved]

INTERIM EMISSIONS STANDARDS AND OPERATING LIMITS FOR INCINERATORS, CEMENT KILNS, AND LIGHTWEIGHT AGGREGATE KILNS

- § 63.1203 What are the standards for hazardous waste incinerators that are effective until compliance with the standards under § 63.1219?
- § 63.1204 What are the standards for hazardous waste burning cement kilns that are effective until compliance with the standards under § 63.1220?
- § 63.1205 What are the standards for hazardous waste burning lightweight aggregate kilns that are effective until compliance with the standards under § 63.1221?

MONITORING AND COMPLIANCE PROVISIONS

- § 63.1206 When and how must you comply with the standards and operating requirements?
- § 63.1207 What are the performance testing requirements?
- § 63.1208 What are the test methods?
- § 63.1209 What are the monitoring requirements?

NOTIFICATION, REPORTING AND RECORDKEEPING

- § 63.1210 What are the notification requirements?
- § 63.1211 What are the recordkeeping and reporting requirements?

OTHER

- § 63.1212 What are the other requirements pertaining to the NIC?
- § 63.1213 How can the compliance date be extended to install pollution prevention or waste minimization controls?
- § 63.1214 Implementation and enforcement.
- § 63.1215 What are the health-based compliance alternatives for total chlorine?

EMISSIONS STANDARDS AND OPERATING LIMITS FOR SOLID FUEL BOILERS, LIQUID FUEL BOILERS, AND HYDROCHLORIC ACID PRODUCTION FURNACES

- § 63.1216 What are the standards for solid fuel boilers that burn hazardous waste?
 § 63.1217 What are the standards for liquid fuel boilers that burn hazardous waste?
 § 63.1218 What are the standards for hydrochloric acid production furnaces that burn hazardous waste?

REPLACEMENT EMISSIONS STANDARDS AND OPERATING LIMITS FOR INCINERATORS, CEMENT KILNS, AND LIGHTWEIGHT AGGREGATE KILNS

- § 63.1219 What are the replacement standards for hazardous waste incinerators?
 § 63.1220 What are the replacement standards for hazardous waste burning cement kilns?
 § 63.1221 What are the replacement standards for hazardous waste burning lightweight aggregate kilns?
 Table 1 to Subpart EEE of Part 63—General Provisions Applicable to Subpart EEE
 Appendix to Subpart EEE of Part 63—Quality Assurance Procedures for Continuous Emissions Monitors Used for Hazardous Waste Combustors

SOURCE: 64 FR 53038, Sept. 30, 1999, unless otherwise noted.

General

§ 63.1200 Who is subject to these regulations?

The provisions of this subpart apply to all hazardous waste combustors: hazardous waste incinerators, hazardous waste cement kilns, hazardous waste lightweight aggregate kilns, hazardous waste solid fuel boilers, hazardous waste liquid fuel boilers, and hazardous waste hydrochloric acid production furnaces. Hazardous waste combustors are also subject to applicable requirements under parts 260 through 270 of this chapter.

(a) *What if I am an area source?* (1) Both area sources and major sources are subject to this subpart.

(2) Both area sources and major sources subject to this subpart, but not previously subject to title V, are immediately subject to the requirement to apply for and obtain a title V permit in all States, and in areas covered by part 71 of this chapter.

(b) These regulations in this subpart do not apply to sources that meet the criteria in Table 1 of this Section, as follows:

TABLE 1 TO § 63.1200—HAZARDOUS WASTE COMBUSTORS EXEMPT FROM SUBPART EEE

If	And if	Then
(1) You are a previously affected source	(i) You ceased feeding hazardous waste for a period of time greater than the hazardous waste residence time (i.e., hazardous waste no longer resides in the combustion chamber); (ii) You have initiated the closure requirements of subpart G, parts 264 or 265 of this chapter; (iii) You begin complying with the requirements of all other applicable standards of this part (Part 63); and (iv) You notify the Administrator in writing that you are no longer an affected source under this subpart (Subpart EEE)	You are no longer subject to this subpart (Subpart EEE).
(2) You are a research,	You operate for no longer than one year after first burning hazardous waste (Note that the Administrator can extend this one-	You are not subject to this subpart (Subpart EEE). This exemption applies even if there

development, and demonstration source	year restriction on a case-by-case basis upon your written request documenting when you first burned hazardous waste and the justification for needing additional time to perform research, development, or demonstration operations).	is a hazardous waste combustor at the plant site that is regulated under this subpart. You still, however, remain subject to § 270.65 of this chapter.
(3) The only hazardous wastes you burn are exempt from regulation under § 266.100(c) of this chapter		You are not subject to the requirements of this subpart (Subpart EEE).
(4) You meet the definition of a small quantity burner under § 266.108 of this chapter		You are not subject to the requirements of this subpart (Subpart EEE).

(c) Table 1 of this section specifies the provisions of subpart A (General Provisions, §§ 63.1-63.15) that apply and those that do not apply to sources affected by this subpart.

[64 FR 53038, Sept. 30, 1999, as amended at 65 FR 42297, July 10, 2000; 67 FR 6986, Feb. 14, 2002; 70 FR 59540, Oct. 12, 2005]

§ 63.1201 Definitions and acronyms used in this subpart.

(a) The terms used in this subpart are defined in the Act, in subpart A of this part, or in this section as follows:

Air pollution control system means the equipment used to reduce the release of particulate matter and other pollutants to the atmosphere.

Automatic waste feed cutoff (AWFCO) system means a system comprised of cutoff valves, actuator, sensor, data manager, and other necessary components and electrical circuitry designed, operated and maintained to stop the flow of hazardous waste to the combustion unit automatically and immediately (except as provided by § 63.1206(c)(3)(viii)) when any operating requirement is exceeded.

Btu means British Thermal Units.

By-pass duct means a device which diverts a minimum of 10 percent of a cement kiln's off gas, or a device which the Administrator determines on a case-by-case basis diverts a sample of kiln gas that contains levels of carbon monoxide or hydrocarbons representative of the levels in the kiln.

Combustion chamber means the area in which controlled flame combustion of hazardous waste occurs.

Continuous monitor means a device which continuously samples the regulated parameter specified in § 63.1209 without interruption, evaluates the detector response at least once every 15 seconds, and computes and records the average value at least every 60 seconds, except during allowable periods of calibration and except as defined otherwise by the CEMS Performance Specifications in appendix B, part 60 of this chapter.

Dioxin/furan and dioxins and furans mean tetra-, penta-, hexa-, hepta-, and octa-chlorinated dibenzo dioxins and furans.

Existing source means any affected source that is not a new source.

Feedrate operating limits means limits on the feedrate of materials (e.g., metals, chlorine) to the combustor that are established based on comprehensive performance testing. The limits are established and monitored by knowing the concentration of the limited material (e.g., chlorine) in each feedstream and the flowrate of each feedstream.

Feedstream means any material fed into a hazardous waste combustor, including, but not limited to, any pumpable or nonpumpable solid, liquid, or gas.

Flowrate means the rate at which a feedstream is fed into a hazardous waste combustor.

Hazardous waste is defined in § 261.3 of this chapter.

Hazardous waste burning cement kiln means a rotary kiln and any associated preheater or precalciner devices that produce clinker by heating limestone and other materials for subsequent production of cement for use in commerce, and that burns hazardous waste at any time.

Hazardous waste combustor means a hazardous waste incinerator, hazardous waste burning cement kiln, hazardous waste burning lightweight aggregate kiln, hazardous waste liquid fuel boiler, hazardous waste solid fuel boiler, or hazardous waste hydrochloric acid production furnace.

Hazardous waste hydrochloric acid production furnace and *Hazardous Waste HCl production furnace* mean a halogen acid furnace defined under § 260.10 of this chapter that produces aqueous hydrochloric acid (HCl) product and that burns hazardous waste at any time.

Hazardous waste incinerator means a device defined as an incinerator in § 260.10 of this chapter and that burns hazardous waste at any time. For purposes of this subpart, the hazardous waste incinerator includes all associated firing systems and air pollution control devices, as well as the combustion chamber equipment.

Hazardous waste lightweight aggregate kiln means a rotary kiln that produces clinker by heating materials such as slate, shale and clay for subsequent production of lightweight aggregate used in commerce, and that burns hazardous waste at any time.

Hazardous waste liquid fuel boiler means a boiler defined under § 260.10 of this chapter that does not burn solid fuels and that burns hazardous waste at any time. Liquid fuel boiler includes boilers that only burn gaseous fuel.

Hazardous waste residence time means the time elapsed from cutoff of the flow of hazardous waste into the combustor (including, for example, the time required for liquids to flow from the cutoff valve into the combustor) until solid, liquid, and gaseous materials from the hazardous waste (excluding residues that may adhere to combustion chamber surfaces and excluding waste-derived recycled materials such as cement kiln dust and internally recycled metals) exit the combustion chamber. For combustors with multiple firing systems whereby the residence time may vary for the firing systems, the hazardous waste residence time for purposes of complying with this subpart means the longest residence time for any firing system in use at the time of the waste cutoff.

Hazardous waste solid fuel boiler means a boiler defined under § 260.10 of this chapter that burns a solid fuel and that burns hazardous waste at any time.

Initial comprehensive performance test means the comprehensive performance test that is used as the basis for initially demonstrating compliance with the standards.

In-line kiln raw mill means a hazardous waste burning cement kiln design whereby kiln gas is ducted through the raw material mill for portions of time to facilitate drying and heating of the raw material.

Instantaneous monitoring for combustion system leak control means detecting and recording pressure, without use of an averaging period, at a frequency adequate to detect combustion system leak events from hazardous waste combustion.

Monovent means an exhaust configuration of a building or emission control device (e.g. positive pressure fabric filter) that extends the length of the structure and has a width very small in relation to its length (i.e., length to width ratio is typically greater than 5:1). The exhaust may be an open vent with or without a roof, louvered vents, or a combination of such features.

MTEC means maximum theoretical emissions concentration of metals or HCl/Cl, expressed as µg/dscm, and is calculated by dividing the feedrate by the gas flowrate.

New source means any affected source the construction or reconstruction of which is commenced after the dates specified under §§ 63.1206(a)(1)(i)(B), (a)(1)(ii)(B), and (a)(2)(ii).

One-minute average means the average of detector responses calculated at least every 60 seconds from responses obtained at least every 15 seconds.

Operating record means a documentation retained at the facility for ready inspection by authorized officials of all information required by the standards to document and maintain compliance with the applicable regulations, including data and information, reports, notifications, and communications with regulatory officials.

Operating requirements means operating terms or conditions, limits, or operating parameter limits developed under this subpart that ensure compliance with the emission standards.

Preheater tower combustion gas monitoring location means a location within the preheater tower of a dry process cement kiln downstream (in terms of gas flow) of all hazardous waste firing locations and where a representative sample of combustion gas to measure combustion efficiency can be monitored.

Raw material feed means the prepared and mixed materials, which include but are not limited to materials such as limestone, clay, shale, sand, iron ore, mill scale, cement kiln dust and flyash, that are fed to a cement or lightweight aggregate kiln. Raw material feed does not include the fuels used in the kiln to produce heat to form the clinker product.

Research, development, and demonstration source means a source engaged in laboratory, pilot plant, or prototype demonstration operations:

- (1) Whose primary purpose is to conduct research, development, or short-term demonstration of an innovative and experimental hazardous waste treatment technology or process; and
- (2) Where the operations are under the close supervision of technically-trained personnel.

Rolling average means the average of all one-minute averages over the averaging period.

Run means the net period of time during which an air emission sample is collected under a given set of operating conditions. Three or more runs constitutes a test. Unless otherwise specified, a run may be either intermittent or continuous.

Run average means the average of the one-minute average parameter values for a run.

System removal efficiency means $[1 - \text{Emission Rate (mass/time)} / \text{Feedrate (mass/time)}] \times 100$.

TEQ means the international method of expressing toxicity equivalents for dioxins and furans as defined in U.S. EPA, Interim Procedures for Estimating Risks Associated with Exposures to Mixtures of Chlorinated Dibenzo-p-dioxins and -dibenzofurans (CDDs and CDFs) and 1989 Update, March 1989.

You means the owner or operator of a hazardous waste combustor.

(b) The acronyms used in this subpart refer to the following:

AWFCO means automatic waste feed cutoff.

CAS means chemical abstract services registry.

CEMS means continuous emissions monitoring system.

CMS means continuous monitoring system.

DRE means destruction and removal efficiency.

MACT means maximum achievable control technology.

MTEC means maximum theoretical emissions concentration.

NIC means notification of intent to comply.

[64 FR 53038, Sept. 30, 1999, as amended at 65 FR 42297, July 10, 2000; 65 FR 67271, Nov. 9, 2000; 66 FR 35103, July 3, 2001; 67 FR 6986, Feb. 14, 2002; 67 FR 77691, Dec. 19, 2002; 70 FR 59540, Oct. 12, 2005]

§ 63.1202 [Reserved]

Interim Emissions Standards and Operating Limits For Incinerators, Cement Kilns, and Lightweight Aggregate Kilns

§ 63.1203 What are the standards for hazardous waste incinerators that are effective until compliance with the standards under § 63.1219?

(a) *Emission limits for existing sources.* You must not discharge or cause combustion gases to be emitted into the atmosphere that contain:

(1) For dioxins and furans:

(i) Emissions in excess of 0.20 ng TEQ/dscm corrected to 7 percent oxygen; or

(ii) Emissions in excess of 0.40 ng TEQ/dscm corrected to 7 percent oxygen provided that the combustion gas temperature at the inlet to the initial particulate matter control device is 400 °F or lower based on the average of the test run average temperatures. (For purposes of compliance, operation of a wet particulate control device is presumed to meet the 400 °F or lower requirement);

(2) Mercury in excess of 130 µg/dscm corrected to 7 percent oxygen;

(3) Lead and cadmium in excess of 240 µg/dscm, combined emissions, corrected to 7 percent oxygen;

(4) Arsenic, beryllium, and chromium in excess of 97 µg/dscm, combined emissions, corrected to 7 percent oxygen;

(5) For carbon monoxide and hydrocarbons, either:

(i) Carbon monoxide in excess of 100 parts per million by volume, over an hourly rolling average (monitored continuously with a continuous emissions monitoring system), dry basis and corrected to 7 percent oxygen. If you elect to comply with this carbon monoxide standard rather than the hydrocarbon standard under paragraph (a)(5)(ii) of this section, you must also document that, during the destruction and removal efficiency (DRE) test runs or their equivalent as provided by § 63.1206(b)(7), hydrocarbons do not exceed 10 parts per million by volume during those runs, over an hourly rolling average (monitored continuously with a continuous emissions monitoring system), dry basis, corrected to 7 percent oxygen, and reported as propane; or

(ii) Hydrocarbons in excess of 10 parts per million by volume, over an hourly rolling average (monitored continuously with a continuous emissions monitoring system), dry basis, corrected to 7 percent oxygen, and reported as propane;

(6) Hydrochloric acid and chlorine gas in excess of 77 parts per million by volume, combined emissions, expressed as hydrochloric acid equivalents, dry basis and corrected to 7 percent oxygen; and

(7) Particulate matter in excess of 34 mg/dscm corrected to 7 percent oxygen.

(b) *Emission limits for new sources.* You must not discharge or cause combustion gases to be emitted into the atmosphere that contain:

(1) Dioxins and furans in excess of 0.20 ng TEQ/dscm, corrected to 7 percent oxygen;

(2) Mercury in excess of 45 µg/dscm corrected to 7 percent oxygen;

(3) Lead and cadmium in excess of 120 µg/dscm, combined emissions, corrected to 7 percent oxygen;

(4) Arsenic, beryllium, and chromium in excess of 97 µg/dscm, combined emissions, corrected to 7 percent oxygen;

(5) For carbon monoxide and hydrocarbons, either:

(i) Carbon monoxide in excess of 100 parts per million by volume, over an hourly rolling average (monitored continuously with a continuous emissions monitoring system), dry basis and corrected to 7 percent oxygen. If you elect to comply with this carbon monoxide standard rather than the hydrocarbon standard under paragraph (b)(5)(ii) of this section, you must also document that, during the destruction and removal efficiency (DRE) test runs or their equivalent as provided by § 63.1206(b)(7), hydrocarbons do not exceed 10 parts per million by volume during those runs, over an hourly rolling average (monitored continuously with a continuous emissions monitoring system), dry basis, corrected to 7 percent oxygen, and reported as propane; or

(ii) Hydrocarbons in excess of 10 parts per million by volume, over an hourly rolling average (monitored continuously with a continuous emissions monitoring system), dry basis, corrected to 7 percent oxygen, and reported as propane;

(6) Hydrochloric acid and chlorine gas in excess of 21 parts per million by volume, combined emissions, expressed as hydrochloric acid equivalents, dry basis and corrected to 7 percent oxygen; and

(7) Particulate matter in excess of 34 mg/dscm corrected to 7 percent oxygen.

(c) *Destruction and removal efficiency (DRE) standard* —(1) *99.99% DRE.* Except as provided in paragraph (c)(2) of this section, you must achieve a destruction and removal efficiency (DRE) of 99.99% for each principle organic hazardous constituent (POHC) designated under paragraph (c)(3) of this section. You must calculate DRE for each POHC from the following equation:

$$\text{DRE} = [1 - (W_{\text{out}} / W_{\text{in}})] \times 100\%$$

Where:

W_{in} = mass feedrate of one principal organic hazardous constituent (POHC) in a waste feedstream; and

W_{out} = mass emission rate of the same POHC present in exhaust emissions prior to release to the atmosphere.

(2) *99.9999% DRE.* If you burn the dioxin-listed hazardous wastes F020, F021, F022, F023, F026, or F027 (see § 261.31 of this chapter), you must achieve a destruction and removal efficiency (DRE) of 99.9999% for each principle organic hazardous constituent (POHC) that you designate under paragraph (c)(3) of this section. You must demonstrate this DRE performance on POHCs that are more difficult to incinerate than tetra-, penta-, and hexachlorodibenzo- *p* -dioxins and dibenzofurans. You must use the equation in paragraph (c)(1) of this section to calculate DRE for each POHC. In

addition, you must notify the Administrator of your intent to incinerate hazardous wastes F020, F021, F022, F023, F026, or F027.

(3) *Principal organic hazardous constituents (POHCs)*. (i) You must treat the Principal Organic Hazardous Constituents (POHCs) in the waste feed that you specify under paragraph (c)(3)(ii) of this section to the extent required by paragraphs (c)(1) and (c)(2) of this section.

(ii) You must specify one or more POHCs that are representative of the most difficult to destroy organic compounds in your hazardous waste feedstream. You must base this specification on the degree of difficulty of incineration of the organic constituents in the hazardous waste and on their concentration or mass in the hazardous waste feed, considering the results of hazardous waste analyses or other data and information.

(d) *Significant figures*. The emission limits provided by paragraphs (a) and (b) of this section are presented with two significant figures. Although you must perform intermediate calculations using at least three significant figures, you may round the resultant emission levels to two significant figures to document compliance.

(e) The provisions of this section no longer apply after any of the following dates, whichever occurs first:

(1) The date that your source begins to comply with § 63.1219 by placing a Documentation of Compliance in the operating record pursuant to § 63.1211(c);

(2) The date that your source begins to comply with § 63.1219 by submitting a Notification of Compliance pursuant to § 63.1210(b); or

(3) The date for your source to comply with § 63.1219 pursuant to § 63.1206 and any extensions granted there under.

[67 FR 6809, Feb. 13, 2002, as amended at 70 FR 59541, Oct. 12, 2005; 73 FR 18979, Apr. 8, 2008]

§ 63.1204 What are the standards for hazardous waste burning cement kilns that are effective until compliance with the standards under § 63.1220?

(a) *Emission limits for existing sources*. You must not discharge or cause combustion gases to be emitted into the atmosphere that contain:

(1) For dioxins and furans:

(i) Emissions in excess of 0.20 ng TEQ/dscm corrected to 7 percent oxygen; or

(ii) Emissions in excess of 0.40 ng TEQ/dscm corrected to 7 percent oxygen provided that the combustion gas temperature at the inlet to the initial dry particulate matter control device is 400 °F or lower based on the average of the test run average temperatures;

(2) Mercury in excess of 120 µg/dscm corrected to 7 percent oxygen;

(3) Lead and cadmium in excess of 330 µg/dscm, combined emissions, corrected to 7 percent oxygen;

(4) Arsenic, beryllium, and chromium in excess of 56 µg/dscm, combined emissions, corrected to 7 percent oxygen;

(5) *Carbon monoxide and hydrocarbons*. (i) For kilns equipped with a by-pass duct or midkiln gas sampling system, either:

(A) Carbon monoxide in the by-pass duct or mid-kiln gas sampling system in excess of 100 parts per million by volume, over an hourly rolling average (monitored continuously with a continuous emissions monitoring system), dry basis and corrected to 7 percent oxygen. If you elect to comply with

this carbon monoxide standard rather than the hydrocarbon standard under paragraph (a)(5)(i)(B) of this section, you must also document that, during the destruction and removal efficiency (DRE) test runs or their equivalent as provided by § 63.1206(b)(7), hydrocarbons in the by-pass duct or mid-kiln gas sampling system do not exceed 10 parts per million by volume during those runs, over an hourly rolling average (monitored continuously with a continuous emissions monitoring system), dry basis, corrected to 7 percent oxygen, and reported as propane; or

(B) Hydrocarbons in the by-pass duct or midkiln gas sampling system in excess of 10 parts per million by volume, over an hourly rolling average (monitored continuously with a continuous emissions monitoring system), dry basis, corrected to 7 percent oxygen, and reported as propane;

(ii) For kilns not equipped with a by-pass duct or midkiln gas sampling system, either:

(A) Hydrocarbons in the main stack in excess of 20 parts per million by volume, over an hourly rolling average (monitored continuously with a continuous emissions monitoring system), dry basis, corrected to 7 percent oxygen, and reported as propane; or

(B) Carbon monoxide in the main stack in excess of 100 parts per million by volume, over an hourly rolling average (monitored continuously with a continuous emissions monitoring system), dry basis and corrected to 7 percent oxygen. If you elect to comply with this carbon monoxide standard rather than the hydrocarbon standard under paragraph (a)(5)(ii)(A) of this section, you also must document that, during the destruction and removal efficiency (DRE) test runs or their equivalent as provided by § 63.1206(b)(7), hydrocarbons in the main stack do not exceed 20 parts per million by volume during those runs, over an hourly rolling average (monitored continuously with a continuous emissions monitoring system), dry basis, corrected to 7 percent oxygen, and reported as propane.

(6) Hydrochloric acid and chlorine gas in excess of 130 parts per million by volume, combined emissions, expressed as hydrochloric acid equivalents, dry basis, corrected to 7 percent oxygen; and

(7) Particulate matter in excess of 0.15 kg/Mg dry feed and opacity greater than 20 percent.

(i) You must use suitable methods to determine the kiln raw material feedrate.

(ii) Except as provided in paragraph (a)(7)(iii) of this section, you must compute the particulate matter emission rate, E , from the following equation:

$$E = (C_s \times Q_{sd}) / P$$

Where:

E = emission rate of particulate matter, kg/Mg of kiln raw material feed;

C_s = concentration of particulate matter, kg/dscm;

Q_{sd} = volumetric flowrate of effluent gas, dscm/hr; and

P = total kiln raw material feed (dry basis), Mg/hr.

(iii) If you operate a preheater or preheater/precalciner kiln with dual stacks, you must test simultaneously and compute the combined particulate matter emission rate, E_c , from the following equation:

$$E_c = (C_{sk} \times Q_{sdk} + C_{sb} \times Q_{sdb}) / P$$

Where:

E_c = the combined emission rate of particulate matter from the kiln and bypass stack, kg/Mg of kiln raw material feed;

C_{sk} = concentration of particulate matter in the kiln effluent, kg/dscm;

Q_{sdk} = volumetric flowrate of kiln effluent gas, dscm/hr;

C_{sb} = concentration of particulate matter in the bypass stack effluent, kg/dscm;

Q_{sdb} = volumetric flowrate of bypass stack effluent gas, dscm/hr; and

P = total kiln raw material feed (dry basis), Mg/hr.

(b) *Emission limits for new sources.* You must not discharge or cause combustion gases to be emitted into the atmosphere that contain:

(1) For dioxins and furans:

(i) Emissions in excess of 0.20 ng TEQ/dscm corrected to 7 percent oxygen; or

(ii) Emissions in excess of 0.40 ng TEQ/dscm corrected to 7 percent oxygen provided that the combustion gas temperature at the inlet to the initial dry particulate matter control device is 400 °F or lower based on the average of the test run average temperatures;

(2) Mercury in excess of 120 µg/dscm corrected to 7 percent oxygen;

(3) Lead and cadmium in excess of 180 µg/dscm, combined emissions, corrected to 7 percent oxygen;

(4) Arsenic, beryllium, and chromium in excess of 54 µg/dscm, combined emissions, corrected to 7 percent oxygen;

(5) *Carbon monoxide and hydrocarbons.* (i) For kilns equipped with a by-pass duct or midkiln gas sampling system, carbon monoxide and hydrocarbons emissions are limited in both the bypass duct or midkiln gas sampling system and the main stack as follows:

(A) Emissions in the by-pass or midkiln gas sampling system are limited to either:

(1) Carbon monoxide in excess of 100 parts per million by volume, over an hourly rolling average (monitored continuously with a continuous emissions monitoring system), dry basis and corrected to 7 percent oxygen. If you elect to comply with this carbon monoxide standard rather than the hydrocarbon standard under paragraph (b)(5)(i)(A)(2) of this section, you also must document that, during the destruction and removal efficiency (DRE) test runs or their equivalent as provided by § 63.1206(b)(7), hydrocarbons do not exceed 10 parts per million by volume during those runs, over an hourly rolling average (monitored continuously with a continuous emissions monitoring system), dry basis, corrected to 7 percent oxygen, and reported as propane; or

(2) Hydrocarbons in the by-pass duct or midkiln gas sampling system in excess of 10 parts per million by volume, over an hourly rolling average (monitored continuously with a continuous emissions monitoring system), dry basis, corrected to 7 percent oxygen, and reported as propane; and

(B) Hydrocarbons in the main stack are limited, if construction of the kiln commenced after April 19, 1996 at a plant site where a cement kiln (whether burning hazardous waste or not) did not previously exist, to 50 parts per million by volume, over a 30-day block average (monitored continuously with a continuous monitoring system), dry basis, corrected to 7 percent oxygen, and reported as propane.

(ii) For kilns not equipped with a by-pass duct or midkiln gas sampling system, hydrocarbons and carbon monoxide are limited in the main stack to either:

(A) Hydrocarbons not exceeding 20 parts per million by volume, over an hourly rolling average (monitored continuously with a continuous emissions monitoring system), dry basis, corrected to 7 percent oxygen, and reported as propane; or

(B)(1) Carbon monoxide not exceeding 100 parts per million by volume, over an hourly rolling average (monitored continuously with a continuous emissions monitoring system), dry basis, corrected to 7 percent oxygen; and

(2) Hydrocarbons not exceeding 20 parts per million by volume, over an hourly rolling average (monitored continuously with a continuous monitoring system), dry basis, corrected to 7 percent oxygen, and reported as propane at any time during the destruction and removal efficiency (DRE) test runs or their equivalent as provided by § 63.1206(b)(7); and

(3) If construction of the kiln commenced after April 19, 1996 at a plant site where a cement kiln (whether burning hazardous waste or not) did not previously exist, hydrocarbons are limited to 50 parts per million by volume, over a 30-day block average (monitored continuously with a continuous monitoring system), dry basis, corrected to 7 percent oxygen, and reported as propane.

(6) Hydrochloric acid and chlorine gas in excess of 86 parts per million, combined emissions, expressed as hydrochloric acid equivalents, dry basis and corrected to 7 percent oxygen; and

(7) Particulate matter in excess of 0.15 kg/Mg dry feed and opacity greater than 20 percent.

(i) You must use suitable methods to determine the kiln raw material feedrate.

(ii) Except as provided in paragraph (a)(7)(iii) of this section, you must compute the particulate matter emission rate, E , from the equation specified in paragraph (a)(7)(ii) of this section.

(iii) If you operate a preheater or preheater/precalciner kiln with dual stacks, you must test simultaneously and compute the combined particulate matter emission rate, E_c , from the equation specified in paragraph (a)(7)(iii) of this section.

(c) *Destruction and removal efficiency (DRE) standard* —(1) *99.99% DRE*. Except as provided in paragraph (c)(2) of this section, you must achieve a destruction and removal efficiency (DRE) of 99.99% for each principle organic hazardous constituent (POHC) designated under paragraph (c)(3) of this section. You must calculate DRE for each POHC from the following equation:

$$DRE = [1 - (W_{out} / W_{in})] \times 100\%$$

Where:

W_{in} =mass feedrate of one principal organic hazardous constituent (POHC) in a waste feedstream; and

W_{out} =mass emission rate of the same POHC present in exhaust emissions prior to release to the atmosphere.

(2) *99.9999% DRE*. If you burn the dioxin-listed hazardous wastes F020, F021, F022, F023, F026, or F027 (see § 261.31 of this chapter), you must achieve a destruction and removal efficiency (DRE) of 99.9999% for each principle organic hazardous constituent (POHC) that you designate under paragraph (c)(3) of this section. You must demonstrate this DRE performance on POHCs that are more difficult to incinerate than tetra-, penta-, and hexachlorodibenzo- *p* -dioxins and dibenzofurans. You must use the equation in paragraph (c)(1) of this section to calculate DRE for each POHC. In addition, you must notify the Administrator of your intent to incinerate hazardous wastes F020, F021, F022, F023, F026, or F027.

(3) *Principal organic hazardous constituents (POHCs)*. (i) You must treat the Principal Organic Hazardous Constituents (POHCs) in the waste feed that you specify under paragraph (c)(3)(ii) of this section to the extent required by paragraphs (c)(1) and (c)(2) of this section.

(ii) You must specify one or more POHCs that are representative of the most difficult to destroy organic compounds in your hazardous waste feedstream. You must base this specification on the degree of difficulty of incineration of the organic constituents in the hazardous waste and on their concentration or mass in the hazardous waste feed, considering the results of hazardous waste analyses or other data and information.

(d) *Cement kilns with in-line kiln raw mills* —(1) *General*. (i) You must conduct performance testing when the raw mill is on-line and when the mill is off-line to demonstrate compliance with the emission standards, and you must establish separate operating parameter limits under § 63.1209 for each mode of operation, except as provided by paragraph (d)(1)(iv) of this section.

(ii) You must document in the operating record each time you change from one mode of operation to the alternate mode and begin complying with the operating parameter limits for that alternate mode of operation.

(iii) You must calculate rolling averages for operating parameter limits as provided by § 63.1209 (q)(2).

(iv) If your in-line kiln raw mill has dual stacks, you may assume that the dioxin/furan emission levels in the by-pass stack and the operating parameter limits determined during performance testing of the by-pass stack when the raw mill is off-line are the same as when the mill is on-line.

(2) *Emissions averaging.* You may comply with the mercury, semivolatile metal, low volatile metal, and hydrochloric acid/chlorine gas emission standards on a time-weighted average basis under the following procedures:

(i) *Averaging methodology.* You must calculate the time-weighted average emission concentration with the following equation:

$$C_{\text{total}} = \{C_{\text{mill-off}} \times (T_{\text{mill-off}} / (T_{\text{mill-off}} + T_{\text{mill-on}}))\} + \{C_{\text{mill-on}} \times (T_{\text{mill-on}} / (T_{\text{mill-off}} + T_{\text{mill-on}}))\}$$

Where:

C_{total} =time-weighted average concentration of a regulated constituent considering both raw mill on time and off time;

$C_{\text{mill-off}}$ =average performance test concentration of regulated constituent with the raw mill off-line;

$C_{\text{mill-on}}$ =average performance test concentration of regulated constituent with the raw mill on-line;

$T_{\text{mill-off}}$ =time when kiln gases are not routed through the raw mill; and

$T_{\text{mill-on}}$ =time when kiln gases are routed through the raw mill.

(ii) *Compliance.* (A) If you use this emission averaging provision, you must document in the operating record compliance with the emission standards on an annual basis by using the equation provided by paragraph (d)(2) of this section.

(B) Compliance is based on one-year block averages beginning on the day you submit the initial notification of compliance.

(iii) *Notification.* (A) If you elect to document compliance with one or more emission standards using this emission averaging provision, you must notify the Administrator in the initial comprehensive performance test plan submitted under § 63.1207(e).

(B) You must include historical raw mill operation data in the performance test plan to estimate future raw mill down-time and document in the performance test plan that estimated emissions and estimated raw mill down-time will not result in an exceedance of an emission standard on an annual basis.

(C) You must document in the notification of compliance submitted under § 63.1207(j) that an emission standard will not be exceeded based on the documented emissions from the performance test and predicted raw mill down-time.

(e) *Preheater or preheater/precalciner kilns with dual stacks* —(1) *General.* You must conduct performance testing on each stack to demonstrate compliance with the emission standards, and you must establish operating parameter limits under § 63.1209 for each stack, except as provided by paragraph (d)(1)(iv) of this section for dioxin/furan emissions testing and operating parameter limits for the by-pass stack of in-line raw mills.

(2) *Emissions averaging.* You may comply with the mercury, semivolatile metal, low volatile metal, and hydrochloric acid/chlorine gas emission standards specified in this section on a gas flowrate-weighted average basis under the following procedures:

(i) *Averaging methodology.* You must calculate the gas flowrate-weighted average emission concentration using the following equation:

$$C_{\text{tot}} = \{C_{\text{main}} \times (Q_{\text{main}} / (Q_{\text{main}} + Q_{\text{bypass}}))\} + \{C_{\text{bypass}} \times (Q_{\text{bypass}} / (Q_{\text{main}} + Q_{\text{bypass}}))\}$$

Where:

C_{tot} = gas flowrate-weighted average concentration of the regulated constituent;

C_{main} = average performance test concentration demonstrated in the main stack;

C_{bypass} = average performance test concentration demonstrated in the bypass stack;

Q_{main} = volumetric flowrate of main stack effluent gas; and

Q_{bypass} = volumetric flowrate of bypass effluent gas.

(ii) *Compliance.* (A) You must demonstrate compliance with the emission standard(s) using the emission concentrations determined from the performance tests and the equation provided by paragraph (e)(1) of this section; and

(B) You must develop operating parameter limits for bypass stack and main stack flowrates that ensure the emission concentrations calculated with the equation in paragraph (e)(1) of this section do not exceed the emission standards on a 12-hour rolling average basis. You must include these flowrate limits in the Notification of Compliance.

(iii) *Notification.* If you elect to document compliance under this emissions averaging provision, you must:

(A) Notify the Administrator in the initial comprehensive performance test plan submitted under § 63.1207(e). The performance test plan must include, at a minimum, information describing the flowrate limits established under paragraph (e)(2)(ii)(B) of this section; and

(B) Document in the Notification of Compliance submitted under § 63.1207(j) the demonstrated gas flowrate-weighted average emissions that you calculate with the equation provided by paragraph (e)(2) of this section.

(f) *Significant figures.* The emission limits provided by paragraphs (a) and (b) of this section are presented with two significant figures. Although you must perform intermediate calculations using at least three significant figures, you may round the resultant emission levels to two significant figures to document compliance.

(g) [Reserved]

(h) When you comply with the particulate matter requirements of paragraphs (a)(7) or (b)(7) of this section, you are exempt from the New Source Performance Standard for particulate matter and opacity under § 60.60 of this chapter.

(i) The provisions of this section no longer apply after any of the following dates, whichever occurs first:

(1) The date that your source begins to comply with § 63.1220 by placing a Documentation of Compliance in the operating record pursuant to § 63.1211(c);

(2) The date that your source begins to comply with § 63.1220 by submitting a Notification of Compliance pursuant to § 63.1210(b); or

(3) The date for your source to comply with § 63.1220 pursuant to § 63.1206 and any extensions granted there under.

[67 FR 6809, Feb. 13, 2002, as amended at 67 FR 6987, Feb. 14, 2002; 70 FR 59541, Oct. 12, 2005; 73 FR 18979, Apr. 8, 2008]

§ 63.1205 What are the standards for hazardous waste burning lightweight aggregate kilns that are effective until compliance with the standards under § 63.1221?

(a) *Emission limits for existing sources.* You must not discharge or cause combustion gases to be emitted into the atmosphere that contain:

(1) For dioxins and furans:

(i) Emissions in excess of 0.20 ng TEQ/dscm corrected to 7 percent oxygen; or

(ii) Rapid quench of the combustion gas temperature at the exit of the (last) combustion chamber (or exit of any waste heat recovery system) to 400 °F or lower based on the average of the test run average temperatures. You must also notify in writing the RCRA authority that you are complying with this option;

(2) Mercury in excess of 120 µg/dscm corrected to 7 percent oxygen;

(3) Lead and cadmium in excess of 250 µg/dscm, combined emissions, corrected to 7 percent oxygen;

(4) Arsenic, beryllium, and chromium in excess of 110 µg/dscm, combined emissions, corrected to 7 percent oxygen;

(5) *Carbon monoxide and hydrocarbons.* (i) Carbon monoxide in excess of 100 parts per million by volume, over an hourly rolling average (monitored continuously with a continuous emissions monitoring system), dry basis and corrected to 7 percent oxygen. If you elect to comply with this carbon monoxide standard rather than the hydrocarbon standard under paragraph (a)(5)(ii) of this section, you also must document that, during the destruction and removal efficiency (DRE) test runs or their equivalent as provided by § 63.1206(b)(7), hydrocarbons do not exceed 20 parts per million by volume during those runs, over an hourly rolling average (monitored continuously with a continuous emissions monitoring system), dry basis, corrected to 7 percent oxygen, and reported as propane; or

(ii) Hydrocarbons in excess of 20 parts per million by volume, over an hourly rolling average, dry basis, corrected to 7 percent oxygen, and reported as propane;

(6) Hydrochloric acid and chlorine gas in excess of 600 parts per million by volume, combined emissions, expressed as hydrochloric acid equivalents, dry basis and corrected to 7 percent oxygen; and

(7) Particulate matter in excess of 57 mg/dscm corrected to 7 percent oxygen.

(b) *Emission limits for new sources.* You must not discharge or cause combustion gases to be emitted into the atmosphere that contain:

(1) For dioxins and furans:

(i) Emissions in excess of 0.20 ng TEQ/dscm corrected to 7 percent oxygen; or

(ii) Rapid quench of the combustion gas temperature at the exit of the (last) combustion chamber (or exit of any waste heat recovery system) to 400 °F or lower based on the average of the test run average temperatures. You must also notify in writing the RCRA authority that you are complying with this option;

(2) Mercury in excess of 120 µg/dscm corrected to 7 percent oxygen;

(3) Lead and cadmium in excess of 43 µg/dscm, combined emissions, corrected to 7 percent oxygen;

(4) Arsenic, beryllium, and chromium in excess of 110 µg/dscm, combined emissions, corrected to 7 percent oxygen;

(5) *Carbon monoxide and hydrocarbons.* (i) Carbon monoxide in excess of 100 parts per million by volume, over an hourly rolling average (monitored continuously with a continuous emissions monitoring system), dry basis and corrected to 7 percent oxygen. If you elect to comply with this carbon monoxide standard rather than the hydrocarbon standard under paragraph (b)(5)(ii) of this section, you also must document that, during the destruction and removal efficiency (DRE) test runs or their equivalent as provided by § 63.1206(b)(7), hydrocarbons do not exceed 20 parts per million by volume during those runs, over an hourly rolling average (monitored continuously with a continuous emissions monitoring system), dry basis, corrected to 7 percent oxygen, and reported as propane; or

(ii) Hydrocarbons in excess of 20 parts per million by volume, over an hourly rolling average, dry basis, corrected to 7 percent oxygen, and reported as propane;

(6) Hydrochloric acid and chlorine gas in excess of 600 parts per million by volume, combined emissions, expressed as hydrochloric acid equivalents, dry basis and corrected to 7 percent oxygen; and

(7) Particulate matter in excess of 57 mg/dscm corrected to 7 percent oxygen.

(c) *Destruction and removal efficiency (DRE) standard* —(1) *99.99% DRE.* Except as provided in paragraph (c)(2) of this section, you must achieve a destruction and removal efficiency (DRE) of 99.99% for each principal organic hazardous constituent (POHC) designated under paragraph (c)(3) of this section. You must calculate DRE for each POHC from the following equation:

$$\text{DRE} = [1 - (W_{\text{out}} / W_{\text{in}})] \times 100\%$$

Where:

W_{in} = mass feedrate of one principal organic hazardous constituent (POHC) in a waste feedstream; and

W_{out} = mass emission rate of the same POHC present in exhaust emissions prior to release to the atmosphere.

(2) *99.9999% DRE.* If you burn the dioxin-listed hazardous wastes F020, F021, F022, F023, F026, or F027 (see § 261.31 of this chapter), you must achieve a destruction and removal efficiency (DRE) of 99.9999% for each principal organic hazardous constituent (POHC) that you designate under paragraph (c)(3) of this section. You must demonstrate this DRE performance on POHCs that are more difficult to incinerate than tetra-, penta-, and hexachlorodibenzo-dioxins and dibenzofurans. You must use the equation in paragraph (c)(1) of this section to calculate DRE for each POHC. In addition, you must notify the Administrator of your intent to burn hazardous wastes F020, F021, F022, F023, F026, or F027.

(3) *Principal organic hazardous constituents (POHCs).* (i) You must treat the Principal Organic Hazardous Constituents (POHCs) in the waste feed that you specify under paragraph (c)(3)(ii) of this section to the extent required by paragraphs (c)(1) and (c)(2) of this section.

(ii) You must specify one or more POHCs that are representative of the most difficult to destroy organic compounds in your hazardous waste feedstream. You must base this specification on the degree of difficulty of incineration of the organic constituents in the hazardous waste and on their concentration or mass in the hazardous waste feed, considering the results of hazardous waste analyses or other data and information.

(d) *Significant figures.* The emission limits provided by paragraphs (a) and (b) of this section are presented with two significant figures. Although you must perform intermediate calculations using at least three significant figures, you may round the resultant emission levels to two significant figures to document compliance.

(e) The provisions of this section no longer apply after any of the following dates, whichever occurs first:

(1) The date that your source begins to comply with § 63.1221 by placing a Documentation of Compliance in the operating record pursuant to § 63.1211(c);

(2) The date that your source begins to comply with § 63.1221 by submitting a Notification of Compliance pursuant to § 63.1210(b); or

(3) The date for your source to comply with § 63.1221 pursuant to § 63.1206 and any extensions granted there under.

[67 FR 6812, Feb. 13, 2002, as amended at 67 FR 77691, Dec. 19, 2002; 70 FR 59541, Oct. 12, 2005; 73 FR 18979, Apr. 8, 2008]

Monitoring and Compliance Provisions

§ 63.1206 When and how must you comply with the standards and operating requirements?

(a) *Compliance dates* —(1) *Compliance dates for incinerators, cement kilns, and lightweight aggregate kilns that burn hazardous waste* —(i) *Compliance date for standards under §§ 63.1203, 63.1204, and 63.1205* —(A) *Compliance dates for existing sources.* You must comply with the emission standards under §§ 63.1203, 63.1204, and 63.1205 and the other requirements of this subpart no later than the compliance date, September 30, 2003, unless the Administrator grants you an extension of time under § 63.6(i) or § 63.1213, except:

(1) Cement kilns are exempt from the bag leak detection system requirements under paragraph (c)(8) of this section;

(2) The bag leak detection system required under § 63.1206(c)(8) must be capable of continuously detecting and recording particulate matter emissions at concentrations of 1.0 milligram per actual cubic meter unless you demonstrate under § 63.1209(g)(1) that a higher detection limit would adequately detect bag leaks, in lieu of the requirement for the higher detection limit under paragraph (c)(8)(ii)(A) of this section; and

(3) The excessive exceedances notification requirements for bag leak detection systems under paragraph (c)(8)(iv) of this section are waived.

(B) *New or reconstructed sources.* (1) If you commenced construction or reconstruction of your hazardous waste combustor after April 19, 1996, you must comply with the emission standards under §§ 63.1203, 63.1204, and 63.1205 and the other requirements of this subpart by the later of September 30, 1999 or the date the source starts operations, except as provided by paragraphs (a)(1)(i)(A)(1) through (3) and (a)(1)(i)(B)(2) of this section. The costs of retrofitting and replacement of equipment that is installed specifically to comply with this subpart, between April 19, 1996 and a source's compliance date, are not considered to be reconstruction costs.

(2) For a standard under §§ 63.1203, 63.1204, and 63.1205 that is more stringent than the standard proposed on April 19, 1996, you may achieve compliance no later than September 30, 2003 if you comply with the standard proposed on April 19, 1996 after September 30, 1999. This exception does not apply, however, to new or reconstructed area source hazardous waste combustors that become major sources after September 30, 1999. As provided by § 63.6(b)(7), such sources must comply with the standards under §§ 63.1203, 63.1204, and 63.1205 at startup.

(ii) *Compliance date for standards under §§ 63.1219, 63.1220, and 63.1221* —(A) *Compliance dates for existing sources.* You must comply with the emission standards under §§ 63.1219, 63.1220, and 63.1221 and the other requirements of this subpart no later than the compliance date, October 14, 2008, unless the Administrator grants you an extension of time under § 63.6(i) or § 63.1213.

(B) *New or reconstructed sources.* (1) If you commenced construction or reconstruction of your hazardous waste combustor after April 20, 2004, you must comply with the new source emission

standards under §§ 63.1219, 63.1220, and 63.1221 and the other requirements of this subpart by the later of October 12, 2005 or the date the source starts operations, except as provided by paragraphs (a)(1)(ii)(B)(2) and (a)(1)(ii)(B)(3) of this section. The costs of retrofitting and replacement of equipment that is installed specifically to comply with this subpart, between April 20, 2004, and a source's compliance date, are not considered to be reconstruction costs.

(2) For a standard under §§ 63.1219, 63.1220, and 63.1221 that is more stringent than the standard proposed on April 20, 2004, you may achieve compliance no later than October 14, 2008, if you comply with the standard proposed on April 20, 2004, after October 12, 2005. This exception does not apply, however, to new or reconstructed area source hazardous waste combustors that become major sources after October 14, 2008. As provided by § 63.6(b)(7), such sources must comply with the standards under §§ 63.1219, 63.1220, and 63.1221 at startup.

(3) If you commenced construction or reconstruction of a cement kiln after April 20, 2004, you must comply with the new source emission standard for particulate matter under § 63.1220(b)(7)(i) by the later of October 28, 2008 or the date the source starts operations.

(2) *Compliance date for solid fuel boilers, liquid fuel boilers, and hydrochloric acid production furnaces that burn hazardous waste for standards under §§ 63.1216, 63.1217, and 63.1218 . (i) Compliance date for existing sources.* You must comply with the standards of this subpart no later than the compliance date, October 14, 2008, unless the Administrator grants you an extension of time under § 63.6(i) or § 63.1213.

(ii) *New or reconstructed sources . (A)* If you commenced construction or reconstruction of your hazardous waste combustor after April 20, 2004, you must comply with the new source emission standards of this subpart by the later of October 12, 2005, or the date the source starts operations, except as provided by paragraph (a)(2)(ii)(B) of this section. The costs of retrofitting and replacement of equipment that is installed specifically to comply with this subpart, between April 20, 2004, and a source's compliance date, are not considered to be reconstruction costs.

(B) For a standard in the subpart that is more stringent than the standard proposed on April 20, 2004, you may achieve compliance no later than October 14, 2008, if you comply with the standard proposed on April 20, 2004, after October 12, 2005. This exception does not apply, however, to new or reconstructed area source hazardous waste combustors that become major sources after October 14, 2008. As provided by § 63.6(b)(7), such sources must comply with this subpart at startup.

(3) *Early compliance.* If you choose to comply with the emission standards of this subpart prior to the dates specified in paragraphs (a)(1) and (a)(2) of this section, your compliance date is the earlier of the date you postmark the Notification of Compliance under § 63.1207(j)(1) or the dates specified in paragraphs (a)(1) and (a)(2) of this section.

(b) *Compliance with standards —(1) Applicability.* The emission standards and operating requirements set forth in this subpart apply at all times except:

(i) During periods of startup, shutdown, and malfunction; and

(ii) When hazardous waste is not in the combustion chamber (i.e., the hazardous waste feed to the combustor has been cut off for a period of time not less than the hazardous waste residence time) and you have documented in the operating record that you are complying with all otherwise applicable requirements and standards promulgated under authority of sections 112 (e.g., 40 CFR part 63, subparts LLL, DDDDD, and NNNNN) or 129 of the Clean Air Act in lieu of the emission standards under §§ 63.1203, 63.1204, 63.1205, 63.1215, 63.1216, 63.1217, 63.1218, 63.1219, 63.1220, and 63.1221; the monitoring and compliance standards of this section and §§ 63.1207 through 63.1209, except the modes of operation requirements of § 63.1209(q); and the notification, reporting, and recordkeeping requirements of §§ 63.1210 through 63.1212.

(2) *Methods for determining compliance.* The Administrator will determine compliance with the emission standards of this subpart as provided by § 63.6(f)(2). Conducting performance testing under operating conditions representative of the extreme range of normal conditions is consistent with the

requirements of §§ 63.6(f)(2)(iii)(B) and 63.7(e)(1) to conduct performance testing under representative operating conditions.

(3) *Finding of compliance.* The Administrator will make a finding concerning compliance with the emission standards and other requirements of this subpart as provided by § 63.6(f)(3).

(4) *Extension of compliance with emission standards.* The Administrator may grant an extension of compliance with the emission standards of this subpart as provided by §§ 63.6(i) and 63.1213.

(5) *Changes in design, operation, or maintenance* —(i) *Changes that may adversely affect compliance.* If you plan to change (as defined in paragraph (b)(5)(iii) of this section) the design, operation, or maintenance practices of the source in a manner that may adversely affect compliance with any emission standard that is not monitored with a CEMS:

(A) *Notification.* You must notify the Administrator at least 60 days prior to the change, unless you document circumstances that dictate that such prior notice is not reasonably feasible. The notification must include:

(1) A description of the changes and which emission standards may be affected; and

(2) A comprehensive performance test schedule and test plan under the requirements of § 63.1207(f) that will document compliance with the affected emission standard(s);

(B) *Performance test.* You must conduct a comprehensive performance test under the requirements of §§ 63.1207(f)(1) and (g)(1) to document compliance with the affected emission standard(s) and establish operating parameter limits as required under § 63.1209, and submit to the Administrator a Notification of Compliance under §§ 63.1207(j) and 63.1210(d); and

(C) *Restriction on waste burning.* (1) Except as provided by paragraph (b)(5)(i)(C)(2) of this section, after the change and prior to submitting the notification of compliance, you must not burn hazardous waste for more than a total of 720 hours (renewable at the discretion of the Administrator) and only for the purposes of pretesting or comprehensive performance testing. Pretesting is defined at § 63.1207(h)(2)(i) and (ii).

(2) You may petition the Administrator to obtain written approval to burn hazardous waste in the interim prior to submitting a Notification of Compliance for purposes other than testing or pretesting. You must specify operating requirements, including limits on operating parameters, that you determine will ensure compliance with the emission standards of this subpart based on available information. The Administrator will review, modify as necessary, and approve if warranted the interim operating requirements.

(ii) *Changes that will not affect compliance.* If you determine that a change will not adversely affect compliance with the emission standards or operating requirements, you must document the change in the operating record upon making such change. You must revise as necessary the performance test plan, Documentation of Compliance, Notification of Compliance, and start-up, shutdown, and malfunction plan to reflect these changes.

(iii) *Definition of “change.”* For purposes of paragraph (b)(5) of this section, “change” means any change in design, operation, or maintenance practices that were documented in the comprehensive performance test plan, Notification of Compliance, or startup, shutdown, and malfunction plan.

(6) *Compliance with the carbon monoxide and hydrocarbon emission standards.* This paragraph applies to sources that elect to comply with the carbon monoxide and hydrocarbon emissions standards of this subpart by documenting continuous compliance with the carbon monoxide standard using a continuous emissions monitoring system and documenting compliance with the hydrocarbon standard during the destruction and removal efficiency (DRE) performance test or its equivalent.

(i) If a DRE test performed pursuant to § 63.1207(c)(2) is acceptable as documentation of compliance with the DRE standard, you may use the highest hourly rolling average hydrocarbon level

achieved during the DRE test runs to document compliance with the hydrocarbon standard. An acceptable DRE test is any test for which the data and results are determined to meet quality assurance objectives (on a site-specific basis) such that the results adequately demonstrate compliance with the DRE standard.

(ii) If during this acceptable DRE test you did not obtain hydrocarbon emissions data sufficient to document compliance with the hydrocarbon standard, you must either:

(A) Perform, as part of the performance test, an “equivalent DRE test” to document compliance with the hydrocarbon standard. An equivalent DRE test is comprised of a minimum of three runs each with a minimum duration of one hour during which you operate the combustor as close as reasonably possible to the operating parameter limits that you established based on the initial DRE test. You must use the highest hourly rolling average hydrocarbon emission level achieved during the equivalent DRE test to document compliance with the hydrocarbon standard; or

(B) Perform a DRE test as part of the performance test.

(7) *Compliance with the DRE standard.* (i) Except as provided in paragraphs (b)(7)(ii) and (b)(7)(iii) of this section:

(A) You must document compliance with the Destruction and Removal Efficiency (DRE) standard under this subpart only once provided that you do not modify the source after the DRE test in a manner that could affect the ability of the source to achieve the DRE standard.

(B) You may use any DRE test data that documents that your source achieves the required level of DRE provided:

(1) You have not modified the design or operation of your source in a manner that could effect the ability of your source to achieve the DRE standard since the DRE test was performed; and,

(2) The DRE test data meet quality assurance objectives determined on a site-specific basis.

(ii) *Sources that feed hazardous waste at locations other than the normal flame zone.* (A) Except as provided by paragraph (b)(7)(ii)(B) of this section, if you feed hazardous waste at a location in the combustion system other than the normal flame zone, then you must demonstrate compliance with the DRE standard during each comprehensive performance test;

(B)(1) A cement kiln that feeds hazardous waste at a location other than the normal flame zone need only demonstrate compliance with the DRE standard during three consecutive comprehensive performance tests provided that:

(i) All three tests achieve the DRE standard in this subpart; and

(ii) The design, operation, and maintenance features of each of the three tests are similar;

(iii) The data in lieu restriction of § 63.1207(c)(2)(iv) does not apply when complying with the provisions of paragraph (b)(7)(ii)(B) of this section;

(2) If at any time you change your design, operation, and maintenance features in a manner that could reasonably be expected to affect your ability to meet the DRE standard, then you must comply with the requirements of paragraph (b)(7)(ii)(A) of this section.

(iii) For sources that do not use DRE previous testing to document conformance with the DRE standard pursuant to § 63.1207(c)(2), you must perform DRE testing during the initial comprehensive performance test.

(8) *Applicability of particulate matter and opacity standards during particulate matter CEMS correlation tests.* (i) Any particulate matter and opacity standards of parts 60, 61, 63, 264, 265, and 266 of this chapter (i.e., any title 40 particulate or opacity standards) applicable to a hazardous waste combustor do not apply while you conduct particulate matter continuous emissions monitoring system

(CEMS) correlation tests (i.e., correlation with manual stack methods) under the conditions of paragraphs (b)(8)(iii) through (vii) of this section.

(ii) Any permit or other emissions or operating parameter limits or conditions, including any limitation on workplace practices, that are applicable to hazardous waste combustors to ensure compliance with any particulate matter and opacity standards of parts 60, 61, 63, 264, 265, and 266 of this chapter (i.e., any title 40 particulate or opacity standards) do not apply while you conduct particulate matter CEMS correlation tests under the conditions of paragraphs (b)(8)(iii) through (vii) of this section.

(iii) For the provisions of this section to apply, you must:

(A) Develop a particulate matter CEMS correlation test plan that includes the following information. This test plan may be included as part of the comprehensive performance test plan required under §§ 63.1207(e) and (f):

(1) Number of test conditions and number of runs for each test condition;

(2) Target particulate matter emission level for each test condition;

(3) How you plan to modify operations to attain the desired particulate matter emission levels; and

(4) Anticipated normal particulate matter emission levels; and

(B) Submit the test plan to the Administrator for approval at least 90 calendar days before the correlation test is scheduled to be conducted.

(iv) The Administrator will review and approve/disapprove the correlation test plan under the procedures for review and approval of the site-specific test plan provided by § 63.7(c)(3)(i) and (iii). If the Administrator fails to approve or disapprove the correlation test plan within the time period specified by § 63.7(c)(3)(i), the plan is considered approved, unless the Administrator has requested additional information.

(v) The particulate matter and opacity standards and associated operating limits and conditions will not be waived for more than 96 hours, in the aggregate, for a correlation test, including all runs of all test conditions, unless more time is approved by the Administrator.

(vi) The stack sampling team must be on-site and prepared to perform correlation testing no later than 24 hours after you modify operations to attain the desired particulate matter emissions concentrations, unless you document in the correlation test plan that a longer period of conditioning is appropriate.

(vii) You must return to operating conditions indicative of compliance with the applicable particulate matter and opacity standards as soon as possible after correlation testing is completed.

(9) *Alternative standards for existing or new hazardous waste burning lightweight aggregate kilns using MACT.* (i) You may petition the Administrator to request alternative standards to the mercury or hydrogen chloride/chlorine gas emission standards of this subpart, to the semivolatile metals emission standards under §§ 63.1205, 63.1221(a)(3)(ii), or 63.1221(b)(3)(ii), or to the low volatile metals emissions standards under §§ 63.1205, 63.1221(a)(4)(ii), or 63.1221(b)(4)(ii) if:

(A) You cannot achieve one or more of these standards while using maximum achievable control technology (MACT) because of raw material contributions to emissions of mercury, semivolatile metals, low volatile metals, or hydrogen chloride/chlorine gas; or

(B) You determine that mercury is not present at detectable levels in your raw material.

(ii) The alternative standard that you recommend under paragraph (b)(9)(i)(A) of this section may be an operating requirement, such as a hazardous waste feedrate limitation for metals and/or chlorine, and/or an emission limitation.

(iii) The alternative standard must include a requirement to use MACT, or better, applicable to the standard for which the source is seeking relief, as defined in paragraphs (b)(9)(viii) and (ix) of this section.

(iv) *Documentation required.* (A) The alternative standard petition you submit under paragraph (b)(9)(i)(A) of this section must include data or information documenting that raw material contributions to emissions prevent you from complying with the emission standard even though the source is using MACT, as defined under paragraphs (b)(9)(viii) and (ix) of this section, for the standard for which you are seeking relief.

(B) Alternative standard petitions that you submit under paragraph (b)(9)(i)(B) of this section must include data or information documenting that mercury is not present at detectable levels in raw materials.

(v) You must include data or information with semivolatile metal and low volatility metal alternative standard petitions that you submit under paragraph (b)(9)(i)(A) of this section documenting that increased chlorine feedrates associated with the burning of hazardous waste, when compared to non-hazardous waste operations, do not significantly increase metal emissions attributable to raw materials.

(vi) You must include data or information with semivolatile metals, low volatile metals, and hydrogen chloride/chlorine gas alternative standard petitions that you submit under paragraph (b)(9)(i)(A) of this section documenting that semivolatile metals, low volatile metals, and hydrogen chloride/chlorine gas emissions attributable to the hazardous waste only will not exceed the emission standards of this subpart.

(vii) You must not operate pursuant to your recommended alternative standards in lieu of emission standards specified in this subpart:

(A) Unless the Administrator approves the provisions of the alternative standard petition request or establishes other alternative standards; and

(B) Until you submit a revised Notification of Compliance that incorporates the revised standards.

(viii) For purposes of this alternative standard provision, MACT for existing hazardous waste burning lightweight aggregate kilns is defined as:

(A) For mercury, a hazardous waste feedrate corresponding to an MTEC of 24 µg/dscm or less;

(B) For semivolatile metals, a hazardous waste feedrate corresponding to an MTEC of 280,000 µg/dscm or less, and use of a particulate matter control device that achieves particulate matter emissions of 57 mg/dscm or less;

(C) For low volatile metals, a hazardous waste feedrate corresponding to an MTEC of 120,000 µg/dscm or less, and use of a particulate matter control device that achieves particulate matter emissions of 57 mg/dscm or less; and

(D) For hydrogen chloride/chlorine gas, a hazardous waste chlorine feedrate corresponding to an MTEC of 2,000,000 µgm/dscm or less, and use of an air pollution control device with a hydrogen chloride/chlorine gas removal efficiency of 85 percent or greater.

(ix) For purposes of this alternative standard provision, MACT for new hazardous waste burning lightweight aggregate kilns is defined as:

(A) For mercury, a hazardous waste feedrate corresponding to an MTEC of 4 µg/dscm or less;

(B) For semivolatile metals, a hazardous waste feedrate corresponding to an MTEC of 280,000 µg/dscm or less, and use of a particulate matter control device that achieves particulate matter emissions of 57 mg/dscm or less;

(C) For low volatile metals, a hazardous waste feedrate corresponding to an MTEC of 46,000 µg/dscm or less, and use of a particulate matter control device that achieves particulate matter emissions of 57 mg/dscm or less;

(D) For hydrogen chloride/chlorine gas, a hazardous waste chlorine feedrate corresponding to an MTEC of 14,000,000 µgm/dscm or less, and use of an air pollution control device with a hydrogen chloride/chlorine gas removal efficiency of 99.6 percent or greater.

(10) *Alternative standards for existing or new hazardous waste burning cement kilns using MACT.*

(i) You may petition the Administrator to request alternative standards to the mercury or hydrogen chloride/chlorine gas emission standards of this subpart, to the semivolatile metals emission standards under §§ 63.1204, 63.1220(a)(3)(ii), or 63.1220(b)(3)(ii), or to the low volatile metals emissions standards under §§ 63.1204, 63.1220(a)(4)(ii), or 63.1220(b)(4)(ii) if:

(A) You cannot achieve one or more of these standards while using maximum achievable control technology (MACT) because of raw material contributions to emissions of mercury, semivolatile metals, low volatile metals, or hydrogen chloride/chlorine gas; or

(B) You determine that mercury is not present at detectable levels in your raw material.

(ii) The alternative standard that you recommend under paragraph (b)(10)(i)(A) of this section may be an operating requirement, such as a hazardous waste feedrate limitation for metals and/or chlorine, and/or an emission limitation.

(iii) The alternative standard must include a requirement to use MACT, or better, applicable to the standard for which the source is seeking relief, as defined in paragraphs (b)(10)(viii) and (ix) of this section.

(iv) *Documentation required.* (A) The alternative standard petition you submit under paragraph (b)(10)(i)(A) of this section must include data or information documenting that raw material contributions to emissions prevent you from complying with the emission standard even though the source is using MACT, as defined in paragraphs (b)(10)(viii) and (ix) of this section, for the standard for which you are seeking relief.

(B) Alternative standard petitions that you submit under paragraph (b)(10)(i)(B) of this section must include data or information documenting that mercury is not present at detectable levels in raw materials.

(v) You must include data or information with semivolatile metal and low volatile metal alternative standard petitions that you submit under paragraph (b)(10)(i)(A) of this section documenting that increased chlorine feedrates associated with the burning of hazardous waste, when compared to non-hazardous waste operations, do not significantly increase metal emissions attributable to raw materials.

(vi) You must include data or information with semivolatile metals, low volatile metals, and hydrogen chloride/chlorine gas alternative standard petitions that you submit under paragraph (b)(10)(i)(A) of this section documenting that emissions of the regulated metals and hydrogen chloride/chlorine gas attributable to the hazardous waste only will not exceed the emission standards in this subpart.

(vii) You must not operate pursuant to your recommended alternative standards in lieu of emission standards specified in this subpart:

(A) Unless the Administrator approves the provisions of the alternative standard petition request or establishes other alternative standards; and

(B) Until you submit a revised Notification of Compliance that incorporates the revised standards.

(viii) For purposes of this alternative standard provision, MACT for existing hazardous waste burning cement kilns is defined as:

(A) For mercury, a hazardous waste feedrate corresponding to an MTEC of 88 µg/dscm or less;

(B) For semivolatile metals, a hazardous waste feedrate corresponding to an MTEC of 31,000 µg/dscm or less, and use of a particulate matter control device that achieves particulate matter emissions of 0.15 kg/Mg dry feed or less;

(C) For low volatile metals, a hazardous waste feedrate corresponding to an MTEC of 54,000 µg/dscm or less, and use of a particulate matter control device that achieves particulate matter emissions of 0.15 kg/Mg dry feed or less; and

(D) For hydrogen chloride/chlorine gas, a hazardous waste chlorine feedrate corresponding to an MTEC of 720,000 µgm/dscm or less.

(ix) For purposes of this alternative standard provision, MACT for new hazardous waste burning cement kilns is defined as:

(A) For mercury, a hazardous waste feedrate corresponding to an MTEC of 7 µg/dscm or less;

(B) For semivolatile metals, a hazardous waste feedrate corresponding to an MTEC of 31,000 µg/dscm or less, and use of a particulate matter control device that achieves particulate matter emissions of 0.15 kg/Mg dry feed or less;

(C) For low volatile metals, a hazardous waste feedrate corresponding to an MTEC of 15,000 µg/dscm or less, and use of a particulate matter control device that achieves particulate matter emissions of 0.15 kg/Mg dry feed or less;

(D) For hydrogen chloride/chlorine gas, a hazardous waste chlorine feedrate corresponding to an MTEC of 420,000 µgm/dscm or less.

(11) *Calculation of hazardous waste residence time.* You must calculate the hazardous waste residence time and include the calculation in the performance test plan under § 63.1207(f) and the operating record. You must also provide the hazardous waste residence time in the Documentation of Compliance under § 63.1211(c) and the Notification of Compliance under §§ 63.1207(j) and 63.1210(d).

(12) *Documenting compliance with the standards based on performance testing.* (i) You must conduct a minimum of three runs of a performance test required under § 63.1207 to document compliance with the emission standards of this subpart.

(ii) You must document compliance with the emission standards based on the arithmetic average of the emission results of each run, except that you must document compliance with the destruction and removal efficiency standard for each run of the comprehensive performance test individually.

(13) *Cement kilns and lightweight aggregate kilns that feed hazardous waste at a location other than the end where products are normally discharged and where fuels are normally fired.* (i) Cement kilns that feed hazardous waste at a location other than the end where products are normally discharged and where fuels are normally fired must comply with the carbon monoxide and hydrocarbon standards of this subpart as follows:

(A) For existing sources, you must not discharge or cause combustion gases to be emitted into the atmosphere that contain either:

(1) Hydrocarbons in the main stack in excess of 20 parts per million by volume, over an hourly rolling average (monitored continuously with a continuous emissions monitoring system), dry basis, corrected to 7 percent oxygen, and reported as propane; or

(2) Hydrocarbons both in the by-pass duct and at a preheater tower combustion gas monitoring location in excess of 10 parts per million by volume, at each location, over an hourly rolling average (monitored continuously with a continuous emissions monitoring system), dry basis, corrected to 7 percent oxygen, and reported as propane; or

(3) If the only firing location of hazardous waste upstream (in terms of gas flow) of the point where combustion gases are diverted into the bypass duct is at the kiln end where products are normally discharged, then both hydrocarbons at the preheater tower combustion gas monitoring location in excess of 10 parts per million by volume, over an hourly rolling average (monitored continuously with a continuous emissions monitoring system), dry basis, corrected to 7 percent oxygen, and reported as propane, and either hydrocarbons in the by-pass duct in excess of 10 parts per million by volume, over an hourly rolling average (monitored continuously with a continuous emissions monitoring system), dry basis, corrected to 7 percent oxygen, and reported as propane, or carbon monoxide in excess of 100 parts per million by volume, over an hourly rolling average (monitored continuously with a continuous emissions monitoring system), dry basis, and corrected to 7 percent oxygen. If you comply with the carbon monoxide standard of 100 parts per million by volume in the by-pass duct, then you must also not discharge or cause combustion gases to be emitted into the atmosphere that contain hydrocarbons in the by-pass duct in excess of 10 parts per million by volume, over an hourly rolling average (monitored continuously with a continuous emissions monitoring system), dry basis, corrected to 7 percent oxygen, and reported as propane, at any time during the destruction and removal efficiency (DRE) test runs or their equivalent as provided by § 63.1206(b)(7).

(B) For new sources, you must not discharge or cause combustion gases to be emitted into the atmosphere that contain either:

(1) Hydrocarbons in the main stack in excess of 20 parts per million by volume, over an hourly rolling average (monitored continuously with a continuous emissions monitoring system), dry basis, corrected to 7 percent oxygen, and reported as propane; or

(2)(i) Hydrocarbons both in the by-pass duct and at a preheater tower combustion gas monitoring location in excess of 10 parts per million by volume, at each location, over an hourly rolling average (monitored continuously with a continuous emissions monitoring system), dry basis, corrected to 7 percent oxygen, and reported as propane, and

(ii) Hydrocarbons in the main stack, if construction of the kiln commenced after April 19, 1996 at a plant site where a cement kiln (whether burning hazardous waste or not) did not previously exist, to 50 parts per million by volume, over a 30-day block average (monitored continuously with a continuous emissions monitoring system), dry basis, corrected to 7 percent oxygen, and reported as propane; or

(3)(i) If the only firing location of hazardous waste upstream (in terms of gas flow) of the point where combustion gases are diverted into the bypass duct is at the kiln end where products are normally discharged, then both hydrocarbons at the preheater tower combustion gas monitoring location in excess of 10 parts per million by volume, over an hourly rolling average (monitored continuously with a continuous emissions monitoring system), dry basis, corrected to 7 percent oxygen, and reported as propane, and either hydrocarbons in the by-pass duct in excess of 10 parts per million by volume, over an hourly rolling average (monitored continuously with a continuous emissions monitoring system), dry basis, corrected to 7 percent oxygen, and reported as propane, or carbon monoxide in excess of 100 parts per million by volume, over an hourly rolling average (monitored continuously with a continuous emissions monitoring system), dry basis, and corrected to 7 percent oxygen. If you comply with the carbon monoxide standard of 100 parts per million by volume in the by-pass duct, then you must also not discharge or cause combustion gases to be emitted into the atmosphere that contain hydrocarbons in the by-pass duct in excess of 10 parts per million by volume, over an hourly rolling average (monitored continuously with a continuous emissions monitoring system), dry basis, corrected to 7 percent oxygen, and reported as propane, at any time during the destruction and removal efficiency (DRE) test runs or their equivalent as provided by § 63.1206(b)(7).

(ii) If construction of the kiln commenced after April 19, 1996 at a plant site where a cement kiln (whether burning hazardous waste or not) did not previously exist, hydrocarbons are limited to 50 parts per million by volume, over a 30-day block average (monitored continuously with a continuous emissions monitoring system), dry basis, corrected to 7 percent oxygen, and reported as propane.

(ii) Lightweight aggregate kilns that feed hazardous waste at a location other than the end where products are normally discharged and where fuels are normally fired must comply with the hydrocarbon standards of this subpart as follows:

(A) Existing sources must comply with the 20 parts per million by volume hydrocarbon standard of this subpart;

(B) New sources must comply with the 20 parts per million by volume hydrocarbon standard of this subpart.

(14) *Alternative to the particulate matter standard for incinerators* —(i) *General*. In lieu of complying with the particulate matter standards under § 63.1203, you may elect to comply with the following alternative metal emission control requirements:

(ii) *Alternative metal emission control requirements for existing incinerators*. (A) You must not discharge or cause combustion gases to be emitted into the atmosphere that contain cadmium, lead, and selenium in excess of 240 µgm/dscm, combined emissions, corrected to 7 percent oxygen; and,

(B) You must not discharge or cause combustion gases to be emitted into the atmosphere that contain antimony, arsenic, beryllium, chromium, cobalt, manganese, and nickel in excess of 97 µgm/dscm, combined emissions, corrected to 7 percent oxygen.

(iii) *Alternative metal emission control requirements for new incinerators*. (A) You must not discharge or cause combustion gases to be emitted into the atmosphere that contain cadmium, lead, and selenium in excess of 24 µgm/dscm, combined emissions, corrected to 7 percent oxygen; and,

(B) You must not discharge or cause combustion gases to be emitted into the atmosphere that contain antimony, arsenic, beryllium, chromium, cobalt, manganese, and nickel in excess of 97 µgm/dscm, combined emissions, corrected to 7 percent oxygen.

(iv) *Operating limits*. Semivolatile and low volatile metal operating parameter limits must be established to ensure compliance with the alternative emission limitations described in paragraphs (b) (14)(ii) and (iii) of this section pursuant to § 63.1209(n), except that semivolatile metal feedrate limits apply to lead, cadmium, and selenium, combined, and low volatile metal feedrate limits apply to arsenic, beryllium, chromium, antimony, cobalt, manganese, and nickel, combined.

(15) *Alternative to the interim standards for mercury for cement and lightweight aggregate kilns* —(i) *General*. In lieu of complying with the applicable mercury standards of §§ 63.1204(a)(2) and (b) (2) for existing and new cement kilns and §§ 63.1205(a)(2) and (b)(2) for existing and new lightweight aggregate kilns, you may instead elect to comply with the alternative mercury standard described in paragraphs (b)(15)(ii) through (b)(15)(v) of this section.

(ii) *Operating requirement*. You must not exceed a hazardous waste feedrate corresponding to a maximum theoretical emission concentration (MTEC) of 120 µg/dscm on a twelve-hour rolling average.

(iii) To document compliance with the operating requirement of paragraph (b)(15)(ii) of this section, you must:

(A) Monitor and record the feedrate of mercury for each hazardous waste feedstream according to § 63.1209(c);

(B) Monitor with a CMS and record in the operating record the gas flowrate (either directly or by monitoring a surrogate parameter that you have correlated to gas flowrate);

(C) Continuously calculate and record in the operating record a MTEC assuming mercury from all hazardous waste feedstreams is emitted;

(D) Interlock the MTEC calculated in paragraph (b)(15)(iii)(C) of this section to the AWFCO system to stop hazardous waste burning when the MTEC exceeds the operating requirement of paragraph (b)(15)(ii) of this section.

(iv) In lieu of the requirement in paragraph (b)(15)(iii) of this section, you may:

(A) Identify in the Notification of Compliance a minimum gas flowrate limit and a maximum feedrate limit of mercury from all hazardous waste feedstreams that ensures the MTEC calculated in paragraph (b)(15)(iii)(C) of this section is below the operating requirement of paragraph (b)(15)(ii) of this section; and

(B) Interlock the minimum gas flowrate limit and maximum feedrate limits in paragraph (b)(15)(iv)(A) of this section to the AWFCO system to stop hazardous waste burning when the gas flowrate or mercury feedrate exceeds the limits in paragraph (b)(15)(iv)(A) of this section.

(v) *Notification requirement.* You must notify in writing the RCRA authority that you intend to comply with the alternative standard.

(16) *Compliance with subcategory standards for liquid fuel boilers.* You must comply with the mercury, semivolatile metals, low volatile metals, and hydrogen chloride and chlorine standards for liquid fuel boilers under § 63.1217 as follows:

(i) You must determine the as-fired heating value of each batch of hazardous waste fired by each firing system of the boiler so that you know the mass-weighted heating value of the hazardous waste fired at all times.

(ii) If the as-fired heating value of the hazardous waste is 10,000 Btu per pound or greater, you are subject to the thermal emission concentration standards (lb/million Btu) under § 63.1217.

(iii) If the as-fired heating value of the hazardous waste is less than 10,000 Btu/lb, you are subject to the mass or volume emission concentration standards ($\mu\text{gm/dscm}$ or ppmv) under § 63.1217.

(iv) If the as-fired heating value of hazardous wastes varies above and below 10,000 Btu/lb over time, you are subject to the thermal concentration standards when the heating value is 10,000 Btu/lb or greater and the mass concentration standards when the heating value is less than 10,000 Btu/lb. You may elect to comply at all times with the more stringent operating requirements that ensure compliance with both the thermal emission concentration standards and the mass or volume emission concentration standards.

(c) *Operating requirements* —(1) *General.* (i) You must operate only under the operating requirements specified in the Documentation of Compliance under § 63.1211(c) or the Notification of Compliance under §§ 63.1207(j) and 63.1210(d), except:

(A) During performance tests under approved test plans according to § 63.1207(e), (f), and (g), and

(B) Under the conditions of paragraph (b)(1)(i) or (ii) of this section;

(ii) The Documentation of Compliance and the Notification of Compliance must contain operating requirements including, but not limited to, the operating requirements in this section and § 63.1209

(iii) Failure to comply with the operating requirements is failure to ensure compliance with the emission standards of this subpart;

(iv) Operating requirements in the Notification of Compliance are applicable requirements for purposes of parts 70 and 71 of this chapter;

(v) The operating requirements specified in the Notification of Compliance will be incorporated in the title V permit.

(2) *Startup, shutdown, and malfunction plan.* (i) You are subject to the startup, shutdown, and malfunction plan requirements of § 63.6(e)(3).

(ii) If you elect to comply with §§ 270.235(a)(1)(iii), 270.235(a)(2)(iii), or 270.235(b)(1)(ii) of this chapter to address RCRA concerns that you minimize emissions of toxic compounds from startup, shutdown, and malfunction events (including releases from emergency safety vents):

(A) The startup, shutdown, and malfunction plan must include a description of potential causes of malfunctions, including releases from emergency safety vents, that may result in significant releases of hazardous air pollutants, and actions the source is taking to minimize the frequency and severity of those malfunctions.

(B) You must submit the startup, shutdown, and malfunction plan to the Administrator for review and approval.

(1) *Approval procedure.* The Administrator will notify you of approval or intention to deny approval of the startup, shutdown, and malfunction plan within 90 calendar days after receipt of the original request and within 60 calendar days after receipt of any supplemental information that you submit. Before disapproving the plan, the Administrator will notify you of the Administrator's intention to disapprove the plan together with:

(i) Notice of the information and findings on which intended disapproval is based; and

(ii) Notice of opportunity for you to present additional information to the Administrator before final action on disapproval of the plan. At the time the Administrator notifies you of intention to disapprove the plan, the Administrator will specify how much time you will have after being notified on the intended disapproval to submit additional information.

(2) *Responsibility of owners and operators.* You are responsible for ensuring that you submit any supplementary and additional information supporting your plan in a timely manner to enable the Administrator to consider whether to approve the plan. Neither your submittal of the plan, nor the Administrator's failure to approve or disapprove the plan, relieves you of the responsibility to comply with the provisions of this subpart.

(C) *Changes to the plan that may significantly increase emissions.* (1) You must request approval in writing from the Administrator within 5 days after making a change to the startup, shutdown, and malfunction plan that may significantly increase emissions of hazardous air pollutants.

(2) To request approval of such changes to the startup, shutdown, and malfunction plan, you must follow the procedures provided by paragraph (c)(2)(ii)(B) of this section for initial approval of the plan.

(iii) You must identify in the plan a projected oxygen correction factor based on normal operations to use during periods of startup and shutdown.

(iv) You must record the plan in the operating record.

(v) *Operating under the startup, shutdown, and malfunction plan* —(A) *Compliance with AWFCO requirements during malfunctions.* (1) During malfunctions, the automatic waste feed cutoff requirements of § 63.1206(c)(3) continue to apply, except for paragraphs (c)(3)(v) and (c)(3)(vi) of this section. If you exceed a part 63, subpart EEE, of this chapter emission standard monitored by a CEMS or COMs or operating limit specified under § 63.1209, the automatic waste feed cutoff system must immediately and automatically cutoff the hazardous waste feed, except as provided by paragraph (c)(3)(viii) of this section. If the malfunction itself prevents immediate and automatic cutoff of the hazardous waste feed, however, you must cease feeding hazardous waste as quickly as possible.

(2) Although the automatic waste feed cutoff requirements continue to apply during a malfunction, an exceedance of an emission standard monitored by a CEMS or COMS or operating limit specified under § 63.1209 is not a violation of this subpart if you take the corrective measures prescribed in the startup, shutdown, and malfunction plan.

(3) *Excessive exceedances during malfunctions.* For each set of 10 exceedances of an emission standard or operating requirement while hazardous waste remains in the combustion chamber (i.e., when the hazardous waste residence time has not transpired since the hazardous waste feed was cutoff) during a 60-day block period, you must:

(i) Within 45 days of the 10th exceedance, complete an investigation of the cause of each exceedance and evaluation of approaches to minimize the frequency, duration, and severity of each exceedance, and revise the startup, shutdown, and malfunction plan as warranted by the evaluation to minimize the frequency, duration, and severity of each exceedance; and

(ii) Record the results of the investigation and evaluation in the operating record, and include a summary of the investigation and evaluation, and any changes to the startup, shutdown, and malfunction plan, in the excess emissions report required under § 63.10(e)(3).

(B) *Compliance with AWFCO requirements when burning hazardous waste during startup and shutdown.* (1) If you feed hazardous waste during startup or shutdown, you must include waste feed restrictions (e.g., type and quantity), and other appropriate operating conditions and limits in the startup, shutdown, and malfunction plan.

(2) You must interlock the operating limits you establish under paragraph (c)(2)(v)(B)(1) of this section with the automatic waste feed cutoff system required under § 63.1206(c)(3), except for paragraphs (c)(3)(v) and (c)(3)(vi) of this section.

(3) When feeding hazardous waste during startup or shutdown, the automatic waste feed cutoff system must immediately and automatically cutoff the hazardous waste feed if you exceed the operating limits you establish under paragraph (c)(2)(v)(B)(1) of this section, except as provided by paragraph (c)(3)(viii) of this section.

(4) Although the automatic waste feed cutoff requirements of this paragraph apply during startup and shutdown, an exceedance of an emission standard or operating limit is not a violation of this subpart if you comply with the operating procedures prescribed in the startup, shutdown, and malfunction plan.

(3) *Automatic waste feed cutoff (AWFCO)* —(i) *General.* Upon the compliance date, you must operate the hazardous waste combustor with a functioning system that immediately and automatically cuts off the hazardous waste feed, except as provided by paragraph (c)(3)(viii) of this section:

(A) When any of the following are exceeded: Operating parameter limits specified under § 63.1209; an emission standard monitored by a CEMS; and the allowable combustion chamber pressure;

(B) When the span value of any CMS detector, except a CEMS, is met or exceeded;

(C) Upon malfunction of a CMS monitoring an operating parameter limit specified under § 63.1209 or an emission level; or

(D) When any component of the automatic waste feed cutoff system fails.

(ii) *Ducting of combustion gases.* During an AWFCO, you must continue to duct combustion gasses to the air pollution control system while hazardous waste remains in the combustion chamber (i.e., if the hazardous waste residence time has not transpired since the hazardous waste feed cutoff system was activated).

(iii) *Restarting waste feed.* You must continue to monitor during the cutoff the operating parameters for which limits are established under § 63.1209 and the emissions required under that section to be monitored by a CEMS, and you must not restart the hazardous waste feed until the operating parameters and emission levels are within the specified limits.

(iv) *Failure of the AWFCO system.* If the AWFCO system fails to automatically and immediately cutoff the flow of hazardous waste upon exceedance of a parameter required to be interlocked with the AWFCO system under paragraph (c)(3)(i) of this section, you have failed to comply with the AWFCO requirements of paragraph (c)(3) of this section. If an equipment or other failure prevents immediate and automatic cutoff of the hazardous waste feed, however, you must cease feeding hazardous waste as quickly as possible.

(v) *Corrective measures.* If, after any AWFCO, there is an exceedance of an emission standard or operating requirement, irrespective of whether the exceedance occurred while hazardous waste remained in the combustion chamber (i.e., whether the hazardous waste residence time has transpired since the hazardous waste feed cutoff system was activated), you must investigate the cause of the AWFCO, take appropriate corrective measures to minimize future AWFCOs, and record the findings and corrective measures in the operating record.

(vi) *Excessive exceedance reporting.* (A) For each set of 10 exceedances of an emission standard or operating requirement while hazardous waste remains in the combustion chamber (i.e., when the hazardous waste residence time has not transpired since the hazardous waste feed was cutoff) during a 60-day block period, you must submit to the Administrator a written report within 5 calendar days of the 10th exceedance documenting the exceedances and results of the investigation and corrective measures taken.

(B) On a case-by-case basis, the Administrator may require excessive exceedance reporting when fewer than 10 exceedances occur during a 60-day block period.

(vii) *Testing.* The AWFCO system and associated alarms must be tested at least weekly to verify operability, unless you document in the operating record that weekly inspections will unduly restrict or upset operations and that less frequent inspection will be adequate. At a minimum, you must conduct operability testing at least monthly. You must document and record in the operating record AWFCO operability test procedures and results.

(viii) *Ramping down waste feed.* (A) You may ramp down the waste feedrate of pumpable hazardous waste over a period not to exceed one minute, except as provided by paragraph (c)(3)(viii) (B) of this section. If you elect to ramp down the waste feed, you must document ramp down procedures in the operating and maintenance plan. The procedures must specify that the ramp down begins immediately upon initiation of automatic waste feed cutoff and the procedures must prescribe a bona fide ramping down. If an emission standard or operating limit is exceeded during the ramp down, you have failed to comply with the emission standards or operating requirements of this subpart.

(B) If the automatic waste feed cutoff is triggered by an exceedance of any of the following operating limits, you may not ramp down the waste feed cutoff: Minimum combustion chamber temperature, maximum hazardous waste feedrate, or any hazardous waste firing system operating limits that may be established for your combustor.

(4) *ESV openings* —(i) *Failure to meet standards.* If an emergency safety vent (ESV) opens when hazardous waste remains in the combustion chamber (i.e., when the hazardous waste residence time has not expired) during an event other than a malfunction as defined in the startup, shutdown, and malfunction plan such that combustion gases are not treated as during the most recent comprehensive performance test (e.g., if the combustion gas by-passes any emission control device that was operating during the performance test), you must document in the operating record whether you remain in compliance with the emission standards of this subpart considering emissions during the ESV opening event.

(ii) *ESV operating plan.* (A) You must develop an ESV operating plan, comply with the operating plan, and keep the plan in the operating record.

(B) The ESV operating plan must provide detailed procedures for rapidly stopping the waste feed, shutting down the combustor, and maintaining temperature and negative pressure in the combustion chamber during the hazardous waste residence time, if feasible. The plan must include calculations and information and data documenting the effectiveness of the plan's procedures for ensuring that combustion chamber temperature and negative pressure are maintained as is reasonably feasible.

(iii) *Corrective measures.* After any ESV opening that results in a failure to meet the emission standards as defined in paragraph (c)(4)(i) of this section, you must investigate the cause of the ESV opening, take appropriate corrective measures to minimize such future ESV openings, and record the findings and corrective measures in the operating record.

(iv) *Reporting requirements.* You must submit to the Administrator a written report within 5 days of an ESV opening that results in failure to meet the emission standards of this subpart (as determined in paragraph (c)(4)(i) of this section) documenting the result of the investigation and corrective measures taken.

(5) *Combustion system leaks.* (i) Combustion system leaks of hazardous air pollutants must be controlled by:

(A) Keeping the combustion zone sealed to prevent combustion system leaks; or

(B) Maintaining the maximum combustion zone pressure lower than ambient pressure using an instantaneous monitor; or

(C) Upon prior written approval of the Administrator, an alternative means of control to provide control of combustion system leaks equivalent to maintenance of combustion zone pressure lower than ambient pressure; or

(D) Upon prior written approval of the Administrator, other technique(s) which can be demonstrated to prevent fugitive emissions without use of instantaneous pressure limits; and

(ii) You must specify in the performance test workplan and Notification of Compliance the method that will be used to control combustion system leaks. If you control combustion system leaks by maintaining the combustion zone pressure lower than ambient pressure using an instantaneous monitor, you must also specify in the performance test workplan and Notification of Compliance the monitoring and recording frequency of the pressure monitor, and specify how the monitoring approach will be integrated into the automatic waste feed cutoff system.

(6) *Operator training and certification.* (i) You must establish training programs for all categories of personnel whose activities may reasonably be expected to directly affect emissions of hazardous air pollutants from the source. Such persons include, but are not limited to, chief facility operators, control room operators, continuous monitoring system operators, persons that sample and analyze feedstreams, persons that manage and charge feedstreams to the combustor, persons that operate emission control devices, and ash and waste handlers. Each training program shall be of a technical level commensurate with the person's job duties specified in the training manual. Each commensurate training program shall require an examination to be administered by the instructor at the end of the training course. Passing of this test shall be deemed the "certification" for personnel, except that, for control room operators, the training and certification program shall be as specified in paragraphs (c)(6)(iii) through (c)(6)(vi) of this section.

(ii) You must ensure that the source is operated and maintained at all times by persons who are trained and certified to perform these and any other duties that may affect emissions of hazardous air pollutants. A certified control room operator must be on duty at the site at all times the source is in operation.

(iii) Hazardous waste incinerator control room operators must:

(A) Be trained and certified under a site-specific, source-developed and implemented program that meets the requirements of paragraph (c)(6)(v) of this section; or

(B) Be trained under the requirements of, and certified under, one of the following American Society of Mechanical Engineers (ASME) standards: QHO-1-1994, QHO-1a-1996, or QHO-1-2004 (Standard for the Qualification and Certification of Hazardous Waste Incinerator Operators). If you elect to use the ASME program:

(1) Control room operators must, prior to the compliance date, achieve provisional certification, and must submit an application to ASME and be scheduled for the full certification exam. Within one year of the compliance date, control room operators must achieve full certification;

(2) New operators and operators of new sources must, before assuming their duties, achieve provisional certification, and must submit an application to ASME, and be scheduled for the full certification exam. Within one year of assuming their duties, these operators must achieve full certification; or

(C) Be trained and certified under a State program.

(iv) Control room operators of cement kilns, lightweight aggregate kilns, solid fuel boilers, liquid fuel boilers, and hydrochloric acid production furnaces must be trained and certified under:

(A) A site-specific, source-developed and implemented program that meets the requirements of paragraph (c)(6)(v) of this section; or

(B) A State program.

(v) Site-specific, source developed and implemented training programs for control room operators must include the following elements:

(A) Training on the following subjects:

(1) Environmental concerns, including types of emissions;

(2) Basic combustion principles, including products of combustion;

(3) Operation of the specific type of combustor used by the operator, including proper startup, waste firing, and shutdown procedures;

(4) Combustion controls and continuous monitoring systems;

(5) Operation of air pollution control equipment and factors affecting performance;

(6) Inspection and maintenance of the combustor, continuous monitoring systems, and air pollution control devices;

(7) Actions to correct malfunctions or conditions that may lead to malfunction;

(8) Residue characteristics and handling procedures; and

(9) Applicable Federal, state, and local regulations, including Occupational Safety and Health Administration workplace standards; and

(B) An examination designed and administered by the instructor; and

(C) Written material covering the training course topics that may serve as reference material following completion of the course.

(vi) To maintain control room operator qualification under a site-specific, source developed and implemented training program as provided by paragraph (c)(6)(v) of this section, control room operators must complete an annual review or refresher course covering, at a minimum, the following topics:

(A) Update of regulations;

(B) Combustor operation, including startup and shutdown procedures, waste firing, and residue handling;

(C) Inspection and maintenance;

(D) Responses to malfunctions or conditions that may lead to malfunction; and

(E) Operating problems encountered by the operator.

(vii) You must record the operator training and certification program in the operating record.

(7) *Operation and maintenance plan* —(i) You must prepare and at all times operate according to an operation and maintenance plan that describes in detail procedures for operation, inspection, maintenance, and corrective measures for all components of the combustor, including associated pollution control equipment, that could affect emissions of regulated hazardous air pollutants.

(ii) The plan must prescribe how you will operate and maintain the combustor in a manner consistent with good air pollution control practices for minimizing emissions at least to the levels achieved during the comprehensive performance test.

(iii) This plan ensures compliance with the operation and maintenance requirements of § 63.6(e) and minimizes emissions of pollutants, automatic waste feed cutoffs, and malfunctions.

(iv) You must record the plan in the operating record.

(8) *Bag leak detection system requirements.* (i) If your combustor is equipped with a baghouse (fabric filter), you must continuously operate either:

(A) A bag leak detection system that meets the specifications and requirements of paragraph (c)(8)(ii) of this section and you must comply with the corrective measures and notification requirements of paragraphs (c)(8)(iii) and (iv) of this section; or

(B) A particulate matter detection system under paragraph (c)(9) of this section.

(ii) *Bag leak detection system specification and requirements.* (A) The bag leak detection system must be certified by the manufacturer to be capable of continuously detecting and recording particulate matter emissions at concentrations of 1.0 milligrams per actual cubic meter unless you demonstrate, under § 63.1209(g)(1), that a higher detection limit would routinely detect particulate matter loadings during normal operations;

(B) The bag leak detection system shall provide output of relative or absolute particulate matter loadings;

(C) The bag leak detection system shall be equipped with an alarm system that will sound an audible alarm when an increase in relative particulate loadings is detected over a preset level;

(D) The bag leak detection system shall be installed and operated in a manner consistent with available written guidance from the U.S. Environmental Protection Agency or, in the absence of such written guidance, the manufacturer's written specifications and recommendations for installation, operation, and adjustment of the system;

(E) The initial adjustment of the system shall, at a minimum, consist of establishing the baseline output by adjusting the sensitivity (range) and the averaging period of the device, and establishing the alarm set points and the alarm delay time;

(F) Following initial adjustment, you must not adjust the sensitivity or range, averaging period, alarm set points, or alarm delay time, except as detailed in the operation and maintenance plan required under paragraph (c)(7) of this section. You must not increase the sensitivity by more than 100

percent or decrease the sensitivity by more than 50 percent over a 365 day period unless such adjustment follows a complete baghouse inspection which demonstrates the baghouse is in good operating condition;

(G) For negative pressure or induced air baghouses, and positive pressure baghouses that are discharged to the atmosphere through a stack, the bag leak detector shall be installed downstream of the baghouse and upstream of any wet acid gas scrubber; and

(H) Where multiple detectors are required, the system's instrumentation and alarm system may be shared among the detectors.

(iii) *Bag leak detection system corrective measures requirements* . The operating and maintenance plan required by paragraph (c)(7) of this section must include a corrective measures plan that specifies the procedures you will follow in the case of a bag leak detection system alarm or malfunction. The corrective measures plan must include, at a minimum, the procedures used to determine and record the time and cause of the alarm or bag leak detection system malfunction in accordance with the requirements of paragraph (c)(8)(iii)(A) of this section as well as the corrective measures taken to correct the control device or bag leak detection system malfunction or to minimize emissions in accordance with the requirements of paragraph (c)(8)(iii)(B) of this section. Failure to initiate the corrective measures required by this paragraph is failure to ensure compliance with the emission standards in this subpart.

(A) You must initiate the procedures used to determine the cause of the alarm or bag leak detection system malfunction within 30 minutes of the time the alarm first sounds; and

(B) You must alleviate the cause of the alarm or bag leak detection system malfunction by taking the necessary corrective measure(s) which may include, but are not to be limited to, the following:

(1) Inspecting the baghouse for air leaks, torn or broken filter elements, or any other malfunction that may cause an increase in emissions;

(2) Sealing off defective bags or filter media;

(3) Replacing defective bags or filter media, or otherwise repairing the control device;

(4) Sealing off a defective baghouse compartment;

(5) Cleaning the bag leak detection system probe, or otherwise repairing the bag leak detection system; or

(6) Shutting down the combustor.

(iv) *Excessive exceedances notification* . If you operate the combustor when the detector response exceeds the alarm set-point or the bag leak detection system is malfunctioning more than 5 percent of the time during any 6-month block time period, you must submit a notification to the Administrator within 30 days of the end of the 6-month block time period that describes the causes of the exceedances and bag leak detection system malfunctions and the revisions to the design, operation, or maintenance of the combustor, baghouse, or bag leak detection system you are taking to minimize exceedances and bag leak detection system malfunctions. To document compliance with this requirement:

(A) You must keep records of the date, time, and duration of each alarm and bag leak detection system malfunction, the time corrective action was initiated and completed, and a brief description of the cause of the alarm or bag leak detection system malfunction and the corrective action taken;

(B) You must record the percent of the operating time during each 6-month period that the alarm sounds and the bag leak detection system malfunctions;

(C) If inspection of the fabric filter demonstrates that no corrective action is required, then no alarm time is counted; and

(D) If corrective action is required, each alarm shall be counted as a minimum of 1 hour. Each bag leak detection system malfunction shall also be counted as a minimum of 1 hour.

(9) *Particulate matter detection system requirements* . You must continuously operate a particulate matter detection system (PMDS) that meets the specifications and requirements of paragraphs (c)(9)(i) through (v) of this section and you must comply with the corrective measures and notification requirements of paragraphs (c)(9)(vii) and (viii) of this section if your combustor either: Is equipped with an electrostatic precipitator or ionizing wet scrubber and you do not establish site-specific control device operating parameter limits under § 63.1209(m)(1)(iv) that are linked to the automatic waste feed cutoff system under paragraph (c)(3) of this section, or is equipped with a baghouse (fabric filter) and you do not operate a bag leak detection system as provided by paragraph (c)(8)(i)(B) of this section.

(i) *PMDS requirements* .—(A) The PMDS must be certified by the manufacturer to be capable of continuously detecting and recording particulate matter emissions at concentrations of 1.0 milligrams per actual cubic meter unless you demonstrate, under § 63.1209(g)(1), that a higher detection limit would routinely detect particulate matter loadings during normal operations;

(B) The particulate matter detector shall provide output of relative or absolute particulate matter loadings;

(C) The PMDS shall be equipped with an alarm system that will sound an audible alarm when an increase in relative or absolute particulate loadings is detected over the set-point;

(D) You must install, operate, and maintain the PMDS in a manner consistent with the provisions of paragraph (c)(9) of this section and available written guidance from the U.S. Environmental Protection Agency or, in the absence of such written guidance, the manufacturer's written specifications and recommendations for installation, operation, maintenance and quality assurance of the system.

(1) *Set-points established without extrapolation* . If you establish the alarm set-point without extrapolation under paragraph (c)(9)(iii)(A) of this section, you must request approval from the regulatory authority, in the continuous monitoring system test plan, of the quality assurance procedures that will reasonably ensure that PMDS response values below the alarm set-point correspond to PM emission concentrations below those demonstrated during the comprehensive performance test. Your recommended quality assurance procedures may include periodic testing under as-found conditions (i.e., normal operations) to obtain additional PM concentration and PMDS response run pairs, as warranted.

(2) *Set-points established with extrapolation* . If you establish the alarm set-point by extrapolation under paragraph (c)(9)(iii)(B) of this section, you must request approval from the regulatory authority, in the continuous monitoring system test plan, of the quality assurance procedures that will reasonably ensure that PMDS response values below the alarm set-point correspond to PM emission concentrations below the value that correlates to the alarm set-point.

(E) You must include procedures for installation, operation, maintenance, and quality assurance of the PMDS in the site-specific continuous monitoring system test plan required under §§ 63.1207(e) and 63.8(e)(3);

(F) Where multiple detectors are required to monitor multiple control devices, the system's instrumentation and alarm system may be shared among the detectors.

(G) You must establish the alarm set-point as a 6-hour rolling average as provided by paragraphs (c)(9)(ii), (c)(9)(iii), and (c)(9)(iv) of this section;

(H) Your PMDS must complete a minimum of one cycle of operation (sampling, analyzing, and data recording) for each successive 15-minute period. You must update the 6-hour rolling average of the detector response each hour with a one-hour block average that is the average of the detector responses over each 15-minute block; and

(l) If you exceed the alarm set-point (or if your PMDS malfunctions), you must comply with the corrective measures under paragraph (c)(9)(vii) of this section.

(ii) *Establishing the alarm set-point for operations under the Documentation of Compliance* . You must establish the alarm set-point for operations under the Documentation of Compliance (i.e., after the compliance date but prior to submitting a Notification of Compliance subsequent to conducting the initial comprehensive performance test) of an existing source as follows:

(A) You must obtain a minimum of three pairs of Method 5 or 5l data, provided in appendix A-3 to part 60 of this chapter, and PMDS data to establish an approximate correlation curve. Data obtained up to 60 months prior to the compliance date may be used provided that the design and operation of the combustor or PMDS has not changed in a manner that may adversely affect the correlation of PM concentrations and PMDS response.

(B) You must request approval from the regulatory authority, in the continuous monitoring system test plan, of your determination whether multiple correlation curves are needed considering the design and operation of your combustor and PMDS.

(C) You must approximate the correlation of the reference method data to the PMDS data.

(1) You may assume a linear correlation of the PMDS response to particulate matter emission concentrations;

(2) You may include a zero point correlation value. To establish a zero point, you must follow one or more of the following steps:

(i) Zero point data for in-situ instruments should be obtained, to the extent possible, by removing the instrument from the stack and monitoring ambient air on a test bench;

(ii) Zero point data for extractive instruments should be obtained by removing the extractive probe from the stack and drawing in clean ambient air;

(iii) Zero point data also can be obtained by performing manual reference method measurements when the flue gas is free of PM emissions or contains very low PM concentrations (e.g., when your process is not operating, but the fans are operating or your source is combusting only natural gas); and

(iv) If none of the steps in paragraphs (c)(9)(ii)(B)(2)(i) through (iii) of this section are possible, you must estimate the monitor response when no PM is in the flue gas (e.g., 4 mA = 0 mg/acm).

(3) For reference method data that were obtained from runs during a test condition where controllable operating factors were held constant, you must average the test run averages of PM concentrations and PMDS responses to obtain a single pair of data for PM concentration and PMDS response. You may use this pair of data and the zero point to define a linear correlation model for the PMDS.

(D) You must establish the alarm set-point as the PMDS response that corresponds to a PM concentration that is 50% of the PM emission standard or 125% of the highest PM concentration used to develop the correlation, whichever is greater. For reference method data that were obtained from runs during a test condition where controllable operating factors were held constant, you must use the average of the test run averages of PM concentrations for extrapolating the alarm set-point. The PM emission concentration used to extrapolate the alarm set-point must not exceed the PM emission standard, however.

(iii) *Establishing the initial alarm set-point for operations under the Notification of Compliance* . You must establish the initial alarm set-point for operations under the Notification of Compliance as provided by either paragraph (c)(9)(iii)(A) or paragraph (c)(9)(iii)(B) of this section. You must periodically revise the alarm set-point as provided by paragraph (c)(9)(iv) of this section.

(A) *Establishing the initial set-point without extrapolation* . (1) If you establish the initial alarm set-point without extrapolation, the alarm set-point is the average of the test run averages of the PMDS response during the runs of the comprehensive performance test that document compliance with the PM emission standard.

(2) During the comprehensive performance test, you may simulate PM emission concentrations at the upper end of the range of normal operations by means including feeding high levels of ash and detuning the emission control equipment.

(B) *Establishing the initial set-point by extrapolation* . You may extrapolate the particulate matter detector response to establish the alarm set-point under the following procedures:

(1) You must request approval from the regulatory authority, in the continuous monitoring system test plan, of the procedures you will use to establish an approximate correlation curve using the three pairs of Method 5 or 5I data (see methods in appendix A-3 of part 60 of this chapter) and PMDS data from the comprehensive performance test, the data pairs used to establish the correlation curve for the Documentation of Compliance under paragraph (c)(9)(ii) of this section, and additional data pairs, as warranted.

(2) You must request approval from the regulatory authority, in the continuous monitoring system test plan, of your determination of whether multiple correlation curves are needed considering the design and operation of your combustor and PMDS. If so, you must recommend the number of data pairs needed to establish those correlation curves and how the data will be obtained.

(3) During the comprehensive performance test, you may simulate PM emission concentrations at the upper end of the range of normal operations by means including feeding high levels of ash and detuning the emission control equipment.

(4) Data obtained up to 60 months prior to the comprehensive performance test may be used provided that the design and operation of the combustor or PMDS has not changed in a manner that may adversely affect the correlation of PM concentrations and PMDS response.

(5) You may include a zero point correlation value. To establish a zero point, you must follow the procedures under paragraph (c)(9)(ii)(C)(2) of this section.

(6) You must use a least-squares regression model to correlate PM concentrations to PMDS responses for data pairs. You may assume a linear regression model approximates the relationship between PM concentrations and PMDS responses.

(7) You must establish the alarm set-point as the PMDS response that corresponds to a PM concentration that is 50% of the PM emission standard or 125% of the highest PM concentration used to develop the correlation, whichever is greater. The emission concentration used to extrapolate the PMDS response must not exceed the PM emission standard.

(iv) *Revising the Notification of Compliance alarm set-point* —(A) *Revising set-points established without extrapolation* . If you establish the alarm set-point without extrapolation under paragraph (c)(9)(iii)(A) of this section, you must establish a new alarm set-point in the Notification of Compliance following each comprehensive performance test as the average of the test run averages of the PMDS response during the runs of the comprehensive performance test that document compliance with the PM emission standard.

(B) *Revising set-points established with extrapolation* . If you establish the alarm set-point by extrapolation under paragraph (c)(9)(iii)(B) of this section, you must request approval from the regulatory authority, in the continuous monitoring system test plan, of the procedures for periodically revising the alarm set-point, considering the additional data pairs obtained during periodic comprehensive performance tests and data pairs obtained from other tests, such as for quality assurance.

(v) *Quality assurance —(A) Set-points established without extrapolation* . If you establish the alarm set-point without extrapolation under paragraph (c)(9)(iii)(A) of this section, you must request approval from the regulatory authority, in the continuous monitoring system test plan, of the quality assurance procedures that reasonably ensure that PMDS response values below the alarm set-point correspond to PM emission concentrations below the average of the PM concentrations demonstrated during the comprehensive performance test. Your recommended quality assurance procedures may include periodic testing under as-found conditions (i.e., normal operations) to obtain additional PM concentration and PMDS response run pairs, as warranted.

(B) *Set-points established with extrapolation* . If you establish the alarm set-point by extrapolation under paragraph (c)(9)(iii)(B) of this section, you must request approval from the regulatory authority, in the continuous monitoring system test plan, of the quality assurance procedures that reasonably ensure that PMDS response values below the alarm set-point correspond to PM emission concentrations below the value that correlated to the alarm set-point.

(vi) *PMDS are used for compliance assurance only* . For a PMDS for which the alarm set-point is established by extrapolation using a correlation curve under paragraphs (c)(9)(ii), (c)(9)(iii)(B), and (c)(9)(iv)(B) of this section, an exceedance of the PMDS response that appears to correlate with a PM concentration that exceeds the PM emission standard is not by itself evidence that the standard has been exceeded.

(vii) *PMDS corrective measures requirements* . The operating and maintenance plan required by paragraph (c)(7) of this section must include a corrective measures plan that specifies the procedures you will follow in the case of a PMDS alarm or malfunction. The corrective measures plan must include, at a minimum, the procedures used to determine and record the time and cause of the alarm or PMDS malfunction as well as the corrective measures taken to correct the control device or PMDS malfunction or minimize emissions as specified below. Failure to initiate the corrective measures required by this paragraph is failure to ensure compliance with the emission standards in this subpart.

(A) You must initiate the procedures used to determine the cause of the alarm or PMDS malfunction within 30 minutes of the time the alarm first sounds or the PMDS malfunctions; and

(B) You must alleviate the cause of the alarm or the PMDS malfunction by taking the necessary corrective measure(s) which may include shutting down the combustor.

(viii) *Excessive exceedances notification* . If you operate the combustor when the detector response exceeds the alarm set-point or when the PMDS is malfunctioning more than 5 percent of the time during any 6-month block time period, you must submit a notification to the Administrator within 30 days of the end of the 6-month block time period that describes the causes of the exceedances and the revisions to the design, operation, or maintenance of the combustor, emission control device, or PMDS you are taking to minimize exceedances. To document compliance with this requirement:

(A) You must keep records of the date, time, and duration of each alarm and PMDS malfunction, the time corrective action was initiated and completed, and a brief description of the cause of the alarm or PMDS malfunction and the corrective action taken;

(B) You must record the percent of the operating time during each 6-month period that the alarm sounds and the PMDS malfunctions;

(C) If inspection of the emission control device demonstrates that no corrective action is required, then no alarm time is counted; and

(D) If corrective action to the emission control device is required, each alarm shall be counted as a minimum of 1 hour. Each PMDS malfunction shall also be counted as a minimum of 1 hour.

[64 FR 53038, Sept. 30, 1999, as amended at 65 FR 42298, July 10, 2000; 65 FR 67271, Nov. 9, 2000; 66 FR 24272, May 14, 2001; 66 FR 35103, July 3, 2001; 66 FR 63317, Dec. 7, 2001; 67 FR 6813, Feb. 13, 2002; 67 FR 6989, Feb. 14, 2002; 67 FR 77691, Dec. 19, 2002; 70 FR 59541, Oct. 12, 2005; 70 FR 75047, Dec. 19, 2005; 71 FR 20459, Apr. 20, 2006; 71 FR 62393, Oct. 25, 2006; 73 FR 18979, Apr. 8, 2008; 73 FR 64094, Oct. 28, 2008]

§ 63.1207 What are the performance testing requirements?

(a) *General.* The provisions of § 63.7 apply, except as noted below.

(b) *Types of performance tests* —(1) *Comprehensive performance test.* You must conduct comprehensive performance tests to demonstrate compliance with the emission standards provided by this subpart, establish limits for the operating parameters provided by § 63.1209, and demonstrate compliance with the performance specifications for continuous monitoring systems.

(2) *Confirmatory performance test.* You must conduct confirmatory performance tests to:

(i) Demonstrate compliance with the dioxin/furan emission standard when the source operates under normal operating conditions; and

(ii) Conduct a performance evaluation of continuous monitoring systems required for compliance assurance with the dioxin/furan emission standard under § 63.1209(k).

(3) *One-Time Dioxin/Furan Test for Sources Not Subject to a Numerical Dioxin/Furan Standard.* For solid fuel boilers and hydrochloric acid production furnaces, for lightweight aggregate kilns that are not subject to a numerical dioxin/furan emission standard under § 63.1221, and liquid fuel boilers that are not subject to a numerical dioxin/furan emission standard under § 63.1217, you must conduct a one-time emission test for dioxin/furan under feed and operating conditions that are most likely to reflect daily maximum operating variability, similar to a dioxin/furan comprehensive performance test.

(i) You must conduct the dioxin/furan emissions test no later than the deadline for conducting the initial comprehensive performance test.

(ii) You may use dioxin/furan emissions data from previous testing to meet this requirement, provided that:

(A) The testing was conducted under feed and operating conditions that are most likely to reflect daily maximum operating variability, similar to a dioxin/furan compliance test;

(B) You have not changed the design or operation of the source in a manner that could significantly affect stack gas dioxin/furan emission concentrations; and

(C) The data meet quality assurance objectives that may be determined on a site-specific basis.

(iii) You may use dioxin/furan emissions data from a source to represent emissions from another on-site source in lieu of testing (i.e., data in lieu of testing) if the design and operation, including hazardous waste feed and other feedstreams, of the sources are identical.

(iv) You must include the results of the one-time dioxin/furan emissions test with the results of the initial comprehensive performance test in the Notification of Compliance.

(v) You must repeat the dioxin/furan emissions test if you change the design or operation of the source in a manner that may increase dioxin/furan emissions.

(vi) Sources that are required to perform the one-time dioxin/furan test pursuant to paragraph (b) (3) of this section are not required to perform confirmatory performance tests.

(c) *Initial comprehensive performance test* —(1) *Test date.* Except as provided by paragraphs (c) (2) and (c)(3) of this section, you must commence the initial comprehensive performance test not later than six months after the compliance date.

(2) *Data in lieu of the initial comprehensive performance test.* (i) You may request that previous emissions test data serve as documentation of conformance with the emission standards of this subpart provided that the previous testing:

(A) Was initiated after 54 months prior to the compliance date, except as provided by paragraphs (c)(2)(iii) or (c)(2)(iv) of this section;

(B) Results in data that meet quality assurance objectives (determined on a site-specific basis) such that the results demonstrate compliance with the applicable standards;

(C) Was in conformance with the requirements of paragraph (g)(1) of this section; and

(D) Was sufficient to establish the applicable operating parameter limits under § 63.1209.

(ii) You must submit data in lieu of the initial comprehensive performance test in lieu of (i.e., if the data are in lieu of all performance testing) or with the notification of performance test required under paragraph (e) of this section.

(iii) The data in lieu test age restriction provided in paragraph (c)(2)(i)(A) of this section does not apply for the duration of the interim standards (i.e., the standards published in the FEDERAL REGISTER on February 13, 2002, 67 FR 6792). See 40 CFR parts 63, 264, 265, 266, 270, and 271 revised as of July 1, 2002. Paragraph (c)(2)(i)(A) of this section does not apply until EPA promulgates permanent replacement standards pursuant to the Settlement Agreement noticed in the FEDERAL REGISTER on November 16, 2001 (66 FR 57715).

(iv) The data in lieu test age restriction provided in paragraph (c)(2)(i)(A) of this section does not apply to DRE data provided you do not feed hazardous waste at a location in the combustion system other than the normal flame zone.

(3) For incinerators, cement kilns, and lightweight aggregate kilns, you must commence the initial comprehensive performance test to demonstrate compliance with the standards under §§ 63.1219, 63.1220, and 63.1221 not later than 12 months after the compliance date.

(d) *Frequency of testing.* Except as otherwise specified in paragraph (d)(4) of this section, you must conduct testing periodically as prescribed in paragraphs (d)(1) through (d)(3) of this section. The date of commencement of the initial comprehensive performance test is the basis for establishing the deadline to commence the initial confirmatory performance test and the next comprehensive performance test. You may conduct performance testing at any time prior to the required date. The deadline for commencing subsequent confirmatory and comprehensive performance testing is based on the date of commencement of the previous comprehensive performance test. Unless the Administrator grants a time extension under paragraph (i) of this section, you must conduct testing as follows:

(1) *Comprehensive performance testing.* Except as otherwise specified in paragraph (d)(4) of this section, you must commence testing no later than 61 months after the date of commencing the previous comprehensive performance test used to show compliance with § 63.1216, § 63.1217, § 63.1218, § 63.1219, § 63.1220, or § 63.1221. If you submit data in lieu of the initial performance test, you must commence the subsequent comprehensive performance test within 61 months of commencing the test used to provide the data in lieu of the initial performance test.

(2) *Confirmatory performance testing.* Except as otherwise specified in paragraph (d)(4) of this section, you must commence confirmatory performance testing no later than 31 months after the date of commencing the previous comprehensive performance test used to show compliance with § 63.1217, § 63.1219, § 63.1220, or § 63.1221. If you submit data in lieu of the initial performance test, you must commence the initial confirmatory performance test within 31 months of the date six months after the compliance date. To ensure that the confirmatory test is conducted approximately midway between comprehensive performance tests, the Administrator will not approve a test plan that schedules testing within 18 months of commencing the previous comprehensive performance test.

(3) *Duration of testing.* You must complete performance testing within 60 days after the date of commencement, unless the Administrator determines that a time extension is warranted based on your documentation in writing of factors beyond your control that prevent you from meeting the 60-day deadline.

(4) *Applicable testing requirements under the interim standards* —(i) *Waiver of periodic comprehensive performance tests* . Except as provided by paragraph (c)(2) of this section, you must conduct only an initial comprehensive performance test under the interim standards (§§ 63.1203 through 63.1205); all subsequent comprehensive performance testing requirements are waived under the interim standards. The provisions in the introductory text to paragraph (d) and in paragraph (d)(1) of this section apply only to tests used to demonstrate compliance with the standards under §§ 63.1219 through 63.1221.

(ii) *Waiver of confirmatory performance tests* . You are not required to conduct a confirmatory test under the interim standards (§§ 63.1203 through 63.1205). The confirmatory testing requirements in the introductory text to paragraph (d) and in paragraph (d)(2) of this section apply only after you have demonstrated compliance with the standards under §§ 63.1219 through 63.1221.

(e) *Notification of performance test and CMS performance evaluation, and approval of test plan and CMS performance evaluation plan*. (1) The provisions of § 63.7(b) and (c) and § 63.8(e) apply, except:

(i) *Comprehensive performance test*. You must submit to the Administrator a notification of your intention to conduct a comprehensive performance test and CMS performance evaluation and a site-specific test plan and CMS performance evaluation test plan at least one year before the performance test and performance evaluation are scheduled to begin.

(A) The Administrator will notify you of approval or intent to deny approval of the site-specific test plan and CMS performance evaluation test plan within 9 months after receipt of the original plan.

(B) You must submit to the Administrator a notification of your intention to conduct the comprehensive performance test at least 60 calendar days before the test is scheduled to begin.

(ii) *Confirmatory performance test*. You must submit to the Administrator a notification of your intention to conduct a confirmatory performance test and CMS performance evaluation and a site-specific test plan and CMS performance evaluation test plan at least 60 calendar days before the performance test is scheduled to begin. The Administrator will notify you of approval or intent to deny approval of the site-specific test plan and CMS performance evaluation test plan within 30 calendar days after receipt of the original test plans.

(2) You must make your site-specific test plan and CMS performance evaluation test plan available to the public for review no later than 60 calendar days before initiation of the test. You must issue a public notice to all persons on your facility/public mailing list (developed pursuant to 40 CFR 70.7(h), 71.11(d)(3)(i)(E) and 124.10(c)(1)(ix)) announcing the availability of the test plans and the location where the test plans are available for review. The test plans must be accessible to the public for 60 calendar days, beginning on the date that you issue your public notice. The location must be unrestricted and provide access to the public during reasonable hours and provide a means for the public to obtain copies. The notification must include the following information at a minimum:

- (i) The name and telephone number of the source's contact person;
- (ii) The name and telephone number of the regulatory agency's contact person;
- (iii) The location where the test plans and any necessary supporting documentation can be reviewed and copied;
- (iv) The time period for which the test plans will be available for public review; and
- (v) An expected time period for commencement and completion of the performance test and CMS performance evaluation test.

(3) *Petitions for time extension if Administrator fails to approve or deny test plans*. You may petition the Administrator under § 63.7(h) to obtain a “waiver” of any performance test—initial or

periodic performance test; comprehensive or confirmatory test. The “waiver” would be implemented as an extension of time to conduct the performance test at a later date.

(i) *Qualifications for the waiver.* (A) You may not petition the Administrator for a waiver under this section if the Administrator has issued a notification of intent to deny your test plan(s) under § 63.7(c)(3)(i)(B);

(B) You must submit a site-specific emissions testing plan and a continuous monitoring system performance evaluation test plan at least one year before a comprehensive performance test is scheduled to begin as required by paragraph (c)(1) of this section, or at least 60 days before a confirmatory performance test is scheduled to begin as required by paragraph (d) of this section. The test plans must include all required documentation, including the substantive content requirements of paragraph (f) of this section and § 63.8(e); and

(C) You must make a good faith effort to accommodate the Administrator's comments on the test plans.

(ii) *Procedures for obtaining a waiver and duration of the waiver.* (A) You must submit to the Administrator a waiver petition or request to renew the petition under § 63.7(h) separately for each source at least 60 days prior to the scheduled date of the performance test;

(B) The Administrator will approve or deny the petition within 30 days of receipt and notify you promptly of the decision;

(C) The Administrator will not approve an individual waiver petition for a duration exceeding 6 months;

(D) The Administrator will include a sunset provision in the waiver ending the waiver within 6 months;

(E) You may submit a revised petition to renew the waiver under § 63.7(h)(3)(iii) at least 60 days prior to the end date of the most recently approved waiver petition;

(F) The Administrator may approve a revised petition for a total waiver period up to 12 months.

(iii) *Content of the waiver.* (A) You must provide documentation to enable the Administrator to determine that the source is meeting the relevant standard(s) on a continuous basis as required by § 63.7(h)(2). For extension requests for the initial comprehensive performance test, you must submit your Documentation of Compliance to assist the Administrator in making this determination.

(B) You must include in the petition information justifying your request for a waiver, such as the technical or economic infeasibility, or the impracticality, of the affected source performing the required test, as required by § 63.7(h)(3)(iii).

(iv) *Public notice.* At the same time that you submit your petition to the Administrator, you must notify the public (e.g., distribute a notice to the facility/public mailing list developed pursuant to 40 CFR 70.7(h), 71.11(d)(3)(i)(E) and 124.10(c)(1)(ix)) of your petition to waive a performance test. The notification must include all of the following information at a minimum:

(A) The name and telephone number of the source's contact person;

(B) The name and telephone number of the regulatory agency's contact person;

(C) The date the source submitted its site-specific performance test plan and CMS performance evaluation test plans; and

(D) The length of time requested for the waiver.

(f) *Content of performance test plan.* The provisions of §§ 63.7(c)(2)(i)-(iii) and (v) regarding the content of the test plan apply. In addition, you must include the following information in the test plan:

(1) *Content of comprehensive performance test plan.* (i) An analysis of each feedstream, including hazardous waste, other fuels, and industrial furnace feedstocks, as fired, that includes:

(A) Heating value, levels of ash (for hazardous waste incinerators only), levels of semivolatile metals, low volatile metals, mercury, and total chlorine (organic and inorganic); and

(B) Viscosity or description of the physical form of the feedstream;

(ii) For organic hazardous air pollutants established by 42 U.S.C. 7412(b)(1), excluding caprolactam (CAS number 105602) as provided by § 63.60:

(A) Except as provided by paragraph (f)(1)(ii)(D) of this section, an identification of such organic hazardous air pollutants that are present in each hazardous waste feedstream. You need not analyze for organic hazardous air pollutants that would reasonably not be expected to be found in the feedstream. You must identify any constituents you exclude from analysis and explain the basis for excluding them. You must conduct the feedstream analysis according to § 63.1208(b)(8);

(B) An approximate quantification of such identified organic hazardous air pollutants in the hazardous waste feedstreams, within the precision produced by analytical procedures of § 63.1208(b)(8); and

(C) A description of blending procedures, if applicable, prior to firing the hazardous waste feedstream, including a detailed analysis of the materials prior to blending, and blending ratios.

(D) The Administrator may approve on a case-by-case basis a hazardous waste feedstream analysis for organic hazardous air pollutants in lieu of the analysis required under paragraph (f)(1)(ii)(A) of this section if the reduced analysis is sufficient to ensure that the POHCs used to demonstrate compliance with the applicable DRE standards of this subpart continue to be representative of the most difficult to destroy organic compounds in your hazardous waste feedstreams;

(iii) A detailed engineering description of the hazardous waste combustor, including:

(A) Manufacturer's name and model number of the hazardous waste combustor;

(B) Type of hazardous waste combustor;

(C) Maximum design capacity in appropriate units;

(D) Description of the feed system for each feedstream;

(E) Capacity of each feed system;

(F) Description of automatic hazardous waste feed cutoff system(s);

(G) Description of the design, operation, and maintenance practices for any air pollution control system; and

(H) Description of the design, operation, and maintenance practices of any stack gas monitoring and pollution control monitoring systems;

(iv) A detailed description of sampling and monitoring procedures including sampling and monitoring locations in the system, the equipment to be used, sampling and monitoring frequency, and planned analytical procedures for sample analysis;

(v) A detailed test schedule for each hazardous waste for which the performance test is planned, including date(s), duration, quantity of hazardous waste to be burned, and other relevant factors;

(vi) A detailed test protocol, including, for each hazardous waste identified, the ranges of hazardous waste feedrate for each feed system, and, as appropriate, the feedrates of other fuels and

feedstocks, and any other relevant parameters that may affect the ability of the hazardous waste combustor to meet the emission standards;

(vii) A description of, and planned operating conditions for, any emission control equipment that will be used;

(viii) Procedures for rapidly stopping the hazardous waste feed and controlling emissions in the event of an equipment malfunction;

(ix) A determination of the hazardous waste residence time as required by § 63.1206(b)(11);

(x) If you are requesting to extrapolate metal feedrate limits from comprehensive performance test levels under §§ 63.1209(l)(1)(v) or 63.1209(n)(2)(vii):

(A) A description of the extrapolation methodology and rationale for how the approach ensures compliance with the emission standards;

(B) Documentation of the historical range of normal (i.e., other than during compliance testing) metals feedrates for each feedstream;

(C) Documentation that the level of spiking recommended during the performance test will mask sampling and analysis imprecision and inaccuracy to the extent that the extrapolated feedrate limits adequately assure compliance with the emission standards;

(xi) If you do not continuously monitor regulated constituents in natural gas, process air feedstreams, and feedstreams from vapor recovery systems under § 63.1209(c)(5), you must include documentation of the expected levels of regulated constituents in those feedstreams;

(xii) Documentation justifying the duration of system conditioning required to ensure the combustor has achieved steady-state operations under performance test operating conditions, as provided by paragraph (g)(1)(iii) of this section;

(xiii) For cement kilns with in-line raw mills, if you elect to use the emissions averaging provision of this subpart, you must notify the Administrator of your intent in the initial (and subsequent) comprehensive performance test plan, and provide the information required by the emission averaging provision;

(xiv) For preheater or preheater/precalciner cement kilns with dual stacks, if you elect to use the emissions averaging provision of this subpart, you must notify the Administrator of your intent in the initial (and subsequent) comprehensive performance test plan, and provide the information required by the emission averaging provision;

(xv) If you request to use Method 23 for dioxin/furan you must provide the information required under § 63.1208(b)(1)(i)(B);

(xvi) If you are not required to conduct performance testing to document compliance with the mercury, semivolatile metals, low volatile metals, or hydrogen chloride/chlorine gas emission standards under paragraph (m) of this section, you must include with the comprehensive performance test plan documentation of compliance with the provisions of that section.

(xvii) If you propose to use a surrogate for measuring or monitoring gas flowrate, you must document in the comprehensive performance test plan that the surrogate adequately correlates with gas flowrate, as required by paragraph (m)(7) of this section, and § 63.1209(j)(2), (k)(3), (m)(2)(i), (n)(5)(i), and (o)(2)(i).

(xviii) You must submit an application to request alternative monitoring under § 63.1209(g)(1) not later than with the comprehensive performance test plan, as required by § 63.1209(g)(1)(iii)(A).

(xix) You must document the temperature location measurement in the comprehensive performance test plan, as required by §§ 63.1209(j)(1)(i) and 63.1209(k)(2)(i).

(xx) If your source is equipped with activated carbon injection, you must document in the comprehensive performance test plan:

(A) The manufacturer specifications for minimum carrier fluid flowrate or pressure drop, as required by § 63.1209(k)(6)(ii); and

(B) Key parameters that affect carbon adsorption, and the operating limits you establish for those parameters based on the carbon used during the performance test, if you elect not to specify and use the brand and type of carbon used during the comprehensive performance test, as required by § 63.1209(k)(6)(iii).

(xxi) If your source is equipped with a carbon bed system, and you elect not to specify and use the brand and type of carbon used during the comprehensive performance test, you must include in the comprehensive performance test plan key parameters that affect carbon adsorption, and the operating limits you establish for those parameters based on the carbon used during the performance test, as required by § 63.1209(k)(7)(ii).

(xxii) If you feed a dioxin/furan inhibitor into the combustion system, you must document in the comprehensive performance test plan key parameters that affect the effectiveness of the inhibitor, and the operating limits you establish for those parameters based on the inhibitor fed during the performance test, if you elect not to specify and use the brand and type of inhibitor used during the comprehensive performance test, as required by § 63.1209(k)(9)(ii).

(xxiii) If your source is equipped with a wet scrubber and you elect to monitor solids content of the scrubber liquid manually but believe that hourly monitoring of solids content is not warranted, you must support an alternative monitoring frequency in the comprehensive performance test plan, as required by § 63.1209(m)(1)(i)(B)(1)(i).

(xxiv) If your source is equipped with a particulate matter control device other than a wet scrubber, baghouse, or electrostatic precipitator, you must include in the comprehensive performance test plan:

(A) Documentation to support the operating parameter limits you establish for the control device, as required by § 63.1209(m)(1)(iv)(A)(4); and

(B) Support for the use of manufacturer specifications if you recommend such specifications in lieu of basing operating limits on performance test operating levels, as required by § 63.1209(m)(1)(iv)(D).

(xxv) If your source is equipped with a dry scrubber to control hydrogen chloride and chlorine gas, you must document in the comprehensive performance test plan key parameters that affect adsorption, and the limits you establish for those parameters based on the sorbent used during the performance test, if you elect not to specify and use the brand and type of sorbent used during the comprehensive performance test, as required by § 63.1209(o)(4)(iii)(A); and

(xxvi) For purposes of calculating semivolatile metal, low volatile metal, mercury, and total chlorine (organic and inorganic), and ash feedrate limits, a description of how you will handle performance test feedstream analytical results that determines these constituents are not present at detectable levels.

(xxvii) Such other information as the Administrator reasonably finds necessary to determine whether to approve the performance test plan.

(2) *Content of confirmatory test plan.* (i) A description of your normal hydrocarbon or carbon monoxide operating levels, as specified in paragraph (g)(2)(i) of this section, and an explanation of how these normal levels were determined;

(ii) A description of your normal applicable operating parameter levels, as specified in paragraph (g)(2)(ii) of this section, and an explanation of how these normal levels were determined;

(iii) A description of your normal chlorine operating levels, as specified in paragraph (g)(2)(iii) of this section, and an explanation of how these normal levels were determined;

(iv) If you use carbon injection or a carbon bed, a description of your normal cleaning cycle of the particulate matter control device, as specified in paragraph (g)(2)(iv) of this section, and an explanation of how these normal levels were determined;

(v) A detailed description of sampling and monitoring procedures including sampling and monitoring locations in the system, the equipment to be used, sampling and monitoring frequency, and planned analytical procedures for sample analysis;

(vi) A detailed test schedule for each hazardous waste for which the performance test is planned, including date(s), duration, quantity of hazardous waste to be burned, and other relevant factors;

(vii) A detailed test protocol, including, for each hazardous waste identified, the ranges of hazardous waste feedrate for each feed system, and, as appropriate, the feedrates of other fuels and feedstocks, and any other relevant parameters that may affect the ability of the hazardous waste combustor to meet the dioxin/furan emission standard;

(viii) A description of, and planned operating conditions for, any emission control equipment that will be used;

(ix) Procedures for rapidly stopping the hazardous waste feed and controlling emissions in the event of an equipment malfunction; and

(x) Such other information as the Administrator reasonably finds necessary to determine whether to approve the confirmatory test plan.

(g) *Operating conditions during testing.* You must comply with the provisions of § 63.7(e). Conducting performance testing under operating conditions representative of the extreme range of normal conditions is consistent with the requirement of § 63.7(e)(1) to conduct performance testing under representative operating conditions.

(1) *Comprehensive performance testing* —(i) *Operations during testing.* For the following parameters, you must operate the combustor during the performance test under normal conditions (or conditions that will result in higher than normal emissions):

(A) *Chlorine feedrate.* You must feed normal (or higher) levels of chlorine during the dioxin/furan performance test;

(B) *Ash feedrate.* For hazardous waste incinerators, you must conduct the following tests when feeding normal (or higher) levels of ash: The semivolatile metal and low volatile metal performance tests; and the dioxin/furan and mercury performance tests if activated carbon injection or a carbon bed is used; and

(C) *Cleaning cycle of the particulate matter control device.* You must conduct the following tests when the particulate matter control device undergoes its normal (or more frequent) cleaning cycle: The particulate matter, semivolatile metal, and low volatile metal performance tests; and the dioxin/furan and mercury performance tests if activated carbon injection or a carbon bed is used.

(ii) *Modes of operation.* Given that you must establish limits for the applicable operating parameters specified in § 63.1209 based on operations during the comprehensive performance test, you may conduct testing under two or more operating modes to provide operating flexibility.

(iii) *Steady-state conditions.* (A) Prior to obtaining performance test data, you must operate under performance test conditions until you reach steady-state operations with respect to emissions of pollutants you must measure during the performance test and operating parameters under § 63.1209 for which you must establish limits. During system conditioning, you must ensure that each operating parameter for which you must establish a limit is held at the level planned for the performance test.

You must include documentation in the performance test plan under paragraph (f) of this section justifying the duration of system conditioning.

(B) If you own or operate a hazardous waste cement kiln that recycles collected particulate matter (i.e., cement kiln dust) into the kiln, you must sample and analyze the recycled particulate matter prior to obtaining performance test data for levels of selected metals that must be measured during performance testing to document that the system has reached steady-state conditions (i.e., that metals levels have stabilized). You must document the rationale for selecting metals that are indicative of system equilibrium and include the information in the performance test plan under paragraph (f) of this section. To determine system equilibrium, you must sample and analyze the recycled particulate matter hourly for each selected metal, unless you submit in the performance test plan a justification for reduced sampling and analysis and the Administrator approves in writing a reduced sampling and analysis frequency.

(2) *Confirmatory performance testing.* You must conduct confirmatory performance testing for dioxin/furan under normal operating conditions for the following parameters:

(i) Carbon monoxide (or hydrocarbon) CEMS emissions levels must be within the range of the average value to the maximum value allowed, except as provided by paragraph (g)(2)(v) of this section. The average value is defined as the sum of the hourly rolling average values recorded (each minute) over the previous 12 months, divided by the number of rolling averages recorded during that time. The average value must not include calibration data, startup data, shutdown data, malfunction data, and data obtained when not burning hazardous waste;

(ii) Each operating limit (specified in § 63.1209) established to maintain compliance with the dioxin/furan emission standard must be held within the range of the average value over the previous 12 months and the maximum or minimum, as appropriate, that is allowed, except as provided by paragraph (g)(2)(v) of this section. The average value is defined as the sum of the rolling average values recorded over the previous 12 months, divided by the number of rolling averages recorded during that time. The average value must not include calibration data, startup data, shutdown data, malfunction data, and data obtained when not burning hazardous waste;

(iii) You must feed chlorine at normal feedrates or greater; and

(iv) If the combustor is equipped with carbon injection or carbon bed, normal cleaning cycle of the particulate matter control device.

(v) The Administrator may approve an alternative range to that required by paragraphs (g)(2)(i) and (ii) of this section if you document in the confirmatory performance test plan that it may be problematic to maintain the required range during the test. In addition, when making the finding of compliance, the Administrator may consider test conditions outside of the range specified in the test plan based on a finding that you could not reasonably maintain the range specified in the test plan and considering factors including whether the time duration and level of the parameter when operations were out of the specified range were such that operations during the confirmatory test are determined to be reasonably representative of normal operations. In addition, the Administrator will consider the proximity of the emission test results to the standard.

(h) *Operating conditions during subsequent testing.* (1) Current operating parameter limits established under § 63.1209 are waived during subsequent comprehensive performance testing.

(2) Current operating parameter limits are also waived during pretesting prior to comprehensive performance testing for an aggregate time not to exceed 720 hours of operation (renewable at the discretion of the Administrator) under an approved test plan or if the source records the results of the pretesting. Pretesting means:

(i) Operations when stack emissions testing for dioxin/furan, mercury, semivolatile metals, low volatile metals, particulate matter, or hydrogen chloride/chlorine gas is being performed; and

(ii) Operations to reach steady-state operating conditions prior to stack emissions testing under paragraph (g)(1)(iii) of this section.

(i) *Time extension for subsequent performance tests.* After the initial comprehensive performance test, you may request up to a one-year time extension for conducting a comprehensive or confirmatory performance test to consolidate performance testing with other state or federally required emission testing, or for other reasons deemed acceptable by the Administrator. If the Administrator grants a time extension for a comprehensive performance test, the deadlines for commencing the next comprehensive and confirmatory tests are based on the date that the subject comprehensive performance test commences.

(1) You must submit in writing to the Administrator any request under this paragraph for a time extension for conducting a performance test.

(2) You must include in the request for an extension for conducting a performance test the following:

(i) A description of the reasons for requesting the time extension;

(ii) The date by which you will commence performance testing.

(3) The Administrator will notify you in writing of approval or intention to deny approval of your request for an extension for conducting a performance test within 30 calendar days after receipt of sufficient information to evaluate your request. The 30-day approval or denial period will begin after you have been notified in writing that your application is complete. The Administrator will notify you in writing whether the application contains sufficient information to make a determination within 30 calendar days after receipt of the original application and within 30 calendar days after receipt of any supplementary information that you submit.

(4) When notifying you that your application is not complete, the Administrator will specify the information needed to complete the application. The Administrator will also provide notice of opportunity for you to present, in writing, within 30 calendar days after notification of the incomplete application, additional information or arguments to the Administrator to enable further action on the application.

(5) Before denying any request for an extension for performance testing, the Administrator will notify you in writing of the Administrator's intention to issue the denial, together with:

(i) Notice of the information and findings on which the intended denial is based; and

(ii) Notice of opportunity for you to present in writing, within 15 calendar days after notification of the intended denial, additional information or arguments to the Administrator before further action on the request.

(6) The Administrator's final determination to deny any request for an extension will be in writing and will set forth specific grounds upon which the denial is based. The final determination will be made within 30 calendar days after the presentation of additional information or argument (if the application is complete), or within 30 calendar days after the final date specified for the presentation if no presentation is made.

(j) *Notification of compliance* —(1) *Comprehensive performance test.* (i) Except as provided by paragraphs (j)(4) and (j)(5) of this section, within 90 days of completion of a comprehensive performance test, you must postmark a Notification of Compliance documenting compliance with the emission standards and continuous monitoring system requirements, and identifying operating parameter limits under § 63.1209.

(ii) Upon postmark of the Notification of Compliance, you must comply with all operating requirements specified in the Notification of Compliance in lieu of the limits specified in the Documentation of Compliance required under § 63.1211(c).

(2) *Confirmatory performance test.* Except as provided by paragraph (j)(4) of this section, within 90 days of completion of a confirmatory performance test, you must postmark a Notification of Compliance documenting compliance or noncompliance with the applicable dioxin/furan emission standard.

(3) See §§ 63.7(g), 63.9(h), and 63.1210(d) for additional requirements pertaining to the Notification of Compliance (e.g., you must include results of performance tests in the Notification of Compliance).

(4) *Time extension.* You may submit a written request to the Administrator for a time extension documenting that, for reasons beyond your control, you may not be able to meet the 90-day deadline for submitting the Notification of Compliance after completion of testing. The Administrator will determine whether a time extension is warranted.

(5) *Early compliance.* If you conduct the initial comprehensive performance test prior to the compliance date, you must postmark the Notification of Compliance within 90 days of completion of the performance test or by the compliance date, whichever is later.

(k) *Failure to submit a timely notification of compliance.* (1) If you fail to postmark a Notification of Compliance by the specified date, you must cease hazardous waste burning immediately.

(2) Prior to submitting a revised Notification of Compliance as provided by paragraph (k)(3) of this section, you may burn hazardous waste only for the purpose of pretesting or comprehensive performance testing and only for a maximum of 720 hours (renewable at the discretion of the Administrator).

(3) You must submit to the Administrator a Notification of Compliance subsequent to a new comprehensive performance test before resuming hazardous waste burning.

(l) *Failure of performance test* —(1) *Comprehensive performance test.* The provisions of this paragraph do not apply to the initial comprehensive performance test if you conduct the test prior to your compliance date.

(i) If you determine (based on CEM recordings, results of analyses of stack samples, or results of CMS performance evaluations) that you have exceeded any emission standard during a comprehensive performance test for a mode of operation, you must cease hazardous waste burning immediately under that mode of operation. You must make this determination within 90 days following completion of the performance test.

(ii) If you have failed to demonstrate compliance with the emission standards for any mode of operation:

(A) Prior to submitting a revised Notification of Compliance as provided by paragraph (l)(1)(ii)(C) of this section, you may burn hazardous waste only for the purpose of pretesting or comprehensive performance testing under revised operating conditions, and only for a maximum of 720 hours (renewable at the discretion of the Administrator), except as provided by paragraph (l)(3) of this section;

(B) You must conduct a comprehensive performance test under revised operating conditions following the requirements for performance testing of this section; and

(C) You must submit to the Administrator a Notification of Compliance subsequent to the new comprehensive performance test.

(2) *Confirmatory performance test.* If you determine (based on CEM recordings, results of analyses of stack samples, or results of CMS performance evaluations) that you have failed the dioxin/furan emission standard during a confirmatory performance test, you must cease burning hazardous waste immediately. You must make this determination within 90 days following completion of the performance test. To burn hazardous waste in the future:

(i) You must submit to the Administrator for review and approval a test plan to conduct a comprehensive performance test to identify revised limits on the applicable dioxin/furan operating parameters specified in § 63.1209(k);

(ii) You must submit to the Administrator a Notification of Compliance with the dioxin/furan emission standard under the provisions of paragraphs (j) and (k) of this section and this paragraph (l). You must include in the Notification of Compliance the revised limits on the applicable dioxin/furan operating parameters specified in § 63.1209(k); and

(iii) Until the Notification of Compliance is submitted, you must not burn hazardous waste except for purposes of pretesting or confirmatory performance testing, and for a maximum of 720 hours (renewable at the discretion of the Administrator), except as provided by paragraph (l)(3) of this section.

(3) You may petition the Administrator to obtain written approval to burn hazardous waste in the interim prior to submitting a Notification of Compliance for purposes other than testing or pretesting. You must specify operating requirements, including limits on operating parameters, that you determine will ensure compliance with the emission standards of this subpart based on available information including data from the failed performance test. The Administrator will review, modify as necessary, and approve if warranted the interim operating requirements. An approval of interim operating requirements will include a schedule for submitting a Notification of Compliance.

(m) *Waiver of performance test*. You are not required to conduct performance tests to document compliance with the mercury, semivolatile metals, low volatile metals, or hydrogen chloride/chlorine gas emission standards under the conditions specified in paragraphs (m)(1) or (m)(2) of this section. The waiver provisions of this paragraph apply in addition to the provisions of § 63.7(h).

(1) *Emission standards based on exhaust gas flow rate*. (i) You are deemed to be in compliance with an emission standard based on the volumetric flow rate of exhaust gas (i.e., µg/dscm or ppmv) if the maximum theoretical emission concentration (MTEC) does not exceed the emission standard over the relevant averaging period specified under § 63.1209(l), (n), and (o) of this section for the standard:

(A) Determine the feedrate of mercury, semivolatile metals, low volatile metals, or total chlorine and chloride from all feedstreams;

(B) Determine the stack gas flowrate; and

(C) Calculate a MTEC for each standard assuming all mercury, semivolatile metals, low volatile metals, or total chlorine (organic and inorganic) from all feedstreams is emitted;

(ii) To document compliance with this provision, you must:

(A) Monitor and record the feedrate of mercury, semivolatile metals, low volatile metals, and total chlorine and chloride from all feedstreams according to § 63.1209(c);

(B) Monitor with a CMS and record in the operating record the gas flowrate (either directly or by monitoring a surrogate parameter that you have correlated to gas flowrate);

(C) Continuously calculate and record in the operating record the MTEC under the procedures of paragraph (m)(1)(i) of this section; and

(D) Interlock the MTEC calculated in paragraph (m)(1)(i)(C) of this section to the AWFCO system to stop hazardous waste burning when the MTEC exceeds the emission standard.

(iii) In lieu of the requirement in paragraphs (m)(1)(ii)(C) and (D) of this section, you may:

(A) Identify in the Notification of Compliance a minimum gas flowrate limit and a maximum feedrate limit of mercury, semivolatile metals, low volatile metals, and/or total chlorine and chloride from all feedstreams that ensures the MTEC as calculated in paragraph (m)(1)(i)(C) of this section is below the applicable emission standard; and

(B) Interlock the minimum gas flowrate limit and maximum feedrate limit of paragraph (m)(1)(iii)(A) of this section to the AWFCO system to stop hazardous waste burning when the gas flowrate or mercury, semivolatile metals, low volatile metals, and/or total chlorine and chloride feedrate exceeds the limits of paragraph (m)(1)(iii)(A) of this section.

(2) *Emission standards based on hazardous waste thermal concentration* . (i) You are deemed to be in compliance with an emission standard specified on a hazardous waste thermal concentration basis (i.e., pounds emitted per million Btu of heat input) if the HAP thermal concentration in the waste feed does not exceed the allowable HAP thermal concentration emission rate.

(ii) To document compliance with this provision, you must:

(A) Monitor and record the feedrate of mercury, semivolatile metals, low volatile metals, and total chlorine and chloride from all hazardous waste feedstreams in accordance with § 63.1209(c);

(B) Determine and record the higher heating value of each hazardous waste feed;

(C) Continuously calculate and record the thermal feed rate of all hazardous waste feedstreams by summing the products of each hazardous waste feed rate multiplied by the higher heating value of that hazardous waste;

(D) Continuously calculate and record the total HAP thermal feed concentration for each constituent by dividing the HAP feedrate determined in paragraph (m)(2)(ii)(A) of this section by the thermal feed rate determined in paragraph (m)(2)(ii)(C) of this section for all hazardous waste feedstreams;

(E) Interlock the HAP thermal feed concentration for each constituent with the AWFCO to stop hazardous waste feed when the thermal feed concentration exceeds the applicable thermal emission standard.

(3) When you determine the feedrate of mercury, semivolatile metals, low volatile metals, or total chlorine and chloride for purposes of this provision, except as provided by paragraph (m)(4) of this section, you must assume that the analyte is present at the full detection limit when the feedstream analysis determines that the analyte is not detected in the feedstream.

(4) Owners and operators of hazardous waste burning cement kilns and lightweight aggregate kilns may assume that mercury is present in raw material at half the detection limit when the raw material feedstream analysis determines that mercury is not detected.

(5) You must state in the site-specific test plan that you submit for review and approval under paragraph (e) of this section that you intend to comply with the provisions of this paragraph. You must include in the test plan documentation that any surrogate that is proposed for gas flowrate adequately correlates with the gas flowrate.

[64 FR 53038, Sept. 30, 1999, as amended at 65 FR 42299, July 10, 2000; 65 FR 67271, Nov. 9, 2000; 66 FR 35106, July 3, 2001; 66 FR 63318, Dec. 6, 2001; 67 FR 6814, Feb. 13, 2002; 67 FR 6990, Feb. 14, 2002; 67 FR 77691, Dec. 19, 2002; 70 FR 59546, Oct. 12, 2005; 73 FR 18980, Apr. 8, 2008; 73 FR 64096, Oct. 28, 2008]

§ 63.1208 What are the test methods?

(a) [Reserved]

(b) *Test methods*. You must use the following test methods to determine compliance with the emissions standards of this subpart:

(1) *Dioxins and furans*. (i) To determine compliance with the emission standard for dioxins and furans, you must use:

(A) Method 0023A, Sampling Method for Polychlorinated Dibenzo- *p* -Dioxins and Polychlorinated Dibenzofurans emissions from Stationary Sources, EPA Publication SW-846 (incorporated by reference—see § 63.14); or

(B) Method 23, provided in appendix A, part 60 of this chapter, after approval by the Administrator.

(1) You may request approval to use Method 23 in the performance test plan required under § 63.1207(e)(i) and (ii).

(2) In determining whether to grant approval to use Method 23, the Administrator may consider factors including whether dioxin/furan were detected at levels substantially below the emission standard in previous testing, and whether previous Method 0023 analyses detected low levels of dioxin/furan in the front half of the sampling train.

(3) Sources that emit carbonaceous particulate matter, such as coal-fired boilers, and sources equipped with activated carbon injection, will be deemed not suitable for use of Method 23 unless you document that there would not be a significant improvement in quality assurance with Method 0023A.

(ii) You must sample for a minimum of three hours, and you must collect a minimum sample volume of 2.5 dscm;

(iii) You may assume that nondetects are present at zero concentration.

(2) *Mercury*. You must use Method 29, provided in appendix A, part 60 of this chapter, to demonstrate compliance with emission standard for mercury.

(3) *Cadmium and lead*. You must use Method 29, provided in appendix A, part 60 of this chapter, to determine compliance with the emission standard for cadmium and lead (combined).

(4) *Arsenic, beryllium, and chromium*. You must use Method 29, provided in appendix A, part 60 of this chapter, to determine compliance with the emission standard for arsenic, beryllium, and chromium (combined).

(5) *Hydrogen chloride and chlorine gas* —(i) *Compliance with MACT standards* . To determine compliance with the emission standard for hydrogen chloride and chlorine gas (combined), you must use:

(A) Method 26/26A as provided in appendix A, part 60 of this chapter; or

(B) Methods 320 or 321 as provided in appendix A, part 63 of this chapter, or

(C) ASTM D 6735-01, Standard Test Method for Measurement of Gaseous Chlorides and Fluorides from Mineral Calcining Exhaust Sources—Impinger Method to measure emissions of hydrogen chloride, and Method 26/26A to measure emissions of chlorine gas, provided that you follow the provisions in paragraphs (b)(5)(C)(1) through (6) of this section. ASTM D 6735-01 is available for purchase from at least one of the following addresses: American Society for Testing and Materials (ASTM), 100 Barr Harbor Drive, Post Office Box C700, West Conshohocken, PA 19428-2959; or ProQuest, 300 North Zeeb Road, Ann Arbor, MI 48106.

(1) A test must include three or more runs in which a pair of samples is obtained simultaneously for each run according to section 11.2.6 of ASTM Method D6735-01.

(2) You must calculate the test run standard deviation of each set of paired samples to quantify data precision, according to Equation 1 of this section:

$$RSD_x = (100) \text{ Absolute Value } \left[\frac{C1_x - C2_x}{C1_x + C2_x} \right] \quad (\text{Eq. 1})$$

Where:

RSD_a = The test run relative standard deviation of sample pair a, percent.

$C1_a$ and $C2_a$ = The HCl concentrations, milligram/dry standard cubic meter (mg/dscm), from the paired samples.

(3) You must calculate the test average relative standard deviation according to Equation 2 of this section:

$$RSD_{TA} = \frac{\sum_{a=1}^p RSD_a}{p} \quad (\text{Eq. 2})$$

Where:

RSD_{TA} = The test average relative standard deviation, percent.

RSD_a = The test run relative standard deviation for sample pair a.

p = The number of test runs, ≥ 3 .

(4) If RSD_{TA} is greater than 20 percent, the data are invalid and the test must be repeated.

(5) The post-test analyte spike procedure of section 11.2.7 of ASTM Method D6735-01 is conducted, and the percent recovery is calculated according to section 12.6 of ASTM Method D6735-01.

(6) If the percent recovery is between 70 percent and 130 percent, inclusive, the test is valid. If the percent recovery is outside of this range, the data are considered invalid, and the test must be repeated.

(ii) *Compliance with risk-based limits under § 63.1215.* To demonstrate compliance with emission limits established under § 63.1215, you must use Method 26/26A as provided in appendix A, part 60 of this chapter, Method 320 as provided in appendix A, part 63 of this chapter, Method 321 as provided in appendix A, part 63 of this chapter, or ASTM D 6735-01, Standard Test Method for Measurement of Gaseous Chlorides and Fluorides from Mineral Calcining Exhaust Sources—Impinger Method (following the provisions of paragraphs (b)(5)(C)(1) through (6) of this section), except:

(A) For cement kilns and sources equipped with a dry acid gas scrubber, you must use Methods 320 or 321 as provided in appendix A, part 63 of this chapter, or ASTM D 6735-01 to measure hydrogen chloride, and the back-half, caustic impingers of Method 26/26A as provided in appendix A, part 60 of this chapter to measure chlorine gas; and

(B) For incinerators, boilers, and lightweight aggregate kilns, you must use Methods 320 or 321 as provided in appendix A, part 63 of this chapter, or ASTM D 6735-01 to measure hydrogen chloride, and Method 26/26A as provided in appendix A, part 60 of this chapter to measure total chlorine, and calculate chlorine gas by difference if:

(1) The bromine/chlorine ratio in feedstreams is greater than 5 percent; or

(2) The sulfur/chlorine ratio in feedstreams is greater than 50 percent.

(6) *Particulate matter.* You must use Methods 5 or 5I, provided in appendix A, part 60 of this chapter, to demonstrate compliance with the emission standard for particulate matter.

(7) *Other test methods.* You may use applicable test methods in EPA Publication SW-846, as incorporated by reference in paragraph (a) of this section, as necessary to demonstrate compliance with requirements of this subpart, except as otherwise specified in paragraphs (b)(2)-(b)(6) of this section.

(8) *Feedstream analytical methods.* You may use any reliable analytical method to determine feedstream concentrations of metals, chlorine, and other constituents. It is your responsibility to ensure that the sampling and analysis procedures are unbiased, precise, and that the results are representative of the feedstream.

(9) *Opacity.* If you determine compliance with the opacity standard under the monitoring requirements of §§ 63.1209(a)(1)(iv) and (a)(1)(v), you must use Method 9, provided in appendix A, part 60 of this chapter.

[64 FR 53038, Sept. 30, 1999, as amended at 69 FR 18803, Apr. 9, 2004; 70 FR 34555, June 14, 2005; 70 FR 59547, Oct. 12, 2005]

§ 63.1209 What are the monitoring requirements?

(a) *Continuous emissions monitoring systems (CEMS) and continuous opacity monitoring systems (COMS).* (1)(i) You must use either a carbon monoxide or hydrocarbon CEMS to demonstrate and monitor compliance with the carbon monoxide and hydrocarbon standard under this subpart. You must also use an oxygen CEMS to continuously correct the carbon monoxide or hydrocarbon level to 7 percent oxygen.

(ii) (A) *Cement kilns under § 63.1204.* Except as provided by paragraphs (a)(1)(iv) and (a)(1)(v) of the section, you must use a COMS to demonstrate and monitor compliance with the opacity standard under §§ 63.1204(a)(7) and (b)(7) at each point where emissions are vented from these affected sources including the bypass stack of a preheater or preheater/precalciner kiln with dual stacks.

(B) *Cement kilns under § 63.1220.* Except as provided by paragraphs (a)(1)(iv) and (a)(1)(v) of the section and unless your source is equipped with a bag leak detection system under § 63.1206(c)(8) or a particulate matter detection system under § 63.1206(c)(9), you must use a COMS to demonstrate and monitor compliance with the opacity standard under §§ 63.1220(a)(7) and (b)(7) at each point where emissions are vented from these affected sources including the bypass stack of a preheater or preheater/precalciner kiln with dual stacks.

(C) You must maintain and operate each COMS in accordance with the requirements of § 63.8(c) except for the requirements under § 63.8(c)(3). The requirements of § 63.1211(c) shall be complied with instead of § 63.8(c)(3); and

(D) Compliance is based on a six-minute block average.

(iii) You must install, calibrate, maintain, and operate a particulate matter CEMS to demonstrate and monitor compliance with the particulate matter standards under this subpart. However, compliance with the requirements in this section to install, calibrate, maintain and operate the PM CEMS is not required until such time that the Agency promulgates all performance specifications and operational requirements applicable to PM CEMS.

(iv) If you operate a cement kiln subject to the provisions of this subpart and use a fabric filter with multiple stacks or an electrostatic precipitator with multiple stacks, you may, in lieu of installing the COMS required by paragraph (a)(1)(ii) of this section, comply with the opacity standard in accordance with the procedures of Method 9 to part 60 of this chapter:

(A) You must conduct the Method 9 test while the affected source is operating at the highest load or capacity level reasonably expected to occur within the day;

(B) The duration of the Method 9 test shall be at least 30 minutes each day;

(C) You must use the Method 9 procedures to monitor and record the average opacity for each six-minute block period during the test; and

(D) To remain in compliance, all six-minute block averages must not exceed the opacity standard.

(v) If you operate a cement kiln subject to the provisions of this subpart and use a particulate matter control device that exhausts through a monovent, or if the use of a COMS in accordance with the installation specification of Performance Specification 1 (PS-1) of appendix B to part 60 of this chapter is not feasible, you may, in lieu of installing the COMS required by paragraph (a)(1)(ii) of this section, comply with the opacity standard in accordance with the procedures of Method 9 to part 60 of this chapter:

(A) You must conduct the Method 9 test while the affected source is operating at the highest load or capacity level reasonably expected to occur within the day;

(B) The duration of the Method 9 test shall be at least 30 minutes each day;

(C) You must use the Method 9 procedures to monitor and record the average opacity for each six-minute block period during the test; and

(D) To remain in compliance, all six-minute block averages must not exceed the opacity standard.

(2) *Performance specifications.* You must install, calibrate, maintain, and continuously operate the CEMS and COMS in compliance with the quality assurance procedures provided in the appendix to this subpart and Performance Specifications 1 (opacity), 4B (carbon monoxide and oxygen), and 8A (hydrocarbons) in appendix B, part 60 of this chapter.

(3) *Carbon monoxide readings exceeding the span.* (i) Except as provided by paragraph (a)(3)(ii) of this section, if a carbon monoxide CEMS detects a response that results in a one-minute average at or above the 3,000 ppmv span level required by Performance Specification 4B in appendix B, part 60 of this chapter, the one-minute average must be recorded as 10,000 ppmv. The one-minute 10,000 ppmv value must be used for calculating the hourly rolling average carbon monoxide level.

(ii) Carbon monoxide CEMS that use a span value of 10,000 ppmv when one-minute carbon monoxide levels are equal to or exceed 3,000 ppmv are not subject to paragraph (a)(3)(i) of this section. Carbon monoxide CEMS that use a span value of 10,000 are subject to the same CEMS performance and equipment specifications when operating in the range of 3,000 ppmv to 10,000 ppmv that are provided by Performance Specification 4B for other carbon monoxide CEMS, except:

(A) Calibration drift must be less than 300 ppmv; and

(B) Calibration error must be less than 500 ppmv.

(4) *Hydrocarbon readings exceeding the span.* (i) Except as provided by paragraph (a)(4)(ii) of this section, if a hydrocarbon CEMS detects a response that results in a one-minute average at or above the 100 ppmv span level required by Performance Specification 8A in appendix B, part 60 of this chapter, the one-minute average must be recorded as 500 ppmv. The one-minute 500 ppmv value must be used for calculating the hourly rolling average HC level.

(ii) Hydrocarbon CEMS that use a span value of 500 ppmv when one-minute hydrocarbon levels are equal to or exceed 100 ppmv are not subject to paragraph (a)(4)(i) of this section. Hydrocarbon CEMS that use a span value of 500 ppmv are subject to the same CEMS performance and equipment specifications when operating in the range of 100 ppmv to 500 ppmv that are provided by Performance Specification 8A for other hydrocarbon CEMS, except:

(A) The zero and high-level calibration gas must have a hydrocarbon level of between 0 and 100 ppmv, and between 250 and 450 ppmv, respectively;

(B) The strip chart recorder, computer, or digital recorder must be capable of recording all readings within the CEM measurement range and must have a resolution of 2.5 ppmv;

(C) The CEMS calibration must not differ by more than ± 15 ppmv after each 24-hour period of the seven day test at both zero and high levels;

(D) The calibration error must be no greater than 25 ppmv; and

(E) The zero level, mid-level, and high level calibration gas used to determine calibration error must have a hydrocarbon level of 0-200 ppmv, 150-200 ppmv, and 350-400 ppmv, respectively.

(5) *Petitions to use CEMS for other standards.* You may petition the Administrator to use CEMS for compliance monitoring for particulate matter, mercury, semivolatile metals, low volatile metals, and hydrogen chloride and chlorine gas under § 63.8(f) in lieu of compliance with the corresponding operating parameter limits under this section.

(6) *Calculation of rolling averages* —(i) *Calculation of rolling averages initially.* The carbon monoxide or hydrocarbon CEMS must begin recording one-minute average values by 12:01 a.m. and hourly rolling average values by 1:01 a.m., when 60 one-minute values will be available for calculating the initial hourly rolling average for those sources that come into compliance on the regulatory compliance date. Sources that elect to come into compliance before the regulatory compliance date must begin recording one-minute and hourly rolling average values within 60 seconds and 60 minutes (when 60 one-minute values will be available for calculating the initial hourly rolling average), respectively, from the time at which compliance begins.

(ii) *Calculation of rolling averages upon intermittent operations.* You must ignore periods of time when one-minute values are not available for calculating the hourly rolling average. When one-minute values become available again, the first one-minute value is added to the previous 59 values to calculate the hourly rolling average.

(iii) *Calculation of rolling averages when the hazardous waste feed is cutoff.* (A) Except as provided by paragraph (a)(6)(iii)(B) of this section, you must continue monitoring carbon monoxide and hydrocarbons when the hazardous waste feed is cutoff if the source is operating. You must not resume feeding hazardous waste if the emission levels exceed the standard.

(B) You are not subject to the CEMS requirements of this subpart during periods of time you meet the requirements of § 63.1206(b)(1)(ii) (compliance with emissions standards for nonhazardous waste burning sources when you are not burning hazardous waste).

(7) *Operating parameter limits for hydrocarbons.* If you elect to comply with the carbon monoxide and hydrocarbon emission standard by continuously monitoring carbon monoxide with a CEMS, you must demonstrate that hydrocarbon emissions during the comprehensive performance test do not exceed the hydrocarbon emissions standard. In addition, the limits you establish on the destruction and removal efficiency (DRE) operating parameters required under paragraph (j) of this section also ensure that you maintain compliance with the hydrocarbon emission standard. If you do not conduct the hydrocarbon demonstration and DRE tests concurrently, you must establish separate operating parameter limits under paragraph (j) of this section based on each test and the more restrictive of the operating parameter limits applies.

(b) *Other continuous monitoring systems (CMS).* (1) You must use CMS (e.g., thermocouples, pressure transducers, flow meters) to document compliance with the applicable operating parameter limits under this section.

(2) Except as specified in paragraphs (b)(2)(i) and (ii) of this section, you must install and operate continuous monitoring systems other than CEMS in conformance with § 63.8(c)(3) that requires you, at a minimum, to comply with the manufacturer's written specifications or recommendations for installation, operation, and calibration of the system:

(i) *Calibration of thermocouples and pyrometers.* The calibration of thermocouples must be verified at a frequency and in a manner consistent with manufacturer specifications, but no less frequent than once per year. You must operate and maintain optical pyrometers in accordance with manufacturer specifications unless otherwise approved by the Administrator. You must calibrate optical pyrometers in accordance with the frequency and procedures recommended by the manufacturer, but no less frequent than once per year, unless otherwise approved by the Administrator. And,

(ii) *Accuracy and calibration of weight measurement devices for activated carbon injection systems.* If you operate a carbon injection system, the accuracy of the weight measurement device must be ± 1 percent of the weight being measured. The calibration of the device must be verified at least once each calendar quarter at a frequency of approximately 120 days.

(3) CMS must sample the regulated parameter without interruption, and evaluate the detector response at least once each 15 seconds, and compute and record the average values at least every 60 seconds.

(4) The span of the non-CEMS CMS detector must not be exceeded. You must interlock the span limits into the automatic waste feed cutoff system required by § 63.1206(c)(3).

(5) *Calculation of rolling averages* —(i) *Calculation of rolling averages initially.* Continuous monitoring systems must begin recording one-minute average values by 12:01 a.m., hourly rolling average values by 1:01 a.m. (e.g., when 60 one-minute values will be available for calculating the initial hourly rolling average), and twelve-hour rolling averages by 12:01 p.m. (e.g., when 720 one-minute averages are available to calculate a 12-hour rolling average), for those sources that come into compliance on the regulatory compliance date. Sources that elect to come into compliance before the regulatory compliance date must begin recording one-minute, hourly rolling average, and 12-hour rolling average values within 60 seconds, 60 minutes (when 60 one-minute values will be available for calculating the initial hourly rolling average), and 720 minutes (when 720 one-minute values will be available for calculating the initial 12-hour hourly rolling average) respectively, from the time at which compliance begins.

(ii) *Calculation of rolling averages upon intermittent operations.* You must ignore periods of time when one-minute values are not available for calculating rolling averages. When one-minute values become available again, the first one-minute value is added to the previous one-minute values to calculate rolling averages.

(iii) *Calculation of rolling averages when the hazardous waste feed is cutoff.* (A) Except as provided by paragraph (b)(5)(iii)(B) of this section, you must continue monitoring operating parameter limits with a CMS when the hazardous waste feed is cutoff if the source is operating. You must not resume feeding hazardous waste if an operating parameter exceeds its limit.

(B) You are not subject to the CMS requirements of this subpart during periods of time you meet the requirements of § 63.1206(b)(1)(ii) (compliance with emissions standards for nonhazardous waste burning sources when you are not burning hazardous waste).

(c) *Analysis of feedstreams* —(1) *General.* Prior to feeding the material, you must obtain an analysis of each feedstream that is sufficient to document compliance with the applicable feedrate limits provided by this section.

(2) *Feedstream analysis plan.* You must develop and implement a feedstream analysis plan and record it in the operating record. The plan must specify at a minimum:

(i) The parameters for which you will analyze each feedstream to ensure compliance with the operating parameter limits of this section;

(ii) Whether you will obtain the analysis by performing sampling and analysis or by other methods, such as using analytical information obtained from others or using other published or documented data or information;

(iii) How you will use the analysis to document compliance with applicable feedrate limits (e.g., if you blend hazardous wastes and obtain analyses of the wastes prior to blending but not of the blended, as-fired, waste, the plan must describe how you will determine the pertinent parameters of the blended waste);

(iv) The test methods which you will use to obtain the analyses;

(v) The sampling method which you will use to obtain a representative sample of each feedstream to be analyzed using sampling methods described in appendix IX, part 266 of this chapter, or an equivalent method; and

(vi) The frequency with which you will review or repeat the initial analysis of the feedstream to ensure that the analysis is accurate and up to date.

(3) *Review and approval of analysis plan.* You must submit the feedstream analysis plan to the Administrator for review and approval, if requested.

(4) *Compliance with feedrate limits.* To comply with the applicable feedrate limits of this section, you must monitor and record feedrates as follows:

(i) Determine and record the value of the parameter for each feedstream by sampling and analysis or other method;

(ii) Determine and record the mass or volume flowrate of each feedstream by a CMS. If you determine flowrate of a feedstream by volume, you must determine and record the density of the feedstream by sampling and analysis (unless you report the constituent concentration in units of weight per unit volume (e.g., mg/l)); and

(iii) Calculate and record the mass feedrate of the parameter per unit time.

(5) *Waiver of monitoring of constituents in certain feedstreams.* You are not required to monitor levels of metals or chlorine in the following feedstreams to document compliance with the feedrate limits under this section provided that you document in the comprehensive performance test plan the expected levels of the constituent in the feedstream and account for those assumed feedrate levels in documenting compliance with feedrate limits: natural gas, process air, and feedstreams from vapor recovery systems.

(d) *Performance evaluations.* (1) The requirements of §§ 63.8(d) (Quality control program) and (e) (Performance evaluation of continuous monitoring systems) apply, except that you must conduct performance evaluations of components of the CMS under the frequency and procedures (for example, submittal of performance evaluation test plan for review and approval) applicable to performance tests as provided by § 63.1207.

(2) You must comply with the quality assurance procedures for CEMS prescribed in the appendix to this subpart.

(e) *Conduct of monitoring.* The provisions of § 63.8(b) apply.

(f) *Operation and maintenance of continuous monitoring systems.* The provisions of § 63.8(c) apply except:

(1) *Section 63.8(c)(3).* The requirements of § 63.1211(c), that requires CMSs to be installed, calibrated, and operational on the compliance date, shall be complied with instead of section 63.8(c)(3);

(2) *Section 63.8(c)(4)(ii).* The performance specifications for carbon monoxide, hydrocarbon, and oxygen CEMSs in subpart B, part 60 of this chapter that requires detectors to measure the sample concentration at least once every 15 seconds for calculating an average emission rate once every 60 seconds shall be complied with instead of section 63.8(c)(4)(ii); and

(3) Sections 63.8(c)(4)(i), (c)(5), and (c)(7)(i)(C) pertaining to COMS apply only to owners and operators of hazardous waste burning cement kilns.

(g) *Alternative monitoring requirements other than continuous emissions monitoring systems (CEMS)* —(1) *Requests to use alternatives to operating parameter monitoring requirements.* (i) You may submit an application to the Administrator under this paragraph for approval of alternative operating parameter monitoring requirements to document compliance with the emission standards of

this subpart. For requests to use additional CEMS, however, you must use paragraph (a)(5) of this section and § 63.8(f). Alternative requests to operating parameter monitoring requirements that include unproven monitoring methods may not be made under this paragraph and must be made under § 63.8(f).

(ii) You may submit an application to waive an operating parameter limit specified in this section based on documentation that neither that operating parameter limit nor an alternative operating parameter limit is needed to ensure compliance with the emission standards of this subpart.

(iii) You must comply with the following procedures for applications submitted under paragraphs (g)(1)(i) and (ii) of this section:

(A) *Timing of the application.* You must submit the application to the Administrator not later than with the comprehensive performance test plan.

(B) *Content of the application.* You must include in the application:

(1) Data or information justifying your request for an alternative monitoring requirement (or for a waiver of an operating parameter limit), such as the technical or economic infeasibility or the impracticality of using the required approach;

(2) A description of the proposed alternative monitoring requirement, including the operating parameter to be monitored, the monitoring approach/technique (e.g., type of detector, monitoring location), the averaging period for the limit, and how the limit is to be calculated; and

(3) Data or information documenting that the alternative monitoring requirement would provide equivalent or better assurance of compliance with the relevant emission standard, or that it is the monitoring requirement that best assures compliance with the standard and that is technically and economically practicable.

(C) *Approval of request to use an alternative monitoring requirement or waive an operating parameter limit.* The Administrator will notify you of approval or intention to deny approval of the request within 90 calendar days after receipt of the original request and within 60 calendar days after receipt of any supplementary information that you submit. The Administrator will not approve an alternative monitoring request unless the alternative monitoring requirement provides equivalent or better assurance of compliance with the relevant emission standard, or is the monitoring requirement that best assures compliance with the standard and that is technically and economically practicable. Before disapproving any request, the Administrator will notify you of the Administrator's intention to disapprove the request together with:

(1) Notice of the information and findings on which the intended disapproval is based; and

(2) Notice of opportunity for you to present additional information to the Administrator before final action on the request. At the time the Administrator notifies you of intention to disapprove the request, the Administrator will specify how much time you will have after being notified of the intended disapproval to submit the additional information.

(D) *Responsibility of owners and operators.* You are responsible for ensuring that you submit any supplementary and additional information supporting your application in a timely manner to enable the Administrator to consider your application during review of the comprehensive performance test plan. Neither your submittal of an application, nor the Administrator's failure to approve or disapprove the application, relieves you of the responsibility to comply with the provisions of this subpart.

(iv) *Dual standards that incorporate the interim standards for HAP metals —(A) Semivolatile and low volatile metals.* You may petition the Administrator to waive a feedrate operating parameter limit under paragraph (n)(2) of this section for either the emission standards expressed in a thermal emissions format or the interim standards based on documentation that the feedrate operating parameter limit is not needed to ensure compliance with the relevant standard on a continuous basis.

(B) *Mercury*. You may petition the Administrator to waive a feedrate operating parameter limit under paragraph (l)(1) of this section for either the feed concentration standard under §§ 63.1220(a)(2)(i) and (b)(2)(i) or the interim standards based on documentation that the feedrate operating parameter limit is not needed to ensure compliance with the relevant standard on a continuous basis.

(2) *Administrator's discretion to specify additional or alternative requirements*. The Administrator may determine on a case-by-case basis at any time (e.g., during review of the comprehensive performance test plan, during compliance certification review) that you may need to limit additional or alternative operating parameters (e.g., opacity in addition to or in lieu of operating parameter limits on the particulate matter control device) or that alternative approaches to establish limits on operating parameters may be necessary to document compliance with the emission standards of this subpart.

(h) *Reduction of monitoring data*. The provisions of § 63.8(g) apply.

(i) *When an operating parameter is applicable to multiple standards*. Paragraphs (j) through (p) of this section require you to establish limits on operating parameters based on comprehensive performance testing to ensure you maintain compliance with the emission standards of this subpart. For several parameters, you must establish a limit for the parameter to ensure compliance with more than one emission standard. An example is a limit on minimum combustion chamber temperature to ensure compliance with both the DRE standard of paragraph (j) of this section and the dioxin/furan standard of paragraph (k) of this section. If the performance tests for such standards are not performed simultaneously, the most stringent limit for a parameter derived from independent performance tests applies.

(j) *DRE*. To remain in compliance with the destruction and removal efficiency (DRE) standard, you must establish operating limits during the comprehensive performance test (or during a previous DRE test under provisions of § 63.1206(b)(7)) for the following parameters, unless the limits are based on manufacturer specifications, and comply with those limits at all times that hazardous waste remains in the combustion chamber (i.e., the hazardous waste residence time has not transpired since the hazardous waste feed cutoff system was activated):

(1) *Minimum combustion chamber temperature*. (i) You must measure the temperature of each combustion chamber at a location that best represents, as practicable, the bulk gas temperature in the combustion zone. You must document the temperature measurement location in the test plan you submit under § 63.1207(e);

(ii) You must establish a minimum hourly rolling average limit as the average of the test run averages;

(2) *Maximum flue gas flowrate or production rate*. (i) As an indicator of gas residence time in the control device, you must establish and comply with a limit on the maximum flue gas flowrate, the maximum production rate, or another parameter that you document in the site-specific test plan as an appropriate surrogate for gas residence time, as the average of the maximum hourly rolling averages for each run.

(ii) You must comply with this limit on a hourly rolling average basis;

(3) *Maximum hazardous waste feedrate*. (i) You must establish limits on the maximum pumpable and total (i.e., pumpable and nonpumpable) hazardous waste feedrate for each location where hazardous waste is fed.

(ii) You must establish the limits as the average of the maximum hourly rolling averages for each run.

(iii) You must comply with the feedrate limit(s) on a hourly rolling average basis;

(4) *Operation of waste firing system*. You must specify operating parameters and limits to ensure that good operation of each hazardous waste firing system is maintained.

(k) *Dioxins and furans*. You must comply with the dioxin and furans emission standard by establishing and complying with the following operating parameter limits. You must base the limits on operations during the comprehensive performance test, unless the limits are based on manufacturer specifications.

(1) *Gas temperature at the inlet to a dry particulate matter control device*. (i) For sources other than a lightweight aggregate kiln, if the combustor is equipped with an electrostatic precipitator, baghouse (fabric filter), or other dry emissions control device where particulate matter is suspended in contact with combustion gas, you must establish a limit on the maximum temperature of the gas at the inlet to the device on an hourly rolling average. You must establish the hourly rolling average limit as the average of the test run averages.

(ii) For hazardous waste burning lightweight aggregate kilns, you must establish a limit on the maximum temperature of the gas at the exit of the (last) combustion chamber (or exit of any waste heat recovery system) on an hourly rolling average. The limit must be established as the average of the test run averages;

(2) *Minimum combustion chamber temperature*. (i) For sources other than cement kilns, you must measure the temperature of each combustion chamber at a location that best represents, as practicable, the bulk gas temperature in the combustion zone. You must document the temperature measurement location in the test plan you submit under §§ 63.1207(e) and (f);

(ii) You must establish a minimum hourly rolling average limit as the average of the test run averages.

(3) *Maximum flue gas flowrate or production rate*. (i) As an indicator of gas residence time in the control device, you must establish and comply with a limit on the maximum flue gas flowrate, the maximum production rate, or another parameter that you document in the site-specific test plan as an appropriate surrogate for gas residence time, as the average of the maximum hourly rolling averages for each run.

(ii) You must comply with this limit on a hourly rolling average basis;

(4) *Maximum hazardous waste feedrate*. (i) You must establish limits on the maximum pumpable and total (pumpable and nonpumpable) hazardous waste feedrate for each location where waste is fed.

(ii) You must establish the limits as the average of the maximum hourly rolling averages for each run.

(iii) You must comply with the feedrate limit(s) on a hourly rolling average basis;

(5) *Particulate matter operating limit*. If your combustor is equipped with an activated carbon injection system, you must establish operating parameter limits on the particulate matter control device as specified by paragraph (m)(1) of this section;

(6) *Activated carbon injection parameter limits*. If your combustor is equipped with an activated carbon injection system:

(i) *Carbon feedrate*. You must establish a limit on minimum carbon injection rate on an hourly rolling average calculated as the average of the test run averages. If your carbon injection system injects carbon at more than one location, you must establish a carbon feedrate limit for each location.

(ii) *Carrier fluid*. You must establish a limit on minimum carrier fluid (gas or liquid) flowrate or pressure drop as an hourly rolling average based on the manufacturer's specifications. You must document the specifications in the test plan you submit under §§ 63.1207(e) and (f);

(iii) *Carbon specification*. (A) You must specify and use the brand (i.e., manufacturer) and type of carbon used during the comprehensive performance test until a subsequent comprehensive

performance test is conducted, unless you document in the site-specific performance test plan required under §§ 63.1207(e) and (f) key parameters that affect adsorption and establish limits on those parameters based on the carbon used in the performance test.

(B) You may substitute at any time a different brand or type of carbon provided that the replacement has equivalent or improved properties compared to the carbon used in the performance test and conforms to the key sorbent parameters you identify under paragraph (k)(6)(iii)(A) of this section. You must include in the operating record documentation that the substitute carbon will provide the same level of control as the original carbon.

(7) *Carbon bed parameter limits.* If your combustor is equipped with a carbon bed system:

(i) *Monitoring bed life.* You must:

(A) Monitor performance of the carbon bed consistent with manufacturer's specifications and recommendations to ensure the carbon bed (or bed segment for sources with multiple segments) has not reached the end of its useful life to minimize dioxin/furan and mercury emissions at least to the levels required by the emission standards;

(B) Document the monitoring procedures in the operation and maintenance plan;

(C) Record results of the performance monitoring in the operating record; and

(D) Replace the bed or bed segment before it has reached the end of its useful life to minimize dioxin/furan and mercury emissions at least to the levels required by the emission standards.

(ii) *Carbon specification.* (A) You must specify and use the brand (i.e., manufacturer) and type of carbon used during the comprehensive performance test until a subsequent comprehensive performance test is conducted, unless you document in the site-specific performance test plan required under §§ 63.1207(e) and (f) key parameters that affect adsorption and establish limits on those parameters based on the carbon used in the performance test.

(B) You may substitute at any time a different brand or type of carbon provided that the replacement has equivalent or improved properties compared to the carbon used in the performance test. You must include in the operating record documentation that the substitute carbon will provide an equivalent or improved level of control as the original carbon.

(iii) *Maximum temperature.* You must measure the temperature of the carbon bed at either the bed inlet or exit and you must establish a maximum temperature limit on an hourly rolling average as the average of the test run averages.

(8) *Catalytic oxidizer parameter limits.* If your combustor is equipped with a catalytic oxidizer, you must establish limits on the following parameters:

(i) *Minimum flue gas temperature at the entrance of the catalyst.* You must establish a limit on minimum flue gas temperature at the entrance of the catalyst on an hourly rolling average as the average of the test run averages.

(ii) *Maximum time in-use.* You must replace a catalytic oxidizer with a new catalytic oxidizer when it has reached the maximum service time specified by the manufacturer.

(iii) *Catalyst replacement specifications.* When you replace a catalyst with a new one, the new catalyst must be equivalent to or better than the one used during the previous comprehensive test, as measured by:

(A) Catalytic metal loading for each metal;

(B) Space time, expressed in the units s^{-1} , the maximum rated volumetric flow of combustion gas through the catalyst divided by the volume of the catalyst; and

(C) Substrate construction, including materials of construction, washcoat type, and pore density.

(iv) *Maximum flue gas temperature.* You must establish a maximum flue gas temperature limit at the entrance of the catalyst as an hourly rolling average, based on manufacturer's specifications.

(9) *Inhibitor feedrate parameter limits.* If you feed a dioxin/furan inhibitor into the combustion system, you must establish limits for the following parameters:

(i) *Minimum inhibitor feedrate.* You must establish a limit on minimum inhibitor feedrate on an hourly rolling average as the average of the test run averages.

(ii) *Inhibitor specifications.* (A) You must specify and use the brand (i.e., manufacturer) and type of inhibitor used during the comprehensive performance test until a subsequent comprehensive performance test is conducted, unless you document in the site-specific performance test plan required under §§ 63.1207(e) and (f) key parameters that affect the effectiveness of the inhibitor and establish limits on those parameters based on the inhibitor used in the performance test.

(B) You may substitute at any time a different brand or type of inhibitor provided that the replacement has equivalent or improved properties compared to the inhibitor used in the performance test and conforms to the key parameters you identify under paragraph (k)(9)(ii)(A) of this section. You must include in the operating record documentation that the substitute inhibitor will provide the same level of control as the original inhibitor.

(l) *Mercury.* You must comply with the mercury emission standard by establishing and complying with the following operating parameter limits. You must base the limits on operations during the comprehensive performance test, unless the limits are based on manufacturer specifications.

(1) *Feedrate of mercury.* (i) For incinerators and solid fuel boilers, when complying with the mercury emission standards under §§ 63.1203, 63.1216 and 63.1219, you must establish a 12-hour rolling average limit for the total feedrate of mercury in all feedstreams as the average of the test run averages.

(ii) For liquid fuel boilers, when complying with the mercury emission standards of § 63.1217, you must establish a rolling average limit for the mercury feedrate as follows on an averaging period not to exceed an annual rolling average:

(A) You must calculate a mercury system removal efficiency for each test run and calculate the average system removal efficiency of the test run averages. If emissions exceed the mercury emission standard during the comprehensive performance test, it is not a violation because the averaging period for the mercury emission standard is (not-to-exceed) one year and compliance is based on compliance with the mercury feedrate limit with an averaging period not-to-exceed one year.

(B) If you burn hazardous waste with a heating value of 10,000 Btu/lb or greater, you must calculate the mercury feedrate limit as follows:

(1) The mercury feedrate limit is the emission standard divided by [1 – system removal efficiency].

(2) The mercury feedrate limit is a hazardous waste thermal concentration limit expressed as pounds of mercury in hazardous waste feedstreams per million Btu of hazardous waste fired.

(3) You must comply with the hazardous waste mercury thermal concentration limit by determining the feedrate of mercury in all hazardous waste feedstreams (lb/hr) at least once a minute and the hazardous waste thermal feedrate (MM Btu/hr) at least once a minute to calculate a 60-minute average thermal emission concentration as [hazardous waste mercury feedrate (lb/hr) / hazardous waste thermal feedrate (MM Btu/hr)].

(4) You must calculate a rolling average hazardous waste mercury thermal concentration that is updated each hour.

(5) If you select an averaging period for the feedrate limit that is greater than a 12-hour rolling average, you must calculate the initial rolling average as though you had selected a 12-hour rolling average, as provided by paragraph (b)(5)(i) of this section. Thereafter, you must calculate rolling averages using either one-minute or one-hour updates. Hourly updates shall be calculated using the average of the one-minute average data for the preceding hour. For the period beginning with initial operation under this standard until the source has operated for the full averaging period that you select, the average feedrate shall be based only on actual operation under this standard.

(C) If you burn hazardous waste with a heating value of less than 10,000 Btu/lb, you must calculate the mercury feedrate limit as follows:

(1) You must calculate the mercury feedrate limit as the mercury emission standard divided by [1 - System Removal Efficiency].

(2) The feedrate limit is expressed as a mass concentration per unit volume of stack gas ($\mu\text{g}/\text{dscm}$) and is converted to a mass feedrate (lb/hr) by multiplying it by the average stack gas flowrate of the test run averages.

(3) You must comply with the feedrate limit by determining the mercury feedrate (lb/hr) at least once a minute to calculate a 60-minute average feedrate.

(4) You must update the rolling average feedrate each hour with this 60-minute feedrate measurement.

(5) If you select an averaging period for the feedrate limit that is greater than a 12-hour rolling average, you must calculate the initial rolling average as though you had selected a 12-hour rolling average, as provided by paragraph (b)(5)(i) of this section. Thereafter, you must calculate rolling averages using either one-minute or one-hour updates. Hourly updates shall be calculated using the average of the one-minute average data for the preceding hour. For the period beginning with initial operation under this standard until the source has operated for the full averaging period that you select, the average feedrate shall be based only on actual operation under this standard.

(D) If your boiler is equipped with a wet scrubber, you must comply with the following unless you document in the performance test plan that you do not feed chlorine at rates that may substantially affect the system removal efficiency of mercury for purposes of establishing a mercury feedrate limit based on the system removal efficiency during the test:

(1) Scrubber blowdown must be minimized during a pretest conditioning period and during the performance test:

(2) Scrubber water must be preconditioned so that mercury in the water is at equilibrium with stack gas at the mercury feedrate level of the performance test; and

(3) You must establish an operating limit on minimum pH of scrubber water as the average of the test run averages and comply with the limit on an hourly rolling average.

(iii) For cement kilns:

(A) When complying with the emission standards under §§ 63.1220(a)(2)(i) and (b)(2)(i), you must:

(1) Comply with the mercury hazardous waste feed concentration operating requirement on a twelve-hour rolling average;

(2) Monitor and record in the operating record the as-fired mercury concentration in the hazardous waste (or the weighted-average mercury concentration for multiple hazardous waste feedstreams);

(3) Initiate an automatic waste feed cutoff that immediately and automatically cuts off the hazardous waste feed when the as-fired mercury concentration operating requirement is exceeded;

(B) When complying with the emission standards under §§ 63.1204 and 63.1220(a)(2)(ii)(A) and (b)(2)(ii)(A), you must establish a 12-hour rolling average limit for the feedrate of mercury in all feedstreams as the average of the test run averages;

(C) Except as provided by paragraph (l)(1)(iii)(D) of this section, when complying with the hazardous waste maximum theoretical emission concentration (MTEC) under § 63.1220(a)(2)(ii)(B) and (b)(2)(ii)(B), you must:

(1) Comply with the MTEC operating requirement on a twelve-hour rolling average;

(2) Monitor and record the feedrate of mercury for each hazardous waste feedstream according to § 63.1209(c);

(3) Monitor with a CMS and record in the operating record the gas flowrate (either directly or by monitoring a surrogate parameter that you have correlated to gas flowrate);

(4) Continuously calculate and record in the operating record a MTEC assuming mercury from all hazardous waste feedstreams is emitted;

(5) Initiate an automatic waste feed cutoff that immediately and automatically cuts off the hazardous waste feed when the MTEC operating requirement is exceeded;

(D) In lieu of complying with paragraph (l)(1)(iii)(C) of this section, you may:

(1) Identify in the Notification of Compliance a minimum gas flowrate limit and a maximum feedrate limit of mercury from all hazardous waste feedstreams that ensures the MTEC calculated in paragraph (l)(1)(iii)(C)(4) of this section is below the operating requirement under paragraphs §§ 63.1220(a)(2)(ii)(B) and (b)(2)(ii)(B); and

(2) Initiate an automatic waste feed cutoff that immediately and automatically cuts off the hazardous waste feed when either the gas flowrate or mercury feedrate exceeds the limits identified in paragraph (l)(1)(iii)(D)(1) of this section.

(iv) For lightweight aggregate kilns:

(A) When complying with the emission standards under §§ 63.1205, 63.1221(a)(2)(i) and (b)(2)(i), you must establish a 12-hour rolling average limit for the total feedrate of mercury in all feedstreams as the average of the test run averages;

(B) Except as provided by paragraph (l)(1)(iv)(C) of this section, when complying with the hazardous waste feedrate corresponding to a maximum theoretical emission concentration (MTEC) under §§ 63.1221(a)(2)(ii) and (b)(2)(ii), you must:

(1) Comply with the MTEC operating requirement on a twelve-hour rolling average;

(2) Monitor and record the feedrate of mercury for each hazardous waste feedstream according to § 63.1209(c);

(3) Monitor with a CMS and record in the operating record the gas flowrate (either directly or by monitoring a surrogate parameter that you have correlated to gas flowrate);

(4) Continuously calculate and record in the operating record a MTEC assuming mercury from all hazardous waste feedstreams is emitted;

(5) Initiate an automatic waste feed cutoff that immediately and automatically cuts off the hazardous waste feed when the MTEC operating requirement is exceeded;

(C) In lieu of complying with paragraph (l)(1)(iv)(B) of this section, you may:

(1) Identify in the Notification of Compliance a minimum gas flowrate limit and a maximum feedrate limit of mercury from all hazardous waste feedstreams that ensures the MTEC calculated in paragraph (l)(1)(iv)(B)(4) of this section is below the operating requirement under paragraphs §§ 63.1221(a)(2)(ii) and (b)(2)(ii); and

(2) Initiate an automatic waste feed cutoff that immediately and automatically cuts off the hazardous waste feed when either the gas flowrate or mercury feedrate exceeds the limits identified in paragraph (l)(1)(iv)(C)(1) of this section.

(v) *Extrapolation of feedrate levels.* In lieu of establishing mercury feedrate limits as specified in paragraphs (l)(1)(i) through (iv) of this section, you may request as part of the performance test plan under §§ 63.7(b) and (c) and §§ 63.1207 (e) and (f) to use the mercury feedrates and associated emission rates during the comprehensive performance test to extrapolate to higher allowable feedrate limits and emission rates. The extrapolation methodology will be reviewed and approved, as warranted, by the Administrator. The review will consider in particular whether:

(A) Performance test metal feedrates are appropriate (i.e., whether feedrates are at least at normal levels; depending on the heterogeneity of the waste, whether some level of spiking would be appropriate; and whether the physical form and species of spiked material is appropriate); and

(B) Whether the extrapolated feedrates you request are warranted considering historical metal feedrate data.

(2) *Wet scrubber.* If your combustor is equipped with a wet scrubber, you must establish operating parameter limits prescribed by paragraph (o)(3) of this section, except for paragraph (o)(3)(iv).

(3) *Activated carbon injection.* If your combustor is equipped with an activated carbon injection system, you must establish operating parameter limits prescribed by paragraphs (k)(5) and (k)(6) of this section.

(4) *Activated carbon bed.* If your combustor is equipped with an activated carbon bed system, you must comply with the requirements of (k)(7) of this section to assure compliance with the mercury emission standard.

(m) *Particulate matter.* You must comply with the particulate matter emission standard by establishing and complying with the following operating parameter limits. You must base the limits on operations during the comprehensive performance test, unless the limits are based on manufacturer specifications.

(1) *Control device operating parameter limits (OPLs)* —(i) *Wet scrubbers.* For sources equipped with wet scrubbers, including ionizing wet scrubbers, high energy wet scrubbers such as venturi, hydrosonic, collision, or free jet wet scrubbers, and low energy wet scrubbers such as spray towers, packed beds, or tray towers, you must establish limits on the following parameters:

(A) For high energy scrubbers only, minimum pressure drop across the wet scrubber on an hourly rolling average, established as the average of the test run averages;

(B) For all wet scrubbers:

(1) To ensure that the solids content of the scrubber liquid does not exceed levels during the performance test, you must either:

(i) Establish a limit on solids content of the scrubber liquid using a CMS or by manual sampling and analysis. If you elect to monitor solids content manually, you must sample and analyze the scrubber liquid hourly unless you support an alternative monitoring frequency in the performance test plan that you submit for review and approval; or

(ii) Establish a minimum blowdown rate using a CMS and either a minimum scrubber tank volume or liquid level using a CMS.

(2) For maximum solids content monitored with a CMS, you must establish a limit on a twelve-hour rolling average as the average of the test run averages.

(3) For maximum solids content measured manually, you must establish an hourly limit, as measured at least once per hour, unless you support an alternative monitoring frequency in the performance test plan that you submit for review and approval. You must establish the maximum hourly limit as the average of the manual measurement averages for each run.

(4) For minimum blowdown rate and either a minimum scrubber tank volume or liquid level using a CMS, you must establish a limit on an hourly rolling average as the average of the test run averages.

(C) For high energy wet scrubbers only, you must establish limits on either the minimum liquid to gas ratio or the minimum scrubber water flowrate and maximum flue gas flowrate on an hourly rolling average. If you establish limits on maximum flue gas flowrate under this paragraph, you need not establish a limit on maximum flue gas flowrate under paragraph (m)(2) of this section. You must establish these hourly rolling average limits as the average of the test run averages; and

(ii)-(iii) [Reserved]

(iv) *Other particulate matter control devices.* For each particulate matter control device that is not a fabric filter or high energy wet scrubber, or is not an electrostatic precipitator or ionizing wet scrubber for which you elect to monitor particulate matter loadings under § 63.1206(c)(9) of this chapter for process control, you must ensure that the control device is properly operated and maintained as required by § 63.1206(c)(7) and by monitoring the operation of the control device as follows:

(A) During each comprehensive performance test conducted to demonstrate compliance with the particulate matter emissions standard, you must establish a range of operating values for the control device that is a representative and reliable indicator that the control device is operating within the same range of conditions as during the performance test. You must establish this range of operating values as follows:

(1) You must select a set of operating parameters appropriate for the control device design that you determine to be a representative and reliable indicator of the control device performance.

(2) You must measure and record values for each of the selected operating parameters during each test run of the performance test. A value for each selected parameter must be recorded using a continuous monitor.

(3) For each selected operating parameter measured in accordance with the requirements of paragraph (m)(1)(iv)(A)(1) of this section, you must establish a minimum operating parameter limit or a maximum operating parameter limit, as appropriate for the parameter, to define the operating limits within which the control device can operate and still continuously achieve the same operating conditions as during the performance test.

(4) You must prepare written documentation to support the operating parameter limits established for the control device and you must include this documentation in the performance test plan that you submit for review and approval. This documentation must include a description for each selected parameter and the operating range and monitoring frequency required to ensure the control device is being properly operated and maintained.

(B) You must install, calibrate, operate, and maintain a monitoring device equipped with a recorder to measure the values for each operating parameter selected in accordance with the requirements of paragraph (m)(1)(iv)(A)(1) of this section. You must install, calibrate, and maintain the monitoring equipment in accordance with the equipment manufacturer's specifications. The recorder must record the detector responses at least every 60 seconds, as required in the definition of continuous monitor.

(C) You must regularly inspect the data recorded by the operating parameter monitoring system at a sufficient frequency to ensure the control device is operating properly. An excursion is determined to

have occurred any time that the actual value of a selected operating parameter is less than the minimum operating limit (or, if applicable, greater than the maximum operating limit) established for the parameter in accordance with the requirements of paragraph (m)(1)(iv)(A)(3) of this section.

(D) Operating parameters selected in accordance with paragraph (m)(1)(iv) of this section may be based on manufacturer specifications provided you support the use of manufacturer specifications in the performance test plan that you submit for review and approval.

(2) *Maximum flue gas flowrate or production rate.* (i) As an indicator of gas residence time in the control device, you must establish a limit on the maximum flue gas flowrate, the maximum production rate, or another parameter that you document in the site-specific test plan as an appropriate surrogate for gas residence time, as the average of the maximum hourly rolling averages for each run.

(ii) You must comply with this limit on a hourly rolling average basis;

(3) *Maximum ash feedrate.* Owners and operators of hazardous waste incinerators, solid fuel boilers, and liquid fuel boilers must establish a maximum ash feedrate limit as a 12-hour rolling average based on the average of the test run averages. This requirement is waived, however, if you comply with the particulate matter detection system requirements under § 63.1206(c)(9).

(n) *Semivolatile metals and low volatility metals.* You must comply with the semivolatile metal (cadmium and lead) and low volatile metal (arsenic, beryllium, and chromium) emission standards by establishing and complying with the following operating parameter limits. You must base the limits on operations during the comprehensive performance test, unless the limits are based on manufacturer specifications.

(1) *Maximum inlet temperature to dry particulate matter air pollution control device.* You must establish a limit on the maximum inlet temperature to the primary dry metals emissions control device (e.g., electrostatic precipitator, baghouse) on an hourly rolling average basis as the average of the test run averages.

(2) *Maximum feedrate of semivolatile and low volatile metals* —(i) *General.* You must establish feedrate limits for semivolatile metals (cadmium and lead) and low volatile metals (arsenic, beryllium, and chromium) as follows, except as provided by paragraph (n)(2)(vii) of this section.

(ii) For incinerators, cement kilns, and lightweight aggregate kilns, when complying with the emission standards under §§ 63.1203, 63.1204, 63.1205, and 63.1219, and for solid fuel boilers when complying with the emission standards under § 63.1216, you must establish 12-hour rolling average limits for the total feedrate of semivolatile and low volatile metals in all feedstreams as the average of the test run averages.

(iii) *Cement kilns under § 63.1220.* (A) When complying with the emission standards under § 63.1220(a)(3)(i), (a)(4)(i), (b)(3)(i), and (b)(4)(i), you must establish 12-hour rolling average feedrate limits for semivolatile and low volatile metals as the thermal concentration of semivolatile metals or low volatile metals in all hazardous waste feedstreams. You must calculate hazardous waste thermal concentrations for semivolatile metals and low volatile metals for each run as the total mass feedrate of semivolatile metals or low volatile metals for all hazardous waste feedstreams divided by the total heat input rate for all hazardous waste feedstreams. The 12-hour rolling average feedrate limits for semivolatile metals and low volatile metals are the average of the test run averages, calculated on a thermal concentration basis, for all hazardous waste feeds.

(B) When complying with the emission standards under §§ 63.1220(a)(3)(ii), (a)(4)(ii), (b)(3)(ii), and (b)(4)(ii), you must establish 12-hour rolling average limits for the total feedrate of semivolatile and low volatile metals in all feedstreams as the average of the test run averages.

(iv) *Lightweight aggregate kilns under § 63.1221.* (A) When complying with the emission standards under §§ 63.1221(a)(3)(i), (a)(4)(i), (b)(3)(i), and (b)(4)(i), you must establish 12-hour rolling average feedrate limits for semivolatile and low volatile metals as the thermal concentration of

semivolatile metals or low volatile metals in all hazardous waste feedstreams as specified in paragraphs (n)(2)(iii)(A) of this section.

(B) When complying with the emission standards under §§ 63.1221(a)(3)(ii), (a)(4)(ii), (b)(3)(ii), and (b)(4)(ii), you must establish 12-hour rolling average limits for the total feedrate of semivolatile and low volatile metals in all feedstreams as the average of the test run averages.

(v) *Liquid fuel boilers under § 63.1217 —(A) Semivolatile metals.* You must establish a rolling average limit for the semivolatile metal feedrate as follows on an averaging period not to exceed an annual rolling average.

(1) *System removal efficiency.* You must calculate a semivolatile metal system removal efficiency for each test run and calculate the average system removal efficiency of the test run averages. If emissions exceed the semivolatile metal emission standard during the comprehensive performance test, it is not a violation because the averaging period for the semivolatile metal emission standard is one year and compliance is based on compliance with the semivolatile metal feedrate limit that has an averaging period not to exceed an annual rolling average.

(2) *Boilers that feed hazardous waste with a heating value of 10,000 Btu/lb or greater.* You must calculate the semivolatile metal feedrate limit as the semivolatile metal emission standard divided by [1 – System Removal Efficiency].

(i) The feedrate limit is a hazardous waste thermal concentration limit expressed as pounds of semivolatile metals in all hazardous waste feedstreams per million Btu of hazardous waste fed to the boiler.

(ii) You must comply with the hazardous waste semivolatile metal thermal concentration limit by determining the feedrate of semivolatile metal in all hazardous waste feedstreams (lb/hr) and the hazardous waste thermal feedrate (MM Btu/hr) at least once a minute to calculate a 60-minute average thermal emission concentration as [hazardous waste semivolatile metal feedrate (lb/hr) / hazardous waste thermal feedrate (MM Btu/hr)].

(iii) You must calculate a rolling average hazardous waste semivolatile metal thermal concentration that is updated each hour.

(iv) If you select an averaging period for the feedrate limit that is greater than a 12-hour rolling average, you must calculate the initial rolling average as though you had selected a 12-hour rolling average, as provided by paragraph (b)(5)(i) of this section. Thereafter, you must calculate rolling averages using either one-minute or one-hour updates. Hourly updates shall be calculated using the average of the one-minute average data for the preceding hour. For the period beginning with initial operation under this standard until the source has operated for the full averaging period that you select, the average feedrate shall be based only on actual operation under this standard.

(3) *Boilers that feed hazardous waste with a heating value less than 10,000 Btu/lb.* (i) You must calculate the semivolatile metal feedrate limit as the semivolatile metal emission standard divided by [1 – System Removal Efficiency].

(ii) The feedrate limit is expressed as a mass concentration per unit volume of stack gas ($\mu\text{gm/dscm}$) and is converted to a mass feedrate (lb/hr) by multiplying it by the average stack gas flowrate (dscm/hr) of the test run averages.

(iii) You must comply with the feedrate limit by determining the semivolatile metal feedrate (lb/hr) at least once a minute to calculate a 60-minute average feedrate.

(iv) You must update the rolling average feedrate each hour with this 60-minute feedrate measurement.

(v) If you select an averaging period for the feedrate limit that is greater than a 12-hour rolling average, you must calculate the initial rolling average as though you had selected a 12-hour rolling

average, as provided by paragraph (b)(5)(i) of this section. Thereafter, you must calculate rolling averages using either one-minute or one-hour updates. Hourly updates shall be calculated using the average of the one-minute average data for the preceding hour. For the period beginning with initial operation under this standard until the source has operated for the full averaging period that you select, the average feedrate shall be based only on actual operation under this standard.

(B) *Chromium* — (1) *Boilers that feed hazardous waste with a heating value of 10,000 Btu/lb or greater.* (i) The 12-hour rolling average feedrate limit is a hazardous waste thermal concentration limit expressed as pounds of chromium in all hazardous waste feedstreams per million Btu of hazardous waste fed to the boiler. You must establish the 12-hour rolling average feedrate limit as the average of the test run averages.

(ii) You must comply with the hazardous waste chromium thermal concentration limit by determining the feedrate of chromium in all hazardous waste feedstreams (lb/hr) and the hazardous waste thermal feedrate (MMBtu/hr) at least once each minute as [hazardous waste chromium feedrate (lb/hr)/hazardous waste thermal feedrate (MMBtu/hr)].

(2) *Boilers that feed hazardous waste with a heating value less than 10,000 Btu/lb.* You must establish a 12-hour rolling average limit for the total feedrate (lb/hr) of chromium in all feedstreams as the average of the test run averages.

(vi) *LVM limits for pumpable wastes.* You must establish separate feedrate limits for low volatile metals in pumpable feedstreams using the procedures prescribed above for total low volatile metals. Dual feedrate limits for both pumpable and total feedstreams are not required, however, if you base the total feedrate limit solely on the feedrate of pumpable feedstreams.

(vii) *Extrapolation of feedrate levels.* In lieu of establishing feedrate limits as specified in paragraphs (n)(2)(ii) through (vi) of this section, you may request as part of the performance test plan under §§ 63.7(b) and (c) and §§ 63.1207(e) and (f) to use the semivolatile metal and low volatile metal feedrates and associated emission rates during the comprehensive performance test to extrapolate to higher allowable feedrate limits and emission rates. The extrapolation methodology will be reviewed and approved, as warranted, by the Administrator. The review will consider in particular whether:

(A) Performance test metal feedrates are appropriate (i.e., whether feedrates are at least at normal levels; depending on the heterogeneity of the waste, whether some level of spiking would be appropriate; and whether the physical form and species of spiked material is appropriate); and

(B) Whether the extrapolated feedrates you request are warranted considering historical metal feedrate data.

(3) *Control device operating parameter limits (OPLs).* You must establish operating parameter limits on the particulate matter control device as specified by paragraph (m)(1) of this section;

(4) *Maximum total chlorine and chloride feedrate.* You must establish a 12-hour rolling average limit for the feedrate of total chlorine and chloride in all feedstreams as the average of the test run averages.

(5) *Maximum flue gas flowrate or production rate.* (i) As an indicator of gas residence time in the control device, you must establish a limit on the maximum flue gas flowrate, the maximum production rate, or another parameter that you document in the site-specific test plan as an appropriate surrogate for gas residence time, as the average of the maximum hourly rolling averages for each run.

(ii) You must comply with this limit on a hourly rolling average basis.

(o) *Hydrogen chloride and chlorine gas.* You must comply with the hydrogen chloride and chlorine gas emission standard by establishing and complying with the following operating parameter limits. You must base the limits on operations during the comprehensive performance test, unless the limits are based on manufacturer specifications.

(1) *Feedrate of total chlorine and chloride* —(i) *Incinerators, cement kilns, lightweight aggregate kilns, solid fuel boilers, and hydrochloric acid production furnaces.* You must establish a 12-hour rolling average limit for the total feedrate of chlorine (organic and inorganic) in all feedstreams as the average of the test run averages.

(ii) *Liquid fuel boilers* —(A) *Boilers that feed hazardous waste with a heating value not less than 10,000 Btu/lb.* (1) The feedrate limit is a hazardous waste thermal concentration limit expressed as pounds of chlorine (organic and inorganic) in all hazardous waste feedstreams per million Btu of hazardous waste fed to the boiler.

(2) You must establish a 12-hour rolling average feedrate limit as the average of the test run averages.

(3) You must comply with the feedrate limit by determining the mass feedrate of hazardous waste feedstreams (lb/hr) at least once a minute and by knowing the chlorine content (organic and inorganic, lb of chlorine/lb of hazardous waste) and heating value (Btu/lb) of hazardous waste feedstreams at all times to calculate a 1-minute average feedrate measurement as [hazardous waste chlorine content (lb of chlorine/lb of hazardous waste feed)/hazardous waste heating value (Btu/lb of hazardous waste)]. You must update the rolling average feedrate each hour with this 60-minute average feedrate measurement.

(B) *Boilers that feed hazardous waste with a heating value less than 10,000 Btu/lb.* You must establish a 12-hour rolling average limit for the total feedrate of chlorine (organic and inorganic) in all feedstreams as the average of the test run averages. You must update the rolling average feedrate each hour with a 60-minute average feedrate measurement.

(2) *Maximum flue gas flowrate or production rate.* (i) As an indicator of gas residence time in the control device, you must establish a limit on the maximum flue gas flowrate, the maximum production rate, or another parameter that you document in the site-specific test plan as an appropriate surrogate for gas residence time, as the average of the maximum hourly rolling averages for each run.

(ii) You must comply with this limit on a hourly rolling average basis;

(3) *Wet scrubber.* If your combustor is equipped with a wet scrubber:

(i) If your source is equipped with a high energy wet scrubber such as a venturi, hydrosonic, collision, or free jet wet scrubber, you must establish a limit on minimum pressure drop across the wet scrubber on an hourly rolling average as the average of the test run averages;

(ii) If your source is equipped with a low energy wet scrubber such as a spray tower, packed bed, or tray tower, you must establish a minimum pressure drop across the wet scrubber based on manufacturer's specifications. You must comply with the limit on an hourly rolling average;

(iii) If your source is equipped with a low energy wet scrubber, you must establish a limit on minimum liquid feed pressure to the wet scrubber based on manufacturer's specifications. You must comply with the limit on an hourly rolling average;

(iv) You must establish a limit on minimum pH on an hourly rolling average as the average of the test run averages;

(v) You must establish limits on either the minimum liquid to gas ratio or the minimum scrubber water flowrate and maximum flue gas flowrate on an hourly rolling average as the average of the test run averages. If you establish limits on maximum flue gas flowrate under this paragraph, you need not establish a limit on maximum flue gas flowrate under paragraph (o)(2) of this section; and

(4) *Dry scrubber.* If your combustor is equipped with a dry scrubber, you must establish the following operating parameter limits:

(i) *Minimum sorbent feedrate.* You must establish a limit on minimum sorbent feedrate on an hourly rolling average as the average of the test run averages.

(ii) *Minimum carrier fluid flowrate or nozzle pressure drop.* You must establish a limit on minimum carrier fluid (gas or liquid) flowrate or nozzle pressure drop based on manufacturer's specifications.

(iii) *Sorbent specifications.* (A) You must specify and use the brand (i.e., manufacturer) and type of sorbent used during the comprehensive performance test until a subsequent comprehensive performance test is conducted, unless you document in the site-specific performance test plan required under §§ 63.1207(e) and (f) key parameters that affect adsorption and establish limits on those parameters based on the sorbent used in the performance test.

(B) You may substitute at any time a different brand or type of sorbent provided that the replacement has equivalent or improved properties compared to the sorbent used in the performance test and conforms to the key sorbent parameters you identify under paragraph (o)(4)(iii)(A) of this section. You must record in the operating record documentation that the substitute sorbent will provide the same level of control as the original sorbent.

(p) *Maximum combustion chamber pressure.* If you comply with the requirements for combustion system leaks under § 63.1206(c)(5) by maintaining the maximum combustion chamber zone pressure lower than ambient pressure to prevent combustion systems leaks from hazardous waste combustion, you must perform instantaneous monitoring of pressure and the automatic waste feed cutoff system must be engaged when negative pressure is not adequately maintained.

(q) *Operating under different modes of operation.* If you operate under different modes of operation, you must establish operating parameter limits for each mode. You must document in the operating record when you change a mode of operation and begin complying with the operating limits for an alternative mode of operation.

(1) *Operating under otherwise applicable standards after the hazardous waste residence time has transpired.* As provided by § 63.1206(b)(1)(ii), you may operate under otherwise applicable requirements promulgated under sections 112 and 129 of the Clean Air Act in lieu of the substantive requirements of this subpart.

(i) The otherwise applicable requirements promulgated under sections 112 and 129 of the Clean Air Act are applicable requirements under this subpart.

(ii) You must specify (e.g., by reference) the otherwise applicable requirements as a mode of operation in your Documentation of Compliance under § 63.1211(c), your Notification of Compliance under § 63.1207(j), and your title V permit application. These requirements include the otherwise applicable requirements governing emission standards, monitoring and compliance, and notification, reporting, and recordkeeping.

(2) *Calculating rolling averages under different modes of operation.* When you transition to a different mode of operation, you must calculate rolling averages as follows:

(i) *Retrieval approach.* Calculate rolling averages anew using the continuous monitoring system values previously recorded for that mode of operation (i.e., you ignore continuous monitoring system values subsequently recorded under other modes of operation when you transition back to a mode of operation); or

(ii) *Start anew.* Calculate rolling averages anew without considering previous recordings.

(A) Rolling averages must be calculated as the average of the available one-minute values for the parameter until enough one-minute values are available to calculate hourly or 12-hour rolling averages, whichever is applicable to the parameter.

(B) You may not transition to a new mode of operation using this approach if the most recent operation in that mode resulted in an exceedance of an applicable emission standard measured with a CEMS or operating parameter limit prior to the hazardous waste residence time expiring; or

(iii) *Seamless transition.* Continue calculating rolling averages using data from the previous operating mode provided that both the operating limit and the averaging period for the parameter are the same for both modes of operation.

(r) *Averaging periods.* The averaging periods specified in this section for operating parameters are not-to-exceed averaging periods. You may elect to use shorter averaging periods. For example, you may elect to use a 1-hour rolling average rather than the 12-hour rolling average specified in paragraph (l)(1)(i) of this section for mercury.

[64 FR 53038, Sept. 30, 1999, as amended at 65 FR 42300, July 10, 2000; 65 FR 67271, Nov. 9, 2000; 66 FR 24272, May 14, 2001; 66 FR 35106, July 3, 2001; 67 FR 6815, Feb. 13, 2002; 67 FR 6991, Feb. 14, 2002; 67 FR 77691, Dec. 19, 2002; 70 FR 59548, Oct. 12, 2005; 73 FR 18981, Apr. 8, 2008]

Notification, Reporting and Recordkeeping

§ 63.1210 What are the notification requirements?

(a) *Summary of requirements.* (1) You must submit the following notifications to the Administrator:

Reference	Notification
63.9(b)	Initial notifications that you are subject to Subpart EEE of this Part.
63.9(d)	Notification that you are subject to special compliance requirements.
63.9(j)	Notification and documentation of any change in information already provided under § 63.9.
63.1206(b)(5)(i)	Notification of changes in design, operation, or maintenance.
63.1206(c)(8)(iv)	Notification of excessive bag leak detection system exceedances.
63.1206(c)(9)(v)	Notification of excessive particulate matter detection system exceedances.
63.1207(e), 63.9(e) 63.9(g)(1) and (3)	Notification of performance test and continuous monitoring system evaluation, including the performance test plan and CMS performance evaluation plan. ¹
63.1210(b)	Notification of intent to comply.
63.1210(d), 63.1207(j), 63.1207(k), 63.1207(l), 63.9(h), 63.10(d)(2), 63.10(e)(2)	Notification of compliance, including results of performance tests and continuous monitoring system performance evaluations.

¹ You may also be required on a case-by-case basis to submit a feedstream analysis plan under § 63.1209(c)(3).

(2) You must submit the following notifications to the Administrator if you request or elect to comply with alternative requirements:

Reference	Notification, request, petition, or application
63.9(i)	You may request an adjustment to time periods or postmark deadlines for submittal and review of required information.
63.10(e)(3)(ii)	You may request to reduce the frequency of excess emissions and CMS performance reports.
63.10(f)	You may request to waive recordkeeping or reporting requirements.

63.1204(d)(2)(iii), 63.1220(d)(2)(iii)	Notification that you elect to comply with the emission averaging requirements for cement kilns with in-line raw mills.
63.1204(e)(2)(iii), 63.1220(e)(2)(iii)	Notification that you elect to comply with the emission averaging requirements for preheater or preheater/precalciner kilns with dual stacks.
63.1206(b)(4), 63.1213, 63.6(i), 63.9(c)	You may request an extension of the compliance date for up to one year.
63.1206(b)(5)(i)(C)	You may request to burn hazardous waste for more than 720 hours and for purposes other than testing or pretesting after making a change in the design or operation that could affect compliance with emission standards and prior to submitting a revised Notification of Compliance.
63.1206(b)(8)(iii)(B)	If you elect to conduct particulate matter CEMS correlation testing and wish to have federal particulate matter and opacity standards and associated operating limits waived during the testing, you must notify the Administrator by submitting the correlation test plan for review and approval.
63.1206(b)(8)(v)	You may request approval to have the particulate matter and opacity standards and associated operating limits and conditions waived for more than 96 hours for a correlation test.
63.1206(b)(9)	Owners and operators of lightweight aggregate kilns may request approval of alternative emission standards for mercury, semivolatile metal, low volatile metal, and hydrogen chloride/chlorine gas under certain conditions.
63.1206(b)(10)	Owners and operators of cement kilns may request approval of alternative emission standards for mercury, semivolatile metal, low volatile metal, and hydrogen chloride/chlorine gas under certain conditions.
63.1206(b)(14)	Owners and operators of incinerators may elect to comply with an alternative to the particulate matter standard.
63.1206(b)(15)	Owners and operators of cement and lightweight aggregate kilns may request to comply with the alternative to the interim standards for mercury.
63.1206(c)(2)(ii)(C)	You may request to make changes to the startup, shutdown, and malfunction plan.
63.1206(c)(5)(i)(C)	You may request an alternative means of control to provide control of combustion system leaks.
63.1206(c)(5)(i)(D)	You may request other techniques to prevent fugitive emissions without use of instantaneous pressure limits.
63.1207(c)(2)	You may request to base initial compliance on data in lieu of a comprehensive performance test.
63.1207(d)(3)	You may request more than 60 days to complete a performance test if additional time is needed for reasons beyond your control.
63.1207(e)(3), 63.7(h)	You may request a time extension if the Administrator fails to approve or deny your test plan.
63.1207(h)(2)	You may request to waive current operating parameter limits during pretesting for more than 720 hours.
63.1207(f)(1)(ii)(D)	You may request a reduced hazardous waste feedstream analysis for organic hazardous air pollutants if the reduced analysis continues to be representative of organic hazardous air pollutants in your hazardous waste feedstreams.
63.1207(g)(2)(v)	You may request to operate under a wider operating range for a parameter during confirmatory performance testing.
63.1207(i)	You may request up to a one-year time extension for conducting a performance test (other than the initial comprehensive performance test) to consolidate testing with other state or federally-required testing.
63.1207(j)(4)	

	You may request more than 90 days to submit a Notification of Compliance after completing a performance test if additional time is needed for reasons beyond your control.
63.1207(l)(3)	After failure of a performance test, you may request to burn hazardous waste for more than 720 hours and for purposes other than testing or pretesting.
63.1209(a)(5), 63.8(f)	You may request: (1) Approval of alternative monitoring methods for compliance with standards that are monitored with a CEMS; and (2) approval to use a CEMS in lieu of operating parameter limits.
63.1209(g)(1)	You may request approval of: (1) Alternatives to operating parameter monitoring requirements, except for standards that you must monitor with a continuous emission monitoring system (CEMS) and except for requests to use a CEMS in lieu of operating parameter limits; or (2) a waiver of an operating parameter limit.
63.1209(l)(1)	You may request to extrapolate mercury feedrate limits.
63.1209(n)(2)	You may request to extrapolate semivolatile and low volatile metal feedrate limits.
63.1211(d)	You may request to use data compression techniques to record data on a less frequent basis than required by § 63.1209.

(b) *Notification of intent to comply (NIC)*. These procedures apply to sources that have not previously complied with the requirements of paragraphs (b) and (c) of this section, and to sources that previously complied with the NIC requirements of §§ 63.1210 and 63.1212(a), which were in effect prior to October 11, 2000, that must make a technology change requiring a Class 1 permit modification to meet the standards of §§ 63.1219, 63.1220, and 63.1221.

(1) You must prepare a Notification of Intent to Comply that includes all of the following information:

(i) General information:

(A) The name and address of the owner/operator and the source;

(B) Whether the source is a major or an area source;

(C) Waste minimization and emission control technique(s) being considered;

(D) Emission monitoring technique(s) you are considering;

(E) Waste minimization and emission control technique(s) effectiveness;

(F) A description of the evaluation criteria used or to be used to select waste minimization and/or emission control technique(s); and

(G) A general description of how you intend to comply with the emission standards of this subpart.

(ii) As applicable to each source, information on key activities and estimated dates for these activities that will bring the source into compliance with emission control requirements of this subpart. You must include all of the following key activities and dates in your NIC:

(A) The dates by which you anticipate you will develop engineering designs for emission control systems or process changes for emissions;

(B) The date by which you anticipate you will commit internal or external resources for installing emission control systems or making process changes for emission control, or the date by which you will issue orders for the purchase of component parts to accomplish emission control or process changes.

(C) The date by which you anticipate you will submit construction applications;

(D) The date by which you anticipate you will initiate on-site construction, installation of emission control equipment, or process change;

(E) The date by which you anticipate you will complete on-site construction, installation of emission control equipment, or process change; and

(F) The date by which you anticipate you will achieve final compliance. The individual dates and milestones listed in paragraphs (b)(1)(ii)(A) through (F) of this section as part of the NIC are not requirements and therefore are not enforceable deadlines; the requirements of paragraphs (b)(1)(ii)(A) through (F) of this section must be included as part of the NIC only to inform the public of how you intend to comply with the emission standards of this subpart.

(iii) A summary of the public meeting required under paragraph (c) of this section;

(iv) If you intend to cease burning hazardous waste prior to or on the compliance date, the requirements of paragraphs (b)(1)(ii) and (b)(1)(iii) of this section do not apply. You must include in your NIC a schedule of key dates for the steps to be taken to stop hazardous waste activity at your combustion unit. Key dates include the date for submittal of RCRA closure documents required under subpart G, part 264 or subpart G, part 265 of this chapter.

(2) You must make a draft of the NIC available for public review no later than 30 days prior to the public meeting required under paragraph (c)(1) of this section or no later than 9 months after the effective date of the rule if you intend to cease burning hazardous waste prior to or on the compliance date.

(3) You must submit the final NIC to the Administrator:

(i) *Existing units*. No later than one year following the effective date of the emission standards of this subpart; or

(ii) *New units*. No later than 60 days following the informal public meeting.

(c) *NIC public meeting and notice*. (1) Prior to the submission of the NIC to the permitting agency and:

(i) *Existing units*. No later than 10 months after the effective date of the emission standards of this subpart, you must hold at least one informal meeting with the public to discuss the anticipated activities described in the draft NIC for achieving compliance with the emission standards of this subpart. You must post a sign-in sheet or otherwise provide a voluntary opportunity for attendees to provide their names and addresses.

(ii) *New units*. No earlier than thirty (30) days following notice of the informal public meeting, you must hold at least one informal meeting with the public to discuss the anticipated activities described in the draft NIC for achieving compliance with the emission standards of this subpart. You must post a sign-in sheet or otherwise provide a voluntary opportunity for attendees to provide their names and addresses.

(2) You must submit a summary of the meeting, along with the list of attendees and their addresses developed under paragraph (b)(1) of this section, and copies of any written comments or materials submitted at the meeting, to the Administrator as part of the final NIC, in accordance with paragraph (b)(1)(iii) of this section;

(3) You must provide public notice of the NIC meeting at least 30 days prior to the meeting and you must maintain, and provide to the Administrator upon request, documentation of the notice. You must provide public notice in all of the following forms:

(i) *Newspaper advertisement*. You must publish a notice in a newspaper of general circulation in the county or equivalent jurisdiction of your facility. In addition, you must publish the notice in newspapers of general circulation in adjacent counties or equivalent jurisdiction where such

publication would be necessary to inform the affected public. You must publish the notice as a display advertisement.

(ii) *Visible and accessible sign.* You must post a notice on a clearly marked sign at or near the source. If you place the sign on the site of the hazardous waste combustor, the sign must be large enough to be readable from the nearest spot where the public would pass by the site.

(iii) *Broadcast media announcement.* You must broadcast a notice at least once on at least one local radio station or television station.

(iv) *Notice to the facility mailing list.* You must provide a copy of the notice to the facility mailing list in accordance with § 124.10(c)(1)(ix) of this chapter.

(4) You must include all of the following in the notices required under paragraph (c)(3) of this section:

(i) The date, time, and location of the meeting;

(ii) A brief description of the purpose of the meeting;

(iii) A brief description of the source and proposed operations, including the address or a map (e.g., a sketched or copied street map) of the source location;

(iv) A statement encouraging people to contact the source at least 72 hours before the meeting if they need special access to participate in the meeting;

(v) A statement describing how the draft NIC (and final NIC, if requested) can be obtained; and

(vi) The name, address, and telephone number of a contact person for the NIC.

(5) The requirements of this paragraph do not apply to sources that intend to cease burning hazardous waste prior to or on the compliance date.

(d) *Notification of compliance.* (1) The Notification of Compliance status requirements of § 63.9(h) apply, except that:

(i) The notification is a Notification of Compliance, rather than compliance status;

(ii) The notification is required for the initial comprehensive performance test and each subsequent comprehensive and confirmatory performance test; and

(iii) You must postmark the notification before the close of business on the 90th day following completion of relevant compliance demonstration activity specified in this subpart rather than the 60th day as required by § 63.9(h)(2)(ii).

(2) Upon postmark of the Notification of Compliance, the operating parameter limits identified in the Notification of Compliance, as applicable, shall be complied with, the limits identified in the Documentation of Compliance or a previous Notification of Compliance are no longer applicable.

(3) The Notification of Compliance requirements of § 63.1207(j) also apply.

[64 FR 53038, Sept. 30, 1999, as amended at 64 FR 63211, Nov. 19, 1999; 65 FR 42301, July 10, 2000; 66 FR 24272, May 14, 2001; 67 FR 6992, Feb. 14, 2002; 70 FR 59552, Oct. 12, 2005; 73 FR 18982, Apr. 8, 2008; 73 FR 64097, Oct. 28, 2008]

§ 63.1211 What are the recordkeeping and reporting requirements?

(a) *Summary of reporting requirements.* You must submit the following reports to the Administrator:

--	--

Reference	Report
63.10(d)(4)	Compliance progress reports, if required as a condition of an extension of the compliance date granted under § 63.6(i).
63.10(d)(5)(i)	Periodic startup, shutdown, and malfunction reports.
63.10(d)(5)(ii)	Immediate startup, shutdown, and malfunction reports.
63.10(e)(3)	Excessive emissions and continuous monitoring system performance report and summary report.
63.1206(c)(2)(ii) (B)	Startup, shutdown, and malfunction plan.
63.1206(c)(3) (vi)	Excessive exceedances reports.
63.1206(c)(4) (iv)	Emergency safety vent opening reports.

(b) *Summary of recordkeeping requirements.* You must retain the following in the operating record:

Reference	Document, Data, or Information
63.1200, 63.10(b) and (c)	General. Information required to document and maintain compliance with the regulations of Subpart EEE, including data recorded by continuous monitoring systems (CMS), and copies of all notifications, reports, plans, and other documents submitted to the Administrator.
63.1204(d)(1)(ii), 63.1220(d)(1)(ii)	Documentation of mode of operation changes for cement kilns with in-line raw mills.
63.1204(d)(2)(ii), 63.1220(d)(2)(ii)	Documentation of compliance with the emission averaging requirements for cement kilns with in-line raw mills.
63.1204(e)(2)(ii), 63.1220(e)(2)(ii)	Documentation of compliance with the emission averaging requirements for preheater or preheater/precalciner kilns with dual stacks.
63.1206(b)(1)(ii)	If you elect to comply with all applicable requirements and standards promulgated under authority of the Clean Air Act, including Sections 112 and 129, in lieu of the requirements of Subpart EEE when not burning hazardous waste, you must document in the operating record that you are in compliance with those requirements.
63.1206(b)(5)(ii)	Documentation that a change will not adversely affect compliance with the emission standards or operating requirements.
63.1206(b)(11)	Calculation of hazardous waste residence time.
63.1206(c)(2)	Startup, shutdown, and malfunction plan.
63.1206(c)(2)(v)(A)	Documentation of your investigation and evaluation of excessive exceedances during malfunctions.
63.1206(c)(3)(v)	Corrective measures for any automatic waste feed cutoff that results in an exceedance of an emission standard or operating parameter limit.
63.1206(c)(3)(vii)	Documentation and results of the automatic waste feed cutoff operability testing.
63.1206(c)(4)(ii)	Emergency safety vent operating plan.
63.1206(c)(4)(iii)	Corrective measures for any emergency safety vent opening.
63.1206(c)(5)(ii)	Method used for control of combustion system leaks.
63.1206(c)(6)	Operator training and certification program.
63.1206(c)(7)(i)(D)	Operation and maintenance plan.
63.1209(c)(2)	Feedstream analysis plan.
63.1209(k)(6)(iii), 63.1209(k)(7)(ii),	Documentation that a substitute activated carbon, dioxin/furan formation reaction inhibitor, or dry scrubber sorbent will provide the same level of control as the original material.

63.1209(k)(9)(ii), 63.1209(o)(4)(iii)	
63.1209(k)(7)(i)(C)	Results of carbon bed performance monitoring.
63.1209(q)	Documentation of changes in modes of operation.
63.1211(c)	Documentation of compliance.

(c) *Documentation of compliance.* (1) By the compliance date, you must develop and include in the operating record a Documentation of Compliance. You are not subject to this requirement, however, if you submit a Notification of Compliance under § 63.1207(j) prior to the compliance date. Upon inclusion of the Documentation of Compliance in the operating record, hazardous waste burning incinerators, cement kilns, and lightweight aggregate kilns regulated under the interim standards of §§ 63.1203, 63.1204, and 63.1205 are no longer subject to compliance with the previously applicable Notification of Compliance.

(2) The Documentation of Compliance must identify the applicable emission standards under this subpart and the limits on the operating parameters under § 63.1209 that will ensure compliance with those emission standards.

(3) You must include a signed and dated certification in the Documentation of Compliance that:

(i) Required CEMs and CMS are installed, calibrated, and continuously operating in compliance with the requirements of this subpart; and

(ii) Based on an engineering evaluation prepared under your direction or supervision in accordance with a system designed to ensure that qualified personnel properly gathered and evaluated the information and supporting documentation, and considering at a minimum the design, operation, and maintenance characteristics of the combustor and emissions control equipment, the types, quantities, and characteristics of feedstreams, and available emissions data:

(A) You are in compliance with the emission standards of this subpart; and

(B) The limits on the operating parameters under § 63.1209 ensure compliance with the emission standards of this subpart.

(4) You must comply with the emission standards and operating parameter limits specified in the Documentation of Compliance.

(d) *Data compression.* You may submit a written request to the Administrator for approval to use data compression techniques to record data from CMS, including CEMS, on a frequency less than that required by § 63.1209. You must submit the request for review and approval as part of the comprehensive performance test plan.

(1) You must record a data value at least once each ten minutes.

(2) For each CEMS or operating parameter for which you request to use data compression techniques, you must recommend:

(i) A fluctuation limit that defines the maximum permissible deviation of a new data value from a previously generated value without requiring you to revert to recording each one-minute value.

(A) If you exceed a fluctuation limit, you must record each one-minute value for a period of time not less than ten minutes.

(B) If neither the fluctuation limit nor the data compression limit are exceeded during that period of time, you may reinitiate recording data values on a frequency of at least once each ten minutes; and

(ii) A data compression limit defined as the closest level to an operating parameter limit or emission standard at which reduced data recording is allowed.

(A) Within this level and the operating parameter limit or emission standard, you must record each one-minute average.

(B) The data compression limit should reflect a level at which you are unlikely to exceed the specific operating parameter limit or emission standard, considering its averaging period, with the addition of a new one-minute average.

[64 FR 53038, Sept. 30, 1999, as amended at 64 FR 63212, Nov. 19, 1999; 65 FR 42301, July 10, 2000; 66 FR 24272, May 14, 2001; 66 FR 35106, July 3, 2001; 67 FR 6993, Feb. 14, 2002; 70 FR 59554, Oct. 12, 2005]

Other

§ 63.1212 What are the other requirements pertaining to the NIC?

(a) *Certification of intent to comply.* The Notice of Intent to Comply (NIC) must contain the following certification signed and dated by a responsible official as defined under § 63.2 of this chapter: I certify under penalty of law that I have personally examined and am familiar with the information submitted in this document and all attachments and that, based on my inquiry of those individuals immediately responsible for obtaining the information, I believe that the information is true, accurate, and complete. I am aware that there are significant penalties for submitting false information, including the possibility of fine and imprisonment.

(b) *New units.* Any source that files a RCRA permit application or permit modification request for construction of a hazardous waste combustion unit after October 12, 2005 must:

(1) Prepare a draft NIC pursuant to § 63.1210(b) and make it available to the public upon issuance of the notice of public meeting pursuant to § 63.1210(c)(3);

(2) Prepare a draft comprehensive performance test plan pursuant to the requirements of § 63.1207 and make it available for public review upon issuance of the notice of NIC public meeting;

(3) Provide notice to the public of a pre-application meeting pursuant to § 124.31 of this chapter or notice to the public of a permit modification request pursuant to § 270.42 of this chapter;

(4) Hold an informal public meeting [pursuant to § 63.1210(c)(1) and (c)(2)] no earlier than 30 days following notice of the NIC public meeting and notice of the pre-application meeting or notice of the permit modification request to discuss anticipated activities described in the draft NIC and pre-application or permit modification request for achieving compliance with the emission standards of this subpart; and

(5) Submit a final NIC pursuant to § 63.1210(b)(3).

(c) *Information Repository specific to new combustion units.* (1) Any source that files a RCRA permit application or modification request for construction of a new hazardous waste combustion unit after October 12, 2005 may be required to establish an information repository if deemed appropriate.

(2) The Administrator may assess the need, on a case-by-case basis for an information repository. When assessing the need for a repository, the Administrator shall consider the level of public interest, the presence of an existing repository, and any information available via the New Source Review and Title V permit processes. If the Administrator determines a need for a repository, then the Administrator shall notify the facility that it must establish and maintain an information repository.

(3) The information repository shall contain all documents, reports, data, and information deemed necessary by the Administrator. The Administrator shall have the discretion to limit the contents of the repository.

(4) The information repository shall be located and maintained at a site chosen by the source. If the Administrator finds the site unsuitable for the purposes and persons for which it was established,

due to problems with location, hours of availability, access, or other relevant considerations, then the Administrator shall specify a more appropriate site.

(5) The Administrator shall require the source to provide a written notice about the information repository to all individuals on the source mailing list.

(6) The source shall be responsible for maintaining and updating the repository with appropriate information throughout a period specified by the Administrator. The Administrator may close the repository at his or her discretion based on the considerations in paragraph (c)(2) of this section.

[70 FR 59555, Oct. 12, 2005, as amended at 73 FR 18982, Apr. 8, 2008]

§ 63.1213 How can the compliance date be extended to install pollution prevention or waste minimization controls?

(a) *Applicability.* You may request from the Administrator or State with an approved Title V program an extension of the compliance date of up to one year. An extension may be granted if you can reasonably document that the installation of pollution prevention or waste minimization measures will significantly reduce the amount and/or toxicity of hazardous wastes entering the feedstream(s) of the hazardous waste combustor(s), and that you could not install the necessary control measures and comply with the emission standards and operating requirements of this subpart by the compliance date.

(b) *Requirements for requesting an extension.* (1) You must make your requests for an (up to) one-year extension in writing in accordance with § 63.6(i)(4)(B) and (C). The request must contain the following information:

(i) A description of pollution prevention or waste minimization controls that, when installed, will significantly reduce the amount and/or toxicity of hazardous wastes entering the feedstream(s) of the hazardous waste combustor(s). Pollution prevention or waste minimization measures may include: equipment or technology modifications, reformulation or redesign of products, substitution of raw materials, improvements in work practices, maintenance, training, inventory control, or recycling practices conducted as defined in § 261.1(c) of this chapter;

(ii) A description of other pollution controls to be installed that are necessary to comply with the emission standards and operating requirements;

(iii) A reduction goal or estimate of the annual reductions in quantity and/or toxicity of hazardous waste(s) entering combustion feedstream(s) that you will achieve by installing the proposed pollution prevention or waste minimization measures;

(iv) A comparison of reductions in the amounts and/or toxicity of hazardous wastes combusted after installation of pollution prevention or waste minimization measures to the amounts and/or toxicity of hazardous wastes combusted prior to the installation of these measures. If the difference is less than a fifteen percent reduction, include a comparison to pollution prevention and waste minimization reductions recorded during the previous five years;

(v) Reasonable documentation that installation of the pollution prevention or waste minimization changes will not result in a net increase (except for documented increases in production) of hazardous constituents released to the environment through other emissions, wastes or effluents;

(vi) Reasonable documentation that the design and installation of waste minimization and other measures that are necessary for compliance with the emission standards and operating requirements of this subpart cannot otherwise be installed within the three year compliance period, and

(vii) The information required in § 63.6(i)(6)(i)(B) through (D).

(2) You may enclose documentation prepared under an existing State-required pollution prevention program that contains the information prescribed in paragraph (b) of this section with a request for extension in lieu of complying with the time extension requirements of that paragraph.

(c) *Approval of request for extension of compliance date.* Based on the information provided in any request made under paragraph (a) of this section, the Administrator or State with an approved title V program may grant an extension of the compliance date of this subpart. The extension will be in writing in accordance with §§ 63.6(i)(10)(i) through 63.6(i)(10)(v)(A).

[57 FR 61992, Dec. 29, 1992, as amended at 67 FR 6994, Feb. 14, 2002; 67 FR 77691, Dec. 19, 2002]

§ 63.1214 Implementation and enforcement.

(a) This subpart can be implemented and enforced by the U.S. EPA, or a delegated authority such as the applicable State, local, or Tribal agency. If the U.S. EPA Administrator has delegated authority to a State, local, or Tribal agency, then that agency, in addition to the U.S. EPA, has the authority to implement and enforce this subpart. Contact the applicable U.S. EPA Regional Office to find out if this subpart is delegated to a State, local, or Tribal agency.

(b) In delegating implementation and enforcement authority of this subpart to a State, local, or Tribal agency under subpart E of this part, the authorities contained in paragraph (c) of this section are retained by the Administrator of U.S. EPA and cannot be transferred to the State, local, or Tribal agency.

(c) The authorities that cannot be delegated to State, local, or Tribal agencies are as specified in paragraphs (c)(1) through (4) of this section.

(1) Approval of alternatives to requirements in §§ 63.1200, 63.1203, 63.1204, 63.1205, 63.1206 (a), 63.1215, 63.1216, 63.1217, 63.1218, 63.1219, 63.1220, and 63.1221.

(2) Approval of major alternatives to test methods under §§ 63.7(e)(2)(ii) and (f), 63.1208(b), and 63.1209(a)(1), as defined under § 63.90, and as required in this subpart.

(3) Approval of major alternatives to monitoring under §§ 63.8(f) and 63.1209(a)(5), as defined under § 63.90, and as required in this subpart.

(4) Approval of major alternatives to recordkeeping and reporting under §§ 63.10(f) and 63.1211 (a) through (c), as defined under § 63.90, and as required in this subpart.

[68 FR 37356, June 23, 2003, as amended at 70 FR 59555, Oct. 12, 2005]

§ 63.1215 What are the health-based compliance alternatives for total chlorine?

(a) *General* —(1) *Overview.* You may establish and comply with health-based compliance alternatives for total chlorine under the procedures prescribed in this section for your hazardous waste combustors other than hydrochloric acid production furnaces. You may comply with these health-based compliance alternatives in lieu of the emission standards for total chlorine provided under §§ 63.1216, 63.1217, 63.1219, 63.1220, and 63.1221. To identify and comply with the limits, you must:

(i) Identify a total chlorine emission concentration (ppmv) expressed as chloride (Cl⁻) equivalent for each on site hazardous waste combustor. You may select total chlorine emission concentrations as you choose to demonstrate eligibility for the risk-based limits under this section, except as provided by paragraph (b)(7) of this section;

(ii) Apportion the total chlorine emission concentration between HCl and Cl₂ according to paragraph (b)(6)(i) of this section, and calculate HCl and Cl₂ emission rates (lb/hr) using the gas flowrate and other parameters from the most recent regulatory compliance test.

(iii) Calculate the annual average HCl-equivalent emission rate as prescribed in paragraph (b)(2) of this section.

(iv) Perform an eligibility demonstration to determine if your HCl-equivalent emission rate meets the national exposure standard and thus is below the annual average HCl-equivalent emission rate limit, as prescribed by paragraph (c) of this section;

(v) Submit your eligibility demonstration for review and approval, as prescribed by paragraph (e) of this section, which must include information to ensure that the 1-hour average HCl-equivalent emission rate limit is not exceeded, as prescribed by paragraph (d) of this section;

(vi) Demonstrate compliance with the annual average HCl-equivalent emission rate limit during the comprehensive performance test, as prescribed by the testing and monitoring requirements under paragraph (e) of this section;

(vii) Comply with compliance monitoring requirements, including establishing feedrate limits on total chlorine and chloride, and operating parameter limits on emission control equipment, as prescribed by paragraph (f) of this section; and

(viii) Comply with the requirements for changes, as prescribed by paragraph (h) of this section.

(2) *Definitions.* In addition to the definitions under § 63.1201, the following definitions apply to this section:

1-Hour Average HCl-Equivalent Emission Rate means the HCl-equivalent emission rate (lb/hr) determined by equating the toxicity of chlorine to HCl using aRELS as the health risk metric for acute exposure.

1-Hour Average HCl-Equivalent Emission Rate Limit means the HCl-equivalent emission rate (lb/hr) determined by equating the toxicity of chlorine to HCl using aRELS as the health risk metric for acute exposure and which ensures that maximum 1-hour average ambient concentrations of HCl-equivalents do not exceed a Hazard Index of 1.0, rounded to the nearest tenths decimal place (0.1), at an off-site receptor location.

Acute Reference Exposure Level (aREL) means health thresholds below which there would be no adverse health effects for greater than once in a lifetime exposures of one hour. ARELS are developed by the California Office of Health Hazard Assessment and are available at http://www.oehha.ca.gov/air/acute_rels/acutereel.html.

Annual Average HCl-Equivalent Emission Rate means the HCl-equivalent emission rate (lb/hr) determined by equating the toxicity of chlorine to HCl using RfCs as the health risk metric for long-term exposure.

Annual Average HCl-Equivalent Emission Rate Limit means the HCl-equivalent emission rate (lb/hr) determined by equating the toxicity of chlorine to HCl using RfCs as the health risk metric for long-term exposure and which ensures that maximum annual average ambient concentrations of HCl equivalents do not exceed a Hazard Index of 1.0, rounded to the nearest tenths decimal place (0.1), at an off-site receptor location.

Hazard Index (HI) means the sum of more than one Hazard Quotient for multiple substances and/or multiple exposure pathways. In this section, the Hazard Index is the sum of the Hazard Quotients for HCl and chlorine.

Hazard Quotient (HQ) means the ratio of the predicted media concentration of a pollutant to the media concentration at which no adverse effects are expected. For chronic inhalation exposures, the HQ is calculated under this section as the air concentration divided by the RfC. For acute inhalation exposures, the HQ is calculated under this section as the air concentration divided by the aREL.

Look-up table analysis means a risk screening analysis based on comparing the HCl-equivalent emission rate from the affected source to the appropriate HCl-equivalent emission rate limit specified in Tables 1 through 4 of this section.

Reference Concentration (RfC) means an estimate (with uncertainty spanning perhaps an order of magnitude) of a continuous inhalation exposure to the human population (including sensitive subgroups) that is likely to be without an appreciable risk of deleterious effects during a lifetime. It can

be derived from various types of human or animal data, with uncertainty factors generally applied to reflect limitations of the data used.

(b) *HCl-equivalent emission rates* . (1) You must express total chlorine emission rates for each hazardous waste combustor as HCl-equivalent emission rates.

(2) *Annual average rates* . You must calculate annual average toxicity-weighted HCl-equivalent emission rates for each combustor as follows:

$$ER_{LTW} = ER_{HCl} + ER_{Cl_2} \times (Rf_{HCl} / Rf_{Cl_2})$$

Where:

ER_{LTW} is the annual average HCl toxicity-weighted emission rate (HCl-equivalent emission rate) considering long-term exposures, lb/hr

ER_{HCl} is the emission rate of HCl in lbs/hr

ER_{Cl_2} is the emission rate of chlorine in lbs/hr

Rf_{HCl} is the reference concentration of HCl

Rf_{Cl_2} is the reference concentration of chlorine

(3) *1-hour average rates* . You must calculate 1-hour average toxicity-weighted HCl-equivalent emission rates for each combustor as follows:

$$ER_{STW} = ER_{HCl} + ER_{Cl_2} \times (aREL_{HCl} / aREL_{Cl_2})$$

Where:

ER_{STW} is the 1-hour average HCl-toxicity-weighted emission rate (HCl-equivalent emission rate) considering 1-hour (short-term) exposures, lb/hr

ER_{HCl} is the emission rate of HCl in lbs/hr

ER_{Cl_2} is the emission rate of chlorine in lbs/hr

$aREL_{HCl}$ is the aREL for HCl

$aREL_{Cl_2}$ is the aREL for chlorine

(4) You must use the RfC values for hydrogen chloride and chlorine found at <http://epa.gov/ttn/atw/toxsource/summary.html> .

(5) You must use the aREL values for hydrogen chloride and chlorine found at http://www.oehha.ca.gov/air/acute_rels/acute_rels.html .

(6) *Cl₂ HCl ratios* —(i) *Ratio for calculating annual average HCl-equivalent emission rates* . (A) To calculate the annual average HCl-equivalent emission rate (lb/hr) for each combustor, you must apportion the total chlorine emission concentration (ppmv chloride (Cl⁻) equivalent) between HCl and chlorine according to the historical average Cl₂ /HCl volumetric ratio for all regulatory compliance tests.

(B) You must calculate HCl and Cl₂ emission rates (lb/hr) using the apportioned emission concentrations and the gas flowrate and other parameters from the most recent regulatory compliance test.

(C) You must calculate the annual average HCl-equivalent emission rate using these HCl and Cl₂ emission rates and the equation in paragraph (b)(2) of this section.

(ii) *Ratio for calculating 1-hour average HCl-equivalent emission rates* . (A) To calculate the 1-hour average HCl-equivalent emission rate for each combustor as a criterion for you to determine

under paragraph (d) of this section if an hourly rolling average feedrate limit on total chlorine and chloride may be waived, you must apportion the total chlorine emission concentration (ppmv chloride (Cl⁻) equivalent) between HCl and chlorine according to the historical highest Cl₂/HCl volumetric ratio for all regulatory compliance tests.

(B) You must calculate HCl and Cl₂ emission rates (lb/hr) using the apportioned emission concentrations and the gas flowrate and other parameters from the most recent regulatory compliance test.

(C) You must calculate the 1-hour average HCl-equivalent emission rate using these HCl and Cl₂ emission rates and the equation in paragraph (b)(3) of this section.

(iii) *Ratios for new sources*. (A) You must use engineering information to estimate the Cl₂/HCl volumetric ratio for a new source for the initial eligibility demonstration.

(B) You must use the Cl₂/HCl volumetric ratio demonstrated during the initial comprehensive performance test to demonstrate in the Notification of Compliance that your HCl-equivalent emission rate does not exceed your HCl-equivalent emission rate limit.

(C) When approving the test plan for the initial comprehensive performance test, the permitting authority will establish a periodic testing requirement, such as every 3 months for 1 year, to establish a record of representative Cl₂/HCl volumetric ratios.

(1) You must revise your HCl-equivalent emission rates and HCl-equivalent emission rate limits after each such test using the procedures prescribed in paragraphs (b)(6)(i) and (ii) of this section.

(2) If you no longer are eligible for the health-based compliance alternative, you must notify the permitting authority immediately and either:

(i) Submit a revised eligibility demonstration requesting lower HCl-equivalent emission rate limits, establishing lower HCl-equivalent emission rates, and establishing by downward extrapolation lower feedrate limits for total chlorine and chloride; or

(ii) Request a compliance schedule of up to three years to demonstrate compliance with the emission standards under §§ 63.1216, 63.1217, 63.1219, 63.1220, and 63.1221.

(iv) *Unrepresentative or inadequate historical Cl₂/HCl volumetric ratios*. (A) If you believe that the Cl₂/HCl volumetric ratio for one or more historical regulatory compliance tests is not representative of the current ratio, you may request that the permitting authority allow you to screen those ratios from the analysis of historical ratios.

(B) If the permitting authority believes that too few historical ratios are available to calculate a representative average ratio or establish a maximum ratio, the permitting authority may require you to conduct periodic testing to establish representative ratios.

(v) *Updating Cl₂/HCl ratios*. You must include the Cl₂/HCl volumetric ratio demonstrated during each performance test in your data base of historical Cl₂/HCl ratios to update the ratios you establish under paragraphs (b)(6)(i) and (ii) of this section for subsequent calculations of the annual average and 1-hour average HCl-equivalent emission rates.

(7) *Emission rates are capped*. The hydrogen chloride and chlorine emission rates you use to calculate the HCl-equivalent emission rate limit for incinerators, cement kilns, and lightweight aggregate kilns must not result in total chlorine emission concentrations exceeding:

(i) For incinerators that were existing sources on April 19, 1996: 77 parts per million by volume, combined emissions, expressed as chloride (Cl⁻) equivalent, dry basis and corrected to 7 percent oxygen;

(ii) For incinerators that are new or reconstructed sources after April 19, 1996: 21 parts per million by volume, combined emissions, expressed as chloride ($\text{Cl}^{(-)}$) equivalent, dry basis and corrected to 7 percent oxygen;

(iii) For cement kilns that were existing sources on April 19, 1996: 130 parts per million by volume, combined emissions, expressed as chloride ($\text{Cl}^{(-)}$) equivalent, dry basis and corrected to 7 percent oxygen;

(iv) For cement kilns that are new or reconstructed sources after April 19, 1996: 86 parts per million by volume, combined emissions, expressed as chloride ($\text{Cl}^{(-)}$) equivalent, dry basis and corrected to 7 percent oxygen;

(v) For lightweight aggregate kilns that were existing sources on April 19, 1996: 600 parts per million by volume, combined emissions, expressed as chloride ($\text{Cl}^{(-)}$) equivalent, dry basis and corrected to 7 percent oxygen;

(vi) For lightweight aggregate kilns that are new or reconstructed sources after April 19, 1996: 600 parts per million by volume, combined emissions, expressed as chloride ($\text{Cl}^{(-)}$) equivalent, dry basis and corrected to 7 percent oxygen.

(c) *Eligibility demonstration* —(1) *General*. (i) You must perform an eligibility demonstration to determine whether the total chlorine emission rates you select for each on-site hazardous waste combustor meet the national exposure standards using either a look-up table analysis prescribed by paragraph (c)(3) of this section, or a site-specific compliance demonstration prescribed by paragraph (c)(4) of this section.

(ii) You must also determine in your eligibility demonstration whether each combustor may exceed the 1-hour HCl-equivalent emission rate limit absent an hourly rolling average limit on the feedrate of total chlorine and chloride, as provided by paragraph (d) of this section.

(2) *Definition of eligibility*. (i) Eligibility for the risk-based total chlorine standard is determined by comparing the annual average HCl-equivalent emission rate for the total chlorine emission rate you select for each combustor to the annual average HCl-equivalent emission rate limit.

(ii) The annual average HCl-equivalent emission rate limit ensures that the Hazard Index for chronic exposure from HCl and chlorine emissions from all on-site hazardous waste combustors is less than or equal to 1.0, rounded to the nearest tenths decimal place (0.1), for the actual individual most exposed to the facility's emissions, considering off-site locations where people reside and where people congregate for work, school, or recreation.

(iii) Your facility is eligible for the health-based compliance alternative for total chlorine if either:

(A) The annual average HCl-equivalent emission rate for each on-site hazardous waste combustor is below the appropriate value in the look-up table determined under paragraph (c)(3) of this section; or

(B) The annual average HCl-equivalent emission rate for each on-site hazardous waste combustor is below the annual average HCl-equivalent emission rate limit you calculate based on a site-specific compliance demonstration under paragraph (c)(4) of this section.

(3) *Look-up table analysis*. Look-up tables for the eligibility demonstration are provided as Tables 1 and 2 to this section.

(i) Table 1 presents annual average HCl-equivalent emission rate limits for sources located in flat terrain. For purposes of this analysis, flat terrain is terrain that rises to a level not exceeding one half the stack height within a distance of 50 stack heights.

(ii) Table 2 presents annual average HCl-equivalent emission rate limits for sources located in simple elevated terrain. For purposes of this analysis, simple elevated terrain is terrain that rises to a

level exceeding one half the stack height, but that does not exceed the stack height, within a distance of 50 stack heights.

(iii) To determine the annual average HCl-equivalent emission rate limit for a source from the look-up table, you must use the stack height and stack diameter for your hazardous waste combustors and the distance between the stack and the property boundary.

(iv) If any of these values for stack height, stack diameter, and distance to nearest property boundary do not match the exact values in the look-up table, you must use the next lowest table value.

(v) *Adjusted HCl-equivalent emission rate limit for multiple on-site combustors.* (A) If you have more than one hazardous waste combustor on site, the sum across all hazardous waste combustors of the ratio of the adjusted HCl-equivalent emission rate limit to the HCl-equivalent emission rate limit provided by Tables 1 or 2 cannot exceed 1.0, according to the following equation:

$$\sum_{i=1}^n \frac{\text{HCl-Equivalent Emission Rate Limit Adjusted}_i}{\text{HCl-Equivalent Emission Rate Limit Table}_i} \leq 1.0$$

Where:

i = number of on-site hazardous waste combustors;

HCl-Equivalent Emission Rate Limit Adjusted _{i} means the apportioned, allowable HCl-equivalent emission rate limit for combustor i , and

HCl-Equivalent Emission Rate Limit Table _{i} means the HCl-equivalent emission rate limit from Table 1 or 2 to § 63.1215 for combustor i .

(B) The adjusted HCl-equivalent emission rate limit becomes the HCl-equivalent emission rate limit.

(4) *Site-specific compliance demonstration.* (i) You may use any scientifically-accepted peer-reviewed risk assessment methodology for your site-specific compliance demonstration to calculate an annual average HCl-equivalent emission rate limit for each on-site hazardous waste combustor. An example of one approach for performing the demonstration for air toxics can be found in the EPA's "Air Toxics Risk Assessment Reference Library, Volume 2, Site-Specific Risk Assessment Technical Resource Document," which may be obtained through the EPA's Air Toxics Web site at http://www.epa.gov/ttn/fera/risk_atra_main.html.

(ii) The annual average HCl-equivalent emission rate limit is the HCl-equivalent emission rate that ensures that the Hazard Index associated with maximum annual average exposures is not greater than 1.0 rounded to the nearest tenths decimal place (0.1).

(iii) To determine the annual average HCl-equivalent emission rate limit, your site-specific compliance demonstration must, at a minimum:

(A) Estimate long-term inhalation exposures through the estimation of annual or multi-year average ambient concentrations;

(B) Estimate the inhalation exposure for the actual individual most exposed to the facility's emissions from hazardous waste combustors, considering off-site locations where people reside and where people congregate for work, school, or recreation;

(C) Use site-specific, quality-assured data wherever possible;

(D) Use health-protective default assumptions wherever site-specific data are not available, and:

(E) Contain adequate documentation of the data and methods used for the assessment so that it is transparent and can be reproduced by an experienced risk assessor and emissions measurement expert.

(iv) Your site-specific compliance demonstration need not:

(A) Assume any attenuation of exposure concentrations due to the penetration of outdoor pollutants into indoor exposure areas;

(B) Assume any reaction or deposition of the emitted pollutants during transport from the emission point to the point of exposure.

(d) *Assurance that the 1-hour HCl-equivalent emission rate limit will not be exceeded.* To ensure that the 1-hour HCl-equivalent emission rate limit will not be exceeded when complying with the annual average HCl-equivalent emission rate limit, you must establish a 1-hour average HCl-equivalent emission rate for each combustor, establish a 1-hour average HCl-equivalent emission rate limit for each combustor, and consider site-specific factors including prescribed criteria to determine if the 1-hour average HCl-equivalent emission rate limit may be exceeded absent an hourly rolling average limit on the feedrate of total chlorine and chloride. If the 1-hour average HCl-equivalent emission rate limit may be exceeded, you must establish an hourly rolling average feedrate limit on total chlorine as provided by paragraph (f)(3) of this section.

(1) *1-hour average HCl-equivalent emission rate.* You must calculate the 1-hour average HCl-equivalent emission rate from the total chlorine emission concentration you select for each source as prescribed in paragraph (b)(6)(ii)(C) of this section.

(2) *1-hour average HCl-equivalent emission rate limit.* You must establish the 1-hour average HCl-equivalent emission rate limit for each affected source using either a look-up table analysis or site-specific analysis:

(i) *Look-up table analysis.* Look-up tables are provided for 1-hour average HCl-equivalent emission rate limits as Table 3 and Table 4 to this section. Table 3 provides limits for facilities located in flat terrain. Table 4 provides limits for facilities located in simple elevated terrain. You must use the Tables to establish 1-hour average HCl-equivalent emission rate limits as prescribed in paragraphs (c)(3)(iii) through (c)(3)(v) of this section for annual average HCl-equivalent emission rate limits.

(ii) *Site-specific analysis.* The 1-hour average HCl-equivalent emission rate limit is the HCl-equivalent emission rate that ensures that the Hazard Index associated with maximum 1-hour average exposures is not greater than 1.0 rounded to the nearest tenths decimal place (0.1). You must follow the risk assessment procedures under paragraph (c)(4) of this section to estimate short-term inhalation exposures through the estimation of maximum 1-hour average ambient concentrations.

(3) *Criteria for determining whether the 1-hour HCl-equivalent emission rate may be exceeded absent an hourly rolling average limit on the feedrate of total chlorine and chloride.* An hourly rolling average feedrate limit on total chlorine and chloride is waived if you determine considering the criteria listed below that the long-term feedrate limit (and averaging period) established under paragraph (c)(4)(i) of this section will also ensure that the 1-hour average HCl-equivalent emission rate will not exceed the 1-hour average HCl-equivalent emission rate limit you calculate for each combustor.

(i) The ratio of the 1-hour average HCl-equivalent emission rate based on the total chlorine emission rate you select for each hazardous waste combustor to the 1-hour average HCl-equivalent emission rate limit for the combustor; and

(ii) The potential for the source to vary total chlorine and chloride feedrates substantially over the averaging period for the feedrate limit established under paragraph (c)(4)(i) of this section.

(e) *Review and approval of eligibility demonstrations* —(1) *Content of the eligibility demonstration* —(i) *General.* The eligibility demonstration must include the following information, at a minimum:

(A) Identification of each hazardous waste combustor combustion gas emission point (e.g., generally, the flue gas stack);

(B) The maximum and average capacity at which each combustor will operate, and the maximum rated capacity for each combustor, using the metric of stack gas volume (under both actual and standard conditions) emitted per unit of time, as well as any other metric that is appropriate for the combustor (e.g., million Btu/hr heat input for boilers; tons of dry raw material feed/hour for cement kilns);

(C) Stack parameters for each combustor, including, but not limited to stack height, stack diameter, stack gas temperature, and stack gas exit velocity;

(D) Plot plan showing all stack emission points, nearby residences and property boundary line;

(E) Identification of any stack gas control devices used to reduce emissions from each combustor;

(F) Identification of the RfC values used to calculate annual average HCl-equivalent emission rates and the aREL values used to calculate 1-hour average HCl-equivalent emission rates;

(G) Calculations used to determine the annual average and 1-hour average HCl-equivalent emission rates and rate limits, including calculation of the Cl_2 /HCl ratios as prescribed by paragraph (b)(6) of this section;

(ii) *Additional content to implement the annual average HCl-equivalent emission rate limit.* You must include the following in your eligibility demonstration to implement the annual average HCl-equivalent emission rate limit:

(A) For incinerators, cement kilns, and lightweight aggregate kilns, calculations to confirm that the annual average HCl-equivalent emission rate that you calculate from the total chlorine emission rate you select for each combustor does not exceed the limits provided by paragraph (b)(7) of this section;

(B) Comparison of the annual average HCl-equivalent emission rate limit for each combustor to the annual average HCl-equivalent emission rate for the total chlorine emission rate you select for each combustor;

(C) The annual average HCl-equivalent emission rate limit for each hazardous waste combustor, and the limits on operating parameters required under paragraph (g)(1) of this section;

(D) Determination of the long-term chlorine feedrate limit, including the total chlorine system removal efficiency for sources that establish an (up to) annual rolling average feedrate limit under paragraph (g)(2)(ii) of this section;

(iii) *Additional content to implement the 1-hour average HCl-equivalent emission rate limit.* You must include the following in your eligibility demonstration to implement the 1-hour average HCl-equivalent emission rate limit:

(A) Determination of whether the combustor may exceed the 1-hour HCl-equivalent emission rate limit absent an hourly rolling average chlorine feedrate limit, including:

(1) Determination of the 1-hour average HCl-equivalent emission rate from the total chlorine emission rate you select for the combustor;

(2) Determination of the 1-hour average HCl-equivalent emission rate limit using either look-up Tables 3 and 4 to this section or site-specific risk analysis;

(3) Determination of the ratio of the 1-hour average HCl-equivalent emission rate to the 1-hour average HCl-equivalent emission rate limit for the combustor; and

(4) The potential for the source to vary total chlorine and chloride feedrates substantially over the averaging period for the long-term feedrate limit established under paragraphs (g)(2)(i) and (g)(2)(ii) of this section; and

(B) Determination of the hourly rolling average chlorine feedrate limit, including the total chlorine system removal efficiency.

(iv) *Additional content of a look-up table demonstration.* If you use the look-up table analysis to establish HCl-equivalent emission rate limits, your eligibility demonstration must also contain, at a minimum, the following:

(A) Documentation that the facility is located in either flat or simple elevated terrain; and

(B) For facilities with more than one on-site hazardous waste combustor, documentation that the sum of the ratios for all such combustors of the HCl-equivalent emission rate to the HCl-equivalent emission rate limit does not exceed 1.0.

(v) *Additional content of a site-specific compliance demonstration.* If you use a site-specific compliance demonstration, your eligibility demonstration must also contain, at a minimum, the following information to support your determination of the annual average HCl-equivalent emission rate limit for each combustor:

(A) Identification of the risk assessment methodology used;

(B) Documentation of the fate and transport model used;

(C) Documentation of the fate and transport model inputs, including the stack parameters listed in paragraph (d)(1)(i)(C) of this section converted to the dimensions required for the model;

(D) As applicable:

(1) Meteorological data;

(2) Building, land use, and terrain data;

(3) Receptor locations and population data, including areas where people congregate for work, school, or recreation; and

(4) Other facility-specific parameters input into the model;

(E) Documentation of the fate and transport model outputs; and

(F) Documentation of any exposure assessment and risk characterization calculations.

(2) *Review and approval* —(i) *Existing sources.* (A) If you operate an existing source, you must submit the eligibility demonstration to your permitting authority for review and approval not later than 12 months prior to the compliance date. You must also submit a separate copy of the eligibility demonstration to: U.S. EPA, Risk and Exposure Assessment Group, Emission Standards Division (C404-01), Attn: Group Leader, Research Triangle Park, North Carolina 27711, electronic mail address REAG@epa.gov.

(B) Your permitting authority should notify you of approval or intent to disapprove your eligibility demonstration within 6 months after receipt of the original demonstration, and within 3 months after receipt of any supplemental information that you submit. A notice of intent to disapprove your eligibility demonstration, whether before or after the compliance date, will identify incomplete or inaccurate information or noncompliance with prescribed procedures and specify how much time you will have to submit additional information or to achieve the MACT standards for total chlorine under §§ 63.1216, 63.1217, 63.1219, 63.1220, and 63.1221. If your eligibility demonstration is disapproved, the permitting authority may extend the compliance date of the total chlorine standards up to one year to allow you to make changes to the design or operation of the combustor or related systems as quickly as practicable to enable you to achieve compliance with the MACT total chlorine standards.

(C) If your permitting authority has not approved your eligibility demonstration by the compliance date, and has not issued a notice of intent to disapprove your demonstration, you may begin

complying, on the compliance date, with the HCl-equivalent emission rate limits you present in your eligibility demonstration provided that you have made a good faith effort to provide complete and accurate information and to respond to any requests for additional information in a timely manner. If the permitting authority believes that you have not made a good faith effort to provide complete and accurate information or to respond to any requests for additional information, however, the authority may notify you in writing by the compliance date that you have not met the conditions for complying with the health-based compliance alternative without prior approval. Such notice will explain the basis for concluding that you have not made a good faith effort to comply with the health-based compliance alternative by the compliance date.

(D) If your permitting authority issues a notice of intent to disapprove your eligibility demonstration after the compliance date, the authority will identify the basis for that notice and specify how much time you will have to submit additional information or to comply with the MACT standards for total chlorine under §§ 63.1216, 63.1217, 63.1219, 63.1220, and 63.1221. The permitting authority may extend the compliance date of the total chlorine standards up to one-year to allow you to make changes to the design or operation of the combustor or related systems as quickly as practicable to enable you to achieve compliance with the MACT standards for total chlorine.

(ii) *New or reconstructed sources* —(A) *General*. The procedures for review and approval of eligibility demonstrations applicable to existing sources under paragraph (e)(2)(i) of this section also apply to new or reconstructed sources, except that the date you must submit the eligibility demonstration is as prescribed in this paragraph (e)(2)(ii).

(B) If you operate a new or reconstructed source that starts up before April 12, 2007, or a solid fuel boiler or liquid fuel boiler that is an area source that increases its emissions or its potential to emit such that it becomes a major source of HAP before April 12, 2007, you must either:

(1) Comply with the final total chlorine emission standards under §§ 63.1216, 63.1217, 63.1219, 63.1220, and 63.1221, by October 12, 2005, or upon startup, whichever is later, except for a standard that is more stringent than the standard proposed on April 20, 2004 for your source. If a final standard is more stringent than the proposed standard, you may comply with the proposed standard until October 14, 2008, after which you must comply with the final standard; or

(2) Submit an eligibility demonstration for review and approval under this section by April 12, 2006, and comply with the HCl-equivalent emission rate limits and operating requirements you establish in the eligibility demonstration.

(C) If you operate a new or reconstructed source that starts up on or after April 12, 2007, or a solid fuel boiler or liquid fuel boiler that is an area source that increases its emissions or its potential to emit such that it becomes a major source of HAP on or after April 12, 2007, you must either:

(1) Comply with the final total chlorine emission standards under §§ 63.1216, 63.1217, 63.1219, 63.1220, and 63.1221 upon startup. If the final standard is more stringent than the standard proposed for your source on April 20, 2004, however, and if you start operations before October 14, 2008, you may comply with the proposed standard until October 14, 2008, after which you must comply with the final standard; or

(2) Submit an eligibility demonstration for review and approval under this section 12 months prior to startup.

(3) The operating requirements in the eligibility demonstration are applicable requirements for purposes of parts 70 and 71 of this chapter and will be incorporated in the title V permit.

(f) *Testing requirements* —(1) *General*. You must comply with the requirements for comprehensive performance testing under § 63.1207.

(2) *System removal efficiency*. (i) You must calculate the total chlorine removal efficiency of the combustor during each run of the comprehensive performance test.

(ii) You must calculate the average system removal efficiency as the average of the test run averages.

(iii) If your source does not control emissions of total chlorine, you must assume zero system removal efficiency.

(3) *Annual average HCl-equivalent emission rate limit.* If emissions during the comprehensive performance test exceed the annual average HCl-equivalent emission rate limit, eligibility for emission limits under this section is not affected. This emission rate limit is an annual average limit even though compliance is based on a 12-hour or (up to) an annual rolling average feedrate limit on total chlorine and chloride because the feedrate limit is also used for compliance assurance for the semivolatile metal emission standard

(4) *1-hour average HCl-equivalent emission rate limit.* Total chlorine emissions during each run of the comprehensive performance test cannot exceed the 1-hour average HCl-equivalent emission rate limit.

(5) *Test methods.* (i) If you operate a cement kiln or a combustor equipped with a dry acid gas scrubber, you must use EPA Method 320/321 or ASTM D 6735-01, or an equivalent method, to measure hydrogen chloride, and the back-half (caustic impingers) of Method 26/26A, or an equivalent method, to measure chlorine gas.

(ii) *Bromine and sulfur considerations.* If you operate an incinerator, boiler, or lightweight aggregate kiln and your feedstreams contain bromine or sulfur during the comprehensive performance test at levels specified under paragraph (e)(2)(ii)(B) of this section, you must use EPA Method 320/321 or ASTM D 6735-01, or an equivalent method, to measure hydrogen chloride, and Method 26/26A, or an equivalent method, to measure chlorine and hydrogen chloride, and determine your chlorine emissions as follows:

(A) You must determine your chlorine emissions to be the higher of the value measured by Method 26/26A as provided in appendix A-8, part 60 of this chapter, or an equivalent method, or the value calculated by the difference between the combined hydrogen chloride and chlorine levels measured by Method 26/26A as provided in appendix A-8, part 60 of this chapter, or an equivalent method, and the hydrogen chloride measurement from EPA Method 320/321 as provided in appendix A, part 63 of this chapter, or ASTM D 6735-01 as described under § 63.1208(b)(5)(i)(C), or an equivalent method.

(B) The procedures under paragraph (f)(2)(ii) of this section for determining hydrogen chloride and chlorine emissions apply if you feed bromine or sulfur during the performance test at the levels specified in this paragraph (f)(5)(ii)(B):

(1) If the bromine/chlorine ratio in feedstreams is greater than 5 percent by mass; or

(2) If the sulfur/chlorine ratio in feedstreams is greater than 50 percent by mass.

(g) *Monitoring requirements* —(1) *General.* You must establish and comply with limits on the same operating parameters that apply to sources complying with the MACT standard for total chlorine under § 63.1209(o), except that feedrate limits on total chlorine and chloride must be established according to paragraphs (g)(2) and (g)(3) of this section:

(2) *Feedrate limit to ensure compliance with the annual average HCl-equivalent emission rate limit.* (i) For sources subject to the feedrate limit for total chlorine and chloride under § 63.1209(n)(4) to ensure compliance with the semivolatile metals standard:

(A) The feedrate limit (and averaging period) for total chlorine and chloride to ensure compliance with the annual average HCl-equivalent emission rate limit is the same as required by § 63.1209(n)(4), except as provided by paragraph (g)(2)(i)(B) of this section.

(B) The numerical value of the total chlorine and chloride feedrate limit (i.e., not considering the averaging period) you establish under § 63.1209(n)(4) must not exceed the value you calculate as the annual average HCl-equivalent emission rate limit (lb/hr) divided by $[1 - \text{system removal efficiency}]$, where the system removal efficiency is calculated as prescribed by paragraph (f)(2) of this section.

(ii) For sources exempt from the feedrate limit for total chlorine and chloride under § 63.1209(n)(4) because they comply with § 63.1207(m)(2), the feedrate limit for total chlorine and chloride to ensure compliance with the annual average HCl-equivalent emission rate must be established as follows:

(A) You must establish an average period for the feedrate limit that does not exceed an annual rolling average;

(B) The numerical value of the total chlorine and chloride feedrate limit (i.e., not considering the averaging period) must not exceed the value you calculate as the annual average HCl-equivalent emission rate limit (lb/hr) divided by $[1 - \text{system removal efficiency}]$, where the system removal efficiency is calculated as prescribed by paragraph (f)(2) of this section.

(C) You must calculate the initial rolling average as though you had selected a 12-hour rolling average, as provided by paragraph (b)(5)(i) of this section. You must calculate rolling averages thereafter as the average of the available one-minute values until enough one-minute values are available to calculate the rolling average period you select. At that time and thereafter, you update the rolling average feedrate each hour with a 60-minute average feedrate.

(3) *Feedrate limit to ensure compliance with the 1-hour average HCl-equivalent emission rate limit.* (i) You must establish an hourly rolling average feedrate limit on total chlorine and chloride to ensure compliance with the 1-hour average HCl-equivalent emission rate limit unless you determine that the hourly rolling average feedrate limit is waived under paragraph (d) of this section.

(ii) You must calculate the hourly rolling average feedrate limit for total chlorine and chloride as the 1-hour average HCl-equivalent emission rate limit (lb/hr) divided by $[1 - \text{system removal efficiency}]$, where the system removal efficiency is calculated as prescribed by paragraph (f)(2)(ii) of this section.

(h) *Changes* —(1) *Changes over which you have control* —(i) *Changes that would affect the HCl-equivalent emission rate limit.* (A) If you plan to change the design, operation, or maintenance of the facility in a manner than would decrease the annual average or 1-hour average HCl-equivalent emission rate limit, you must submit to the permitting authority prior to the change a revised eligibility demonstration documenting the lower emission rate limits and calculations of reduced total chlorine and chloride feedrate limits.

(B) If you plan to change the design, operation, or maintenance of the facility in a manner than would increase the annual average or 1-hour average HCl-equivalent emission rate limit, and you elect to increase your total chlorine and chloride feedrate limits. You must also submit to the permitting authority prior to the change a revised eligibility demonstration documenting the increased emission rate limits and calculations of the increased feedrate limits prior to the change.

(ii) *Changes that could affect system removal efficiency.* (A) If you plan to change the design, operation, or maintenance of the combustor in a manner than could decrease the system removal efficiency, you are subject to the requirements of § 63.1206(b)(5) for conducting a performance test to reestablish the combustor's system removal efficiency and you must submit a revised eligibility demonstration documenting the lower system removal efficiency and the reduced feedrate limits on total chlorine and chloride.

(B) If you plan to change the design, operation, or maintenance of the combustor in a manner than could increase the system removal efficiency, and you elect to document the increased system removal efficiency to establish higher feedrate limits on total chlorine and chloride, you are subject to the requirements of § 63.1206(b)(5) for conducting a performance test to reestablish the combustor's system removal efficiency. You must also submit to the permitting authority a revised eligibility

demonstration documenting the higher system removal efficiency and the increased feedrate limits on total chlorine and chloride.

(2) *Changes over which you do not have control that may decrease the HCl-equivalent emission rate limits.* These requirements apply if you use a site-specific risk assessment under paragraph (c)(4) of this section to demonstrate eligibility for the health-based limits.

(i) *Proactive review.* You must submit for review and approval with each comprehensive performance test plan either a certification that the information used in your eligibility demonstration has not changed in a manner that would decrease the annual average or 1-hour average HCl-equivalent emission rate limit, or a revised eligibility demonstration.

(ii) *Reactive review.* If in the interim between your comprehensive performance tests you have reason to know of changes that would decrease the annual average or 1-hour average HCl-equivalent emission rate limit, you must submit a revised eligibility demonstration as soon as practicable but not more frequently than annually.

(iii) *Compliance schedule.* If you determine that you cannot demonstrate compliance with a lower annual average HCl-equivalent emission rate limit during the comprehensive performance test because you need additional time to complete changes to the design or operation of the source, you may request that the permitting authority grant you additional time to make those changes as quickly as practicable.

Table 1 of §63.1215: Annual Average HCl-Equivalent Emission Rate Limits (lb/hr) – Flat Terrain

Distance to property boundary (m)

Stack Diameter = 0.3 m	Distance to property boundary (m)												
Stack Height (m)	30	50	70	100	150	200	300	500	700	1000	2000	3000	5000
5	3.7E+01	4.0E+01	4.6E+01	0.1E+01	1.6E+00	2.3E+00	4.1E+00	5.7E+00	8.1E+00	1.0E+01	1.5E+01	2.2E+01	3.2E+01
10	1.0E+00	1.0E+00	1.1E+00	1.0E+00	2.7E+00	4.0E+00	5.7E+00	8.1E+00	1.1E+01	1.6E+01	2.3E+01	3.2E+01	4.6E+01
20	2.3E+00	2.3E+00	2.3E+00	2.3E+00	3.7E+00	5.0E+00	7.4E+00	1.0E+01	1.4E+01	2.0E+01	2.8E+01	3.9E+01	5.3E+01
30	4.1E+00	4.1E+00	4.1E+00	4.1E+00	6.0E+00	8.0E+00	1.1E+01	1.5E+01	2.1E+01	2.9E+01	4.0E+01	5.4E+01	7.4E+01
40	1.2E+01	1.2E+01	1.2E+01	1.2E+01	1.7E+01	2.3E+01	3.1E+01	4.2E+01	5.6E+01	7.4E+01	9.9E+01	1.3E+02	1.8E+02
50	1.9E+01	1.9E+01	1.9E+01	1.9E+01	2.7E+01	3.6E+01	4.8E+01	6.3E+01	8.3E+01	1.1E+02	1.4E+02	1.9E+02	2.6E+02
60	2.7E+01	2.7E+01	2.7E+01	2.7E+01	3.7E+01	4.9E+01	6.4E+01	8.4E+01	1.1E+02	1.4E+02	1.9E+02	2.6E+02	3.5E+02
70	3.6E+01	3.6E+01	3.6E+01	3.6E+01	4.9E+01	6.4E+01	8.4E+01	1.1E+02	1.4E+02	1.9E+02	2.6E+02	3.5E+02	4.7E+02
80	4.6E+01	4.6E+01	4.6E+01	4.6E+01	6.2E+01	8.0E+01	1.0E+02	1.3E+02	1.7E+02	2.2E+02	2.9E+02	3.9E+02	5.2E+02
90	5.7E+01	5.7E+01	5.7E+01	5.7E+01	7.6E+01	9.8E+01	1.3E+02	1.7E+02	2.2E+02	2.9E+02	3.9E+02	5.2E+02	6.9E+02
100	6.9E+01	6.9E+01	6.9E+01	6.9E+01	9.3E+01	1.2E+02	1.6E+02	2.1E+02	2.8E+02	3.7E+02	4.9E+02	6.4E+02	8.5E+02
110	8.2E+01	8.2E+01	8.2E+01	8.2E+01	1.1E+02	1.4E+02	1.9E+02	2.5E+02	3.3E+02	4.3E+02	5.7E+02	7.5E+02	1.0E+03
120	9.6E+01	9.6E+01	9.6E+01	9.6E+01	1.3E+02	1.7E+02	2.3E+02	3.0E+02	4.0E+02	5.2E+02	6.8E+02	9.0E+02	1.2E+03
130	1.1E+02	1.1E+02	1.1E+02	1.1E+02	1.5E+02	2.0E+02	2.7E+02	3.5E+02	4.6E+02	6.0E+02	7.9E+02	1.0E+03	1.3E+03
140	1.3E+02	1.3E+02	1.3E+02	1.3E+02	1.8E+02	2.4E+02	3.2E+02	4.2E+02	5.4E+02	7.0E+02	9.2E+02	1.2E+03	1.6E+03
150	1.5E+02	1.5E+02	1.5E+02	1.5E+02	2.1E+02	2.8E+02	3.7E+02	4.8E+02	6.2E+02	8.0E+02	1.0E+03	1.3E+03	1.7E+03
160	1.8E+02	1.8E+02	1.8E+02	1.8E+02	2.5E+02	3.3E+02	4.4E+02	5.6E+02	7.2E+02	9.3E+02	1.2E+03	1.6E+03	2.1E+03
170	2.1E+02	2.1E+02	2.1E+02	2.1E+02	3.0E+02	3.9E+02	5.1E+02	6.4E+02	8.2E+02	1.0E+03	1.3E+03	1.7E+03	2.3E+03
180	2.4E+02	2.4E+02	2.4E+02	2.4E+02	3.5E+02	4.5E+02	5.8E+02	7.3E+02	9.3E+02	1.2E+03	1.6E+03	2.1E+03	2.8E+03
190	2.8E+02	2.8E+02	2.8E+02	2.8E+02	4.0E+02	5.1E+02	6.5E+02	8.1E+02	1.0E+03	1.3E+03	1.7E+03	2.3E+03	3.0E+03
200	3.2E+02	3.2E+02	3.2E+02	3.2E+02	4.6E+02	5.8E+02	7.3E+02	9.0E+02	1.1E+03	1.4E+03	1.8E+03	2.4E+03	3.2E+03
210	3.6E+02	3.6E+02	3.6E+02	3.6E+02	5.2E+02	6.5E+02	8.1E+02	9.9E+02	1.2E+03	1.6E+03	2.1E+03	2.8E+03	3.7E+03
220	4.1E+02	4.1E+02	4.1E+02	4.1E+02	5.9E+02	7.3E+02	9.0E+02	1.1E+03	1.4E+03	1.8E+03	2.4E+03	3.1E+03	4.1E+03
230	4.6E+02	4.6E+02	4.6E+02	4.6E+02	6.6E+02	8.1E+02	9.9E+02	1.2E+03	1.6E+03	2.1E+03	2.8E+03	3.7E+03	4.8E+03
240	5.2E+02	5.2E+02	5.2E+02	5.2E+02	7.4E+02	9.0E+02	1.1E+03	1.4E+03	1.8E+03	2.4E+03	3.1E+03	4.1E+03	5.3E+03
250	5.8E+02	5.8E+02	5.8E+02	5.8E+02	8.3E+02	1.0E+03	1.3E+03	1.7E+03	2.2E+03	2.9E+03	3.8E+03	5.0E+03	6.5E+03
260	6.5E+02	6.5E+02	6.5E+02	6.5E+02	9.3E+02	1.1E+03	1.4E+03	1.8E+03	2.4E+03	3.1E+03	4.1E+03	5.3E+03	6.9E+03
270	7.2E+02	7.2E+02	7.2E+02	7.2E+02	1.0E+03	1.3E+03	1.7E+03	2.2E+03	2.9E+03	3.8E+03	5.0E+03	6.5E+03	8.4E+03
280	8.0E+02	8.0E+02	8.0E+02	8.0E+02	1.1E+03	1.4E+03	1.8E+03	2.4E+03	3.1E+03	4.1E+03	5.3E+03	6.9E+03	9.0E+03
290	8.8E+02	8.8E+02	8.8E+02	8.8E+02	1.2E+03	1.6E+03	2.0E+03	2.6E+03	3.4E+03	4.4E+03	5.7E+03	7.4E+03	9.7E+03
300	9.7E+02	9.7E+02	9.7E+02	9.7E+02	1.3E+03	1.7E+03	2.2E+03	2.9E+03	3.8E+03	4.9E+03	6.3E+03	8.2E+03	1.1E+04
310	1.1E+03	1.1E+03	1.1E+03	1.1E+03	1.4E+03	1.9E+03	2.4E+03	3.1E+03	4.1E+03	5.3E+03	6.9E+03	9.0E+03	1.2E+04
320	1.2E+03	1.2E+03	1.2E+03	1.2E+03	1.5E+03	2.0E+03	2.6E+03	3.4E+03	4.4E+03	5.7E+03	7.4E+03	9.7E+03	1.3E+04
330	1.3E+03	1.3E+03	1.3E+03	1.3E+03	1.6E+03	2.1E+03	2.7E+03	3.5E+03	4.5E+03	5.8E+03	7.5E+03	9.9E+03	1.3E+04
340	1.4E+03	1.4E+03	1.4E+03	1.4E+03	1.7E+03	2.2E+03	2.8E+03	3.6E+03	4.6E+03	5.9E+03	7.6E+03	1.0E+04	1.3E+04
350	1.5E+03	1.5E+03	1.5E+03	1.5E+03	1.8E+03	2.3E+03	2.9E+03	3.7E+03	4.7E+03	6.0E+03	7.7E+03	1.0E+04	1.3E+04
360	1.6E+03	1.6E+03	1.6E+03	1.6E+03	1.9E+03	2.4E+03	3.0E+03	3.8E+03	4.8E+03	6.1E+03	7.8E+03	1.0E+04	1.3E+04
370	1.7E+03	1.7E+03	1.7E+03	1.7E+03	2.0E+03	2.5E+03	3.1E+03	3.9E+03	4.9E+03	6.2E+03	7.9E+03	1.0E+04	1.3E+04
380	1.8E+03	1.8E+03	1.8E+03	1.8E+03	2.1E+03	2.6E+03	3.2E+03	4.0E+03	5.0E+03	6.3E+03	8.0E+03	1.0E+04	1.3E+04
390	1.9E+03	1.9E+03	1.9E+03	1.9E+03	2.2E+03	2.7E+03	3.3E+03	4.1E+03	5.1E+03	6.4E+03	8.1E+03	1.0E+04	1.3E+04
400	2.0E+03	2.0E+03	2.0E+03	2.0E+03	2.3E+03	2.8E+03	3.4E+03	4.2E+03	5.2E+03	6.5E+03	8.2E+03	1.0E+04	1.3E+04
410	2.1E+03	2.1E+03	2.1E+03	2.1E+03	2.4E+03	2.9E+03	3.5E+03	4.3E+03	5.3E+03	6.6E+03	8.3E+03	1.0E+04	1.3E+04
420	2.2E+03	2.2E+03	2.2E+03	2.2E+03	2.5E+03	3.0E+03	3.6E+03	4.4E+03	5.4E+03	6.7E+03	8.4E+03	1.0E+04	1.3E+04
430	2.3E+03	2.3E+03	2.3E+03	2.3E+03	2.6E+03	3.1E+03	3.7E+03	4.5E+03	5.5E+03	6.8E+03	8.5E+03	1.0E+04	1.3E+04
440	2.4E+03	2.4E+03	2.4E+03	2.4E+03	2.7E+03	3.2E+03	3.8E+03	4.6E+03	5.6E+03	6.9E+03	8.6E+03	1.0E+04	1.3E+04
450	2.5E+03	2.5E+03	2.5E+03	2.5E+03	2.8E+03	3.3E+03	3.9E+03	4.7E+03	5.7E+03	7.0E+03	8.7E+03	1.0E+04	1.3E+04
460	2.6E+03	2.6E+03	2.6E+03	2.6E+03	2.9E+03	3.4E+03	4.0E+03	4.8E+03	5.8E+03	7.1E+03	8.8E+03	1.0E+04	1.3E+04
470	2.7E+03	2.7E+03	2.7E+03	2.7E+03	3.0E+03	3.5E+03	4.1E+03	4.9E+03	5.9E+03	7.2E+03	8.9E+03	1.0E+04	1.3E+04
480	2.8E+03	2.8E+03	2.8E+03	2.8E+03	3.1E+03	3.6E+03	4.2E+03	5.0E+03	6.0E+03	7.3E+03	9.0E+03	1.0E+04	1.3E+04
490	2.9E+03	2.9E+03	2.9E+03	2.9E+03	3.2E+03	3.7E+03	4.3E+03	5.1E+03	6.1E+03	7.4E+03	9.1E+03	1.0E+04	1.3E+04
500	3.0E+03	3.0E+03	3.0E+03	3.0E+03	3.3E+03	3.8E+03	4.4E+03	5.2E+03	6.2E+03	7.5E+03	9.2E+03	1.0E+04	1.3E+04
510	3.1E+03	3.1E+03	3.1E+03	3.1E+03	3.4E+03	3.9E+03	4.5E+03	5.3E+03	6.3E+03	7.6E+03	9.3E+03	1.0E+04	1.3E+04
520	3.2E+03	3.2E+03	3.2E+03	3.2E+03	3.5E+03	4.0E+03	4.6E+03	5.4E+03	6.4E+03	7.7E+03	9.4E+03	1.0E+04	1.3E+04
530	3.3E+03	3.3E+03	3.3E+03	3.3E+03	3.6E+03	4.1E+03	4.7E+03	5.5E+03	6.5E+03	7.8E+03	9.5E+03	1.0E+04	1.3E+04
540	3.4E+03	3.4E+03	3.4E+03	3.4E+03	3.7E+03	4.2E+03	4.8E+03	5.6E+03	6.6E+03	7.9E+03	9.6E+03	1.0E+04	1.3E+04
550	3.5E+03	3.5E+03	3.5E+03	3.5E+03	3.8E+03	4.3E+03	4.9E+03	5.7E+03	6.7E+03	8.0E+03	9.7E+03	1.0E+04	1.3E+04
560	3.6E+03	3.6E+03	3.6E+03	3.6E+03	3.9E+03	4.4E+03	5.0E+03	5.8E+03	6.8E+03	8.1E+03	9.8E+03	1.0E+04	1.3E+04
570	3.7E+03	3.7E+03	3.7E+03	3.7E+03	4.0E+03	4.5E+03	5.1E+03	5.9E+03	6.9E+03	8.2E+03	9.9E+03	1.0E+04	1.3E+04
580	3.8E+03	3.8E+03	3.8E+03	3.8E+03	4.1E+03	4.6E+03	5.2E+03	6.0E+03	7.0E+03	8.3E+03	1.0E+04	1.3E+04	1.3E+04
590	3.9E+03	3.9E+03	3.9E+03	3.9E+03	4.2E+03	4.7E+03	5.3E+03	6.1E+03	7.1E+03	8.4E+03	1.0E+04	1.3E+04	1.3E+04
600	4.0E+03	4.0E+03	4.0E+03	4.0E+03	4.3E+03	4.8E+03	5.4E+03	6.2E+03	7.2E+03	8.5E+03	1.0E+04	1.3E+04	1.3E+04
610	4.1E+03	4.1E+03	4.1E+03	4.1E+03	4.4E+03	4.9E+03	5.5E+03	6.3E+03	7.3E+03	8.6E+03	1.0E+04	1.3E+04	1.3E+04
620	4.2E+03	4.2E+03	4.2E+03	4.2E+03	4.5E+03	5.0E+03	5.6E+03	6					

Table 2 of §63.1215: Annual Average HCl-Equivalent Emission Rate Limits (lbs/hr)—Simple Elevated Terrain

Stack Diameter = 0.3 m	Distance to property boundary (m)														
	30	50	70	100	200	300	500	700	1000	2000	3000	5000			
Stack height (m)	5	10	20	30	50	70	100	200 <td>300</td> <td>500</td> <td>700</td> <td>1000</td> <td>2000</td> <td>3000</td> <td>5000</td>	300	500	700	1000	2000	3000	5000
1.3E+01	1.8E+01	2.5E+01	3.7E+01	5.6E+01	8.9E+01	1.4E+02	2.0E+02	3.1E+02	4.6E+02	7.2E+02	1.1E+03	1.7E+03	2.6E+03	4.0E+03	6.1E+03
3.8E+01	5.3E+01	7.7E+01	1.1E+02	1.7E+02	2.6E+02	4.0E+02	6.0E+02	9.0E+02	1.4E+03	2.1E+03	3.2E+03	4.8E+03	7.2E+03	1.1E+04	1.6E+04
1.1E+02	1.5E+02	2.2E+02	3.3E+02	5.0E+02	7.5E+02	1.1E+03	1.7E+03	2.5E+03	3.8E+03	5.7E+03	8.6E+03	1.3E+04	2.0E+04	3.0E+04	4.5E+04
3.4E+02	4.8E+02	7.1E+02	1.1E+03	1.6E+03	2.4E+03	3.6E+03	5.4E+03	8.1E+03	1.2E+04	1.8E+04	2.7E+04	4.0E+04	6.0E+04	9.0E+04	1.4E+05
1.0E+05	1.4E+05	2.1E+05	3.2E+05	4.8E+05	7.2E+05	1.1E+06	1.6E+06	2.4E+06	3.6E+06	5.4E+06	8.1E+06	1.2E+07	1.8E+07	2.7E+07	4.0E+07
3.4E+07	4.8E+07	7.1E+07	1.1E+08	1.6E+08	2.4E+08	3.6E+08	5.4E+08	8.1E+08	1.2E+09	1.8E+09	2.7E+09	4.0E+09	6.0E+09	9.0E+09	1.4E+10
1.0E+10	1.4E+10	2.1E+10	3.2E+10	4.8E+10	7.2E+10	1.1E+11	1.6E+11	2.4E+11	3.6E+11	5.4E+11	8.1E+11	1.2E+12	1.8E+12	2.7E+12	4.0E+12
3.4E+12	4.8E+12	7.1E+12	1.1E+13	1.6E+13	2.4E+13	3.6E+13	5.4E+13	8.1E+13	1.2E+14	1.8E+14	2.7E+14	4.0E+14	6.0E+14	9.0E+14	1.4E+15
1.0E+15	1.4E+15	2.1E+15	3.2E+15	4.8E+15	7.2E+15	1.1E+16	1.6E+16	2.4E+16	3.6E+16	5.4E+16	8.1E+16	1.2E+17	1.8E+17	2.7E+17	4.0E+17
3.4E+17	4.8E+17	7.1E+17	1.1E+18	1.6E+18	2.4E+18	3.6E+18	5.4E+18	8.1E+18	1.2E+19	1.8E+19	2.7E+19	4.0E+19	6.0E+19	9.0E+19	1.4E+20
1.0E+20	1.4E+20	2.1E+20	3.2E+20	4.8E+20	7.2E+20	1.1E+21	1.6E+21	2.4E+21	3.6E+21	5.4E+21	8.1E+21	1.2E+22	1.8E+22	2.7E+22	4.0E+22
3.4E+22	4.8E+22	7.1E+22	1.1E+23	1.6E+23	2.4E+23	3.6E+23	5.4E+23	8.1E+23	1.2E+24	1.8E+24	2.7E+24	4.0E+24	6.0E+24	9.0E+24	1.4E+25
1.0E+25	1.4E+25	2.1E+25	3.2E+25	4.8E+25	7.2E+25	1.1E+26	1.6E+26	2.4E+26	3.6E+26	5.4E+26	8.1E+26	1.2E+27	1.8E+27	2.7E+27	4.0E+27
3.4E+27	4.8E+27	7.1E+27	1.1E+28	1.6E+28	2.4E+28	3.6E+28	5.4E+28	8.1E+28	1.2E+29	1.8E+29	2.7E+29	4.0E+29	6.0E+29	9.0E+29	1.4E+30
1.0E+30	1.4E+30	2.1E+30	3.2E+30	4.8E+30	7.2E+30	1.1E+31	1.6E+31	2.4E+31	3.6E+31	5.4E+31	8.1E+31	1.2E+32	1.8E+32	2.7E+32	4.0E+32
3.4E+32	4.8E+32	7.1E+32	1.1E+33	1.6E+33	2.4E+33	3.6E+33	5.4E+33	8.1E+33	1.2E+34	1.8E+34	2.7E+34	4.0E+34	6.0E+34	9.0E+34	1.4E+35
1.0E+35	1.4E+35	2.1E+35	3.2E+35	4.8E+35	7.2E+35	1.1E+36	1.6E+36	2.4E+36	3.6E+36	5.4E+36	8.1E+36	1.2E+37	1.8E+37	2.7E+37	4.0E+37
3.4E+37	4.8E+37	7.1E+37	1.1E+38	1.6E+38	2.4E+38	3.6E+38	5.4E+38	8.1E+38	1.2E+39	1.8E+39	2.7E+39	4.0E+39	6.0E+39	9.0E+39	1.4E+40
1.0E+40	1.4E+40	2.1E+40	3.2E+40	4.8E+40	7.2E+40	1.1E+41	1.6E+41	2.4E+41	3.6E+41	5.4E+41	8.1E+41	1.2E+42	1.8E+42	2.7E+42	4.0E+42
3.4E+42	4.8E+42	7.1E+42	1.1E+43	1.6E+43	2.4E+43	3.6E+43	5.4E+43	8.1E+43	1.2E+44	1.8E+44	2.7E+44	4.0E+44	6.0E+44	9.0E+44	1.4E+45
1.0E+45	1.4E+45	2.1E+45	3.2E+45	4.8E+45	7.2E+45	1.1E+46	1.6E+46	2.4E+46	3.6E+46	5.4E+46	8.1E+46	1.2E+47	1.8E+47	2.7E+47	4.0E+47
3.4E+47	4.8E+47	7.1E+47	1.1E+48	1.6E+48	2.4E+48	3.6E+48	5.4E+48	8.1E+48	1.2E+49	1.8E+49	2.7E+49	4.0E+49	6.0E+49	9.0E+49	1.4E+50
1.0E+50	1.4E+50	2.1E+50	3.2E+50	4.8E+50	7.2E+50	1.1E+51	1.6E+51	2.4E+51	3.6E+51	5.4E+51	8.1E+51	1.2E+52	1.8E+52	2.7E+52	4.0E+52
3.4E+52	4.8E+52	7.1E+52	1.1E+53	1.6E+53	2.4E+53	3.6E+53	5.4E+53	8.1E+53	1.2E+54	1.8E+54	2.7E+54	4.0E+54	6.0E+54	9.0E+54	1.4E+55
1.0E+55	1.4E+55	2.1E+55	3.2E+55	4.8E+55	7.2E+55	1.1E+56	1.6E+56	2.4E+56	3.6E+56	5.4E+56	8.1E+56	1.2E+57	1.8E+57	2.7E+57	4.0E+57
3.4E+57	4.8E+57	7.1E+57	1.1E+58	1.6E+58	2.4E+58	3.6E+58	5.4E+58	8.1E+58	1.2E+59	1.8E+59	2.7E+59	4.0E+59	6.0E+59	9.0E+59	1.4E+60
1.0E+60	1.4E+60	2.1E+60	3.2E+60	4.8E+60	7.2E+60	1.1E+61	1.6E+61	2.4E+61	3.6E+61	5.4E+61	8.1E+61	1.2E+62	1.8E+62	2.7E+62	4.0E+62
3.4E+62	4.8E+62	7.1E+62	1.1E+63	1.6E+63	2.4E+63	3.6E+63	5.4E+63	8.1E+63	1.2E+64	1.8E+64	2.7E+64	4.0E+64	6.0E+64	9.0E+64	1.4E+65
1.0E+65	1.4E+65	2.1E+65	3.2E+65	4.8E+65	7.2E+65	1.1E+66	1.6E+66	2.4E+66	3.6E+66	5.4E+66	8.1E+66	1.2E+67	1.8E+67	2.7E+67	4.0E+67
3.4E+67	4.8E+67	7.1E+67	1.1E+68	1.6E+68	2.4E+68	3.6E+68	5.4E+68	8.1E+68	1.2E+69	1.8E+69	2.7E+69	4.0E+69	6.0E+69	9.0E+69	1.4E+70
1.0E+70	1.4E+70	2.1E+70	3.2E+70	4.8E+70	7.2E+70	1.1E+71	1.6E+71	2.4E+71	3.6E+71	5.4E+71	8.1E+71	1.2E+72	1.8E+72	2.7E+72	4.0E+72
3.4E+72	4.8E+72	7.1E+72	1.1E+73	1.6E+73	2.4E+73	3.6E+73	5.4E+73	8.1E+73	1.2E+74	1.8E+74	2.7E+74	4.0E+74	6.0E+74	9.0E+74	1.4E+75
1.0E+75	1.4E+75	2.1E+75	3.2E+75	4.8E+75	7.2E+75	1.1E+76	1.6E+76	2.4E+76	3.6E+76	5.4E+76	8.1E+76	1.2E+77	1.8E+77	2.7E+77	4.0E+77
3.4E+77	4.8E+77	7.1E+77	1.1E+78	1.6E+78	2.4E+78	3.6E+78	5.4E+78	8.1E+78	1.2E+79	1.8E+79	2.7E+79	4.0E+79	6.0E+79	9.0E+79	1.4E+80
1.0E+80	1.4E+80	2.1E+80	3.2E+80	4.8E+80	7.2E+80	1.1E+81	1.6E+81	2.4E+81	3.6E+81	5.4E+81	8.1E+81	1.2E+82	1.8E+82	2.7E+82	4.0E+82
3.4E+82	4.8E+82	7.1E+82	1.1E+83	1.6E+83	2.4E+83	3.6E+83	5.4E+83	8.1E+83	1.2E+84	1.8E+84	2.7E+84	4.0E+84	6.0E+84	9.0E+84	1.4E+85
1.0E+85	1.4E+85	2.1E+85	3.2E+85	4.8E+85	7.2E+85	1.1E+86	1.6E+86	2.4E+86	3.6E+86	5.4E+86	8.1E+86	1.2E+87	1.8E+87	2.7E+87	4.0E+87
3.4E+87	4.8E+87	7.1E+87	1.1E+88	1.6E+88	2.4E+88	3.6E+88	5.4E+88	8.1E+88	1.2E+89	1.8E+89	2.7E+89	4.0E+89	6.0E+89	9.0E+89	1.4E+90
1.0E+90	1.4E+90	2.1E+90	3.2E+90	4.8E+90	7.2E+90	1.1E+91	1.6E+91	2.4E+91	3.6E+91	5.4E+91	8.1E+91	1.2E+92	1.8E+92	2.7E+92	4.0E+92
3.4E+92	4.8E+92	7.1E+92	1.1E+93	1.6E+93	2.4E+93	3.6E+93	5.4E+93	8.1E+93	1.2E+94	1.8E+94	2.7E+94	4.0E+94	6.0E+94	9.0E+94	1.4E+95
1.0E+95	1.4E+95	2.1E+95	3.2E+95	4.8E+95	7.2E+95	1.1E+96	1.6E+96	2.4E+96	3.6E+96	5.4E+96	8.1E+96	1.2E+97	1.8E+97	2.7E+97	4.0E+97
3.4E+97	4.8E+97	7.1E+97	1.1E+98	1.6E+98	2.4E+98	3.6E+98	5.4E+98	8.1E+98	1.2E+99	1.8E+99	2.7E+99	4.0E+99	6.0E+99	9.0E+99	1.4E+100
1.0E+100	1.4E+100	2.1E+100	3.2E+100	4.8E+100	7.2E+100	1.1E+101	1.6E+101	2.4E+101	3.6E+101	5.4E+101	8.1E+101	1.2E+102	1.8E+102	2.7E+102	4.0E+102
3.4E+102	4.8E+102	7.1E+102	1.1E+103	1.6E+103	2.4E+103	3.6E+103	5.4E+103	8.1E+103	1.2E+104	1.8E+104	2.7E+104	4.0E+104	6.0E+104	9.0E+104	1.4E+105
1.0E+105	1.4E+105	2.1E+105	3.2E+105	4.8E+105	7.2E+105	1.1E+106	1.6E+106	2.4E+106	3.6E+106	5.4E+106	8.1E+106	1.2E+107	1.8E+107	2.7E+107	4.0E+107
3.4E+107	4.8E+107	7.1E+107	1.1E+108	1.6E+108	2.4E+108	3.6E+108	5.4E+108	8.1E+108	1.2E+109	1.8E+109	2.7E+109	4.0E+109	6.0E+109	9.0E+109	1.4E+110
1.0E+110	1.4E+110	2.1E+110	3.2E+110	4.8E+110	7.2E+110	1.1E+111	1.6E+111	2.4E+111	3.6E+111	5.4E+111	8.1E+111	1.2E+112	1.8E+112	2.7E+112	4.0E+112
3.4E+112	4.8E+112	7.1E+112	1.1E+113	1.6E+113	2.4E+113	3.6E+113	5.4E+113	8.1E+113	1.2E+114	1.8E+114	2.7E+114	4.0E+114	6.0E+114	9.0E+114	1.4E+115
1.0E+115	1.4E+115	2.1E+115	3.2E+115	4.8E+115	7.2E+115	1.1E+116	1.6E+116	2.4E+116	3.6E+116	5.4E+116	8.1E+116	1.2E+117	1.8E+117	2.7E+117	4.0E+117
3.4E+117	4.8E+117	7.1E+117	1.1E+118	1.6E+118	2.4E+118	3.6E+118	5.4E+118	8.1E+118	1.2E+119	1.8E+119	2.7E+119	4.0E+119	6.0E+119	9.0E+119	1.4E+120
1.0E+120	1.4E+120	2.1E+120	3.2E+120	4.8E+120	7.2E+120	1.1E+121	1.6E+121	2.4E+121	3.6E+121	5.4E+121	8.1E+121	1.2E+122	1.8E+122	2.7E+122	4.0E+122
3.4E+122	4.8E+122	7.1E+122	1.1E+123	1.6E+123	2.4E+123	3.6E+123	5.4E+123	8.1E+123	1.2E+124	1.8E+124	2.7E+124	4.0E+124	6.0E+124	9.0E+124	1.4E+125
1.0E+125	1.4E+125	2.1E+125	3.2E+125	4.8E+125	7.2E+125	1.1E+126	1.6E+126	2.4E+126	3.6E+126	5.4E+126	8.1E+126	1.2E+127	1.8E+127	2.7E+127	4.0E+127
3.4E+127	4.8E+127	7.1E+127	1.1E+128	1.6E+128	2.4E+128	3.6E+128	5.4E+128	8.1E+128	1.2E+129	1.8E+129	2.7E+129	4.0E+129	6.0E+129	9.0E+129	1.4E+130
1.0E+130	1.4E+130	2.1E+130	3.2E+130	4.8E+130											

Table 3 of §63.1215: 1-Hour Average HCl-Equivalent Emission Rates (lb/hr)—Flat Terrain
Distance to property boundary (m)

Stack Diameter (m)	30	50	70	100	200	300	500	700	1000	2000	3000	5000
Stack Diameter = 0.3 m												
Stack Height (m)	5	3.0E+00	5.1E+00	7.0E+00	9.0E+00	1.0E+01	4.0E+01	5.0E+01	6.0E+01	1.1E+02	1.0E+02	1.0E+02
	10	9.7E+00	9.9E+00	1.1E+01	1.4E+01	2.0E+01	2.0E+01	3.0E+01	3.0E+01	4.0E+01	4.0E+01	5.0E+01
	20	2.2E+01	2.2E+01	2.2E+01	2.2E+01	2.2E+01	2.2E+01	2.2E+01	2.2E+01	2.2E+01	2.2E+01	2.2E+01
	30	3.0E+01	3.0E+01	3.0E+01	3.0E+01	3.0E+01	3.0E+01	3.0E+01	3.0E+01	3.0E+01	3.0E+01	3.0E+01
Stack Diameter = 0.5 m												
Stack Height (m)	5	6.0E+00	9.0E+00	1.0E+01	1.0E+01	1.0E+01	4.0E+01	5.0E+01	6.0E+01	1.0E+02	1.0E+02	1.0E+02
	10	1.3E+01	1.4E+01	1.5E+01	2.0E+01	3.0E+01	3.0E+01	5.0E+01	5.0E+01	7.0E+01	7.0E+01	8.0E+01
	20	3.0E+01	3.0E+01	3.0E+01	3.0E+01	3.0E+01	3.0E+01	3.0E+01	3.0E+01	3.0E+01	3.0E+01	3.0E+01
	30	5.0E+01	5.0E+01	5.0E+01	5.0E+01	5.0E+01	5.0E+01	5.0E+01	5.0E+01	5.0E+01	5.0E+01	5.0E+01
Stack Diameter = 1.0 m												
Stack Height (m)	5	3.0E+01	3.4E+01	5.1E+01	6.0E+01	9.0E+01	1.2E+02	1.7E+02	2.2E+02	2.2E+02	2.2E+02	2.2E+02
	10	6.0E+01	6.0E+01	7.0E+01	7.0E+01	9.0E+01	1.2E+02	1.2E+02	1.2E+02	1.2E+02	1.2E+02	1.2E+02
	20	9.0E+01	9.0E+01	9.0E+01	9.0E+01	9.0E+01	9.0E+01	9.0E+01	9.0E+01	9.0E+01	9.0E+01	9.0E+01
	30	1.2E+02	1.2E+02	1.2E+02	1.2E+02	1.2E+02	1.2E+02	1.2E+02	1.2E+02	1.2E+02	1.2E+02	1.2E+02
Stack Diameter = 1.5 m												
Stack Height (m)	5	3.0E+01	5.0E+01	7.0E+01	9.0E+01	1.2E+02	1.2E+02	1.2E+02	1.2E+02	1.2E+02	1.2E+02	1.2E+02
	10	7.0E+01	7.0E+01	7.0E+01	7.0E+01	7.0E+01	7.0E+01	7.0E+01	7.0E+01	7.0E+01	7.0E+01	7.0E+01
	20	1.2E+02	1.2E+02	1.2E+02	1.2E+02	1.2E+02	1.2E+02	1.2E+02	1.2E+02	1.2E+02	1.2E+02	1.2E+02
	30	1.2E+02	1.2E+02	1.2E+02	1.2E+02	1.2E+02	1.2E+02	1.2E+02	1.2E+02	1.2E+02	1.2E+02	1.2E+02
Stack Diameter = 2.0 m												
Stack Height (m)	5	4.7E+01	6.0E+01	7.0E+01	9.0E+01	1.2E+02	1.2E+02	1.2E+02	1.2E+02	1.2E+02	1.2E+02	1.2E+02
	10	9.0E+01	9.0E+01	9.0E+01	9.0E+01	9.0E+01	9.0E+01	9.0E+01	9.0E+01	9.0E+01	9.0E+01	9.0E+01
	20	1.0E+02	1.0E+02	1.0E+02	1.0E+02	1.0E+02	1.0E+02	1.0E+02	1.0E+02	1.0E+02	1.0E+02	1.0E+02
	30	1.0E+02	1.0E+02	1.0E+02	1.0E+02	1.0E+02	1.0E+02	1.0E+02	1.0E+02	1.0E+02	1.0E+02	1.0E+02
Stack Diameter = 3.0 m												
Stack Height (m)	5	6.2E+01	6.2E+01	7.0E+01	9.0E+01	1.2E+02	1.2E+02	1.2E+02	1.2E+02	1.2E+02	1.2E+02	1.2E+02
	10	1.0E+02	1.0E+02	1.0E+02	1.0E+02	1.0E+02	1.0E+02	1.0E+02	1.0E+02	1.0E+02	1.0E+02	1.0E+02
	20	1.0E+02	1.0E+02	1.0E+02	1.0E+02	1.0E+02	1.0E+02	1.0E+02	1.0E+02	1.0E+02	1.0E+02	1.0E+02
	30	1.0E+02	1.0E+02	1.0E+02	1.0E+02	1.0E+02	1.0E+02	1.0E+02	1.0E+02	1.0E+02	1.0E+02	1.0E+02
Stack Diameter = 4.0 m												
Stack Height (m)	5	2.3E+02	2.3E+02	2.3E+02	2.3E+02	2.3E+02	2.3E+02	2.3E+02	2.3E+02	2.3E+02	2.3E+02	2.3E+02
	10	4.0E+02	4.0E+02	4.0E+02	4.0E+02	4.0E+02	4.0E+02	4.0E+02	4.0E+02	4.0E+02	4.0E+02	4.0E+02
	20	4.0E+02	4.0E+02	4.0E+02	4.0E+02	4.0E+02	4.0E+02	4.0E+02	4.0E+02	4.0E+02	4.0E+02	4.0E+02
	30	4.0E+02	4.0E+02	4.0E+02	4.0E+02	4.0E+02	4.0E+02	4.0E+02	4.0E+02	4.0E+02	4.0E+02	4.0E+02

[View or download PDF](#)

Table 4 of §63.1216: 1-Hour Average HCl-Equivalent Emission Rate Limits (lb/hr)--Simple Elevated Terrain
Distance to property boundary (m)

Stack Diameter = 0.3 m	30	50	70	100	200	300	500	700	1000	2000	3000	5000
Stack Height (m)	5	1.4E+00	1.9E+00	2.6E+00	3.9E+00	6.0E+00	9.4E+00	1.5E+01	2.1E+01	3.3E+01	5.1E+01	8.1E+01
10	4.0E+00	4.0E+00	4.6E+00	6.4E+00	1.0E+01	1.5E+01	2.4E+01	3.7E+01	5.4E+01	8.1E+01	1.2E+02	1.8E+02
20	1.1E+01	1.1E+01	1.1E+01	1.1E+01	1.2E+01	1.5E+01	2.4E+01	3.5E+01	5.4E+01	8.1E+01	1.2E+02	1.8E+02
30	2.3E+01	2.3E+01	2.3E+01	2.3E+01	2.7E+01	3.3E+01	5.4E+01	8.1E+01	1.2E+02	1.8E+02	2.7E+02	4.0E+02
50	7.3E+01	7.3E+01	7.3E+01	7.3E+01	7.3E+01	8.3E+01	1.1E+02	1.5E+02	2.1E+02	3.0E+02	4.5E+02	6.6E+02
Stack Diameter = 0.5 m	30	50	70	100	200	300	500	700	1000	2000	3000	5000
Stack Height (m)	5	1.9E+00	2.7E+00	3.7E+00	5.9E+00	9.4E+00	1.4E+01	1.7E+01	2.4E+01	3.5E+01	5.1E+01	7.6E+01
10	5.6E+00	5.6E+00	6.4E+00	9.4E+00	1.4E+01	2.1E+01	3.2E+01	4.8E+01	7.0E+01	1.0E+02	1.5E+02	2.2E+02
20	1.5E+01	1.6E+01	1.6E+01	1.6E+01	1.8E+01	2.4E+01	3.5E+01	5.4E+01	8.1E+01	1.2E+02	1.8E+02	2.7E+02
30	2.7E+01	2.7E+01	2.7E+01	2.7E+01	2.7E+01	3.3E+01	4.4E+01	6.6E+01	9.4E+01	1.4E+02	2.1E+02	3.0E+02
50	7.6E+01	7.6E+01	7.6E+01	7.6E+01	7.6E+01	8.3E+01	1.1E+02	1.5E+02	2.1E+02	3.0E+02	4.5E+02	6.6E+02
Stack Diameter = 1.0 m	30	50	70	100	200	300	500	700	1000	2000	3000	5000
Stack Height (m)	5	1.0E+01	1.0E+01	1.2E+01	1.7E+01	2.6E+01	3.9E+01	5.8E+01	8.1E+01	1.2E+02	1.8E+02	2.7E+02
10	2.9E+01	2.9E+01	2.9E+01	2.9E+01	3.5E+01	4.8E+01	7.0E+01	1.0E+02	1.5E+02	2.2E+02	3.0E+02	4.5E+02
20	4.2E+01	4.2E+01	4.2E+01	4.2E+01	4.2E+01	5.0E+01	7.0E+01	1.0E+02	1.5E+02	2.2E+02	3.0E+02	4.5E+02
30	8.1E+01	8.1E+01	8.1E+01	8.1E+01	8.1E+01	9.4E+01	1.3E+02	1.7E+02	2.4E+02	3.5E+02	5.1E+02	7.6E+02
50	2.3E+02	2.3E+02	2.3E+02	2.3E+02	2.3E+02	2.7E+02	3.5E+02	5.4E+02	8.1E+02	1.2E+03	1.8E+03	2.7E+03
Stack Diameter = 1.5 m	30	50	70	100	200	300	500	700	1000	2000	3000	5000
Stack Height (m)	5	2.1E+01	2.1E+01	2.1E+01	2.1E+01	2.1E+01	2.1E+01	2.1E+01	2.1E+01	2.1E+01	2.1E+01	2.1E+01
10	3.3E+01	3.3E+01	3.3E+01	3.3E+01	3.3E+01	3.3E+01	3.3E+01	3.3E+01	3.3E+01	3.3E+01	3.3E+01	3.3E+01
20	5.3E+01	5.3E+01	5.3E+01	5.3E+01	5.3E+01	5.3E+01	5.3E+01	5.3E+01	5.3E+01	5.3E+01	5.3E+01	5.3E+01
30	1.0E+02	1.0E+02	1.0E+02	1.0E+02	1.0E+02	1.0E+02	1.0E+02	1.0E+02	1.0E+02	1.0E+02	1.0E+02	1.0E+02
50	2.7E+02	2.7E+02	2.7E+02	2.7E+02	2.7E+02	2.7E+02	2.7E+02	2.7E+02	2.7E+02	2.7E+02	2.7E+02	2.7E+02
Stack Diameter = 2.0 m	30	50	70	100	200	300	500	700	1000	2000	3000	5000
Stack Height (m)	5	2.7E+01	2.7E+01	2.7E+01	2.7E+01	2.7E+01	2.7E+01	2.7E+01	2.7E+01	2.7E+01	2.7E+01	2.7E+01
10	4.0E+01	4.0E+01	4.0E+01	4.0E+01	4.0E+01	4.0E+01	4.0E+01	4.0E+01	4.0E+01	4.0E+01	4.0E+01	4.0E+01
20	6.0E+01	6.0E+01	6.0E+01	6.0E+01	6.0E+01	6.0E+01	6.0E+01	6.0E+01	6.0E+01	6.0E+01	6.0E+01	6.0E+01
30	1.2E+02	1.2E+02	1.2E+02	1.2E+02	1.2E+02	1.2E+02	1.2E+02	1.2E+02	1.2E+02	1.2E+02	1.2E+02	1.2E+02
50	3.3E+02	3.3E+02	3.3E+02	3.3E+02	3.3E+02	3.3E+02	3.3E+02	3.3E+02	3.3E+02	3.3E+02	3.3E+02	3.3E+02
Stack Diameter = 3.0 m	30	50	70	100	200	300	500	700	1000	2000	3000	5000
Stack Height (m)	5	3.0E+01	3.0E+01	3.0E+01	3.0E+01	3.0E+01	3.0E+01	3.0E+01	3.0E+01	3.0E+01	3.0E+01	3.0E+01
10	4.0E+01	4.0E+01	4.0E+01	4.0E+01	4.0E+01	4.0E+01	4.0E+01	4.0E+01	4.0E+01	4.0E+01	4.0E+01	4.0E+01
20	6.0E+01	6.0E+01	6.0E+01	6.0E+01	6.0E+01	6.0E+01	6.0E+01	6.0E+01	6.0E+01	6.0E+01	6.0E+01	6.0E+01
30	1.2E+02	1.2E+02	1.2E+02	1.2E+02	1.2E+02	1.2E+02	1.2E+02	1.2E+02	1.2E+02	1.2E+02	1.2E+02	1.2E+02
50	3.3E+02	3.3E+02	3.3E+02	3.3E+02	3.3E+02	3.3E+02	3.3E+02	3.3E+02	3.3E+02	3.3E+02	3.3E+02	3.3E+02
Stack Diameter = 4.0 m	30	50	70	100	200	300	500	700	1000	2000	3000	5000
Stack Height (m)	5	3.0E+01	3.0E+01	3.0E+01	3.0E+01	3.0E+01	3.0E+01	3.0E+01	3.0E+01	3.0E+01	3.0E+01	3.0E+01
10	4.0E+01	4.0E+01	4.0E+01	4.0E+01	4.0E+01	4.0E+01	4.0E+01	4.0E+01	4.0E+01	4.0E+01	4.0E+01	4.0E+01
20	6.0E+01	6.0E+01	6.0E+01	6.0E+01	6.0E+01	6.0E+01	6.0E+01	6.0E+01	6.0E+01	6.0E+01	6.0E+01	6.0E+01
30	1.2E+02	1.2E+02	1.2E+02	1.2E+02	1.2E+02	1.2E+02	1.2E+02	1.2E+02	1.2E+02	1.2E+02	1.2E+02	1.2E+02
50	3.3E+02	3.3E+02	3.3E+02	3.3E+02	3.3E+02	3.3E+02	3.3E+02	3.3E+02	3.3E+02	3.3E+02	3.3E+02	3.3E+02

[View or download PDF](#)

[70 FR 59565, Oct. 12, 2005, as amended at 73 FR 18982, Apr. 8, 2008; 73 FR 64097, Oct. 28, 2008]

Emissions Standards and Operating Limits for Solid Fuel Boilers, Liquid Fuel Boilers, and Hydrochloric Acid Production Furnaces

§ 63.1216 What are the standards for solid fuel boilers that burn hazardous waste?

(a) *Emission limits for existing sources.* You must not discharge or cause combustion gases to be emitted into the atmosphere that contain:

- (1) For dioxins and furans, either carbon monoxide or hydrocarbon emissions in excess of the limits provided by paragraph (a)(5) of this section;
- (2) Mercury in excess of 11 µgm/dscm corrected to 7 percent oxygen;
- (3) For cadmium and lead combined, except for an area source as defined under § 63.2, emissions in excess of 180 µgm/dscm, corrected to 7 percent oxygen;
- (4) For arsenic, beryllium, and chromium combined, except for an area source as defined under § 63.2, emissions in excess of 380 µgm/dscm, corrected to 7 percent oxygen;
- (5) For carbon monoxide and hydrocarbons, either:
 - (i) Carbon monoxide in excess of 100 parts per million by volume, over an hourly rolling average (monitored continuously with a continuous emissions monitoring system), dry basis and corrected to 7

percent oxygen. If you elect to comply with this carbon monoxide standard rather than the hydrocarbon standard under paragraph (a)(5)(ii) of this section, you must also document that, during the destruction and removal efficiency (DRE) test runs or their equivalent as provided by § 63.1206(b)(7), hydrocarbons do not exceed 10 parts per million by volume during those runs, over an hourly rolling average (monitored continuously with a continuous emissions monitoring system), dry basis, corrected to 7 percent oxygen, and reported as propane; or

(ii) Hydrocarbons in excess of 10 parts per million by volume, over an hourly rolling average (monitored continuously with a continuous emissions monitoring system), dry basis, corrected to 7 percent oxygen, and reported as propane;

(6) For hydrogen chloride and chlorine combined, except for an area source as defined under § 63.2, emissions in excess of 440 parts per million by volume, expressed as a chloride ($\text{Cl}^{(-)}$) equivalent, dry basis and corrected to 7 percent oxygen; and

(7) For particulate matter, except for an area source as defined under § 63.2 or as provided by paragraph (e) of this section, emissions in excess of 68 mg/dscm corrected to 7 percent oxygen.

(b) *Emission limits for new sources.* You must not discharge or cause combustion gases to be emitted into the atmosphere that contain:

(1) For dioxins and furans, either carbon monoxide or hydrocarbon emissions in excess of the limits provided by paragraph (b)(5) of this section;

(2) Mercury in excess of 11 $\mu\text{g}/\text{dscm}$ corrected to 7 percent oxygen;

(3) For cadmium and lead combined, except for an area source as defined under § 63.2, emissions in excess of 180 $\mu\text{g}/\text{dscm}$, corrected to 7 percent oxygen;

(4) For arsenic, beryllium, and chromium combined, except for an area source as defined under § 63.2, emissions in excess of 190 $\mu\text{g}/\text{dscm}$, corrected to 7 percent oxygen;

(5) For carbon monoxide and hydrocarbons, either:

(i) Carbon monoxide in excess of 100 parts per million by volume, over an hourly rolling average (monitored continuously with a continuous emissions monitoring system), dry basis and corrected to 7 percent oxygen. If you elect to comply with this carbon monoxide standard rather than the hydrocarbon standard under paragraph (b)(5)(ii) of this section, you must also document that, during the destruction and removal efficiency (DRE) test runs or their equivalent as provided by § 63.1206(b)(7), hydrocarbons do not exceed 10 parts per million by volume during those runs, over an hourly rolling average (monitored continuously with a continuous emissions monitoring system), dry basis, corrected to 7 percent oxygen, and reported as propane; or

(ii) Hydrocarbons in excess of 10 parts per million by volume, over an hourly rolling average (monitored continuously with a continuous emissions monitoring system), dry basis, corrected to 7 percent oxygen, and reported as propane;

(6) For hydrogen chloride and chlorine combined, except for an area source as defined under § 63.2, emissions in excess of 73 parts per million by volume, expressed as a chloride ($\text{Cl}^{(-)}$) equivalent, dry basis and corrected to 7 percent oxygen; and

(7) For particulate matter, except for an area source as defined under § 63.2 or as provided by paragraph (e) of this section, emissions in excess of 34 mg/dscm corrected to 7 percent oxygen.

(c) *Destruction and removal efficiency (DRE) standard* —(1) 99.99% DRE. Except as provided in paragraph (c)(2) of this section, you must achieve a DRE of 99.99% for each principle organic hazardous constituent (POHC) designated under paragraph (c)(3) of this section. You must calculate DRE for each POHC from the following equation:

$$DRE = [1 - (W_{out} \div W_{in})] \times 100\%$$

Where:

W_{in} = mass feedrate of one POHC in a waste feedstream; and

W_{out} = mass emission rate of the same POHC present in exhaust emissions prior to release to the atmosphere.

(2) *99.9999% DRE.* If you burn the dioxin-listed hazardous wastes F020, F021, F022, F023, F026, or F027 (see § 261.31 of this chapter), you must achieve a DRE of 99.9999% for each POHC that you designate under paragraph (c)(3) of this section. You must demonstrate this DRE performance on POHCs that are more difficult to incinerate than tetra-, penta-, and hexachlorodibenzo- *p* -dioxins and dibenzofurans. You must use the equation in paragraph (c)(1) of this section to calculate DRE for each POHC. In addition, you must notify the Administrator of your intent to incinerate hazardous wastes F020, F021, F022, F023, F026, or F027.

(3) *Principal organic hazardous constituents (POHCs).* (i) You must treat the POHCs in the waste feed that you specify under paragraph (c)(3)(ii) of this section to the extent required by paragraphs (c) (1) and (c)(2) of this section.

(ii) You must specify one or more POHCs that are representative of the most difficult to destroy organic compounds in your hazardous waste feedstream. You must base this specification on the degree of difficulty of incineration of the organic constituents in the hazardous waste and on their concentration or mass in the hazardous waste feed, considering the results of hazardous waste analyses or other data and information.

(d) *Significant figures.* The emission limits provided by paragraphs (a) and (b) of this section are presented with two significant figures. Although you must perform intermediate calculations using at least three significant figures, you may round the resultant emission levels to two significant figures to document compliance.

(e) *Alternative to the particulate matter standard —(1) General.* In lieu of complying with the particulate matter standards of this section, you may elect to comply with the following alternative metal emission control requirement:

(2) *Alternative metal emission control requirements for existing solid fuel boilers.* (i) You must not discharge or cause combustion gases to be emitted into the atmosphere that contain cadmium, lead, and selenium in excess of 180 $\mu\text{gm/dscm}$, combined emissions, corrected to 7 percent oxygen; and,

(ii) You must not discharge or cause combustion gases to be emitted into the atmosphere that contain antimony, arsenic, beryllium, chromium, cobalt, manganese, and nickel in excess of 380 $\mu\text{gm/dscm}$, combined emissions, corrected to 7 percent oxygen.

(3) *Alternative metal emission control requirements for new solid fuel boilers.* (i) You must not discharge or cause combustion gases to be emitted into the atmosphere that contain cadmium, lead, and selenium in excess of 180 $\mu\text{gm/dscm}$, combined emissions, corrected to 7 percent oxygen; and,

(ii) You must not discharge or cause combustion gases to be emitted into the atmosphere that contain antimony, arsenic, beryllium, chromium, cobalt, manganese, and nickel in excess of 190 $\mu\text{gm/dscm}$, combined emissions, corrected to 7 percent oxygen.

(4) *Operating limits.* Semivolatile and low volatile metal operating parameter limits must be established to ensure compliance with the alternative emission limitations described in paragraphs (e) (2) and (e)(3) of this section pursuant to § 63.1209(n), except that semivolatile metal feedrate limits apply to lead, cadmium, and selenium, combined, and low volatile metal feedrate limits apply to arsenic, beryllium, chromium, antimony, cobalt, manganese, and nickel, combined.

(f) *Elective standards for area sources.* Area sources as defined under § 63.2 are subject to the standards for cadmium and lead, the standards for arsenic, beryllium, and chromium, the standards for hydrogen chloride and chlorine, and the standards for particulate matter under this section if they elect

under § 266.100(b)(3) of this chapter to comply with those standards in lieu of the standards under 40 CFR 266.105, 266.106, and 266.107 to control those pollutants.

[70 FR 59565, Oct. 12, 2005]

§ 63.1217 What are the standards for liquid fuel boilers that burn hazardous waste?

(a) *Emission limits for existing sources.* You must not discharge or cause combustion gases to be emitted into the atmosphere that contain:

(1)(i) Dioxins and furans in excess of 0.40 ng TEQ/dscm, corrected to 7 percent oxygen, for liquid fuel boilers equipped with a dry air pollution control system; or

(ii) Either carbon monoxide or hydrocarbon emissions in excess of the limits provided by paragraph (a)(5) of this section for sources not equipped with a dry air pollution control system;

(iii) A source equipped with a wet air pollution control system followed by a dry air pollution control system is not considered to be a dry air pollution control system, and a source equipped with a dry air pollution control system followed by a wet air pollution control system is considered to be a dry air pollution control system for purposes of this emission limit;

(2) For mercury, except as provided for in paragraph (a)(2)(iii) of this section:

(i) When you burn hazardous waste with an as-fired heating value less than 10,000 Btu/lb, emissions in excess of 19 µgm/dscm, corrected to 7 percent oxygen, on an (not-to-exceed) annual averaging period;

(ii) When you burn hazardous waste with an as-fired heating value 10,000 Btu/lb or greater, emissions in excess of 4.2×10^{-5} lbs mercury attributable to the hazardous waste per million Btu heat input from the hazardous waste on an (not-to-exceed) annual averaging period;

(iii) The boiler operated by Diversified Scientific Services, Inc. with EPA identification number TND982109142, and which burns radioactive waste mixed with hazardous waste, must comply with the mercury emission standard under § 63.1219(a)(2);

(3) For cadmium and lead combined, except for an area source as defined under § 63.2,

(i) When you burn hazardous waste with an as-fired heating value less than 10,000 Btu/lb, emissions in excess of 150 µgm/dscm, corrected to 7 percent oxygen, on an (not-to-exceed) annual averaging period;

(ii) When you burn hazardous waste with an as-fired heating value of 10,000 Btu/lb or greater, emissions in excess of 8.2×10^{-5} lbs combined cadmium and lead emissions attributable to the hazardous waste per million Btu heat input from the hazardous waste on an (not-to-exceed) annual averaging period;

(4) For chromium, except for an area source as defined under § 63.2:

(i) When you burn hazardous waste with an as-fired heating value less than 10,000 Btu/lb, emissions in excess of 370 µgm/dscm, corrected to 7 percent oxygen;

(ii) When you burn hazardous waste with an as-fired heating value of 10,000 Btu/lb or greater, emissions in excess of 1.3×10^{-4} lbs chromium emissions attributable to the hazardous waste per million Btu heat input from the hazardous waste;

(5) For carbon monoxide and hydrocarbons, either:

(i) Carbon monoxide in excess of 100 parts per million by volume, over an hourly rolling average (monitored continuously with a continuous emissions monitoring system), dry basis and corrected to 7 percent oxygen. If you elect to comply with this carbon monoxide standard rather than the

hydrocarbon standard under paragraph (a)(5)(ii) of this section, you must also document that, during the destruction and removal efficiency (DRE) test runs or their equivalent as provided by § 63.1206(b) (7), hydrocarbons do not exceed 10 parts per million by volume during those runs, over an hourly rolling average (monitored continuously with a continuous emissions monitoring system), dry basis, corrected to 7 percent oxygen, and reported as propane; or

(ii) Hydrocarbons in excess of 10 parts per million by volume, over an hourly rolling average (monitored continuously with a continuous emissions monitoring system), dry basis, corrected to 7 percent oxygen, and reported as propane;

(6) For hydrogen chloride and chlorine, except for an area source as defined under § 63.2:

(i) When you burn hazardous waste with an as-fired heating value less than 10,000 Btu/lb, emissions in excess of 31 parts per million by volume, combined emissions, expressed as a chloride (Cl^-) equivalent, dry basis and corrected to 7 percent oxygen;

(ii) When you burn hazardous waste with an as-fired heating value of 10,000 Btu/lb or greater, emissions in excess of 5.1×10^{-2} lbs combined emissions of hydrogen chloride and chlorine gas attributable to the hazardous waste per million Btu heat input from the hazardous waste;

(7) For particulate matter, except for an area source as defined under § 63.2 or as provided by paragraph (e) of this section, emissions in excess of 80 mg/dscm corrected to 7 percent oxygen.

(b) *Emission limits for new sources.* You must not discharge or cause combustion gases to be emitted into the atmosphere that contain:

(1)(i) Dioxins and furans in excess of 0.40 ng TEQ/dscm, corrected to 7 percent oxygen, for liquid fuel boilers equipped with a dry air pollution control system; or

(ii) Either carbon monoxide or hydrocarbon emissions in excess of the limits provided by paragraph (b)(5) of this section for sources not equipped with a dry air pollution control system;

(iii) A source equipped with a wet air pollution control system followed by a dry air pollution control system is not considered to be a dry air pollution control system, and a source equipped with a dry air pollution control system followed by a wet air pollution control system is considered to be a dry air pollution control system for purposes of this emission limit;

(2) For mercury:

(i) When you burn hazardous waste with an as-fired heating value less than 10,000 Btu/lb, emissions in excess of 6.8 $\mu\text{gm/dscm}$, corrected to 7 percent oxygen, on an (not-to-exceed) annual averaging period;

(ii) When you burn hazardous waste with an as-fired heating value of 10,000 Btu/lb or greater, emissions in excess of 1.2×10^{-6} lbs mercury emissions attributable to the hazardous waste per million Btu heat input from the hazardous waste on an (not-to-exceed) annual averaging period;

(3) For cadmium and lead combined, except for an area source as defined under § 63.2:

(i) When you burn hazardous waste with an as-fired heating value less than 10,000 Btu/lb, emissions in excess of 78 $\mu\text{gm/dscm}$, corrected to 7 percent oxygen, on an (not-to-exceed) annual averaging period;

(ii) When you burn hazardous waste with an as-fired heating value greater than or equal to 10,000 Btu/lb, emissions in excess of 6.2×10^{-6} lbs combined cadmium and lead emissions attributable to the hazardous waste per million Btu heat input from the hazardous waste on an (not-to-exceed) annual averaging period;

(4) For chromium, except for an area source as defined under § 63.2:

(i) When you burn hazardous waste with an as-fired heating value less than 10,000 Btu/lb, emissions in excess of 12 $\mu\text{gm/dscm}$, corrected to 7 percent oxygen;

(ii) When you burn hazardous waste with an as-fired heating value of 10,000 Btu/lb or greater, emissions in excess of 1.4×10^{-5} lbs chromium emissions attributable to the hazardous waste per million Btu heat input from the hazardous waste;

(5) For carbon monoxide and hydrocarbons, either:

(i) Carbon monoxide in excess of 100 parts per million by volume, over an hourly rolling average (monitored continuously with a continuous emissions monitoring system), dry basis and corrected to 7 percent oxygen. If you elect to comply with this carbon monoxide standard rather than the hydrocarbon standard under paragraph (b)(5)(ii) of this section, you must also document that, during the destruction and removal efficiency (DRE) test runs or their equivalent as provided by § 63.1206(b)(7), hydrocarbons do not exceed 10 parts per million by volume during those runs, over an hourly rolling average (monitored continuously with a continuous emissions monitoring system), dry basis, corrected to 7 percent oxygen, and reported as propane; or

(ii) Hydrocarbons in excess of 10 parts per million by volume, over an hourly rolling average (monitored continuously with a continuous emissions monitoring system), dry basis, corrected to 7 percent oxygen, and reported as propane;

(6) For hydrogen chloride and chlorine, except for an area source as defined under § 63.2:

(i) When you burn hazardous waste with an as-fired heating value less than 10,000 Btu/lb, emissions in excess of 31 parts per million by volume, combined emissions, expressed as a chloride (Cl^-) equivalent, dry basis and corrected to 7 percent oxygen;

(ii) When you burn hazardous waste with an as-fired heating value of 10,000 Btu/lb or greater, emissions in excess of 5.1×10^{-2} lbs combined emissions of hydrogen chloride and chlorine gas attributable to the hazardous waste per million Btu heat input from the hazardous waste;

(7) For particulate matter, except for an area source as defined under § 63.2 or as provided by paragraph (e) of this section, emissions in excess of 20 mg/dscm corrected to 7 percent oxygen.

(c) *Destruction and removal efficiency (DRE) standard* —(1) *99.99% DRE*. Except as provided in paragraph (c)(2) of this section, you must achieve a DRE of 99.99% for each principle organic hazardous constituent (POHC) designated under paragraph (c)(3) of this section. You must calculate DRE for each POHC from the following equation:

$$\text{DRE} = [1 - (W_{\text{out}} \div W_{\text{in}})] \times 100\%$$

Where:

W_{in} = mass feedrate of one POHC in a waste feedstream; and

W_{out} = mass emission rate of the same POHC present in exhaust emissions prior to release to the atmosphere.

(2) *99.9999% DRE*. If you burn the dioxin-listed hazardous wastes F020, F021, F022, F023, F026, or F027 (see § 261.31 of this chapter), you must achieve a DRE of 99.9999% for each POHC that you designate under paragraph (c)(3) of this section. You must demonstrate this DRE performance on POHCs that are more difficult to incinerate than tetra-, penta-, and hexachlorodibenzo- *p*-dioxins and dibenzofurans. You must use the equation in paragraph (c)(1) of this section to calculate DRE for each POHC. In addition, you must notify the Administrator of your intent to incinerate hazardous wastes F020, F021, F022, F023, F026, or F027.

(3) *Principal organic hazardous constituents (POHCs)*. (i) You must treat the POHCs in the waste feed that you specify under paragraph (c)(3)(ii) of this section to the extent required by paragraphs (c)(1) and (c)(2) of this section.

(ii) You must specify one or more POHCs that are representative of the most difficult to destroy organic compounds in your hazardous waste feedstream. You must base this specification on the degree of difficulty of incineration of the organic constituents in the hazardous waste and on their concentration or mass in the hazardous waste feed, considering the results of hazardous waste analyses or other data and information.

(d) *Significant figures*. The emission limits provided by paragraphs (a) and (b) of this section are presented with two significant figures. Although you must perform intermediate calculations using at least three significant figures, you may round the resultant emission levels to two significant figures to document compliance.

(e) *Alternative to the particulate matter standard* —(1) *General*. In lieu of complying with the particulate matter standards of this section, you may elect to comply with the following alternative metal emission control requirement:

(2) *Alternative metal emission control requirements for existing liquid fuel boilers*. (i) When you burn hazardous waste with a heating value less than 10,000 Btu/lb:

(A) You must not discharge or cause combustion gases to be emitted into the atmosphere that contain cadmium, lead, and selenium, combined, in excess of 150 $\mu\text{g}/\text{dscm}$, corrected to 7 percent oxygen; and

(B) You must not discharge or cause combustion gases to be emitted into the atmosphere that contain antimony, arsenic, beryllium, chromium, cobalt, manganese, and nickel, combined, in excess of 370 $\mu\text{g}/\text{dscm}$, corrected to 7 percent oxygen;

(ii) When you burn hazardous waste with a heating value of 10,000 Btu/lb or greater:

(A) You must not discharge or cause combustion gases to be emitted into the atmosphere that contain in excess of 8.2×10^{-5} lbs combined emissions of cadmium, lead, and selenium attributable to the hazardous waste per million Btu heat input from the hazardous waste; and

(B) You must not discharge or cause combustion gases to be emitted into the atmosphere that contain either in excess of 1.3×10^{-4} lbs combined emissions of antimony, arsenic, beryllium, chromium, cobalt, manganese, and nickel attributable to the hazardous waste per million Btu heat input from the hazardous waste;

(3) *Alternative metal emission control requirements for new liquid fuel boilers*. (i) When you burn hazardous waste with a heating value less than 10,000 Btu/lb:

(A) You must not discharge or cause combustion gases to be emitted into the atmosphere that contain cadmium, lead, and selenium, combined, in excess of 78 $\mu\text{g}/\text{dscm}$, corrected to 7 percent oxygen; and

(B) You must not discharge or cause combustion gases to be emitted into the atmosphere that contain antimony, arsenic, beryllium, chromium, cobalt, manganese, and nickel, combined, in excess of 12 $\mu\text{g}/\text{dscm}$, corrected to 7 percent oxygen;

(ii) When you burn hazardous waste with a heating value greater than or equal to 10,000 Btu/lb:

(A) You must not discharge or cause combustion gases to be emitted into the atmosphere that contain in excess of 6.2×10^{-6} lbs combined emissions of cadmium, lead, and selenium attributable to the hazardous waste per million Btu heat input from the hazardous waste; and

(B) You must not discharge or cause combustion gases to be emitted into the atmosphere that contain either in excess of 1.4×10^{-5} lbs combined emissions of antimony, arsenic, beryllium, chromium, cobalt, manganese, and nickel attributable to the hazardous waste per million Btu heat input from the hazardous waste;

(4) *Operating limits.* Semivolatile and low volatile metal operating parameter limits must be established to ensure compliance with the alternative emission limitations described in paragraphs (e) (2) and (e)(3) of this section pursuant to § 63.1209(n), except that semivolatile metal feedrate limits apply to lead, cadmium, and selenium, combined, and low volatile metal feedrate limits apply to arsenic, beryllium, chromium, antimony, cobalt, manganese, and nickel, combined.

(f) *Elective standards for area sources.* Area sources as defined under § 63.2 are subject to the standards for cadmium and lead, the standards for chromium, the standards for hydrogen chloride and chlorine, and the standards for particulate matter under this section if they elect under § 266.100(b)(3) of this chapter to comply with those standards in lieu of the standards under 40 CFR 266.105, 266.106, and 266.107 to control those pollutants.

[70 FR 59567, Oct. 12, 2005, as amended at 73 FR 18983, Apr. 8, 2008]

§ 63.1218 What are the standards for hydrochloric acid production furnaces that burn hazardous waste?

(a) *Emission limits for existing sources.* You must not discharge or cause combustion gases to be emitted into the atmosphere that contain:

(1) For dioxins and furans, either carbon monoxide or hydrocarbon emissions in excess of the limits provided by paragraph (a)(5) of this section;

(2) For mercury, hydrogen chloride and chlorine gas emissions in excess of the levels provided by paragraph (a)(6) of this section;

(3) For lead and cadmium, except for an area source as defined under § 63.2, hydrogen chloride and chlorine gas emissions in excess of the levels provided by paragraph (a)(6) of this section;

(4) For arsenic, beryllium, and chromium, except for an area source as defined under § 63.2, hydrogen chloride and chlorine gas emissions in excess of the levels provided by paragraph (a)(6) of this section;

(5) For carbon monoxide and hydrocarbons, either:

(i) Carbon monoxide in excess of 100 parts per million by volume, over an hourly rolling average (monitored continuously with a continuous emissions monitoring system), dry basis and corrected to 7 percent oxygen. If you elect to comply with this carbon monoxide standard rather than the hydrocarbon standard under paragraph (a)(5)(ii) of this section, you must also document that, during the destruction and removal efficiency (DRE) test runs or their equivalent as provided by § 63.1206(b) (7), hydrocarbons do not exceed 10 parts per million by volume during those runs, over an hourly rolling average (monitored continuously with a continuous emissions monitoring system), dry basis, corrected to 7 percent oxygen, and reported as propane; or

(ii) Hydrocarbons in excess of 10 parts per million by volume, over an hourly rolling average (monitored continuously with a continuous emissions monitoring system), dry basis, corrected to 7 percent oxygen, and reported as propane;

(6) For hydrogen chloride and chlorine gas, either:

(i) Emission in excess of 150 parts per million by volume, combined emissions, expressed as a chloride ($\text{Cl}^{(-)}$) equivalent, dry basis and corrected to 7 percent oxygen; or

(ii) Emissions greater than the levels that would be emitted if the source is achieving a system removal efficiency (SRE) of less than 99.923 percent for total chlorine and chloride fed to the combustor. You must calculate SRE from the following equation:

$$\text{SRE} = [1 - (\text{Cl}_{\text{out}} / \text{Cl}_{\text{in}})] \times 100\%$$

Where:

Cl in = mass feedrate of total chlorine or chloride in all feedstreams, reported as chloride; and

Cl out = mass emission rate of hydrogen chloride and chlorine gas, reported as chloride, in exhaust emissions prior to release to the atmosphere.

(7) For particulate matter, except for an area source as defined under § 63.2, hydrogen chloride and chlorine gas emissions in excess of the levels provided by paragraph (a)(6) of this section.

(b) *Emission limits for new sources.* You must not discharge or cause combustion gases to be emitted into the atmosphere that contain:

(1) For dioxins and furans, either carbon monoxide or hydrocarbon emissions in excess of the limits provided by paragraph (b)(5) of this section;

(2) For mercury, hydrogen chloride and chlorine gas emissions in excess of the levels provided by paragraph (b)(6) of this section;

(3) For lead and cadmium, except for an area source as defined under § 63.2, hydrogen chloride and chlorine gas emissions in excess of the levels provided by paragraph (b)(6) of this section;

(4) For arsenic, beryllium, and chromium, except for an area source as defined under § 63.2, hydrogen chloride and chlorine gas emissions in excess of the levels provided by paragraph (b)(6) of this section;

(5) For carbon monoxide and hydrocarbons, either:

(i) Carbon monoxide in excess of 100 parts per million by volume, over an hourly rolling average (monitored continuously with a continuous emissions monitoring system), dry basis and corrected to 7 percent oxygen. If you elect to comply with this carbon monoxide standard rather than the hydrocarbon standard under paragraph (b)(5)(ii) of this section, you must also document that, during the destruction and removal efficiency (DRE) test runs or their equivalent as provided by § 63.1206(b)(7), hydrocarbons do not exceed 10 parts per million by volume during those runs, over an hourly rolling average (monitored continuously with a continuous emissions monitoring system), dry basis, corrected to 7 percent oxygen, and reported as propane; or

(ii) Hydrocarbons in excess of 10 parts per million by volume, over an hourly rolling average (monitored continuously with a continuous emissions monitoring system), dry basis, corrected to 7 percent oxygen, and reported as propane;

(6) For hydrogen chloride and chlorine gas, either:

(i) Emission in excess of 25 parts per million by volume, combined emissions, expressed as a chloride ($\text{Cl}^{(-)}$) equivalent, dry basis and corrected to 7 percent oxygen; or

(ii) Emissions greater than the levels that would be emitted if the source is achieving a system removal efficiency (SRE) of less than 99.987 percent for total chlorine and chloride fed to the combustor. You must calculate SRE from the following equation:

$$\text{SRE} = [1 - (\text{Cl}_{\text{out}} / \text{Cl}_{\text{in}})] \times 100\%$$

Where:

Cl in = mass feedrate of total chlorine or chloride in all feedstreams, reported as chloride; and

Cl out = mass emission rate of hydrogen chloride and chlorine gas, reported as chloride, in exhaust emissions prior to release to the atmosphere.

(7) For particulate matter, except for an area source as defined under § 63.2, hydrogen chloride and chlorine gas emissions in excess of the levels provided by paragraph (b)(6) of this section.

(c) *Destruction and removal efficiency (DRE) standard* —(1) *99.99% DRE*. Except as provided in paragraph (c)(2) of this section, you must achieve a DRE of 99.99% for each principle organic hazardous constituent (POHC) designated under paragraph (c)(3) of this section. You must calculate DRE for each POHC from the following equation:

$$\text{DRE} = [1 - (W_{\text{out}} / W_{\text{in}})] \times 100\%$$

Where:

Win = mass feedrate of one POHC in a waste feedstream; and

Wout = mass emission rate of the same POHC present in exhaust emissions prior to release to the atmosphere.

(2) *99.9999% DRE*. If you burn the dioxin-listed hazardous wastes F020, F021, F022, F023, F026, or F027 (see § 261.31 of this chapter), you must achieve a DRE of 99.9999% for each POHC that you designate under paragraph (c)(3) of this section. You must demonstrate this DRE performance on POHCs that are more difficult to incinerate than tetra-, penta-, and hexachlorodibenzo- *p* -dioxins and dibenzofurans. You must use the equation in paragraph (c)(1) of this section to calculate DRE for each POHC. In addition, you must notify the Administrator of your intent to incinerate hazardous wastes F020, F021, F022, F023, F026, or F027.

(3) *Principal organic hazardous constituents (POHCs)*. (i) You must treat the POHCs in the waste feed that you specify under paragraph (c)(3)(ii) of this section to the extent required by paragraphs (c) (1) and (c)(2) of this section.

(ii) You must specify one or more POHCs that are representative of the most difficult to destroy organic compounds in your hazardous waste feedstream. You must base this specification on the degree of difficulty of incineration of the organic constituents in the hazardous waste and on their concentration or mass in the hazardous waste feed, considering the results of hazardous waste analyses or other data and information.

(d) *Significant figures*. The emission limits provided by paragraphs (a) and (b) of this section are presented with two significant figures. Although you must perform intermediate calculations using at least three significant figures, you may round the resultant emission levels to two significant figures to document compliance.

(e) *Elective standards for area sources*. Area sources as defined under § 63.2 are subject to the standards for cadmium and lead, the standards for arsenic, beryllium, and chromium, the standards for hydrogen chloride and chlorine, and the standards for particulate matter under this section if they elect under § 266.100(b)(3) of this chapter to comply with those standards in lieu of the standards under 40 CFR 266.105, 266.106, and 266.107 to control those pollutants.

[70 FR 59569, Oct. 12, 2005]

Replacement Emissions Standards and Operating Limits for Incinerators, Cement Kilns, and Lightweight Aggregate Kilns

§ 63.1219 What are the replacement standards for hazardous waste incinerators?

(a) *Emission limits for existing sources*. You must not discharge or cause combustion gases to be emitted into the atmosphere that contain:

(1) For dioxins and furans:

(i) For incinerators equipped with either a waste heat boiler or dry air pollution control system, either:

(A) Emissions in excess of 0.20 ng TEQ/dscm, corrected to 7 percent oxygen; or

(B) Emissions in excess of 0.40 ng TEQ/dscm, corrected to 7 percent oxygen, provided that the combustion gas temperature at the inlet to the initial particulate matter control device is 400 °F or lower based on the average of the test run average temperatures. (For purposes of compliance, operation of a wet particulate matter control device is presumed to meet the 400 °F or lower requirement);

(ii) Emissions in excess of 0.40 ng TEQ/dscm, corrected to 7 percent oxygen, for incinerators not equipped with either a waste heat boiler or dry air pollution control system;

(iii) A source equipped with a wet air pollution control system followed by a dry air pollution control system is not considered to be a dry air pollution control system, and a source equipped with a dry air pollution control system followed by a wet air pollution control system is considered to be a dry air pollution control system for purposes of this standard;

(2) Mercury in excess of 130 µgm/dscm, corrected to 7 percent oxygen;

(3) Cadmium and lead in excess of 230 µgm/dscm, combined emissions, corrected to 7 percent oxygen;

(4) Arsenic, beryllium, and chromium in excess of 92 µgm/dscm, combined emissions, corrected to 7 percent oxygen;

(5) For carbon monoxide and hydrocarbons, either:

(i) Carbon monoxide in excess of 100 parts per million by volume, over an hourly rolling average (monitored continuously with a continuous emissions monitoring system), dry basis and corrected to 7 percent oxygen. If you elect to comply with this carbon monoxide standard rather than the hydrocarbon standard under paragraph (a)(5)(ii) of this section, you must also document that, during the destruction and removal efficiency (DRE) test runs or their equivalent as provided by § 63.1206(b)(7), hydrocarbons do not exceed 10 parts per million by volume during those runs, over an hourly rolling average (monitored continuously with a continuous emissions monitoring system), dry basis, corrected to 7 percent oxygen, and reported as propane; or

(ii) Hydrocarbons in excess of 10 parts per million by volume, over an hourly rolling average (monitored continuously with a continuous emissions monitoring system), dry basis, corrected to 7 percent oxygen, and reported as propane;

(6) Hydrogen chloride and chlorine gas (total chlorine) in excess of 32 parts per million by volume, combined emissions, expressed as a chloride (Cl^{-}) equivalent, dry basis and corrected to 7 percent oxygen; and

(7) Except as provided by paragraph (e) of this section, particulate matter in excess of 0.013 gr/dscf corrected to 7 percent oxygen.

(b) *Emission limits for new sources.* You must not discharge or cause combustion gases to be emitted into the atmosphere that contain:

(1)(i) Dioxins and furans in excess of 0.11 ng TEQ/dscm corrected to 7 percent oxygen for incinerators equipped with either a waste heat boiler or dry air pollution control system; or

(ii) Dioxins and furans in excess of 0.20 ng TEQ/dscm corrected to 7 percent oxygen for sources not equipped with either a waste heat boiler or dry air pollution control system;

(iii) A source equipped with a wet air pollution control system followed by a dry air pollution control system is not considered to be a dry air pollution control system, and a source equipped with a dry air

pollution control system followed by a wet air pollution control system is considered to be a dry air pollution control system for purposes of this standard;

(2) Mercury in excess of 8.1 $\mu\text{g}/\text{dscm}$, corrected to 7 percent oxygen;

(3) Cadmium and lead in excess of 10 $\mu\text{g}/\text{dscm}$, combined emissions, corrected to 7 percent oxygen;

(4) Arsenic, beryllium, and chromium in excess of 23 $\mu\text{g}/\text{dscm}$, combined emissions, corrected to 7 percent oxygen;

(5) For carbon monoxide and hydrocarbons, either:

(i) Carbon monoxide in excess of 100 parts per million by volume, over an hourly rolling average (monitored continuously with a continuous emissions monitoring system), dry basis and corrected to 7 percent oxygen. If you elect to comply with this carbon monoxide standard rather than the hydrocarbon standard under paragraph (b)(5)(ii) of this section, you must also document that, during the destruction and removal efficiency (DRE) test runs or their equivalent as provided by § 63.1206(b)(7), hydrocarbons do not exceed 10 parts per million by volume during those runs, over an hourly rolling average (monitored continuously with a continuous emissions monitoring system), dry basis, corrected to 7 percent oxygen, and reported as propane; or

(ii) Hydrocarbons in excess of 10 parts per million by volume, over an hourly rolling average (monitored continuously with a continuous emissions monitoring system), dry basis, corrected to 7 percent oxygen, and reported as propane;

(6) Hydrogen chloride and chlorine gas in excess of 21 parts per million by volume, combined emissions, expressed as a chloride (Cl^{-}) equivalent, dry basis and corrected to 7 percent oxygen; and

(7) Except as provided by paragraph (e) of this section, particulate matter emissions in excess of 0.0016 gr/dscf corrected to 7 percent oxygen.

(c) *Destruction and removal efficiency (DRE) standard* —(1) *99.99% DRE*. Except as provided in paragraph (c)(2) of this section, you must achieve a destruction and removal efficiency (DRE) of 99.99% for each principle organic hazardous constituent (POHC) designated under paragraph (c)(3) of this section. You must calculate DRE for each POHC from the following equation:

$$\text{DRE} = [1 - (W_{\text{out}} / W_{\text{in}})] \times 100\%$$

Where:

W_{in} = mass feedrate of one POHC in a waste feedstream; and

W_{out} = mass emission rate of the same POHC present in exhaust emissions prior to release to the atmosphere.

(2) *99.9999% DRE*. If you burn the dioxin-listed hazardous wastes F020, F021, F022, F023, F026, or F027 (see § 261.31 of this chapter), you must achieve a DRE of 99.9999% for each POHC that you designate under paragraph (c)(3) of this section. You must demonstrate this DRE performance on POHCs that are more difficult to incinerate than tetra-, penta-, and hexachlorodibenzo- *p* -dioxins and dibenzofurans. You must use the equation in paragraph (c)(1) of this section to calculate DRE for each POHC. In addition, you must notify the Administrator of your intent to incinerate hazardous wastes F020, F021, F022, F023, F026, or F027.

(3) *Principal organic hazardous constituent (POHC)*. (i) You must treat each POHC in the waste feed that you specify under paragraph (c)(3)(ii) of this section to the extent required by paragraphs (c)(1) and (c)(2) of this section.

(ii) You must specify one or more POHCs that are representative of the most difficult to destroy organic compounds in your hazardous waste feedstream. You must base this specification on the

degree of difficulty of incineration of the organic constituents in the hazardous waste and on their concentration or mass in the hazardous waste feed, considering the results of hazardous waste analyses or other data and information.

(d) *Significant figures* . The emission limits provided by paragraphs (a) and (b) of this section are presented with two significant figures. Although you must perform intermediate calculations using at least three significant figures, you may round the resultant emission levels to two significant figures to document compliance.

(e) *Alternative to the particulate matter standard* —(1) *General* . In lieu of complying with the particulate matter standards of this section, you may elect to comply with the following alternative metal emission control requirement:

(2) *Alternative metal emission control requirements for existing incinerators* . (i) You must not discharge or cause combustion gases to be emitted into the atmosphere that contain cadmium, lead, and selenium in excess of 230 µgm/dscm, combined emissions, corrected to 7 percent oxygen; and,

(ii) You must not discharge or cause combustion gases to be emitted into the atmosphere that contain antimony, arsenic, beryllium, chromium, cobalt, manganese, and nickel in excess of 92 µgm/dscm, combined emissions, corrected to 7 percent oxygen.

(3) *Alternative metal emission control requirements for new incinerators* . (i) You must not discharge or cause combustion gases to be emitted into the atmosphere that contain cadmium, lead, and selenium in excess of 10 µgm/dscm, combined emissions, corrected to 7 percent oxygen; and,

(ii) You must not discharge or cause combustion gases to be emitted into the atmosphere that contain antimony, arsenic, beryllium, chromium, cobalt, manganese, and nickel in excess of 23 µgm/dscm, combined emissions, corrected to 7 percent oxygen.

(4) *Operating limits* . Semivolatile and low volatile metal operating parameter limits must be established to ensure compliance with the alternative emission limitations described in paragraphs (e) (2) and (e)(3) of this section pursuant to § 63.1209(n), except that semivolatile metal feedrate limits apply to lead, cadmium, and selenium, combined, and low volatile metal feedrate limits apply to arsenic, beryllium, chromium, antimony, cobalt, manganese, and nickel, combined.

[70 FR 59570, Oct. 12, 2005, as amended at 73 FR 64097, Oct. 28, 2008]

§ 63.1220 What are the replacement standards for hazardous waste burning cement kilns?

(a) *Emission and hazardous waste feed limits for existing sources*. You must not discharge or cause combustion gases to be emitted into the atmosphere or feed hazardous waste that contain:

(1) For dioxins and furans, either:

(i) Emissions in excess of 0.20 ng TEQ/dscm corrected to 7 percent oxygen; or

(ii) Emissions in excess of 0.40 ng TEQ/dscm corrected to 7 percent oxygen provided that the combustion gas temperature at the inlet to the initial dry particulate matter control device is 400 °F or lower based on the average of the test run average temperatures;

(2) For mercury, both:

(i) An average as-fired concentration of mercury in all hazardous waste feedstreams in excess of 3.0 parts per million by weight; and

(ii) Either:

(A) Emissions in excess of 120 µg/dscm, corrected to 7 percent oxygen, or

(B) A hazardous waste feed maximum theoretical emission concentration (MTEC) in excess of 120 µg/dscm;

(3) For cadmium and lead, both:

(i) Emissions in excess of 7.6×10^{-4} lbs combined emissions of cadmium and lead attributable to the hazardous waste per million Btu heat input from the hazardous waste; and

(ii) Emissions in excess of 330 µgm/dscm, combined emissions, corrected to 7 percent oxygen;

(4) For arsenic, beryllium, and chromium, both:

(i) Emissions in excess of 2.1×10^{-5} lbs combined emissions of arsenic, beryllium, and chromium attributable to the hazardous waste per million Btu heat input from the hazardous waste; and

(ii) Emissions in excess of 56 µgm/dscm, combined emissions, corrected to 7 percent oxygen;

(5) *Carbon monoxide and hydrocarbons*. (i) For kilns equipped with a by-pass duct or midkiln gas sampling system, either:

(A) Carbon monoxide in the by-pass duct or mid-kiln gas sampling system in excess of 100 parts per million by volume, over an hourly rolling average (monitored continuously with a continuous emissions monitoring system), dry basis and corrected to 7 percent oxygen. If you elect to comply with this carbon monoxide standard rather than the hydrocarbon standard under paragraph (a)(5)(i)(B) of this section, you must also document that, during the destruction and removal efficiency (DRE) test runs or their equivalent as provided by § 63.1206(b)(7), hydrocarbons in the by-pass duct or mid-kiln gas sampling system do not exceed 10 parts per million by volume during those runs, over an hourly rolling average (monitored continuously with a continuous emissions monitoring system), dry basis, corrected to 7 percent oxygen, and reported as propane; or

(B) Hydrocarbons in the by-pass duct or midkiln gas sampling system in excess of 10 parts per million by volume, over an hourly rolling average (monitored continuously with a continuous emissions monitoring system), dry basis, corrected to 7 percent oxygen, and reported as propane;

(ii) For kilns not equipped with a by-pass duct or midkiln gas sampling system, either:

(A) Hydrocarbons in the main stack in excess of 20 parts per million by volume, over an hourly rolling average (monitored continuously with a continuous emissions monitoring system), dry basis, corrected to 7 percent oxygen, and reported as propane; or

(B) Carbon monoxide in the main stack in excess of 100 parts per million by volume, over an hourly rolling average (monitored continuously with a continuous emissions monitoring system), dry basis and corrected to 7 percent oxygen. If you elect to comply with this carbon monoxide standard rather than the hydrocarbon standard under paragraph (a)(5)(ii)(A) of this section, you also must document that, during the destruction and removal efficiency (DRE) test runs or their equivalent as provided by § 63.1206(b)(7), hydrocarbons in the main stack do not exceed 20 parts per million by volume during those runs, over an hourly rolling average (monitored continuously with a continuous emissions monitoring system), dry basis, corrected to 7 percent oxygen, and reported as propane.

(6) Hydrogen chloride and chlorine gas in excess of 120 parts per million by volume, combined emissions, expressed as a chloride (Cl⁻) equivalent, dry basis, corrected to 7 percent oxygen; and

(7) For particulate matter, both:

(i) Emissions in excess of 0.028 gr/dscf corrected to 7 percent oxygen; and

(ii) Opacity greater than 20 percent, unless your source is equipped with a bag leak detection system under § 63.1206(c)(8) or a particulate matter detection system under § 63.1206(c)(9).

(b) *Emission and hazardous waste feed limits for new sources* . You must not discharge or cause combustion gases to be emitted into the atmosphere or feed hazardous waste that contain:

(1) For dioxins and furans, either:

(i) Emissions in excess of 0.20 ng TEQ/dscm corrected to 7 percent oxygen; or

(ii) Emissions in excess of 0.40 ng TEQ/dscm corrected to 7 percent oxygen provided that the combustion gas temperature at the inlet to the initial dry particulate matter control device is 400 °F or lower based on the average of the test run average temperatures;

(2) For mercury, both:

(i) An average as-fired concentration of mercury in all hazardous waste feedstreams in excess of 1.9 parts per million by weight; and

(ii) Either:

(A) Emissions in excess of 120 µg/dscm, corrected to 7 percent oxygen, or

(B) A hazardous waste feed maximum theoretical emission concentration (MTEC) in excess of 120 µg/dscm;

(3) For cadmium and lead, both:

(i) Emissions in excess of 6.2×10^{-5} lbs combined emissions of cadmium and lead attributable to the hazardous waste per million Btu heat input from the hazardous waste; and

(ii) Emissions in excess of 180 µgm/dscm, combined emissions, corrected to 7 percent oxygen;

(4) For arsenic, beryllium, and chromium, both:

(i) Emissions in excess of 1.5×10^{-5} lbs combined emissions of arsenic, beryllium, and chromium attributable to the hazardous waste per million Btu heat input from the hazardous waste; and

(ii) Emissions in excess of 54 µgm/dscm, combined emissions, corrected to 7 percent oxygen;

(5) *Carbon monoxide and hydrocarbons*. (i) For kilns equipped with a by-pass duct or midkiln gas sampling system, carbon monoxide and hydrocarbons emissions are limited in both the bypass duct or midkiln gas sampling system and the main stack as follows:

(A) Emissions in the by-pass or midkiln gas sampling system are limited to either:

(1) Carbon monoxide in excess of 100 parts per million by volume, over an hourly rolling average (monitored continuously with a continuous emissions monitoring system), dry basis and corrected to 7 percent oxygen. If you elect to comply with this carbon monoxide standard rather than the hydrocarbon standard under paragraph (b)(5)(i)(A)(2) of this section, you also must document that, during the destruction and removal efficiency (DRE) test runs or their equivalent as provided by § 63.1206(b)(7), hydrocarbons do not exceed 10 parts per million by volume during those runs, over an hourly rolling average (monitored continuously with a continuous emissions monitoring system), dry basis, corrected to 7 percent oxygen, and reported as propane; or

(2) Hydrocarbons in the by-pass duct or midkiln gas sampling system in excess of 10 parts per million by volume, over an hourly rolling average (monitored continuously with a continuous emissions monitoring system), dry basis, corrected to 7 percent oxygen, and reported as propane; and

(B) Hydrocarbons in the main stack are limited, if construction of the kiln commenced after April 19, 1996 at a plant site where a cement kiln (whether burning hazardous waste or not) did not previously exist, to 50 parts per million by volume, over a 30-day block average (monitored

continuously with a continuous monitoring system), dry basis, corrected to 7 percent oxygen, and reported as propane.

(ii) For kilns not equipped with a by-pass duct or midkiln gas sampling system, hydrocarbons and carbon monoxide are limited in the main stack to either:

(A) Hydrocarbons not exceeding 20 parts per million by volume, over an hourly rolling average (monitored continuously with a continuous emissions monitoring system), dry basis, corrected to 7 percent oxygen, and reported as propane; or

(B)(1) Carbon monoxide not exceeding 100 parts per million by volume, over an hourly rolling average (monitored continuously with a continuous emissions monitoring system), dry basis, corrected to 7 percent oxygen; and

(2) Hydrocarbons not exceeding 20 parts per million by volume, over an hourly rolling average (monitored continuously with a continuous monitoring system), dry basis, corrected to 7 percent oxygen, and reported as propane at any time during the destruction and removal efficiency (DRE) test runs or their equivalent as provided by § 63.1206(b)(7); and

(3) If construction of the kiln commenced after April 19, 1996 at a plant site where a cement kiln (whether burning hazardous waste or not) did not previously exist, hydrocarbons are limited to 50 parts per million by volume, over a 30-day block average (monitored continuously with a continuous monitoring system), dry basis, corrected to 7 percent oxygen, and reported as propane.

(6) Hydrogen chloride and chlorine gas in excess of 86 parts per million by volume, combined emissions, expressed as a chloride (Cl^{-}) equivalent, dry basis and corrected to 7 percent oxygen; and

(7) For particulate matter, both:

(i) Emissions in excess of 0.0069 gr/dscf corrected to 7 percent oxygen; and

(ii) Opacity greater than 20 percent, unless your source is equipped with a bag leak detection system under § 63.1206(c)(8) or a particulate matter detection system under § 63.1206(c)(9).

(c) *Destruction and removal efficiency (DRE) standard* —(1) *99.99% DRE*. Except as provided in paragraph (c)(2) of this section, you must achieve a destruction and removal efficiency (DRE) of 99.99% for each principle organic hazardous constituent (POHC) designated under paragraph (c)(3) of this section. You must calculate DRE for each POHC from the following equation:

$$\text{DRE} = [1 - (W_{\text{out}} / W_{\text{in}})] \times 100\%$$

Where:

W_{in} = mass feedrate of one POHC in a waste feedstream; and

W_{out} = mass emission rate of the same POHC present in exhaust emissions prior to release to the atmosphere.

(2) *99.9999% DRE*. If you burn the dioxin-listed hazardous wastes F020, F021, F022, F023, F026, or F027 (see § 261.31 of this chapter), you must achieve a DRE of 99.9999% for each POHC that you designate under paragraph (c)(3) of this section. You must demonstrate this DRE performance on POHCs that are more difficult to incinerate than tetra-, penta-, and hexachlorodibenzo- *p* -dioxins and dibenzofurans. You must use the equation in paragraph (c)(1) of this section to calculate DRE for each POHC. In addition, you must notify the Administrator of your intent to incinerate hazardous wastes F020, F021, F022, F023, F026, or F027.

(3) *Principal organic hazardous constituent (POHC)*. (i) You must treat each POHC in the waste feed that you specify under paragraph (c)(3)(ii) of this section to the extent required by paragraphs (c)(1) and (c)(2) of this section.

(ii) You must specify one or more POHCs that are representative of the most difficult to destroy organic compounds in your hazardous waste feedstream. You must base this specification on the degree of difficulty of incineration of the organic constituents in the hazardous waste and on their concentration or mass in the hazardous waste feed, considering the results of hazardous waste analyses or other data and information.

(d) *Cement kilns with in-line kiln raw mills* —(1) *General.* (i) You must conduct performance testing when the raw mill is on-line and when the mill is off-line to demonstrate compliance with the emission standards, and you must establish separate operating parameter limits under § 63.1209 for each mode of operation, except as provided by paragraphs (d)(1)(iv) and (d)(1)(v) of this section.

(ii) You must document in the operating record each time you change from one mode of operation to the alternate mode and begin complying with the operating parameter limits for that alternate mode of operation.

(iii) You must calculate rolling averages for operating parameter limits as provided by § 63.1209 (q)(2).

(iv) If your in-line kiln raw mill has dual stacks, you may assume that the dioxin/furan emission levels in the by-pass stack and the operating parameter limits determined during performance testing of the by-pass stack when the raw mill is off-line are the same as when the mill is on-line.

(v) In lieu of conducting a performance test to demonstrate compliance with the dioxin/furan emission standards for the mode of operation when the raw mill is on-line, you may specify in the performance test workplan and Notification of Compliance the same operating parameter limits required under § 63.1209(k) for the mode of operation when the raw mill is on-line as you establish during performance testing for the mode of operation when the raw mill is off-line.

(2) *Emissions averaging.* You may comply with the mercury, semivolatile metal, low volatile metal, and hydrogen chloride/chlorine gas emission standards on a time-weighted average basis under the following procedures:

(i) *Averaging methodology.* You must calculate the time-weighted average emission concentration with the following equation:

$$C_{\text{total}} = \{C_{\text{mill-off}} \times (T_{\text{mill-off}} / (T_{\text{mill-off}} + T_{\text{mill-on}}))\} + \{C_{\text{mill-on}} \times (T_{\text{mill-on}} / (T_{\text{mill-off}} + T_{\text{mill-on}}))\}$$

Where:

C_{total} = time-weighted average concentration of a regulated constituent considering both raw mill on time and off time;

$C_{\text{mill-off}}$ = average performance test concentration of regulated constituent with the raw mill off-line;

$C_{\text{mill-on}}$ = average performance test concentration of regulated constituent with the raw mill on-line;

$T_{\text{mill-off}}$ = time when kiln gases are not routed through the raw mill; and

$T_{\text{mill-on}}$ = time when kiln gases are routed through the raw mill.

(ii) *Compliance.* (A) If you use this emission averaging provision, you must document in the operating record compliance with the emission standards on an annual basis by using the equation provided by paragraph (d)(2) of this section.

(B) Compliance is based on one-year block averages beginning on the day you submit the initial notification of compliance.

(iii) *Notification.* (A) If you elect to document compliance with one or more emission standards using this emission averaging provision, you must notify the Administrator in the initial comprehensive performance test plan submitted under § 63.1207(e).

(B) You must include historical raw mill operation data in the performance test plan to estimate future raw mill down-time and document in the performance test plan that estimated emissions and estimated raw mill down-time will not result in an exceedance of an emission standard on an annual basis.

(C) You must document in the notification of compliance submitted under § 63.1207(j) that an emission standard will not be exceeded based on the documented emissions from the performance test and predicted raw mill down-time.

(e) *Preheater or preheater/precalciner kilns with dual stacks* —(1) *General*. You must conduct performance testing on each stack to demonstrate compliance with the emission standards, and you must establish operating parameter limits under § 63.1209 for each stack, except as provided by paragraph (d)(1)(iv) of this section for dioxin/furan emissions testing and operating parameter limits for the by-pass stack of in-line raw mills.

(2) *Emissions averaging*. You may comply with the mercury, semivolatile metal, low volatile metal, and hydrogen chloride/chlorine gas emission standards specified in this section on a gas flowrate-weighted average basis under the following procedures:

(i) *Averaging methodology*. You must calculate the gas flowrate-weighted average emission concentration using the following equation:

$$C_{\text{tot}} = \{C_{\text{main}} \times (Q_{\text{main}} / (Q_{\text{main}} + Q_{\text{bypass}}))\} + \{C_{\text{bypass}} \times (Q_{\text{bypass}} / (Q_{\text{main}} + Q_{\text{bypass}}))\}$$

Where:

C_{tot} = gas flowrate-weighted average concentration of the regulated constituent;

C_{main} = average performance test concentration demonstrated in the main stack;

C_{bypass} = average performance test concentration demonstrated in the bypass stack;

Q_{main} = volumetric flowrate of main stack effluent gas; and

Q_{bypass} = volumetric flowrate of bypass effluent gas.

(ii) *Compliance*. (A) You must demonstrate compliance with the emission standard(s) using the emission concentrations determined from the performance tests and the equation provided by paragraph (e)(1) of this section; and

(B) You must develop operating parameter limits for bypass stack and main stack flowrates that ensure the emission concentrations calculated with the equation in paragraph (e)(1) of this section do not exceed the emission standards on a 12-hour rolling average basis. You must include these flowrate limits in the Notification of Compliance.

(iii) *Notification*. If you elect to document compliance under this emissions averaging provision, you must:

(A) Notify the Administrator in the initial comprehensive performance test plan submitted under § 63.1207(e). The performance test plan must include, at a minimum, information describing the flowrate limits established under paragraph (e)(2)(ii)(B) of this section; and

(B) Document in the Notification of Compliance submitted under § 63.1207(j) the demonstrated gas flowrate-weighted average emissions that you calculate with the equation provided by paragraph (e)(2) of this section.

(f) *Significant figures*. The emission limits provided by paragraphs (a) and (b) of this section are presented with two significant figures. Although you must perform intermediate calculations using at least three significant figures, you may round the resultant emission levels to two significant figures to document compliance.

(g) [Reserved]

(h) When you comply with the particulate matter requirements of paragraphs (a)(7) or (b)(7) of this section, you are exempt from the New Source Performance Standard for particulate matter and opacity under § 60.60 of this chapter.

[70 FR 59571, Oct. 12, 2005, as amended at 71 FR 62394, Oct. 25, 2006; 73 FR 18983, Apr. 8, 2008; 73 FR 64097, Oct. 28, 2008]

§ 63.1221 What are the replacement standards for hazardous waste burning lightweight aggregate kilns?

(a) *Emission and hazardous waste feed limits for existing sources* . You must not discharge or cause combustion gases to be emitted into the atmosphere or feed hazardous waste that contain:

(1) For dioxins and furans, either:

(i) Emissions in excess of 0.20 ng TEQ/dscm corrected to 7 percent oxygen; or

(ii) Rapid quench of the combustion gas temperature at the exit of the (last) combustion chamber (or exit of any waste heat recovery system that immediately follows the last combustion chamber) to 400 °F or lower based on the average of the test run average temperatures. You must also notify in writing the RCRA authority that you are complying with this option;

(2) For mercury, either:

(i) Emissions in excess of 120 µgm/dscm, corrected to 7 percent oxygen; or

(ii) A hazardous waste feedrate corresponding to a maximum theoretical emission concentration (MTEC) in excess of 120 µgm/dscm;

(3) For cadmium and lead, both:

(i) Emissions in excess of 3.0×10^{-4} lbs combined emissions of cadmium and lead attributable to the hazardous waste per million Btu heat input from the hazardous waste; and

(ii) Emissions in excess of 250 µgm/dscm, combined emissions, corrected to 7 percent oxygen;

(4) For arsenic, beryllium, and chromium, both:

(i) In excess of 9.5×10^{-5} lbs combined emissions of arsenic, beryllium, and chromium attributable to the hazardous waste per million Btu heat input from the hazardous waste;

(ii) Emissions in excess of 110 µgm/dscm, combined emissions, corrected to 7 percent oxygen;

(5) *Carbon monoxide and hydrocarbons* . (i) Carbon monoxide in excess of 100 parts per million by volume, over an hourly rolling average (monitored continuously with a continuous emissions monitoring system), dry basis and corrected to 7 percent oxygen. If you elect to comply with this carbon monoxide standard rather than the hydrocarbon standard under paragraph (a)(5)(ii) of this section, you also must document that, during the destruction and removal efficiency (DRE) test runs or their equivalent as provided by § 63.1206(b)(7), hydrocarbons do not exceed 20 parts per million by volume during those runs, over an hourly rolling average (monitored continuously with a continuous emissions monitoring system), dry basis, corrected to 7 percent oxygen, and reported as propane; or

(ii) Hydrocarbons in excess of 20 parts per million by volume, over an hourly rolling average, dry basis, corrected to 7 percent oxygen, and reported as propane;

(6) Hydrogen chloride and chlorine gas in excess of 600 parts per million by volume, combined emissions, expressed as a chloride (Cl⁻) equivalent, dry basis and corrected to 7 percent oxygen; and

(7) Particulate matter emissions in excess of 0.025 gr/dscf, corrected to 7 percent oxygen.

(b) *Emission and hazardous waste feed limits for new sources* . You must not discharge or cause combustion gases to be emitted into the atmosphere or feed hazardous waste that contain:

(1) For dioxins and furans, either:

(i) Emissions in excess of 0.20 ng TEQ/dscm corrected to 7 percent oxygen; or

(ii) Rapid quench of the combustion gas temperature at the exit of the (last) combustion chamber (or exit of any waste heat recovery system that immediately follows the last combustion chamber) to 400 °F or lower based on the average of the test run average temperatures. You must also notify in writing the RCRA authority that you are complying with this option;

(2) For mercury, either:

(i) Emissions in excess of 120 µgm/dscm, corrected to 7 percent oxygen; or

(ii) A hazardous waste feedrate corresponding to a maximum theoretical emission concentration (MTEC) in excess of 120 µgm/dscm;

(3) For cadmium and lead, both:

(i) Emissions in excess of 3.7×10^{-5} lbs combined emissions of cadmium and lead attributable to the hazardous waste per million Btu heat input from the hazardous waste; and

(ii) Emissions in excess of 43 µgm/dscm, combined emissions, corrected to 7 percent oxygen;

(4) For arsenic, beryllium, and chromium, both:

(i) In excess of 3.3×10^{-5} lbs combined emissions of arsenic, beryllium, and chromium attributable to the hazardous waste per million Btu heat input from the hazardous waste;

(ii) Emissions in excess of 110 µgm/dscm, combined emissions, corrected to 7 percent oxygen;

(5) *Carbon monoxide and hydrocarbons* . (i) Carbon monoxide in excess of 100 parts per million by volume, over an hourly rolling average (monitored continuously with a continuous emissions monitoring system), dry basis and corrected to 7 percent oxygen. If you elect to comply with this carbon monoxide standard rather than the hydrocarbon standard under paragraph (b)(5)(ii) of this section, you also must document that, during the destruction and removal efficiency (DRE) test runs or their equivalent as provided by § 63.1206(b)(7), hydrocarbons do not exceed 20 parts per million by volume during those runs, over an hourly rolling average (monitored continuously with a continuous emissions monitoring system), dry basis, corrected to 7 percent oxygen, and reported as propane; or

(ii) Hydrocarbons in excess of 20 parts per million by volume, over an hourly rolling average, dry basis, corrected to 7 percent oxygen, and reported as propane;

(6) Hydrogen chloride and chlorine gas in excess of 600 parts per million by volume, combined emissions, expressed as a chloride (Cl^-) equivalent, dry basis and corrected to 7 percent oxygen; and

(7) Particulate matter emissions in excess of 0.0098 gr/dscf corrected to 7 percent oxygen.

(c) *Destruction and removal efficiency (DRE) standard* —(1) *99.99% DRE* . Except as provided in paragraph (c)(2) of this section, you must achieve a destruction and removal efficiency (DRE) of 99.99% for each principal organic hazardous constituent (POHC) designated under paragraph (c)(3) of this section. You must calculate DRE for each POHC from the following equation:

$$\text{DRE} = [1 - (W_{\text{out}} / W_{\text{in}})] \times 100\%$$

Where:

W_{in} = mass feedrate of one POHC in a waste feedstream; and

W_{out} = mass emission rate of the same POHC present in exhaust emissions prior to release to the atmosphere.

(2) **99.9999% DRE** . If you burn the dioxin-listed hazardous wastes F020, F021, F022, F023, F026, or F027 (see § 261.31 of this chapter), you must achieve a destruction and removal efficiency (DRE) of 99.9999% for each POHC that you designate under paragraph (c)(3) of this section. You must demonstrate this DRE performance on POHCs that are more difficult to incinerate than tetra-, penta-, and hexachlorodibenzo-dioxins and dibenzofurans. You must use the equation in paragraph (c)(1) of this section to calculate DRE for each POHC. In addition, you must notify the Administrator of your intent to burn hazardous wastes F020, F021, F022, F023, F026, or F027.

(3) **Principal organic hazardous constituents (POHCs)** . (i) You must treat each POHC in the waste feed that you specify under paragraph (c)(3)(ii) of this section to the extent required by paragraphs (c)(1) and (c)(2) of this section.

(ii) You must specify one or more POHCs that are representative of the most difficult to destroy organic compounds in your hazardous waste feedstream. You must base this specification on the degree of difficulty of incineration of the organic constituents in the hazardous waste and on their concentration or mass in the hazardous waste feed, considering the results of hazardous waste analyses or other data and information.

(d) **Significant figures** . The emission limits provided by paragraphs (a) and (b) of this section are presented with two significant figures. Although you must perform intermediate calculations using at least three significant figures, you may round the resultant emission levels to two significant figures to document compliance.

[70 FR 59574, Oct. 12, 2005]

Table 1 to Subpart EEE of Part 63—General Provisions Applicable to Subpart EEE

Reference	Applies to subpart EEE	Explanation
63.1	Yes.	
63.2	Yes.	
63.3	Yes.	
63.4	Yes.	
63.5	Yes.	
63.6(a), (b), (c), (d), and (e)	Yes.	
63.6(f)	Yes	Except that the performance test requirements of Sec. 63.1207 apply instead of § 63.6(f)(2)(iii)(B).
63.6(g) and (h)	Yes.	
63.6(i)	Yes	Section 63.1213 specifies that the compliance date may also be extended for inability to install necessary emission control equipment by the compliance date because of implementation of pollution prevention or waste minimization controls.
63.6(j)	Yes.	
63.7(a)	Yes	Except § 63.1207(e)(3) allows you to petition the Administrator under § 63.7(h) to provide an extension of time to conduct a performance test.
63.7(b)	Yes	

		Except § 63.1207(e) requires you to submit the site-specific test plan for approval at least one year before the comprehensive performance test is scheduled to begin.
63.7(c)	Yes	Except § 63.1207(e) requires you to submit the site-specific test plan (including the quality assurance provisions under § 63.7(c)) for approval at least one year before the comprehensive performance test is scheduled to begin.
63.7(d)	Yes.	
63.7(e)	Yes	Except § 63.1207 prescribes operations during performance testing and § 63.1209 specifies operating limits that will be established during performance testing (such that testing is likely to be representative of the extreme range of normal performance).
63.7(f)	Yes.	
63.7(g)	Yes	Except § 63.1207(j) requiring that you submit the results of the performance test (and the notification of compliance) within 90 days of completing the test, unless the Administrator grants a time extension, applies instead of § 63.7(g)(1).
63.7(h)	Yes	Except § 63.1207(c)(2) allows data in lieu of the initial comprehensive performance test, and § 63.1207(m) provides a waiver of certain performance tests. You must submit requests for these waivers with the site-specific test plan.
63.8(a) and (b)	Yes.	
63.8(c)	Yes	Except: (1) § 63.1211(c) that requires you to install, calibrate, and operate CMS by the compliance date applies instead of § 63.8(c)(3); and (2) the performance specifications for CO, HC, and O ₂ CEMS in subpart B, of this chapter requiring that the detectors measure the sample concentration at least once every 15 seconds for calculating an average emission level once every 60 seconds apply instead of § 63.8(c)(4)(ii).
63.8(d)	Yes.	
63.8(e)	Yes	Except § 63.1207(e) requiring you to submit the site-specific comprehensive performance test plan and the CMS performance evaluation test plan for approval at least one year prior to the planned test date applies instead of §§ 63.8(e)(2) and (3)(iii).
63.8(f) and (g)	Yes.	
63.9(a)	Yes.	
63.9(b)	Yes	<i>Note:</i> Section 63.9(b)(1)(ii) pertains to notification requirements for area sources that become a major source, and § 63.9(b)(2)(v) requires a major source determination. Although area sources are subject to all provisions of this subpart (Subpart EEE), these sections nonetheless apply because the major source determination may affect the applicability of part 63 standards or title V permit requirements to other sources (i.e., other than a hazardous waste combustor) of hazardous air pollutants at the facility.
63.9(c) and (d)	Yes.	
63.9(e)	Yes	Except § 63.1207(e) which requires you to submit the comprehensive performance test plan for approval one year prior to the planned performance test date applies instead of § 63.9(e).
63.9(f)	Yes	Section 63.9(f) applies if you are allowed under § 63.1209(a)(1)(v) to use visible determination of opacity for compliance in lieu of a COMS.
63.9(g)	Yes	Except § 63.9(g)(2) pertaining to COMS does not apply.
63.9(h)	Yes	Except § 63.1207(j) requiring you to submit the notification of compliance within 90 days of completing a performance test unless the Administrator

		grants a time extension applies instead of § 63.9(h)(2)(iii). Note: Even though area sources are subject to this subpart, the major source determination required by § 63.9(h)(2)(i)(E) is applicable to hazardous waste combustors for the reasons discussed above.
63.9(i) and (j)	Yes.	
63.10	Yes	Except reports of performance test results required under § 63.10(d)(2) may be submitted up to 90 days after completion of the test.
63.11	No.	
63.12-63.15	Yes.	

[67 FR 6994, Feb. 14, 2002]

Appendix to Subpart **EEE** of Part **63**—Quality Assurance Procedures for Continuous Emissions Monitors Used for Hazardous Waste Combustors

1. Applicability and Principle

1.1 Applicability. These quality assurance requirements are used to evaluate the effectiveness of quality control (QC) and quality assurance (QA) procedures and the quality of data produced by continuous emission monitoring systems (CEMS) that are used for determining compliance with the emission standards on a continuous basis as specified in the applicable regulation. The QA procedures specified by these requirements represent the minimum requirements necessary for the control and assessment of the quality of CEMS data used to demonstrate compliance with the emission standards provided under this subpart **EEE** of part **63**. Owners and operators must meet these minimum requirements and are encouraged to develop and implement a more extensive QA program. These requirements supersede those found in part 60, Appendix F, of this chapter. Appendix F does not apply to hazardous waste-burning devices.

1.2 Principle. The QA procedures consist of two distinct and equally important functions. One function is the assessment of the quality of the CEMS data by estimating accuracy. The other function is the control and improvement of the quality of the CEMS data by implementing QC policies and corrective actions. These two functions form a control loop. When the assessment function indicates that the data quality is inadequate, the source must immediately stop burning hazardous waste. The CEM data control effort must be increased until the data quality is acceptable before hazardous waste burning can resume.

a. In order to provide uniformity in the assessment and reporting of data quality, this procedure explicitly specifies the assessment methods for response drift and accuracy. The methods are based on procedures included in the applicable performance specifications provided in appendix B to part 60 of this chapter. These procedures also require the analysis of the EPA audit samples concurrent with certain reference method (RM) analyses as specified in the applicable RM's.

b. Because the control and corrective action function encompasses a variety of policies, specifications, standards, and corrective measures, this procedure treats QC requirements in general terms to allow each source owner or operator to develop a QC system that is most effective and efficient for the circumstances.

2. Definitions

2.1 *Continuous Emission Monitoring System (CEMS)*. The total equipment required for the determination of a pollutant concentration. The system consists of the following major subsystems:

2.1.1 *Sample Interface*. That portion of the CEMS used for one or more of the following: sample acquisition, sample transport, and sample conditioning, or protection of the monitor from the effects of the stack effluent.

2.1.2 *Pollutant Analyzer*. That portion of the CEMS that senses the pollutant concentration and generates a proportional output.

2.1.3 *Diluent Analyzer*. That portion of the CEMS that senses the diluent gas (O₂) and generates an output proportional to the gas concentration.

2.1.4 *Data Recorder*. That portion of the CEMS that provides a permanent record of the analyzer output. The data recorder may provide automatic data reduction and CEMS control capabilities.

2.2 *Relative Accuracy (RA)*. The absolute mean difference between the pollutant concentration determined by the CEMS and the value determined by the reference method (RM) plus the 2.5 percent error confidence coefficient of a series of test divided by the mean of the RM tests or the applicable emission limit.

2.3 *Calibration Drift (CD)*. The difference in the CEMS output readings from the established reference value after a stated period of operation during which no unscheduled maintenance, repair, or adjustment took place.

2.4 *Zero Drift (ZD)*. The difference in CEMS output readings at the zero pollutant level after a stated period of operation during which no unscheduled maintenance, repair, or adjustment took place.

2.5 *Calibration Standard*. Calibration standards produce a known and unchanging response when presented to the pollutant analyzer portion of the CEMS, and are used to calibrate the drift or response of the analyzer.

2.6 *Relative Accuracy Test Audit (RATA)*. Comparison of CEMS measurements to reference method measurements in order to evaluate relative accuracy following procedures and specification given in the appropriate performance specification.

2.7 *Absolute Calibration Audit (ACA)*. Equivalent to calibration error (CE) test defined in the appropriate performance specification using NIST traceable calibration standards to challenge the CEMS and assess accuracy.

2.8 *Rolling Average*. The average emissions, based on some (specified) time period, calculated every minute from a one-minute average of four measurements taken at 15-second intervals.

3. QA/QC Requirements

3.1 QC Requirements. a. Each owner or operator must develop and implement a QC program. At a minimum, each QC program must include written procedures describing in detail complete, step-by-step procedures and operations for the following activities.

1. Checks for component failures, leaks, and other abnormal conditions.
2. Calibration of CEMS.
3. CD determination and adjustment of CEMS.
4. Integration of CEMS with the automatic waste feed cutoff (AWFCO) system.
5. Preventive Maintenance of CEMS (including spare parts inventory).
6. Data recording, calculations, and reporting.
7. Checks of record keeping.
8. Accuracy audit procedures, including sampling and analysis methods.

9. Program of corrective action for malfunctioning CEMS.

10. Operator training and certification.

11. Maintaining and ensuring current certification or naming of cylinder gasses, metal solutions, and particulate samples used for audit and accuracy tests, daily checks, and calibrations.

b. Whenever excessive inaccuracies occur for two consecutive quarters, the current written procedures must be revised or the CEMS modified or replaced to correct the deficiency causing the excessive inaccuracies. These written procedures must be kept on record and available for inspection by the enforcement agency.

3.2 QA Requirements. Each source owner or operator must develop and implement a QA plan that includes, at a minimum, the following.

1. QA responsibilities (including maintaining records, preparing reports, reviewing reports).

2. Schedules for the daily checks, periodic audits, and preventive maintenance.

3. Check lists and data sheets.

4. Preventive maintenance procedures.

5. Description of the media, format, and location of all records and reports.

6. Provisions for a review of the CEMS data at least once a year. Based on the results of the review, the owner or operator must revise or update the QA plan, if necessary.

4. CD and ZD Assessment and Daily System Audit

4.1 *CD and ZD Requirement.* Owners and operators must check, record, and quantify the ZD and the CD at least once daily (approximately 24 hours) in accordance with the method prescribed by the manufacturer. The CEMS calibration must, at a minimum, be adjusted whenever the daily ZD or CD exceeds the limits in the Performance Specifications. If, on any given ZD and/or CD check the ZD and/or CD exceed(s) two times the limits in the Performance Specifications, or if the cumulative adjustment to the ZD and/or CD (see Section 4.2) exceed(s) three times the limits in the Performance Specifications, hazardous waste burning must immediately cease and the CEMS must be serviced and recalibrated. Hazardous waste burning cannot resume until the owner or operator documents that the CEMS is in compliance with the Performance Specifications by carrying out an ACA.

4.2 *Recording Requirements for Automatic ZD and CD Adjusting Monitors.* Monitors that automatically adjust the data to the corrected calibration values must record the unadjusted concentration measurement prior to resetting the calibration, if performed, or record the amount of the adjustment.

4.3 *Daily System Audit.* The audit must include a review of the calibration check data, an inspection of the recording system, an inspection of the control panel warning lights, and an inspection of the sample transport and interface system (e.g., flowmeters, filters, etc.) as appropriate.

4.4 *Data Recording and Reporting.* All measurements from the CEMS must be retained in the operating record for at least 5 years.

5. Performance Evaluation for CO, O₂, and HC CEMS

Carbon Monoxide (CO), Oxygen (O₂), and Hydrocarbon (HC) CEMS. An Absolute Calibration Audit (ACA) must be conducted quarterly, and a Relative Accuracy Test Audit (RATA) (if applicable, see sections 5.1 and 5.2) must be conducted yearly. An Interference Response Tests must be performed whenever an ACA or a RATA is conducted. When a performance test is also required under § 63.1207 to document compliance with emission standards, the RATA must coincide with the performance test. The audits must be conducted as follows.

5.1 *Relative Accuracy Test Audit (RATA)*. This requirement applies to O₂ and CO CEMS. The RATA must be conducted at least yearly. Conduct the RATA as described in the RA test procedure (or alternate procedures section) described in the applicable Performance Specifications. In addition, analyze the appropriate performance audit samples received from the EPA as described in the applicable sampling methods.

5.2 *Absolute Calibration Audit (ACA)*. The ACA must be conducted at least quarterly except in a quarter when a RATA (if applicable, see section 5.1) is conducted instead. Conduct an ACA as described in the calibration error (CE) test procedure described in the applicable Performance Specifications.

5.3 *Interference Response Test*. The interference response test must be conducted whenever an ACA or RATA is conducted. Conduct an interference response test as described in the applicable Performance Specifications.

5.4 *Excessive Audit Inaccuracy*. If the RA from the RATA or the CE from the ACA exceeds the criteria in the applicable Performance Specifications, hazardous waste burning must cease immediately. Hazardous waste burning cannot resume until the owner or operator takes corrective measures and audit the CEMS with a RATA to document that the CEMS is operating within the specifications.

6. Other Requirements

6.1 *Performance Specifications*. CEMS used by owners and operators of HWCs must comply with the following performance specifications in appendix B to part 60 of this chapter:

TABLE I: PERFORMANCE SPECIFICATIONS FOR CEMS

CEMS	Performance specification
Carbon monoxide	4B
Oxygen	4B
Total hydrocarbons	8A

6.2 *Downtime due to Calibration*. Facilities may continue to burn hazardous waste for a maximum of 20 minutes while calibrating the CEMS. If all CEMS are calibrated at once, the facility must have twenty minutes to calibrate all the CEMS. If CEMS are calibrated individually, the facility must have twenty minutes to calibrate each CEMS. If the CEMS are calibrated individually, other CEMS must be operational while the individual CEMS is being calibrated.

6.3 Span of the CEMS.

6.3.1 *CO CEMS*. The CO CEM must have two ranges, a low range with a span of 200 ppmv and a high range with a span of 3000 ppmv at an oxygen correction factor of 1. A one-range CEM may be used, but it must meet the performance specifications for the low range in the specified span of the low range.

6.3.2 *O₂ CEMS*. The O₂ CEM must have a span of 25 percent. The span may be higher than 25 percent if the O₂ concentration at the sampling point is greater than 25 percent.

6.3.3 *HC CEMS*. The HC CEM must have a span of 100 ppmv, expressed as propane, at an oxygen correction factor of 1.

6.3.4 *CEMS Span Values*. When the Oxygen Correction Factor is Greater than 2. When an owner or operator installs a CEMS at a location of high ambient air dilution, i.e., where the maximum oxygen correction factor as determined by the permitting agency is greater than 2, the owner or operator must install a CEM with a lower span(s), proportionate to the larger oxygen correction factor, than those specified above.

6.3.5 *Use of Alternative Spans.* Owner or operators may request approval to use alternative spans and ranges to those specified. Alternate spans must be approved in writing in advance by the Administrator. In considering approval of alternative spans and ranges, the Administrator will consider that measurements beyond the span will be recorded as values at the maximum span for purposes of calculating rolling averages.

6.3.6 *Documentation of Span Values.* The span value must be documented by the CEMS manufacturer with laboratory data.

6.4.1 *Moisture Correction.* Method 4 of appendix A, part 60 of this chapter, must be used to determine moisture content of the stack gasses.

6.4.2 *Oxygen Correction Factor.* Measured pollutant levels must be corrected for the amount of oxygen in the stack according to the following formula:

$$P_c = P_m \times 14 / (E - Y)$$

Where:

P_c = concentration of the pollutant or standard corrected to 7 percent oxygen, dry basis;

P_m = measured concentration of the pollutant, dry basis;

E = volume fraction of oxygen in the combustion air fed into the device, on a dry basis (normally 21 percent or 0.21 if only air is fed);

Y = measured fraction of oxygen on a dry basis at the sampling point.

The oxygen correction factor is:

$$OCF = 14 / (E - Y)$$

6.4.3 *Temperature Correction.* Correction values for temperature are obtainable from standard reference materials.

6.5 *Rolling Average.* A rolling average is the arithmetic average of all one-minute averages over the averaging period.

6.5.1 *One-Minute Average for CO and HHC CEMS.* One-minute averages are the arithmetic average of the four most recent 15-second observations and must be calculated using the following equation:

$$\bar{c} = \sum_{i=1}^4 \frac{c_i}{4}$$

Where:

\bar{c} = the one minute average

c_i = a fifteen-second observation from the CEM

Fifteen second observations must not be rounded or smoothed. Fifteen-second observations may be disregarded only as a result of a failure in the CEMS and allowed in the source's quality assurance plan at the time of the CEMS failure. One-minute averages must not be rounded, smoothed, or disregarded.

6.5.2 *Ten Minute Rolling Average Equation.* The ten minute rolling average must be calculated using the following equation:

$$C_{RA} = \sum_{i=1}^{10} \frac{\bar{c}_i}{10}$$

Where:

C_{RA} = The concentration of the standard, expressed as a rolling average

\bar{c}_i = a one minute average

6.5.3 Hourly Rolling Average Equation for CO and THC CEMS and Operating Parameter Limits. The rolling average, based on a specific number integer of hours, must be calculated using the following equation:

$$C_{RA} = \sum_{i=1}^{60} \frac{\bar{c}_i}{60}$$

Where:

c_{RA} = The concentration of the standard, expressed as a rolling average

\bar{c}_i = a one minute average

6.5.4 Averaging Periods for CEMS other than CO and THC. The averaging period for CEMS other than CO and THC CEMS must be calculated as a rolling average of all one-hour values over the averaging period. An hourly average is comprised of 4 measurements taken at equally spaced time intervals, or at most every 15 minutes. Fewer than 4 measurements might be available within an hour for reasons such as facility downtime or CEMS calibration. If at least two measurements (30 minutes of data) are available, an hourly average must be calculated. The n -hour rolling average is calculated by averaging the n most recent hourly averages.

6.6 Units of the Standards for the Purposes of Recording and Reporting Emissions. Emissions must be recorded and reported expressed after correcting for oxygen, temperature, and moisture. Emissions must be reported in metric, but may also be reported in the English system of units, at 7 percent oxygen, 20 °C, and on a dry basis.

6.7 Rounding and Significant Figures. Emissions must be rounded to two significant figures using ASTM procedure E-29-90 or its successor. Rounding must be avoided prior to rounding for the reported value.

7. Bibliography

1. 40 CFR part 60, appendix F, "Quality Assurance Procedures: Procedure 1. Quality Assurance Requirements for Gas continuous Emission Monitoring Systems Used For Compliance Determination".

[64 FR 53038, Sept. 30, 1999, as amended at 65 FR 42301, July 10, 2000]

For questions or comments regarding e-CFR editorial content, features, or design, email ecfr@nara.gov.

For questions concerning e-CFR programming and delivery issues, email webteam@gpo.gov.

Appendix L – Continuous Emission Monitoring Systems Conditions

Arkansas Department of Environmental Quality



CONTINUOUS EMISSION MONITORING SYSTEMS CONDITIONS

Revised September 2013

PREAMBLE

These conditions are intended to outline the requirements for facilities required to operate Continuous Emission Monitoring Systems/Continuous Opacity Monitoring Systems (CEMS/COMS). Generally there are three types of sources required to operate CEMS/COMS:

1. CEMS/COMS required by 40 CFR Part 60 or 63,
2. CEMS required by 40 CFR Part 75,
3. CEMS/COMS required by ADEQ permit for reasons other than Part 60, 63 or 75.

These CEMS/COMS conditions are not intended to supercede Part 60, 63 or 75 requirements.

- Only CEMS/COMS in the third category (those required by ADEQ permit for reasons other than Part 60, 63, or 75) shall comply with SECTION II, MONITORING REQUIREMENTS and SECTION IV, QUALITY ASSURANCE/QUALITY CONTROL.
- All CEMS/COMS shall comply with Section III, NOTIFICATION AND RECORDKEEPING.

SECTION I

DEFINITIONS

Continuous Emission Monitoring System (CEMS) - The total equipment required for the determination of a gas concentration and/or emission rate so as to include sampling, analysis and recording of emission data.

Continuous Opacity Monitoring System (COMS) - The total equipment required for the determination of opacity as to include sampling, analysis and recording of emission data.

Calibration Drift (CD) - The difference in the CEMS output reading from the established reference value after a stated period of operation during which no unscheduled maintenance, repair, or adjustments took place.

Back-up CEMS (Secondary CEMS) - A CEMS with the ability to sample, analyze and record stack pollutant to determine gas concentration and/or emission rate. This CEMS is to serve as a back-up to the primary CEMS to minimize monitor downtime.

Excess Emissions - Any period in which the emissions exceed the permit limits.

Monitor Downtime - Any period during which the CEMS/COMS is unable to sample, analyze and record a minimum of four evenly spaced data points over an hour, except during one daily zero-span check during which two data points per hour are sufficient.

Out-of-Control Period - Begins with the time corresponding to the completion of the fifth, consecutive, daily CD check with a CD in excess of two times the allowable limit, or the time corresponding to the completion of the daily CD check preceding the daily CD check that results in a CD in excess of four times the allowable limit and the time corresponding to the completion of the sampling for the Relative Accuracy Test Audit (RATA), Relative Accuracy Audit (RAA), or Cylinder Gas Audit (CGA) which exceeds the limits outlined in Section IV. Out-of-Control Period ends with the time corresponding to the completion of the CD check following corrective action with the results being within the allowable CD limit or the completion of the sampling of the subsequent successful RATA, RAA, or CGA.

Primary CEMS - The main reporting CEMS with the ability to sample, analyze, and record stack pollutant to determine gas concentration and/or emission rate.

Relative Accuracy (RA) - The absolute mean difference between the gas concentration or emission rate determined by the CEMS and the value determined by the reference method plus the 2.5 percent error confidence coefficient of a series of tests divided by the mean of the reference method tests of the applicable emission limit.

Span Value – The upper limit of a gas concentration measurement range.

SECTION II

MONITORING REQUIREMENTS

** Only CEMS/COMS required by ADEQ permit for reasons other than Part 60, 63 or 75 shall comply with this section.

- A. For new sources, the installation date for the CEMS/COMS shall be no later than thirty (30) days from the date of start-up of the source.
- B. For existing sources, the installation date for the CEMS/COMS shall be no later than sixty (60) days from the issuance of the permit unless the permit requires a specific date.
- C. Within sixty (60) days of installation of a CEMS/COMS, a performance specification test (PST) must be completed. PST's are defined in 40 CFR, Part 60, Appendix B, PS 1-9. The Department may accept alternate PST's for pollutants not covered by Appendix B on a case-by-case basis. Alternate PST's shall be approved, in writing, by the ADEQ CEM Coordinator prior to testing.
- D. Each CEMS/COMS shall have, as a minimum, a daily zero-span check. The zero-span shall be adjusted whenever the 24-hour zero or 24-hour span drift exceeds two times the limits in the applicable performance specification in 40 CFR, Part 60, Appendix B. Before any adjustments are made to either the zero or span drifts measured at the 24-hour interval, the excess zero and span drifts measured must be quantified and recorded.
- E. All CEMS/COMS shall be in continuous operation and shall meet minimum frequency of operation requirements of 95% up-time for each quarter for each pollutant measured. Percent of monitor down-time is calculated by dividing the total minutes the monitor is not in operation by the total time in the calendar quarter and multiplying by one hundred. Failure to maintain operation time shall constitute a violation of the CEMS conditions.
- F. Percent of excess emissions are calculated by dividing the total minutes of excess emissions by the total time the source operated and multiplying by one hundred. Failure to maintain compliance may constitute a violation of the CEMS conditions.
- G. All CEMS measuring emissions shall complete a minimum of one cycle of operation (sampling, analyzing, and data recording) for each successive fifteen minute period unless more cycles are required by the permit. For each CEMS, one-hour averages shall be computed from four or more data points equally spaced over each one hour period unless more data points are required by the permit.
- H. All COMS shall complete a minimum of one cycle of sampling and analyzing for each successive 10-second period and one cycle of data recording for each successive 6-minute period.
- I. When the pollutant from a single affected facility is released through more than one point, a CEMS/COMS shall be installed on each point unless installation of fewer systems is approved, in writing, by the ADEQ

CEM Coordinator. When more than one CEM/COM is used to monitor emissions from one affected facility the owner or operator shall report the results as required from each CEMS/COMS.

SECTION III

NOTIFICATION AND RECORD KEEPING

** All CEMS/COMS shall comply with this section.

- A. When requested to do so by an owner or operator, the ADEQ CEM Coordinator will review plans for installation or modification for the purpose of providing technical advice to the owner or operator.
- B. Each facility which operates a CEMS/COMS shall notify the ADEQ CEM Coordinator of the date for which the demonstration of the CEMS/COMS performance will commence (i.e. PST, RATA, RAA, CGA). Notification shall be received in writing no less than 15 business days prior to testing. Performance test results shall be submitted to the Department within thirty days after completion of testing.
- C. Each facility which operates a CEMS/COMS shall maintain records of the occurrence and duration of start up/shut down, cleaning/soot blowing, process problems, fuel problems, or other malfunction in the operation of the affected facility which causes excess emissions. This includes any malfunction of the air pollution control equipment or any period during which a continuous monitoring device/system is inoperative.
- D. Each facility required to install a CEMS/COMS shall submit an excess emission and monitoring system performance report to the Department (Attention: Air Division, CEM Coordinator) at least quarterly, unless more frequent submittals are warranted to assess the compliance status of the facility. Quarterly reports shall be postmarked no later than the 30th day of the month following the end of each calendar quarter.
- E. All excess emissions shall be reported in terms of the applicable standard. Each report shall be submitted on ADEQ Quarterly Excess Emission Report Forms. Alternate forms may be used with prior written approval from the Department.
- F. Each facility which operates a CEMS/COMS must maintain on site a file of CEMS/COMS data including all raw data, corrected and adjusted, repair logs, calibration checks, adjustments, and test audits. This file must be retained for a period of at least five years, and is required to be maintained in such a condition that it can easily be audited by an inspector.
- G. Quarterly reports shall be used by the Department to determine compliance with the permit.

SECTION IV

QUALITY ASSURANCE/QUALITY CONTROL

** Only CEMS/COMS required by ADEQ permit for reasons other than Part 60, 63 or 75 shall comply with this section.

- A. For each CEMS/COMS a Quality Assurance/Quality Control (QA/QC) plan shall be submitted to the Department (Attn.: Air Division, CEM Coordinator). CEMS quality assurance procedures are defined in 40 CFR, Part 60, Appendix F. This plan shall be submitted within 180 days of the CEMS/COMS installation. A QA/QC plan shall consist of procedure and practices which assures acceptable level of monitor data accuracy, precision, representativeness, and availability.
- B. The submitted QA/QC plan for each CEMS/COMS shall not be considered as accepted until the facility receives a written notification of acceptance from the Department.
- C. Facilities responsible for one, or more, CEMS/COMS used for compliance monitoring shall meet these minimum requirements and are encouraged to develop and implement a more extensive QA/QC program, or to continue such programs where they already exist. Each QA/QC program must include written procedures which should describe in detail, complete, step-by-step procedures and operations for each of the following activities:
 - 1. Calibration of CEMS/COMS
 - a. Daily calibrations (including the approximate time(s) that the daily zero and span drifts will be checked and the time required to perform these checks and return to stable operation)
 - 2. Calibration drift determination and adjustment of CEMS/COMS
 - a. Out-of-control period determination
 - b. Steps of corrective action
 - 3. Preventive maintenance of CEMS/COMS
 - a. CEMS/COMS information
 - 1) Manufacture
 - 2) Model number
 - 3) Serial number
 - b. Scheduled activities (check list)
 - c. Spare part inventory
 - 4. Data recording, calculations, and reporting
 - 5. Accuracy audit procedures including sampling and analysis methods
 - 6. Program of corrective action for malfunctioning CEMS/COMS
- D. A Relative Accuracy Test Audit (RATA), shall be conducted at least once every four calendar quarters. A Relative Accuracy Audit (RAA), or a Cylinder Gas Audit (CGA), may be conducted in the other three

quarters but in no more than three quarters in succession. The RATA should be conducted in accordance with the applicable test procedure in 40 CFR Part 60 Appendix A and calculated in accordance with the applicable performance specification in 40 CFR Part 60 Appendix B. CGA's and RAA's should be conducted and the data calculated in accordance with the procedures outlined on 40 CFR Part 60 Appendix F.

If alternative testing procedures or methods of calculation are to be used in the RATA, RAA or CGA audits prior authorization must be obtained from the ADEQ CEM Coordinator.

E. Criteria for excessive audit inaccuracy.

RATA

All Pollutants except Carbon Monoxide	> 20% Relative Accuracy
Carbon Monoxide	> 10% Relative Accuracy
All Pollutants except Carbon Monoxide	> 10% of the Applicable Standard
Carbon Monoxide	> 5% of the Applicable Standard
Diluent (O ₂ & CO ₂)	> 1.0 % O ₂ or CO ₂
Flow	> 20% Relative Accuracy

CGA

Pollutant	> 15% of average audit value or 5 ppm difference
Diluent (O ₂ & CO ₂)	> 15% of average audit value or 5 ppm difference

RAA

Pollutant	> 15% of the three run average or > 7.5 % of the applicable standard
Diluent (O ₂ & CO ₂)	> 15% of the three run average or > 7.5 % of the applicable standard

- F. If either the zero or span drift results exceed two times the applicable drift specification in 40 CFR, Part 60, Appendix B for five consecutive, daily periods, the CEMS is out-of-control. If either the zero or span drift results exceed four times the applicable drift specification in Appendix B during a calibration drift check, the CEMS is out-of-control. If the CEMS exceeds the audit inaccuracies listed above, the CEMS is out-of-control. If a CEMS is out-of-control, the data from that out-of-control period is not counted towards meeting the minimum data availability as required and described in the applicable subpart. The end of the out-of-control period is the time corresponding to the completion of the successful daily zero or span drift or completion of the successful CGA, RAA or RATA.
- G. A back-up monitor may be placed on an emission source to minimize monitor downtime. This back-up CEMS is subject to the same QA/QC procedure and practices as the primary CEMS. The back-up CEMS shall be certified by a PST. Daily zero-span checks must be performed and recorded in accordance with standard practices. When the primary CEMS goes down, the back-up CEMS may then be engaged to sample, analyze and record the emission source pollutant until repairs are made and the primary unit is placed back in service. Records must be maintained on site when the back-up CEMS is placed in service, these records shall include at a minimum the reason the primary CEMS is out of service, the date and time the primary CEMS was out of service and the date and time the primary CEMS was placed back in service.

Appendix M – Waste Fired Boiler Recovered Energy Calculation Plan

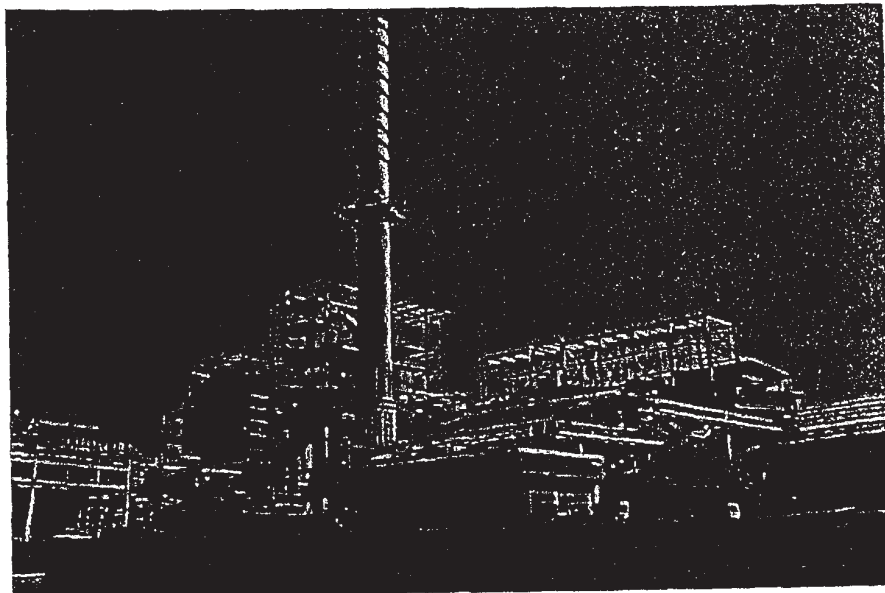

**WFB Recovered Energy Calculation Plan
El Dorado Facility
El Dorado, AR**

TITLE: WFB Recovered Energy Calculation Plan	SOP No.: 69EL-2009-	Page 2 of 4
--	------------------------	-------------

TITLE: WFB Recovered Energy Calculation Plan			
Facility: Clean Harbors El Dorado	Prepared by: S. Shoemaker	SOP Number: 69EL-2009-	Page 2 of 4
Reviewed By: Scot Shoemaker	Title: Maintenance Manager		
Reviewed By: Russell Hargiss	Title: Health and Safety Manager	Issue Date: 3/11/09	
Approved By: Ron Hines	Title: General Manager	Next Review Date: 3/11/10	

1.0 Objective

Clean Harbors El Dorado operates a waste fired boiler (WFB) that does not qualify as a MACT boiler according to regulation 63.1217. Clean Harbors El Dorado does not utilize more than 74% of the recovered energy from the WFB as calculated on an annual basis and documented monthly. The facility is required to document these calculations as part of its Air Permit #1009-AOP-R5. This procedure describes the method utilized to demonstrate compliance with this requirement.

2.0 Site Specific Terms

WFB – Waste Fired Boiler

3.0 Responsibilities

The General Manager will ensure that all employees are trained and knowledgeable regarding the proper operating procedures.

The Maintenance Manager and Supervisors are responsible for monitoring, and enforcing this procedure with the employees.

Employees are responsible for following and adhering to safe work practices and all provisions found in this procedure.

4.0 Prerequisites

- 1) Plant instrument and PLC training and knowledge.

5.0 Procedure

Clean Harbors El Dorado's renewed Title V air permit has the following two (2) specific conditions regarding the operation of the WFB:

- SC # 13 The permittee shall not utilize more than 74% of the recovered energy, calculated on an annual basis, from the liquid waste fired boiler at SN-01. The permit shall maintain monthly records to demonstrate compliance with this specific condition. These records shall be updated the 15th day of the month following the month to which the records pertain, shall be kept on site and shall be

TITLE: WFB Recovered Energy Calculation Plan	SOP No.: 69EL-2009-	Page 3 of 4
--	------------------------	-------------

provided to the ADEQ personnel upon request. A 12-month rolling average and each individual month's data shall be submitted in accordance with GP #7.

SC #14 A plan for calculating the energy utilization rate of the liquid fired boiler at SN-01 shall be submitted to the ADEQ for approval within 60 days of the date of issuance of Permit #1009-AOP-R5.

This SOP represents the plan for complying with specific condition (SC #14) above. Compliance with SC #13 is described below.

The definition of recovered energy for the purpose of this plan will be the total steam output of the WFB outlet header measured in pounds per hour (#/hr). To determine the utilization of the total steam output of the WFB the steam flow in pounds per hour (#/hr) will be tracked to the processes that are recovering the energy. Clean Harbors El Dorado currently has only two (2) processes that utilize the recovered energy and they are:

Brine Recovery Process

Solvent Recovery Process

The steam utilized by these processes will be tracked and these flows will be considered the utilized recovered energy. Therefore, to determine compliance with SC #13 the following calculation will be used.

$$\text{WFB Recovered Energy \% (Er)} = \left[\frac{\{ \text{Brine Recovery Utilized Energy (\#/hr steam flow)} + \text{Solvent Recovery Utilized Energy (\#/hr steam flow)} \}}{\{ \text{WFB Total Energy Output (\#/hr steam flow)} \}} \right] \times 100$$

Any future site processes that utilize recovered energy from the WFB will be added to the calculation to determine compliance.

The WFB recovered energy calculation will be programmed into the PLC for tracking and for compliance demonstration. The monthly average will be documented on the 15th of every month per SC #13. These monthly averages will be used to calculate a 12-month rolling average to comply with reporting requirements under general provision (GP) #7.

To ensure the accuracy of the calculation the instruments used to measure the steam flow will be calibrated on a set schedule. All steam flow measurements will be determined by taking a differential pressure across an orifice plate and the signal will be converted into an analog measurement of flow in pounds per hour. To maintain the accuracy of these measurement devices the following calibrations will be performed and documented.

TITLE: WFB Recovered Energy Calculation Plan	SOP No.: 69EL-2009-	Page 4 of 4
--	------------------------	-------------

Quarterly

The following differential pressure flow transmitters will be calibrated using a calibrated Fluke 725 meter with a Fluke 700 series pressure module or equivalent. All taps and connections will be cleared and checked to be leak free.

- 126FT426 Waste Fired Boiler Steam Flow
- 108FITXXXX Brine Recovery Unit Steam Flow
- 600FT118 Solvent Recovery Steam Flow

Annually

Orifice plates associated with the following differential pressure flow transmitters will be removed and measured to ensure the orifice diameter is not worn greater than 0.5% of the design diameter. If the orifice plate is worn >0.5% of the design diameter the orifice plate will be replaced.

- 126FT426 Waste Fired Boiler Steam Flow
- 108FITXXXX Brine Recovery Unit Steam Flow
- 600FT118 Solvent Recovery Steam Flow

6.0 Consequences of Deviations

- Calculation Error(s)
- Non-compliance with Title V Air Permit

7.0 Appendices

Approvals

General Manger

Incineration Manager

Facility Engineering Manager

Compliance Manager

Appendix N - 40 CFR Part 63, Subpart ZZZZ

ELECTRONIC CODE OF FEDERAL REGULATIONS

e-CFR Data is current as of August 30, 2013

Title 40: Protection of Environment

PART 63—NATIONAL EMISSION STANDARDS FOR HAZARDOUS AIR POLLUTANTS FOR SOURCE CATEGORIES (CONTINUED)

Subpart ZZZZ—National Emissions Standards for Hazardous Air Pollutants for Stationary Reciprocating Internal Combustion Engines

Contents

WHAT THIS SUBPART COVERS

- § 63.6580 What is the purpose of subpart ZZZZ?
- § 63.6585 Am I subject to this subpart?
- § 63.6590 What parts of my plant does this subpart cover?
- § 63.6595 When do I have to comply with this subpart?

EMISSION AND OPERATING LIMITATIONS

- § 63.6600 What emission limitations and operating limitations must I meet if I own or operate a stationary RICE with a site rating of more than 500 brake HP located at a major source of HAP emissions?
- § 63.6601 What emission limitations must I meet if I own or operate a new or reconstructed 4SLB stationary RICE with a site rating of greater than or equal to 250 brake HP and less than or equal to 500 brake HP located at a major source of HAP emissions?
- § 63.6602 What emission limitations and other requirements must I meet if I own or operate an existing stationary RICE with a site rating of equal to or less than 500 brake HP located at a major source of HAP emissions?
- § 63.6603 What emission limitations, operating limitations, and other requirements must I meet if I own or operate an existing stationary RICE located at an area source of HAP emissions?
- § 63.6604 What fuel requirements must I meet if I own or operate a stationary CI RICE?

GENERAL COMPLIANCE REQUIREMENTS

- § 63.6605 What are my general requirements for complying with this subpart?

TESTING AND INITIAL COMPLIANCE REQUIREMENTS

- § 63.6610 By what date must I conduct the initial performance tests or other initial compliance demonstrations if I own or operate a stationary RICE with a site rating of more than 500 brake HP located at a major source of HAP emissions?
- § 63.6611 By what date must I conduct the initial performance tests or other initial compliance demonstrations if I own or operate a new or reconstructed 4SLB SI stationary RICE with a site rating of greater than or equal to 250 and less than or equal to 500 brake HP located at a major source of HAP emissions?
- § 63.6612 By what date must I conduct the initial performance tests or other initial compliance demonstrations if I own or operate an existing stationary RICE with a site rating of less than or equal to 500 brake HP located at a major source of HAP emissions or an existing stationary RICE located at an area source of HAP emissions?

- § 63.6615 When must I conduct subsequent performance tests?
- § 63.6620 What performance tests and other procedures must I use?
- § 63.6625 What are my monitoring, installation, collection, operation, and maintenance requirements?
- § 63.6630 How do I demonstrate initial compliance with the emission limitations, operating limitations, and other requirements?

CONTINUOUS COMPLIANCE REQUIREMENTS

- § 63.6635 How do I monitor and collect data to demonstrate continuous compliance?
- § 63.6640 How do I demonstrate continuous compliance with the emission limitations, operating limitations, and other requirements?

NOTIFICATIONS, REPORTS, AND RECORDS

- § 63.6645 What notifications must I submit and when?
- § 63.6650 What reports must I submit and when?
- § 63.6655 What records must I keep?
- § 63.6660 In what form and how long must I keep my records?

OTHER REQUIREMENTS AND INFORMATION

- § 63.6665 What parts of the General Provisions apply to me?
- § 63.6670 Who implements and enforces this subpart?
- § 63.6675 What definitions apply to this subpart?
- Table 1 a to Subpart ZZZZ of Part 63—Emission Limitations for Existing, New, and Reconstructed Spark Ignition, 4SRB Stationary RICE > 500 HP Located at a Major Source of HAP Emissions
- Table 1 b to Subpart ZZZZ of Part 63—Operating Limitations for Existing, New, and Reconstructed SI 4SRB Stationary RICE >500 HP Located at a Major Source of HAP Emissions
- Table 2 a to Subpart ZZZZ of Part 63—Emission Limitations for New and Reconstructed 2SLB and Compression Ignition Stationary RICE >500 HP and New and Reconstructed 4SLB Stationary RICE ≥250 HP Located at a Major Source of HAP Emissions
- Table 2 b to Subpart ZZZZ of Part 63—Operating Limitations for New and Reconstructed 2SLB and CI Stationary RICE >500 HP Located at a Major Source of HAP Emissions, New and Reconstructed 4SLB Stationary RICE ≥250 HP Located at a Major Source of HAP Emissions, Existing CI Stationary RICE >500 HP
- Table 2 c to Subpart ZZZZ of Part 63—Requirements for Existing Compression Ignition Stationary RICE Located at a Major Source of HAP Emissions and Existing Spark Ignition Stationary RICE ≤500 HP Located at a Major Source of HAP Emissions
- Table 2 d to Subpart ZZZZ of Part 63—Requirements for Existing Stationary RICE Located at Area Sources of HAP Emissions
- Table 3 to Subpart ZZZZ of Part 63—Subsequent Performance Tests
- Table 4 to Subpart ZZZZ of Part 63—Requirements for Performance Tests
- Table 5 to Subpart ZZZZ of Part 63—Initial Compliance With Emission Limitations, Operating Limitations, and Other Requirements
- Table 6 to Subpart ZZZZ of Part 63—Continuous Compliance With Emission Limitations, and Other Requirements
- Table 7 to Subpart ZZZZ of Part 63—Requirements for Reports
- Table 8 to Subpart ZZZZ of Part 63—Applicability of General Provisions to Subpart ZZZZ.
- Appendix A—Protocol for Using an Electrochemical Analyzer to Determine Oxygen and Carbon Monoxide Concentrations From Certain Engines

SOURCE: 69 FR 33506, June 15, 2004, unless otherwise noted.

What This Subpart Covers

§ 63.6580 What is the purpose of subpart ZZZZ?

Subpart ZZZZ establishes national emission limitations and operating limitations for hazardous air pollutants (HAP) emitted from stationary reciprocating internal combustion engines (RICE) located at major and area sources of HAP emissions. This subpart also establishes requirements to demonstrate initial and continuous compliance with the emission limitations and operating limitations.

[73 FR 3603, Jan. 18, 2008]

§ 63.6585 Am I subject to this subpart?

You are subject to this subpart if you own or operate a stationary RICE at a major or area source of HAP emissions, except if the stationary RICE is being tested at a stationary RICE test cell/stand.

(a) A stationary RICE is any internal combustion engine which uses reciprocating motion to convert heat energy into mechanical work and which is not mobile. Stationary RICE differ from mobile RICE in that a stationary RICE is not a non-road engine as defined at 40 CFR 1068.30, and is not used to propel a motor vehicle or a vehicle used solely for competition.

(b) A major source of HAP emissions is a plant site that emits or has the potential to emit any single HAP at a rate of 10 tons (9.07 megagrams) or more per year or any combination of HAP at a rate of 25 tons (22.68 megagrams) or more per year, except that for oil and gas production facilities, a major source of HAP emissions is determined for each surface site.

(c) An area source of HAP emissions is a source that is not a major source.

(d) If you are an owner or operator of an area source subject to this subpart, your status as an entity subject to a standard or other requirements under this subpart does not subject you to the obligation to obtain a permit under 40 CFR part 70 or 71, provided you are not required to obtain a permit under 40 CFR 70.3(a) or 40 CFR 71.3(a) for a reason other than your status as an area source under this subpart. Notwithstanding the previous sentence, you must continue to comply with the provisions of this subpart as applicable.

(e) If you are an owner or operator of a stationary RICE used for national security purposes, you may be eligible to request an exemption from the requirements of this subpart as described in 40 CFR part 1068, subpart C.

(f) The emergency stationary RICE listed in paragraphs (f)(1) through (3) of this section are not subject to this subpart. The stationary RICE must meet the definition of an emergency stationary RICE in § 63.6675, which includes operating according to the provisions specified in § 63.6640(f).

(1) Existing residential emergency stationary RICE located at an area source of HAP emissions that do not operate or are not contractually obligated to be available for more than 15 hours per calendar year for the purposes specified in § 63.6640(f)(2)(ii) and (iii) and that do not operate for the purpose specified in § 63.6640(f)(4)(ii).

(2) Existing commercial emergency stationary RICE located at an area source of HAP emissions that do not operate or are not contractually obligated to be available for more than 15 hours per calendar year for the purposes specified in § 63.6640(f)(2)(ii) and (iii) and that do not operate for the purpose specified in § 63.6640(f)(4)(ii).

(3) Existing institutional emergency stationary RICE located at an area source of HAP emissions that do not operate or are not contractually obligated to be available for more than 15 hours per calendar year for the purposes specified in § 63.6640(f)(2)(ii) and (iii) and that do not operate for the purpose specified in § 63.6640(f)(4)(ii).

[69 FR 33506, June 15, 2004, as amended at 73 FR 3603, Jan. 18, 2008; 78 FR 6700, Jan. 30, 2013]

§ 63.6590 What parts of my plant does this subpart cover?

This subpart applies to each affected source.

(a) *Affected source.* An affected source is any existing, new, or reconstructed stationary RICE located at a major or area source of HAP emissions, excluding stationary RICE being tested at a stationary RICE test cell/stand.

(1) *Existing stationary RICE.*

(i) For stationary RICE with a site rating of more than 500 brake horsepower (HP) located at a major source of HAP emissions, a stationary RICE is existing if you commenced construction or reconstruction of the stationary RICE before December 19, 2002.

(ii) For stationary RICE with a site rating of less than or equal to 500 brake HP located at a major source of HAP emissions, a stationary RICE is existing if you commenced construction or reconstruction of the stationary RICE before June 12, 2006.

(iii) For stationary RICE located at an area source of HAP emissions, a stationary RICE is existing if you commenced construction or reconstruction of the stationary RICE before June 12, 2006.

(iv) A change in ownership of an existing stationary RICE does not make that stationary RICE a new or reconstructed stationary RICE.

(2) *New stationary RICE.* (i) A stationary RICE with a site rating of more than 500 brake HP located at a major source of HAP emissions is new if you commenced construction of the stationary RICE on or after December 19, 2002.

(ii) A stationary RICE with a site rating of equal to or less than 500 brake HP located at a major source of HAP emissions is new if you commenced construction of the stationary RICE on or after June 12, 2006.

(iii) A stationary RICE located at an area source of HAP emissions is new if you commenced construction of the stationary RICE on or after June 12, 2006.

(3) *Reconstructed stationary RICE.* (i) A stationary RICE with a site rating of more than 500 brake HP located at a major source of HAP emissions is reconstructed if you meet the definition of reconstruction in § 63.2 and reconstruction is commenced on or after December 19, 2002.

(ii) A stationary RICE with a site rating of equal to or less than 500 brake HP located at a major source of HAP emissions is reconstructed if you meet the definition of reconstruction in § 63.2 and reconstruction is commenced on or after June 12, 2006.

(iii) A stationary RICE located at an area source of HAP emissions is reconstructed if you meet the definition of reconstruction in § 63.2 and reconstruction is commenced on or after June 12, 2006.

(b) *Stationary RICE subject to limited requirements.* (1) An affected source which meets either of the criteria in paragraphs (b)(1)(i) through (ii) of this section does not have to meet the requirements of this subpart and of subpart A of this part except for the initial notification requirements of § 63.6645(f).

(i) The stationary RICE is a new or reconstructed emergency stationary RICE with a site rating of more than 500 brake HP located at a major source of HAP emissions that does not operate or is not contractually obligated to be available for more than 15 hours per calendar year for the purposes specified in § 63.6640(f)(2)(ii) and (iii).

(ii) The stationary RICE is a new or reconstructed limited use stationary RICE with a site rating of more than 500 brake HP located at a major source of HAP emissions.

(2) A new or reconstructed stationary RICE with a site rating of more than 500 brake HP located at a major source of HAP emissions which combusts landfill or digester gas equivalent to 10 percent or more of the gross heat input on an annual basis must meet the initial notification requirements of § 63.6645(f) and the requirements of §§ 63.6625(c), 63.6650(g), and 63.6655(c). These stationary RICE do not have to meet the emission limitations and operating limitations of this subpart.

(3) The following stationary RICE do not have to meet the requirements of this subpart and of subpart A of this part, including initial notification requirements:

(i) Existing spark ignition 2 stroke lean burn (2SLB) stationary RICE with a site rating of more than 500 brake HP located at a major source of HAP emissions;

(ii) Existing spark ignition 4 stroke lean burn (4SLB) stationary RICE with a site rating of more than 500 brake HP located at a major source of HAP emissions;

(iii) Existing emergency stationary RICE with a site rating of more than 500 brake HP located at a major source of HAP emissions that does not operate or is not contractually obligated to be available for more than 15 hours per calendar year for the purposes specified in § 63.6640(f)(2)(ii) and (iii).

(iv) Existing limited use stationary RICE with a site rating of more than 500 brake HP located at a major source of HAP emissions;

(v) Existing stationary RICE with a site rating of more than 500 brake HP located at a major source of HAP emissions that combusts landfill gas or digester gas equivalent to 10 percent or more of the gross heat input on an annual basis;

(c) *Stationary RICE subject to Regulations under 40 CFR Part 60.* An affected source that meets any of the criteria in paragraphs (c)(1) through (7) of this section must meet the requirements of this part by meeting the requirements of 40 CFR part 60 subpart IIII, for compression ignition engines or 40 CFR part 60 subpart JJJJ, for spark ignition engines. No further requirements apply for such engines under this part.

(1) A new or reconstructed stationary RICE located at an area source;

(2) A new or reconstructed 2SLB stationary RICE with a site rating of less than or equal to 500 brake HP located at a major source of HAP emissions;

(3) A new or reconstructed 4SLB stationary RICE with a site rating of less than 250 brake HP located at a major source of HAP emissions;

(4) A new or reconstructed spark ignition 4 stroke rich burn (4SRB) stationary RICE with a site rating of less than or equal to 500 brake HP located at a major source of HAP emissions;

(5) A new or reconstructed stationary RICE with a site rating of less than or equal to 500 brake HP located at a major source of HAP emissions which combusts landfill or digester gas equivalent to 10 percent or more of the gross heat input on an annual basis;

(6) A new or reconstructed emergency or limited use stationary RICE with a site rating of less than or equal to 500 brake HP located at a major source of HAP emissions;

(7) A new or reconstructed compression ignition (CI) stationary RICE with a site rating of less than or equal to 500 brake HP located at a major source of HAP emissions.

[69 FR 33506, June 15, 2004, as amended at 73 FR 3604, Jan. 18, 2008; 75 FR 9674, Mar. 3, 2010; 75 FR 37733, June 30, 2010; 75 FR 51588, Aug. 20, 2010; 78 FR 6700, Jan. 30, 2013]

§ 63.6595 When do I have to comply with this subpart?

(a) *Affected sources.* (1) If you have an existing stationary RICE, excluding existing non-emergency CI stationary RICE, with a site rating of more than 500 brake HP located at a major source of HAP emissions, you must comply with the applicable emission limitations, operating limitations and other requirements no later than June 15, 2007. If you have an existing non-emergency CI stationary RICE with a site rating of more than 500 brake HP located at a major source of HAP emissions, an existing stationary CI RICE with a site rating of less than or equal to 500 brake HP located at a major source of HAP emissions, or an existing stationary CI RICE located at an area source of HAP emissions, you must comply with the applicable emission limitations, operating limitations, and other

requirements no later than May 3, 2013. If you have an existing stationary SI RICE with a site rating of less than or equal to 500 brake HP located at a major source of HAP emissions, or an existing stationary SI RICE located at an area source of HAP emissions, you must comply with the applicable emission limitations, operating limitations, and other requirements no later than October 19, 2013.

(2) If you start up your new or reconstructed stationary RICE with a site rating of more than 500 brake HP located at a major source of HAP emissions before August 16, 2004, you must comply with the applicable emission limitations and operating limitations in this subpart no later than August 16, 2004.

(3) If you start up your new or reconstructed stationary RICE with a site rating of more than 500 brake HP located at a major source of HAP emissions after August 16, 2004, you must comply with the applicable emission limitations and operating limitations in this subpart upon startup of your affected source.

(4) If you start up your new or reconstructed stationary RICE with a site rating of less than or equal to 500 brake HP located at a major source of HAP emissions before January 18, 2008, you must comply with the applicable emission limitations and operating limitations in this subpart no later than January 18, 2008.

(5) If you start up your new or reconstructed stationary RICE with a site rating of less than or equal to 500 brake HP located at a major source of HAP emissions after January 18, 2008, you must comply with the applicable emission limitations and operating limitations in this subpart upon startup of your affected source.

(6) If you start up your new or reconstructed stationary RICE located at an area source of HAP emissions before January 18, 2008, you must comply with the applicable emission limitations and operating limitations in this subpart no later than January 18, 2008.

(7) If you start up your new or reconstructed stationary RICE located at an area source of HAP emissions after January 18, 2008, you must comply with the applicable emission limitations and operating limitations in this subpart upon startup of your affected source.

(b) *Area sources that become major sources.* If you have an area source that increases its emissions or its potential to emit such that it becomes a major source of HAP, the compliance dates in paragraphs (b)(1) and (2) of this section apply to you.

(1) Any stationary RICE for which construction or reconstruction is commenced after the date when your area source becomes a major source of HAP must be in compliance with this subpart upon startup of your affected source.

(2) Any stationary RICE for which construction or reconstruction is commenced before your area source becomes a major source of HAP must be in compliance with the provisions of this subpart that are applicable to RICE located at major sources within 3 years after your area source becomes a major source of HAP.

(c) If you own or operate an affected source, you must meet the applicable notification requirements in § 63.6645 and in 40 CFR part 63, subpart A.

[69 FR 33506, June 15, 2004, as amended at 73 FR 3604, Jan. 18, 2008; 75 FR 9675, Mar. 3, 2010; 75 FR 51589, Aug. 20, 2010; 78 FR 6701, Jan. 30, 2013]

Emission and Operating Limitations

§ 63.6600 What emission limitations and operating limitations must I meet if I own or operate a stationary RICE with a site rating of more than 500 brake HP located at a major source of HAP emissions?

Compliance with the numerical emission limitations established in this subpart is based on the results of testing the average of three 1-hour runs using the testing requirements and procedures in § 63.6620 and Table 4 to this subpart.

(a) If you own or operate an existing, new, or reconstructed spark ignition 4SRB stationary RICE with a site rating of more than 500 brake HP located at a major source of HAP emissions, you must comply with the emission limitations in Table 1a to this subpart and the operating limitations in Table 1b to this subpart which apply to you.

(b) If you own or operate a new or reconstructed 2SLB stationary RICE with a site rating of more than 500 brake HP located at major source of HAP emissions, a new or reconstructed 4SLB stationary RICE with a site rating of more than 500 brake HP located at major source of HAP emissions, or a new or reconstructed CI stationary RICE with a site rating of more than 500 brake HP located at a major source of HAP emissions, you must comply with the emission limitations in Table 2a to this subpart and the operating limitations in Table 2b to this subpart which apply to you.

(c) If you own or operate any of the following stationary RICE with a site rating of more than 500 brake HP located at a major source of HAP emissions, you do not need to comply with the emission limitations in Tables 1a, 2a, 2c, and 2d to this subpart or operating limitations in Tables 1b and 2b to this subpart: an existing 2SLB stationary RICE; an existing 4SLB stationary RICE; a stationary RICE that combusts landfill gas or digester gas equivalent to 10 percent or more of the gross heat input on an annual basis; an emergency stationary RICE; or a limited use stationary RICE.

(d) If you own or operate an existing non-emergency stationary CI RICE with a site rating of more than 500 brake HP located at a major source of HAP emissions, you must comply with the emission limitations in Table 2c to this subpart and the operating limitations in Table 2b to this subpart which apply to you.

[73 FR 3605, Jan. 18, 2008, as amended at 75 FR 9675, Mar. 3, 2010]

§ 63.6601 What emission limitations must I meet if I own or operate a new or reconstructed 4SLB stationary RICE with a site rating of greater than or equal to 250 brake HP and less than or equal to 500 brake HP located at a major source of HAP emissions?

Compliance with the numerical emission limitations established in this subpart is based on the results of testing the average of three 1-hour runs using the testing requirements and procedures in § 63.6620 and Table 4 to this subpart. If you own or operate a new or reconstructed 4SLB stationary RICE with a site rating of greater than or equal to 250 and less than or equal to 500 brake HP located at major source of HAP emissions manufactured on or after January 1, 2008, you must comply with the emission limitations in Table 2a to this subpart and the operating limitations in Table 2b to this subpart which apply to you.

[73 FR 3605, Jan. 18, 2008, as amended at 75 FR 9675, Mar. 3, 2010; 75 FR 51589, Aug. 20, 2010]

§ 63.6602 What emission limitations and other requirements must I meet if I own or operate an existing stationary RICE with a site rating of equal to or less than 500 brake HP located at a major source of HAP emissions?

If you own or operate an existing stationary RICE with a site rating of equal to or less than 500 brake HP located at a major source of HAP emissions, you must comply with the emission limitations and other requirements in Table 2c to this subpart which apply to you. Compliance with the numerical emission limitations established in this subpart is based on the results of testing the average of three 1-hour runs using the testing requirements and procedures in § 63.6620 and Table 4 to this subpart.

[78 FR 6701, Jan. 30, 2013]

§ 63.6603 What emission limitations, operating limitations, and other requirements must I meet if I own or operate an existing stationary RICE located at an area source of HAP emissions?

Compliance with the numerical emission limitations established in this subpart is based on the results of testing the average of three 1-hour runs using the testing requirements and procedures in § 63.6620 and Table 4 to this subpart.

(a) If you own or operate an existing stationary RICE located at an area source of HAP emissions, you must comply with the requirements in Table 2d to this subpart and the operating limitations in Table 2b to this subpart that apply to you.

(b) If you own or operate an existing stationary non-emergency CI RICE with a site rating of more than 300 HP located at an area source of HAP that meets either paragraph (b)(1) or (2) of this section, you do not have to meet the numerical CO emission limitations specified in Table 2d of this subpart. Existing stationary non-emergency CI RICE with a site rating of more than 300 HP located at an area source of HAP that meet either paragraph (b)(1) or (2) of this section must meet the management practices that are shown for stationary non-emergency CI RICE with a site rating of less than or equal to 300 HP in Table 2d of this subpart.

(1) The area source is located in an area of Alaska that is not accessible by the Federal Aid Highway System (FAHS).

(2) The stationary RICE is located at an area source that meets paragraphs (b)(2)(i), (ii), and (iii) of this section.

(i) The only connection to the FAHS is through the Alaska Marine Highway System (AMHS), or the stationary RICE operation is within an isolated grid in Alaska that is not connected to the statewide electrical grid referred to as the Alaska Railbelt Grid.

(ii) At least 10 percent of the power generated by the stationary RICE on an annual basis is used for residential purposes.

(iii) The generating capacity of the area source is less than 12 megawatts, or the stationary RICE is used exclusively for backup power for renewable energy.

(c) If you own or operate an existing stationary non-emergency CI RICE with a site rating of more than 300 HP located on an offshore vessel that is an area source of HAP and is a nonroad vehicle that is an Outer Continental Shelf (OCS) source as defined in 40 CFR 55.2, you do not have to meet the numerical CO emission limitations specified in Table 2d of this subpart. You must meet all of the following management practices:

(1) Change oil every 1,000 hours of operation or annually, whichever comes first. Sources have the option to utilize an oil analysis program as described in § 63.6625(i) in order to extend the specified oil change requirement.

(2) Inspect and clean air filters every 750 hours of operation or annually, whichever comes first, and replace as necessary.

(3) Inspect fuel filters and belts, if installed, every 750 hours of operation or annually, whichever comes first, and replace as necessary.

(4) Inspect all flexible hoses every 1,000 hours of operation or annually, whichever comes first, and replace as necessary.

(d) If you own or operate an existing non-emergency CI RICE with a site rating of more than 300 HP located at an area source of HAP emissions that is certified to the Tier 1 or Tier 2 emission standards in Table 1 of 40 CFR 89.112 and that is subject to an enforceable state or local standard that requires the engine to be replaced no later than June 1, 2018, you may until January 1, 2015, or 12 years after the installation date of the engine (whichever is later), but not later than June 1, 2018, choose to comply with the management practices that are shown for stationary non-emergency CI RICE with a site rating of less than or equal to 300 HP in Table 2d of this subpart instead of the applicable emission limitations in Table 2d, operating limitations in Table 2b, and crankcase ventilation

system requirements in § 63.6625(g). You must comply with the emission limitations in Table 2d and operating limitations in Table 2b that apply for non-emergency CI RICE with a site rating of more than 300 HP located at an area source of HAP emissions by January 1, 2015, or 12 years after the installation date of the engine (whichever is later), but not later than June 1, 2018. You must also comply with the crankcase ventilation system requirements in § 63.6625(g) by January 1, 2015, or 12 years after the installation date of the engine (whichever is later), but not later than June 1, 2018.

(e) If you own or operate an existing non-emergency CI RICE with a site rating of more than 300 HP located at an area source of HAP emissions that is certified to the Tier 3 (Tier 2 for engines above 560 kilowatt (kW)) emission standards in Table 1 of 40 CFR 89.112, you may comply with the requirements under this part by meeting the requirements for Tier 3 engines (Tier 2 for engines above 560 kW) in 40 CFR part 60 subpart IIII instead of the emission limitations and other requirements that would otherwise apply under this part for existing non-emergency CI RICE with a site rating of more than 300 HP located at an area source of HAP emissions.

(f) An existing non-emergency SI 4SLB and 4SRB stationary RICE with a site rating of more than 500 HP located at area sources of HAP must meet the definition of remote stationary RICE in § 63.6675 on the initial compliance date for the engine, October 19, 2013, in order to be considered a remote stationary RICE under this subpart. Owners and operators of existing non-emergency SI 4SLB and 4SRB stationary RICE with a site rating of more than 500 HP located at area sources of HAP that meet the definition of remote stationary RICE in § 63.6675 of this subpart as of October 19, 2013 must evaluate the status of their stationary RICE every 12 months. Owners and operators must keep records of the initial and annual evaluation of the status of the engine. If the evaluation indicates that the stationary RICE no longer meets the definition of remote stationary RICE in § 63.6675 of this subpart, the owner or operator must comply with all of the requirements for existing non-emergency SI 4SLB and 4SRB stationary RICE with a site rating of more than 500 HP located at area sources of HAP that are not remote stationary RICE within 1 year of the evaluation.

[75 FR 9675, Mar. 3, 2010, as amended at 75 FR 51589, Aug. 20, 2010; 76 FR 12866, Mar. 9, 2011; 78 FR 6701, Jan. 30, 2013]

§ 63.6604 What fuel requirements must I meet if I own or operate a stationary CI RICE?

(a) If you own or operate an existing non-emergency, non-black start CI stationary RICE with a site rating of more than 300 brake HP with a displacement of less than 30 liters per cylinder that uses diesel fuel, you must use diesel fuel that meets the requirements in 40 CFR 80.510(b) for nonroad diesel fuel.

(b) Beginning January 1, 2015, if you own or operate an existing emergency CI stationary RICE with a site rating of more than 100 brake HP and a displacement of less than 30 liters per cylinder that uses diesel fuel and operates or is contractually obligated to be available for more than 15 hours per calendar year for the purposes specified in § 63.6640(f)(2)(ii) and (iii) or that operates for the purpose specified in § 63.6640(f)(4)(ii), you must use diesel fuel that meets the requirements in 40 CFR 80.510(b) for nonroad diesel fuel, except that any existing diesel fuel purchased (or otherwise obtained) prior to January 1, 2015, may be used until depleted.

(c) Beginning January 1, 2015, if you own or operate a new emergency CI stationary RICE with a site rating of more than 500 brake HP and a displacement of less than 30 liters per cylinder located at a major source of HAP that uses diesel fuel and operates or is contractually obligated to be available for more than 15 hours per calendar year for the purposes specified in § 63.6640(f)(2)(ii) and (iii), you must use diesel fuel that meets the requirements in 40 CFR 80.510(b) for nonroad diesel fuel, except that any existing diesel fuel purchased (or otherwise obtained) prior to January 1, 2015, may be used until depleted.

(d) Existing CI stationary RICE located in Guam, American Samoa, the Commonwealth of the Northern Mariana Islands, at area sources in areas of Alaska that meet either § 63.6603(b)(1) or § 63.6603(b)(2), or are on offshore vessels that meet § 63.6603(c) are exempt from the requirements of this section.

[78 FR 6702, Jan. 30, 2013]

General Compliance Requirements

§ 63.6605 What are my general requirements for complying with this subpart?

(a) You must be in compliance with the emission limitations, operating limitations, and other requirements in this subpart that apply to you at all times.

(b) At all times you must operate and maintain any affected source, including associated air pollution control equipment and monitoring equipment, in a manner consistent with safety and good air pollution control practices for minimizing emissions. The general duty to minimize emissions does not require you to make any further efforts to reduce emissions if levels required by this standard have been achieved. Determination of whether such operation and maintenance procedures are being used will be based on information available to the Administrator which may include, but is not limited to, monitoring results, review of operation and maintenance procedures, review of operation and maintenance records, and inspection of the source.

[75 FR 9675, Mar. 3, 2010, as amended at 78 FR 6702, Jan. 30, 2013]

Testing and Initial Compliance Requirements

§ 63.6610 By what date must I conduct the initial performance tests or other initial compliance demonstrations if I own or operate a stationary RICE with a site rating of more than 500 brake HP located at a major source of HAP emissions?

If you own or operate a stationary RICE with a site rating of more than 500 brake HP located at a major source of HAP emissions you are subject to the requirements of this section.

(a) You must conduct the initial performance test or other initial compliance demonstrations in Table 4 to this subpart that apply to you within 180 days after the compliance date that is specified for your stationary RICE in § 63.6595 and according to the provisions in § 63.7(a)(2).

(b) If you commenced construction or reconstruction between December 19, 2002 and June 15, 2004 and own or operate stationary RICE with a site rating of more than 500 brake HP located at a major source of HAP emissions, you must demonstrate initial compliance with either the proposed emission limitations or the promulgated emission limitations no later than February 10, 2005 or no later than 180 days after startup of the source, whichever is later, according to § 63.7(a)(2)(ix).

(c) If you commenced construction or reconstruction between December 19, 2002 and June 15, 2004 and own or operate stationary RICE with a site rating of more than 500 brake HP located at a major source of HAP emissions, and you chose to comply with the proposed emission limitations when demonstrating initial compliance, you must conduct a second performance test to demonstrate compliance with the promulgated emission limitations by December 13, 2007 or after startup of the source, whichever is later, according to § 63.7(a)(2)(ix).

(d) An owner or operator is not required to conduct an initial performance test on units for which a performance test has been previously conducted, but the test must meet all of the conditions described in paragraphs (d)(1) through (5) of this section.

(1) The test must have been conducted using the same methods specified in this subpart, and these methods must have been followed correctly.

(2) The test must not be older than 2 years.

(3) The test must be reviewed and accepted by the Administrator.

(4) Either no process or equipment changes must have been made since the test was performed, or the owner or operator must be able to demonstrate that the results of the performance test, with or without adjustments, reliably demonstrate compliance despite process or equipment changes.

(5) The test must be conducted at any load condition within plus or minus 10 percent of 100 percent load.

[69 FR 33506, June 15, 2004, as amended at 73 FR 3605, Jan. 18, 2008]

§ 63.6611 By what date must I conduct the initial performance tests or other initial compliance demonstrations if I own or operate a new or reconstructed 4SLB SI stationary RICE with a site rating of greater than or equal to 250 and less than or equal to 500 brake HP located at a major source of HAP emissions?

If you own or operate a new or reconstructed 4SLB stationary RICE with a site rating of greater than or equal to 250 and less than or equal to 500 brake HP located at a major source of HAP emissions, you must conduct an initial performance test within 240 days after the compliance date that is specified for your stationary RICE in § 63.6595 and according to the provisions specified in Table 4 to this subpart, as appropriate.

[73 FR 3605, Jan. 18, 2008, as amended at 75 FR 51589, Aug. 20, 2010]

§ 63.6612 By what date must I conduct the initial performance tests or other initial compliance demonstrations if I own or operate an existing stationary RICE with a site rating of less than or equal to 500 brake HP located at a major source of HAP emissions or an existing stationary RICE located at an area source of HAP emissions?

If you own or operate an existing stationary RICE with a site rating of less than or equal to 500 brake HP located at a major source of HAP emissions or an existing stationary RICE located at an area source of HAP emissions you are subject to the requirements of this section.

(a) You must conduct any initial performance test or other initial compliance demonstration according to Tables 4 and 5 to this subpart that apply to you within 180 days after the compliance date that is specified for your stationary RICE in § 63.6595 and according to the provisions in § 63.7(a)(2).

(b) An owner or operator is not required to conduct an initial performance test on a unit for which a performance test has been previously conducted, but the test must meet all of the conditions described in paragraphs (b)(1) through (4) of this section.

(1) The test must have been conducted using the same methods specified in this subpart, and these methods must have been followed correctly.

(2) The test must not be older than 2 years.

(3) The test must be reviewed and accepted by the Administrator.

(4) Either no process or equipment changes must have been made since the test was performed, or the owner or operator must be able to demonstrate that the results of the performance test, with or without adjustments, reliably demonstrate compliance despite process or equipment changes.

[75 FR 9676, Mar. 3, 2010, as amended at 75 FR 51589, Aug. 20, 2010]

§ 63.6615 When must I conduct subsequent performance tests?

If you must comply with the emission limitations and operating limitations, you must conduct subsequent performance tests as specified in Table 3 of this subpart.

§ 63.6620 What performance tests and other procedures must I use?

(a) You must conduct each performance test in Tables 3 and 4 of this subpart that applies to you.

(b) Each performance test must be conducted according to the requirements that this subpart specifies in Table 4 to this subpart. If you own or operate a non-operational stationary RICE that is subject to performance testing, you do not need to start up the engine solely to conduct the performance test. Owners and operators of a non-operational engine can conduct the performance

test when the engine is started up again. The test must be conducted at any load condition within plus or minus 10 percent of 100 percent load for the stationary RICE listed in paragraphs (b)(1) through (4) of this section.

(1) Non-emergency 4SRB stationary RICE with a site rating of greater than 500 brake HP located at a major source of HAP emissions.

(2) New non-emergency 4SLB stationary RICE with a site rating of greater than or equal to 250 brake HP located at a major source of HAP emissions.

(3) New non-emergency 2SLB stationary RICE with a site rating of greater than 500 brake HP located at a major source of HAP emissions.

(4) New non-emergency CI stationary RICE with a site rating of greater than 500 brake HP located at a major source of HAP emissions.

(c) [Reserved]

(d) You must conduct three separate test runs for each performance test required in this section, as specified in § 63.7(e)(3). Each test run must last at least 1 hour, unless otherwise specified in this subpart.

(e)(1) You must use Equation 1 of this section to determine compliance with the percent reduction requirement:

$$\frac{C_i - C_o}{C_i} \times 100 = R \quad (\text{Eq. 1})$$

[View or download PDF](#)

Where:

C_i = concentration of carbon monoxide (CO), total hydrocarbons (THC), or formaldehyde at the control device inlet,

C_o = concentration of CO, THC, or formaldehyde at the control device outlet, and

R = percent reduction of CO, THC, or formaldehyde emissions.

(2) You must normalize the CO, THC, or formaldehyde concentrations at the inlet and outlet of the control device to a dry basis and to 15 percent oxygen, or an equivalent percent carbon dioxide (CO_2). If pollutant concentrations are to be corrected to 15 percent oxygen and CO_2 concentration is measured in lieu of oxygen concentration measurement, a CO_2 correction factor is needed. Calculate the CO_2 correction factor as described in paragraphs (e)(2)(i) through (iii) of this section.

(i) Calculate the fuel-specific F_o value for the fuel burned during the test using values obtained from Method 19, Section 5.2, and the following equation:

$$F_o = \frac{0.209 F_d}{F_c} \quad (\text{Eq. 2})$$

[View or download PDF](#)

Where:

F_o = Fuel factor based on the ratio of oxygen volume to the ultimate CO_2 volume produced by the fuel at zero percent excess air.

0.209 = Fraction of air that is oxygen, percent/100.

F_d = Ratio of the volume of dry effluent gas to the gross calorific value of the fuel from Method 19, dsm^3 / J ($\text{dscf}/10^6 \text{ Btu}$).

F_c = Ratio of the volume of CO_2 produced to the gross calorific value of the fuel from Method 19, dsm^3 / J ($\text{dscf}/10^6 \text{ Btu}$)

(ii) Calculate the CO_2 correction factor for correcting measurement data to 15 percent O_2 , as follows:

$$X_{\text{CO}_2} = \frac{5.9}{F_o} \quad (\text{Eq. 3})$$

[View or download PDF](#)

Where:

X_{CO_2} = CO_2 correction factor, percent.

5.9 = 20.9 percent O_2 — 15 percent O_2 , the defined O_2 correction value, percent.

(iii) Calculate the CO, THC, and formaldehyde gas concentrations adjusted to 15 percent O_2 using CO_2 as follows:

$$C_{\text{adj}} = C_d \frac{X_{\text{CO}_2}}{\% \text{CO}_2} \quad (\text{Eq. 4})$$

[View or download PDF](#)

Where:

C_{adj} = Calculated concentration of CO, THC, or formaldehyde adjusted to 15 percent O_2 .

C_d = Measured concentration of CO, THC, or formaldehyde, uncorrected.

X_{CO_2} = CO_2 correction factor, percent.

$\% \text{CO}_2$ = Measured CO_2 concentration measured, dry basis, percent.

(f) If you comply with the emission limitation to reduce CO and you are not using an oxidation catalyst, if you comply with the emission limitation to reduce formaldehyde and you are not using NSCR, or if you comply with the emission limitation to limit the concentration of formaldehyde in the stationary RICE exhaust and you are not using an oxidation catalyst or NSCR, you must petition the Administrator for operating limitations to be established during the initial performance test and continuously monitored thereafter; or for approval of no operating limitations. You must not conduct the initial performance test until after the petition has been approved by the Administrator.

(g) If you petition the Administrator for approval of operating limitations, your petition must include the information described in paragraphs (g)(1) through (5) of this section.

(1) Identification of the specific parameters you propose to use as operating limitations;

(2) A discussion of the relationship between these parameters and HAP emissions, identifying how HAP emissions change with changes in these parameters, and how limitations on these parameters will serve to limit HAP emissions;

(3) A discussion of how you will establish the upper and/or lower values for these parameters which will establish the limits on these parameters in the operating limitations;

(4) A discussion identifying the methods you will use to measure and the instruments you will use to monitor these parameters, as well as the relative accuracy and precision of these methods and instruments; and

(5) A discussion identifying the frequency and methods for recalibrating the instruments you will use for monitoring these parameters.

(h) If you petition the Administrator for approval of no operating limitations, your petition must include the information described in paragraphs (h)(1) through (7) of this section.

(1) Identification of the parameters associated with operation of the stationary RICE and any emission control device which could change intentionally (e.g., operator adjustment, automatic controller adjustment, etc.) or unintentionally (e.g., wear and tear, error, etc.) on a routine basis or over time;

(2) A discussion of the relationship, if any, between changes in the parameters and changes in HAP emissions;

(3) For the parameters which could change in such a way as to increase HAP emissions, a discussion of whether establishing limitations on the parameters would serve to limit HAP emissions;

(4) For the parameters which could change in such a way as to increase HAP emissions, a discussion of how you could establish upper and/or lower values for the parameters which would establish limits on the parameters in operating limitations;

(5) For the parameters, a discussion identifying the methods you could use to measure them and the instruments you could use to monitor them, as well as the relative accuracy and precision of the methods and instruments;

(6) For the parameters, a discussion identifying the frequency and methods for recalibrating the instruments you could use to monitor them; and

(7) A discussion of why, from your point of view, it is infeasible or unreasonable to adopt the parameters as operating limitations.

(i) The engine percent load during a performance test must be determined by documenting the calculations, assumptions, and measurement devices used to measure or estimate the percent load in a specific application. A written report of the average percent load determination must be included in the notification of compliance status. The following information must be included in the written report: the engine model number, the engine manufacturer, the year of purchase, the manufacturer's site-rated brake horsepower, the ambient temperature, pressure, and humidity during the performance test, and all assumptions that were made to estimate or calculate percent load during the performance test must be clearly explained. If measurement devices such as flow meters, kilowatt meters, beta analyzers, stain gauges, etc. are used, the model number of the measurement device, and an estimate of its accurate in percentage of true value must be provided.

[69 FR 33506, June 15, 2004, as amended at 75 FR 9676, Mar. 3, 2010; 78 FR 6702, Jan. 30, 2013]

§ 63.6625 What are my monitoring, installation, collection, operation, and maintenance requirements?

(a) If you elect to install a CEMS as specified in Table 5 of this subpart, you must install, operate, and maintain a CEMS to monitor CO and either O₂ or CO₂ according to the requirements in paragraphs (a)(1) through (4) of this section. If you are meeting a requirement to reduce CO emissions, the CEMS must be installed at both the inlet and outlet of the control device. If you are meeting a requirement to limit the concentration of CO, the CEMS must be installed at the outlet of the control device.

(1) Each CEMS must be installed, operated, and maintained according to the applicable performance specifications of 40 CFR part 60, appendix B.

(2) You must conduct an initial performance evaluation and an annual relative accuracy test audit (RATA) of each CEMS according to the requirements in § 63.8 and according to the applicable

performance specifications of 40 CFR part 60, appendix B as well as daily and periodic data quality checks in accordance with 40 CFR part 60, appendix F, procedure 1.

(3) As specified in § 63.8(c)(4)(ii), each CEMS must complete a minimum of one cycle of operation (sampling, analyzing, and data recording) for each successive 15-minute period. You must have at least two data points, with each representing a different 15-minute period, to have a valid hour of data.

(4) The CEMS data must be reduced as specified in § 63.8(g)(2) and recorded in parts per million or parts per billion (as appropriate for the applicable limitation) at 15 percent oxygen or the equivalent CO₂ concentration.

(b) If you are required to install a continuous parameter monitoring system (CPMS) as specified in Table 5 of this subpart, you must install, operate, and maintain each CPMS according to the requirements in paragraphs (b)(1) through (6) of this section. For an affected source that is complying with the emission limitations and operating limitations on March 9, 2011, the requirements in paragraph (b) of this section are applicable September 6, 2011.

(1) You must prepare a site-specific monitoring plan that addresses the monitoring system design, data collection, and the quality assurance and quality control elements outlined in paragraphs (b)(1)(i) through (v) of this section and in § 63.8(d). As specified in § 63.8(f)(4), you may request approval of monitoring system quality assurance and quality control procedures alternative to those specified in paragraphs (b)(1) through (5) of this section in your site-specific monitoring plan.

(i) The performance criteria and design specifications for the monitoring system equipment, including the sample interface, detector signal analyzer, and data acquisition and calculations;

(ii) Sampling interface (e.g., thermocouple) location such that the monitoring system will provide representative measurements;

(iii) Equipment performance evaluations, system accuracy audits, or other audit procedures;

(iv) Ongoing operation and maintenance procedures in accordance with provisions in § 63.8(c)(1) (ii) and (c)(3); and

(v) Ongoing reporting and recordkeeping procedures in accordance with provisions in § 63.10(c), (e)(1), and (e)(2)(i).

(2) You must install, operate, and maintain each CPMS in continuous operation according to the procedures in your site-specific monitoring plan.

(3) The CPMS must collect data at least once every 15 minutes (see also § 63.6635).

(4) For a CPMS for measuring temperature range, the temperature sensor must have a minimum tolerance of 2.8 degrees Celsius (5 degrees Fahrenheit) or 1 percent of the measurement range, whichever is larger.

(5) You must conduct the CPMS equipment performance evaluation, system accuracy audits, or other audit procedures specified in your site-specific monitoring plan at least annually.

(6) You must conduct a performance evaluation of each CPMS in accordance with your site-specific monitoring plan.

(c) If you are operating a new or reconstructed stationary RICE which fires landfill gas or digester gas equivalent to 10 percent or more of the gross heat input on an annual basis, you must monitor and record your fuel usage daily with separate fuel meters to measure the volumetric flow rate of each fuel. In addition, you must operate your stationary RICE in a manner which reasonably minimizes HAP emissions.

(d) If you are operating a new or reconstructed emergency 4SLB stationary RICE with a site rating of greater than or equal to 250 and less than or equal to 500 brake HP located at a major source of HAP emissions, you must install a non-resettable hour meter prior to the startup of the engine.

(e) If you own or operate any of the following stationary RICE, you must operate and maintain the stationary RICE and after-treatment control device (if any) according to the manufacturer's emission-related written instructions or develop your own maintenance plan which must provide to the extent practicable for the maintenance and operation of the engine in a manner consistent with good air pollution control practice for minimizing emissions:

(1) An existing stationary RICE with a site rating of less than 100 HP located at a major source of HAP emissions;

(2) An existing emergency or black start stationary RICE with a site rating of less than or equal to 500 HP located at a major source of HAP emissions;

(3) An existing emergency or black start stationary RICE located at an area source of HAP emissions;

(4) An existing non-emergency, non-black start stationary CI RICE with a site rating less than or equal to 300 HP located at an area source of HAP emissions;

(5) An existing non-emergency, non-black start 2SLB stationary RICE located at an area source of HAP emissions;

(6) An existing non-emergency, non-black start stationary RICE located at an area source of HAP emissions which combusts landfill or digester gas equivalent to 10 percent or more of the gross heat input on an annual basis.

(7) An existing non-emergency, non-black start 4SLB stationary RICE with a site rating less than or equal to 500 HP located at an area source of HAP emissions;

(8) An existing non-emergency, non-black start 4SRB stationary RICE with a site rating less than or equal to 500 HP located at an area source of HAP emissions;

(9) An existing, non-emergency, non-black start 4SLB stationary RICE with a site rating greater than 500 HP located at an area source of HAP emissions that is operated 24 hours or less per calendar year; and

(10) An existing, non-emergency, non-black start 4SRB stationary RICE with a site rating greater than 500 HP located at an area source of HAP emissions that is operated 24 hours or less per calendar year.

(f) If you own or operate an existing emergency stationary RICE with a site rating of less than or equal to 500 brake HP located at a major source of HAP emissions or an existing emergency stationary RICE located at an area source of HAP emissions, you must install a non-resettable hour meter if one is not already installed.

(g) If you own or operate an existing non-emergency, non-black start CI engine greater than or equal to 300 HP that is not equipped with a closed crankcase ventilation system, you must comply with either paragraph (g)(1) or paragraph (2) of this section. Owners and operators must follow the manufacturer's specified maintenance requirements for operating and maintaining the open or closed crankcase ventilation systems and replacing the crankcase filters, or can request the Administrator to approve different maintenance requirements that are as protective as manufacturer requirements. Existing CI engines located at area sources in areas of Alaska that meet either § 63.6603(b)(1) or § 63.6603(b)(2) do not have to meet the requirements of this paragraph (g). Existing CI engines located on offshore vessels that meet § 63.6603(c) do not have to meet the requirements of this paragraph (g).

(1) Install a closed crankcase ventilation system that prevents crankcase emissions from being emitted to the atmosphere, or

(2) Install an open crankcase filtration emission control system that reduces emissions from the crankcase by filtering the exhaust stream to remove oil mist, particulates and metals.

(h) If you operate a new, reconstructed, or existing stationary engine, you must minimize the engine's time spent at idle during startup and minimize the engine's startup time to a period needed for appropriate and safe loading of the engine, not to exceed 30 minutes, after which time the emission standards applicable to all times other than startup in Tables 1a, 2a, 2c, and 2d to this subpart apply.

(i) If you own or operate a stationary CI engine that is subject to the work, operation or management practices in items 1 or 2 of Table 2c to this subpart or in items 1 or 4 of Table 2d to this subpart, you have the option of utilizing an oil analysis program in order to extend the specified oil change requirement in Tables 2c and 2d to this subpart. The oil analysis must be performed at the same frequency specified for changing the oil in Table 2c or 2d to this subpart. The analysis program must at a minimum analyze the following three parameters: Total Base Number, viscosity, and percent water content. The condemning limits for these parameters are as follows: Total Base Number is less than 30 percent of the Total Base Number of the oil when new; viscosity of the oil has changed by more than 20 percent from the viscosity of the oil when new; or percent water content (by volume) is greater than 0.5. If all of these condemning limits are not exceeded, the engine owner or operator is not required to change the oil. If any of the limits are exceeded, the engine owner or operator must change the oil within 2 business days of receiving the results of the analysis; if the engine is not in operation when the results of the analysis are received, the engine owner or operator must change the oil within 2 business days or before commencing operation, whichever is later. The owner or operator must keep records of the parameters that are analyzed as part of the program, the results of the analysis, and the oil changes for the engine. The analysis program must be part of the maintenance plan for the engine.

(j) If you own or operate a stationary SI engine that is subject to the work, operation or management practices in items 6, 7, or 8 of Table 2c to this subpart or in items 5, 6, 7, 9, or 11 of Table 2d to this subpart, you have the option of utilizing an oil analysis program in order to extend the specified oil change requirement in Tables 2c and 2d to this subpart. The oil analysis must be performed at the same frequency specified for changing the oil in Table 2c or 2d to this subpart. The analysis program must at a minimum analyze the following three parameters: Total Acid Number, viscosity, and percent water content. The condemning limits for these parameters are as follows: Total Acid Number increases by more than 3.0 milligrams of potassium hydroxide (KOH) per gram from Total Acid Number of the oil when new; viscosity of the oil has changed by more than 20 percent from the viscosity of the oil when new; or percent water content (by volume) is greater than 0.5. If all of these condemning limits are not exceeded, the engine owner or operator is not required to change the oil. If any of the limits are exceeded, the engine owner or operator must change the oil within 2 business days of receiving the results of the analysis; if the engine is not in operation when the results of the analysis are received, the engine owner or operator must change the oil within 2 business days or before commencing operation, whichever is later. The owner or operator must keep records of the parameters that are analyzed as part of the program, the results of the analysis, and the oil changes for the engine. The analysis program must be part of the maintenance plan for the engine.

[69 FR 33506, June 15, 2004, as amended at 73 FR 3606, Jan. 18, 2008; 75 FR 9676, Mar. 3, 2010; 75 FR 51589, Aug. 20, 2010; 76 FR 12866, Mar. 9, 2011; 78 FR 6703, Jan. 30, 2013]

§ 63.6630 How do I demonstrate initial compliance with the emission limitations, operating limitations, and other requirements?

(a) You must demonstrate initial compliance with each emission limitation, operating limitation, and other requirement that applies to you according to Table 5 of this subpart.

(b) During the initial performance test, you must establish each operating limitation in Tables 1b and 2b of this subpart that applies to you.

(c) You must submit the Notification of Compliance Status containing the results of the initial compliance demonstration according to the requirements in § 63.6645.

(d) Non-emergency 4SRB stationary RICE complying with the requirement to reduce formaldehyde emissions by 76 percent or more can demonstrate initial compliance with the formaldehyde emission limit by testing for THC instead of formaldehyde. The testing must be conducted according to the requirements in Table 4 of this subpart. The average reduction of emissions of THC determined from the performance test must be equal to or greater than 30 percent.

(e) The initial compliance demonstration required for existing non-emergency 4SLB and 4SRB stationary RICE with a site rating of more than 500 HP located at an area source of HAP that are not remote stationary RICE and that are operated more than 24 hours per calendar year must be conducted according to the following requirements:

(1) The compliance demonstration must consist of at least three test runs.

(2) Each test run must be of at least 15 minute duration, except that each test conducted using the method in appendix A to this subpart must consist of at least one measurement cycle and include at least 2 minutes of test data phase measurement.

(3) If you are demonstrating compliance with the CO concentration or CO percent reduction requirement, you must measure CO emissions using one of the CO measurement methods specified in Table 4 of this subpart, or using appendix A to this subpart.

(4) If you are demonstrating compliance with the THC percent reduction requirement, you must measure THC emissions using Method 25A, reported as propane, of 40 CFR part 60, appendix A.

(5) You must measure O₂ using one of the O₂ measurement methods specified in Table 4 of this subpart. Measurements to determine O₂ concentration must be made at the same time as the measurements for CO or THC concentration.

(6) If you are demonstrating compliance with the CO or THC percent reduction requirement, you must measure CO or THC emissions and O₂ emissions simultaneously at the inlet and outlet of the control device.

[69 FR 33506, June 15, 2004, as amended at 78 FR 6704, Jan. 30, 2013]

Continuous Compliance Requirements

§ 63.6635 How do I monitor and collect data to demonstrate continuous compliance?

(a) If you must comply with emission and operating limitations, you must monitor and collect data according to this section.

(b) Except for monitor malfunctions, associated repairs, required performance evaluations, and required quality assurance or control activities, you must monitor continuously at all times that the stationary RICE is operating. A monitoring malfunction is any sudden, infrequent, not reasonably preventable failure of the monitoring to provide valid data. Monitoring failures that are caused in part by poor maintenance or careless operation are not malfunctions.

(c) You may not use data recorded during monitoring malfunctions, associated repairs, and required quality assurance or control activities in data averages and calculations used to report emission or operating levels. You must, however, use all the valid data collected during all other periods.

[69 FR 33506, June 15, 2004, as amended at 76 FR 12867, Mar. 9, 2011]

§ 63.6640 How do I demonstrate continuous compliance with the emission limitations, operating limitations, and other requirements?

(a) You must demonstrate continuous compliance with each emission limitation, operating limitation, and other requirements in Tables 1a and 1b, Tables 2a and 2b, Table 2c, and Table 2d to this subpart that apply to you according to methods specified in Table 6 to this subpart.

(b) You must report each instance in which you did not meet each emission limitation or operating limitation in Tables 1a and 1b, Tables 2a and 2b, Table 2c, and Table 2d to this subpart that apply to you. These instances are deviations from the emission and operating limitations in this subpart. These deviations must be reported according to the requirements in § 63.6650. If you change your catalyst, you must reestablish the values of the operating parameters measured during the initial performance test. When you reestablish the values of your operating parameters, you must also conduct a performance test to demonstrate that you are meeting the required emission limitation applicable to your stationary RICE.

(c) The annual compliance demonstration required for existing non-emergency 4SLB and 4SRB stationary RICE with a site rating of more than 500 HP located at an area source of HAP that are not remote stationary RICE and that are operated more than 24 hours per calendar year must be conducted according to the following requirements:

(1) The compliance demonstration must consist of at least one test run.

(2) Each test run must be of at least 15 minute duration, except that each test conducted using the method in appendix A to this subpart must consist of at least one measurement cycle and include at least 2 minutes of test data phase measurement.

(3) If you are demonstrating compliance with the CO concentration or CO percent reduction requirement, you must measure CO emissions using one of the CO measurement methods specified in Table 4 of this subpart, or using appendix A to this subpart.

(4) If you are demonstrating compliance with the THC percent reduction requirement, you must measure THC emissions using Method 25A, reported as propane, of 40 CFR part 60, appendix A.

(5) You must measure O₂ using one of the O₂ measurement methods specified in Table 4 of this subpart. Measurements to determine O₂ concentration must be made at the same time as the measurements for CO or THC concentration.

(6) If you are demonstrating compliance with the CO or THC percent reduction requirement, you must measure CO or THC emissions and O₂ emissions simultaneously at the inlet and outlet of the control device.

(7) If the results of the annual compliance demonstration show that the emissions exceed the levels specified in Table 6 of this subpart, the stationary RICE must be shut down as soon as safely possible, and appropriate corrective action must be taken (e.g., repairs, catalyst cleaning, catalyst replacement). The stationary RICE must be retested within 7 days of being restarted and the emissions must meet the levels specified in Table 6 of this subpart. If the retest shows that the emissions continue to exceed the specified levels, the stationary RICE must again be shut down as soon as safely possible, and the stationary RICE may not operate, except for purposes of startup and testing, until the owner/operator demonstrates through testing that the emissions do not exceed the levels specified in Table 6 of this subpart.

(d) For new, reconstructed, and rebuilt stationary RICE, deviations from the emission or operating limitations that occur during the first 200 hours of operation from engine startup (engine burn-in period) are not violations. Rebuilt stationary RICE means a stationary RICE that has been rebuilt as that term is defined in 40 CFR 94.11(a).

(e) You must also report each instance in which you did not meet the requirements in Table 8 to this subpart that apply to you. If you own or operate a new or reconstructed stationary RICE with a site rating of less than or equal to 500 brake HP located at a major source of HAP emissions (except new or reconstructed 4SLB engines greater than or equal to 250 and less than or equal to 500 brake HP), a new or reconstructed stationary RICE located at an area source of HAP emissions, or any of the

following RICE with a site rating of more than 500 brake HP located at a major source of HAP emissions, you do not need to comply with the requirements in Table 8 to this subpart: An existing 2SLB stationary RICE, an existing 4SLB stationary RICE, an existing emergency stationary RICE, an existing limited use stationary RICE, or an existing stationary RICE which fires landfill gas or digester gas equivalent to 10 percent or more of the gross heat input on an annual basis. If you own or operate any of the following RICE with a site rating of more than 500 brake HP located at a major source of HAP emissions, you do not need to comply with the requirements in Table 8 to this subpart, except for the initial notification requirements: a new or reconstructed stationary RICE that combusts landfill gas or digester gas equivalent to 10 percent or more of the gross heat input on an annual basis, a new or reconstructed emergency stationary RICE, or a new or reconstructed limited use stationary RICE.

(f) If you own or operate an emergency stationary RICE, you must operate the emergency stationary RICE according to the requirements in paragraphs (f)(1) through (4) of this section. In order for the engine to be considered an emergency stationary RICE under this subpart, any operation other than emergency operation, maintenance and testing, emergency demand response, and operation in non-emergency situations for 50 hours per year, as described in paragraphs (f)(1) through (4) of this section, is prohibited. If you do not operate the engine according to the requirements in paragraphs (f)(1) through (4) of this section, the engine will not be considered an emergency engine under this subpart and must meet all requirements for non-emergency engines.

(1) There is no time limit on the use of emergency stationary RICE in emergency situations.

(2) You may operate your emergency stationary RICE for any combination of the purposes specified in paragraphs (f)(2)(i) through (iii) of this section for a maximum of 100 hours per calendar year. Any operation for non-emergency situations as allowed by paragraphs (f)(3) and (4) of this section counts as part of the 100 hours per calendar year allowed by this paragraph (f)(2).

(i) Emergency stationary RICE may be operated for maintenance checks and readiness testing, provided that the tests are recommended by federal, state or local government, the manufacturer, the vendor, the regional transmission organization or equivalent balancing authority and transmission operator, or the insurance company associated with the engine. The owner or operator may petition the Administrator for approval of additional hours to be used for maintenance checks and readiness testing, but a petition is not required if the owner or operator maintains records indicating that federal, state, or local standards require maintenance and testing of emergency RICE beyond 100 hours per calendar year.

(ii) Emergency stationary RICE may be operated for emergency demand response for periods in which the Reliability Coordinator under the North American Electric Reliability Corporation (NERC) Reliability Standard EOP-002-3, Capacity and Energy Emergencies (incorporated by reference, see § 63.14), or other authorized entity as determined by the Reliability Coordinator, has declared an Energy Emergency Alert Level 2 as defined in the NERC Reliability Standard EOP-002-3.

(iii) Emergency stationary RICE may be operated for periods where there is a deviation of voltage or frequency of 5 percent or greater below standard voltage or frequency.

(3) Emergency stationary RICE located at major sources of HAP may be operated for up to 50 hours per calendar year in non-emergency situations. The 50 hours of operation in non-emergency situations are counted as part of the 100 hours per calendar year for maintenance and testing and emergency demand response provided in paragraph (f)(2) of this section. The 50 hours per year for non-emergency situations cannot be used for peak shaving or non-emergency demand response, or to generate income for a facility to supply power to an electric grid or otherwise supply power as part of a financial arrangement with another entity.

(4) Emergency stationary RICE located at area sources of HAP may be operated for up to 50 hours per calendar year in non-emergency situations. The 50 hours of operation in non-emergency situations are counted as part of the 100 hours per calendar year for maintenance and testing and emergency demand response provided in paragraph (f)(2) of this section. Except as provided in paragraphs (f)(4)(i) and (ii) of this section, the 50 hours per year for non-emergency situations cannot

be used for peak shaving or non-emergency demand response, or to generate income for a facility to an electric grid or otherwise supply power as part of a financial arrangement with another entity.

(i) Prior to May 3, 2014, the 50 hours per year for non-emergency situations can be used for peak shaving or non-emergency demand response to generate income for a facility, or to otherwise supply power as part of a financial arrangement with another entity if the engine is operated as part of a peak shaving (load management program) with the local distribution system operator and the power is provided only to the facility itself or to support the local distribution system.

(ii) The 50 hours per year for non-emergency situations can be used to supply power as part of a financial arrangement with another entity if all of the following conditions are met:

(A) The engine is dispatched by the local balancing authority or local transmission and distribution system operator.

(B) The dispatch is intended to mitigate local transmission and/or distribution limitations so as to avert potential voltage collapse or line overloads that could lead to the interruption of power supply in a local area or region.

(C) The dispatch follows reliability, emergency operation or similar protocols that follow specific NERC, regional, state, public utility commission or local standards or guidelines.

(D) The power is provided only to the facility itself or to support the local transmission and distribution system.

(E) The owner or operator identifies and records the entity that dispatches the engine and the specific NERC, regional, state, public utility commission or local standards or guidelines that are being followed for dispatching the engine. The local balancing authority or local transmission and distribution system operator may keep these records on behalf of the engine owner or operator.

[69 FR 33506, June 15, 2004, as amended at 71 FR 20467, Apr. 20, 2006; 73 FR 3606, Jan. 18, 2008; 75 FR 9676, Mar. 3, 2010; 75 FR 51591, Aug. 20, 2010; 78 FR 6704, Jan. 30, 2013]

Notifications, Reports, and Records

§ 63.6645 What notifications must I submit and when?

(a) You must submit all of the notifications in §§ 63.7(b) and (c), 63.8(e), (f)(4) and (f)(6), 63.9(b) through (e), and (g) and (h) that apply to you by the dates specified if you own or operate any of the following;

(1) An existing stationary RICE with a site rating of less than or equal to 500 brake HP located at a major source of HAP emissions.

(2) An existing stationary RICE located at an area source of HAP emissions.

(3) A stationary RICE with a site rating of more than 500 brake HP located at a major source of HAP emissions.

(4) A new or reconstructed 4SLB stationary RICE with a site rating of greater than or equal to 250 HP located at a major source of HAP emissions.

(5) This requirement does not apply if you own or operate an existing stationary RICE less than 100 HP, an existing stationary emergency RICE, or an existing stationary RICE that is not subject to any numerical emission standards.

(b) As specified in § 63.9(b)(2), if you start up your stationary RICE with a site rating of more than 500 brake HP located at a major source of HAP emissions before the effective date of this subpart, you must submit an Initial Notification not later than December 13, 2004.

(c) If you start up your new or reconstructed stationary RICE with a site rating of more than 500 brake HP located at a major source of HAP emissions on or after August 16, 2004, you must submit an Initial Notification not later than 120 days after you become subject to this subpart.

(d) As specified in § 63.9(b)(2), if you start up your stationary RICE with a site rating of equal to or less than 500 brake HP located at a major source of HAP emissions before the effective date of this subpart and you are required to submit an initial notification, you must submit an Initial Notification not later than July 16, 2008.

(e) If you start up your new or reconstructed stationary RICE with a site rating of equal to or less than 500 brake HP located at a major source of HAP emissions on or after March 18, 2008 and you are required to submit an initial notification, you must submit an Initial Notification not later than 120 days after you become subject to this subpart.

(f) If you are required to submit an Initial Notification but are otherwise not affected by the requirements of this subpart, in accordance with § 63.6590(b), your notification should include the information in § 63.9(b)(2)(i) through (v), and a statement that your stationary RICE has no additional requirements and explain the basis of the exclusion (for example, that it operates exclusively as an emergency stationary RICE if it has a site rating of more than 500 brake HP located at a major source of HAP emissions).

(g) If you are required to conduct a performance test, you must submit a Notification of Intent to conduct a performance test at least 60 days before the performance test is scheduled to begin as required in § 63.7(b)(1).

(h) If you are required to conduct a performance test or other initial compliance demonstration as specified in Tables 4 and 5 to this subpart, you must submit a Notification of Compliance Status according to § 63.9(h)(2)(ii).

(1) For each initial compliance demonstration required in Table 5 to this subpart that does not include a performance test, you must submit the Notification of Compliance Status before the close of business on the 30th day following the completion of the initial compliance demonstration.

(2) For each initial compliance demonstration required in Table 5 to this subpart that includes a performance test conducted according to the requirements in Table 3 to this subpart, you must submit the Notification of Compliance Status, including the performance test results, before the close of business on the 60th day following the completion of the performance test according to § 63.10(d)(2).

(i) If you own or operate an existing non-emergency CI RICE with a site rating of more than 300 HP located at an area source of HAP emissions that is certified to the Tier 1 or Tier 2 emission standards in Table 1 of 40 CFR 89.112 and subject to an enforceable state or local standard requiring engine replacement and you intend to meet management practices rather than emission limits, as specified in § 63.6603(d), you must submit a notification by March 3, 2013, stating that you intend to use the provision in § 63.6603(d) and identifying the state or local regulation that the engine is subject to.

[73 FR 3606, Jan. 18, 2008, as amended at 75 FR 9677, Mar. 3, 2010; 75 FR 51591, Aug. 20, 2010; 78 FR 6705, Jan. 30, 2013]

§ 63.6650 What reports must I submit and when?

(a) You must submit each report in Table 7 of this subpart that applies to you.

(b) Unless the Administrator has approved a different schedule for submission of reports under § 63.10(a), you must submit each report by the date in Table 7 of this subpart and according to the requirements in paragraphs (b)(1) through (b)(9) of this section.

(1) For semiannual Compliance reports, the first Compliance report must cover the period beginning on the compliance date that is specified for your affected source in § 63.6595 and ending on

June 30 or December 31, whichever date is the first date following the end of the first calendar half after the compliance date that is specified for your source in § 63.6595.

(2) For semiannual Compliance reports, the first Compliance report must be postmarked or delivered no later than July 31 or January 31, whichever date follows the end of the first calendar half after the compliance date that is specified for your affected source in § 63.6595.

(3) For semiannual Compliance reports, each subsequent Compliance report must cover the semiannual reporting period from January 1 through June 30 or the semiannual reporting period from July 1 through December 31.

(4) For semiannual Compliance reports, each subsequent Compliance report must be postmarked or delivered no later than July 31 or January 31, whichever date is the first date following the end of the semiannual reporting period.

(5) For each stationary RICE that is subject to permitting regulations pursuant to 40 CFR part 70 or 71, and if the permitting authority has established dates for submitting semiannual reports pursuant to 40 CFR 70.6(a)(3)(iii)(A) or 40 CFR 71.6 (a)(3)(iii)(A), you may submit the first and subsequent Compliance reports according to the dates the permitting authority has established instead of according to the dates in paragraphs (b)(1) through (b)(4) of this section.

(6) For annual Compliance reports, the first Compliance report must cover the period beginning on the compliance date that is specified for your affected source in § 63.6595 and ending on December 31.

(7) For annual Compliance reports, the first Compliance report must be postmarked or delivered no later than January 31 following the end of the first calendar year after the compliance date that is specified for your affected source in § 63.6595.

(8) For annual Compliance reports, each subsequent Compliance report must cover the annual reporting period from January 1 through December 31.

(9) For annual Compliance reports, each subsequent Compliance report must be postmarked or delivered no later than January 31.

(c) The Compliance report must contain the information in paragraphs (c)(1) through (6) of this section.

(1) Company name and address.

(2) Statement by a responsible official, with that official's name, title, and signature, certifying the accuracy of the content of the report.

(3) Date of report and beginning and ending dates of the reporting period.

(4) If you had a malfunction during the reporting period, the compliance report must include the number, duration, and a brief description for each type of malfunction which occurred during the reporting period and which caused or may have caused any applicable emission limitation to be exceeded. The report must also include a description of actions taken by an owner or operator during a malfunction of an affected source to minimize emissions in accordance with § 63.6605(b), including actions taken to correct a malfunction.

(5) If there are no deviations from any emission or operating limitations that apply to you, a statement that there were no deviations from the emission or operating limitations during the reporting period.

(6) If there were no periods during which the continuous monitoring system (CMS), including CEMS and CPMS, was out-of-control, as specified in § 63.8(c)(7), a statement that there were no periods during which the CMS was out-of-control during the reporting period.

(d) For each deviation from an emission or operating limitation that occurs for a stationary RICE where you are not using a CMS to comply with the emission or operating limitations in this subpart, the Compliance report must contain the information in paragraphs (c)(1) through (4) of this section and the information in paragraphs (d)(1) and (2) of this section.

(1) The total operating time of the stationary RICE at which the deviation occurred during the reporting period.

(2) Information on the number, duration, and cause of deviations (including unknown cause, if applicable), as applicable, and the corrective action taken.

(e) For each deviation from an emission or operating limitation occurring for a stationary RICE where you are using a CMS to comply with the emission and operating limitations in this subpart, you must include information in paragraphs (c)(1) through (4) and (e)(1) through (12) of this section.

(1) The date and time that each malfunction started and stopped.

(2) The date, time, and duration that each CMS was inoperative, except for zero (low-level) and high-level checks.

(3) The date, time, and duration that each CMS was out-of-control, including the information in § 63.8(c)(8).

(4) The date and time that each deviation started and stopped, and whether each deviation occurred during a period of malfunction or during another period.

(5) A summary of the total duration of the deviation during the reporting period, and the total duration as a percent of the total source operating time during that reporting period.

(6) A breakdown of the total duration of the deviations during the reporting period into those that are due to control equipment problems, process problems, other known causes, and other unknown causes.

(7) A summary of the total duration of CMS downtime during the reporting period, and the total duration of CMS downtime as a percent of the total operating time of the stationary RICE at which the CMS downtime occurred during that reporting period.

(8) An identification of each parameter and pollutant (CO or formaldehyde) that was monitored at the stationary RICE.

(9) A brief description of the stationary RICE.

(10) A brief description of the CMS.

(11) The date of the latest CMS certification or audit.

(12) A description of any changes in CMS, processes, or controls since the last reporting period.

(f) Each affected source that has obtained a title V operating permit pursuant to 40 CFR part 70 or 71 must report all deviations as defined in this subpart in the semiannual monitoring report required by 40 CFR 70.6 (a)(3)(iii)(A) or 40 CFR 71.6(a)(3)(iii)(A). If an affected source submits a Compliance report pursuant to Table 7 of this subpart along with, or as part of, the semiannual monitoring report required by 40 CFR 70.6(a)(3)(iii)(A) or 40 CFR 71.6(a)(3)(iii)(A), and the Compliance report includes all required information concerning deviations from any emission or operating limitation in this subpart, submission of the Compliance report shall be deemed to satisfy any obligation to report the same deviations in the semiannual monitoring report. However, submission of a Compliance report shall not otherwise affect any obligation the affected source may have to report deviations from permit requirements to the permit authority.

(g) If you are operating as a new or reconstructed stationary RICE which fires landfill gas or digester gas equivalent to 10 percent or more of the gross heat input on an annual basis, you must submit an annual report according to Table 7 of this subpart by the date specified unless the Administrator has approved a different schedule, according to the information described in paragraphs (b)(1) through (b)(5) of this section. You must report the data specified in (g)(1) through (g)(3) of this section.

(1) Fuel flow rate of each fuel and the heating values that were used in your calculations. You must also demonstrate that the percentage of heat input provided by landfill gas or digester gas is equivalent to 10 percent or more of the total fuel consumption on an annual basis.

(2) The operating limits provided in your federally enforceable permit, and any deviations from these limits.

(3) Any problems or errors suspected with the meters.

(h) If you own or operate an emergency stationary RICE with a site rating of more than 100 brake HP that operates or is contractually obligated to be available for more than 15 hours per calendar year for the purposes specified in § 63.6640(f)(2)(ii) and (iii) or that operates for the purpose specified in § 63.6640(f)(4)(ii), you must submit an annual report according to the requirements in paragraphs (h) (1) through (3) of this section.

(1) The report must contain the following information:

(i) Company name and address where the engine is located.

(ii) Date of the report and beginning and ending dates of the reporting period.

(iii) Engine site rating and model year.

(iv) Latitude and longitude of the engine in decimal degrees reported to the fifth decimal place.

(v) Hours operated for the purposes specified in § 63.6640(f)(2)(ii) and (iii), including the date, start time, and end time for engine operation for the purposes specified in § 63.6640(f)(2)(ii) and (iii).

(vi) Number of hours the engine is contractually obligated to be available for the purposes specified in § 63.6640(f)(2)(ii) and (iii).

(vii) Hours spent for operation for the purpose specified in § 63.6640(f)(4)(ii), including the date, start time, and end time for engine operation for the purposes specified in § 63.6640(f)(4)(ii). The report must also identify the entity that dispatched the engine and the situation that necessitated the dispatch of the engine.

(viii) If there were no deviations from the fuel requirements in § 63.6604 that apply to the engine (if any), a statement that there were no deviations from the fuel requirements during the reporting period.

(ix) If there were deviations from the fuel requirements in § 63.6604 that apply to the engine (if any), information on the number, duration, and cause of deviations, and the corrective action taken.

(2) The first annual report must cover the calendar year 2015 and must be submitted no later than March 31, 2016. Subsequent annual reports for each calendar year must be submitted no later than March 31 of the following calendar year.

(3) The annual report must be submitted electronically using the subpart specific reporting form in the Compliance and Emissions Data Reporting Interface (CEDRI) that is accessed through EPA's Central Data Exchange (CDX) (www.epa.gov/cdx). However, if the reporting form specific to this subpart is not available in CEDRI at the time that the report is due, the written report must be submitted to the Administrator at the appropriate address listed in § 63.13.

[69 FR 33506, June 15, 2004, as amended at 75 FR 9677, Mar. 3, 2010; 78 FR 6705, Jan. 30, 2013]

§ 63.6655 What records must I keep?

(a) If you must comply with the emission and operating limitations, you must keep the records described in paragraphs (a)(1) through (a)(5), (b)(1) through (b)(3) and (c) of this section.

(1) A copy of each notification and report that you submitted to comply with this subpart, including all documentation supporting any Initial Notification or Notification of Compliance Status that you submitted, according to the requirement in § 63.10(b)(2)(xiv).

(2) Records of the occurrence and duration of each malfunction of operation (*i.e.*, process equipment) or the air pollution control and monitoring equipment.

(3) Records of performance tests and performance evaluations as required in § 63.10(b)(2)(viii).

(4) Records of all required maintenance performed on the air pollution control and monitoring equipment.

(5) Records of actions taken during periods of malfunction to minimize emissions in accordance with § 63.6605(b), including corrective actions to restore malfunctioning process and air pollution control and monitoring equipment to its normal or usual manner of operation.

(b) For each CEMS or CPMS, you must keep the records listed in paragraphs (b)(1) through (3) of this section.

(1) Records described in § 63.10(b)(2)(vi) through (xi).

(2) Previous (*i.e.*, superseded) versions of the performance evaluation plan as required in § 63.8(d)(3).

(3) Requests for alternatives to the relative accuracy test for CEMS or CPMS as required in § 63.8(f)(6)(i), if applicable.

(c) If you are operating a new or reconstructed stationary RICE which fires landfill gas or digester gas equivalent to 10 percent or more of the gross heat input on an annual basis, you must keep the records of your daily fuel usage monitors.

(d) You must keep the records required in Table 6 of this subpart to show continuous compliance with each emission or operating limitation that applies to you.

(e) You must keep records of the maintenance conducted on the stationary RICE in order to demonstrate that you operated and maintained the stationary RICE and after-treatment control device (if any) according to your own maintenance plan if you own or operate any of the following stationary RICE;

(1) An existing stationary RICE with a site rating of less than 100 brake HP located at a major source of HAP emissions.

(2) An existing stationary emergency RICE.

(3) An existing stationary RICE located at an area source of HAP emissions subject to management practices as shown in Table 2d to this subpart.

(f) If you own or operate any of the stationary RICE in paragraphs (f)(1) through (2) of this section, you must keep records of the hours of operation of the engine that is recorded through the non-resettable hour meter. The owner or operator must document how many hours are spent for emergency operation, including what classified the operation as emergency and how many hours are spent for non-emergency operation. If the engine is used for the purposes specified in § 63.6640(f)(2)(ii) or (iii) or § 63.6640(f)(4)(ii), the owner or operator must keep records of the notification of the emergency situation, and the date, start time, and end time of engine operation for these purposes.

(1) An existing emergency stationary RICE with a site rating of less than or equal to 500 brake HP located at a major source of HAP emissions that does not meet the standards applicable to non-emergency engines.

(2) An existing emergency stationary RICE located at an area source of HAP emissions that does not meet the standards applicable to non-emergency engines.

[69 FR 33506, June 15, 2004, as amended at 75 FR 9678, Mar. 3, 2010; 75 FR 51592, Aug. 20, 2010; 78 FR 6706, Jan. 30, 2013]

§ 63.6660 In what form and how long must I keep my records?

(a) Your records must be in a form suitable and readily available for expeditious review according to § 63.10(b)(1).

(b) As specified in § 63.10(b)(1), you must keep each record for 5 years following the date of each occurrence, measurement, maintenance, corrective action, report, or record.

(c) You must keep each record readily accessible in hard copy or electronic form for at least 5 years after the date of each occurrence, measurement, maintenance, corrective action, report, or record, according to § 63.10(b)(1).

[69 FR 33506, June 15, 2004, as amended at 75 FR 9678, Mar. 3, 2010]

Other Requirements and Information

§ 63.6665 What parts of the General Provisions apply to me?

Table 8 to this subpart shows which parts of the General Provisions in §§ 63.1 through 63.15 apply to you. If you own or operate a new or reconstructed stationary RICE with a site rating of less than or equal to 500 brake HP located at a major source of HAP emissions (except new or reconstructed 4SLB engines greater than or equal to 250 and less than or equal to 500 brake HP), a new or reconstructed stationary RICE located at an area source of HAP emissions, or any of the following RICE with a site rating of more than 500 brake HP located at a major source of HAP emissions, you do not need to comply with any of the requirements of the General Provisions specified in Table 8: An existing 2SLB stationary RICE, an existing 4SLB stationary RICE, an existing stationary RICE that combusts landfill or digester gas equivalent to 10 percent or more of the gross heat input on an annual basis, an existing emergency stationary RICE, or an existing limited use stationary RICE. If you own or operate any of the following RICE with a site rating of more than 500 brake HP located at a major source of HAP emissions, you do not need to comply with the requirements in the General Provisions specified in Table 8 except for the initial notification requirements: A new stationary RICE that combusts landfill gas or digester gas equivalent to 10 percent or more of the gross heat input on an annual basis, a new emergency stationary RICE, or a new limited use stationary RICE.

[75 FR 9678, Mar. 3, 2010]

§ 63.6670 Who implements and enforces this subpart?

(a) This subpart is implemented and enforced by the U.S. EPA, or a delegated authority such as your State, local, or tribal agency. If the U.S. EPA Administrator has delegated authority to your State, local, or tribal agency, then that agency (as well as the U.S. EPA) has the authority to implement and enforce this subpart. You should contact your U.S. EPA Regional Office to find out whether this subpart is delegated to your State, local, or tribal agency.

(b) In delegating implementation and enforcement authority of this subpart to a State, local, or tribal agency under 40 CFR part 63, subpart E, the authorities contained in paragraph (c) of this section are retained by the Administrator of the U.S. EPA and are not transferred to the State, local, or tribal agency.

(c) The authorities that will not be delegated to State, local, or tribal agencies are:

(1) Approval of alternatives to the non-opacity emission limitations and operating limitations in § 63.6600 under § 63.6(g).

(2) Approval of major alternatives to test methods under § 63.7(e)(2)(ii) and (f) and as defined in § 63.90.

(3) Approval of major alternatives to monitoring under § 63.8(f) and as defined in § 63.90.

(4) Approval of major alternatives to recordkeeping and reporting under § 63.10(f) and as defined in § 63.90.

(5) Approval of a performance test which was conducted prior to the effective date of the rule, as specified in § 63.6610(b).

§ 63.6675 What definitions apply to this subpart?

Terms used in this subpart are defined in the Clean Air Act (CAA); in 40 CFR 63.2, the General Provisions of this part; and in this section as follows:

Alaska Railbelt Grid means the service areas of the six regulated public utilities that extend from Fairbanks to Anchorage and the Kenai Peninsula. These utilities are Golden Valley Electric Association; Chugach Electric Association; Matanuska Electric Association; Homer Electric Association; Anchorage Municipal Light & Power; and the City of Seward Electric System.

Area source means any stationary source of HAP that is not a major source as defined in part 63.

Associated equipment as used in this subpart and as referred to in section 112(n)(4) of the CAA, means equipment associated with an oil or natural gas exploration or production well, and includes all equipment from the well bore to the point of custody transfer, except glycol dehydration units, storage vessels with potential for flash emissions, combustion turbines, and stationary RICE.

Backup power for renewable energy means an engine that provides backup power to a facility that generates electricity from renewable energy resources, as that term is defined in Alaska Statute 42.45.045(l)(5) (incorporated by reference, see § 63.14).

Black start engine means an engine whose only purpose is to start up a combustion turbine.

CAA means the Clean Air Act (42 U.S.C. 7401 *et seq.*, as amended by Public Law 101-549, 104 Stat. 2399).

Commercial emergency stationary RICE means an emergency stationary RICE used in commercial establishments such as office buildings, hotels, stores, telecommunications facilities, restaurants, financial institutions such as banks, doctor's offices, and sports and performing arts facilities.

Compression ignition means relating to a type of stationary internal combustion engine that is not a spark ignition engine.

Custody transfer means the transfer of hydrocarbon liquids or natural gas: After processing and/or treatment in the producing operations, or from storage vessels or automatic transfer facilities or other such equipment, including product loading racks, to pipelines or any other forms of transportation. For the purposes of this subpart, the point at which such liquids or natural gas enters a natural gas processing plant is a point of custody transfer.

Deviation means any instance in which an affected source subject to this subpart, or an owner or operator of such a source:

(1) Fails to meet any requirement or obligation established by this subpart, including but not limited to any emission limitation or operating limitation;

(2) Fails to meet any term or condition that is adopted to implement an applicable requirement in this subpart and that is included in the operating permit for any affected source required to obtain such a permit; or

(3) Fails to meet any emission limitation or operating limitation in this subpart during malfunction, regardless or whether or not such failure is permitted by this subpart.

(4) Fails to satisfy the general duty to minimize emissions established by § 63.6(e)(1)(i).

Diesel engine means any stationary RICE in which a high boiling point liquid fuel injected into the combustion chamber ignites when the air charge has been compressed to a temperature sufficiently high for auto-ignition. This process is also known as compression ignition.

Diesel fuel means any liquid obtained from the distillation of petroleum with a boiling point of approximately 150 to 360 degrees Celsius. One commonly used form is fuel oil number 2. Diesel fuel also includes any non-distillate fuel with comparable physical and chemical properties (e.g. biodiesel) that is suitable for use in compression ignition engines.

Digester gas means any gaseous by-product of wastewater treatment typically formed through the anaerobic decomposition of organic waste materials and composed principally of methane and CO₂ .

Dual-fuel engine means any stationary RICE in which a liquid fuel (typically diesel fuel) is used for compression ignition and gaseous fuel (typically natural gas) is used as the primary fuel.

Emergency stationary RICE means any stationary reciprocating internal combustion engine that meets all of the criteria in paragraphs (1) through (3) of this definition. All emergency stationary RICE must comply with the requirements specified in § 63.6640(f) in order to be considered emergency stationary RICE. If the engine does not comply with the requirements specified in § 63.6640(f), then it is not considered to be an emergency stationary RICE under this subpart.

(1) The stationary RICE is operated to provide electrical power or mechanical work during an emergency situation. Examples include stationary RICE used to produce power for critical networks or equipment (including power supplied to portions of a facility) when electric power from the local utility (or the normal power source, if the facility runs on its own power production) is interrupted, or stationary RICE used to pump water in the case of fire or flood, etc.

(2) The stationary RICE is operated under limited circumstances for situations not included in paragraph (1) of this definition, as specified in § 63.6640(f).

(3) The stationary RICE operates as part of a financial arrangement with another entity in situations not included in paragraph (1) of this definition only as allowed in § 63.6640(f)(2)(ii) or (iii) and § 63.6640(f)(4)(i) or (ii).

Engine startup means the time from initial start until applied load and engine and associated equipment reaches steady state or normal operation. For stationary engine with catalytic controls, engine startup means the time from initial start until applied load and engine and associated equipment, including the catalyst, reaches steady state or normal operation.

Four-stroke engine means any type of engine which completes the power cycle in two crankshaft revolutions, with intake and compression strokes in the first revolution and power and exhaust strokes in the second revolution.

Gaseous fuel means a material used for combustion which is in the gaseous state at standard atmospheric temperature and pressure conditions.

Gasoline means any fuel sold in any State for use in motor vehicles and motor vehicle engines, or nonroad or stationary engines, and commonly or commercially known or sold as gasoline.

Glycol dehydration unit means a device in which a liquid glycol (including, but not limited to, ethylene glycol, diethylene glycol, or triethylene glycol) absorbent directly contacts a natural gas

stream and absorbs water in a contact tower or absorption column (absorber). The glycol contacts and absorbs water vapor and other gas stream constituents from the natural gas and becomes “rich” glycol. This glycol is then regenerated in the glycol dehydration unit reboiler. The “lean” glycol is then recycled.

Hazardous air pollutants (HAP) means any air pollutants listed in or pursuant to section 112(b) of the CAA.

Institutional emergency stationary RICE means an emergency stationary RICE used in institutional establishments such as medical centers, nursing homes, research centers, institutions of higher education, correctional facilities, elementary and secondary schools, libraries, religious establishments, police stations, and fire stations.

ISO standard day conditions means 288 degrees Kelvin (15 degrees Celsius), 60 percent relative humidity and 101.3 kilopascals pressure.

Landfill gas means a gaseous by-product of the land application of municipal refuse typically formed through the anaerobic decomposition of waste materials and composed principally of methane and CO₂.

Lean burn engine means any two-stroke or four-stroke spark ignited engine that does not meet the definition of a rich burn engine.

Limited use stationary RICE means any stationary RICE that operates less than 100 hours per year.

Liquefied petroleum gas means any liquefied hydrocarbon gas obtained as a by-product in petroleum refining of natural gas production.

Liquid fuel means any fuel in liquid form at standard temperature and pressure, including but not limited to diesel, residual/crude oil, kerosene/naphtha (jet fuel), and gasoline.

Major Source, as used in this subpart, shall have the same meaning as in § 63.2, except that:

(1) Emissions from any oil or gas exploration or production well (with its associated equipment (as defined in this section)) and emissions from any pipeline compressor station or pump station shall not be aggregated with emissions from other similar units, to determine whether such emission points or stations are major sources, even when emission points are in a contiguous area or under common control;

(2) For oil and gas production facilities, emissions from processes, operations, or equipment that are not part of the same oil and gas production facility, as defined in § 63.1271 of subpart HHH of this part, shall not be aggregated;

(3) For production field facilities, only HAP emissions from glycol dehydration units, storage vessel with the potential for flash emissions, combustion turbines and reciprocating internal combustion engines shall be aggregated for a major source determination; and

(4) Emissions from processes, operations, and equipment that are not part of the same natural gas transmission and storage facility, as defined in § 63.1271 of subpart HHH of this part, shall not be aggregated.

Malfunction means any sudden, infrequent, and not reasonably preventable failure of air pollution control equipment, process equipment, or a process to operate in a normal or usual manner which causes, or has the potential to cause, the emission limitations in an applicable standard to be exceeded. Failures that are caused in part by poor maintenance or careless operation are not malfunctions.

Natural gas means a naturally occurring mixture of hydrocarbon and non-hydrocarbon gases found in geologic formations beneath the Earth's surface, of which the principal constituent is methane. Natural gas may be field or pipeline quality.

Non-selective catalytic reduction (NSCR) means an add-on catalytic nitrogen oxides (NO_x) control device for rich burn engines that, in a two-step reaction, promotes the conversion of excess oxygen, NO_x, CO, and volatile organic compounds (VOC) into CO₂, nitrogen, and water.

Oil and gas production facility as used in this subpart means any grouping of equipment where hydrocarbon liquids are processed, upgraded (*i.e.*, remove impurities or other constituents to meet contract specifications), or stored prior to the point of custody transfer; or where natural gas is processed, upgraded, or stored prior to entering the natural gas transmission and storage source category. For purposes of a major source determination, facility (including a building, structure, or installation) means oil and natural gas production and processing equipment that is located within the boundaries of an individual surface site as defined in this section. Equipment that is part of a facility will typically be located within close proximity to other equipment located at the same facility. Pieces of production equipment or groupings of equipment located on different oil and gas leases, mineral fee tracts, lease tracts, subsurface or surface unit areas, surface fee tracts, surface lease tracts, or separate surface sites, whether or not connected by a road, waterway, power line or pipeline, shall not be considered part of the same facility. Examples of facilities in the oil and natural gas production source category include, but are not limited to, well sites, satellite tank batteries, central tank batteries, a compressor station that transports natural gas to a natural gas processing plant, and natural gas processing plants.

Oxidation catalyst means an add-on catalytic control device that controls CO and VOC by oxidation.

Peaking unit or engine means any standby engine intended for use during periods of high demand that are not emergencies.

Percent load means the fractional power of an engine compared to its maximum manufacturer's design capacity at engine site conditions. Percent load may range between 0 percent to above 100 percent.

Potential to emit means the maximum capacity of a stationary source to emit a pollutant under its physical and operational design. Any physical or operational limitation on the capacity of the stationary source to emit a pollutant, including air pollution control equipment and restrictions on hours of operation or on the type or amount of material combusted, stored, or processed, shall be treated as part of its design if the limitation or the effect it would have on emissions is federally enforceable. For oil and natural gas production facilities subject to subpart HH of this part, the potential to emit provisions in § 63.760(a) may be used. For natural gas transmission and storage facilities subject to subpart HHH of this part, the maximum annual facility gas throughput for storage facilities may be determined according to § 63.1270(a)(1) and the maximum annual throughput for transmission facilities may be determined according to § 63.1270(a)(2).

Production field facility means those oil and gas production facilities located prior to the point of custody transfer.

Production well means any hole drilled in the earth from which crude oil, condensate, or field natural gas is extracted.

Propane means a colorless gas derived from petroleum and natural gas, with the molecular structure C₃ H₈.

Remote stationary RICE means stationary RICE meeting any of the following criteria:

(1) Stationary RICE located in an offshore area that is beyond the line of ordinary low water along that portion of the coast of the United States that is in direct contact with the open seas and beyond the line marking the seaward limit of inland waters.

(2) Stationary RICE located on a pipeline segment that meets both of the criteria in paragraphs (2) (i) and (ii) of this definition.

(i) A pipeline segment with 10 or fewer buildings intended for human occupancy and no buildings with four or more stories within 220 yards (200 meters) on either side of the centerline of any continuous 1-mile (1.6 kilometers) length of pipeline. Each separate dwelling unit in a multiple dwelling unit building is counted as a separate building intended for human occupancy.

(ii) The pipeline segment does not lie within 100 yards (91 meters) of either a building or a small, well-defined outside area (such as a playground, recreation area, outdoor theater, or other place of public assembly) that is occupied by 20 or more persons on at least 5 days a week for 10 weeks in any 12-month period. The days and weeks need not be consecutive. The building or area is considered occupied for a full day if it is occupied for any portion of the day.

(iii) For purposes of this paragraph (2), the term pipeline segment means all parts of those physical facilities through which gas moves in transportation, including but not limited to pipe, valves, and other appurtenance attached to pipe, compressor units, metering stations, regulator stations, delivery stations, holders, and fabricated assemblies. Stationary RICE located within 50 yards (46 meters) of the pipeline segment providing power for equipment on a pipeline segment are part of the pipeline segment. Transportation of gas means the gathering, transmission, or distribution of gas by pipeline, or the storage of gas. A building is intended for human occupancy if its primary use is for a purpose involving the presence of humans.

(3) Stationary RICE that are not located on gas pipelines and that have 5 or fewer buildings intended for human occupancy and no buildings with four or more stories within a 0.25 mile radius around the engine. A building is intended for human occupancy if its primary use is for a purpose involving the presence of humans.

Residential emergency stationary RICE means an emergency stationary RICE used in residential establishments such as homes or apartment buildings.

Responsible official means responsible official as defined in 40 CFR 70.2.

Rich burn engine means any four-stroke spark ignited engine where the manufacturer's recommended operating air/fuel ratio divided by the stoichiometric air/fuel ratio at full load conditions is less than or equal to 1.1. Engines originally manufactured as rich burn engines, but modified prior to December 19, 2002 with passive emission control technology for NO_x (such as pre-combustion chambers) will be considered lean burn engines. Also, existing engines where there are no manufacturer's recommendations regarding air/fuel ratio will be considered a rich burn engine if the excess oxygen content of the exhaust at full load conditions is less than or equal to 2 percent.

Site-rated HP means the maximum manufacturer's design capacity at engine site conditions.

Spark ignition means relating to either: A gasoline-fueled engine; or any other type of engine with a spark plug (or other sparking device) and with operating characteristics significantly similar to the theoretical Otto combustion cycle. Spark ignition engines usually use a throttle to regulate intake air flow to control power during normal operation. Dual-fuel engines in which a liquid fuel (typically diesel fuel) is used for CI and gaseous fuel (typically natural gas) is used as the primary fuel at an annual average ratio of less than 2 parts diesel fuel to 100 parts total fuel on an energy equivalent basis are spark ignition engines.

Stationary reciprocating internal combustion engine (RICE) means any reciprocating internal combustion engine which uses reciprocating motion to convert heat energy into mechanical work and which is not mobile. Stationary RICE differ from mobile RICE in that a stationary RICE is not a non-road engine as defined at 40 CFR 1068.30, and is not used to propel a motor vehicle or a vehicle used solely for competition.

Stationary RICE test cell/stand means an engine test cell/stand, as defined in subpart P of this part, that tests stationary RICE.

Stoichiometric means the theoretical air-to-fuel ratio required for complete combustion.

Storage vessel with the potential for flash emissions means any storage vessel that contains a hydrocarbon liquid with a stock tank gas-to-oil ratio equal to or greater than 0.31 cubic meters per liter and an American Petroleum Institute gravity equal to or greater than 40 degrees and an actual annual average hydrocarbon liquid throughput equal to or greater than 79,500 liters per day. Flash emissions occur when dissolved hydrocarbons in the fluid evolve from solution when the fluid pressure is reduced.

Subpart means 40 CFR part 63, subpart ZZZZ.

Surface site means any combination of one or more graded pad sites, gravel pad sites, foundations, platforms, or the immediate physical location upon which equipment is physically affixed.

Two-stroke engine means a type of engine which completes the power cycle in single crankshaft revolution by combining the intake and compression operations into one stroke and the power and exhaust operations into a second stroke. This system requires auxiliary scavenging and inherently runs lean of stoichiometric.

[69 FR 33506, June 15, 2004, as amended at 71 FR 20467, Apr. 20, 2006; 73 FR 3607, Jan. 18, 2008; 75 FR 9679, Mar. 3, 2010; 75 FR 51592, Aug. 20, 2010; 76 FR 12867, Mar. 9, 2011; 78 FR 6706, Jan. 30, 2013]

Table 1 a to Subpart ZZZZ of Part 63—Emission Limitations for Existing, New, and Reconstructed Spark Ignition, 4SRB Stationary RICE > 500 HP Located at a Major Source of HAP Emissions

As stated in §§ 63.6600 and 63.6640, you must comply with the following emission limitations at 100 percent load plus or minus 10 percent for existing, new and reconstructed 4SRB stationary RICE >500 HP located at a major source of HAP emissions:

For each . . .	You must meet the following emission limitation, except during periods of startup . . .	During periods of startup you must . . .
1. 4SRB stationary RICE	a. Reduce formaldehyde emissions by 76 percent or more. If you commenced construction or reconstruction between December 19, 2002 and June 15, 2004, you may reduce formaldehyde emissions by 75 percent or more until June 15, 2007 or	Minimize the engine's time spent at idle and minimize the engine's startup time at startup to a period needed for appropriate and safe loading of the engine, not to exceed 30 minutes, after which time the non-startup emission limitations apply. ¹
	b. Limit the concentration of formaldehyde in the stationary RICE exhaust to 350 ppbvd or less at 15 percent O ₂	

¹Sources can petition the Administrator pursuant to the requirements of 40 CFR 63.6(g) for alternative work practices.

[75 FR 9679, Mar. 3, 2010, as amended at 75 FR 51592, Aug. 20, 2010]

Table 1 b to Subpart ZZZZ of Part 63—Operating Limitations for Existing, New, and Reconstructed SI 4SRB Stationary RICE >500 HP Located at a Major Source of HAP Emissions

As stated in §§ 63.6600, 63.6603, 63.6630 and 63.6640, you must comply with the following operating limitations for existing, new and reconstructed 4SRB stationary RICE >500 HP located at a major source of HAP emissions:

For each . . .	You must meet the following operating limitation, except during periods of startup . . .

<p>1. existing, new and reconstructed 4SRB stationary RICE >500 HP located at a major source of HAP emissions complying with the requirement to reduce formaldehyde emissions by 76 percent or more (or by 75 percent or more, if applicable) and using NSCR; or existing, new and reconstructed 4SRB stationary RICE >500 HP located at a major source of HAP emissions complying with the requirement to limit the concentration of formaldehyde in the stationary RICE exhaust to 350 ppbvd or less at 15 percent O₂ and using NSCR;</p>	<p>a. maintain your catalyst so that the pressure drop across the catalyst does not change by more than 2 inches of water at 100 percent load plus or minus 10 percent from the pressure drop across the catalyst measured during the initial performance test; and b. maintain the temperature of your stationary RICE exhaust so that the catalyst inlet temperature is greater than or equal to 750 °F and less than or equal to 1250 °F.¹</p>
<p>2. existing, new and reconstructed 4SRB stationary RICE >500 HP located at a major source of HAP emissions complying with the requirement to reduce formaldehyde emissions by 76 percent or more (or by 75 percent or more, if applicable) and not using NSCR; or</p>	<p>Comply with any operating limitations approved by the Administrator.</p>
<p>existing, new and reconstructed 4SRB stationary RICE >500 HP located at a major source of HAP emissions complying with the requirement to limit the concentration of formaldehyde in the stationary RICE exhaust to 350 ppbvd or less at 15 percent O₂ and not using NSCR.</p>	

¹ Sources can petition the Administrator pursuant to the requirements of 40 CFR 63.8(f) for a different temperature range.

[78 FR 6706, Jan. 30, 2013]

Table 2 a to Subpart ZZZZ of Part 63—Emission Limitations for New and Reconstructed 2SLB and Compression Ignition Stationary RICE >500 HP and New and Reconstructed 4SLB Stationary RICE ≥250 HP Located at a Major Source of HAP Emissions

As stated in §§ 63.6600 and 63.6640, you must comply with the following emission limitations for new and reconstructed lean burn and new and reconstructed compression ignition stationary RICE at 100 percent load plus or minus 10 percent:

For each . . .	You must meet the following emission limitation, except during periods of startup . . .	During periods of startup you must . . .
1. 2SLB stationary RICE	<p>a. Reduce CO emissions by 58 percent or more; or b. Limit concentration of formaldehyde in the stationary RICE exhaust to 12 ppmvd or less at 15 percent O₂. If you commenced construction or reconstruction between December 19, 2002 and June 15, 2004, you may limit concentration of formaldehyde to 17 ppmvd or less at 15 percent O₂ until June 15, 2007</p>	<p>Minimize the engine's time spent at idle and minimize the engine's startup time at startup to a period needed for appropriate and safe loading of the engine, not to exceed 30 minutes, after which time the non-startup emission limitations apply.¹</p>
2. 4SLB stationary RICE	<p>a. Reduce CO emissions by 93 percent or more; or</p>	
	<p>b. Limit concentration of formaldehyde in the stationary RICE exhaust to 14 ppmvd or less at 15 percent O₂</p>	

3. CI stationary RICE	a. Reduce CO emissions by 70 percent or more; or	
	b. Limit concentration of formaldehyde in the stationary RICE exhaust to 580 ppbvd or less at 15 percent O ₂	

¹ Sources can petition the Administrator pursuant to the requirements of 40 CFR 63.6(g) for alternative work practices.

[75 FR 9680, Mar. 3, 2010]

Table 2 b to Subpart ZZZZ of Part 63—Operating Limitations for New and Reconstructed 2SLB and CI Stationary RICE >500 HP Located at a Major Source of HAP Emissions, New and Reconstructed 4SLB Stationary RICE ≥250 HP Located at a Major Source of HAP Emissions, Existing CI Stationary RICE >500 HP

As stated in §§ 63.6600, 63.6601, 63.6603, 63.6630, and 63.6640, you must comply with the following operating limitations for new and reconstructed 2SLB and CI stationary RICE >500 HP located at a major source of HAP emissions; new and reconstructed 4SLB stationary RICE ≥250 HP located at a major source of HAP emissions; and existing CI stationary RICE >500 HP:

For each . . .	You must meet the following operating limitation, except during periods of startup . . .
1. New and reconstructed 2SLB and CI stationary RICE >500 HP located at a major source of HAP emissions and new and reconstructed 4SLB stationary RICE ≥250 HP located at a major source of HAP emissions complying with the requirement to reduce CO emissions and using an oxidation catalyst; and New and reconstructed 2SLB and CI stationary RICE >500 HP located at a major source of HAP emissions and new and reconstructed 4SLB stationary RICE ≥250 HP located at a major source of HAP emissions complying with the requirement to limit the concentration of formaldehyde in the stationary RICE exhaust and using an oxidation catalyst.	a. maintain your catalyst so that the pressure drop across the catalyst does not change by more than 2 inches of water at 100 percent load plus or minus 10 percent from the pressure drop across the catalyst that was measured during the initial performance test; and b. maintain the temperature of your stationary RICE exhaust so that the catalyst inlet temperature is greater than or equal to 450 °F and less than or equal to 1350 °F. ¹
2. Existing CI stationary RICE >500 HP complying with the requirement to limit or reduce the concentration of CO in the stationary RICE exhaust and using an oxidation catalyst	a. maintain your catalyst so that the pressure drop across the catalyst does not change by more than 2 inches of water from the pressure drop across the catalyst that was measured during the initial performance test; and
	b. maintain the temperature of your stationary RICE exhaust so that the catalyst inlet temperature is greater than or equal to 450 °F and less than or equal to 1350 °F. ¹
3. New and reconstructed 2SLB and CI stationary RICE >500 HP located at a major source of HAP emissions and new and reconstructed 4SLB stationary RICE ≥250 HP located at a major source of HAP emissions complying with the requirement to reduce CO emissions and not using an oxidation catalyst; and	Comply with any operating limitations approved by the Administrator.
New and reconstructed 2SLB and CI stationary RICE >500 HP located at a major source of HAP emissions	

and new and reconstructed 4SLB stationary RICE ≥250 HP located at a major source of HAP emissions complying with the requirement to limit the concentration of formaldehyde in the stationary RICE exhaust and not using an oxidation catalyst; and	
existing CI stationary RICE >500 HP complying with the requirement to limit or reduce the concentration of CO in the stationary RICE exhaust and not using an oxidation catalyst.	

¹ Sources can petition the Administrator pursuant to the requirements of 40 CFR 63.8(f) for a different temperature range.

[78 FR 6707, Jan. 30, 2013]

Table 2 c to Subpart ZZZZ of Part 63—Requirements for Existing Compression Ignition Stationary RICE Located at a Major Source of HAP Emissions and Existing Spark Ignition Stationary RICE ≤500 HP Located at a Major Source of HAP Emissions

As stated in §§ 63.6600, 63.6602, and 63.6640, you must comply with the following requirements for existing compression ignition stationary RICE located at a major source of HAP emissions and existing spark ignition stationary RICE ≤500 HP located at a major source of HAP emissions:

For each . . .	You must meet the following requirement, except during periods of startup . . .	During periods of startup you must . . .
1. Emergency stationary CI RICE and black start stationary CI RICE ¹	a. Change oil and filter every 500 hours of operation or annually, whichever comes first. ² b. Inspect air cleaner every 1,000 hours of operation or annually, whichever comes first, and replace as necessary; c. Inspect all hoses and belts every 500 hours of operation or annually, whichever comes first, and replace as necessary. ³	Minimize the engine's time spent at idle and minimize the engine's startup time at startup to a period needed for appropriate and safe loading of the engine, not to exceed 30 minutes, after which time the non-startup emission limitations apply. ³
2. Non-Emergency, non-black start stationary CI RICE <100 HP	a. Change oil and filter every 1,000 hours of operation or annually, whichever comes first. ² b. Inspect air cleaner every 1,000 hours of operation or annually, whichever comes first, and replace as necessary; c. Inspect all hoses and belts every 500 hours of operation or annually, whichever comes first, and replace as necessary. ³	

3. Non-Emergency, non-black start CI stationary RICE 100≤HP≤300 HP	Limit concentration of CO in the stationary RICE exhaust to 230 ppmvd or less at 15 percent O ₂ .	
4. Non-Emergency, non-black start CI stationary RICE 300<HP≤500	a. Limit concentration of CO in the stationary RICE exhaust to 49 ppmvd or less at 15 percent O ₂ ; or b. Reduce CO emissions by 70 percent or more.	
5. Non-Emergency, non-black start stationary CI RICE >500 HP	a. Limit concentration of CO in the stationary RICE exhaust to 23 ppmvd or less at 15 percent O ₂ ; or b. Reduce CO emissions by 70 percent or more.	
6. Emergency stationary SI RICE and black start stationary SI RICE. ¹	a. Change oil and filter every 500 hours of operation or annually, whichever comes first; ² b. Inspect spark plugs every 1,000 hours of operation or annually, whichever comes first, and replace as necessary; c. Inspect all hoses and belts every 500 hours of operation or annually, whichever comes first, and replace as necessary. ³	
7. Non-Emergency, non-black start stationary SI RICE <100 HP that are not 2SLB stationary RICE	a. Change oil and filter every 1,440 hours of operation or annually, whichever comes first; ² b. Inspect spark plugs every 1,440 hours of operation or annually, whichever comes first, and replace as necessary;	
	c. Inspect all hoses and belts every 1,440 hours of operation or annually, whichever comes first, and replace as necessary. ³	
8. Non-Emergency, non-black start 2SLB stationary SI RICE <100 HP	a. Change oil and filter every 4,320 hours of operation or annually, whichever comes first; ² b. Inspect spark plugs every 4,320 hours of operation or annually, whichever comes first, and replace as necessary;	
	c. Inspect all hoses and belts every 4,320 hours of	

	operation or annually, whichever comes first, and replace as necessary. ³	
9. Non-emergency, non-black start 2SLB stationary RICE 100≤HP≤500	Limit concentration of CO in the stationary RICE exhaust to 225 ppmvd or less at 15 percent O ₂ .	
10. Non-emergency, non-black start 4SLB stationary RICE 100≤HP≤500	Limit concentration of CO in the stationary RICE exhaust to 47 ppmvd or less at 15 percent O ₂ .	
11. Non-emergency, non-black start 4SRB stationary RICE 100≤HP≤500	Limit concentration of formaldehyde in the stationary RICE exhaust to 10.3 ppmvd or less at 15 percent O ₂ .	
12. Non-emergency, non-black start stationary RICE 100≤HP≤500 which combusts landfill or digester gas equivalent to 10 percent or more of the gross heat input on an annual basis	Limit concentration of CO in the stationary RICE exhaust to 177 ppmvd or less at 15 percent O ₂ .	

¹ If an emergency engine is operating during an emergency and it is not possible to shut down the engine in order to perform the work practice requirements on the schedule required in Table 2c of this subpart, or if performing the work practice on the required schedule would otherwise pose an unacceptable risk under federal, state, or local law, the work practice can be delayed until the emergency is over or the unacceptable risk under federal, state, or local law has abated. The work practice should be performed as soon as practicable after the emergency has ended or the unacceptable risk under federal, state, or local law has abated. Sources must report any failure to perform the work practice on the schedule required and the federal, state or local law under which the risk was deemed unacceptable.

² Sources have the option to utilize an oil analysis program as described in § 63.6625(i) or (j) in order to extend the specified oil change requirement in Table 2c of this subpart.

³ Sources can petition the Administrator pursuant to the requirements of 40 CFR 63.6(g) for alternative work practices.

[78 FR 6708, Jan. 30, 2013, as amended at 78 FR 14457, Mar. 6, 2013]

Table 2 d to Subpart ZZZZ of Part 63—Requirements for Existing Stationary RICE Located at Area Sources of HAP Emissions

As stated in §§ 63.6603 and 63.6640, you must comply with the following requirements for existing stationary RICE located at area sources of HAP emissions:

For each . . .	You must meet the following requirement, except during periods of startup . . .	During periods of startup you must . . .
1. Non-Emergency, non-black start CI stationary RICE ≤300 HP	a. Change oil and filter every 1,000 hours of operation or annually, whichever comes first; ¹	Minimize the engine's time spent at idle and minimize the engine's startup time at startup to a period needed for appropriate and safe

	<p>b. Inspect air cleaner every 1,000 hours of operation or annually, whichever comes first, and replace as necessary;</p> <p>c. Inspect all hoses and belts every 500 hours of operation or annually, whichever comes first, and replace as necessary.</p>	<p>loading of the engine, not to exceed 30 minutes, after which time the non-startup emission limitations apply.</p>
2. Non-Emergency, non-black start CI stationary RICE 300<HP≤500	<p>a. Limit concentration of CO in the stationary RICE exhaust to 49 ppmvd at 15 percent O₂; or</p>	
	<p>b. Reduce CO emissions by 70 percent or more.</p>	
3. Non-Emergency, non-black start CI stationary RICE >500 HP	<p>a. Limit concentration of CO in the stationary RICE exhaust to 23 ppmvd at 15 percent O₂; or</p>	
	<p>b. Reduce CO emissions by 70 percent or more.</p>	
4. Emergency stationary CI RICE and black start stationary CI RICE. ²	<p>a. Change oil and filter every 500 hours of operation or annually, whichever comes first;¹</p>	
	<p>b. Inspect air cleaner every 1,000 hours of operation or annually, whichever comes first, and replace as necessary; and</p>	
	<p>c. Inspect all hoses and belts every 500 hours of operation or annually, whichever comes first, and replace as necessary.</p>	
5. Emergency stationary SI RICE; black start stationary SI RICE; non-emergency, non-black start 4SLB stationary RICE >500 HP that operate 24 hours or less per calendar year; non-emergency, non-black start 4SRB stationary RICE >500 HP that operate 24 hours or less per calendar year. ²	<p>a. Change oil and filter every 500 hours of operation or annually, whichever comes first;¹;</p> <p>b. Inspect spark plugs every 1,000 hours of operation or annually, whichever comes first, and replace as necessary; and</p> <p>c. Inspect all hoses and belts every 500 hours of</p>	

	operation or annually, whichever comes first, and replace as necessary.	
6. Non-emergency, non-black start 2SLB stationary RICE	a. Change oil and filter every 4,320 hours of operation or annually, whichever comes first; ¹	
	b. Inspect spark plugs every 4,320 hours of operation or annually, whichever comes first, and replace as necessary; and	
	c. Inspect all hoses and belts every 4,320 hours of operation or annually, whichever comes first, and replace as necessary.	
7. Non-emergency, non-black start 4SLB stationary RICE ≤500 HP	a. Change oil and filter every 1,440 hours of operation or annually, whichever comes first; ¹	
	b. Inspect spark plugs every 1,440 hours of operation or annually, whichever comes first, and replace as necessary; and	
	c. Inspect all hoses and belts every 1,440 hours of operation or annually, whichever comes first, and replace as necessary.	
8. Non-emergency, non-black start 4SLB remote stationary RICE >500 HP	a. Change oil and filter every 2,160 hours of operation or annually, whichever comes first; ¹	
	b. Inspect spark plugs every 2,160 hours of operation or annually, whichever comes first, and replace as necessary; and	
	c. Inspect all hoses and belts every 2,160 hours of operation or annually, whichever comes first, and replace as necessary.	
9. Non-emergency, non-black start 4SLB stationary RICE >500 HP that are not	Install an oxidation catalyst to reduce HAP	

remote stationary RICE and that operate more than 24 hours per calendar year	emissions from the stationary RICE.	
10. Non-emergency, non-black start 4SRB stationary RICE ≤500 HP	a. Change oil and filter every 1,440 hours of operation or annually, whichever comes first; ¹	
	b. Inspect spark plugs every 1,440 hours of operation or annually, whichever comes first, and replace as necessary; and	
	c. Inspect all hoses and belts every 1,440 hours of operation or annually, whichever comes first, and replace as necessary.	
11. Non-emergency, non-black start 4SRB remote stationary RICE >500 HP	a. Change oil and filter every 2,160 hours of operation or annually, whichever comes first; ¹	
	b. Inspect spark plugs every 2,160 hours of operation or annually, whichever comes first, and replace as necessary; and	
	c. Inspect all hoses and belts every 2,160 hours of operation or annually, whichever comes first, and replace as necessary.	
12. Non-emergency, non-black start 4SRB stationary RICE >500 HP that are not remote stationary RICE and that operate more than 24 hours per calendar year	Install NSCR to reduce HAP emissions from the stationary RICE.	
13. Non-emergency, non-black start stationary RICE which combusts landfill or digester gas equivalent to 10 percent or more of the gross heat input on an annual basis	a. Change oil and filter every 1,440 hours of operation or annually, whichever comes first; ¹	
	b. Inspect spark plugs every 1,440 hours of operation or annually, whichever comes first, and replace as necessary; and	
	c. Inspect all hoses and belts every 1,440 hours of operation or annually, whichever comes first, and replace as necessary.	

¹ Sources have the option to utilize an oil analysis program as described in § 63.6625(i) or (j) in order to extend the specified oil change requirement in Table 2d of this subpart.

² If an emergency engine is operating during an emergency and it is not possible to shut down the engine in order to perform the management practice requirements on the schedule required in Table 2d of this subpart, or if performing the management practice on the required schedule would otherwise pose an unacceptable risk under federal, state, or local law, the management practice can be delayed until the emergency is over or the unacceptable risk under federal, state, or local law has abated. The management practice should be performed as soon as practicable after the emergency has ended or the unacceptable risk under federal, state, or local law has abated. Sources must report any failure to perform the management practice on the schedule required and the federal, state or local law under which the risk was deemed unacceptable.

[78 FR 6709, Jan. 30, 2013]

Table 3 to Subpart ZZZZ of Part 63—Subsequent Performance Tests

As stated in §§ 63.6615 and 63.6620, you must comply with the following subsequent performance test requirements:

For each . . .	Complying with the requirement to . . .	You must . . .
1. New or reconstructed 2SLB stationary RICE >500 HP located at major sources; new or reconstructed 4SLB stationary RICE ≥250 HP located at major sources; and new or reconstructed CI stationary RICE >500 HP located at major sources	Reduce CO emissions and not using a CEMS	Conduct subsequent performance tests semiannually. ¹
2. 4SRB stationary RICE ≥5,000 HP located at major sources	Reduce formaldehyde emissions	Conduct subsequent performance tests semiannually. ¹
3. Stationary RICE >500 HP located at major sources and new or reconstructed 4SLB stationary RICE 250≤HP≤500 located at major sources	Limit the concentration of formaldehyde in the stationary RICE exhaust	Conduct subsequent performance tests semiannually. ¹
4. Existing non-emergency, non-black start CI stationary RICE >500 HP that are not limited use stationary RICE	Limit or reduce CO emissions and not using a CEMS	Conduct subsequent performance tests every 8,760 hours or 3 years, whichever comes first.
5. Existing non-emergency, non-black start CI stationary RICE >500 HP that are limited use stationary RICE	Limit or reduce CO emissions and not using a CEMS	Conduct subsequent performance tests every 8,760 hours or 5 years, whichever comes first.

¹ After you have demonstrated compliance for two consecutive tests, you may reduce the frequency of subsequent performance tests to annually. If the results of any subsequent annual performance test indicate the stationary RICE is not in compliance with the CO or formaldehyde emission limitation, or you deviate from any of your operating limitations, you must resume semiannual performance tests.

[78 FR 6711, Jan. 30, 2013]

Table 4 to Subpart ZZZZ of Part 63—Requirements for Performance Tests

As stated in §§ 63.6610, 63.6611, 63.6612, 63.6620, and 63.6640, you must comply with the following requirements for performance tests for stationary RICE:

--	--	--	--	--

For each . . .	Complying with the requirement to . . .	You must . . .	Using . . .	According to the following requirements . . .
1. 2SLB, 4SLB, and CI stationary RICE	a. reduce CO emissions	i. Measure the O ₂ at the inlet and outlet of the control device; and	(1) Method 3 or 3A or 3B of 40 CFR part 60, appendix A, or ASTM Method D6522-00 (Reapproved 2005). ^{a c}	(a) Measurements to determine O ₂ must be made at the same time as the measurements for CO concentration.
		ii. Measure the CO at the inlet and the outlet of the control device	(1) ASTM D6522-00 (Reapproved 2005) ^{a b c} or Method 10 of 40 CFR part 60, appendix A	(a) The CO concentration must be at 15 percent O ₂ , dry basis.
2. 4SRB stationary RICE	a. reduce formaldehyde emissions	i. Select the sampling port location and the number of traverse points; and	(1) Method 1 or 1A of 40 CFR part 60, appendix A § 63.7(d)(1)(i)	(a) sampling sites must be located at the inlet and outlet of the control device.
		ii. Measure O ₂ at the inlet and outlet of the control device; and	(1) Method 3 or 3A or 3B of 40 CFR part 60, appendix A, or ASTM Method D6522-00 (Reapproved 2005). ^a	(a) measurements to determine O ₂ concentration must be made at the same time as the measurements for formaldehyde or THC concentration.
		iii. Measure moisture content at the inlet and outlet of the control device; and	(1) Method 4 of 40 CFR part 60, appendix A, or Test Method 320 of 40 CFR part 63, appendix A, or ASTM D 6348-03. ^a	(a) measurements to determine moisture content must be made at the same time and location as the measurements for formaldehyde or THC concentration.
		iv. If demonstrating compliance with the formaldehyde percent reduction requirement, measure formaldehyde at the inlet and the outlet of the control device	(1) Method 320 or 323 of 40 CFR part 63, appendix A; or ASTM D6348-03, ^a provided in ASTM D6348-03 Annex A5 (Analyte Spiking Technique), the percent R must be greater than or equal to 70 and less than or equal to 130	(a) formaldehyde concentration must be at 15 percent O ₂ , dry basis. Results of this test consist of the average of the three 1-hour or longer runs.
		v. If demonstrating compliance with the THC percent reduction requirement, measure THC at the inlet and the outlet of the control device	(1) Method 25A, reported as propane, of 40 CFR part 60, appendix A	(a) THC concentration must be at 15 percent O ₂ , dry basis. Results of this test consist of the average of the three 1-hour or longer runs.
3. Stationary RICE	a. limit the concentration of formaldehyde or CO in the	i. Select the sampling port location and the number of traverse points; and	(1) Method 1 or 1A of 40 CFR part 60, appendix A § 63.7(d)(1)(i)	(a) if using a control device, the sampling site must be located at the

	stationary RICE exhaust			outlet of the control device.
		ii. Determine the O ₂ concentration of the stationary RICE exhaust at the sampling port location; and	(1) Method 3 or 3A or 3B of 40 CFR part 60, appendix A, or ASTM Method D6522-00 (Reapproved 2005). ^a	(a) measurements to determine O ₂ concentration must be made at the same time and location as the measurements for formaldehyde or CO concentration.
		iii. Measure moisture content of the stationary RICE exhaust at the sampling port location; and	(1) Method 4 of 40 CFR part 60, appendix A, or Test Method 320 of 40 CFR part 63, appendix A, or ASTM D 6348-03. ^a	(a) measurements to determine moisture content must be made at the same time and location as the measurements for formaldehyde or CO concentration.
		iv. Measure formaldehyde at the exhaust of the stationary RICE; or	(1) Method 320 or 323 of 40 CFR part 63, appendix A; or ASTM D6348-03, ^a provided in ASTM D6348-03 Annex A5 (Analyte Spiking Technique), the percent R must be greater than or equal to 70 and less than or equal to 130	(a) Formaldehyde concentration must be at 15 percent O ₂ , dry basis. Results of this test consist of the average of the three 1-hour or longer runs.
		v. measure CO at the exhaust of the stationary RICE.	(1) Method 10 of 40 CFR part 60, appendix A, ASTM Method D6522-00 (2005), ^a ^c Method 320 of 40 CFR part 63, appendix A, or ASTM D6348-03. ^a	(a) CO concentration must be at 15 percent O ₂ , dry basis. Results of this test consist of the average of the three 1-hour or longer runs.

^a Incorporated by reference, see 40 CFR 63.14. You may also obtain copies from University Microfilms International, 300 North Zeeb Road, Ann Arbor, MI 48106.

^b You may also use Method 320 of 40 CFR part 63, appendix A, or ASTM D6348-03.

^c ASTM-D6522-00 (2005) may be used to test both CI and SI stationary RICE.

[78 FR 6711, Jan. 30, 2013]

Table 5 to Subpart ZZZZ of Part 63—Initial Compliance With Emission Limitations, Operating Limitations, and Other Requirements

As stated in §§ 63.6612, 63.6625 and 63.6630, you must initially comply with the emission and operating limitations as required by the following:

For each . . .	Complying with the requirement to . . .	You have demonstrated initial compliance if . . .
1. New or reconstructed non-emergency 2SLB stationary RICE >500 HP located	a. Reduce CO emissions and using	i. The average reduction of emissions of CO determined from the

<p>at a major source of HAP, new or reconstructed non-emergency 4SLB stationary RICE ≥ 250 HP located at a major source of HAP, non-emergency stationary CI RICE >500 HP located at a major source of HAP, and existing non-emergency stationary CI RICE >500 HP located at an area source of HAP</p>	<p>oxidation catalyst, and using a CPMS</p>	<p>initial performance test achieves the required CO percent reduction; and ii. You have installed a CPMS to continuously monitor catalyst inlet temperature according to the requirements in § 63.6625(b); and iii. You have recorded the catalyst pressure drop and catalyst inlet temperature during the initial performance test.</p>
<p>2. Non-emergency stationary CI RICE >500 HP located at a major source of HAP, and existing non-emergency stationary CI RICE >500 HP located at an area source of HAP</p>	<p>a. Limit the concentration of CO, using oxidation catalyst, and using a CPMS</p>	<p>i. The average CO concentration determined from the initial performance test is less than or equal to the CO emission limitation; and</p>
		<p>ii. You have installed a CPMS to continuously monitor catalyst inlet temperature according to the requirements in § 63.6625(b); and</p>
		<p>iii. You have recorded the catalyst pressure drop and catalyst inlet temperature during the initial performance test.</p>
<p>3. New or reconstructed non-emergency 2SLB stationary RICE >500 HP located at a major source of HAP, new or reconstructed non-emergency 4SLB stationary RICE ≥ 250 HP located at a major source of HAP, non-emergency stationary CI RICE >500 HP located at a major source of HAP, and existing non-emergency stationary CI RICE >500 HP located at an area source of HAP</p>	<p>a. Reduce CO emissions and not using oxidation catalyst</p>	<p>i. The average reduction of emissions of CO determined from the initial performance test achieves the required CO percent reduction; and ii. You have installed a CPMS to continuously monitor operating parameters approved by the Administrator (if any) according to the requirements in § 63.6625(b); and iii. You have recorded the approved operating parameters (if any) during the initial performance test.</p>
<p>4. Non-emergency stationary CI RICE >500 HP located at a major source of HAP, and existing non-emergency stationary CI RICE >500 HP located at an area source of HAP</p>	<p>a. Limit the concentration of CO, and not using oxidation catalyst</p>	<p>i. The average CO concentration determined from the initial performance test is less than or equal to the CO emission limitation; and ii. You have installed a CPMS to continuously monitor operating parameters approved by the Administrator (if any) according to the requirements in § 63.6625(b); and</p>
		<p>iii. You have recorded the approved operating parameters (if any) during the initial performance test.</p>
<p>5. New or reconstructed non-emergency 2SLB stationary RICE >500 HP located at a major source of HAP, new or reconstructed non-emergency 4SLB stationary RICE ≥ 250 HP located at a major source of HAP, non-emergency</p>	<p>a. Reduce CO emissions, and using a CEMS</p>	<p>i. You have installed a CEMS to continuously monitor CO and either O₂ or CO₂ at both the inlet and outlet of the oxidation catalyst according to the requirements in § 63.6625(a); and</p>

stationary CI RICE >500 HP located at a major source of HAP, and existing non-emergency stationary CI RICE >500 HP located at an area source of HAP		ii. You have conducted a performance evaluation of your CEMS using PS 3 and 4A of 40 CFR part 60, appendix B; and
		iii. The average reduction of CO calculated using § 63.6620 equals or exceeds the required percent reduction. The initial test comprises the first 4-hour period after successful validation of the CEMS. Compliance is based on the average percent reduction achieved during the 4-hour period.
6. Non-emergency stationary CI RICE >500 HP located at a major source of HAP, and existing non-emergency stationary CI RICE >500 HP located at an area source of HAP	a. Limit the concentration of CO, and using a CEMS	i. You have installed a CEMS to continuously monitor CO and either O ₂ or CO ₂ at the outlet of the oxidation catalyst according to the requirements in § 63.6625(a); and
		ii. You have conducted a performance evaluation of your CEMS using PS 3 and 4A of 40 CFR part 60, appendix B; and
		iii. The average concentration of CO calculated using § 63.6620 is less than or equal to the CO emission limitation. The initial test comprises the first 4-hour period after successful validation of the CEMS. Compliance is based on the average concentration measured during the 4-hour period.
7. Non-emergency 4SRB stationary RICE >500 HP located at a major source of HAP	a. Reduce formaldehyde emissions and using NSCR	i. The average reduction of emissions of formaldehyde determined from the initial performance test is equal to or greater than the required formaldehyde percent reduction, or the average reduction of emissions of THC determined from the initial performance test is equal to or greater than 30 percent; and
		ii. You have installed a CPMS to continuously monitor catalyst inlet temperature according to the requirements in § 63.6625(b); and
		iii. You have recorded the catalyst pressure drop and catalyst inlet temperature during the initial performance test.
8. Non-emergency 4SRB stationary RICE >500 HP located at a major source of HAP	a. Reduce formaldehyde emissions and not using NSCR	i. The average reduction of emissions of formaldehyde determined from the initial performance test is equal to or greater than the required formaldehyde percent reduction or the average reduction of emissions

		of THC determined from the initial performance test is equal to or greater than 30 percent; and
		ii. You have installed a CPMS to continuously monitor operating parameters approved by the Administrator (if any) according to the requirements in § 63.6625(b); and
		iii. You have recorded the approved operating parameters (if any) during the initial performance test.
9. New or reconstructed non-emergency stationary RICE >500 HP located at a major source of HAP, new or reconstructed non-emergency 4SLB stationary RICE 250≤HP≤500 located at a major source of HAP, and existing non-emergency 4SRB stationary RICE >500 HP located at a major source of HAP	a. Limit the concentration of formaldehyde in the stationary RICE exhaust and using oxidation catalyst or NSCR	i. The average formaldehyde concentration, corrected to 15 percent O ₂ , dry basis, from the three test runs is less than or equal to the formaldehyde emission limitation; and ii. You have installed a CPMS to continuously monitor catalyst inlet temperature according to the requirements in § 63.6625(b); and
		iii. You have recorded the catalyst pressure drop and catalyst inlet temperature during the initial performance test.
10. New or reconstructed non-emergency stationary RICE >500 HP located at a major source of HAP, new or reconstructed non-emergency 4SLB stationary RICE 250≤HP≤500 located at a major source of HAP, and existing non-emergency 4SRB stationary RICE >500 HP located at a major source of HAP	a. Limit the concentration of formaldehyde in the stationary RICE exhaust and not using oxidation catalyst or NSCR	i. The average formaldehyde concentration, corrected to 15 percent O ₂ , dry basis, from the three test runs is less than or equal to the formaldehyde emission limitation; and ii. You have installed a CPMS to continuously monitor operating parameters approved by the Administrator (if any) according to the requirements in § 63.6625(b); and
		iii. You have recorded the approved operating parameters (if any) during the initial performance test.
11. Existing non-emergency stationary RICE 100≤HP≤500 located at a major source of HAP, and existing non-emergency stationary CI RICE 300<HP≤500 located at an area source of HAP	a. Reduce CO emissions	i. The average reduction of emissions of CO or formaldehyde, as applicable determined from the initial performance test is equal to or greater than the required CO or formaldehyde, as applicable, percent reduction.
12. Existing non-emergency stationary RICE 100≤HP≤500 located at a major source of HAP, and existing non-emergency stationary CI RICE 300<HP≤500 located at an area source of HAP	a. Limit the concentration of formaldehyde or CO in the stationary RICE exhaust	i. The average formaldehyde or CO concentration, as applicable, corrected to 15 percent O ₂ , dry basis, from the three test runs is less than or equal to the formaldehyde or CO emission limitation, as applicable.
13. Existing non-emergency 4SLB stationary RICE >500 HP located at an	a. Install an oxidation catalyst	i. You have conducted an initial compliance demonstration as

<p>area source of HAP that are not remote stationary RICE and that are operated more than 24 hours per calendar year</p>		<p>specified in § 63.6630(e) to show that the average reduction of emissions of CO is 93 percent or more, or the average CO concentration is less than or equal to 47 ppmvd at 15 percent O₂;</p>
		<p>ii. You have installed a CPMS to continuously monitor catalyst inlet temperature according to the requirements in § 63.6625(b), or you have installed equipment to automatically shut down the engine if the catalyst inlet temperature exceeds 1350 °F.</p>
<p>14. Existing non-emergency 4SRB stationary RICE >500 HP located at an area source of HAP that are not remote stationary RICE and that are operated more than 24 hours per calendar year</p>	<p>a. Install NSCR</p>	<p>i. You have conducted an initial compliance demonstration as specified in § 63.6630(e) to show that the average reduction of emissions of CO is 75 percent or more, the average CO concentration is less than or equal to 270 ppmvd at 15 percent O₂, or the average reduction of emissions of THC is 30 percent or more;</p>
		<p>ii. You have installed a CPMS to continuously monitor catalyst inlet temperature according to the requirements in § 63.6625(b), or you have installed equipment to automatically shut down the engine if the catalyst inlet temperature exceeds 1250 °F.</p>

[78 FR 6712, Jan. 30, 2013]

Table 6 to Subpart ZZZZ of Part 63—Continuous Compliance With Emission Limitations, and Other Requirements

As stated in § 63.6640, you must continuously comply with the emissions and operating limitations and work or management practices as required by the following:

<p>For each . . .</p>	<p>Complying with the requirement to . . .</p>	<p>You must demonstrate continuous compliance by . . .</p>
<p>1. New or reconstructed non-emergency 2SLB stationary RICE >500 HP located at a major source of HAP, new or reconstructed non-emergency 4SLB stationary RICE ≥250 HP located at a major source of HAP, and new or reconstructed non-emergency CI stationary RICE >500 HP located at a major source of HAP</p>	<p>a. Reduce CO emissions and using an oxidation catalyst, and using a CPMS</p>	<p>i. Conducting semiannual performance tests for CO to demonstrate that the required CO percent reduction is achieved ^a; and ii. Collecting the catalyst inlet temperature data according to § 63.6625(b); and iii. Reducing these data to 4-hour rolling averages; and</p>

		iv. Maintaining the 4-hour rolling averages within the operating limitations for the catalyst inlet temperature; and
		v. Measuring the pressure drop across the catalyst once per month and demonstrating that the pressure drop across the catalyst is within the operating limitation established during the performance test.
2. New or reconstructed non-emergency 2SLB stationary RICE >500 HP located at a major source of HAP, new or reconstructed non-emergency 4SLB stationary RICE ≥250 HP located at a major source of HAP, and new or reconstructed non-emergency CI stationary RICE >500 HP located at a major source of HAP	a. Reduce CO emissions and not using an oxidation catalyst, and using a CPMS	i. Conducting semiannual performance tests for CO to demonstrate that the required CO percent reduction is achieved ^a ; and ii. Collecting the approved operating parameter (if any) data according to § 63.6625(b); and iii. Reducing these data to 4-hour rolling averages; and
		iv. Maintaining the 4-hour rolling averages within the operating limitations for the operating parameters established during the performance test.
3. New or reconstructed non-emergency 2SLB stationary RICE >500 HP located at a major source of HAP, new or reconstructed non-emergency 4SLB stationary RICE ≥250 HP located at a major source of HAP, new or reconstructed non-emergency stationary CI RICE >500 HP located at a major source of HAP, and existing non-emergency stationary CI RICE >500 HP	a. Reduce CO emissions or limit the concentration of CO in the stationary RICE exhaust, and using a CEMS	i. Collecting the monitoring data according to § 63.6625(a), reducing the measurements to 1-hour averages, calculating the percent reduction or concentration of CO emissions according to § 63.6620; and ii. Demonstrating that the catalyst achieves the required percent reduction of CO emissions over the 4-hour averaging period, or that the emission remain at or below the CO concentration limit; and
		iii. Conducting an annual RATA of your CEMS using PS 3 and 4A of 40 CFR part 60, appendix B, as well as daily and periodic data quality checks in accordance with 40 CFR

		part 60, appendix F, procedure 1.
4. Non-emergency 4SRB stationary RICE >500 HP located at a major source of HAP	a. Reduce formaldehyde emissions and using NSCR	i. Collecting the catalyst inlet temperature data according to § 63.6625(b); and
		ii. Reducing these data to 4-hour rolling averages; and
		iii. Maintaining the 4-hour rolling averages within the operating limitations for the catalyst inlet temperature; and
		iv. Measuring the pressure drop across the catalyst once per month and demonstrating that the pressure drop across the catalyst is within the operating limitation established during the performance test.
5. Non-emergency 4SRB stationary RICE >500 HP located at a major source of HAP	a. Reduce formaldehyde emissions and not using NSCR	i. Collecting the approved operating parameter (if any) data according to § 63.6625(b); and
		ii. Reducing these data to 4-hour rolling averages; and
		iii. Maintaining the 4-hour rolling averages within the operating limitations for the operating parameters established during the performance test.
6. Non-emergency 4SRB stationary RICE with a brake HP \geq 5,000 located at a major source of HAP	a. Reduce formaldehyde emissions	Conducting semiannual performance tests for formaldehyde to demonstrate that the required formaldehyde percent reduction is achieved, or to demonstrate that the average reduction of emissions of THC determined from the performance test is equal to or greater than 30 percent. ^a
7. New or reconstructed non-emergency stationary RICE >500 HP located at a major source of HAP and new or reconstructed non-emergency 4SLB stationary RICE $250 \leq$ HP \leq 500 located at a major source of HAP	a. Limit the concentration of formaldehyde in the stationary RICE exhaust and using	i. Conducting semiannual performance tests for formaldehyde to demonstrate that your emissions remain at or below the formaldehyde

	oxidation catalyst or NSCR	concentration limit ^a ; and ii. Collecting the catalyst inlet temperature data according to § 63.6625(b); and
		iii. Reducing these data to 4-hour rolling averages; and
		iv. Maintaining the 4-hour rolling averages within the operating limitations for the catalyst inlet temperature; and
		v. Measuring the pressure drop across the catalyst once per month and demonstrating that the pressure drop across the catalyst is within the operating limitation established during the performance test.
8. New or reconstructed non-emergency stationary RICE >500 HP located at a major source of HAP and new or reconstructed non-emergency 4SLB stationary RICE 250≤HP≤500 located at a major source of HAP	a. Limit the concentration of formaldehyde in the stationary RICE exhaust and not using oxidation catalyst or NSCR	i. Conducting semiannual performance tests for formaldehyde to demonstrate that your emissions remain at or below the formaldehyde concentration limit ^a ; and ii. Collecting the approved operating parameter (if any) data according to § 63.6625(b); and
		iii. Reducing these data to 4-hour rolling averages; and
		iv. Maintaining the 4-hour rolling averages within the operating limitations for the operating parameters established during the performance test.
9. Existing emergency and black start stationary RICE ≤500 HP located at a major source of HAP, existing non-emergency stationary RICE <100 HP located at a major source of HAP, existing emergency and black start stationary RICE located at an area source of HAP, existing non-emergency stationary CI RICE ≤300 HP located at an area source of HAP, existing non-emergency 2SLB stationary RICE located at an area source of HAP, existing non-emergency stationary SI RICE located at an area source of HAP which combusts landfill or digester gas equivalent to 10 percent or more of the gross heat input on an annual basis, existing non-emergency 4SLB and 4SRB stationary RICE ≤500 HP located at an area	a. Work or Management practices	i. Operating and maintaining the stationary RICE according to the manufacturer's emission-related operation and maintenance instructions; or ii. Develop and follow your own maintenance plan which must provide to the extent practicable for the maintenance and operation of the engine in a manner consistent with good air

<p>source of HAP, existing non-emergency 4SLB and 4SRB stationary RICE >500 HP located at an area source of HAP that operate 24 hours or less per calendar year, and existing non-emergency 4SLB and 4SRB stationary RICE >500 HP located at an area source of HAP that are remote stationary RICE</p>		<p>pollution control practice for minimizing emissions.</p>
<p>10. Existing stationary CI RICE >500 HP that are not limited use stationary RICE</p>	<p>a. Reduce CO emissions, or limit the concentration of CO in the stationary RICE exhaust, and using oxidation catalyst</p>	<p>i. Conducting performance tests every 8,760 hours or 3 years, whichever comes first, for CO or formaldehyde, as appropriate, to demonstrate that the required CO or formaldehyde, as appropriate, percent reduction is achieved or that your emissions remain at or below the CO or formaldehyde concentration limit; and</p>
		<p>ii. Collecting the catalyst inlet temperature data according to § 63.6625(b); and</p>
		<p>iii. Reducing these data to 4-hour rolling averages; and</p>
		<p>iv. Maintaining the 4-hour rolling averages within the operating limitations for the catalyst inlet temperature; and</p>
		<p>v. Measuring the pressure drop across the catalyst once per month and demonstrating that the pressure drop across the catalyst is within the operating limitation established during the performance test.</p>
<p>11. Existing stationary CI RICE >500 HP that are not limited use stationary RICE</p>	<p>a. Reduce CO emissions, or limit the concentration of CO in the stationary RICE exhaust, and not using oxidation catalyst</p>	<p>i. Conducting performance tests every 8,760 hours or 3 years, whichever comes first, for CO or formaldehyde, as appropriate, to demonstrate that the required CO or formaldehyde, as appropriate, percent reduction is achieved or that your emissions remain at or below the CO or</p>

		formaldehyde concentration limit; and
		ii. Collecting the approved operating parameter (if any) data according to § 63.6625(b); and
		iii. Reducing these data to 4-hour rolling averages; and
		iv. Maintaining the 4-hour rolling averages within the operating limitations for the operating parameters established during the performance test.
12. Existing limited use CI stationary RICE >500 HP	a. Reduce CO emissions or limit the concentration of CO in the stationary RICE exhaust, and using an oxidation catalyst	i. Conducting performance tests every 8,760 hours or 5 years, whichever comes first, for CO or formaldehyde, as appropriate, to demonstrate that the required CO or formaldehyde, as appropriate, percent reduction is achieved or that your emissions remain at or below the CO or formaldehyde concentration limit; and
		ii. Collecting the catalyst inlet temperature data according to § 63.6625(b); and
		iii. Reducing these data to 4-hour rolling averages; and
		iv. Maintaining the 4-hour rolling averages within the operating limitations for the catalyst inlet temperature; and
		v. Measuring the pressure drop across the catalyst once per month and demonstrating that the pressure drop across the catalyst is within the operating limitation established during the performance test.
13. Existing limited use CI stationary RICE >500 HP	a. Reduce CO emissions or limit the concentration of CO in the stationary RICE	i. Conducting performance tests every 8,760 hours or 5 years, whichever comes first, for CO or formaldehyde, as

	exhaust, and not using an oxidation catalyst	appropriate, to demonstrate that the required CO or formaldehyde, as appropriate, percent reduction is achieved or that your emissions remain at or below the CO or formaldehyde concentration limit; and
		ii. Collecting the approved operating parameter (if any) data according to § 63.6625(b); and
		iii. Reducing these data to 4-hour rolling averages; and
		iv. Maintaining the 4-hour rolling averages within the operating limitations for the operating parameters established during the performance test.
14. Existing non-emergency 4SLB stationary RICE >500 HP located at an area source of HAP that are not remote stationary RICE and that are operated more than 24 hours per calendar year	a. Install an oxidation catalyst	<p>i. Conducting annual compliance demonstrations as specified in § 63.6640 (c) to show that the average reduction of emissions of CO is 93 percent or more, or the average CO concentration is less than or equal to 47 ppmvd at 15 percent O₂; and either</p> <p>ii. Collecting the catalyst inlet temperature data according to § 63.6625(b), reducing these data to 4-hour rolling averages; and maintaining the 4-hour rolling averages within the limitation of greater than 450 °F and less than or equal to 1350 °F for the catalyst inlet temperature; or</p> <p>iii. Immediately shutting down the engine if the catalyst inlet temperature exceeds 1350 °F.</p>
15. Existing non-emergency 4SRB stationary RICE >500 HP located at an area source of HAP that are not remote stationary RICE and that are operated more than 24 hours per calendar year	a. Install NSCR	i. Conducting annual compliance demonstrations as specified in § 63.6640 (c) to show that the average reduction of emissions of CO is 75 percent or more, the

	average CO concentration is less than or equal to 270 ppmvd at 15 percent O ₂ or the average reduction of emissions of THC is 30 percent or more; and either ii. Collecting the catalyst inlet temperature data according to § 63.6625(b), reducing these data to 4-hour rolling averages; and maintaining the 4-hour rolling averages within the limitation of greater than or equal to 750 °F and less than or equal to 1250 °F for the catalyst inlet temperature; or iii. Immediately shutting down the engine if the catalyst inlet temperature exceeds 1250 °F.
--	--

^a After you have demonstrated compliance for two consecutive tests, you may reduce the frequency of subsequent performance tests to annually. If the results of any subsequent annual performance test indicate the stationary RICE is not in compliance with the CO or formaldehyde emission limitation, or you deviate from any of your operating limitations, you must resume semiannual performance tests.

[78 FR 6715, Jan. 30, 2013]

Table 7 to Subpart ZZZZ of Part 63—Requirements for Reports

As stated in § 63.6650, you must comply with the following requirements for reports:

For each . . .	You must submit a . . .	The report must contain . . .	You must submit the report . . .
1. Existing non-emergency, non-black start stationary RICE 100≤HP≤500 located at a major source of HAP; existing non-emergency, non-black start stationary CI RICE >500 HP located at a major source of HAP; existing non-emergency 4SRB stationary RICE >500 HP located at a major source of HAP; existing non-emergency, non-black start stationary CI RICE >300 HP located at an area source of HAP; new or reconstructed non-emergency stationary RICE >500 HP located at a major source of HAP; and new or reconstructed non-emergency 4SLB stationary RICE 250≤HP≤500 located at a major source of HAP	Compliance report	a. If there are no deviations from any emission limitations or operating limitations that apply to you, a statement that there were no deviations from the emission limitations or operating limitations during the reporting period. If there were no periods during which the CMS, including CEMS and CPMS, was out-of-control, as specified in § 63.8(c)(7), a statement that there were not periods during which the CMS was out-of-control during the reporting period; or	i. Semiannually according to the requirements in § 63.6650(b)(1)-(5) for engines that are not limited use stationary RICE subject to numerical emission limitations; and ii. Annually according to the requirements in § 63.6650(b)(6)-(9) for engines that are limited use stationary RICE subject to

			numerical emission limitations.
		b. If you had a deviation from any emission limitation or operating limitation during the reporting period, the information in § 63.6650(d). If there were periods during which the CMS, including CEMS and CPMS, was out-of-control, as specified in § 63.8(c)(7), the information in § 63.6650(e); or	i. Semiannually according to the requirements in § 63.6650(b).
		c. If you had a malfunction during the reporting period, the information in § 63.6650(c)(4).	i. Semiannually according to the requirements in § 63.6650(b).
2. New or reconstructed non-emergency stationary RICE that combusts landfill gas or digester gas equivalent to 10 percent or more of the gross heat input on an annual basis	Report	a. The fuel flow rate of each fuel and the heating values that were used in your calculations, and you must demonstrate that the percentage of heat input provided by landfill gas or digester gas, is equivalent to 10 percent or more of the gross heat input on an annual basis; and	i. Annually, according to the requirements in § 63.6650.
		b. The operating limits provided in your federally enforceable permit, and any deviations from these limits; and	i. See item 2.a.i.
		c. Any problems or errors suspected with the meters.	i. See item 2.a.i.
3. Existing non-emergency, non-black start 4SLB and 4SRB stationary RICE >500 HP located at an area source of HAP that are not remote stationary RICE and that operate more than 24 hours per calendar year	Compliance report	a. The results of the annual compliance demonstration, if conducted during the reporting period.	i. Semiannually according to the requirements in § 63.6650(b)(1)-(5).
4. Emergency stationary RICE that operate or are contractually obligated to be available for more than 15 hours per year for the purposes specified in § 63.6640(f)(2)(ii) and (iii) or that operate for the purposes specified in § 63.6640(f)(4)(ii)	Report	a. The information in § 63.6650(h)(1)	i. annually according to the requirements in § 63.6650(h)(2)-(3).

[78 FR 6719, Jan. 30, 2013]

Table 8 to Subpart ZZZZ of Part 63—Applicability of General Provisions to Subpart ZZZZ.

As stated in § 63.6665, you must comply with the following applicable general provisions.

General provisions citation	Subject of citation	Applies to subpart	Explanation
§ 63.1	General applicability of the General Provisions	Yes.	
§ 63.2	Definitions	Yes	Additional terms defined in § 63.6675.
§ 63.3	Units and abbreviations	Yes.	
§ 63.4	Prohibited activities and circumvention	Yes.	
§ 63.5	Construction and reconstruction	Yes.	
§ 63.6(a)	Applicability	Yes.	
§ 63.6(b)(1)-(4)	Compliance dates for new and reconstructed sources	Yes.	
§ 63.6(b)(5)	Notification	Yes.	
§ 63.6(b)(6)	[Reserved]		
§ 63.6(b)(7)	Compliance dates for new and reconstructed area sources that become major sources	Yes.	
§ 63.6(c)(1)-(2)	Compliance dates for existing sources	Yes.	
§ 63.6(c)(3)-(4)	[Reserved]		
§ 63.6(c)(5)	Compliance dates for existing area sources that become major sources	Yes.	
§ 63.6(d)	[Reserved]		
§ 63.6(e)	Operation and maintenance	No.	
§ 63.6(f)(1)	Applicability of standards	No.	
§ 63.6(f)(2)	Methods for determining compliance	Yes.	
§ 63.6(f)(3)	Finding of compliance	Yes.	
§ 63.6(g)(1)-(3)	Use of alternate standard	Yes.	
§ 63.6(h)	Opacity and visible emission standards	No	Subpart ZZZZ does not contain opacity or visible emission standards.
§ 63.6(i)	Compliance extension procedures and criteria	Yes.	
§ 63.6(j)	Presidential compliance exemption	Yes.	
§ 63.7(a)(1)-(2)	Performance test dates	Yes	Subpart ZZZZ contains performance test dates at §§ 63.6610, 63.6611, and 63.6612.
§ 63.7(a)(3)	CAA section 114 authority	Yes.	
§ 63.7(b)(1)	Notification of performance test	Yes	Except that § 63.7(b)(1) only applies as specified in § 63.6645.
§ 63.7(b)(2)	Notification of rescheduling	Yes	Except that § 63.7(b)(2) only applies as specified in § 63.6645.
§ 63.7(c)	Quality assurance/test plan	Yes	Except that § 63.7(c) only applies as specified in § 63.6645.

§ 63.7(d)	Testing facilities	Yes.	
§ 63.7(e)(1)	Conditions for conducting performance tests	No.	Subpart ZZZZ specifies conditions for conducting performance tests at § 63.6620.
§ 63.7(e)(2)	Conduct of performance tests and reduction of data	Yes	Subpart ZZZZ specifies test methods at § 63.6620.
§ 63.7(e)(3)	Test run duration	Yes.	
§ 63.7(e)(4)	Administrator may require other testing under section 114 of the CAA	Yes.	
§ 63.7(f)	Alternative test method provisions	Yes.	
§ 63.7(g)	Performance test data analysis, recordkeeping, and reporting	Yes.	
§ 63.7(h)	Waiver of tests	Yes.	
§ 63.8(a)(1)	Applicability of monitoring requirements	Yes	Subpart ZZZZ contains specific requirements for monitoring at § 63.6625.
§ 63.8(a)(2)	Performance specifications	Yes.	
§ 63.8(a)(3)	[Reserved]		
§ 63.8(a)(4)	Monitoring for control devices	No.	
§ 63.8(b)(1)	Monitoring	Yes.	
§ 63.8(b)(2)-(3)	Multiple effluents and multiple monitoring systems	Yes.	
§ 63.8(c)(1)	Monitoring system operation and maintenance	Yes.	
§ 63.8(c)(1)(i)	Routine and predictable SSM	No	
§ 63.8(c)(1)(ii)	SSM not in Startup Shutdown Malfunction Plan	Yes.	
§ 63.8(c)(1)(iii)	Compliance with operation and maintenance requirements	No	
§ 63.8(c)(2)-(3)	Monitoring system installation	Yes.	
§ 63.8(c)(4)	Continuous monitoring system (CMS) requirements	Yes	Except that subpart ZZZZ does not require Continuous Opacity Monitoring System (COMS).
§ 63.8(c)(5)	COMS minimum procedures	No	Subpart ZZZZ does not require COMS.
§ 63.8(c)(6)-(8)	CMS requirements	Yes	Except that subpart ZZZZ does not require COMS.
§ 63.8(d)	CMS quality control	Yes.	
§ 63.8(e)	CMS performance evaluation	Yes	Except for § 63.8(e)(5)(ii), which applies to COMS.
		Except that § 63.8(e) only applies as specified in § 63.6645.	
§ 63.8(f)(1)-(5)	Alternative monitoring method	Yes	Except that § 63.8(f)(4) only applies as specified in § 63.6645.
§ 63.8(f)(6)	Alternative to relative accuracy test	Yes	Except that § 63.8(f)(6) only applies as specified in § 63.6645.

§ 63.8(g)	Data reduction	Yes	Except that provisions for COMS are not applicable. Averaging periods for demonstrating compliance are specified at §§ 63.6635 and 63.6640.
§ 63.9(a)	Applicability and State delegation of notification requirements	Yes.	
§ 63.9(b)(1)-(5)	Initial notifications	Yes	Except that § 63.9(b)(3) is reserved.
		Except that § 63.9(b) only applies as specified in § 63.6645.	
§ 63.9(c)	Request for compliance extension	Yes	Except that § 63.9(c) only applies as specified in § 63.6645.
§ 63.9(d)	Notification of special compliance requirements for new sources	Yes	Except that § 63.9(d) only applies as specified in § 63.6645.
§ 63.9(e)	Notification of performance test	Yes	Except that § 63.9(e) only applies as specified in § 63.6645.
§ 63.9(f)	Notification of visible emission (VE)/opacity test	No	Subpart ZZZZ does not contain opacity or VE standards.
§ 63.9(g)(1)	Notification of performance evaluation	Yes	Except that § 63.9(g) only applies as specified in § 63.6645.
§ 63.9(g)(2)	Notification of use of COMS data	No	Subpart ZZZZ does not contain opacity or VE standards.
§ 63.9(g)(3)	Notification that criterion for alternative to RATA is exceeded	Yes	If alternative is in use.
		Except that § 63.9(g) only applies as specified in § 63.6645.	
§ 63.9(h)(1)-(6)	Notification of compliance status	Yes	Except that notifications for sources using a CEMS are due 30 days after completion of performance evaluations. § 63.9(h)(4) is reserved.
			Except that § 63.9(h) only applies as specified in § 63.6645.
§ 63.9(i)	Adjustment of submittal deadlines	Yes.	
§ 63.9(j)	Change in previous information	Yes.	
§ 63.10(a)	Administrative provisions for recordkeeping/reporting	Yes.	
§ 63.10(b)(1)	Record retention	Yes	Except that the most recent 2 years of data do not have to be retained on site.
§ 63.10(b)(2)(i)-(v)	Records related to SSM	No.	
§ 63.10(b)(2)(vi)-(xi)	Records	Yes.	
	Record when under waiver	Yes.	

§ 63.10(b)(2)(xii)			
§ 63.10(b)(2)(xiii)	Records when using alternative to RATA	Yes	For CO standard if using RATA alternative.
§ 63.10(b)(2)(xiv)	Records of supporting documentation	Yes.	
§ 63.10(b)(3)	Records of applicability determination	Yes.	
§ 63.10(c)	Additional records for sources using CEMS	Yes	Except that § 63.10(c)(2)-(4) and (9) are reserved.
§ 63.10(d)(1)	General reporting requirements	Yes.	
§ 63.10(d)(2)	Report of performance test results	Yes.	
§ 63.10(d)(3)	Reporting opacity or VE observations	No	Subpart ZZZZ does not contain opacity or VE standards.
§ 63.10(d)(4)	Progress reports	Yes.	
§ 63.10(d)(5)	Startup, shutdown, and malfunction reports	No.	
§ 63.10(e)(1) and (2)(i)	Additional CMS Reports	Yes.	
§ 63.10(e)(2)(ii)	COMS-related report	No	Subpart ZZZZ does not require COMS.
§ 63.10(e)(3)	Excess emission and parameter exceedances reports	Yes.	Except that § 63.10(e)(3)(i) (C) is reserved.
§ 63.10(e)(4)	Reporting COMS data	No	Subpart ZZZZ does not require COMS.
§ 63.10(f)	Waiver for recordkeeping/reporting	Yes.	
§ 63.11	Flares	No.	
§ 63.12	State authority and delegations	Yes.	
§ 63.13	Addresses	Yes.	
§ 63.14	Incorporation by reference	Yes.	
§ 63.15	Availability of information	Yes.	

[75 FR 9688, Mar. 3, 2010, as amended at 78 FR 6720, Jan. 30, 2013]

Appendix A—Protocol for Using an Electrochemical Analyzer to Determine Oxygen and Carbon Monoxide Concentrations From Certain Engines

1.0 SCOPE AND APPLICATION. WHAT IS THIS PROTOCOL?

This protocol is a procedure for using portable electrochemical (EC) cells for measuring carbon monoxide (CO) and oxygen (O₂) concentrations in controlled and uncontrolled emissions from existing stationary 4-stroke lean burn and 4-stroke rich burn reciprocating internal combustion engines as specified in the applicable rule.

1.1 Analytes. What does this protocol determine?

This protocol measures the engine exhaust gas concentrations of carbon monoxide (CO) and oxygen (O₂).

Analyte	CAS No.	Sensitivity

Carbon monoxide (CO)	630-08-0	Minimum detectable limit should be 2 percent of the nominal range or 1 ppm, whichever is less restrictive.
Oxygen (O ₂)	7782-44-7	

1.2 Applicability. When is this protocol acceptable?

This protocol is applicable to 40 CFR part 63, subpart ZZZZ. Because of inherent cross sensitivities of EC cells, you must not apply this protocol to other emissions sources without specific instruction to that effect.

1.3 Data Quality Objectives. How good must my collected data be?

Refer to Section 13 to verify and document acceptable analyzer performance.

1.4 Range. What is the targeted analytical range for this protocol?

The measurement system and EC cell design(s) conforming to this protocol will determine the analytical range for each gas component. The nominal ranges are defined by choosing up-scale calibration gas concentrations near the maximum anticipated flue gas concentrations for CO and O₂, or no more than twice the permitted CO level.

1.5 Sensitivity. What minimum detectable limit will this protocol yield for a particular gas component?

The minimum detectable limit depends on the nominal range and resolution of the specific EC cell used, and the signal to noise ratio of the measurement system. The minimum detectable limit should be 2 percent of the nominal range or 1 ppm, whichever is less restrictive.

2.0 SUMMARY OF PROTOCOL

In this protocol, a gas sample is extracted from an engine exhaust system and then conveyed to a portable EC analyzer for measurement of CO and O₂ gas concentrations. This method provides measurement system performance specifications and sampling protocols to ensure reliable data. You may use additions to, or modifications of vendor supplied measurement systems (e.g., heated or unheated sample lines, thermocouples, flow meters, selective gas scrubbers, etc.) to meet the design specifications of this protocol. Do not make changes to the measurement system from the as-verified configuration (Section 3.12).

3.0 DEFINITIONS

3.1 Measurement System. The total equipment required for the measurement of CO and O₂ concentrations. The measurement system consists of the following major subsystems:

3.1.1 Data Recorder. A strip chart recorder, computer or digital recorder for logging measurement data from the analyzer output. You may record measurement data from the digital data display manually or electronically.

3.1.2 Electrochemical (EC) Cell. A device, similar to a fuel cell, used to sense the presence of a specific analyte and generate an electrical current output proportional to the analyte concentration.

3.1.3 Interference Gas Scrubber. A device used to remove or neutralize chemical compounds that may interfere with the selective operation of an EC cell.

3.1.4 Moisture Removal System. Any device used to reduce the concentration of moisture in the sample stream so as to protect the EC cells from the damaging effects of condensation and to minimize errors in measurements caused by the scrubbing of soluble gases.

3.1.5 Sample Interface. The portion of the system used for one or more of the following: sample acquisition; sample transport; sample conditioning or protection of the EC cell from any degrading effects of the engine exhaust effluent; removal of particulate matter and condensed moisture.

3.2 Nominal Range. The range of analyte concentrations over which each EC cell is operated (normally 25 percent to 150 percent of up-scale calibration gas value). Several nominal ranges can be used for any given cell so long as the calibration and repeatability checks for that range remain within specifications.

3.3 Calibration Gas. A vendor certified concentration of a specific analyte in an appropriate balance gas.

3.4 Zero Calibration Error. The analyte concentration output exhibited by the EC cell in response to zero-level calibration gas.

3.5 Up-Scale Calibration Error. The mean of the difference between the analyte concentration exhibited by the EC cell and the certified concentration of the up-scale calibration gas.

3.6 Interference Check. A procedure for quantifying analytical interference from components in the engine exhaust gas other than the targeted analytes.

3.7 Repeatability Check. A protocol for demonstrating that an EC cell operated over a given nominal analyte concentration range provides a stable and consistent response and is not significantly affected by repeated exposure to that gas.

3.8 Sample Flow Rate. The flow rate of the gas sample as it passes through the EC cell. In some situations, EC cells can experience drift with changes in flow rate. The flow rate must be monitored and documented during all phases of a sampling run.

3.9 Sampling Run. A timed three-phase event whereby an EC cell's response rises and plateaus in a sample conditioning phase, remains relatively constant during a measurement data phase, then declines during a refresh phase. The sample conditioning phase exposes the EC cell to the gas sample for a length of time sufficient to reach a constant response. The measurement data phase is the time interval during which gas sample measurements can be made that meet the acceptance criteria of this protocol. The refresh phase then purges the EC cells with CO-free air. The refresh phase replenishes requisite O₂ and moisture in the electrolyte reserve and provides a mechanism to de-gas or desorb any interference gas scrubbers or filters so as to enable a stable CO EC cell response. There are four primary types of sampling runs: pre-sampling calibrations; stack gas sampling; post-sampling calibration checks; and measurement system repeatability checks. Stack gas sampling runs can be chained together for extended evaluations, providing all other procedural specifications are met.

3.10 Sampling Day. A time not to exceed twelve hours from the time of the pre-sampling calibration to the post-sampling calibration check. During this time, stack gas sampling runs can be repeated without repeated recalibrations, providing all other sampling specifications have been met.

3.11 Pre-Sampling Calibration/Post-Sampling Calibration Check. The protocols executed at the beginning and end of each sampling day to bracket measurement readings with controlled performance checks.

3.12 Performance-Established Configuration. The EC cell and sampling system configuration that existed at the time that it initially met the performance requirements of this protocol.

4.0 INTERFERENCES.

When present in sufficient concentrations, NO and NO₂ are two gas species that have been reported to interfere with CO concentration measurements. In the likelihood of this occurrence, it is the protocol user's responsibility to employ and properly maintain an appropriate CO EC cell filter or scrubber for removal of these gases, as described in Section 6.2.12.

5.0 SAFETY. [RESERVED]

6.0 EQUIPMENT AND SUPPLIES.

6.1 What equipment do I need for the measurement system?

The system must maintain the gas sample at conditions that will prevent moisture condensation in the sample transport lines, both before and as the sample gas contacts the EC cells. The essential components of the measurement system are described below.

6.2 Measurement System Components.

6.2.1 Sample Probe. A single extraction-point probe constructed of glass, stainless steel or other non-reactive material, and of length sufficient to reach any designated sampling point. The sample probe must be designed to prevent plugging due to condensation or particulate matter.

6.2.2 Sample Line. Non-reactive tubing to transport the effluent from the sample probe to the EC cell.

6.2.3 Calibration Assembly (optional). A three-way valve assembly or equivalent to introduce calibration gases at ambient pressure at the exit end of the sample probe during calibration checks. The assembly must be designed such that only stack gas or calibration gas flows in the sample line and all gases flow through any gas path filters.

6.2.4 Particulate Filter (optional). Filters before the inlet of the EC cell to prevent accumulation of particulate material in the measurement system and extend the useful life of the components. All filters must be fabricated of materials that are non-reactive to the gas mixtures being sampled.

6.2.5 Sample Pump. A leak-free pump to provide undiluted sample gas to the system at a flow rate sufficient to minimize the response time of the measurement system. If located upstream of the EC cells, the pump must be constructed of a material that is non-reactive to the gas mixtures being sampled.

6.2.8 Sample Flow Rate Monitoring. An adjustable rotameter or equivalent device used to adjust and maintain the sample flow rate through the analyzer as prescribed.

6.2.9 Sample Gas Manifold (optional). A manifold to divert a portion of the sample gas stream to the analyzer and the remainder to a by-pass discharge vent. The sample gas manifold may also include provisions for introducing calibration gases directly to the analyzer. The manifold must be constructed of a material that is non-reactive to the gas mixtures being sampled.

6.2.10 EC cell. A device containing one or more EC cells to determine the CO and O₂ concentrations in the sample gas stream. The EC cell(s) must meet the applicable performance specifications of Section 13 of this protocol.

6.2.11 Data Recorder. A strip chart recorder, computer or digital recorder to make a record of analyzer output data. The data recorder resolution (i.e., readability) must be no greater than 1 ppm for CO; 0.1 percent for O₂; and one degree (either °C or °F) for temperature. Alternatively, you may use a digital or analog meter having the same resolution to observe and manually record the analyzer responses.

6.2.12 Interference Gas Filter or Scrubber. A device to remove interfering compounds upstream of the CO EC cell. Specific interference gas filters or scrubbers used in the performance-established configuration of the analyzer must continue to be used. Such a filter or scrubber must have a means to determine when the removal agent is exhausted. Periodically replace or replenish it in accordance with the manufacturer's recommendations.

7.0 REAGENTS AND STANDARDS. WHAT CALIBRATION GASES ARE NEEDED?

7.1 Calibration Gases. CO calibration gases for the EC cell must be CO in nitrogen or CO in a mixture of nitrogen and O₂. Use CO calibration gases with labeled concentration values certified by the manufacturer to be within ± 5 percent of the label value. Dry ambient air (20.9 percent O₂) is acceptable for calibration of the O₂ cell. If needed, any lower percentage O₂ calibration gas must be a mixture of O₂ in nitrogen.

7.1.1 Up-Scale CO Calibration Gas Concentration. Choose one or more up-scale gas concentrations such that the average of the stack gas measurements for each stack gas sampling run are between 25 and 150 percent of those concentrations. Alternatively, choose an up-scale gas that does not exceed twice the concentration of the applicable outlet standard. If a measured gas value exceeds 150 percent of the up-scale CO calibration gas value at any time during the stack gas sampling run, the run must be discarded and repeated.

7.1.2 Up-Scale O₂ Calibration Gas Concentration.

Select an O₂ gas concentration such that the difference between the gas concentration and the average stack gas measurement or reading for each sample run is less than 15 percent O₂. When the average exhaust gas O₂ readings are above 6 percent, you may use dry ambient air (20.9 percent O₂) for the up-scale O₂ calibration gas.

7.1.3 Zero Gas. Use an inert gas that contains less than 0.25 percent of the up-scale CO calibration gas concentration. You may use dry air that is free from ambient CO and other combustion gas products (e.g., CO₂).

8.0 SAMPLE COLLECTION AND ANALYSIS

8.1 Selection of Sampling Sites.

8.1.1 Control Device Inlet. Select a sampling site sufficiently downstream of the engine so that the combustion gases should be well mixed. Use a single sampling extraction point near the center of the duct (e.g., within the 10 percent centroidal area), unless instructed otherwise.

8.1.2 Exhaust Gas Outlet. Select a sampling site located at least two stack diameters downstream of any disturbance (e.g., turbocharger exhaust, crossover junction or recirculation take-off) and at least one-half stack diameter upstream of the gas discharge to the atmosphere. Use a single sampling extraction point near the center of the duct (e.g., within the 10 percent centroidal area), unless instructed otherwise.

8.2 Stack Gas Collection and Analysis. Prior to the first stack gas sampling run, conduct that the pre-sampling calibration in accordance with Section 10.1. Use Figure 1 to record all data. Zero the analyzer with zero gas. Confirm and record that the scrubber media color is correct and not exhausted. Then position the probe at the sampling point and begin the sampling run at the same flow rate used during the up-scale calibration. Record the start time. Record all EC cell output responses and the flow rate during the "sample conditioning phase" once per minute until constant readings are obtained. Then begin the "measurement data phase" and record readings every 15 seconds for at least two minutes (or eight readings), or as otherwise required to achieve two continuous minutes of data that meet the specification given in Section 13.1. Finally, perform the "refresh phase" by introducing dry air, free from CO and other combustion gases, until several minute-to-minute readings of consistent value have been obtained. For each run use the "measurement data phase" readings to calculate the average stack gas CO and O₂ concentrations.

8.3 EC Cell Rate. Maintain the EC cell sample flow rate so that it does not vary by more than ± 10 percent throughout the pre-sampling calibration, stack gas sampling and post-sampling calibration check. Alternatively, the EC cell sample flow rate can be maintained within a tolerance range that does not affect the gas concentration readings by more than ± 3 percent, as instructed by the EC cell manufacturer.

9.0 QUALITY CONTROL (RESERVED)

10.0 CALIBRATION AND STANDARDIZATION

10.1 Pre-Sampling Calibration. Conduct the following protocol once for each nominal range to be used on each EC cell before performing a stack gas sampling run on each field sampling day. Repeat the calibration if you replace an EC cell before completing all of the sampling runs. There is no prescribed order for calibration of the EC cells; however, each cell must complete the measurement data phase during calibration. Assemble the measurement system by following the manufacturer's recommended protocols including for preparing and preconditioning the EC cell. Assure the measurement system has no leaks and verify the gas scrubbing agent is not depleted. Use Figure 1 to record all data.

10.1.1 Zero Calibration. For both the O₂ and CO cells, introduce zero gas to the measurement system (e.g., at the calibration assembly) and record the concentration reading every minute until readings are constant for at least two consecutive minutes. Include the time and sample flow rate. Repeat the steps in this section at least once to verify the zero calibration for each component gas.

10.1.2 Zero Calibration Tolerance. For each zero gas introduction, the zero level output must be less than or equal to ± 3 percent of the up-scale gas value or ± 1 ppm, whichever is less restrictive, for the CO channel and less than or equal to ± 0.3 percent O₂ for the O₂ channel.

10.1.3 Up-Scale Calibration. Individually introduce each calibration gas to the measurement system (e.g., at the calibration assembly) and record the start time. Record all EC cell output responses and the flow rate during this "sample conditioning phase" once per minute until readings are constant for at least two minutes. Then begin the "measurement data phase" and record readings every 15 seconds for a total of two minutes, or as otherwise required. Finally, perform the "refresh phase" by introducing dry air, free from CO and other combustion gases, until readings are constant for at least two consecutive minutes. Then repeat the steps in this section at least once to verify the calibration for each component gas. Introduce all gases to flow through the entire sample handling system (i.e., at the exit end of the sampling probe or the calibration assembly).

10.1.4 Up-Scale Calibration Error. The mean of the difference of the "measurement data phase" readings from the reported standard gas value must be less than or equal to ± 5 percent or ± 1 ppm for CO or ± 0.5 percent O₂, whichever is less restrictive, respectively. The maximum allowable deviation from the mean measured value of any single "measurement data phase" reading must be less than or equal to ± 2 percent or ± 1 ppm for CO or ± 0.5 percent O₂, whichever is less restrictive, respectively.

10.2 Post-Sampling Calibration Check. Conduct a stack gas post-sampling calibration check after the stack gas sampling run or set of runs and within 12 hours of the initial calibration. Conduct up-scale and zero calibration checks using the protocol in Section 10.1. Make no changes to the sampling system or EC cell calibration until all post-sampling calibration checks have been recorded. If either the zero or up-scale calibration error exceeds the respective specification in Sections 10.1.2 and 10.1.4 then all measurement data collected since the previous successful calibrations are invalid and re-calibration and re-sampling are required. If the sampling system is disassembled or the EC cell calibration is adjusted, repeat the calibration check before conducting the next analyzer sampling run.

11.0 ANALYTICAL PROCEDURE

The analytical procedure is fully discussed in Section 8.

12.0 CALCULATIONS AND DATA ANALYSIS

Determine the CO and O₂ concentrations for each stack gas sampling run by calculating the mean gas concentrations of the data recorded during the "measurement data phase".

13.0 PROTOCOL PERFORMANCE

Use the following protocols to verify consistent analyzer performance during each field sampling day.

13.1 Measurement Data Phase Performance Check. Calculate the mean of the readings from the “measurement data phase”. The maximum allowable deviation from the mean for each of the individual readings is ± 2 percent, or ± 1 ppm, whichever is less restrictive. Record the mean value and maximum deviation for each gas monitored. Data must conform to Section 10.1.4. The EC cell flow rate must conform to the specification in Section 8.3.

Example: A measurement data phase is invalid if the maximum deviation of any single reading comprising that mean is greater than ± 2 percent or ± 1 ppm (the default criteria). For example, if the mean = 30 ppm, single readings of below 29 ppm and above 31 ppm are disallowed .

13.2 Interference Check. Before the initial use of the EC cell and interference gas scrubber in the field, and semi-annually thereafter, challenge the interference gas scrubber with NO and NO₂ gas standards that are generally recognized as representative of diesel-fueled engine NO and NO₂ emission values. Record the responses displayed by the CO EC cell and other pertinent data on Figure 1 or a similar form.

13.2.1 Interference Response. The combined NO and NO₂ interference response should be less than or equal to ± 5 percent of the up-scale CO calibration gas concentration.

13.3 Repeatability Check. Conduct the following check once for each nominal range that is to be used on the CO EC cell within 5 days prior to each field sampling program. If a field sampling program lasts longer than 5 days, repeat this check every 5 days. Immediately repeat the check if the EC cell is replaced or if the EC cell is exposed to gas concentrations greater than 150 percent of the highest up-scale gas concentration.

13.3.1 Repeatability Check Procedure. Perform a complete EC cell sampling run (all three phases) by introducing the CO calibration gas to the measurement system and record the response. Follow Section 10.1.3. Use Figure 1 to record all data. Repeat the run three times for a total of four complete runs. During the four repeatability check runs, do not adjust the system except where necessary to achieve the correct calibration gas flow rate at the analyzer.

13.3.2 Repeatability Check Calculations. Determine the highest and lowest average “measurement data phase” CO concentrations from the four repeatability check runs and record the results on Figure 1 or a similar form. The absolute value of the difference between the maximum and minimum average values recorded must not vary more than ± 3 percent or ± 1 ppm of the up-scale gas value, whichever is less restrictive.

14.0 POLLUTION PREVENTION (RESERVED)

15.0 WASTE MANAGEMENT (RESERVED)

16.0 ALTERNATIVE PROCEDURES (RESERVED)

17.0 REFERENCES

(1) “Development of an Electrochemical Cell Emission Analyzer Test Protocol”, Topical Report, Phil Juneau, Emission Monitoring, Inc., July 1997.

(2) “Determination of Nitrogen Oxides, Carbon Monoxide, and Oxygen Emissions from Natural Gas-Fired Engines, Boilers, and Process Heaters Using Portable Analyzers”, EMC Conditional Test Protocol 30 (CTM-30), Gas Research Institute Protocol GRI-96/0008, Revision 7, October 13, 1997.

(3) “ICAC Test Protocol for Periodic Monitoring”, EMC Conditional Test Protocol 34 (CTM-034), The Institute of Clean Air Companies, September 8, 1999.

(4) “Code of Federal Regulations”, Protection of Environment, 40 CFR, Part 60, Appendix A, Methods 1-4; 10.

TABLE 1: APPENDIX A—SAMPLING RUN DATA.

Facility _____		Engine I.D. _____				Date _____					
Run Type:	()	()	()	()	()	()	()	()	()	()	()
(X)	Pre-Sample Calibration	Stack Gas Sample				Post-Sample Cal. Check		Repeatability Check			
Run #	1	1	2	2	3	3	4	4	Time	Scrub. OK	Flow- Rate
Gas	O ₂	CO	O ₂	CO	O ₂	CO	O ₂	CO			
Sample Cond. Phase											
"											
"											
"											
"											
Measurement Data Phase											
"											
"											
"											
"											
"											
"											
"											
"											
"											
Mean											
Refresh Phase											
"											
"											
"											
"											

[78 FR 6721, Jan. 30, 2013]

For questions or comments regarding e-CFR editorial content, features, or design, email ecfr@nara.gov.
 For questions concerning e-CFR programming and delivery issues, email webteam@gpo.gov.

Appendix O - 40 CFR Part 63, Subpart III

ELECTRONIC CODE OF FEDERAL REGULATIONS

e-CFR Data is current as of August 30, 2013

Title 40: Protection of Environment

PART 60—STANDARDS OF PERFORMANCE FOR NEW STATIONARY SOURCES

Subpart III—Standards of Performance for Stationary Compression Ignition Internal Combustion Engines

Contents

WHAT THIS SUBPART COVERS

§ 60.4200 Am I subject to this subpart?

EMISSION STANDARDS FOR MANUFACTURERS

§ 60.4201 What emission standards must I meet for non-emergency engines if I am a stationary CI internal combustion engine manufacturer?

§ 60.4202 What emission standards must I meet for emergency engines if I am a stationary CI internal combustion engine manufacturer?

§ 60.4203 How long must my engines meet the emission standards if I am a manufacturer of stationary CI internal combustion engines?

EMISSION STANDARDS FOR OWNERS AND OPERATORS

§ 60.4204 What emission standards must I meet for non-emergency engines if I am an owner or operator of a stationary CI internal combustion engine?

§ 60.4205 What emission standards must I meet for emergency engines if I am an owner or operator of a stationary CI internal combustion engine?

§ 60.4206 How long must I meet the emission standards if I am an owner or operator of a stationary CI internal combustion engine?

FUEL REQUIREMENTS FOR OWNERS AND OPERATORS

§ 60.4207 What fuel requirements must I meet if I am an owner or operator of a stationary CI internal combustion engine subject to this subpart?

OTHER REQUIREMENTS FOR OWNERS AND OPERATORS

§ 60.4208 What is the deadline for importing or installing stationary CI ICE produced in previous model years?

§ 60.4209 What are the monitoring requirements if I am an owner or operator of a stationary CI internal combustion engine?

COMPLIANCE REQUIREMENTS

§ 60.4210 What are my compliance requirements if I am a stationary CI internal combustion engine manufacturer?

§ 60.4211 What are my compliance requirements if I am an owner or operator of a stationary CI internal combustion engine?

TESTING REQUIREMENTS FOR OWNERS AND OPERATORS

§ 60.4212 What test methods and other procedures must I use if I am an owner or operator of a stationary CI internal combustion engine with a displacement of less than 30 liters per cylinder?

§ 60.4213 What test methods and other procedures must I use if I am an owner or operator of a stationary CI internal combustion engine with a displacement of greater than or equal to 30 liters per cylinder?

NOTIFICATION, REPORTS, AND RECORDS FOR OWNERS AND OPERATORS

§ 60.4214 What are my notification, reporting, and recordkeeping requirements if I am an owner or operator of a stationary CI internal combustion engine?

SPECIAL REQUIREMENTS

§ 60.4215 What requirements must I meet for engines used in Guam, American Samoa, or the Commonwealth of the Northern Mariana Islands?

§ 60.4216 What requirements must I meet for engines used in Alaska?

§ 60.4217 What emission standards must I meet if I am an owner or operator of a stationary internal combustion engine using special fuels?

GENERAL PROVISIONS

§ 60.4218 What parts of the General Provisions apply to me?

§ 60.4219 What definitions apply to this subpart?

Table 1 to Subpart IIII of Part 60—Emission Standards for Stationary Pre-2007 Model Year Engines With a Displacement of <10 Liters per Cylinder and 2007-2010 Model Year Engines >2,237 KW (3,000 HP) and With a Displacement of <10 Liters per Cylinder

Table 2 to Subpart IIII of Part 60—Emission Standards for 2008 Model Year and Later Emergency Stationary CI ICE <37 KW (50 HP) With a Displacement of <10 Liters per Cylinder

Table 3 to Subpart IIII of Part 60—Certification Requirements for Stationary Fire Pump Engines

Table 4 to Subpart IIII of Part 60—Emission Standards for Stationary Fire Pump Engines

Table 5 to Subpart IIII of Part 60—Labeling and Recordkeeping Requirements for New Stationary Emergency Engines

Table 6 to Subpart IIII of Part 60—Optional 3-Mode Test Cycle for Stationary Fire Pump Engines

Table 7 to Subpart IIII of Part 60—Requirements for Performance Tests for Stationary CI ICE With a Displacement of ≥30 Liters per Cylinder

Table 8 to Subpart IIII of Part 60—Applicability of General Provisions to Subpart IIII

SOURCE: 71 FR 39172, July 11, 2006, unless otherwise noted.

What This Subpart Covers**§ 60.4200 Am I subject to this subpart?**

(a) The provisions of this subpart are applicable to manufacturers, owners, and operators of stationary compression ignition (CI) internal combustion engines (ICE) and other persons as specified in paragraphs (a)(1) through (4) of this section. For the purposes of this subpart, the date that construction commences is the date the engine is ordered by the owner or operator.

(1) Manufacturers of stationary CI ICE with a displacement of less than 30 liters per cylinder where the model year is:

(i) 2007 or later, for engines that are not fire pump engines;

(ii) The model year listed in Table 3 to this subpart or later model year, for fire pump engines.

(2) Owners and operators of stationary CI ICE that commence construction after July 11, 2005, where the stationary CI ICE are:

(i) Manufactured after April 1, 2006, and are not fire pump engines, or

(ii) Manufactured as a certified National Fire Protection Association (NFPA) fire pump engine after July 1, 2006.

(3) Owners and operators of any stationary CI ICE that are modified or reconstructed after July 11, 2005 and any person that modifies or reconstructs any stationary CI ICE after July 11, 2005.

(4) The provisions of § 60.4208 of this subpart are applicable to all owners and operators of stationary CI ICE that commence construction after July 11, 2005.

(b) The provisions of this subpart are not applicable to stationary CI ICE being tested at a stationary CI ICE test cell/stand.

(c) If you are an owner or operator of an area source subject to this subpart, you are exempt from the obligation to obtain a permit under 40 CFR part 70 or 40 CFR part 71, provided you are not required to obtain a permit under 40 CFR 70.3(a) or 40 CFR 71.3(a) for a reason other than your status as an area source under this subpart. Notwithstanding the previous sentence, you must continue to comply with the provisions of this subpart applicable to area sources.

(d) Stationary CI ICE may be eligible for exemption from the requirements of this subpart as described in 40 CFR part 1068, subpart C (or the exemptions described in 40 CFR part 89, subpart J and 40 CFR part 94, subpart J, for engines that would need to be certified to standards in those parts), except that owners and operators, as well as manufacturers, may be eligible to request an exemption for national security.

(e) Owners and operators of facilities with CI ICE that are acting as temporary replacement units and that are located at a stationary source for less than 1 year and that have been properly certified as meeting the standards that would be applicable to such engine under the appropriate nonroad engine provisions, are not required to meet any other provisions under this subpart with regard to such engines.

[71 FR 39172, July 11, 2006, as amended at 76 FR 37967, June 28, 2011]

Emission Standards for Manufacturers

§ 60.4201 What emission standards must I meet for non-emergency engines if I am a stationary CI internal combustion engine manufacturer?

(a) Stationary CI internal combustion engine manufacturers must certify their 2007 model year and later non-emergency stationary CI ICE with a maximum engine power less than or equal to 2,237 kilowatt (KW) (3,000 horsepower (HP)) and a displacement of less than 10 liters per cylinder to the certification emission standards for new nonroad CI engines in 40 CFR 89.112, 40 CFR 89.113, 40 CFR 1039.101, 40 CFR 1039.102, 40 CFR 1039.104, 40 CFR 1039.105, 40 CFR 1039.107, and 40 CFR 1039.115, as applicable, for all pollutants, for the same model year and maximum engine power.

(b) Stationary CI internal combustion engine manufacturers must certify their 2007 through 2010 model year non-emergency stationary CI ICE with a maximum engine power greater than 2,237 KW (3,000 HP) and a displacement of less than 10 liters per cylinder to the emission standards in table 1 to this subpart, for all pollutants, for the same maximum engine power.

(c) Stationary CI internal combustion engine manufacturers must certify their 2011 model year and later non-emergency stationary CI ICE with a maximum engine power greater than 2,237 KW (3,000 HP) and a displacement of less than 10 liters per cylinder to the certification emission standards for new nonroad CI engines in 40 CFR 1039.101, 40 CFR 1039.102, 40 CFR 1039.104, 40 CFR 1039.105, 40 CFR 1039.107, and 40 CFR 1039.115, as applicable, for all pollutants, for the same maximum engine power.

(d) Stationary CI internal combustion engine manufacturers must certify the following non-emergency stationary CI ICE to the certification emission standards for new marine CI engines in 40 CFR 94.8, as applicable, for all pollutants, for the same displacement and maximum engine power:

(1) Their 2007 model year through 2012 non-emergency stationary CI ICE with a displacement of greater than or equal to 10 liters per cylinder and less than 30 liters per cylinder;

(2) Their 2013 model year non-emergency stationary CI ICE with a maximum engine power greater than or equal to 3,700 KW (4,958 HP) and a displacement of greater than or equal to 10 liters per cylinder and less than 15 liters per cylinder; and

(3) Their 2013 model year non-emergency stationary CI ICE with a displacement of greater than or equal to 15 liters per cylinder and less than 30 liters per cylinder.

(e) Stationary CI internal combustion engine manufacturers must certify the following non-emergency stationary CI ICE to the certification emission standards and other requirements for new marine CI engines in 40 CFR 1042.101, 40 CFR 1042.107, 40 CFR 1042.110, 40 CFR 1042.115, 40 CFR 1042.120, and 40 CFR 1042.145, as applicable, for all pollutants, for the same displacement and maximum engine power:

(1) Their 2013 model year non-emergency stationary CI ICE with a maximum engine power less than 3,700 KW (4,958 HP) and a displacement of greater than or equal to 10 liters per cylinder and less than 15 liters per cylinder; and

(2) Their 2014 model year and later non-emergency stationary CI ICE with a displacement of greater than or equal to 10 liters per cylinder and less than 30 liters per cylinder.

(f) Notwithstanding the requirements in paragraphs (a) through (c) of this section, stationary non-emergency CI ICE identified in paragraphs (a) and (c) may be certified to the provisions of 40 CFR part 94 or, if Table 1 to 40 CFR 1042.1 identifies 40 CFR part 1042 as being applicable, 40 CFR part 1042, if the engines will be used solely in either or both of the following locations:

(1) Areas of Alaska not accessible by the Federal Aid Highway System (FAHS); and

(2) Marine offshore installations.

(g) Notwithstanding the requirements in paragraphs (a) through (f) of this section, stationary CI internal combustion engine manufacturers are not required to certify reconstructed engines; however manufacturers may elect to do so. The reconstructed engine must be certified to the emission standards specified in paragraphs (a) through (e) of this section that are applicable to the model year, maximum engine power, and displacement of the reconstructed stationary CI ICE.

[71 FR 39172, July 11, 2006, as amended at 76 FR 37967, June 28, 2011]

§ 60.4202 What emission standards must I meet for emergency engines if I am a stationary CI internal combustion engine manufacturer?

(a) Stationary CI internal combustion engine manufacturers must certify their 2007 model year and later emergency stationary CI ICE with a maximum engine power less than or equal to 2,237 KW (3,000 HP) and a displacement of less than 10 liters per cylinder that are not fire pump engines to the emission standards specified in paragraphs (a)(1) through (2) of this section.

(1) For engines with a maximum engine power less than 37 KW (50 HP):

(i) The certification emission standards for new nonroad CI engines for the same model year and maximum engine power in 40 CFR 89.112 and 40 CFR 89.113 for all pollutants for model year 2007 engines, and

(ii) The certification emission standards for new nonroad CI engines in 40 CFR 1039.104, 40 CFR 1039.105, 40 CFR 1039.107, 40 CFR 1039.115, and table 2 to this subpart, for 2008 model year and later engines.

(2) For engines with a maximum engine power greater than or equal to 37 KW (50 HP), the certification emission standards for new nonroad CI engines for the same model year and maximum engine power in 40 CFR 89.112 and 40 CFR 89.113 for all pollutants beginning in model year 2007.

(b) Stationary CI internal combustion engine manufacturers must certify their 2007 model year and later emergency stationary CI ICE with a maximum engine power greater than 2,237 KW (3,000 HP) and a displacement of less than 10 liters per cylinder that are not fire pump engines to the emission standards specified in paragraphs (b)(1) through (2) of this section.

(1) For 2007 through 2010 model years, the emission standards in table 1 to this subpart, for all pollutants, for the same maximum engine power.

(2) For 2011 model year and later, the certification emission standards for new nonroad CI engines for engines of the same model year and maximum engine power in 40 CFR 89.112 and 40 CFR 89.113 for all pollutants.

(c) [Reserved]

(d) Beginning with the model years in table 3 to this subpart, stationary CI internal combustion engine manufacturers must certify their fire pump stationary CI ICE to the emission standards in table 4 to this subpart, for all pollutants, for the same model year and NFPA nameplate power.

(e) Stationary CI internal combustion engine manufacturers must certify the following emergency stationary CI ICE that are not fire pump engines to the certification emission standards for new marine CI engines in 40 CFR 94.8, as applicable, for all pollutants, for the same displacement and maximum engine power:

(1) Their 2007 model year through 2012 emergency stationary CI ICE with a displacement of greater than or equal to 10 liters per cylinder and less than 30 liters per cylinder;

(2) Their 2013 model year and later emergency stationary CI ICE with a maximum engine power greater than or equal to 3,700 KW (4,958 HP) and a displacement of greater than or equal to 10 liters per cylinder and less than 15 liters per cylinder;

(3) Their 2013 model year emergency stationary CI ICE with a displacement of greater than or equal to 15 liters per cylinder and less than 30 liters per cylinder; and

(4) Their 2014 model year and later emergency stationary CI ICE with a maximum engine power greater than or equal to 2,000 KW (2,682 HP) and a displacement of greater than or equal to 15 liters per cylinder and less than 30 liters per cylinder.

(f) Stationary CI internal combustion engine manufacturers must certify the following emergency stationary CI ICE to the certification emission standards and other requirements applicable to Tier 3 new marine CI engines in 40 CFR 1042.101, 40 CFR 1042.107, 40 CFR 1042.115, 40 CFR 1042.120, and 40 CFR 1042.145, for all pollutants, for the same displacement and maximum engine power:

(1) Their 2013 model year and later emergency stationary CI ICE with a maximum engine power less than 3,700 KW (4,958 HP) and a displacement of greater than or equal to 10 liters per cylinder and less than 15 liters per cylinder; and

(2) Their 2014 model year and later emergency stationary CI ICE with a maximum engine power less than 2,000 KW (2,682 HP) and a displacement of greater than or equal to 15 liters per cylinder and less than 30 liters per cylinder.

(g) Notwithstanding the requirements in paragraphs (a) through (d) of this section, stationary emergency CI internal combustion engines identified in paragraphs (a) and (c) may be certified to the

provisions of 40 CFR part 94 or, if Table 2 to 40 CFR 1042.101 identifies Tier 3 standards as being applicable, the requirements applicable to Tier 3 engines in 40 CFR part 1042, if the engines will be used solely in either or both of the following locations:

- (1) Areas of Alaska not accessible by the FAHS; and
- (2) Marine offshore installations.

(h) Notwithstanding the requirements in paragraphs (a) through (f) of this section, stationary CI internal combustion engine manufacturers are not required to certify reconstructed engines; however manufacturers may elect to do so. The reconstructed engine must be certified to the emission standards specified in paragraphs (a) through (f) of this section that are applicable to the model year, maximum engine power and displacement of the reconstructed emergency stationary CI ICE.

[71 FR 39172, July 11, 2006, as amended at 76 FR 37968, June 28, 2011]

§ 60.4203 How long must my engines meet the emission standards if I am a manufacturer of stationary CI internal combustion engines?

Engines manufactured by stationary CI internal combustion engine manufacturers must meet the emission standards as required in §§ 60.4201 and 60.4202 during the certified emissions life of the engines.

[76 FR 37968, June 28, 2011]

Emission Standards for Owners and Operators

§ 60.4204 What emission standards must I meet for non-emergency engines if I am an owner or operator of a stationary CI internal combustion engine?

(a) Owners and operators of pre-2007 model year non-emergency stationary CI ICE with a displacement of less than 10 liters per cylinder must comply with the emission standards in table 1 to this subpart. Owners and operators of pre-2007 model year non-emergency stationary CI ICE with a displacement of greater than or equal to 10 liters per cylinder and less than 30 liters per cylinder must comply with the emission standards in 40 CFR 94.8(a)(1).

(b) Owners and operators of 2007 model year and later non-emergency stationary CI ICE with a displacement of less than 30 liters per cylinder must comply with the emission standards for new CI engines in § 60.4201 for their 2007 model year and later stationary CI ICE, as applicable.

(c) Owners and operators of non-emergency stationary CI engines with a displacement of greater than or equal to 30 liters per cylinder must meet the following requirements:

(1) For engines installed prior to January 1, 2012, limit the emissions of NO_x in the stationary CI internal combustion engine exhaust to the following:

(i) 17.0 grams per kilowatt-hour (g/KW-hr) (12.7 grams per horsepower-hr (g/HP-hr)) when maximum engine speed is less than 130 revolutions per minute (rpm);

(ii) $45 \cdot n^{-0.2}$ g/KW-hr ($34 \cdot n^{-0.2}$ g/HP-hr) when maximum engine speed is 130 or more but less than 2,000 rpm, where n is maximum engine speed; and

(iii) 9.8 g/KW-hr (7.3 g/HP-hr) when maximum engine speed is 2,000 rpm or more.

(2) For engines installed on or after January 1, 2012 and before January 1, 2016, limit the emissions of NO_x in the stationary CI internal combustion engine exhaust to the following:

(i) 14.4 g/KW-hr (10.7 g/HP-hr) when maximum engine speed is less than 130 rpm;

(ii) $44 \cdot n^{-0.23}$ g/KW-hr ($33 \cdot n^{-0.23}$ g/HP-hr) when maximum engine speed is greater than or equal to 130 but less than 2,000 rpm and where n is maximum engine speed; and

(iii) 7.7 g/KW-hr (5.7 g/HP-hr) when maximum engine speed is greater than or equal to 2,000 rpm.

(3) For engines installed on or after January 1, 2016, limit the emissions of NO_x in the stationary CI internal combustion engine exhaust to the following:

(i) 3.4 g/KW-hr (2.5 g/HP-hr) when maximum engine speed is less than 130 rpm;

(ii) $9.0 \cdot n^{-0.20}$ g/KW-hr ($6.7 \cdot n^{-0.20}$ g/HP-hr) where n (maximum engine speed) is 130 or more but less than 2,000 rpm; and

(iii) 2.0 g/KW-hr (1.5 g/HP-hr) where maximum engine speed is greater than or equal to 2,000 rpm.

(4) Reduce particulate matter (PM) emissions by 60 percent or more, or limit the emissions of PM in the stationary CI internal combustion engine exhaust to 0.15 g/KW-hr (0.11 g/HP-hr).

(d) Owners and operators of non-emergency stationary CI ICE with a displacement of less than 30 liters per cylinder who conduct performance tests in-use must meet the not-to-exceed (NTE) standards as indicated in § 60.4212.

(e) Owners and operators of any modified or reconstructed non-emergency stationary CI ICE subject to this subpart must meet the emission standards applicable to the model year, maximum engine power, and displacement of the modified or reconstructed non-emergency stationary CI ICE that are specified in paragraphs (a) through (d) of this section.

[71 FR 39172, July 11, 2006, as amended at 76 FR 37968, June 28, 2011]

§ 60.4205 What emission standards must I meet for emergency engines if I am an owner or operator of a stationary CI internal combustion engine?

(a) Owners and operators of pre-2007 model year emergency stationary CI ICE with a displacement of less than 10 liters per cylinder that are not fire pump engines must comply with the emission standards in Table 1 to this subpart. Owners and operators of pre-2007 model year emergency stationary CI ICE with a displacement of greater than or equal to 10 liters per cylinder and less than 30 liters per cylinder that are not fire pump engines must comply with the emission standards in 40 CFR 94.8(a)(1).

(b) Owners and operators of 2007 model year and later emergency stationary CI ICE with a displacement of less than 30 liters per cylinder that are not fire pump engines must comply with the emission standards for new nonroad CI engines in § 60.4202, for all pollutants, for the same model year and maximum engine power for their 2007 model year and later emergency stationary CI ICE.

(c) Owners and operators of fire pump engines with a displacement of less than 30 liters per cylinder must comply with the emission standards in table 4 to this subpart, for all pollutants.

(d) Owners and operators of emergency stationary CI engines with a displacement of greater than or equal to 30 liters per cylinder must meet the requirements in this section.

(1) For engines installed prior to January 1, 2012, limit the emissions of NO_x in the stationary CI internal combustion engine exhaust to the following:

(i) 17.0 g/KW-hr (12.7 g/HP-hr) when maximum engine speed is less than 130 rpm;

(ii) $45 \cdot n^{-0.2}$ g/KW-hr ($34 \cdot n^{-0.2}$ g/HP-hr) when maximum engine speed is 130 or more but less than 2,000 rpm, where n is maximum engine speed; and

(iii) 9.8 g/kW-hr (7.3 g/HP-hr) when maximum engine speed is 2,000 rpm or more.

(2) For engines installed on or after January 1, 2012, limit the emissions of NO_x in the stationary CI internal combustion engine exhaust to the following:

(i) 14.4 g/KW-hr (10.7 g/HP-hr) when maximum engine speed is less than 130 rpm;

(ii) $44 \cdot n^{-0.23}$ g/KW-hr ($33 \cdot n^{-0.23}$ g/HP-hr) when maximum engine speed is greater than or equal to 130 but less than 2,000 rpm and where n is maximum engine speed; and

(iii) 7.7 g/KW-hr (5.7 g/HP-hr) when maximum engine speed is greater than or equal to 2,000 rpm.

(3) Limit the emissions of PM in the stationary CI internal combustion engine exhaust to 0.40 g/KW-hr (0.30 g/HP-hr).

(e) Owners and operators of emergency stationary CI ICE with a displacement of less than 30 liters per cylinder who conduct performance tests in-use must meet the NTE standards as indicated in § 60.4212.

(f) Owners and operators of any modified or reconstructed emergency stationary CI ICE subject to this subpart must meet the emission standards applicable to the model year, maximum engine power, and displacement of the modified or reconstructed CI ICE that are specified in paragraphs (a) through (e) of this section.

[71 FR 39172, July 11, 2006, as amended at 76 FR 37969, June 28, 2011]

§ 60.4206 How long must I meet the emission standards if I am an owner or operator of a stationary CI internal combustion engine?

Owners and operators of stationary CI ICE must operate and maintain stationary CI ICE that achieve the emission standards as required in §§ 60.4204 and 60.4205 over the entire life of the engine.

[76 FR 37969, June 28, 2011]

Fuel Requirements for Owners and Operators

§ 60.4207 What fuel requirements must I meet if I am an owner or operator of a stationary CI internal combustion engine subject to this subpart?

(a) Beginning October 1, 2007, owners and operators of stationary CI ICE subject to this subpart that use diesel fuel must use diesel fuel that meets the requirements of 40 CFR 80.510(a).

(b) Beginning October 1, 2010, owners and operators of stationary CI ICE subject to this subpart with a displacement of less than 30 liters per cylinder that use diesel fuel must use diesel fuel that meets the requirements of 40 CFR 80.510(b) for nonroad diesel fuel, except that any existing diesel fuel purchased (or otherwise obtained) prior to October 1, 2010, may be used until depleted.

(c) [Reserved]

(d) Beginning June 1, 2012, owners and operators of stationary CI ICE subject to this subpart with a displacement of greater than or equal to 30 liters per cylinder are no longer subject to the requirements of paragraph (a) of this section, and must use fuel that meets a maximum per-gallon sulfur content of 1,000 parts per million (ppm).

(e) Stationary CI ICE that have a national security exemption under § 60.4200(d) are also exempt from the fuel requirements in this section.

[71 FR 39172, July 11, 2006, as amended at 76 FR 37969, June 28, 2011; 78 FR 6695, Jan. 30, 2013]

Other Requirements for Owners and Operators

§ 60.4208 What is the deadline for importing or installing stationary CI ICE produced in previous model years?

(a) After December 31, 2008, owners and operators may not install stationary CI ICE (excluding fire pump engines) that do not meet the applicable requirements for 2007 model year engines.

(b) After December 31, 2009, owners and operators may not install stationary CI ICE with a maximum engine power of less than 19 KW (25 HP) (excluding fire pump engines) that do not meet the applicable requirements for 2008 model year engines.

(c) After December 31, 2014, owners and operators may not install non-emergency stationary CI ICE with a maximum engine power of greater than or equal to 19 KW (25 HP) and less than 56 KW (75 HP) that do not meet the applicable requirements for 2013 model year non-emergency engines.

(d) After December 31, 2013, owners and operators may not install non-emergency stationary CI ICE with a maximum engine power of greater than or equal to 56 KW (75 HP) and less than 130 KW (175 HP) that do not meet the applicable requirements for 2012 model year non-emergency engines.

(e) After December 31, 2012, owners and operators may not install non-emergency stationary CI ICE with a maximum engine power of greater than or equal to 130 KW (175 HP), including those above 560 KW (750 HP), that do not meet the applicable requirements for 2011 model year non-emergency engines.

(f) After December 31, 2016, owners and operators may not install non-emergency stationary CI ICE with a maximum engine power of greater than or equal to 560 KW (750 HP) that do not meet the applicable requirements for 2015 model year non-emergency engines.

(g) After December 31, 2018, owners and operators may not install non-emergency stationary CI ICE with a maximum engine power greater than or equal to 600 KW (804 HP) and less than 2,000 KW (2,680 HP) and a displacement of greater than or equal to 10 liters per cylinder and less than 30 liters per cylinder that do not meet the applicable requirements for 2017 model year non-emergency engines.

(h) In addition to the requirements specified in §§ 60.4201, 60.4202, 60.4204, and 60.4205, it is prohibited to import stationary CI ICE with a displacement of less than 30 liters per cylinder that do not meet the applicable requirements specified in paragraphs (a) through (g) of this section after the dates specified in paragraphs (a) through (g) of this section.

(i) The requirements of this section do not apply to owners or operators of stationary CI ICE that have been modified, reconstructed, and do not apply to engines that were removed from one existing location and reinstalled at a new location.

[71 FR 39172, July 11, 2006, as amended at 76 FR 37969, June 28, 2011]

§ 60.4209 What are the monitoring requirements if I am an owner or operator of a stationary CI internal combustion engine?

If you are an owner or operator, you must meet the monitoring requirements of this section. In addition, you must also meet the monitoring requirements specified in § 60.4211.

(a) If you are an owner or operator of an emergency stationary CI internal combustion engine that does not meet the standards applicable to non-emergency engines, you must install a non-resettable hour meter prior to startup of the engine.

(b) If you are an owner or operator of a stationary CI internal combustion engine equipped with a diesel particulate filter to comply with the emission standards in § 60.4204, the diesel particulate filter must be installed with a backpressure monitor that notifies the owner or operator when the high backpressure limit of the engine is approached.

[71 FR 39172, July 11, 2006, as amended at 76 FR 37969, June 28, 2011]

Compliance Requirements

§ 60.4210 What are my compliance requirements if I am a stationary CI internal combustion engine manufacturer?

(a) Stationary CI internal combustion engine manufacturers must certify their stationary CI ICE with a displacement of less than 10 liters per cylinder to the emission standards specified in § 60.4201 (a) through (c) and § 60.4202(a), (b) and (d) using the certification procedures required in 40 CFR part 89, subpart B, or 40 CFR part 1039, subpart C, as applicable, and must test their engines as specified in those parts. For the purposes of this subpart, engines certified to the standards in table 1 to this subpart shall be subject to the same requirements as engines certified to the standards in 40 CFR part 89. For the purposes of this subpart, engines certified to the standards in table 4 to this subpart shall be subject to the same requirements as engines certified to the standards in 40 CFR part 89, except that engines with NFPA nameplate power of less than 37 KW (50 HP) certified to model year 2011 or later standards shall be subject to the same requirements as engines certified to the standards in 40 CFR part 1039.

(b) Stationary CI internal combustion engine manufacturers must certify their stationary CI ICE with a displacement of greater than or equal to 10 liters per cylinder and less than 30 liters per cylinder to the emission standards specified in § 60.4201(d) and (e) and § 60.4202(e) and (f) using the certification procedures required in 40 CFR part 94, subpart C, or 40 CFR part 1042, subpart C, as applicable, and must test their engines as specified in 40 CFR part 94 or 1042, as applicable.

(c) Stationary CI internal combustion engine manufacturers must meet the requirements of 40 CFR 1039.120, 1039.125, 1039.130, and 1039.135, and 40 CFR part 1068 for engines that are certified to the emission standards in 40 CFR part 1039. Stationary CI internal combustion engine manufacturers must meet the corresponding provisions of 40 CFR part 89, 40 CFR part 94 or 40 CFR part 1042 for engines that would be covered by that part if they were nonroad (including marine) engines. Labels on such engines must refer to stationary engines, rather than or in addition to nonroad or marine engines, as appropriate. Stationary CI internal combustion engine manufacturers must label their engines according to paragraphs (c)(1) through (3) of this section.

(1) Stationary CI internal combustion engines manufactured from January 1, 2006 to March 31, 2006 (January 1, 2006 to June 30, 2006 for fire pump engines), other than those that are part of certified engine families under the nonroad CI engine regulations, must be labeled according to 40 CFR 1039.20.

(2) Stationary CI internal combustion engines manufactured from April 1, 2006 to December 31, 2006 (or, for fire pump engines, July 1, 2006 to December 31 of the year preceding the year listed in table 3 to this subpart) must be labeled according to paragraphs (c)(2)(i) through (iii) of this section:

(i) Stationary CI internal combustion engines that are part of certified engine families under the nonroad regulations must meet the labeling requirements for nonroad CI engines, but do not have to meet the labeling requirements in 40 CFR 1039.20.

(ii) Stationary CI internal combustion engines that meet Tier 1 requirements (or requirements for fire pumps) under this subpart, but do not meet the requirements applicable to nonroad CI engines must be labeled according to 40 CFR 1039.20. The engine manufacturer may add language to the label clarifying that the engine meets Tier 1 requirements (or requirements for fire pumps) of this subpart.

(iii) Stationary CI internal combustion engines manufactured after April 1, 2006 that do not meet Tier 1 requirements of this subpart, or fire pumps engines manufactured after July 1, 2006 that do not meet the requirements for fire pumps under this subpart, may not be used in the U.S. If any such engines are manufactured in the U.S. after April 1, 2006 (July 1, 2006 for fire pump engines), they must be exported or must be brought into compliance with the appropriate standards prior to initial operation. The export provisions of 40 CFR 1068.230 would apply to engines for export and the manufacturers must label such engines according to 40 CFR 1068.230.

(3) Stationary CI internal combustion engines manufactured after January 1, 2007 (for fire pump engines, after January 1 of the year listed in table 3 to this subpart, as applicable) must be labeled according to paragraphs (c)(3)(i) through (iii) of this section.

(i) Stationary CI internal combustion engines that meet the requirements of this subpart and the corresponding requirements for nonroad (including marine) engines of the same model year and HP must be labeled according to the provisions in 40 CFR parts 89, 94, 1039 or 1042, as appropriate.

(ii) Stationary CI internal combustion engines that meet the requirements of this subpart, but are not certified to the standards applicable to nonroad (including marine) engines of the same model year and HP must be labeled according to the provisions in 40 CFR parts 89, 94, 1039 or 1042, as appropriate, but the words “stationary” must be included instead of “nonroad” or “marine” on the label. In addition, such engines must be labeled according to 40 CFR 1039.20.

(iii) Stationary CI internal combustion engines that do not meet the requirements of this subpart must be labeled according to 40 CFR 1068.230 and must be exported under the provisions of 40 CFR 1068.230.

(d) An engine manufacturer certifying an engine family or families to standards under this subpart that are identical to standards applicable under 40 CFR parts 89, 94, 1039 or 1042 for that model year may certify any such family that contains both nonroad (including marine) and stationary engines as a single engine family and/or may include any such family containing stationary engines in the averaging, banking and trading provisions applicable for such engines under those parts.

(e) Manufacturers of engine families discussed in paragraph (d) of this section may meet the labeling requirements referred to in paragraph (c) of this section for stationary CI ICE by either adding a separate label containing the information required in paragraph (c) of this section or by adding the words “and stationary” after the word “nonroad” or “marine,” as appropriate, to the label.

(f) Starting with the model years shown in table 5 to this subpart, stationary CI internal combustion engine manufacturers must add a permanent label stating that the engine is for stationary emergency use only to each new emergency stationary CI internal combustion engine greater than or equal to 19 KW (25 HP) that meets all the emission standards for emergency engines in § 60.4202 but does not meet all the emission standards for non-emergency engines in § 60.4201. The label must be added according to the labeling requirements specified in 40 CFR 1039.135(b). Engine manufacturers must specify in the owner's manual that operation of emergency engines is limited to emergency operations and required maintenance and testing.

(g) Manufacturers of fire pump engines may use the test cycle in table 6 to this subpart for testing fire pump engines and may test at the NFPA certified nameplate HP, provided that the engine is labeled as “Fire Pump Applications Only”.

(h) Engine manufacturers, including importers, may introduce into commerce uncertified engines or engines certified to earlier standards that were manufactured before the new or changed standards took effect until inventories are depleted, as long as such engines are part of normal inventory. For example, if the engine manufacturers' normal industry practice is to keep on hand a one-month supply of engines based on its projected sales, and a new tier of standards starts to apply for the 2009 model year, the engine manufacturer may manufacture engines based on the normal inventory requirements late in the 2008 model year, and sell those engines for installation. The engine manufacturer may not circumvent the provisions of §§ 60.4201 or 60.4202 by stockpiling engines that are built before new or changed standards take effect. Stockpiling of such engines beyond normal industry practice is a violation of this subpart.

(i) The replacement engine provisions of 40 CFR 89.1003(b)(7), 40 CFR 94.1103(b)(3), 40 CFR 94.1103(b)(4) and 40 CFR 1068.240 are applicable to stationary CI engines replacing existing equipment that is less than 15 years old.

[71 FR 39172, July 11, 2006, as amended at 76 FR 37969, June 28, 2011]

§ 60.4211 What are my compliance requirements if I am an owner or operator of a stationary CI internal combustion engine?

(a) If you are an owner or operator and must comply with the emission standards specified in this subpart, you must do all of the following, except as permitted under paragraph (g) of this section:

- (1) Operate and maintain the stationary CI internal combustion engine and control device according to the manufacturer's emission-related written instructions;
- (2) Change only those emission-related settings that are permitted by the manufacturer; and
- (3) Meet the requirements of 40 CFR parts 89, 94 and/or 1068, as they apply to you.

(b) If you are an owner or operator of a pre-2007 model year stationary CI internal combustion engine and must comply with the emission standards specified in §§ 60.4204(a) or 60.4205(a), or if you are an owner or operator of a CI fire pump engine that is manufactured prior to the model years in table 3 to this subpart and must comply with the emission standards specified in § 60.4205(c), you must demonstrate compliance according to one of the methods specified in paragraphs (b)(1) through (5) of this section.

(1) Purchasing an engine certified according to 40 CFR part 89 or 40 CFR part 94, as applicable, for the same model year and maximum engine power. The engine must be installed and configured according to the manufacturer's specifications.

(2) Keeping records of performance test results for each pollutant for a test conducted on a similar engine. The test must have been conducted using the same methods specified in this subpart and these methods must have been followed correctly.

(3) Keeping records of engine manufacturer data indicating compliance with the standards.

(4) Keeping records of control device vendor data indicating compliance with the standards.

(5) Conducting an initial performance test to demonstrate compliance with the emission standards according to the requirements specified in § 60.4212, as applicable.

(c) If you are an owner or operator of a 2007 model year and later stationary CI internal combustion engine and must comply with the emission standards specified in § 60.4204(b) or § 60.4205(b), or if you are an owner or operator of a CI fire pump engine that is manufactured during or after the model year that applies to your fire pump engine power rating in table 3 to this subpart and must comply with the emission standards specified in § 60.4205(c), you must comply by purchasing an engine certified to the emission standards in § 60.4204(b), or § 60.4205(b) or (c), as applicable, for the same model year and maximum (or in the case of fire pumps, NFPA nameplate) engine power. The engine must be installed and configured according to the manufacturer's emission-related specifications, except as permitted in paragraph (g) of this section.

(d) If you are an owner or operator and must comply with the emission standards specified in § 60.4204(c) or § 60.4205(d), you must demonstrate compliance according to the requirements specified in paragraphs (d)(1) through (3) of this section.

(1) Conducting an initial performance test to demonstrate initial compliance with the emission standards as specified in § 60.4213.

(2) Establishing operating parameters to be monitored continuously to ensure the stationary internal combustion engine continues to meet the emission standards. The owner or operator must petition the Administrator for approval of operating parameters to be monitored continuously. The petition must include the information described in paragraphs (d)(2)(i) through (v) of this section.

(i) Identification of the specific parameters you propose to monitor continuously;

(ii) A discussion of the relationship between these parameters and NO_x and PM emissions, identifying how the emissions of these pollutants change with changes in these parameters, and how limitations on these parameters will serve to limit NO_x and PM emissions;

(iii) A discussion of how you will establish the upper and/or lower values for these parameters which will establish the limits on these parameters in the operating limitations;

(iv) A discussion identifying the methods and the instruments you will use to monitor these parameters, as well as the relative accuracy and precision of these methods and instruments; and

(v) A discussion identifying the frequency and methods for recalibrating the instruments you will use for monitoring these parameters.

(3) For non-emergency engines with a displacement of greater than or equal to 30 liters per cylinder, conducting annual performance tests to demonstrate continuous compliance with the emission standards as specified in § 60.4213.

(e) If you are an owner or operator of a modified or reconstructed stationary CI internal combustion engine and must comply with the emission standards specified in § 60.4204(e) or § 60.4205(f), you must demonstrate compliance according to one of the methods specified in paragraphs (e)(1) or (2) of this section.

(1) Purchasing, or otherwise owning or operating, an engine certified to the emission standards in § 60.4204(e) or § 60.4205(f), as applicable.

(2) Conducting a performance test to demonstrate initial compliance with the emission standards according to the requirements specified in § 60.4212 or § 60.4213, as appropriate. The test must be conducted within 60 days after the engine commences operation after the modification or reconstruction.

(f) If you own or operate an emergency stationary ICE, you must operate the emergency stationary ICE according to the requirements in paragraphs (f)(1) through (3) of this section. In order for the engine to be considered an emergency stationary ICE under this subpart, any operation other than emergency operation, maintenance and testing, emergency demand response, and operation in non-emergency situations for 50 hours per year, as described in paragraphs (f)(1) through (3) of this section, is prohibited. If you do not operate the engine according to the requirements in paragraphs (f)(1) through (3) of this section, the engine will not be considered an emergency engine under this subpart and must meet all requirements for non-emergency engines.

(1) There is no time limit on the use of emergency stationary ICE in emergency situations.

(2) You may operate your emergency stationary ICE for any combination of the purposes specified in paragraphs (f)(2)(i) through (iii) of this section for a maximum of 100 hours per calendar year. Any operation for non-emergency situations as allowed by paragraph (f)(3) of this section counts as part of the 100 hours per calendar year allowed by this paragraph (f)(2).

(i) Emergency stationary ICE may be operated for maintenance checks and readiness testing, provided that the tests are recommended by federal, state or local government, the manufacturer, the vendor, the regional transmission organization or equivalent balancing authority and transmission operator, or the insurance company associated with the engine. The owner or operator may petition the Administrator for approval of additional hours to be used for maintenance checks and readiness testing, but a petition is not required if the owner or operator maintains records indicating that federal, state, or local standards require maintenance and testing of emergency ICE beyond 100 hours per calendar year.

(ii) Emergency stationary ICE may be operated for emergency demand response for periods in which the Reliability Coordinator under the North American Electric Reliability Corporation (NERC) Reliability Standard EOP-002-3, Capacity and Energy Emergencies (incorporated by reference, see

§ 60.17), or other authorized entity as determined by the Reliability Coordinator, has declared an Energy Emergency Alert Level 2 as defined in the NERC Reliability Standard EOP-002-3.

(iii) Emergency stationary ICE may be operated for periods where there is a deviation of voltage or frequency of 5 percent or greater below standard voltage or frequency.

(3) Emergency stationary ICE may be operated for up to 50 hours per calendar year in non-emergency situations. The 50 hours of operation in non-emergency situations are counted as part of the 100 hours per calendar year for maintenance and testing and emergency demand response provided in paragraph (f)(2) of this section. Except as provided in paragraph (f)(3)(i) of this section, the 50 hours per calendar year for non-emergency situations cannot be used for peak shaving or non-emergency demand response, or to generate income for a facility to an electric grid or otherwise supply power as part of a financial arrangement with another entity.

(i) The 50 hours per year for non-emergency situations can be used to supply power as part of a financial arrangement with another entity if all of the following conditions are met:

(A) The engine is dispatched by the local balancing authority or local transmission and distribution system operator;

(B) The dispatch is intended to mitigate local transmission and/or distribution limitations so as to avert potential voltage collapse or line overloads that could lead to the interruption of power supply in a local area or region.

(C) The dispatch follows reliability, emergency operation or similar protocols that follow specific NERC, regional, state, public utility commission or local standards or guidelines.

(D) The power is provided only to the facility itself or to support the local transmission and distribution system.

(E) The owner or operator identifies and records the entity that dispatches the engine and the specific NERC, regional, state, public utility commission or local standards or guidelines that are being followed for dispatching the engine. The local balancing authority or local transmission and distribution system operator may keep these records on behalf of the engine owner or operator.

(ii) [Reserved]

(g) If you do not install, configure, operate, and maintain your engine and control device according to the manufacturer's emission-related written instructions, or you change emission-related settings in a way that is not permitted by the manufacturer, you must demonstrate compliance as follows:

(1) If you are an owner or operator of a stationary CI internal combustion engine with maximum engine power less than 100 HP, you must keep a maintenance plan and records of conducted maintenance to demonstrate compliance and must, to the extent practicable, maintain and operate the engine in a manner consistent with good air pollution control practice for minimizing emissions. In addition, if you do not install and configure the engine and control device according to the manufacturer's emission-related written instructions, or you change the emission-related settings in a way that is not permitted by the manufacturer, you must conduct an initial performance test to demonstrate compliance with the applicable emission standards within 1 year of such action.

(2) If you are an owner or operator of a stationary CI internal combustion engine greater than or equal to 100 HP and less than or equal to 500 HP, you must keep a maintenance plan and records of conducted maintenance and must, to the extent practicable, maintain and operate the engine in a manner consistent with good air pollution control practice for minimizing emissions. In addition, you must conduct an initial performance test to demonstrate compliance with the applicable emission standards within 1 year of startup, or within 1 year after an engine and control device is no longer installed, configured, operated, and maintained in accordance with the manufacturer's emission-related written instructions, or within 1 year after you change emission-related settings in a way that is not permitted by the manufacturer.

(3) If you are an owner or operator of a stationary CI internal combustion engine greater than 500 HP, you must keep a maintenance plan and records of conducted maintenance and must, to the extent practicable, maintain and operate the engine in a manner consistent with good air pollution control practice for minimizing emissions. In addition, you must conduct an initial performance test to demonstrate compliance with the applicable emission standards within 1 year of startup, or within 1 year after an engine and control device is no longer installed, configured, operated, and maintained in accordance with the manufacturer's emission-related written instructions, or within 1 year after you change emission-related settings in a way that is not permitted by the manufacturer. You must conduct subsequent performance testing every 8,760 hours of engine operation or 3 years, whichever comes first, thereafter to demonstrate compliance with the applicable emission standards.

[71 FR 39172, July 11, 2006, as amended at 76 FR 37970, June 28, 2011; 78 FR 6695, Jan. 30, 2013]

Testing Requirements for Owners and Operators

§ 60.4212 What test methods and other procedures must I use if I am an owner or operator of a stationary CI internal combustion engine with a displacement of less than 30 liters per cylinder?

Owners and operators of stationary CI ICE with a displacement of less than 30 liters per cylinder who conduct performance tests pursuant to this subpart must do so according to paragraphs (a) through (e) of this section.

(a) The performance test must be conducted according to the in-use testing procedures in 40 CFR part 1039, subpart F, for stationary CI ICE with a displacement of less than 10 liters per cylinder, and according to 40 CFR part 1042, subpart F, for stationary CI ICE with a displacement of greater than or equal to 10 liters per cylinder and less than 30 liters per cylinder.

(b) Exhaust emissions from stationary CI ICE that are complying with the emission standards for new CI engines in 40 CFR part 1039 must not exceed the not-to-exceed (NTE) standards for the same model year and maximum engine power as required in 40 CFR 1039.101(e) and 40 CFR 1039.102(g) (1), except as specified in 40 CFR 1039.104(d). This requirement starts when NTE requirements take effect for nonroad diesel engines under 40 CFR part 1039.

(c) Exhaust emissions from stationary CI ICE that are complying with the emission standards for new CI engines in 40 CFR 89.112 or 40 CFR 94.8, as applicable, must not exceed the NTE numerical requirements, rounded to the same number of decimal places as the applicable standard in 40 CFR 89.112 or 40 CFR 94.8, as applicable, determined from the following equation:

$$\text{NTE requirement for each pollutant} = (1.25) \times (\text{STD}) \quad (\text{Eq. 1})$$

Where:

STD = The standard specified for that pollutant in 40 CFR 89.112 or 40 CFR 94.8, as applicable.

Alternatively, stationary CI ICE that are complying with the emission standards for new CI engines in 40 CFR 89.112 or 40 CFR 94.8 may follow the testing procedures specified in § 60.4213 of this subpart, as appropriate.

(d) Exhaust emissions from stationary CI ICE that are complying with the emission standards for pre-2007 model year engines in § 60.4204(a), § 60.4205(a), or § 60.4205(c) must not exceed the NTE numerical requirements, rounded to the same number of decimal places as the applicable standard in § 60.4204(a), § 60.4205(a), or § 60.4205(c), determined from the equation in paragraph (c) of this section.

Where:

STD = The standard specified for that pollutant in § 60.4204(a), § 60.4205(a), or § 60.4205(c).

Alternatively, stationary CI ICE that are complying with the emission standards for pre-2007 model year engines in § 60.4204(a), § 60.4205(a), or § 60.4205(c) may follow the testing procedures specified in § 60.4213, as appropriate.

(e) Exhaust emissions from stationary CI ICE that are complying with the emission standards for new CI engines in 40 CFR part 1042 must not exceed the NTE standards for the same model year and maximum engine power as required in 40 CFR 1042.101(c).

[71 FR 39172, July 11, 2006, as amended at 76 FR 37971, June 28, 2011]

§ 60.4213 What test methods and other procedures must I use if I am an owner or operator of a stationary CI internal combustion engine with a displacement of greater than or equal to 30 liters per cylinder?

Owners and operators of stationary CI ICE with a displacement of greater than or equal to 30 liters per cylinder must conduct performance tests according to paragraphs (a) through (f) of this section.

(a) Each performance test must be conducted according to the requirements in § 60.8 and under the specific conditions that this subpart specifies in table 7. The test must be conducted within 10 percent of 100 percent peak (or the highest achievable) load.

(b) You may not conduct performance tests during periods of startup, shutdown, or malfunction, as specified in § 60.8(c).

(c) You must conduct three separate test runs for each performance test required in this section, as specified in § 60.8(f). Each test run must last at least 1 hour.

(d) To determine compliance with the percent reduction requirement, you must follow the requirements as specified in paragraphs (d)(1) through (3) of this section.

(1) You must use Equation 2 of this section to determine compliance with the percent reduction requirement:

$$\frac{C_i - C_o}{C_i} \times 100 = R \quad (\text{Eq. 2})$$

Where:

C_i = concentration of NO_x or PM at the control device inlet,

C_o = concentration of NO_x or PM at the control device outlet, and

R = percent reduction of NO_x or PM emissions.

(2) You must normalize the NO_x or PM concentrations at the inlet and outlet of the control device to a dry basis and to 15 percent oxygen (O_2) using Equation 3 of this section, or an equivalent percent carbon dioxide (CO_2) using the procedures described in paragraph (d)(3) of this section.

$$C_{\text{adj}} = C_d \frac{5.9}{20.9 - \% \text{O}_2} \quad (\text{Eq. 3})$$

Where:

C_{adj} = Calculated NO_x or PM concentration adjusted to 15 percent O_2 .

C_d = Measured concentration of NO_x or PM, uncorrected.

5.9 = 20.9 percent O_2 - 15 percent O_2 , the defined O_2 correction value, percent.

%O₂ = Measured O₂ concentration, dry basis, percent.

(3) If pollutant concentrations are to be corrected to 15 percent O₂ and CO₂ concentration is measured in lieu of O₂ concentration measurement, a CO₂ correction factor is needed. Calculate the CO₂ correction factor as described in paragraphs (d)(3)(i) through (iii) of this section.

(i) Calculate the fuel-specific F_o value for the fuel burned during the test using values obtained from Method 19, Section 5.2, and the following equation:

$$F_o = \frac{0.209 \times F_d}{F_c} \quad (\text{Eq. 4})$$

Where:

F_o = Fuel factor based on the ratio of O₂ volume to the ultimate CO₂ volume produced by the fuel at zero percent excess air.

0.209 = Fraction of air that is O₂, percent/100.

F_d = Ratio of the volume of dry effluent gas to the gross calorific value of the fuel from Method 19, dsm³ /J (dscf/10⁶ Btu).

F_c = Ratio of the volume of CO₂ produced to the gross calorific value of the fuel from Method 19, dsm³ /J (dscf/10⁶ Btu).

(ii) Calculate the CO₂ correction factor for correcting measurement data to 15 percent O₂, as follows:

$$X_{CO_2} = \frac{5.9}{F_o} \quad (\text{Eq. 5})$$

Where:

X_{CO₂} = CO₂ correction factor, percent.

5.9 = 20.9 percent O₂ - 15 percent O₂, the defined O₂ correction value, percent.

(iii) Calculate the NO_x and PM gas concentrations adjusted to 15 percent O₂ using CO₂ as follows:

$$C_{adj} = C_d \frac{X_{CO_2}}{\%CO_2} \quad (\text{Eq. 6})$$

Where:

C_{adj} = Calculated NO_x or PM concentration adjusted to 15 percent O₂.

C_d = Measured concentration of NO_x or PM, uncorrected.

%CO₂ = Measured CO₂ concentration, dry basis, percent.

(e) To determine compliance with the NO_x mass per unit output emission limitation, convert the concentration of NO_x in the engine exhaust using Equation 7 of this section:

$$ER = \frac{C_d \times 1.912 \times 10^{-3} \times Q \times T}{\text{KW-hour}} \quad (\text{Eq. 7})$$

Where:

ER = Emission rate in grams per KW-hour.

C_d = Measured NO_x concentration in ppm.

1.912×10^{-3} = Conversion constant for ppm NO_x to grams per standard cubic meter at 25 degrees Celsius.

Q = Stack gas volumetric flow rate, in standard cubic meter per hour.

T = Time of test run, in hours.

KW-hour = Brake work of the engine, in KW-hour.

(f) To determine compliance with the PM mass per unit output emission limitation, convert the concentration of PM in the engine exhaust using Equation 8 of this section:

$$ER = \frac{C_{adj} \times Q \times T}{KW\text{-hour}} \quad (\text{Eq. 8})$$

Where:

ER = Emission rate in grams per KW-hour.

C_{adj} = Calculated PM concentration in grams per standard cubic meter.

Q = Stack gas volumetric flow rate, in standard cubic meter per hour.

T = Time of test run, in hours.

KW-hour = Energy output of the engine, in KW.

[71 FR 39172, July 11, 2006, as amended at 76 FR 37971, June 28, 2011]

Notification, Reports, and Records for Owners and Operators

§ 60.4214 What are my notification, reporting, and recordkeeping requirements if I am an owner or operator of a stationary CI internal combustion engine?

(a) Owners and operators of non-emergency stationary CI ICE that are greater than 2,237 KW (3,000 HP), or have a displacement of greater than or equal to 10 liters per cylinder, or are pre-2007 model year engines that are greater than 130 KW (175 HP) and not certified, must meet the requirements of paragraphs (a)(1) and (2) of this section.

(1) Submit an initial notification as required in § 60.7(a)(1). The notification must include the information in paragraphs (a)(1)(i) through (v) of this section.

(i) Name and address of the owner or operator;

(ii) The address of the affected source;

(iii) Engine information including make, model, engine family, serial number, model year, maximum engine power, and engine displacement;

(iv) Emission control equipment; and

(v) Fuel used.

(2) Keep records of the information in paragraphs (a)(2)(i) through (iv) of this section.

(i) All notifications submitted to comply with this subpart and all documentation supporting any notification.

(ii) Maintenance conducted on the engine.

(iii) If the stationary CI internal combustion is a certified engine, documentation from the manufacturer that the engine is certified to meet the emission standards.

(iv) If the stationary CI internal combustion is not a certified engine, documentation that the engine meets the emission standards.

(b) If the stationary CI internal combustion engine is an emergency stationary internal combustion engine, the owner or operator is not required to submit an initial notification. Starting with the model years in table 5 to this subpart, if the emergency engine does not meet the standards applicable to non-emergency engines in the applicable model year, the owner or operator must keep records of the operation of the engine in emergency and non-emergency service that are recorded through the non-resettable hour meter. The owner must record the time of operation of the engine and the reason the engine was in operation during that time.

(c) If the stationary CI internal combustion engine is equipped with a diesel particulate filter, the owner or operator must keep records of any corrective action taken after the backpressure monitor has notified the owner or operator that the high backpressure limit of the engine is approached.

(d) If you own or operate an emergency stationary CI ICE with a maximum engine power more than 100 HP that operates or is contractually obligated to be available for more than 15 hours per calendar year for the purposes specified in § 60.4211(f)(2)(ii) and (iii) or that operates for the purposes specified in § 60.4211(f)(3)(i), you must submit an annual report according to the requirements in paragraphs (d)(1) through (3) of this section.

(1) The report must contain the following information:

(i) Company name and address where the engine is located.

(ii) Date of the report and beginning and ending dates of the reporting period.

(iii) Engine site rating and model year.

(iv) Latitude and longitude of the engine in decimal degrees reported to the fifth decimal place.

(v) Hours operated for the purposes specified in § 60.4211(f)(2)(ii) and (iii), including the date, start time, and end time for engine operation for the purposes specified in § 60.4211(f)(2)(ii) and (iii).

(vi) Number of hours the engine is contractually obligated to be available for the purposes specified in § 60.4211(f)(2)(ii) and (iii).

(vii) Hours spent for operation for the purposes specified in § 60.4211(f)(3)(i), including the date, start time, and end time for engine operation for the purposes specified in § 60.4211(f)(3)(i). The report must also identify the entity that dispatched the engine and the situation that necessitated the dispatch of the engine.

(2) The first annual report must cover the calendar year 2015 and must be submitted no later than March 31, 2016. Subsequent annual reports for each calendar year must be submitted no later than March 31 of the following calendar year.

(3) The annual report must be submitted electronically using the subpart specific reporting form in the Compliance and Emissions Data Reporting Interface (CEDRI) that is accessed through EPA's Central Data Exchange (CDX) (www.epa.gov/cdx). However, if the reporting form specific to this subpart is not available in CEDRI at the time that the report is due, the written report must be submitted to the Administrator at the appropriate address listed in § 60.4.

[71 FR 39172, July 11, 2006, as amended at 78 FR 6696, Jan. 30, 2013]

Special Requirements

§ 60.4215 What requirements must I meet for engines used in Guam, American Samoa, or the Commonwealth of the Northern Mariana Islands?

(a) Stationary CI ICE with a displacement of less than 30 liters per cylinder that are used in Guam, American Samoa, or the Commonwealth of the Northern Mariana Islands are required to meet the applicable emission standards in §§ 60.4202 and 60.4205.

(b) Stationary CI ICE that are used in Guam, American Samoa, or the Commonwealth of the Northern Mariana Islands are not required to meet the fuel requirements in § 60.4207.

(c) Stationary CI ICE with a displacement of greater than or equal to 30 liters per cylinder that are used in Guam, American Samoa, or the Commonwealth of the Northern Mariana Islands are required to meet the following emission standards:

(1) For engines installed prior to January 1, 2012, limit the emissions of NO_x in the stationary CI internal combustion engine exhaust to the following:

(i) 17.0 g/KW-hr (12.7 g/HP-hr) when maximum engine speed is less than 130 rpm;

(ii) $45 \cdot n^{-0.2}$ g/KW-hr ($34 \cdot n^{-0.2}$ g/HP-hr) when maximum engine speed is 130 or more but less than 2,000 rpm, where n is maximum engine speed; and

(iii) 9.8 g/KW-hr (7.3 g/HP-hr) when maximum engine speed is 2,000 rpm or more.

(2) For engines installed on or after January 1, 2012, limit the emissions of NO_x in the stationary CI internal combustion engine exhaust to the following:

(i) 14.4 g/KW-hr (10.7 g/HP-hr) when maximum engine speed is less than 130 rpm;

(ii) $44 \cdot n^{-0.23}$ g/KW-hr ($33 \cdot n^{-0.23}$ g/HP-hr) when maximum engine speed is greater than or equal to 130 but less than 2,000 rpm and where n is maximum engine speed; and

(iii) 7.7 g/KW-hr (5.7 g/HP-hr) when maximum engine speed is greater than or equal to 2,000 rpm.

(3) Limit the emissions of PM in the stationary CI internal combustion engine exhaust to 0.40 g/KW-hr (0.30 g/HP-hr).

[71 FR 39172, July 11, 2006, as amended at 76 FR 37971, June 28, 2011]

§ 60.4216 What requirements must I meet for engines used in Alaska?

(a) Prior to December 1, 2010, owners and operators of stationary CI ICE with a displacement of less than 30 liters per cylinder located in areas of Alaska not accessible by the FAHS should refer to 40 CFR part 69 to determine the diesel fuel requirements applicable to such engines.

(b) Except as indicated in paragraph (c) of this section, manufacturers, owners and operators of stationary CI ICE with a displacement of less than 10 liters per cylinder located in areas of Alaska not accessible by the FAHS may meet the requirements of this subpart by manufacturing and installing engines meeting the requirements of 40 CFR parts 94 or 1042, as appropriate, rather than the otherwise applicable requirements of 40 CFR parts 89 and 1039, as indicated in sections §§ 60.4201 (f) and 60.4202(g) of this subpart.

(c) Manufacturers, owners and operators of stationary CI ICE that are located in areas of Alaska not accessible by the FAHS may choose to meet the applicable emission standards for emergency engines in § 60.4202 and § 60.4205, and not those for non-emergency engines in § 60.4201 and § 60.4204, except that for 2014 model year and later non-emergency CI ICE, the owner or operator of any such engine that was not certified as meeting Tier 4 PM standards, must meet the applicable requirements for PM in § 60.4201 and § 60.4204 or install a PM emission control device that achieves PM emission reductions of 85 percent, or 60 percent for engines with a displacement of greater than or equal to 30 liters per cylinder, compared to engine-out emissions.

(d) The provisions of § 60.4207 do not apply to owners and operators of pre-2014 model year stationary CI ICE subject to this subpart that are located in areas of Alaska not accessible by the FAHS.

(e) The provisions of § 60.4208(a) do not apply to owners and operators of stationary CI ICE subject to this subpart that are located in areas of Alaska not accessible by the FAHS until after December 31, 2009.

(f) The provisions of this section and § 60.4207 do not prevent owners and operators of stationary CI ICE subject to this subpart that are located in areas of Alaska not accessible by the FAHS from using fuels mixed with used lubricating oil, in volumes of up to 1.75 percent of the total fuel. The sulfur content of the used lubricating oil must be less than 200 parts per million. The used lubricating oil must meet the on-specification levels and properties for used oil in 40 CFR 279.11.

[76 FR 37971, June 28, 2011]

§ 60.4217 What emission standards must I meet if I am an owner or operator of a stationary internal combustion engine using special fuels?

Owners and operators of stationary CI ICE that do not use diesel fuel may petition the Administrator for approval of alternative emission standards, if they can demonstrate that they use a fuel that is not the fuel on which the manufacturer of the engine certified the engine and that the engine cannot meet the applicable standards required in § 60.4204 or § 60.4205 using such fuels and that use of such fuel is appropriate and reasonably necessary, considering cost, energy, technical feasibility, human health and environmental, and other factors, for the operation of the engine.

[76 FR 37972, June 28, 2011]

General Provisions

§ 60.4218 What parts of the General Provisions apply to me?

Table 8 to this subpart shows which parts of the General Provisions in §§ 60.1 through 60.19 apply to you.

DEFINITIONS

§ 60.4219 What definitions apply to this subpart?

As used in this subpart, all terms not defined herein shall have the meaning given them in the CAA and in subpart A of this part.

Certified emissions life means the period during which the engine is designed to properly function in terms of reliability and fuel consumption, without being remanufactured, specified as a number of hours of operation or calendar years, whichever comes first. The values for certified emissions life for stationary CI ICE with a displacement of less than 10 liters per cylinder are given in 40 CFR 1039.101 (g). The values for certified emissions life for stationary CI ICE with a displacement of greater than or equal to 10 liters per cylinder and less than 30 liters per cylinder are given in 40 CFR 94.9(a).

Combustion turbine means all equipment, including but not limited to the turbine, the fuel, air, lubrication and exhaust gas systems, control systems (except emissions control equipment), and any ancillary components and sub-components comprising any simple cycle combustion turbine, any regenerative/recuperative cycle combustion turbine, the combustion turbine portion of any cogeneration cycle combustion system, or the combustion turbine portion of any combined cycle steam/electric generating system.

Compression ignition means relating to a type of stationary internal combustion engine that is not a spark ignition engine.

Date of manufacture means one of the following things:

(1) For freshly manufactured engines and modified engines, date of manufacture means the date the engine is originally produced.

(2) For reconstructed engines, date of manufacture means the date the engine was originally produced, except as specified in paragraph (3) of this definition.

(3) Reconstructed engines are assigned a new date of manufacture if the fixed capital cost of the new and refurbished components exceeds 75 percent of the fixed capital cost of a comparable entirely new facility. An engine that is produced from a previously used engine block does not retain the date of manufacture of the engine in which the engine block was previously used if the engine is produced using all new components except for the engine block. In these cases, the date of manufacture is the date of reconstruction or the date the new engine is produced.

Diesel fuel means any liquid obtained from the distillation of petroleum with a boiling point of approximately 150 to 360 degrees Celsius. One commonly used form is number 2 distillate oil.

Diesel particulate filter means an emission control technology that reduces PM emissions by trapping the particles in a flow filter substrate and periodically removes the collected particles by either physical action or by oxidizing (burning off) the particles in a process called regeneration.

Emergency stationary internal combustion engine means any stationary reciprocating internal combustion engine that meets all of the criteria in paragraphs (1) through (3) of this definition. All emergency stationary ICE must comply with the requirements specified in § 60.4211(f) in order to be considered emergency stationary ICE. If the engine does not comply with the requirements specified in § 60.4211(f), then it is not considered to be an emergency stationary ICE under this subpart.

(1) The stationary ICE is operated to provide electrical power or mechanical work during an emergency situation. Examples include stationary ICE used to produce power for critical networks or equipment (including power supplied to portions of a facility) when electric power from the local utility (or the normal power source, if the facility runs on its own power production) is interrupted, or stationary ICE used to pump water in the case of fire or flood, etc.

(2) The stationary ICE is operated under limited circumstances for situations not included in paragraph (1) of this definition, as specified in § 60.4211(f).

(3) The stationary ICE operates as part of a financial arrangement with another entity in situations not included in paragraph (1) of this definition only as allowed in § 60.4211(f)(2)(ii) or (iii) and § 60.4211(f)(3)(i).

Engine manufacturer means the manufacturer of the engine. See the definition of “manufacturer” in this section.

Fire pump engine means an emergency stationary internal combustion engine certified to NFPA requirements that is used to provide power to pump water for fire suppression or protection.

Freshly manufactured engine means an engine that has not been placed into service. An engine becomes freshly manufactured when it is originally produced.

Installed means the engine is placed and secured at the location where it is intended to be operated.

Manufacturer has the meaning given in section 216(1) of the Act. In general, this term includes any person who manufactures a stationary engine for sale in the United States or otherwise introduces a new stationary engine into commerce in the United States. This includes importers who import stationary engines for sale or resale.

Maximum engine power means maximum engine power as defined in 40 CFR 1039.801.

Model year means the calendar year in which an engine is manufactured (see “date of manufacture”), except as follows:

(1) Model year means the annual new model production period of the engine manufacturer in which an engine is manufactured (see “date of manufacture”), if the annual new model production period is different than the calendar year and includes January 1 of the calendar year for which the model year is named. It may not begin before January 2 of the previous calendar year and it must end by December 31 of the named calendar year.

(2) For an engine that is converted to a stationary engine after being placed into service as a nonroad or other non-stationary engine, model year means the calendar year or new model production period in which the engine was manufactured (see “date of manufacture”).

Other internal combustion engine means any internal combustion engine, except combustion turbines, which is not a reciprocating internal combustion engine or rotary internal combustion engine.

Reciprocating internal combustion engine means any internal combustion engine which uses reciprocating motion to convert heat energy into mechanical work.

Rotary internal combustion engine means any internal combustion engine which uses rotary motion to convert heat energy into mechanical work.

Spark ignition means relating to a gasoline, natural gas, or liquefied petroleum gas fueled engine or any other type of engine with a spark plug (or other sparking device) and with operating characteristics significantly similar to the theoretical Otto combustion cycle. Spark ignition engines usually use a throttle to regulate intake air flow to control power during normal operation. Dual-fuel engines in which a liquid fuel (typically diesel fuel) is used for CI and gaseous fuel (typically natural gas) is used as the primary fuel at an annual average ratio of less than 2 parts diesel fuel to 100 parts total fuel on an energy equivalent basis are spark ignition engines.

Stationary internal combustion engine means any internal combustion engine, except combustion turbines, that converts heat energy into mechanical work and is not mobile. Stationary ICE differ from mobile ICE in that a stationary internal combustion engine is not a nonroad engine as defined at 40 CFR 1068.30 (excluding paragraph (2)(ii) of that definition), and is not used to propel a motor vehicle, aircraft, or a vehicle used solely for competition. Stationary ICE include reciprocating ICE, rotary ICE, and other ICE, except combustion turbines.

Subpart means 40 CFR part 60, subpart IIII.

[71 FR 39172, July 11, 2006, as amended at 76 FR 37972, June 28, 2011; 78 FR 6696, Jan. 30, 2013]

Table 1 to Subpart IIII of Part 60—Emission Standards for Stationary Pre-2007 Model Year Engines With a Displacement of <10 Liters per Cylinder and 2007-2010 Model Year Engines >2,237 KW (3,000 HP) and With a Displacement of <10 Liters per Cylinder

[As stated in §§ 60.4201(b), 60.4202(b), 60.4204(a), and 60.4205(a), you must comply with the following emission standards]

Emission standards for stationary pre-2007 model year engines with a displacement of <10 liters per cylinder and 2007-2010 model year engines >2,237 KW (3,000 HP) and with a displacement of <10 liters per cylinder in g/KW-hr (g/HP-hr)					
Maximum engine power	NMHC + NO _x	HC	NO _x	CO	PM
KW<8 (HP<11)	10.5 (7.8)			8.0 (6.0)	1.0 (0.75)
8≤KW<19 (11≤HP<25)	9.5 (7.1)			6.6 (4.9)	0.80 (0.60)
19≤KW<37 (25≤HP<50)	9.5 (7.1)			5.5 (4.1)	0.80 (0.60)
37≤KW<56 (50≤HP<75)			9.2 (6.9)		
			9.2 (6.9)		

56≤KW<75 (75≤HP<100)					
75≤KW<130 (100≤HP<175)			9.2 (6.9)		
130≤KW<225 (175≤HP<300)		1.3 (1.0)	9.2 (6.9)	11.4 (8.5)	0.54 (0.40)
225≤KW<450 (300≤HP<600)		1.3 (1.0)	9.2 (6.9)	11.4 (8.5)	0.54 (0.40)
450≤KW≤560 (600≤HP≤750)		1.3 (1.0)	9.2 (6.9)	11.4 (8.5)	0.54 (0.40)
KW>560 (HP>750)		1.3 (1.0)	9.2 (6.9)	11.4 (8.5)	0.54 (0.40)

Table 2 to Subpart IIII of Part 60—Emission Standards for 2008 Model Year and Later Emergency Stationary CI ICE <37 KW (50 HP) With a Displacement of <10 Liters per Cylinder

[As stated in § 60.4202(a)(1), you must comply with the following emission standards]

Engine power	Emission standards for 2008 model year and later emergency stationary CI ICE <37 KW (50 HP) with a displacement of <10 liters per cylinder in g/KW-hr (g/HP-hr)			
	Model year(s)	NO _x + NMHC	CO	PM
KW<8 (HP<11)	2008+	7.5 (5.6)	8.0 (6.0)	0.40 (0.30)
8≤KW<19 (11≤HP<25)	2008+	7.5 (5.6)	6.6 (4.9)	0.40 (0.30)
19≤KW<37 (25≤HP<50)	2008+	7.5 (5.6)	5.5 (4.1)	0.30 (0.22)

Table 3 to Subpart IIII of Part 60—Certification Requirements for Stationary Fire Pump Engines

As stated in § 60.4202(d), you must certify new stationary fire pump engines beginning with the following model years:

Engine power	Starting model year engine manufacturers must certify new stationary fire pump engines according to § 60.4202(d) ¹
KW<75 (HP<100)	2011
75≤KW<130 (100≤HP<175)	2010
130≤KW≤560 (175≤HP≤750)	2009
KW>560 (HP>750)	2008

¹Manufacturers of fire pump stationary CI ICE with a maximum engine power greater than or equal to 37 kW (50 HP) and less than 450 KW (600 HP) and a rated speed of greater than 2,650 revolutions per minute (rpm) are not required to certify such engines until three model years following the model year indicated in this Table 3 for engines in the applicable engine power category.

[71 FR 39172, July 11, 2006, as amended at 76 FR 37972, June 28, 2011]

Table 4 to Subpart IIII of Part 60—Emission Standards for Stationary Fire Pump Engines

[As stated in §§ 60.4202(d) and 60.4205(c), you must comply with the following emission standards for stationary fire pump engines]

Maximum engine power	Model year(s)	NMHC + NO _x	CO	PM
KW<8 (HP<11)	2010 and earlier	10.5 (7.8)	8.0 (6.0)	1.0 (0.75)
	2011+	7.5 (5.6)		0.40 (0.30)
8≤KW<19 (11≤HP<25)	2010 and earlier	9.5 (7.1)	6.6 (4.9)	0.80 (0.60)
	2011+	7.5 (5.6)		0.40 (0.30)
19≤KW<37 (25≤HP<50)	2010 and earlier	9.5 (7.1)	5.5 (4.1)	0.80 (0.60)
	2011+	7.5 (5.6)		0.30 (0.22)
37≤KW<56 (50≤HP<75)	2010 and earlier	10.5 (7.8)	5.0 (3.7)	0.80 (0.60)
	2011+ ¹	4.7 (3.5)		0.40 (0.30)
56≤KW<75 (75≤HP<100)	2010 and earlier	10.5 (7.8)	5.0 (3.7)	0.80 (0.60)
	2011+ ¹	4.7 (3.5)		0.40 (0.30)
75≤KW<130 (100≤HP<175)	2009 and earlier	10.5 (7.8)	5.0 (3.7)	0.80 (0.60)
	2010+ ²	4.0 (3.0)		0.30 (0.22)
130≤KW<225 (175≤HP<300)	2008 and earlier	10.5 (7.8)	3.5 (2.6)	0.54 (0.40)
	2009+ ³	4.0 (3.0)		0.20 (0.15)
225≤KW<450 (300≤HP<600)	2008 and earlier	10.5 (7.8)	3.5 (2.6)	0.54 (0.40)
	2009+ ³	4.0 (3.0)		0.20 (0.15)
450≤KW≤560 (600≤HP≤750)	2008 and earlier	10.5 (7.8)	3.5 (2.6)	0.54 (0.40)
	2009+	4.0 (3.0)		0.20 (0.15)
KW>560 (HP>750)	2007 and earlier	10.5 (7.8)	3.5 (2.6)	0.54 (0.40)
	2008+	6.4 (4.8)		0.20 (0.15)

¹ For model years 2011-2013, manufacturers, owners and operators of fire pump stationary CI ICE in this engine power category with a rated speed of greater than 2,650 revolutions per minute (rpm) may comply with the emission limitations for 2010 model year engines.

² For model years 2010-2012, manufacturers, owners and operators of fire pump stationary CI ICE in this engine power category with a rated speed of greater than 2,650 rpm may comply with the emission limitations for 2009 model year engines.

³ In model years 2009-2011, manufacturers of fire pump stationary CI ICE in this engine power category with a rated speed of greater than 2,650 rpm may comply with the emission limitations for 2008 model year engines.

Table 5 to Subpart IIII of Part 60—Labeling and Recordkeeping Requirements for New Stationary Emergency Engines

[You must comply with the labeling requirements in § 60.4210(f) and the recordkeeping requirements in § 60.4214(b) for new emergency stationary CI ICE beginning in the following model years:]

Engine power	Starting model year
19≤KW<56 (25≤HP<75)	2013
56≤KW<130 (75≤HP<175)	2012
KW≥130 (HP≥175)	2011

Table 6 to Subpart IIII of Part 60—Optional 3-Mode Test Cycle for Stationary Fire Pump Engines

[As stated in § 60.4210(g), manufacturers of fire pump engines may use the following test cycle for testing fire pump engines:]

Mode No.	Engine speed ¹	Torque (percent) ²	Weighting factors
1	Rated	100	0.30
2	Rated	75	0.50
3	Rated	50	0.20

¹ Engine speed: ±2 percent of point.

² Torque: NFPA certified nameplate HP for 100 percent point. All points should be ±2 percent of engine percent load value.

Table 7 to Subpart IIII of Part 60—Requirements for Performance Tests for Stationary CI ICE With a Displacement of ≥30 Liters per Cylinder

[As stated in § 60.4213, you must comply with the following requirements for performance tests for stationary CI ICE with a displacement of ≥30 liters per cylinder:]

For each	Complying with the requirement to	You must	Using	According to the following requirements
1. Stationary CI internal combustion engine with a displacement of ≥30 liters per cylinder	a. Reduce NO _x emissions by 90 percent or more	i. Select the sampling port location and the number of traverse points;	(1) Method 1 or 1A of 40 CFR part 60, appendix A	(a) Sampling sites must be located at the inlet and outlet of the control device.
		ii. Measure O ₂ at the inlet and outlet of the control device;	(2) Method 3, 3A, or 3B of 40 CFR part 60, appendix A	(b) Measurements to determine O ₂ concentration must be made at the same time as the measurements for NO _x concentration.
		iii. If necessary, measure moisture content at the inlet and outlet of the control device; and,	(3) Method 4 of 40 CFR part 60, appendix A, Method 320 of 40 CFR part 63, appendix A, or ASTM D 6348-03 (incorporated by reference, see § 60.17)	(c) Measurements to determine moisture content must be made at the same time as the measurements for NO _x concentration.
		iv. Measure NO _x at the inlet and outlet of the control device	(4) Method 7E of 40 CFR part 60, appendix A, Method 320 of 40 CFR part 63, appendix A, or ASTM D 6348-03	(d) NO _x concentration must be at 15 percent O ₂ , dry basis. Results of this test consist of the average of the three 1-hour or longer runs.

			(incorporated by reference, see § 60.17)	
	b. Limit the concentration of NO _x in the stationary CI internal combustion engine exhaust.	i. Select the sampling port location and the number of traverse points;	(1) Method 1 or 1A of 40 CFR part 60, appendix A	(a) If using a control device, the sampling site must be located at the outlet of the control device.
		ii. Determine the O ₂ concentration of the stationary internal combustion engine exhaust at the sampling port location; and,	(2) Method 3, 3A, or 3B of 40 CFR part 60, appendix A	(b) Measurements to determine O ₂ concentration must be made at the same time as the measurement for NO _x concentration.
		iii. If necessary, measure moisture content of the stationary internal combustion engine exhaust at the sampling port location; and,	(3) Method 4 of 40 CFR part 60, appendix A, Method 320 of 40 CFR part 63, appendix A, or ASTM D 6348-03 (incorporated by reference, see § 60.17)	(c) Measurements to determine moisture content must be made at the same time as the measurement for NO _x concentration.
		iv. Measure NO _x at the exhaust of the stationary internal combustion engine	(4) Method 7E of 40 CFR part 60, appendix A, Method 320 of 40 CFR part 63, appendix A, or ASTM D 6348-03 (incorporated by reference, see § 60.17)	(d) NO _x concentration must be at 15 percent O ₂ , dry basis. Results of this test consist of the average of the three 1-hour or longer runs.
	c. Reduce PM emissions by 60 percent or more	i. Select the sampling port location and the number of traverse points;	(1) Method 1 or 1A of 40 CFR part 60, appendix A	(a) Sampling sites must be located at the inlet and outlet of the control device.
		ii. Measure O ₂ at the inlet and outlet of the control device;	(2) Method 3, 3A, or 3B of 40 CFR part 60, appendix A	(b) Measurements to determine O ₂ concentration must be made at the same time as the measurements for PM concentration.
		iii. If necessary, measure moisture content at the inlet and outlet of the control device; and	(3) Method 4 of 40 CFR part 60, appendix A	(c) Measurements to determine and moisture content must be made at the same time as the measurements for PM concentration.

		iv. Measure PM at the inlet and outlet of the control device	(4) Method 5 of 40 CFR part 60, appendix A	(d) PM concentration must be at 15 percent O ₂ , dry basis. Results of this test consist of the average of the three 1-hour or longer runs.
	d. Limit the concentration of PM in the stationary CI internal combustion engine exhaust	i. Select the sampling port location and the number of traverse points;	(1) Method 1 or 1A of 40 CFR part 60, appendix A	(a) If using a control device, the sampling site must be located at the outlet of the control device.
		ii. Determine the O ₂ concentration of the stationary internal combustion engine exhaust at the sampling port location; and	(2) Method 3, 3A, or 3B of 40 CFR part 60, appendix A	(b) Measurements to determine O ₂ concentration must be made at the same time as the measurements for PM concentration.
		iii. If necessary, measure moisture content of the stationary internal combustion engine exhaust at the sampling port location; and	(3) Method 4 of 40 CFR part 60, appendix A	(c) Measurements to determine moisture content must be made at the same time as the measurements for PM concentration.
		iv. Measure PM at the exhaust of the stationary internal combustion engine	(4) Method 5 of 40 CFR part 60, appendix A	(d) PM concentration must be at 15 percent O ₂ , dry basis. Results of this test consist of the average of the three 1-hour or longer runs.

Table 8 to Subpart IIII of Part 60—Applicability of General Provisions to Subpart IIII

[As stated in § 60.4218, you must comply with the following applicable General Provisions:]

General Provisions citation	Subject of citation	Applies to subpart	Explanation
§ 60.1	General applicability of the General Provisions	Yes	
§ 60.2	Definitions	Yes	Additional terms defined in § 60.4219.
§ 60.3	Units and abbreviations	Yes	
§ 60.4	Address	Yes	
§ 60.5	Determination of construction or modification	Yes	
§ 60.6	Review of plans	Yes	
§ 60.7	Notification and Recordkeeping	Yes	Except that § 60.7 only applies as specified in § 60.4214(a).
§ 60.8	Performance tests	Yes	

			Except that § 60.8 only applies to stationary CI ICE with a displacement of (≥30 liters per cylinder and engines that are not certified.
§ 60.9	Availability of information	Yes	
§ 60.10	State Authority	Yes	
§ 60.11	Compliance with standards and maintenance requirements	No	Requirements are specified in subpart IIII.
§ 60.12	Circumvention	Yes	
§ 60.13	Monitoring requirements	Yes	Except that § 60.13 only applies to stationary CI ICE with a displacement of (≥30 liters per cylinder.
§ 60.14	Modification	Yes	
§ 60.15	Reconstruction	Yes	
§ 60.16	Priority list	Yes	
§ 60.17	Incorporations by reference	Yes	
§ 60.18	General control device requirements	No	
§ 60.19	General notification and reporting requirements	Yes	

For questions or comments regarding e-CFR editorial content, features, or design, email ecfr@nara.gov.

For questions concerning e-CFR programming and delivery issues, email webteam@gpo.gov.

Appendix P - Notification of Compliance for SN-01

Hazardous Waste Combustor
NOTIFICATION OF COMPLIANCE

For the

Clean Harbors El Dorado Facility
Phase I Incinerator
and
Phase II Waste Fired Boiler

Clean Harbors El Dorado, LLC
309 American Way
El Dorado, Arkansas 71730

February 17, 2012

Version 0.0

TABLE OF CONTENTS

	Page
<u>1.0 Introduction</u>	1
<u>2.0 Emissions Standards and Operating Limit Basis</u>	2
<u>3.0 Engineering Description</u>	12
<u>4.0 Final Operating Limits</u>	19
<u>5.0 Certification Statement</u>	33

Attachments

Attachment 1 – Residence time calculations

1.0 Notification of Compliance Introduction

Clean Harbors El Dorado, LLC (Clean Harbors) owns and operates a hazardous waste incineration and disposal complex located in El Dorado, Arkansas. Clean Harbors treats hazardous and non regulated wastes in an incineration system with two kilns, a secondary combustion chamber (SCC) and a waste fired boiler (WFB). The facility operates under an Arkansas Department of Environmental Quality (ADEQ) Title V Air Permit (No 1009-AOP-R9) and an Industrial Hazardous Waste Permit NO 10H-RN1.

Clean Harbors, EPA ID ARD069748192, has proven the performance of its incineration and waste fired boiler equipment to meet the final MACT Combustion Rule standards (*40 CFR 63 Subpart EEE*). This notification of compliance (NOC) was developed to certify compliance with the applicable emission standards of *40 CFR 63.1219(a)* and *40 CFR 63.1217(a)*. This notification was prepared for and is submitted to USEPA Region 6 and ADEQ in accordance with *40 CFR 63.1207(j)(5)*.

This NOC is maintained in the facility operating record as specified in the Final Standards for Hazardous Air Pollutants for Waste Combustors. The compliance date for meeting the final emission standards is October 14, 2008 as specified at *40 CFR 63.1206 (a)(1)(ii)*. The operating limits established in this NOC are based on the results of the Comprehensive Performance Test (CPT) performed in October and November of 2011. The 2011 Comprehensive Performance Tests demonstrated compliance with the final emissions standards of *40 CFR 63.1219(a)* for existing Hazardous Waste Incinerators and *40 CFR 63.1217(a)* liquid fired boilers burning waste that is 10,000 BTU/lb or greater.

The CPT was performed in accordance with the approved CPT Plan dated October 7, 2011 revision 4.0 and the approved QAPP dated October 7, 2011 revision 2.0

This NOC is being submitted to USEPA Region 6 and ADEQ with the final CPT Report (February 17 2011) for the Comprehensive Performance Test that was performed in October and November 2011. Clean Harbors requests that the agency review the final CPT Report and this NOC, and issue a finding of compliance.

2.0 Emission Standards and Operating Limits

This NOC was developed to certify compliance with the applicable emission standards of *40 CFR 63.1219(a)*, MACT standards for existing hazardous waste incinerators, and *40 CFR 63.1217(a)*, MACT standards for existing liquid waste fired boilers, firing waste that is 10,000 BTU or greater. The operating parameter limits specified in this NOC were identified to ensure compliance with the emission standards, based on actual test data.

2.1 Emission Standards - Hazardous Waste Incinerators

40 CFR 63.1219(a)

The specific emission standards for this NOC are listed below. All concentration limits are specified as corrected to seven percent oxygen (7% O₂).

- 99.99 percent Destruction and Removal Efficiency (DRE)
- Control of dioxin/furan emissions to a concentration less than 0.40 nanograms toxic equivalent quotient per dry standard cubic meter (ng TEQ/dscm)
- Control of mercury emissions to a concentration less than or equal to 130 micrograms per dry standard cubic meter (ug/dscm) at maximum Hg feed rate
- Control of semi-volatile metal (SVM - cadmium and lead) emissions to a concentration less than or equal to 230 ug/dscm at maximum SVM feed rates
- Control of low-volatility metal (LVM - arsenic, beryllium, and chromium) emissions to a concentration less than or equal to 92 ug/dscm at maximum LVM feed rates
- Control of carbon monoxide (CO) emissions to a concentration less than 100 ppmv (dry) or total hydrocarbon (THC) less than 10 ppmv – Clean Harbors has demonstrated compliance with both and has elected to use CO as the control parameter. *40 CFR 63.1219(a)(5)(ii)*.
- Control of hydrogen chloride/chlorine emissions to a concentration less than or equal to 32 ppmv (as HCl) at maximum chlorine feed rates
- Control of particulate emissions to less than or equal to 0.013 grains per dry standard cubic foot (gr/dscf) at maximum ash feed rates

Table 2-1. Phase I Final Replacement Standards for Existing Incinerators

Parameter	Units ¹	Emission Standard
Dioxins and furans	ng TEQ/dscm	0.40
Mercury	µg/dscm	130
Semivolatile metals	µg/dscm	230
Low volatile metals	µg/dscm	92
Hydrogen chloride and chlorine	ppmv (dry)	32
Particulate matter	gr/dscf	0.013
Carbon monoxide	ppmv (dry)	100
Hydrocarbons ²	ppmv (dry)	10
Destruction and removal efficiency	%	99.99

¹ Emission standards corrected to seven percent oxygen.

² Compliance with the HC standard is demonstrated during the DRE performance test.

2.2 Emission Standards - Liquid Waste Fired Boilers

40 CFR 63.1217(a)

During discussions with USEPA Region 6, it was determined that the WFB may meet the definition of a boiler as defined in 40 CFR § 260.10. As such, the WFB would be subject to the HWC NESHAP Phase II standards for liquid fuel boilers that burn hazardous waste at facilities that are a major source of HAPs. Historically, the as-fired heating value of the liquid wastes burned in the WFB have varied above and below 10,000 British thermal units per pound (BTU/lb). Therefore, the WFB would be subject to either the concentration-based standards or the thermal-based standards for metals and chlorine depending upon the heating value of the waste. Clean Harbors has elected to restrict the waste feed to the WFB to blended waste with greater than 10,000 BTU/lb. This simplifies compliance with the Phase II standards as only one set of standards apply. The Phase II emission standards are summarized in Table 2-2 and are described below:

- DRE of 99.99 percent
- Control of dioxin/furan emissions to a concentration less than 0.40 nanograms toxic equivalent quotient per dry standard cubic meter (ng TEQ/dscm) (40 CFR § 63.1217(a)(1)(ii)) or compliance with the CO and HC emission standards of 40 CFR § 63.1217(a)(5) to demonstrate compliance with the D/F emission standard for boilers not equipped with a dry air pollution control system per 40 CFR § 63.1217(a)(1)(ii). Clean Harbors has elected to use CO in the boiler flue gas exit duct for compliance with the dioxins and furans requirement. In accordance with 40 CFR § 63.1217(a)(1)(iii), a source equipped with a wet air pollution control system followed by a dry air pollution control system is not considered to be a dry air pollution control system.
- Control of carbon monoxide (CO) emissions to a concentration less than 100 ppmv (dry) over an hourly rolling average or total hydrocarbon (THC) less than 10 ppmv over a hourly rolling average, dry basis, corrected to seven percent oxygen, and reported as

propane. Clean Harbors has demonstrated compliance with both and has elected to use CO as the control parameter, in accordance with 40 CFR § 63.1217(a)(5)(i).

- Control of mercury emissions from a boiler, when the as-fired heating value of the waste feed is 10,000 Btu/lb or greater, to no greater than 4.2E-05 pounds of pollutant attributed to the hazardous waste per million British thermal units heat input from the hazardous waste (lb/MMBtu).
- Control of SVM emissions from a boiler, when the as-fired heating value of the waste feed is 10,000 Btu/lb or greater, to no greater than 8.2E-05 lb/MMBtu.
- Control of chromium emissions from a boiler, when the as-fired heating value of the waste feed is 10,000 Btu/lb or greater, to no greater than 1.3E-04 lb/MMBtu.
- Control of chlorine emissions from a boiler, when the as-fired heating value of the waste feed is 10,000 Btu/lb or greater, to no greater than 5.1E-02 lb/MMBtu.
- Control of particulate emissions to no greater than 80 milligrams per dry standard cubic meter corrected to 7% oxygen.

Table 2-2. Phase II Emission Standards for Existing Liquid Fuel Boilers

Parameter	Units ¹	Emission Standard (≥ 10,000 Btu/lb)
Dioxins and furans	na	Compliance with the CO and HC emission standards
Mercury	lb/ MMBTU	4.2E-05 lb/MMBtu
Semivolatile metals	lb/ MMBTU	8.2E-05 lb/MMBtu
Chromium	lb/ MMBTU	1.3E-04 lb/MMBtu
Hydrogen chloride and chlorine	lb/ MMBTU	5.1E-02 lb/MMBtu
Particulate matter	mg/dscm	80 ¹
Carbon monoxide ²	ppmv (dry)	100 ppmv-
Hydrocarbons ²	ppmv (dry)	10 ppmv
Destruction and removal efficiency	%	99.99

¹Emission standards corrected to seven percent oxygen. WFB will only fire waste ≥10,000 Btu/lb.

²A CO CEMS has been installed in the flue gas exit duct from the WFB to monitor CO from the WFB on a continuous basis . Compliance with the HC standard was demonstrated during the DRE performance

2.2 Emission Results from 2011 CPT – Compliance with Final Emission Standards

Table 2-3 shows the emissions results obtained from the 2011 CPT. These data confirm Clean Harbors incinerator and WFB compliance with the final MACT emissions standard for existing incinerators and liquid fired boilers burning waste with 10,000 BTU/lb or greater.

The CO and HC emissions standards and the DRE standard are the same for both subcategories. The CPT was designed to demonstrate CO and HC emissions and DRE in both combustion systems simultaneously. CO and HC was monitored in both the exit gas (flue gas) from the WFB and in the stack gas. DRE was measured for the incinerator and WFB separately by feeding two different Principal Organic Hazardous Constituents (POHC), one to the incinerator and one to the WFB, and determining the concentration for each POHC in the stack.

The specific D/F emission standard is only applicable to the Phase I incinerator unit. However, in accordance with 40 CFR § 63.1207(b)(3), a one-time D/F test is required for Phase II sources that are not subject to a numerical D/F emission standard. The HWC NESHAP requires that this one-time test be conducted “under feed and operating conditions that are most likely to reflect daily maximum operating variability.” D/F emissions were demonstrated for the WFB in combination with the incineration system during two conditions of the CPT. These conditions reflected the daily maximum operating variability of the WFB (one condition with the WFB at maximum feed rate and one condition with the WFB at minimum temperature) and satisfy the requirements for the one-time D/F test.

For the metals and chlorine standards, Clean Harbors used a calculation methodology with demonstrated system removal efficiencies (SRE) to develop thermal based (lbs/MMBTU) OPLs for the WFB. CPT emission demonstrations for mercury, SVM, chromium, and HCl/Cl₂ were performed while operating the kilns, SCC, and WFB simultaneously. Pollutant feed rates and emission rates were used to calculate system removal efficiencies. The system removal efficiencies and WFB flue gas flow rate (calculated based on WFB combustion air flow rate) were used with the Phase II emission standards or the Phase I standards if more stringent to calculate feed rate OPLs for the WFB. The calculation methodology, developed in cooperation with USEPA Region 6, was described in detail in the CPT Plan, and was reviewed and approved by USEPA Region 6.

The Phase I PM emission standard is much more stringent than the Phase II emission standard. Therefore, Clean Harbors demonstrated compliance with the Phase I emission standard for the entire incineration system, including the WFB. A separate ash feed rate OPL was established for the WFB based on a separate set of tests where ash was spiked directly into the WFB feed line while the WFB was operating at maximum feed rate.

Table 2-3 - Summary of 2011 CPT Emission Results

Parameter	Units	MACT Limit	CPT Results	Test Condition
Incinerator DRE	%	99.99	>99.9995	1
			>99.9990	2
WFB DRE	%	99.99	>99.9985	2R
			>99.9989	3
Dioxins and Furans	ng TEQ/ dscm	0.40	0.0003	1
			0.0005	2
			0.0003	3
Main Stack Carbon Monoxide (CO)	ppmvd	100	6.55	1
			14.89	2
			4.03	2R
			5.63	3
Main Stack Total Hydrocarbons (THC)	as propane, ppmvd	10	1.38	1
			<0.07	2
			0.31	2R
			0.76	3
WFB Flue Gas Carbon Monoxide (CO)	ppmvd	100	1.47	2R
			0.87	3
WFB Flue Gas Total Hydrocarbons (THC)	as propane, ppmvd	10	0.74	2R
			0.21	3
Mercury	ug/dscm	130 ⁽¹⁾	<1.89	2
Semi-Volatile Metals (SVM)	ug/dscm	230 ⁽¹⁾	<5.59	2
Low Volatility Metals (LVM)	ug/dscm	92 ⁽¹⁾	<11.0	2
Total Chlorine - Hydrogen Chloride and Chlorine	HCl equivalent, ppmvd	32 ⁽¹⁾	<0.54	2
Total System Ash Feed Particulate Matter (PM)	gr/dscf	0.013	0.0024	1
WFB Ash Feed Test Particulate Matter (PM)	gr/dscf	0.013 ⁽²⁾	0.0012 ⁽²⁾	3
	mg/dscm	28	2.6	

Data are corrected to 7% O₂ basis as required by the MACT Standard.

- (1) Metals and chlorine boiler standards are a thermal based feed rate standard (lb/MMBTU). The feed rate OPLs for the boiler are set based on calculations using SRE for the APC system and 80% of the boiler thermal standard as required by USEPA Region 6.
- (2) The Phase I incinerator PM standard of 28 mg/dscm is more stringent than the Phase II boiler standard. As agreed to with USEPA Region 6, the more stringent standard applies.

2.3 Operating Parameter Limits [40 CFR 63.1209(p) through (o)]

The required operating parameter limits to ensure compliance with the emission standards are established within this document. The Hazardous Waste Combustor regulations limit key Hazardous Air Pollutant (HAP) emissions and detail how those emissions are controlled by the various systems inherent to the incinerator and WFB.

The MACT standard [40 CFR 63.1209(j) through (p)] specifies operating parameters for each control system that must be tracked by the Continuous Monitoring System (CMS). Specific control of these parameters yields compliance with the MACT emissions limits. The parameters relevant to the above unit operations were established by completion of the Comprehensive Performance Test (CPT).

Part of the CPT planning process is to review and determine the appropriate OPLs that apply for a specific configuration of equipment. Clean Harbors and USEPA Region 6 determined the OPLs for the Phase I incinerator and Phase II WFB as part of the development and approval process for the CPT Plan. The CPT Plan provides a detailed discussion of the various OPLs and additional regulatory information. The OPLs that are established as part of this CPT are summarized in Table 2-4. The OPLs are established as hourly rolling averages (HRAs) or 12-hour rolling averages (12-hr RAs) in accordance with *Subpart EEE* requirements. Table 2-4 also shows the test Condition or Conditions that are used for establishing the OPLs. When an OPL applies to multiple Conditions and/or emission parameters, the most conservative OPL from the various test runs is used to set the OPL. If an OPL is a maximum limit, then the lowest average value from the applicable Conditions is used, and conversely if the OPL is a minimum value, the highest average value from the applicable conditions is selected. As example, the high energy scrubber flow rate is a minimum OPL that applies to PM, metals, and chlorine. PM was tested during Condition 1 and 3 and the metals/chlorine were tested during Condition 2. Therefore, the highest average flow rate from the three Conditions was selected as the OPL for high energy scrubber flow rate.

Table 2-4 presents the averages for the three runs from each CPT, which serve as the basis for establishing the MACT operating parameter limits (OPLs) related to feed rate control and specific operating conditions. The MACT operating limits established from these test data are shown in the table along with the monitoring basis and monitoring devices used at the facility. Table 2-4 also shows which parameters are controlled by an Automatic Waste Feed Cutoff (AWFCO). Each MACT limit is discussed and presented individually in Section 4 of this Notice of Compliance. All of the results for all test Conditions and test runs are detailed in the CPT Report, February 2012. These data are the basis for the averages shown in Table 2-4.

Table 2-4 Summary of Operating Conditions and Waste Feed Rates - OPLs						
OPERATING PARAMETER	UNITS	AVERAGING PERIOD	FINAL OPERATING LIMIT	BASIS FOR LIMIT 2011 CPT CONDITION THAT SET OPL	AUTOMATIC WASTE FEED CUTOFF	
Kiln No. 1 combustion chamber temperature	°F	Min HRA	861	Condition 2	Y	
Kiln No. 2 combustion chamber temperature	°F	Min HRA	875	Condition 2	Y	
Secondary combustion chamber temperature	°F	Min HRA	1,851	Highest Temp Conditions 1, 2	Y	
Waste fired boiler combustion chamber temperature	°F	Min HRA	1,856	Condition 2, 2R	Y	
Stack gas flow rate	acfm	Max HRA	100,568	Lowest Flow Conditions 1, 2, 3	Y	
Waste fired boiler combustion air flow rate	acfm	Max HRA	8,630	Lowest Flow Condition 2, 2R, 3	Y	
Total hazardous waste feed rate to Kiln No. 1	lbs/hr	Max HRA	13,383	Condition 1	Y	
Pumpable hazardous waste feed rate to Kiln No. 1	lbs/hr	Max HRA	5,005	Condition 1	Y	
Total hazardous waste feed rate to Kiln No. 2	lbs/hr	Max HRA	30,168	Condition 1	Y	
Pumpable hazardous waste feed rate to Kiln No. 2	lbs/hr	Max HRA	9,527	Condition 1	Y	
Total hazardous waste feed rate to the secondary combustion chamber	lbs/hr	Max HRA	13,601	Condition 2	Y	
Total hazardous waste feed rate to the entire incineration system (kiln1, kiln2, SCC)	lbs/hr	Max HRA	50,505	Condition 1	Y	
Total hazardous waste feed rate to the waste fired boiler	lbs/hr	Max HRA	3,873	Condition 3	Y	
Total system mercury feed rate	lbs/hr	Max 12-hr RA	0.46 ⁽¹⁾	Condition 2	Y	

Table 2-4 Summary of Operating Conditions and Waste Feed Rates - OPLs

OPERATING PARAMETER	UNITS	AVERAGING PERIOD	FINAL OPERATING LIMIT	BASIS FOR LIMIT 2011 CPT CONDITION THAT SET OPL	AUTOMATIC WASTE FEED CUTOFF
Mercury thermal input to the waste fired boiler	lbs/ MMBTU	Max12-hr RA	0.187 ⁽¹⁾	Condition 2	Y
Total system ash feed rate	lbs/hr	Max12-hr RA	12,642	Condition 1	Y
Ash Feed Rate to WFB	lbs/hr	Max12-hr RA	164.2	Condition 3	Y
Total system semivolatile metals feed rate	lbs/hr	Max12-hr RA	116 ⁽¹⁾	Condition 2	Y
Semivolatile metals thermal input to the waste fired boiler	lbs/ MMBTU	Max12-hr RA	3.12 ⁽¹⁾	Condition 2	Y
Total system low volatile metals feed rate	lbs/hr	Max12-hr RA	114 ⁽¹⁾	Condition 2	Y
Chromium thermal input to the waste fired boiler	lbs/ MMBTU	Max12-hr RA	2.87 ⁽¹⁾	Condition 2	Y
Chromium waste feed rate limit to the waste fired boiler	lbs/hr	Max12-hr RA	30 ⁽²⁾	Condition 2	Y
Total system chlorine feed rate	lbs/hr	Max12-hr RA	3,117	Condition 2	Y
Chlorine thermal input to the waste fired boiler	lbs/ MMBTU	Max12-hr RA	1020 ⁽¹⁾	Condition 2	Y
High energy scrubber (HES) pressure drop	in wc	Min HRA	34	Highest dp Conditions 1, 2, 3	Y
HES blowdown rate	gpm	Min HRA	19	Highest Flow Conditions 1, 2, 3	Y
HES tank liquid level	ft	Min HRA	4.0	Highest Level Conditions 1, 2, 3	Y
HES liquid flow rate	gpm	Min HRA	696	Highest Flow Conditions 1, 2, 3	Y
HES liquid pH	S.U.	Min HRA	3.0	Condition 2	Y

Table 2-4 Summary of Operating Conditions and Waste Feed Rates - OPLs

OPERATING PARAMETER	UNITS	AVERAGING PERIOD	FINAL OPERATING LIMIT	BASIS FOR LIMIT 2011 CPT CONDITION THAT SET OPL	AUTOMATIC WASTE FEED CUTOFF
Activated carbon feed rate	lbs/hr	Min HRA	22.7	Highest Rate Condition 1, 2, 3	Y
Activated carbon carrier fluid flow rate	scfm	Min HRA	32	Highest Flow Condition 1, 2, 3	Y
Baghouse inlet temperature	°F	Max HRA	214	Lowest Temp Condition 1, 2, 3	Y
Kiln pressure	in wc	Instantaneous ³	<atmospheric	Fixed regulatory requirement	Y
Secondary combustion chamber pressure	in wc	Instantaneous ³	<atmospheric		Y
Waste fired boiler pressure	in wc	Instantaneous ³	<atmospheric		Y
Stack Carbon Monoxide	ppm	Max HRA	100		Y
WFB Exit Duct Carbon Monoxide	ppm	Max HRA	100		Y

Metals feed rates total and thermal, and chlorine thermal feed rate based on calculation from the 2011 test results;

Total metals feed rates capped at 3 times the CPT feed rate and thermal limit set based on 80% of the standard and the measured SRE.

See Section 7 of 2011 CPT Report

² USEPA requested that a WFB chromium feed rate limit (lbs/hr) be calculated under the Phase I incinerator emission limit of 92 ug/dscm in addition to the thermal waste feed limit for liquid fired boilers. The approved calculation method using SRE for LVM and 80% of the 92 ug/dscm limit is shown in Section 7 of the CPT report and in the approved CPT Plan. This mass based limit is the more restrictive limit if the boiler is feeding more than 10.45 MMBTU/hr.

³ Due to the nature of unit operations, these instantaneous pressure limits are established with a one-second delay, which reflects instrument reaction time.

Table 2-4 continued - Additional OPLs based on Manufacturers Specification for Good Combustion and for Activated Carbon for dioxins and furans and mercury control

Activated carbon specification: Minimum molasses DE	na	None	80	Fixed specification	N
Activated carbon specification: Minimum sieve analysis	%	None	90	Fixed specification	N
Kiln No. 1 atomizing fluid pressure	psig	Min HRA	30	Manufacturer specification	Y
Kiln No. 2 atomizing fluid pressure	psig	Min HRA	30	Manufacturer specification	Y
Secondary combustion chamber atomizing fluid pressure	psig	Min HRA	30	Manufacturer specification	Y
Waste fired boiler atomizing fluid pressure	psig	Min HRA	35	Manufacturer specification	Y

3.0 Engineering Description

This brief discussion is intended to describe the combustion and air pollution control systems in place at Clean Harbors. More detail on the equipment can be found in the Facility Operating Record – applications, modifications, the CPT Plan and 2012 CPT report.

3.1 Characteristics of Feedstreams

Waste feed streams to the incinerator and WFB are routinely analyzed for heating value, ash, metals, and chlorine. Waste feed streams and their constituents are identified at the point of waste receipt to determine the key constituent content of all waste streams. These streams are mixed and segregated as necessary to facilitate safe and efficient combustion.

Ash content is tested to comply with ash feed limits

Chlorine content is tested to control corrosion, and comply with feed limits

Mercury, SVM, and LVM contents are monitored to comply with those feed limits

Most of the analysis of these parameters is performed in the laboratory on-site. Details on the procedures used can be found in the facility's Feedstream Analysis Plan. The data generated by these analyses are entered into a computerized system called WinWeb. The data are extracted from WinWeb by the plant Distributed Control System (DCS) and matched with waste feed rates to track constituent feed rates in "real time." Each of the limits is monitored by operations personnel, and controlled by feed rate control to avoid approaching the limits. If a limit is reached, the DCS initiates an Automatic Waste Feed Cutoff (AWFCO).

3.2 Combustor and Emission Control Equipment

The incineration system consists of two rotary kilns, a SCC, a WFB, a gas conditioning system, and an air pollution control train.

Wastes are fed to one of the primary feed locations: the two rotary kilns, the WFB, and the SCC. The purpose of the rotary kilns is to pre-process solid and liquid wastes before the resulting pyrolysis gases flow to the combustion system. The gases generated in the kilns are fed along with separately controlled liquid and gaseous wastes to the SCC for thermal treatment. The WFB also receives liquid wastes for thermal treatment. WFB liquid feed is restricted to blended waste with heat content of 10,000 BTU/lb or higher.

Combustion gases from the WFB and SCC are combined and routed through a saturator and two parallel condensing towers for gas conditioning. The saturator rapidly cools the combustion gases as they exit the thermal treatment devices. The gas stream is then split and passes into two

parallel condensing towers where it is further cooled, condensing some of the moisture carried with the gases.

Once gas conditioning is complete, the gases from the two towers are combined and are routed to the air pollution control system, which consists of an High Energy Scrubber (HES) and a baghouse. The gases first enter the HES for removal of acid gases and are then reheated with a direct-fired natural gas burner or an indirect steam heat exchanger to prevent condensation of moisture on the filter bags. With the temperature of the combustion gases elevated above the dew point temperature, the combustion gases enter a fabric-filter baghouse for removal of PM, SVM, and LVM. Activated carbon is introduced ahead of the baghouse for control of D/F and mercury. The treated combustion gases then pass through the induced draft (ID) fan and exit to the atmosphere through the stack.

3.2.1 Combustion and Fuel Feed Systems

Kilns

Solid and containerized wastes and pumpable sludges intended for thermal treatment are pyrolyzed in one of two rotary kilns and the resulting gases are fed to the SCC. The kilns are not identical; therefore, a separate description is provided for each.

Kiln No. 1

Kiln No. 1 is a refractory lined, horizontal cylinder that is sloped slightly toward the discharge end to promote movement of solids through the kiln. The 36-foot long kiln has an inner diameter of 6.5 feet, resulting in a total interior volume of approximately 1,200 cubic feet. The 3/8-inch thick carbon steel cylinder is refractory lined with 9 inches of super duty firebrick to withstand the high temperatures in the kiln.

The kiln is equipped with a North American Model 9 burner. In addition to the feed nozzle in the burner, pumpable wastes are fed to the kiln through 2 liquid feed lances. Auxiliary fuels can be fed to the burners during startup and shutdown and during normal operation to help maintain an adequate temperature for waste processing in the kiln.

Kiln No. 2

Kiln No. 2 is larger than Kiln No. 1, with an internal diameter of 10.5 feet, a length of 48 feet, and a total internal volume of approximately 4,150 cubic feet. The 7/8-inch thick carbon steel shell on Kiln No. 2 is refractory lined with 9 inches of super duty firebrick.

A North American Model 6385 burner is used in the kiln to obtain desired operating temperatures. Pumpable wastes are fed into Kiln No. 2 through the main burner nozzle or

through 2 liquid feed lances. As with Kiln No. 1, auxiliary fuels can be fed to the burners during startup and shutdown and during normal operation to help maintain an adequate temperature for waste processing in the kiln.

Secondary Combustion Chamber (SCC)

Gases from the kilns, liquid wastes, and gases from the cylinder building are thermally treated in the SCC. The liquid wastes are injected into the chamber through lances in the two burners and through feed injection guns located adjacent to and below the burners. Gases from the kilns pass through separate refractory lined ducts, entering the combustion chamber below the injection guns.

The SCC was installed during the system upgrade in 2003 to help achieve compliance with the HWC NESHAP CO and HC emission standards. The new SCC is a vertically oriented, refractory-lined, carbon steel cylinder with a 22-foot inner diameter and 64-foot inner height. The total chamber volume is calculated to be approximately 24,330 cubic feet.

The two SCC burners were manufactured by John Zink, Inc. Each burner is rated for up to 35 MMBtu/hr thermal input. The burners are manufactured from carbon steel and are refractory lined. The feed lances in each burner are manufactured from Hastelloy. Each burner is equipped with three feed lances: a pilot gas lance, a natural gas lance, and a waste feed lance. Auxiliary fuels can be fed to the burners during startup and shutdown and during normal operations to maintain desired combustion chamber temperatures.

A wet-ash drag conveyor is attached to the bottom of the SCC to process any ash and molten slag that falls through the refractory-lined chute. Once dropped through the chute, these materials are conducted to the drag conveyor, the bottom of which is submerged in water. Once the ash materials fall into the water, they solidify and are moved along the bottom of the compartment by drag-chain driven metal flights. The metal flights transfer the solidified ash up a dewatering incline through a discharge chute, where it is collected in a roll-off bin for disposal.

Waste Fired Boiler

Liquid wastes from day storage tanks are processed in the WFB. The Babcock and Wilcox H-4, No. 32 Stirling Boiler has a rectangular combustion chamber with an approximate chamber volume of 2,400 cubic feet (dimensions of 14 feet by 16 feet by 10.7 feet). The WFB is constructed of carbon steel and is lined with refractory brick. The WFB is designed to produce up to 500 pounds of 250 pounds per square inch gauge (psig) steam per minute.

The WFB is equipped with three Trane-Thermal Model LV-14 burners. Each burner is rated for up to 14 MMBtu/hr and has one waste feed nozzle that can be used to feed liquid wastes into the combustion chamber. Auxiliary fuels can be fed to the burners during startup and shutdown and

normal operation to maintain desired operating temperatures. The thermocouple for temperature measurement is located directly in the fire box of the boiler. This location is before the flue gas exits the boiler, travels through the boiler exit duct and then mixes with the SCC flue gas.

3.2.2 Auxiliary Fuel Feed Systems

Natural gas and other non-hazardous fuels are used as auxiliary fuel during startup and shutdown and during normal operation to help maintain an adequate temperature for waste processing. The natural gas, the primary fuel, does not contain any HWC NESHAP regulated constituents in greater than trace quantities. The other fuels may include used oils, off-specification oils, RCRA comparable fuels, and non-hazardous waste fuels. For these other auxiliary fuels, concentrations of HWC NESHAP regulated constituents are determined, and any contributions included when determining the total feed rates of ash, metals and chlorine.

The auxiliary fuel feed system consists of fuel oil and used oil storage tanks, pumps, supply piping and valves; natural gas regulators and controls, pilots, electric igniters, and burners; atomizing air, and flame detectors, as well as the burner components themselves. The fuel supply is interlocked with combustion control and automatic shutdown systems. Each burner is overseen by a burner management system that ensures the safety of the fuel-combustion systems.

3.2.3 Description of Rapid Quench System

Hot combustion gases from the SCC and the WFB combine and flow into the refractory-lined saturator for gas conditioning. The carbon steel saturator is designed to cool the hot combustion gases to within several degrees of total saturation before they pass into the condenser columns and the air pollution control system. Water is sprayed into the gases in a down flow arrangement that minimizes dioxin formation. The floor of the saturator is sloped so that liquids will tend to flow to the drain. These liquids are gravity transferred to the saturator rundown tank. As needed, blowdown water from the condenser system is fed to the tank as makeup water.

Two centrifugal pumps maintain water flow to the saturator. Each pump is driven by a 100-horsepower (hp) motor and can supply up to 1,200 gpm of water to the saturator.

3.2.4 Description of Condensing Towers

Gases from the saturator split and flow into two parallel condensing towers where the gases are further cooled and moisture is condensed from the gas stream. The gases enter the 29.5-foot tall columns and pass countercurrent to water sprays. The water sprays serve to further cool the gases and cause the moisture to condense from the gas stream.

The water from the condenser columns then drains into the condenser rundown tank system. The condenser rundown tank system consists of two 12,000-gallon agitated fiberglass tanks in series.

Makeup water, provided by the blowdown stream from the saturator rundown tank, is added as needed to maintain a density suitable for pumping and spraying into the condenser columns. Liquid from the first tank flows via an overflow line to the second condenser rundown tank. The flow from the first tank is mixed into a homogenous solution before being pumped through heat exchangers back to the condenser columns. The plate and frame heat exchangers cool the water before it enters the condenser columns to increase the cooling effect. The water is transferred through the system by three pumps that are rated for up to 2,500 gpm of water flow. The pumps are driven by 150-hp motors.

3.2.5 High Energy Scrubber (HES)

The gas stream from the condensers combines and moves via fiberglass ductwork to the HES. The fiberglass-reinforced plastic (FRP) HES serves as the primary HCl/Cl₂ control device. Immediately prior to entering the HES, the gas stream is split into two equal flows. Water is sprayed into each stream before it passes through a venturi throat where the water droplets are reduced in size. The size of each throat is variable such that a steady scrubber pressure drop can be controlled over the typical gas flow range. Once passing through the throat sections, the two streams meet each other head on. The combined gas flow then passes through a demister where the water droplets are removed.

Rundown from the scrubber and demister flows by gravity to the scrubber rundown tank. Hydrated lime is added to the rundown line to neutralize any acid gas absorbed in the scrubber. The hydrated lime is supplied by the plant lime system. Immediately after the lime is added, the liquid flow passes through an in-line mixer to distribute it evenly in the scrubber rundown stream. The liquid flow then enters the rundown tank where it resides long enough to allow neutralization to proceed to completion. Water from plant and process water supplies is added to the rundown tank as needed to help achieve the desired pH. The rate of lime addition is also adjusted as necessary to control the liquid pH. Water in the scrubber system is transferred by two 1,500-gpm pumps that are driven by 75-hp motors.

3.2.6 Reheater

Upon exiting the HES, the gases pass through a reheat stage to elevate the temperature of the gas above the dew point. This is done using a natural gas fired burner exiting into the flue gas stream or an indirect steam heat exchanger. This ensures that no condensation will occur downstream in the remaining components of the air pollution control system.

3.2.7 Baghouse

Gases continue their flow through the air pollution control system into the baghouse, which serves as the primary PM, SVM, and LVM control device. Immediately prior to the baghouse, dry lime and activated carbon are injected into the gas stream as a pre-coat mechanism to help

increase the coating on the filter elements. The carbon will absorb any D/F and mercury remaining in the flue gases. The insulated, stainless steel alloy baghouse has three separate modules or cells. Each module contains several filter elements. The total filter area across all three cells is 25,300 square feet or more. The clean gas exiting the filter elements is collected in a clean air plenum. An exit nozzle on the plenum feeds the gas to a stainless steel alloy duct where it passes to the ID fan.

Periodic cleaning of the filter elements is accomplished with a pulsejet of dry air that flexes the elements and provides a temporary reverse gas flow. This combined flow dislodges the filter cake from the outside surface of the elements. While some cake buildup on the elements is preferred, periodic cake removal is necessary to retain the removal efficiency and to maintain the structural integrity of the filters. The frequency of the pulse cycle is determined based upon the pressure drop across each cell. When a pre-determined maximum level is reached, the pulsing cycle is activated.

Collected PM removed from the filter elements is discharged into a pyramid shaped hopper at the base of the module. The cake then falls by gravity out of the hopper into bins provided at the bottom of each hopper.

3.2.8 ID Fan and Stack

The induced draft (ID) fan has been designed to serve as the prime air mover for the system. The fan provides sufficient capacity to allow for maintenance of a negative pressure (draft) at the kilns, the SCC, and the WFB. The ID fan is manufactured from stainless nickel alloy and is rated for up to 120,000 acfm of air flow at 77 in. w.c. The design rating the fan is driven by a 2,000-hp motor. Flow control is provided by a variable frequency drive (VFD) or damper.

Treated combustion gases exit the incineration system through the exhaust stack. The stack has a carbon steel shell that extends from ground level to an elevation of 115 feet. The bottom 40 feet of the carbon steel section is lined with acid brick; the upper 75 feet is lined with an FRP liner. The FRP extends an additional 80 feet above the top of the steel shell, reaching a total stack elevation of 195 feet. Flow from the ID fan enters at an elevation of 60 feet, where the stack has an inner diameter of nine feet.

Sampling ports are located on the exit duct from the ID fan approximately 15 feet above ground level. The diameter at the sampling location is six feet. At this sampling location, there are ports that can be used for non-isokinetic sampling. There are additional ports on the stack that are used for isokinetic sampling. The gases flowing out the stack are sampled by the continuous emissions monitoring system (CEMS).

3.2.9 Automatic Waste Feed Cutoff System

All automatic data management at the facility is performed by a distributed control system (DCS). This DCS receives inputs from transmitters and instruments throughout the plant, performs calculations as necessary, and delivers output to control valves and other devices. Much of this control is performed in “real time,” wherein all parameters are read and adjusted in a continuous scan that takes at most 5 seconds to complete. Thus, all data points are reviewed on that frequency. The DCS also exports data history to a data acquisition system (DAS) for compliance purposes.

The current operating data are made available to plant operators at interface screens in each control room and throughout the facility. HRA and 12-HRA calculations are performed on the key parameters highlighted in this document, which are tracked to perform an AWFCO before an emission limit is exceeded. If an instrument fails, the DCS will execute an AWFCO. When an AWFCO occurs, the DCS will continue to calculate HRA in a seamless fashion so as to maintain the parameters while waste remains in the system. The last twelve hours of data are stored for use when an extended shutdown occurs, allowing the subsequent start-up to utilize actual operating data as the rolling average calculation starting point. Twelve hours is the averaging time for the constituent feed rate limit rolling averages, which are calculated from waste feed CMS and analytical data.

The DCS exports data history to a data acquisition system (DAS) for compliance purposes. Historical data are stored in the computer itself, and downloaded to the plant DAS as necessary. The DAS is a Microsoft SQL Server.

4.0 Final Operating Limits

The basis for these operating parameter limits is the facility Comprehensive Performance Test that was completed in October and November 2011, and detailed in the CPT Report, dated February 17, 2012.

4.1 Waste Feed Rate Limitations

The feed rate limits below are met by a combination of waste analysis and mass feed rate monitoring. The elements of waste analysis and data management are detailed in the facility Feedstream Analysis Plan. Individual waste feed flow rates are summed to yield individual combustion chamber totals. The constituent feed parameters are calculated using these data and analytical results.

4.1.1 Maximum Waste Feed Rate

40 CFR 63.1209(j)(3); 40 CFR 63.1209(k)(4)

This is an operating parameter limit for good combustion practices and is mandated for DRE and dioxin/furan control. Individual waste feed flow rates by port (feed location) are summed to yield individual combustion chamber total feed rates for the kilns, SCC, and WFB, and total pumpable feed rates for the kilns. Maximum HRA OPL's are based on CPT data using the maximum hourly feed rates demonstrated during the testing. Condition 1 of the CPT testing demonstrated maximum total and pumpable feed rates to the kilns, Condition 2 demonstrated maximum feed rate to the SCC, and Condition 3 demonstrated maximum feed rate to the WFB. Dioxins and furans were monitored for each of these Conditions and DRE was measured for the both the incinerator system and WFB.

A total waste feed rate limit is also established for the incinerator system which includes Kiln 1, Kiln 2, and the SCC. The operation of the kilns in pyrolytic mode (oxygen starved) send gaseous fuel to the SCC. Thus, the maximum waste feed rate for the two kilns was established in a Condition separate from the Condition setting the maximum liquid waste feed rate for the SCC. EPA requested that a maximum total incinerator waste feed rate be established in Condition 1. This additional OPL has been established as requested.

The maximum waste feed rates were calculated by averaging the maximum HRA feed rates for each of the three test runs from the applicable test Condition in accordance with *40 CFR 63.1209(j)(3)(ii)* and *63.1209(k)(4)(ii)*.

The total and pumpable waste feed rate limits are shown in the Table below.

Maximum Total and Pumpable Waste Feed Rate Limits for Kilns, SCC, WFB

	Units	Basis	Established Operating Limit
Maximum Kiln #1 Total Waste Feed	pph	HRA	13,383
Maximum Kiln #1 Pumpable Waste Feed	pph	HRA	5,005
Maximum Kiln #2 Total Waste Feed	pph	HRA	30,168
Maximum Kiln #2 Pumpable Waste Feed	pph	HRA	9,527
Maximum SCC Total Waste Feed	pph	HRA	13,601
Maximum WFB Waste Feed	pph	HRA	3,873
Maximum Total Waste Feed Rate for Incinerator (Kiln 1, Kiln2, SCC)	pph	HRA	50,505

All of these limits are stated in pounds per hour (pph), and tracked as HRA.

4.1.2 Maximum Chlorine Feed Rate

40 CFR 63.1209(o)(1)(i), (o)(1)(ii)

Maximum chlorine feed rate limit is necessary to ensure compliance with HCl/Cl₂ emission standards as well as LVM and SVM standards. It is measured and controlled on a 12-HRA basis.

The incinerator feed rate is a pound per hour limit that is derived directly from the average chlorine feed rate for the three test runs in Condition 2 of the 2011 CPT.

The WFB chlorine feed rate is a thermal based limit in pounds per MMBTU. This limit is derived from the measured system removal efficiency (SRE of 99.996%) from the test runs and using 80% of the standard (5.1E-02 lb/MMBTU) as required by USEPA Region 6. Section 7 of the CPT report details the calculations, as does the CPT Plan.

Maximum Chlorine Feed Rate Limits

	units	Basis	Established Operating Limit
Maximum Chlorine Feed Rate	pph	12 HRA	3,117
Maximum WFB Feed Rate	lbs/MMBTU	12 HRA	1,020

4.1.3 Maximum Ash Feed Rate

40 CFR 63.1209(m)(3)

Ash is the major constituent that results in particulate matter (PM) in the incinerator and WFB off gases. The operating parameter limits are derived directly from the 2011 CPT. Condition 1 tested PM at maximum ash feed rate to the incinerator system (Kilns plus SCC). Ash was spiked to the WFB during Condition 3 to establish a separate feed rate limit for the WFB. The limits are

based on the average of the three test runs in each Condition. Ash is monitored and controlled on a 12-hour rolling average.

The existing incinerator PM standard of 0.013 gr/dscft (28 mg/dscm) is more stringent than the liquid fired boiler PM standard of 80 mg/dscm. The more stringent standard is used for all compliance monitoring during the CPT, as noted in Section 2.0 of this NOC.

Maximum Ash Feed Rate Limits

	units	Basis	Established Operating Limit
Total System Feed Rate	pph	12 HRA	12,642
Waste Fired Boiler Feed Rate	pph	12 HRA	164.2

4.1.4 Maximum Total Mercury Feed Rate

40 CFR 63.1209(l)(i)

Mercury is a specific emission standard and is controlled by a mercury feed rate limit to the incinerator and by APC operating parameter limits described later in this section. Mercury is monitored and controlled on a 12-hour rolling average basis.

The incinerator feed rate is a pound per hour limit. As described in Section 7 of the CPT report, the calculated feed rate limit is determined by calculation based on using 80% of the regulatory emission limit, the average measured actual emissions, and the feed rate of mercury during Condition 2 of the CPT. In addition, the feed rate limit is capped at three (3) times the actual feed rate during the CPT test, as required by USEPA Region 6. The CPT data showed that the calculation method gave a mercury feed rate limit of 8.42 pph, whereas the maximum cap at three times the actual feed rate yielded a feed rate limit of 0.46 pph based on the average actual feed rate of 0.153 pph. The more conservative feed rate limit of 0.46 pph is established and is very conservative compared to the actual measured results.

The WFB mercury feed rate is a thermal based limit in pounds per MMBTU. This limit is derived from the measured system removal efficiency (SRE of 99.82%) from the test runs in Condition 2 and using 80% of the standard (4.2E-05 lb/MMBTU) as required by USEPA Region 6. Section 7 of the CPT report details the calculations, as does the CPT Plan.

Maximum Mercury Feed Rate Limits

	units	Basis	Established Operating Limit
Maximum Mercury Feed Rate	pph	12 HRA	0.46
Maximum Mercury WFB Feed Rate	lb/MMBTU	12 HRA	0.187

4.1.5 Maximum Total Semi-Volatile Metals Feed Rate

40 CFR 1209(n)(2)(ii) and (n)(2)(v)(A)

The SVM maximum waste feed rate limit is the sum of the lead and cadmium feed rates in all of the feed streams. SVM is a specific emission standard and is controlled by SVM feed rate limits to the incinerator and WFB, and by the air pollution control system operating parameter limits described later in this section.

The incinerator feed rate is a pound per hour limit. As described in Section 7 of the CPT report, the calculated feed rate limit is determined by calculation based on using 80% of the regulatory emission limit, the average measured emissions, and the feed rate of SVM during Condition 2 of the CPT. In addition, the feed rate limit is capped at three (3) times the actual feed rate during the CPT test, as required by USEPA Region 6. The CPT data showed that the calculation method gave a SVM feed rate limit of 1,272 pph, whereas the maximum cap at three times the actual feed rate yielded a feed rate limit of 116 pph based on the average actual feed rate of 38.65 pph. The more conservative feed rate limit of 116 pph is established and is very conservative compared to the actual measured results.

The WFB SVM feed rate is a thermal based limit in pounds per MMBTU. This limit is derived from the measured system removal efficiency (SRE of >99.9979%) from the test runs in Condition 2 and using 80% of the standard (8.2E-05 lb/MMBTU) as required by USEPA Region 6. Section 7 of the CPT report details the calculations, as does the CPT Plan.

Maximum SVM Feed Rate Limits

	units	Basis	Established Operating Limit
Maximum SVM Feed Rate	pph	12 HRA	116
Maximum SVM WFB Feed Rate	lb/MMBTU	12 HRA	3.12

4.1.6 Maximum Total and Pumpable Low-Volatile Metals Feed Rate

40 CFR 63.1209(n)(2)(ii); 40 CFR 63.1209(n)(2)(vi)

LVM is a specific emission standard and is controlled by LVM feed rate limits to the incinerator and WFB, and by the air pollution control system operating parameter limits described later in this section. Further, LVM is regulated for both pumpable feed rates and total feed rates. Because of the low volatility of LVM, system removal efficiency can be impacted by the type (liquid or solid) of feed to the incinerator. LVM is monitored and controlled on a 12-hour rolling average.

During the CPT all of the spiked LVM material was fed as a liquid chromium pumpable material. Virtually all of the LVM feed was a pumpable LVM material (38.1 pph pumpable, <1 pph nonpumpable). To simplify monitoring and compliance, a conservative approach is used where the maximum pumpable LVM data were used to set both the pumpable and total LVM feed rates to the units. All calculations assumed zero pounds of LVM in the solids feed during the test.

The incinerator feed rate is a pound per hour limit. As described in Section 7 of the CPT report, the calculated feed rate limit is determined by calculation based on using 80% of the regulatory emission limit, the average measured emission, and the feed rate of LVM during Condition 2 of the CPT. In addition, the feed rate limit is capped at three (3) times the actual feed rate during the CPT test, as required by USEPA Region 6. The CPT data showed that the calculation method gave a LVM feed rate limit of 254.9 pph, whereas the maximum cap at three times the actual feed rate yielded a feed rate limit of 114 pph based on the average actual feed rate of 38.1 pph. The more conservative feed rate limit of 114 pph is established and is very conservative compared to the actual measured results.

The WFB SVM feed rate is a thermal based limit in pounds per MMBTU. This limit is derived from the measured system removal efficiency (SRE of >99.9961%) from the test runs in Condition 2 and using 80% of the standard (1.4E-04 lb/MMBTU) as required by USEPA Region 6. Section 7 of the CPT report details the calculations, as does the CPT Plan.

USEPA also requested that a WFB chromium feed rate limit (pph) be calculated using the Phase I incinerator emission limit of 92 ug/dscm in addition to the thermal waste feed limit for liquid fired boilers. The approved calculation method using SRE for LVM and 80% of the 92 ug/dscm limit is shown in Section 7 of the CPT report. This mass based limit is the more restrictive limit if the boiler is feeding more than 10.45 MMBTU/hr.

Maximum LVM Feed Rate Limits (Pumpable and Total)

	units	Basis	Established Operating Limit
Maximum Total System Feed Rate	pph	12 HRA	114
Maximum Pumpable System Feed Rate	pph	12 HRA	114
Maximum Waste Fired Boiler Chromium Feed Rate	lb/MMBT U	12 HRA	2.87
Maximum Waste Fired Boiler Chromium Feed Rate	pph	12 HRA	30

4.2 Combustion Chamber Limitations

Clean Harbors measures and monitors physical data from the combustion process to show that the incinerator is operating in accordance with the MACT emission standards. These limits are based upon the 2011 CPT data.

4.2.1 Minimum Combustion Chamber Temperature

40 CFR 63.1209(j)(1); 40 CFR 63.1209((k)(2)

Minimum combustion chamber temperature is the parameter used to demonstrate compliance with the DRE and dioxins/furans emission standards. The temperature limits are stated as minimum, on an HRA basis. The limits are derived directly from the 2011 CPT. All data are based on the average of the three test runs performed for the applicable CPT Condition.

The minimum temperature operating limit applies to combustion parameters such as DRE, dioxin/furans, CO, and THC. Dioxins and furans, CO, THC, and DRE were measured during Condition 1 of the CPT when Kiln #1, Kiln #2, and SCC temperature were minimized. Dioxins and furans, CO, THC, and DRE were measured during Condition 2 of the CPT when the SCC temperature was minimized while operating at maximum waste feed rate. Therefore, the minimum temperature OPL for the SCC is the highest average temperature from either Condition 1 or 2. The minimum temperature limit for the SCC of 1,851 °F is based on Condition 2.

Dioxins and furans were measured during Condition 2 for the WFB when it was operating at minimum temperatures. DRE, CO, and THC was monitored for the WFB during Condition 2R (rerun) when the WFB was operating at minimum temperature. The minimum temperature OPL is set based on the higher of the average temperature from these two Conditions. The temperature limit for the WFB of 1,856 °F is based on Condition 2R.

Minimum Temperature Limits for Kiln 1, Kiln 2, SCC, and WFB

	units	Basis	Established Operating Limit
Kiln #1 Minimum Temperature	°F	HRA	861
Kiln #2 Minimum Temperature	°F	HRA	875
SCC Minimum Temperature	°F	HRA	1,851
WFB Minimum Temperature	°F	HRA	1,856

4.2.2 Maximum Combustion Air Flow Rate

40 CFR 63.1209(j)(2); (k)(3); (l)(2); (m)(2); (n)(5); (o)(2)

Clean Harbors uses stack flow rate, measured on a continuous basis, to monitor and control the total combustion air flow rate from the incinerator and WFB. The stack flow rate is a measure of the gas flow through the air pollution control system. Maximum stack flow rate is used to ensure acceptable gas residence time in the incineration system SCC combustion chamber to achieve the required DRE. Stack flow is directly related to combustion chamber efficiency and is an operating parameter related to compliance with DRE, dioxin/furans, THC, and CO. Stack flow rate is also a control parameter for the air pollution control equipment impacting gas scrubbing in the high energy scrubber and baghouse efficiency.

Clean Harbors uses WFB combustion air flow rate, measured on a continuous basis, to monitor and control gas flow rate in the WFB. Combustion air flow rate is related to flue gas flow rate from the WFB at maximum gas flow operating conditions and is related to combustion chamber efficiency. Gas flow is a operating parameter related to compliance with DRE, THC, and CO.

Stack gas flow rate is an operating parameter related to all of the combustion efficiency and emission limits in the regulations, including DRE, dioxin/furans, PM, Cl₂/HCl, LVM, SVM, and mercury. Determination of the maximum stack gas flow rate limit is based directly upon the 2011 CPT data for Conditions 1, 2, and 3 when DRE performance and the constituent emissions measurements were made. Condition 1 included measurement of DRE, dioxin/furan and PM for the incinerator system, Condition 2 included measurement of DRE for the incinerator system, dioxins and furans, PM, Cl₂/HCl, LVM, SVM, and mercury, and Condition 3 included PM for the WFB test. The lowest average maximum HRA was then selected as the most stringent OPL as required by the regulation *40 CFR 63.1209(i)*.

The MACT regulation requires that the maximum HRA stack flow rate limit be based on the average of the maximum HRAs from the three test runs in an applicable Condition. The maximum HRA was determined for each CPT run for Conditions 1, 2, and 3 and the average maximum HRA calculated for each Condition. The average maximum HRA stack flow rate for Condition 1 was 100,568 acfm, for Condition 2 was 101,162, and for Condition 3 was 102,171

acfm. The most stringent (lowest) average maximum HRA is from Condition 1 (100,568 acfm) and is selected as the OPL in accordance with *40 CFR 63.1209(i)*.

The WFB combustion air flow rate was monitored for Conditions 2, 2R and 3, when the combustion efficiency parameters (DRE, CO, and THC) and dioxins/furans were measured during the 2011 CPT. The combustion air flow rate maximum HRA was calculated for each test run in Conditions 2, 2R and 3 and the average maximum HRA calculated for each Condition. The average maximum HRA combustion gas flow rate for Condition 2 was 8,699 acfm, for Condition 2R was 8,630 acfm and for Condition 3 was 9,197. The most stringent (lowest) average maximum HRA is from Condition 2R (8,630 acfm) and is selected as the OPL in accordance *40 CFR 63.1209(i)*.

Stack flow rate and WFB combustion air flow rate limits are set as a maximum on an HRA basis.

Maximum Gas Flow Rate Limits

	Units	Basis	Established Operating Limit
Maximum Stack Flow Rate	acfm	HRA	100,568
WFB Maximum Combustion Air Flow Rate	acfm	HRA	8,630

Stack flow rate also is a major parameter controlling hazardous waste residence time in the incinerator. The combustor rules [*40 CFR 63.1206(b)(11)*] require that the residence time for hazardous waste in the system be calculated and included the NOC. The calculation for hazardous waste residence time was supplied in the CPT Plan as required and is included in Attachment 1 to this NOC.

4.2.3 Maximum Carbon Monoxide/ Total Hydrocarbon Concentration

40 CFR 63.1209(a)

Maximum CO and THC concentrations are parameters used to demonstrate compliance with the DRE and dioxins/furans emission standards. The CO limit is set by the MACT emission standards at a concentration of 100 ppmv, on a dry basis, corrected to 7% oxygen. The THC limit is 10 ppmv. A continuous emission monitoring system (CEMS) is used to demonstrate compliance with this standard. CO has been selected by Clean Harbors as the primary compliance AWFCO parameter for the incinerator and WFB. CO is monitored in the stack and in the exit duct from the WFB, and is tracked on an HRA basis in accordance with *40 CFR 1219(a)(5)(i)* and *1217(a)(5)(i)*.

All tests during the CPT showed CO and THC well below the established MACT limits.

4.2.4 Maximum Combustion Chamber Pressure

40 CFR § 63.1209(p)

This limit is intended to prevent fugitive emissions from the incineration system. By operating below atmospheric pressure, any leak point on the incinerator is ensured to draw ambient air into the system and not emit gases from the system. The standard calls for an AWFCO when the pressure exceeds atmospheric.

Clean Harbors continuously monitors draft in the following portions of the incineration system with differential pressure transmitters: the kilns, the SCC, and the WFB. The pressure at these locations is maintained below atmospheric pressure at all times to help control fugitive emissions. Due to the nature of kiln operation, Clean Harbors has established these instantaneous pressure limits with a one-second delay, which reflects instrument reaction time.

4.2.5 Combustion Firing System

40 CFR 63.1209.(j)(4)

Clean Harbors monitors and controls the atomizing air pressure for each burner or lance in the various combustion units. The atomizing air pressure limits are based on the manufacturers specifications and good combustion practice. The following atomizing air pressure limits are established to ensure good combustion practice. The limits are established on an HRA basis.

Minimum Atomizing Air Pressure Limits

	Units	Basis	Established Operating Limit
Minimum Kiln 1 Atomizing Air Pressure	psig	HRA	30
Minimum Kiln 2 Atomizing Air Pressure	psig	HRA	30
Minimum SCC Atomizing Air Pressure	psig	HRA	30
Minimum WFB Atomizing Air Pressure	psig	HRA	35

4.3 Air Pollution Control System

Clean Harbors measures and monitors physical data from the Air Pollution Control Equipment to demonstrate that the incinerator is operating in accordance with the MACT emission standards. All of these operating parameters limits are based on results of the 2011 CPT when the related emissions limits for dioxins and furans, PM, Cl₂/HCl, LVM, SVM, and mercury were measured.

4.3.1 High Energy Scrubber Limitations

Five parameter limits were established during the 2011 testing for the high energy scrubber (HES). All these limits are based on the average of the test run averages for the Conditions performed during the CPT, and stated as minimums, on an HRA basis. In the cases where more than one CPT Condition applies to a specific OPL, the more stringent (higher or lower average) limit of the applicable Conditions applies in accordance with *40 CFR 63.1209(i)*.

4.3.1.1 Minimum High Energy Scrubber Tank Level *40 CFR 63.1209(m)(1)(i)(B)(ii), 63.1209(n)(3)*

A minimum tank level is mandated by MACT to satisfy the PM, LVM and SVM standards. That level sets the system's capacity to store the collected particulate and control solids levels in the HES inlet water. The level in the HES recirculation tank level is measured directly. The operating parameter limit is set based on the most stringent (highest) minimum tank level from the 2011 CPT from Conditions 1, 2 and 3, as PM was measured during Conditions 1 and 3, and LVM and SVM were measured during Condition 2. Condition 1 was for high ash feed rate to the incinerator and Condition 3 was for high ash feed to the WFB. The highest minimum tank level of 4.0 occurred during Condition 3.

Minimum HES Blowdown Tank Level

	Units	Basis	Established Operating Limit
Minimum HES Blowdown Tank Level	feet	HRA	4.0

4.3.1.2 Minimum HES Blowdown Flow Rate *40 CFR 63.1209(m)(1)(i)(B)(ii), 63.1209(n)(3)*

A minimum blowdown is mandated to satisfy the MACT PM, LVM and SVM standards. That minimum sets the system's capacity to purge the collected particulate. The HES recirculation tank blowdown rate is measured on the pipeline exiting the system. The operating parameter limit is set based on the most stringent (highest) minimum blowdown rate from Conditions 1, 2 and 3 as PM was measured during Conditions 1 and 3, and LVM and SVM were measured during Condition 2. The highest minimum blowdown rate of 19 gpm occurred during Condition 3.

Minimum HES Tank Blowdown Flow Rate

	Units	Basis	Established Operating Limit
Minimum HES Tank Blowdown Flow Rate	gpm	HRA	19

4.3.1.3 Minimum HES Pressure Drop

40 CFR 63.1209(o)(3)(i)(A); 63.1209(n)(3); 63.1209(l)(2); 63.1209(m)(1)(i)(A)

A minimum pressure drop is used to ensure that the HES scrubber has sufficient gas/liquid contact for control of PM, LVM, SVM, mercury, and Cl₂/HCl. The operating parameter limit is set based on the most stringent (highest) minimum pressure drop from Conditions 1, 2 and 3 as PM was measured during Conditions 1 and 3, and LVM, SVM, mercury, and Cl₂/HCl were measured during Condition 2. The pressure drop during Condition 2 (34 in wc) was the most stringent (highest) limit from the three test Conditions. This limit is stated as minimum, on an HRA basis.

Minimum HES Pressure Drop Limit

	Units	Basis	Established Operating Limit
Minimum HES Pressure Drop	in wc	HRA	34

in wc = inches of water column

4.3.1.4 Minimum HES Water Flow Rate

40 CFR 63.1209(o)(3)(v); 63.1209(n)(3); 63.1209(l)(2); 63.1209(m)(1)(i)(C)

A minimum HES water flow rate is used to ensure that the scrubber has enough water to contact the gases in the scrubber and is related to pressure drop. The operating parameter limit is set based on the most stringent (highest) minimum HES water flow rate from Conditions 1, 2 and 3 as PM was measured during Conditions 1 and 3, and LVM, SVM, mercury, and Cl₂/HCl were measured during Condition 2. The minimum HES water flow rate during Condition 2 was the most stringent (highest) limit from the three test Conditions. This limit is stated as minimum, on an HRA basis.

Minimum HES Water Flow Rate Limit

	Units	Basis	Established Operating Limit
Minimum HES Water Flow Rate	gpm	HRA	696

4.3.1.5 Minimum HES Water pH
40 CFR 63.1209(o)(3)(iv)

A minimum HES water pH is required by the MACT rules to meet the HCl/Chlorine standard. The pH sets the system’s ability to neutralize acid gases. The minimum limit is derived directly from the 2011 CPT as measured during Condition 2, which measured Cl₂/HCl emissions and set the maximum chlorine feed rate.. This limit are stated as minimum, on an HRA basis.

Minimum HES Water pH Limit

	Units	Basis	Established Operating Limit
Minimum HES Water pH	S.U.	HRA	3.0

4.3.2 Baghouse Limitations

The baghouse equipment is monitored and controlled to ensure PM and metal emissions limits are not exceeded. Further, the associated activated carbon injection system is monitored and controlled to ensure dioxins and furans, and mercury limits are not exceeded. The operating parameter limits below are based on the most stringent results from the 2011 CPT results for Conditions 1, 2, and 3, as each of these conditions included one or more of the emissions measurements related to the baghouse and activated carbon system OPLs. The calculations for these limits are based on the average of the test run averages for each Condition.

4.3.2.1 Maximum Baghouse Inlet Temperature
40 CFR 63.1209(k)(1)(i); 63.1209(n)(1)

A maximum baghouse inlet temperature is an operating parameter related to dioxins and furans, and LVM and SVM emissions control. The operating parameter limit is set based on the most stringent (lowest) maximum baghouse inlet temperature from Conditions 1, 2 and 3 as dioxins and furans were measured during Conditions 1, 2 and 3, and LVM and SVM were measured during Condition 2. The most stringent maximum baghouse inlet temperature was during Condition 2. The limit is stated as minimum, on an HRA basis.

Maximum Baghouse Inlet Temperature Limit

	Units	Basis	Established Operating Limit
Maximum Baghouse Inlet Temperature	°F	HRA	214

4.3.2.2 Minimum Activated Carbon Feed Rate
40 CFR 63.1209(k)(6)(i); 63.1209(l)(3)

Clean Harbors feeds activated carbon to the gas stream before the baghouse. The carbon feed is designed to reduce dioxins and furans, and mercury in the gas stream. A minimum activated carbon feed rate is an operating parameter related to this control. The operating parameter limit is set based on the most stringent (highest) minimum activated carbon feed rate from Conditions 1, 2 and 3 as dioxins and furans were measured during Conditions 1, 2 and 3, and mercury was measured during Condition 2. The most stringent minimum activated carbon feed rate occurred during all three Conditions, as the average feed rate of 22.7 pph was the same for all three Conditions. The limit is stated as minimum, on an HRA basis.

Minimum Activated Carbon Feed Rate Limit

	Units	Basis	Established Operating Limit
Minimum Activated Carbon Feed Rate	pph	HRA	22.7

4.3.2.3 Minimum Activated Carbon Carrier Fluid Flow Rate
40 CFR 63.1209(k)(6)(ii); 63.1209(l)(3)

Clean Harbors feeds activated carbon to the gas stream before the baghouse. The carbon feed is designed to reduce dioxins and furans, and mercury in the gas stream. A minimum activated carbon carrier fluid flow rate is an operating related to this control, as carrier flow rate can impact the distribution pattern of the carbon as it is injected into the gas stream. The operating parameter limit is set based on the most stringent (highest) minimum activated carbon carrier flow rate from Conditions 1, 2 and 3 as dioxins and furans were measured during Conditions 1, 2 and 3, and mercury was measured during Condition 2. The most stringent minimum activated carbon carrier feed rate occurred during Condition 2. The limit is stated as minimum, on an HRA basis.

Minimum Activated Carbon Feed Rate Limit

	Units	Basis	Established Operating Limit
Minimum Activated Carbon Carrier Feed Rate	scfm	HRA	32

4.3.2.4 Activated Carbon Specifications
40 CFR 63.1209(k)(6)(iii); 63.1209(l)(3)

Clean Harbors has placed in the CPT Plan, the activated carbon specifications for use at the facility in accordance with *40 CFR 63.1209(k)(6)(iii)*. The following description and specifications are taken from the approved CPT Plan.

40 CFR §§ 63.1209(k)(6)(iii) and (l)(3) require that the activated carbon must have equivalent or better adsorption properties than the activated carbon used during the CPT. The activated carbon parameters that affect adsorption are sieve analysis and absorptivity. Sieve analysis is an important parameter in carbon effectiveness because it is an indication of particle size and surface area. Carbon with greater surface area will provide more sites for adsorption of pollutants. Carbon made from lignite uses molasses absorption as a measure of porosity/absorptivity. Porosity is also an indicator of surface area, or active sites, of the activated carbon. Clean Harbors uses activated carbon with the following specifications:

Minimum molasses DE of 80; and

Minimum sieve analysis of 90 percent for 325 mesh.

5.0 Certification

I certify that the information presented in this notification of compliance was prepared under my direction or supervision in accordance with a system designed to ensure that qualified personnel properly gathered and evaluated the information and supporting documentation, and that the incinerator and waste fired boiler will meet the emission standards specified in Section 2.1 when operating under the operating parameter limits established in Section 2.3 and summarized in Table 2-4. I also certify that all required continuous emission monitoring systems and continuous monitoring systems necessary to monitor the parameters limits established in Section 2.3 are installed, calibrated and continuously operating while combusting hazardous waste. Based on my inquiry of those persons directly responsible for gathering the information, this notification of compliance is, to the best of my knowledge and belief, true, accurate, and complete.

Daniel C. Roblee

Name

General Manager

Title

Signature

Date

Attachment – 1

Clean Harbors – El Dorado

Notification of Compliance

Residence Time Calculations

HWC NESHAP defines hazardous waste residence time as “the time elapsed from cutoff of the flow of hazardous waste into the combustor (including, for example, the time required for liquids to flow from the cutoff valve into the combustor) until solid, liquid, and gaseous materials from the hazardous waste, excluding residues that may adhere to combustion chamber surfaces, exit the combustion chamber.” This hazardous waste residence time is not an indication of good combustion conditions. It is a regulatory term that is used to define when a unit is operating under a hazardous waste burning mode of operation. The hazardous waste residence time must be calculated, and the calculation must be included in performance test plans and the operating facility records.

For systems with rotary kilns, the hazardous waste residence time will be controlled by the amount of time required for solid materials to exit the chamber, or the solids residence time. The time required for the liquid and gaseous materials to exit is fractional in comparison. According to the USEPA handbook *Guidance on Setting Permit Conditions and Reporting Trial Burn Results*, the solids, or ash, residence time for a rotary kiln is calculated using the following formula:

$$\Theta = \frac{0.19 \times L}{N \times S \times D}$$

Where:

- Θ = Solids Residence Time (minutes)
- L = Kiln Length (meters)
- D = Kiln Inside Diameter (meters)
- N = Kiln Rotational Speed (revolutions per minute)
- S = Kiln slope (meters/meter)

All factors except for rotational speed were input to the above equation to determine site-specific equations for the residence time in each kiln.

KILN NO. 1

$$\Theta_1 = \frac{52.6}{N_1}$$

132 to 26 minutes

KILN NO. 2

$$\Theta_2 = \frac{43.5}{N_2}$$

109 to 22 minutes

Of the factors included in the above equations, only the rotational speed of the kilns will vary during operations. Clean Harbors varies the rotation speed of the kilns depending on the type of materials being incinerated. The rotational speed of each kiln can vary from 0.4 to 2 revolutions per minute (rpm). The range of solids residence times then, are noted in the bottom row of the table above. Faster rotational speeds result in shorter residence times.

APPENDIX Q

Monitoring and Maintaining Carbon Canister for Fugitive Emissions at Tank Farms



**Monitoring and Maintaining Carbon Canister
Fugitive Emissions at Tank Farms Work Instructions
Standard Operating Procedure
El Dorado Facility
El Dorado, AR**

TITLE: Monitoring and Maintaining Carbon Canister for Fugitive Emissions at Tank Farms			
Facility: Clean Harbors El Dorado	Prepared by: Craig Hudson	SOP Number: 69EL-104-174-04	Page 2 of 4
Reviewed By: William Simmons	Title: Maintenance Manager	Issue Date: 8/21/2010	
Reviewed By: Russell Hargiss	Title: Health and Safety Manager	Revision Number and Date: 4, 11/20/2011 / 3, 2/11/2013	
Approved By: Dan Roblee	Title: General Manager	Next Review Date: 01/24/2014	

1.0 Objective

To establish the performance standard for testing and changing out of carbon canisters on volatile organic storage vessels which fall under 40 CFR Part 60, Subpart Kb as well as RCRA 40 CFR Part 264 Subpart CC.

2.0 Site Specific Terms

Carbon canisters are used for filtering tanks emissions, tanks are used for fuel blending for Waste Fire Boiler, Kilns, and SCC

3.0 Responsibilities

The General Manager will ensure that all employees are trained and knowledgeable regarding the proper operating procedures.

The Maintenance Manager is responsible for monitoring, and enforcing this procedure with the employees.

Employees are responsible for following and adhering to safe work practices and all provisions found in this procedure.

4.0 Prerequisites

Health and Safety:

- 1) See Appendices, Review the Job Hazard Analysis, PPE Hazard Assessments
- 2) LOTO, confined space entry, line break and hot work procedure training

5.0 Procedure

5.1 Fugitive Emission Monitor

- a) Calibrate test equipment (as prescribed by the manufacturer) each time before making checks and rechecks.
- b) Perform weekly inspections of mechanical seals on pumps.
- c) Monitor all of the tank farms (Day Feed Tanks, Lower Tanks Farms, and Solvent Recovery Tanks) carbon filters once daily.
- d) Identify leak points and create a corrective work order, follow up on repairs by retesting for compliance within the 24-hour timeframe required under the regulations.

TITLE: Monitoring and Maintaining Carbon Canister for Fugitive Emissions at Tank Farms			
Facility: Clean Harbors El Dorado	Prepared by: Craig Hudson	SOP Number: 69EL-104-174-04	Page 3 of 4

- e) Update log of process equipment database of completed checks, record new or retested check points. Send results to Compliance Department via email.

5.2 Maintaining failed Carbon Canisters

- a) Option new carbon from central using work order (copy is attached)
- b) Follow the PPE Procedure
- c) Remove lid ring and lid from carbon canister to access used / spent carbon
- d) Empty out all used / spent carbon from canister by using a metal bucket (5-gal) and put in an empty (55-gal fiber), if spent carbon contains liquid insure empty fiber is lined with plastic to prevent any possible leakage
- e) After emptying the canister of all carbon ensure there is no liquid in bottom of canister, if there is any liquid found in the canister contact the operator and or supervisor, if no liquid is found proceed with putting new carbon in canister
- f) Open new drum of carbon, empty new carbon in to canister by using a bucket (5-gal) or approved method by supervisor (boom lift) , only one drum of carbon per canister
- g) After emptying new carbon into canister, re-install the canister lid and ring, ensuring lid ring is tight to prevent any leaks.
- h) Clean all carbon from outside canister and/or ground that may have spilt from the carbon change. Confirm Grounding cables are properly connected.
- i) Notify supervisor when carbon change is complete and turn in work order completed.
- j) Notify fugitive emission monitor of completion.
 - a. Re test carbon and if all canisters pass- record time, date, and submit per work order and ECAO form (F104-174 Rev 1).
 - b. Re test carbon and it canister **FAILS:**
 - i. Tank is removed from FILL service.
 - ii. Communication with operations is made that the contents of the vessel is to be processed (incinerated) as a priority.

TITLE: Monitoring and Maintaining Carbon Canister for Fugitive Emissions at Tank Farms			
Facility: Clean Harbors El Dorado	Prepared by: Craig Hudson	SOP Number: 69EL-104-174-04	Page 4 of 4

- iii. All efforts will be made to define causes of failure (gassing) and corrections put into place before vessel is returned to (filling) service.
- iv. Once the Tank is re initiated into service testing of carbon will be performed immediately and monitored appropriately (daily).

k) All removed spent carbon canisters will be incinerated.

6.0 Consequences of Deviations

- Personal injury
- Regulatory violations and/or fines
- Damaged agency relations
- Adverse harm to the environment and increased risk to human health
- Disciplinary actions up to and including termination
- Possible down time / loss of production

7.0 Appendices

Emissions Corrective Action Order Form (F104-174 Rev 1)

Sample tracking and work order forms

Quiz – See file “Quiz – Maintaining Carbon Canister.doc”

Job Hazard Analysis – See file “JHA – Maintaining Carbon Canister.doc”

PPE Hazard Assessment – See file “PPE – Maintaining Carbon Canister.doc”

Approvals

General Manager

Incineration Manager

Health & Safety Manager

Compliance Manager

Facility Engineering Manager

Facility Operations Manager

Maintenance Manager

Facility Marketing Manager

ECAO FORM

EMISSIONS CORRECTIVE ACTION ORDER

DATE.....

ECAO NUMBER.....

ISSUED TO.....

WORK ORDER

CORRECTIVE ACTION REQUESTED

Change Charcoal
.....

EQUIPMENT NUMBER.....

POINT NUMBER.....

TAG NUMBER.....

PRIORITY CODE..... 1

COMPLIANCE TIME.....23 hours and 59 minute

REQUESTED BY.....

REMARKS / COMMENTS.....
.....
.....
.....

COMPLETION DATE..... / /

DATE CLOSED..... / /

TECH SIGNATURE _____

APPENDIX R

Lamp Recycling/Bulb Crushing System Standard Operating Procedure



Lamp Recycling/Bulb Crushing System Standard Operating Procedure

El Dorado Facility



Table of Contents

1. Objective	3
2. Site Specific Terms	3
3. Responsibilities	3
3.1. General Manager	3
3.2. Supervisors	3
3.3. Employees	3
4. Prerequisites	4
4.1. Health and Safety	4
4.2. Environmental	4
4.3. Documented Training	4
4.4. Operations	4
5. Procedures	4
5.1. Receiving	4
5.2. Waste Tracking	4
5.3. Material Processing Operation	5
5.3.1. Air Monitoring	5
5.3.2. Start Up Operations	5
5.3.3. Operation	6
5.3.4. Shut Down Procedure	8
5.3.5. Emergency Shutdown	8
5.3.6. Routine Housekeeping	8
6. Consequences of Deviations	9
7. Appendices/References	9
• Job Hazard Analysis	9
• PPE Hazard Assessment	9
• Startup Inspection Checklist	9
• LSSI Operating Manual	9
• SOP Quiz	9
8. Approvals	9

TITLE: Lamp Recycling/ Bulb Crushing System			
Facility: Clean Harbors El Dorado	Prepared by: Eddie J. Prim	SOP Number: 69EL-LMP001-000	Page 3 of 9
Reviewed By: Eddie Prim	Date: 8/7/2013	Issue Date: September 6, 2008	
Reviewed By: Russ Hargiss	Title: Health and Safety Manager	Revision Number and Date: 69EL-LMP001-003 8/7/2013	
Approved By: Dan Roblee	Title: General Manager	Next Review Date: August 7, 2014	

1. Objective

This SOP is to provide the guidance and necessary steps to standardize the process and techniques of operating the Model LSS1 Lamp Recycling System. The LSS1 Lamp Recycling System is a fully computerized, self-contained bulb crushing system. Unit operates a power feed belt that passes all bulbs through a negative pressure air chamber absorbing all contained vapors through an activated carbon filter system eliminating fugitive emissions during process.

2. Site Specific Terms

Specific equipment involved in lamp recycling operations includes:

- Bulb Machine – The Model LSS1 Lamp Recycling System
- HID Chamber – High Intensity Discharge De-Globing Chamber
- PLC – Programmable Logic Controller
- Compact Fluorescent Auger – Screw Auger that carries Compact Fluorescents into the # 1 Trammel

3. Responsibilities

3.1. General Manager

The General Manager will ensure that all employees are trained and knowledgeable regarding the proper operating procedures used during dumping operations, and to ensure all personnel comply with the SOP.

3.2. Supervisors

The supervisor and/or lead foreman for this process is responsible for training, monitoring, and enforcing this procedure with the employees, and for ensuring all equipment and required PPE are available to the employees.

3.3. Employees

Employees are responsible for adhering to safe work practices and all provisions found in this procedure. Employees must inspect equipment and report any failures or deficiencies to the appropriate Supervisor.

4. Prerequisites

4.1. Health and Safety

- Any incidents, including near misses, are to be reported immediately to the supervisor.
- Review the Job Hazard Analysis to become familiar with the hazards associated with this process.
- Consult the PPE Hazard Assessments to identify the proper PPE to be worn for this job task.
- The buddy system (e.g., visual, audio contact, etc.) must be maintained when this process is being conducted.

4.2. Environmental

- If an incident occurs, report it immediately to your supervisor.
- Incidental releases are to be cleaned up immediately in PPE designated by the hazard assessments listed in Appendix 2 according to individual waste stream constituents.
- If the incident requires additional assistance or equipment, the Contingency Plan may need to be implemented.

4.3. Documented Training

- 24hr HazWoper training
- OSHA regulated substances - Mercury
- RCRA training
- SOP training
- Equipment training – Forklift, Jerome Mercury Vapor Meter, Respiratory Protection, Bulb Machine

4.4. Operations

- Ensure that all preventative maintenance on equipment has been conducted.
- Ensure that all equipment is clean and operational.
- Ensure that all waste to be processed has been plant received with tracking numbers
- Required equipment:
 - Forklift
 - 55-gal open top metal drums
 - self-dumping metal hopper
 - Jerome Mercury Vapor Meter

5. Procedures

5.1. Receiving

- Receiving procedures should be accomplished per facility specific sampling and waste acceptance plan.

5.2. Waste Tracking

- Tracking procedures should be accomplished per facility specific requirements.

TITLE: Lamp Recycling/ Bulb Crushing System			
Facility: Clean Harbors El Dorado	Prepared by: Eddie J. Prim	SOP Number: 69EL-LMP001-002	Page 5 of 9

5.3. Material Processing Operation

5.3.1. Air Monitoring

Clean Harbors Mercury Guidelines establish cutoff levels for respiratory protection –

Level D - .012 mg/m³

Level C - .12 mg/m³

Level B – 10 mg/m³

The operating permit requires air monitoring to be conducted and look for visible emissions on a weekly basis. As a best management practice we sample at the discharge stack side to determine the unit’s efficiency every 2 hours while the machine is operating. A visual observation of the stack on the outside of the bulb process building needs to be observed while the unit is in use. All findings are to be logged in the Mercury levels log and visual emissions findings needs to be recorded on the Mercury log on a daily basis also.

SN-32 Lamp Recycling System permit requires that we do not process more than 38,435 lbs/per day. It also states that the Mercury levels are not to exceed 0.000013 lb/hr and 0.000057 tpy.

- Ensure Jerome Mercury Vapor Meter is operating properly
- Conduct readings at exit duct sample port every two hours
- All Mercury readings must be logged on the daily log sheet no exceptions.
- The carbon is sampled with the Jerome meter at the exit side of the carbon tank and if any breakthrough is noted, the carbon is changed out before operations can resume. The canister tanks holds approx 1200 lbs of carbon A man way on the side of the carbon tank that opens and the carbon gravity falls into a DOT approved container which is sent as hazardous waste to a permitted mercury retort facility.

5.3.2. Start Up Operations

The Bulb Machine is designed to run in an automatic mode only. When the Bulb Machine runs in the automatic mode, all equipment operations are supervised through the programmable logic controller (PLC). If there is an alarm, the Bulb Machine will stop and indicate the reason for the alarm.

- Conduct a walk around inspection to ensure all byproduct receptacles are in position to receive the materials as they are discharged and properly labeled.
- Ensure that the four drums around the unit are properly positioned and have straight, unobstructed connection boots and secure connection rings.
- Ensure all byproduct containers have proper lids that are closed and secured.
- Ensure that the knife switch on the “Electrical Disconnect” is in the “ON” position with the power indicator light on.
- Turn the key switch on the touch pad to the “ON” position following the prompts on the screen.
- Press the “Automatic” selection on the touch screen.
- When the Automatic screen appears, press the “System Start” to activate a five second buzzer, which indicates that the system will start.

TITLE: Lamp Recycling/ Bulb Crushing System			
Facility: Clean Harbors El Dorado	Prepared by: Eddie J. Prim	SOP Number: 69EL-LMP001-002	Page 6 of 9

- When the buzzer shuts off, the system will start in a sequence.
- When all of the systems are operating all indicator lights of the system will be lit, except “Vacuum Bar and HID”
- The system is now ready to accept lamps.

5.3.3. Operation

Feeding Conveyor #1

- Lamps are to be manually placed on the #1 feed conveyor end-to-end and stacked no higher than the guard at the end of the conveyor.
- **DO NOT** feed cardboard, wood, plastic, or other debris into the machine as such will clog the vacuum lines or jam the equipment.

***Caution:** In order to prevent jamming the machine, all coated “Shattershield” bulbs are not to be ran thru the machine. All CLF4 coated bulbs are to be packed and palletized. At times there are removable plastic protective sleeves on the bulbs and they will be removed and placed into a container for subsequent disposal. (Landfill or Incineration)*

Bulbs containing wires running through them cannot be processed through the lamp-recycling machine. These bulbs will be busted and repacked into a 55 gallon drum for retort. These types of bulbs are typically coded at CFL6 “UV” bulbs.

- The LSS1 is designed to run 2660 lbs or 4000, 4 foot lamp equivalent per hour at maximum capacity.
- When any of the byproduct material containers are full, an alarm will sound and the system will shut down and will identify the container on the Programmable Logic Controller (PLC). Replace the full container and restart the system.
- Full containers of Phosphor powder will be handled as a hazardous waste and must be labeled and placed in to the appropriate storage area.
- Full containers of metal end caps are to be sent out for aluminum recycling and are consider non-hazardous. Boxes will be stored on the Recycler’s supplied trailer.
- Crushed glass will be sent out to a glass recycler and is consider non-hazardous material.

NOTE: If the bulb machine becomes jammed the operator shall turn the machine off prior to trying to clear the jam. Once the jam is cleared the machine may be restarted. The operators should use caution when working around the machine after start up. All doors shall be closed prior to start restart.

TITLE: Lamp Recycling/ Bulb Crushing System			
Facility: Clean Harbors El Dorado	Prepared by: Eddie J. Prim	SOP Number: 69EL-LMP001-002	Page 7 of 9

Feeding the HID De-Globing Chamber

- The HID De-Globing Chamber serves to remove the outer glass from the HID lamps.
- Remove the high intensity discharge (HID) lamps from the container and place them in the HID De-Globing Chamber socket side in.
- After loading the chamber the door must be closed and latched.
- Press the black start button on the side of the chamber to activate the de-globing process.
- Allow 10 seconds for the outer glass to be crushed. The chamber door will not open until the cycle is fully complete. After the HID has been crushed the remaining ampoule and metal need to be packed into a 55 gallon drum to be shipped out for retort.

HID De-Globing Procedure on the # 2 Belt

- HID bulbs that do not have the powder coating inside the globe can be de-globed at the #2 belt hatch opening. All HID's that have the powder coating on the inside of the globe must be processed thru the HID De-Globing Chamber.
- In order to remove the globe the HID, hold the metal base firmly in one hand above the hatch opening on the # 2 belt. With the other hand slightly tap the glass just above the metal base with a screw driver. The entire globe will pop off, generally in one large piece possibly two. Pull the metal base and filament with ampoule attached from the globe sending the globe onto the belt moving forward to the crusher wheel.
- Mercury in HID bulbs is located in the ceramic filaments and glass ampoules. These are to not be broken and bulked into 55 gallon containers along with the metal bases attached.

Feeding the Compact Fluorescent Auger

- The Compact Fluorescent Auger serves as a way of transferring Compacts into the LSS1 safely and effectively. Compacts are carried up the auger and dumped into the #1 trammel. The compacts will tumble causing the glass to break away from the plastic base. The glass will be processed thru the machine just as all the glass is processed and the plastic base will come out the end where the aluminum caps do.
- Turn on the auger system once the LSS1 is up and running. The on/off switch is located on the west wall of the process building. The light on the switch box will be lit when the auger is turning. When not running Compacts it is not necessary to turn on the auger. After daily runs please ensure that the auger is turned to the off position and the light is no longer on.
- The Compacts are dumped onto the sorting table to allow for removal of outer cardboard containers and plastic coverings and to make sure nothing is in the containers that shouldn't be

before entering other than bulbs into the auger chute. All drums are to be lifted onto the pallet table located in front of the sorting table before dumping. This will reduce the risk of back injuries or strains.

TITLE: Lamp Recycling/ Bulb Crushing System			
Facility: Clean Harbors El Dorado	Prepared by: Eddie J. Prim	SOP Number: 69EL-LMP001-002	Page 8 of 9

- Once determined that all bulbs should be processed, push the bulbs into the auger chute opening using the push stick only. No person should push compacts with their hands into the chute at anytime, even if it's to remove bulbs from the chute due to jam. To clear auger Jam, please follow the proper Lock-Out Tag-Out procedures before doing so. The lock out point for the auger is located on the west wall of the process building also labeled Compact Auger. All persons involved in the Lock Out must be signed off on the permit and locked out on the Auger before work is performed.
- The volume of compacts allowed to go in the trammel is set based on half of the maximum allowable volume which is 2,660 lbs. So the auger will only be able to process 1,330 lbs/hour.

5.3.4. Shut Down Procedure

- Allow the system to continue running for a minimum of ten minutes after the last lamp has been fed through. This will ensure that a negative pressure is maintained within the unit, preventing the release of any residual mercury vapors and/or phosphor powder that may remain in the system.
- During this time the operator should use the attached vacuum (positive displacement) and vacuum the area thoroughly of any residual phosphor powder or glass in the area.
- Press the system shut down key on the touch screen panel.
- Allow the vapor fan to continue running to keep the unit under negative pressure.
- Empty byproduct material containers if needed.

5.3.5. Emergency Shutdown

- If at any time the machine needs to be immediately shut down the operator should depress one of the four Emergency Shutdown buttons located on the machine. Three Emergency Shutdown buttons are located along the front of the machine, and one at the back of the machine.

Note: To prevent fugitive vapor emissions the vapor collection system should not be shut down unless necessary.

- Follow Site Contingency Plan for Emergency Response
- Evacuate as directed in the Site Contingency Plan
- Power failure. In case of a power failure the vapor collection system must be restarted immediately following the treatment of emergency to prevent fugitive vapor emissions.

5.3.6. Routine Housekeeping and Maintenance

- Daily Housekeeping – Floors should be free of all empty containers, debris, broken glass, etc. Floors must be swept and vacuumed utilizing the wet/dry vac with a HEPA filter in place to help reduce dust from being scattered.
- The Bulb Processing Building will be power washed on an as needed basis upon Supervisors request only. Any and all water is to be managed as Hazardous Waste and will require Bulk handling to Vac Truck all wash down water. This is to include all rainwater in sumps and the unloading containment. No wash or rainwater is to be released at **ANYTIME!**

TITLE: Lamp Recycling/ Bulb Crushing System			
Facility: Clean Harbors El Dorado	Prepared by: Eddie J. Prim	SOP Number: 69EL-LMP001-002	Page 9 of 9

- Any rain water that happens to get into the process building while moving pallets or coming underneath the doorways must be vacuumed up with the wet and dry vac. Water is to be managed for incineration. At no time do we push water out of the process building except when power washing the process building, **which requires Supervisors prior-approval!**
- Weekly Housekeeping – The work area is to be vacuumed with a solution of HgX. At no time do we spray the HgX on the surface of the bulb machine. The machine is to be manually wiped with a mild detergent and water.
- #1 and #2 conveyor belt belly pan’s are to be dropped and cleaned out on a weekly basis. This will eliminates unwanted build up of powder and glass that could potentially cut the belts.
- Bulb Process Building Exhaust Fan Pre Filters are to be changed on a weekly basis, typically change out on Tuesdays.
- Incline Glass discharge belly pan must be cleaned out on a weekly basis to keep material from building up underneath the belt.

6. Consequences of Deviations

In addition to the process interruptions, which can occur, the following additional consequences of deviations could result:

- Injuries and/or fatalities
- Property damage
- Regulatory violations and/or fines
- Damaged public relations and/or customer relations
- Disciplinary actions up to and including termination
- Environmental impact

7. Appendices/References

- *Job Hazard Analysis*
- *PPE Hazard Assessment*
- *Startup Inspection Checklist*
- *LSSI Operating Manual*
- *SOP Quiz*

8. Approvals

General Manager

Incineration Manager

Health & Safety Manger

Compliance Manger

Facility Engineering Manager

CERTIFICATE OF SERVICE

I, Cynthia Hook, hereby certify that a copy of this permit has been mailed by first class mail to
Clean Harbors El Dorado, LLC, 309 American Circle, El Dorado, AR, 71730, on this

13th day of February, 2018.



Cynthia Hook, ASIII, Office of Air Quality