

# ADEQ

ARKANSAS  
Department of Environmental Quality

**MAY 10 2018**

Adriane Rogers, Environmental Manager  
Great Lakes Chemical Corporation - Central Plant  
P.O. Box 7020  
El Dorado, AR 71731

Dear Ms. Rogers:

The enclosed Permit No. 1077-AOP-R5 is your authority to construct, operate, and maintain the equipment and/or control apparatus as set forth in your application initially received on 2/5/2018.

After considering the facts and requirements of A.C.A. §8-4-101 et seq. as referenced by §8-4-304. and implementing regulations, I have determined that Permit No. 1077-AOP-R5 for the construction and operation of equipment at Great Lakes Chemical Corporation - Central Plant shall be issued and effective on the date specified in the permit, unless a Commission review has been properly requested under Arkansas Department of Pollution Control & Ecology Commission's Administrative Procedures, Regulation 8, within thirty (30) days after service of this decision.

The applicant or permittee and any other person submitting public comments on the record may request an adjudicatory hearing and Commission review of the final permitting decisions as provided under Chapter Six of Regulation No. 8, Administrative Procedures, Arkansas Pollution Control and Ecology Commission. Such a request shall be in the form and manner required by Regulation 8.603, including filing a written Request for Hearing with the APC&E Commission Secretary at 101 E. Capitol Ave., Suite 205, Little Rock, Arkansas 72201. If you have any questions about filing the request, please call the Commission at 501-682-7890.

Sincerely,



Stuart Spencer  
Associate Director, Office of Air Quality

Enclosure: Final Permit

# ADEQ OPERATING AIR PERMIT

Pursuant to the Regulations of the Arkansas Operating Air Permit Program, Regulation 26:

Permit No. : 1077-AOP-R5

IS ISSUED TO:

Great Lakes Chemical Corporation - Central Plant  
2226 Haynesville Highway  
El Dorado, AR 71730  
Union County  
AFIN: 70-00012

THIS PERMIT AUTHORIZES THE ABOVE REFERENCED PERMITTEE TO INSTALL, OPERATE, AND MAINTAIN THE EQUIPMENT AND EMISSION UNITS DESCRIBED IN THE PERMIT APPLICATION AND ON THE FOLLOWING PAGES. THIS PERMIT IS VALID BETWEEN:

May 1, 2018 AND January 24, 2021

THE PERMITTEE IS SUBJECT TO ALL LIMITS AND CONDITIONS CONTAINED HEREIN.

Signed:



Stuart Spencer  
Associate Director, Office of Air Quality

MAY 10 2018

\_\_\_\_\_  
Date

Table of Contents

**SECTION I: FACILITY INFORMATION** ..... 5

**SECTION II: INTRODUCTION** ..... 6

**Summary of Permit Activity** ..... 6

**Process Description** ..... 6

**Regulations** ..... 6

**Emission Summary** ..... 8

**SECTION III: PERMIT HISTORY** ..... 23

**SECTION IV: SPECIFIC CONDITIONS** ..... 27

    SN-402, SN-403, SN-405, SN-411, SN-412, SN-413, SN-499 ..... 27

    SN-605, SN-612, SN-653, SN-654, SN-657, SN-658, SN-660, SN-661, SN-664, SN-672, SN-673, SN-699 ..... 33

    SN-1001A, SN-1001B, SN-1002, SN-1003, SN-1005, SN-1006, SN-1007, SN-1008, SN-1014, SN-1015, SN-1016, SN-1019, SN-1025, SN-1030, SN-1031, SN-1099 ..... 38

    SN-1102, SN-1103, SN-1104, SN-1105, SN-1106, SN-1107, SN-1109, SN-1112, SN-1113, SN-1114, SN-1115, SN-1116, SN-1123, SN-1140, SN-1141, SN-1142, SN-1150, SN-1199 ..... 46

    SN-1202, SN-1203, SN-1204, SN-1220, SN-1221, SN-1230, SN-1299 ..... 56

    SN-1301, SN-1314, SN-1315, SN-1337, SN-1350, SN-1351, SN-1361, SN-1362, SN-1398, SN-1399 ..... 62

    SN-1403, SN-1404, SN-1406A, SN-1406B, SN-1409, SN-1413, SN-1420, SN-1421, SN-1422, SN-1423, SN-1430, SN-1431, SN-1433, SN-1434, SN-1435, SN-1499 ..... 69

    SN-1501, SN-1504, SN-1551, SN-1552, SN-1599 ..... 80

    SN-301, SN-302, SN-303, SN-902, SN-906, SN-907, SN-908, SN-909 ..... 84

    SN-102, SN-199 ..... 91

    SN-201, SN-202, SN-299 ..... 95

    SN-901, SN-999 ..... 98

    SN-406, SN-409, SN-410 ..... 100

    SN-1903, SN-1904, SN-1905, SN-1906, SN-1907, SN-1908, SN-1909 ..... 102

    Alternative Operating Scenario ..... 113

    Sweet Gas Flaring Events ..... 115

**SECTION V: COMPLIANCE PLAN AND SCHEDULE** ..... 119

**SECTION VI: PLANTWIDE CONDITIONS** ..... 120

**SECTION VII: INSIGNIFICANT ACTIVITIES** ..... 167

**SECTION VIII: GENERAL PROVISIONS** ..... 169

Appendix A – 40 CFR Part 60, Subpart Dc

Appendix B – 40 CFR Part 60, Subpart VV

Appendix C – 40 CFR Part 60, Subpart IIII

Appendix D – 40 CFR Part 61, Subpart FF

Appendix E – 40 CFR Part 63, Subpart F

Appendix F – 40 CFR Part 63, Subpart UU

Appendix G – 40 CFR Part 63, Subpart YY

Appendix H – 40 CFR Part 63, Subpart MMM

Appendix I – 40 CFR Part 63, Subpart EEEE

Appendix J – 40 CFR Part 63, Subpart FFFF

Great Lakes Chemical Corporation - Central Plant

Permit #: 1077-AOP-R5

AFIN: 70-00012

Appendix K – 40 CFR Part 63, Subpart ZZZZ

Appendix L – 40 CFR Part 63, Subpart DDDDD

List of Acronyms and Abbreviations

A.C.A.	Arkansas Code Annotated
AFIN	ADEQ Facility Identification Number
CFR	Code of Federal Regulations
CO	Carbon Monoxide
HAP	Hazardous Air Pollutant
lb/hr	Pound Per Hour
MVAC	Motor Vehicle Air Conditioner
No.	Number
NO <sub>x</sub>	Nitrogen Oxide
PM	Particulate Matter
PM <sub>10</sub>	Particulate Matter Smaller Than Ten Microns
SNAP	Significant New Alternatives Program (SNAP)
SO <sub>2</sub>	Sulfur Dioxide
SSM	Startup, Shutdown, and Malfunction Plan
Tpy	Tons Per Year
UTM	Universal Transverse Mercator
VOC	Volatile Organic Compound

Great Lakes Chemical Corporation - Central Plant  
Permit #: 1077-AOP-R5  
AFIN: 70-00012

**SECTION I: FACILITY INFORMATION**

PERMITTEE: Great Lakes Chemical Corporation - Central Plant

AFIN: 70-00012

PERMIT NUMBER: 1077-AOP-R5

FACILITY ADDRESS: 2226 Haynesville Highway  
El Dorado, AR 71730

MAILING ADDRESS: P.O. Box 7020  
El Dorado, AR 71731

COUNTY: Union County

CONTACT NAME: Adriane Rogers

CONTACT POSITION: Environmental Manager

TELEPHONE NUMBER: (870) 881-6252

REVIEWING ENGINEER: Derrick Brown

UTM North South (Y): Zone 15: 3671911.12 m

UTM East West (X): Zone 15: 527462.02 m

## SECTION II: INTRODUCTION

### Summary of Permit Activity

Great Lakes Chemical Corporation (GLCC) Central Plant operates a chemical product preparation and manufacturing facility located at 2226 Haynesville Highway, Union County, El Dorado, Arkansas. This modification replaces two existing cooling towers: SN-1433 and SN-1434 with a new cooling tower which will retain source number SN-1433. Reference to SN-1434 will be removed from the permit. Also, the permittee requested the minimum operating limit for SN-1409 (Acid Vent Scrubber) decreased from 49.0 gallons/minute to 15.0 gallons/minute. There will be no change in permittee emissions for SN-1409. Facility emissions will decrease by 16.0 tons per year of PM and 16 tons per year of PM<sub>10</sub>.

### Process Description

The primary process at this plant is the extraction of bromine from naturally occurring brine. The brine is brought to the surface via wells, the bromine is extracted, and the de-brominated brine (tail brine) is deep-well injected. The bromine is then sold as a product or utilized in the manufacture of brominated chemicals. Brominated chemicals have a variety of uses, including flame retardation and fumigation.

Some processes at the plant are incidental to the manufacture of brominated chemicals. Boilers produce steam using natural gas, partially sweet fuel gas from the NaHS Unit and/or gas from an amine unit operated as a joint venture with Lion Oil Company as fuel (a NaHS unit is permitted to produce sodium hydrosulfide from hydrogen sulfide gas as an alternative to routing it to Lion Oil). Process water is treated at the Process Water Treatment Plant (PWTP) and deep-well injected. Leachate is treated in the Leachate Treatment Unit (LTU) and deep-well injected. Corrosion resistance is imparted to equipment at a Halar/Teflon Coating facility. Nitrogen is generated on site.

Air emissions are controlled by scrubbers, condensers, baghouses, flares, and bromine recovery units (BRUs).

### Regulations

The following table contains the regulations applicable to this permit.

Regulations
Arkansas Air Pollution Control Code, Regulation 18, effective March 14, 2016
Regulations of the Arkansas Plan of Implementation for Air Pollution Control, Regulation 19, effective March 14, 2016
Regulations of the Arkansas Operating Air Permit Program, Regulation 26, effective March 14, 2016

Regulations
40 CFR Part 60 Subpart Dc – <i>Standards of Performance for Small Industrial-Commercial-Institutional Steam Generating Units (Appendix A)</i>
40 CFR Part 60 Subpart VV – <i>Standards of Performance for Equipment Leaks of VOC in the Synthetic Organic Chemicals Manufacturing Industry (Appendix B)</i>
40 CFR Part 60 Subpart IIII – <i>Standards of Performance for Stationary Compression Ignition Internal Combustion Engines (Appendix C)</i>
40 CFR Part 61 Subpart FF – <i>National Emission Standard for Benzene Waste Operations (Appendix D)</i>
40 CFR Part 63 Subpart F – <i>National Emission Standard for Organic Hazardous Air Pollutants from The Synthetic Organic Chemical Manufacturing Industry (Appendix E)</i>
40 CFR Part 63 Subpart UU – <i>National Emission Standards for Equipment Leaks – Control Level 2 (Appendix F)</i>
40 CFR Part 63 Subpart YY – <i>National Emission Standards for Hazardous Air Pollutants for Source Categories: Generic Maximum Achievable Control Technology Standards (Appendix G)</i>
40 CFR Part 63 Subpart MMM – <i>National Emission Standards for Hazardous Air Pollutants for Pesticide Active Ingredient Production (Appendix H)</i>
40 CFR Part 63 Subpart EEEE – <i>National Emission Standards for Hazardous Air Pollutants: Organic Liquids Distribution (Non-Gasoline) (Appendix I)</i>
40 CFR Part 63 Subpart FFFF – <i>National Emission Standards for Hazardous Air Pollutants: Miscellaneous Organic Chemical Manufacturing (Appendix J)</i>
40 CFR Part 63 Subpart ZZZZ – <i>National Emission Standards for Hazardous Air Pollutants for Stationary Reciprocating Internal Combustion Engines (Appendix K)</i>
40 CFR Part 63 Subpart DDDDD – <i>National Emission Standard for Hazardous Air Pollutants for Industrial, Commercial, and Institutional Boilers and Process Heaters (Appendix L)</i>
40 CFR Part 64 – Compliance Assurance Monitoring



### Emission Summary

The following table is a summary of emissions from the facility. This table, in itself, is not an enforceable condition of the permit.

EMISSION SUMMARY				
Source Number	Description	Pollutant	Emission Rates	
			lb/hr	tpy
Total Allowable Emissions		PM	51.3	201.7
		PM <sub>10</sub>	51.8	200.4
		SO <sub>2</sub>	130.4	544.0
		VOC	153.9	313.4
		CO	86.8	326.6
		NO <sub>x</sub>	168.9	387.4
HAPs		Arsenic	0.04	0.04
		Benzene	0.12	0.11
		Beryllium	0.05	0.05
		Cadmium	0.05	0.05
		Cl <sub>2</sub> *	1.54	6.77
		Chromium	0.05	0.05
		Cobalt	0.05	0.05
		Dichlorobenzene	0.05	0.05
		Ethyl chloride	3.44	16.62
		Formaldehyde	0.13	0.19
		HCl*	8.15	16.03
		Hydrazine*	0.09	0.38
		Hexane	0.62	2.96
		Manganese	0.05	0.05
		Mercury	0.05	0.05
		Methanol	18.37	73.17
		Meth. & Methyl Br.	4.76	20.89
		Methyl Bromide	2.16	9.48
		Methylene Chloride*	9.98	44.14
		Naphthalene	0.12	0.11
		Nickel	0.05	0.05
		Organic HAP	7.23	31.64
		Phosgene	0.89	3.94
	Selenium	0.05	0.05	
	Toluene	0.10	0.10	
	Triethylamine	2.58	12.87	
	TEA & Ethyl Chloride	0.01	0.44	

EMISSION SUMMARY				
Source Number	Description	Pollutant	Emission Rates	
			lb/hr	tpy
		Acetaldehyde	0.06	0.06
		Acrolein	0.06	0.06
		1,3 – Butadiene	0.07	0.07
		Xylenes	0.07	0.07
		POM	0.12	0.12
		HAPs***	0.01	0.01
	Air Contaminants **	Ammonium Bromide**	0.10	0.02
		Br <sub>2</sub> **	17.71	77.42
		HBr**	14.96	65.56
		HBr + Br <sub>2</sub> **	2.50	11.00
		H <sub>2</sub> S**	1.30	5.70
		NH <sub>3</sub> **	0.10	0.44
102	BRU Thermal Oxidizer	PM <sub>10</sub>	1.0	4.4
		PM	1.0	4.4
		SO <sub>2</sub>	0.1	0.5
		VOC	10.0	43.4
		CO	33.5	146.8
		NO <sub>x</sub>	0.5	2.2
		HBr + Br <sub>2</sub>	2.50	11.00
		HCl	0.46	2.02
		Methylene Chloride	1.62	7.10
199	BRU Fugitive Equipment Leaks	VOC	4.4	19.1
		Methanol	4.353	19.07
		Methyl Bromide	0.02507	0.1098
201	HCL Storage Tank Scrubber	HCl	1.68	2.04
202	PWTP Area VOC Emissions	VOC	7.3	31.7
		Organic HAP	7.23	31.64
299	PWTP Fugitive Equipment Leaks	HCl	0.29	1.27
301	Boiler #2/Flare (Natural Gas, Sweet Gas, and Partially Sweetened NaHS Gas) (Bubble)	PM <sub>10</sub>	11.2	58.4~
		PM	11.2	58.4~
		SO <sub>2</sub>	120.0	525.6~
		VOC	0.9	17.6~
		CO	12.4	91.0~
		NO <sub>x</sub>	41.1	186.7~
		Arsenic	2.933E-05	0.01~
		Benzene	3.079E-04	0.01~
		Beryllium	1.760E-06	0.01~
		Cadmium	1.613E-04	0.01~
		Chromium	2.053E-04	0.01~
		Cobalt	1.232E-05	0.01~
		Dichlorobenzene	1.760E-04	0.01~

Great Lakes Chemical Corporation - Central Plant

Permit #: 1077-AOP-R5

AFIN: 70-00012

EMISSION SUMMARY				
Source Number	Description	Pollutant	Emission Rates	
			lb/hr	tpy
		Formaldehyde	1.100E-02	0.06~
		Hexane	2.639E-01	1.39~
		Manganese	5.572E-05	0.01~
		Mercury	3.812E-05	0.01~
		Naphthalene	8.944E-05	0.01~
		Nickel	3.079E-04	0.01~
		Selenium	3.519E-06	0.01~
		Toluene	4.985E-04	0.01~
		POM	1.293E-05	0.01~
		H <sub>2</sub> S	1.3	5.7~
302	Boiler #3	PM <sub>10</sub>	0.9	3.7
		PM	0.9	3.7
		SO <sub>2</sub>	3.5	15.2
		VOC	0.7	2.7
		CO	9.3	40.7
		NO <sub>x</sub>	31.0	135.5
		Arsenic	0.01	0.01
		Benzene	0.01	0.01
		Beryllium	0.01	0.01
		Cadmium	0.01	0.01
		Chromium	0.01	0.01
		Cobalt	0.01	0.01
		Dichlorobenzene	0.01	0.01
		Formaldehyde	0.01	0.03
		Hexane	0.19	0.87
		Manganese	0.01	0.01
		Mercury	0.01	0.01
		Naphthalene	0.01	0.01
		Nickel	0.01	0.01
		Selenium	0.01	0.01
Toluene	0.01	0.01		
POM	0.01	0.01		
303	Boiler #4	PM <sub>10</sub>	0.7	2.9
		PM	0.7	2.9
		SO <sub>2</sub>	0.1	0.3
		VOC	0.5	2.1
		CO	7.3	31.9
		NO <sub>x</sub>	8.7	38.0
		Arsenic	0.01	0.01
		Benzene	0.01	0.01
		Beryllium	0.01	0.01
		Cadmium	0.01	0.01
		Chromium	0.01	0.01

EMISSION SUMMARY				
Source Number	Description	Pollutant	Emission Rates	
			lb/hr	tpy
		Cobalt	0.01	0.01
		Dichlorobenzene	0.01	0.01
		Formaldehyde	0.01	0.02
		Hexane	0.15	0.68
		Manganese	0.01	0.01
		Mercury	0.01	0.01
		Naphthalene	0.01	0.01
		Nickel	0.01	0.01
		Selenium	0.01	0.01
		Toluene	0.01	0.01
		POM	0.01	0.01
402	Alternate Vent Scrubber (No emissions allowed except in emergency)			
403	Tail Brine Surge Tanks Combined Vent (TT-01-066)	HBr	0.1	0.44
		Br <sub>2</sub>	0.1	0.44
		HCl	0.01	0.05
		Cl <sub>2</sub>	0.01	0.05
405	Bromine Production with Caustic Vent Scrubber	HBr	0.5	2.19
		Br <sub>2</sub>	0.5	2.19
		HCl	0.01	0.05
		Cl <sub>2</sub>	0.01	0.05
406	ISO/Railcar Scrubber	Br <sub>2</sub>	0.10	0.50
		Cl <sub>2</sub>	0.01	0.05
409	Chlorine Transfer Scrubber (TT-01-702)	Cl <sub>2</sub>	0.1	0.44
410	HCl Transfer Scrubber (CL-01-717)	HCl	1.70	2.03
411	Cooling Tower (CT-01-090)	PM <sub>10</sub>	0.8	3.3
		PM	0.8	3.3
412	Cooling Tower (CT-01-127)	PM <sub>10</sub>	0.1	0.5
		PM	0.1	0.5
		VOC	0.1	0.5
		HBr	0.01	0.05
		HCl	0.01	0.05
413	Cooling Tower (CT-01-227)	PM <sub>10</sub>	0.1	0.5
		PM	0.1	0.5
		VOC	0.1	0.5
		HBr	0.01	0.05
		HCl	0.01	0.05
499	Bromine Production Unit	HCl	0.32	1.40
		Cl <sub>2</sub>	1.08	4.71

EMISSION SUMMARY				
Source Number	Description	Pollutant	Emission Rates	
			lb/hr	tpy
	Fugitive Equipment Leaks			
605	Product Storage Tank (TT-22-652)	VOC	15.4	2.9
612	HBr Scrap Tank (TT-02-494)	HBr HCl	0.30 0.01	1.31 0.05
653	Intermediate Product Tank (TT-22-631)	VOC	14.3	2.7
654	Refrigerated Methanol Tank (TT-22-040)	VOC Methanol	0.1 0.10	0.5 0.44
657	HBr Absorber Scrubber Vent (HBr production in alkyl bromides reactor)	HCl HBr NH <sub>3</sub>	0.01 1.00 0.10	0.05 4.38 0.44
658	HBr Scrap Tank (TT-02-168)	HBr HCl	0.10 0.01	0.44 0.05
660	Ethyl Bromide Transfer and Storage (TT-22-031)	VOC	1.8	7.5
661	Ethyl Bromide Transfer and Storage (TT-22-647)	VOC	3.5	0.8
664	Raw Material Storage Tank (TT-22-648)	VOC	3.5	0.8
672	Product Storage Tank (TT-22-236)	VOC	13.0	2.5
673	Product Loadout Operations	VOC	30.8	8.1
699	Fugitive Equipment Leaks	VOC Methanol Methyl Bromide	3.5 1.76 1.76	15.4 7.69 7.69
901	Acid Storage Tanks	HBr HCl	0.04 1.13	0.03 1.37

EMISSION SUMMARY						
Source Number	Description	Pollutant	Emission Rates			
			lb/hr	tpy		
902	Sour Gas Flare (Pilot Only)	PM <sub>10</sub>	0.1	0.1		
		PM	0.1	0.1		
		SO <sub>2</sub>	0.1	0.1		
		VOC	0.1	0.1		
		CO	0.2	0.5		
		NO <sub>x</sub>	0.2	0.6		
		Arsenic	0.01	0.01		
		Benzene	0.01	0.01		
		Beryllium	0.01	0.01		
		Cadmium	0.01	0.01		
		Chromium	0.01	0.01		
		Cobalt	0.01	0.01		
		Dichlorobenzene	0.01	0.01		
		Formaldehyde	0.01	0.01		
903	Sour Gas Backup Flare (Pilot Only)	Hexane	0.01	0.01		
		Manganese	0.01	0.01		
		Mercury	0.01	0.01		
		Naphthalene	0.01	0.01		
		Nickel	0.01	0.01		
		Selenium	0.01	0.01		
		Toluene	0.01	0.01		
		POM	0.01	0.01		
		906	Cooling Tower	PM <sub>10</sub>	1.1	4.8
				PM	1.1	4.8
		907	Cooling Tower	PM <sub>10</sub>	0.5	1.9
				PM	0.5	1.9
		908	Cooling Tower	PM <sub>10</sub>	0.1	0.4
				PM	0.1	0.4
909	Cooling Tower	PM <sub>10</sub>	0.1	0.3		
		PM	0.1	0.3		
999	Equipment Leaks	HCl	0.16	0.69		
1001 A & B	Caustic Scrubber	Br <sub>2</sub>	0.5	2.19		
		Cl <sub>2</sub>	0.01	0.05		
1002	BPA Silo Baghouse	PM <sub>10</sub>	0.4	1.5		
		PM	0.4	1.5		
1003	Line 1 Fabric Filter	PM <sub>10</sub>	1.8	7.6		
		PM	1.8	7.6		
		VOC	1.0	4.4		
		Meth. & Methyl Br.	1.00	4.40		
1005	Railcar Loading Baghouse	PM <sub>10</sub>	2.2	9.5		
		PM	2.2	9.5		
1006	Baghouse	PM <sub>10</sub>	1.8	7.6		

EMISSION SUMMARY				
Source Number	Description	Pollutant	Emission Rates	
			lb/hr	tpy
		PM	1.8	7.6
		VOC	1.0	4.4
		Meth. & Methyl Br.	1.00	4.40
1007	Warehouse Baghouse	PM <sub>10</sub>	1.8	7.6
		PM	1.8	7.6
		VOC	1.0	4.4
		Meth. & Methyl Br.	1.00	4.40
1008	TBBPA Ground Flare (GF-08-001)	PM <sub>10</sub>	0.1	0.1
		PM	0.1	0.1
		SO <sub>2</sub>	0.1	0.1
		VOC	1.6	0.3
		CO	3.4	2.2
		NO <sub>x</sub>	0.7	0.4
		Methanol	1.52	0.28
1014	Recycle Water Tank	VOC	0.1	0.5
1015	Chilled Methanol Recirculation Tank #1	VOC	0.1	0.5
		Methanol	0.10	0.44
1016	Chilled Methanol Recirculation Tank #2	VOC	0.1	0.5
		Methanol	0.10	0.44
1019	BPA Mix Tanks water Scrubber	VOC	1.2	5.3
		Methanol	1.20	5.26
1025	MeBr Caustic Vent Scrubber	Br <sub>2</sub>	0.5	2.20
		Cl <sub>2</sub>	0.01	0.05
1030	Cooling Tower	PM <sub>10</sub>	0.1	0.1
		PM	0.1	0.1
1031	Cooling Tower	PM <sub>10</sub>	0.1	0.1
		PM	0.1	0.1
1099	TBBPA Unit Fugitive Emissions (equipment leaks)	VOC	5.3	23.3
		HCl	0.01	0.05
		Methanol	4.94	21.62
		Methyl Bromide	0.39	1.70
1102	Wet Scrubber (VS-10-105)	PM <sub>10</sub>	2.1	8.8
		PM	2.1	8.8
		SO <sub>2</sub>	0.1	0.1
		VOC	0.1	0.1
		CO	0.1	0.2
		NO <sub>x</sub>	0.1	0.3
		HBr	0.5	2.20
		Br <sub>2</sub>	0.5	2.20
		HCl	0.01	0.05

EMISSION SUMMARY				
Source Number	Description	Pollutant	Emission Rates	
			lb/hr	tpy
		Cl <sub>2</sub>	0.01	0.05
1103	Crude Baghouse (BH-10-108)	PM <sub>10</sub>	1.1	4.9
		PM	1.1	4.9
		HBr	2.00	8.76
		Br <sub>2</sub>	2.00	8.76
		HCl	0.02	0.09
		Cl <sub>2</sub>	0.02	0.09
1104	First Grind Baghouse (BH-10-108)	PM <sub>10</sub>	0.6	2.5
		PM	0.6	2.5
		HBr	1.00	4.38
		Br <sub>2</sub>	1.00	4.38
		HCl	0.01	0.05
		Cl <sub>2</sub>	0.01	0.05
1105	Roasted Product Baghouse (BH-10-110)	PM <sub>10</sub>	0.6	2.5
		PM	0.6	2.5
		HBr	0.5	2.19
		Br <sub>2</sub>	0.5	2.19
		HCl	0.01	0.03
		Cl <sub>2</sub>	0.01	0.03
1106	Final Product baghouse (BH-10-111)	PM <sub>10</sub>	0.6	2.5
		PM	0.6	2.5
		HBr	0.5	2.19
		Br <sub>2</sub>	0.5	2.19
		HCl	0.01	0.03
		Cl <sub>2</sub>	0.01	0.03
1107	Caustic Scrubber (VS-10-103)	HBr	0.5	2.20
		Br <sub>2</sub>	0.5	2.20
		HCl	0.01	0.05
		Cl <sub>2</sub>	0.01	0.05
1109	Filter Belt Vacuum Pump (FT-10-112)	VOC	0.1	0.5
		HBr	0.5	2.20
		Br <sub>2</sub>	0.5	2.20
		HCl	0.01	0.05
		Cl <sub>2</sub>	0.01	0.05
1112	Wet Scrubber (VS-10-101)	PM <sub>10</sub>	3.1	13.2
		PM	3.1	13.2
		SO <sub>2</sub>	0.1	0.1
		VOC	0.1	0.1
		CO	0.1	0.2
		NO <sub>x</sub>	0.1	0.3
		HBr	0.5	2.2
		Br <sub>2</sub>	0.5	2.2
		HCl	0.01	0.05



EMISSION SUMMARY				
Source Number	Description	Pollutant	Emission Rates	
			lb/hr	tpy
		Cl <sub>2</sub>	0.01	0.05
1113	Crude Baghouse (BH-10-103)	PM <sub>10</sub>	1.1	4.9
		PM	1.1	4.9
		HBr	2.00	8.76
		Br <sub>2</sub>	2.00	8.76
		HCl	0.02	0.09
		Cl <sub>2</sub>	0.02	0.09
1114	First Grind baghouse (BH-10-107)	PM <sub>10</sub>	0.6	2.4
		PM	0.6	2.4
		HBr	1.00	4.38
		Br <sub>2</sub>	1.00	4.38
		HCl	0.01	0.05
		Cl <sub>2</sub>	0.01	0.05
1115	Roasted Product Baghouse (BH-10-104)	PM <sub>10</sub>	0.6	2.5
		PM	0.6	2.5
		HBr	0.50	2.19
		Br <sub>2</sub>	0.50	2.19
		HCl	0.01	0.03
		Cl <sub>2</sub>	0.01	0.03
1116	Final Product Baghouse (BH-10-105)	PM <sub>10</sub>	0.6	2.7
		PM	0.6	2.7
		HBr	0.50	2.19
		Br <sub>2</sub>	0.50	2.19
		HCl	0.01	0.03
		Cl <sub>2</sub>	0.01	0.03
1123	Packaging Baghouse (BH-10-112)	PM <sub>10</sub>	0.4	1.5
		PM	0.4	1.5
		HBr	0.5	2.19
		Br <sub>2</sub>	0.5	2.19
		HCl	0.01	0.03
		Cl <sub>2</sub>	0.01	0.03
1140	Cooling Tower (CT-10-101)	PM <sub>10</sub>	0.6	2.3
		PM	0.6	2.3
1141	Cooling Tower (CT-10-102)	PM <sub>10</sub>	0.6	2.3
		PM	0.6	2.3
1142	Cooling Tower (CT-10-103)	PM <sub>10</sub>	0.6	2.3
		PM	0.6	2.3
1150	Methanol Surge Tank (TT-10-615)	VOC	0.3	0.3
		Methanol	0.26	0.26
1199	Fugitive Equipment Leaks	VOC	2.2	9.7
		Hydrazine	0.001086	0.04758
		Methanol	2.194	9.608

EMISSION SUMMARY				
Source Number	Description	Pollutant	Emission Rates	
			lb/hr	tpy
1202	Bromine Tank Scrubber (VS-11-507)	Br <sub>2</sub>	0.1	0.5
		Cl <sub>2</sub>	0.01	0.05
1203	Lime silo with Fabric Filter (TT-12-801)	PM <sub>10</sub>	0.1	0.5
		PM	0.1	0.5
1204	Calcium Bromide Reactors Vent with Caustic Scrubber (VS-12-827)	HBr	1.2	5.3
		Br <sub>2</sub>	1.2	5.3
		HCl	0.01	0.05
		Cl <sub>2</sub>	0.01	0.05
1220	Cooling Tower (CT-12-800)	PM <sub>10</sub>	0.4	1.5
		PM	0.4	1.5
1221	Cooling Tower (VS-12-808)	PM <sub>10</sub>	0.1	0.2
		PM	0.1	0.2
1230	Bromine Tanks with Scrubber (VS-11-301)	HBr	0.1	0.5
		Br <sub>2</sub>	0.1	0.5
		HCl	0.01	0.05
		Cl <sub>2</sub>	0.01	0.05
1299	Fugitive Equipment Leaks	Hydrazine	0.08	0.33
1301	OCP Facility Flare	PM <sub>10</sub>	0.1	0.2
		PM	0.1	0.2
		SO <sub>2</sub>	0.1	0.1
		VOC	1.1	4.9
		CO	1.8	7.9
		NO <sub>x</sub>	0.4	1.5
		Benzene	0.01	0.01
		Beryllium	0.01	0.01
		Cadmium	0.01	0.01
		Chromium	0.01	0.01
		Cobalt	0.01	0.01
		Dichlorobenzene	0.01	0.01
		Formaldehyde	0.01	0.01
		Hexane	0.01	0.01
		Manganese	0.01	0.01
		Mercury	0.01	0.01
		Naphthalene	0.01	0.01
Nickel	0.01	0.01		
Selenium	0.01	0.01		
Toluene	0.01	0.01		
POM	0.01	0.01		
1314	Roasted Baghouse (BH-13-004)	PM <sub>10</sub>	0.2	0.7
		PM	0.2	0.7

EMISSION SUMMARY				
Source Number	Description	Pollutant	Emission Rates	
			lb/hr	tpy
		VOC	5.0	22.1
1315	Final Baghouse (BH-13-005)	PM <sub>10</sub>	0.3	1.2
		PM	0.3	1.2
		VOC	0.1	0.6
1337	LAC Filter Receiver Fabric Filter (BH-13-297)	PM <sub>10</sub>	0.2	0.8
		PM	0.2	0.8
		Br <sub>2</sub>	1.00	4.38
		Cl <sub>2</sub>	0.01	0.05
1350	CN-3370 Bromine Storage tank caustic Vent Scrubber	Br <sub>2</sub>	0.11	0.07
		Cl <sub>2</sub>	0.01	0.05
1351	CN-3370 Polymer Unloading	PM <sub>10</sub>	0.5	1.2
		PM	1.0	2.5
1361	CN-3370 Cooling Tower	PM <sub>10</sub>	0.5	1.9
		PM	0.5	1.9
1362	Cooling Tower	PM <sub>10</sub>	0.2	0.5
		PM	0.2	0.5
1398	CN-3370 Fugitives	VOC	1.5	6.6
		Br <sub>2</sub>	1.5	6.52
		Methylene Chloride	1.5	6.52
1399	Fugitive Equipment Leaks	VOC	1.9	8.1
		Methanol	1.85	8.07
1403	Oligomer Baghouse #2 (BH- 174-002)	PM <sub>10</sub>	1.8	7.6
		PM	1.8	7.6
		VOC	1.0	4.4
		Ethyl Chloride	0.01	0.44
		Methylene Chloride	2.00	8.76
		Triethylamine	0.01	0.44
1404	MCRU Absorber (CL-14-501)	VOC	2.0	8.8
		CO	0.1	0.5
		Ethyl Chloride	2.00	8.76
		Methylene Chloride	0.50	2.19
		Triethylamine	0.01	0.44
		TEA & Ethyl Chloride	0.01	0.44
1406A	Centrifuge #1 (CF- 14-001)	VOC	0.1	0.5
		Ethyl Chloride	0.01	0.44
		Methylene Chloride	0.01	0.44
		Triethylamine	0.01	0.44
1406B	Centrifuge #2 (CF- 14-002)	VOC	0.1	0.5
		Ethyl chloride	0.01	0.44
		Methylene Chloride	0.01	0.44
		Triethylamine	0.01	0.44

EMISSION SUMMARY				
Source Number	Description	Pollutant	Emission Rates	
			lb/hr	tpy
1409	Acid Tank Vent Scrubber (VS-14-225)	HCl	1.70	2.05
1413	Oligomer Baghouse #1 (BH-14-001)	PM <sub>10</sub>	2.0	8.7
		PM	2.0	8.7
		VOC	1.0	4.4
		Ethyl Chloride	0.01	0.44
		Methylene Chloride	2.00	8.76
		Triethylamine	0.01	0.44
1420	TCO Wastewater Sump	VOC	1.0	4.4
		Ethyl Chloride	0.55	2.41
		Methylene Chloride	0.25	1.10
		Triethylamine	0.02	0.09
1421	TCO Wastewater Tank (TT-14-028)	VOC	0.1	0.1
		Ethyl Chloride	0.01	0.01
		Methylene Chloride	0.04	0.02
		Triethylamine	0.01	0.01
1422	TCO Wastewater Tank (TT-14-029)	VOC	0.1	0.1
		Ethyl Chloride	0.01	0.01
		Methylene Chloride	0.04	0.02
		Triethylamine	0.01	0.01
1423	Surge Hopper Vent Filter (BH-14-701)	PM <sub>10</sub>	0.3	1.2
		PM	0.3	1.2
1430	Water Tank (TT-14-034)	Methylene Chloride	0.10	0.44
1431	Water Tank (TT-14-035)	Methylene Chloride	0.10	0.44
1433	Cooling Tower (CT-14-101)	PM <sub>10</sub>	0.4	1.7
		PM	0.4	1.7
1435	Phosgene Scrubber	Phosgene	0.06	0.27
1499	Fugitive Equipment Leaks	VOC	3.3	14.1
		Ethyl Chloride	0.83	3.67
		HCl	0.45	1.98
		Methylene Chloride	1.81	7.95
		Phosgene	0.83	3.67
		Triethylamine	2.41	10.56
1501	Bromine Container Cleaning Scrubber (VS-03-008)	Br <sub>2</sub>	1.00	4.40
		Cl <sub>2</sub>	0.01	0.05
		HBr	1.00	4.40
1504	North Drum/Cylinder	VOC	1.2	5.1
		HBr	0.10	0.44

EMISSION SUMMARY				
Source Number	Description	Pollutant	Emission Rates	
			lb/hr	tpy
	Station (WT-03-005)	HCl	0.01	0.05
1551	Bromine Packaging Scrubber (VS-03-001)	Br <sub>2</sub>	0.50	2.20
		Cl <sub>2</sub>	0.10	0.44
1552	South Drum Station (WT-03-001)	VOC	1.6	7.1
		Ammonium Bromide	0.01	0.02
1599	Fugitive Equipment Leaks	VOC	1.5	6.5
1903	TBBPA Emergency Generator	PM <sub>10</sub>	0.5	0.2
		PM	0.5	0.2
		SO <sub>2</sub>	0.5	0.2
		VOC	0.6	0.2
		CO	1.5	0.4
		NO <sub>x</sub>	6.8	1.7
		Benzene	0.01	0.01
		Formaldehyde	0.01	0.01
		Naphthalene	0.01	0.01
		Toluene	0.01	0.01
		Acetaldehyde	0.01	0.01
		Acrolein	0.01	0.01
		1,3-Butadiene	0.01	0.01
		Xylenes	0.01	0.01
POM	0.01	0.01		
1904	P & S Emergency Generator	PM <sub>10</sub>	0.4	0.1
		PM	0.4	0.1
		SO <sub>2</sub>	0.4	0.1
		VOC	0.4	0.1
		CO	1.1	0.3
		NO <sub>x</sub>	4.9	1.3
		Benzene	0.01	0.01
		Formaldehyde	0.01	0.01
		Naphthalene	0.01	0.01
		Acetaldehyde	0.01	0.01
		Acrolein	0.01	0.01
		1,3-Butadiene	0.01	0.01
		Xylenes	0.01	0.01
		POM	0.01	0.01
1905	North Emergency Firewater Pump Engine (300 hp)	PM <sub>10</sub>	0.7	0.2
		PM	0.7	0.2
		SO <sub>2</sub>	0.7	0.2
		VOC	0.8	0.2
		CO	2.0	0.5

EMISSION SUMMARY				
Source Number	Description	Pollutant	Emission Rates	
			lb/hr	tpy
		NO <sub>x</sub>	9.3	2.4
		Benzene	0.01	0.01
		Formaldehyde	0.01	0.01
		Naphthalene	0.01	0.01
		Toluene	0.01	0.01
		Acetaldehyde	0.01	0.01
		Acrolein	0.01	0.01
		1,3-Butadiene	0.01	0.01
		Xylenes	0.01	0.01
		POM	0.01	0.01
1906	South Emergency Firewater Pump Engine (300 hp)	PM <sub>10</sub>	0.7	0.2
		PM	0.7	0.2
		SO <sub>2</sub>	0.7	0.2
		VOC	0.8	0.2
		CO	2.0	0.5
		NO <sub>x</sub>	9.3	2.4
		Benzene	0.01	0.01
		Formaldehyde	0.01	0.01
		Naphthalene	0.01	0.01
		Toluene	0.01	0.01
		Acetaldehyde	0.01	0.01
		Acrolein	0.01	0.01
		1,3-Butadiene	0.01	0.01
		Xylenes	0.01	0.01
POM	0.01	0.01		
1907	#1 Generator Engine	PM <sub>10</sub>	1.4	0.4
		PM	1.4	0.4
		SO <sub>2</sub>	1.3	0.4
		VOC	1.5	0.4
		CO	4.0	1.0
		NO <sub>x</sub>	18.6	4.7
		Benzene	0.01	0.01
		Formaldehyde	0.01	0.01
		Naphthalene	0.01	0.01
		Toluene	0.01	0.01
		Acetaldehyde	0.01	0.01
		Acrolein	0.01	0.01
		1,3-Butadiene	0.01	0.01
		Xylenes	0.01	0.01
POM	0.01	0.01		
1908	#2 Generator Engine	PM <sub>10</sub>	1.4	0.4
		PM	1.4	0.4
		SO <sub>2</sub>	1.3	0.4

EMISSION SUMMARY				
Source Number	Description	Pollutant	Emission Rates	
			lb/hr	tpy
		VOC	1.5	0.4
		CO	4.0	1.0
		NO <sub>x</sub>	18.6	4.7
		Benzene	0.01	0.01
		Formaldehyde	0.01	0.01
		Naphthalene	0.01	0.01
		Toluene	0.01	0.01
		Acetaldehyde	0.01	0.01
		Acrolein	0.01	0.01
		1,3-Butadiene	0.01	0.01
		Xylenes	0.01	0.01
		POM	0.01	0.01
1909	#3 Generator Engine	PM <sub>10</sub>	1.4	0.4
		PM	1.4	0.4
		SO <sub>2</sub>	1.3	0.4
		VOC	1.5	0.4
		CO	4.0	1.0
		NO <sub>x</sub>	18.6	4.7
		Benzene	0.01	0.01
		Formaldehyde	0.01	0.01
		Naphthalene	0.01	0.01
		Toluene	0.01	0.01
		Acetaldehyde	0.01	0.01
		Acrolein	0.01	0.01
		1,3-Butadiene	0.01	0.01
		Xylenes	0.01	0.01
POM	0.01	0.01		

\*HAPs not included in the VOC or particulate totals.

\*\*Air Contaminants such as ammonia, acetone, and certain halogenated solvents are not VOCs or HAPs.

~Annual Bubble for SN-301, SN-902, and SN-903.

### **SECTION III: PERMIT HISTORY**

Permit #289-A was issued on March 27, 1975. This permit allowed GLCC to install a baghouse for controlling emissions from the spray drying operation.

Permit #199-I was issued on April 1, 1974. This permit allowed GLCC to install an incinerator to burn 600 pounds per day of type 0 waste.

Permit #307-A was submitted on August 25, 1975. This permit allowed GLCC to install seven flares at the bromine well sites.

Permit #395-A was issued on January 28, 1977. This permit allowed GLCC to replace an existing bromine extraction tower with a tower of the same capacity.

Permit #400-A was issued on February 25, 1977. This permit allowed GLCC to install a drying unit for their DE-83 process.

Permit #457-A was issued on March 24, 1978. This permit allowed GLCC to route a gas stream of 11.1 SCFM of 76.6% ethylene dibromide (the balance being air and water) into their steam generating boiler.

Permit #307-AR-1 was issued on June 14, 1978. This modification allowed GLCC to construct and operate a new brine well (#11) and discontinue operation of brine wells #3 and #4.

Permit #525-A was issued on November 17, 1978. This permit allowed GLCC to construct a unit to produce anhydrous hydrogen bromide.

Permit #307-AR-2 was issued on December 27, 1978. This modification allowed GLCC to install a sodium hydrosulfide unit at its central bromine extraction and chemical production unit.

Permit #553-A was issued on May 25, 1979. This permit allowed GLCC to construct a unit to produce calcium bromide.

Permit #610-A was issued on April 4, 1980. This permit allowed GLCC to construct a unit to produce tetrabromobisphenol A and methyl bromide.

Permit #616-A was issued on May 23, 1980. This permit allowed GLCC to construct a unit to produce an intermediate chemical used in the production of an insecticide.

Permit #344-I was issued on January 1, 1981. This permit allowed GLCC to install a chemical waste incinerator with a rated capacity of 600 pounds per hour. This incinerator was used to recover bromine from waste chemicals and to recover the wasted heat from by-products.

Permit #616-AR-1 was issued on April 9, 1981. This modification allowed GLCC to construct a unit to produce dibromodimethylhydantoin.

Permit #653-A was issued on May 22, 1981. This permit allowed GLCC to construct a unit to produce tetrabromobisphenol-A oligomer.

Permit #786-A was issued on February 13, 1986. This permit allowed GLCC to manufacture Santogard HTM at their existing aldehyde unit.

Permit #786-AR-1 was issued on February 20, 1987. This permit allowed GLCC to manufacture Kelthane (1,1-Bis(chlorophenyl)-2,2,2-trichloroethane) and FM-836 at their existing MPBz unit.



Great Lakes Chemical Corporation - Central Plant  
Permit #: 1077-AOP-R5  
AFIN: 70-00012

Permit #783-A was issued on April 30, 1987. This permit allowed GLCC to install a temporary air stripper to remove volatile organic compounds from an existing recovery well adjacent to the process water pond.

Permit #783-AR-1 was issued on June 5, 1987. This modification allowed GLCC to pump the groundwater recovery wells up to 48 hours each, at a low flow rate, air-strip the volatiles, and use the effluent to produce bromine.

Permit #947-A was issued on August 17, 1989. This permit allowed GLCC to remediate contaminated groundwater.

Permit #955-A was issued on December 18, 1989. This permit identified the products produced at the Fine Chemical unit.

Permit #1006-A was issued on February 28, 1990. This permit allowed GLCC to replace its existing feed brine ponds at its Central plant with a scrubber brine cooling system (SBCS). The brine pond was replaced as part of a ground water clean up program.

Permit #1077-A was issued on September 17, 1991. This modification covered replacing both bromine towers and venting waste gases generated during the production of ethylene dibromide (EDB) to the #2 boiler. In addition, this permit consolidated the facility's boilers, bromine production unit, ethylene dibromide unit, sodium hydrosulfide (NaHS) unit, and brine supply wells.

Permit #1077-AR-1 was issued on March 12, 1993. This modification rescinded all of the air permits issued to Great Lakes Chemical Corporation and issued one permit that included all of the process units and emission sources at this facility which required permitting.

Permit #1077-AR-2 was issued on August 2, 1993. This modification covered revisions to the hydrosulfide, fine chemicals, tetrabromobisphenol-A, brominated organic compounds, calcium bromide/hydrogen bromide, OCP, TCO, and packaging and shipping units of the permit. In addition, a new unit was added to include miscellaneous process units. Permit 1077-AR-2 allowed for an increase of 32.2 tons per year of particulate matter, 0.4 tons per year of sulfur dioxide, 62.0 tons per year of volatile organic compounds, 2.31 tons per year of hydrogen bromide, and decreases of 0.36 tons per year of HCl, 3.93 tons per year of chlorine, 0.12 tons per year of ammonia.

Permit #1077-AR-3 was issued on June 30, 1995. This modification covered installation of a new boiler used to increase steam production capacity, construction of a leachate treatment plant, an additional hydrogen bromide solution tank at the Calcium Bromide/Hydrogen Bromide unit, production of DCDMH at the Organic Chemical Processing (OCP) unit, and to document the replacement of a baghouse at the OCP unit which was moved to the TCO unit. Permit 1077-AR-3 allowed for an increase of 14.9 tons per year of particulate matter, 2.0 tons per year of sulfur dioxide, 48.9 tons per year of volatile organic compounds, 30.8 tons per year of carbon monoxide, 506.2 tons per year of nitrogen oxides, 0.45 tons per year of hydrogen sulfide, 14.68 tons per year of bromine, 9.21 tons per year hydrogen bromide, 3.76 tons per year of HCl, 3.71 tons per year of chlorine, 2.53 tons per year of bromochlorine, 2.3 tons per year of ammonia, 1.8 tons per year of carbon tetrachloride, 6.1 tons per year of hydrogen, and 0.4 tons per year of hydrazine. This permit was used to establish the emission baseline for this facility. It set forth

Great Lakes Chemical Corporation - Central Plant  
Permit #: 1077-AOP-R5  
AFIN: 70-00012

the requirement that if the facility shows an increase in excess of the significance levels and cannot show a contemporaneous reduction then PSD permitting activities would be required.

Permit #1077-AR-4 was issued on November 27, 1995. This modification allowed GLCC to increase production of DE-83 in the OCP unit and boiler #2 and #3 to burn “sweetened” gas from the Lion Oil JV Amine unit. Permit #609-AR-2 allowed an increase of 13.1 tons per year of particulate matter and 0.4 tons per year of volatile organic compounds.

Permit #1077-AR-5 was issued on June 14, 1996. This modification covered increasing emissions of volatile organic compounds and incorporated emissions of chlorine, HCl, bromine, and hydrogen bromine that were not previously permitted from the ozone reaction system. Permit 1077-AR-5 allowed for an increase of 1.8 tons per year of volatile organic compounds, 0.5 tons per year of bromine, 0.4 tons per year of hydrogen bromine, 0.4 tons per year of HCl, and 0.4 tons per year of chlorine.

Permit #1077-AR-6 was issued on November 13, 1996. This modification allowed GLCC to increase the emissions from TBBPA bulk loading, methanol tank, and spray dryer, increased the amount of products drummed in the packaging and shipping unit, documented the installation of two chilled methanol tanks and a centrifuge, established the HALAR/Teflon coating section as an independent section, and identified the time that the canning machine is routed to the BRU. Permit 1077-AR-6 allowed for an increase of 9.3 tons per year of particulate matter, 0.5 tons per year of sulfur dioxide, 6.1 tons per year of volatile organic compounds, 0.5 tons per year of carbon dioxide, 1.8 tons per year of nitrogen oxides, 0.9 tons per year of non-volatile organic compounds, 1.1 tons per year of HCl, and 2.4 tons per year of hydrogen fluoride.

Permit #1077-AOP-R0 was issued December 19, 2008. This was the initial Title V Operating Air Permit for this existing facility.

Permit #1077-AOP-R1 was issued January 26, 2010. This permit modification included a process change for the production of methyl bromide in the TBBPA unit. This process change will utilize existing equipment within the TBBPA unit; however GLCC had to add a caustic scrubber (SN-1025) and a spent caustic tank (insignificant activity) to control emissions from a process vessel. This modification increased BR<sub>2</sub> and Cl<sub>2</sub> emissions by 2.2 and 0.4 tons per year respectively. Also, this permit action allowed the operation of Scrubbers SN-1001A and SN-1001B in series.

Permit #1077-AOP-R2 was issued January 25, 2016. This permit action incorporated the facility’s renewal permit application. Included in this permit action was the removal of the Fine Chemicals Unit (SN-603, SN-604, SN-609, SN-610, and SN-615) and transfer of SN-657 to the Alkyl Bromide Unit. Also, the Spray Dryer Unit (SN-801) was removed from the permit. This permit action also incorporated the installation of a new caustic scrubber system (SN-1435), replaced a flare (SN-1008), and allowed a sour gas backup flare (SN-903) in the Boilers and NaHS Process Unit. This permit action decreased permitted criteria pollutant emissions by 29.2 tons of PM per year, 30.2 tons of PM<sub>10</sub> per year, 2.8 tons of SO<sub>2</sub> per year, 55 tons per year of NO<sub>x</sub>. Overall permitted HAP pollutant emissions decreased as well.

Great Lakes Chemical Corporation - Central Plant

Permit #: 1077-AOP-R5

AFIN: 70-00012

Permit #1077-AOP-R3 was issued April 5, 2017. This action permitted emergency engine replacement (SN-1903), operation of a cooling tower (SN-909), added a 25-kg packaging system to the insignificant activity list, and finally allowed the facility flexibility to combust fuel gasses (i.e., partially sweet fuel gas from the NaHS Plant or “sweetened” gas from the JV Amine Unit at Lion Oil Company in the facility’s Boiler #2 (SN-301) and Flare (SN-902B) simultaneously. This permit action included emission increases of 9.9 tpy of PM/PM<sub>10</sub>, 0.2 tpy of SO<sub>2</sub>, 6.8 tpy of NO<sub>x</sub>, and emission decreases of 50.9 tpy of VOC, and 127.7 tpy of CO. Overall HAP emissions decreased as well.

## SECTION IV: SPECIFIC CONDITIONS

SN-402, SN-403, SN-405, SN-411, SN-412, SN-413, SN-499  
Bromine Production Unit

### Source Description

GLCC Central operates the Bromine Production Unit to produce bromine for use in other Central Plant process units/areas. The major steps in the production of bromine are described below.

- Bromine is extracted from a feed brine solution
- Chlorine from the extraction process is stripped from the bromine stream
- Non-volatiles are stripped from the bromine stream
- The bromine is dried
- The bromine product is stored
- The bromine product is shipped

### Bromine Production

Bromine occurs naturally in brines found throughout south Arkansas. The feed brine is collected at supply wells throughout the area serving GLCC Central. In addition to bromine, the brine also contains sour gas and sodium bromide. This gas is separated and sent to the NaHS plant for treatment.

In the bromine tower, the brine is chlorinated to remove the bromine which is steam stripped and condensed. The bromine vapors are condensed, purified and then packaged in tank trucks, railcars, ISOs or bulk containers. Bromine vapors displaced during the packaging and loading operations as well as several process tanks are controlled by a caustic scrubber (SN-405).

### Air Pollutant Emissions

The predominant air pollutant emissions sources in the Bromine Production Unit are process vessels and storage vessels. Water and/or caustic vent scrubbers are used to control emissions from process vessels (i.e. reactors, strippers, etc.) operated in the Bromine Production Unit. Storage vessels with minimal emissions vent to atmosphere.

GLCC Central operates a total of three cooling towers in the Bromine Production Unit. Two of these (SN-412 and 413) are the tail brine cooling towers which circulate tail brine that has been processed through the bromine unit to remove the bromine. Due to the high brine concentration (up to 36% by weight), the emissions from these towers are significantly higher than those from the other cooling tower (SN-411) which utilize standard water.

SN-402 is a pressure relief emergency vent; these emissions only occur due to process upsets. Any Hydrogen Bromine or Bromine emissions from SN-402 will be considered an upset condition and shall be reported as such to ADEQ. The two tail brine surge tanks vent through a

combined vent (SN-403). Emissions occur at various connectors, pumps, and valves associated with piping for this process (SN-499).

### Specific Conditions

- The permittee shall not exceed the emission rates set forth in the following table. The permittee shall demonstrate compliance with this condition by compliance with Specific Conditions 11, 12, and 13. [Reg.19.501 *et seq.* and 40 C.F.R. § 52 Subpart E]

SN	Description	Pollutant	lb/hr	tpy
402	Alternate Vent Scrubber	No emissions allowed except in emergency		
411	Cooling Tower (CT-01-090)	PM <sub>10</sub>	0.8	3.3
412	Cooling Tower (CT-01-127)	PM <sub>10</sub>	0.1	0.5
		VOC	0.1	0.5
413	Cooling Tower (CT-01-227)	PM <sub>10</sub>	0.1	0.5
		VOC	0.1	0.5

- The permittee shall not exceed the emission rates set forth in the following table. For SN-405, compliance shall be demonstrated by compliance with Specific Conditions 4 and 6. For SN-403, compliance shall be demonstrated by compliance with Specific Condition 9. For SN-411, SN-412, and SN-413, compliance shall be demonstrated by compliance with Specific Conditions 11, 12, and 13. [Reg.18.801 and Ark. Code Ann. § 8-4-203 as referenced by Ark. Code Ann. §§ 8-4-304 and 8-4-311]

SN	Description	Pollutant	lb/hr	tpy
402	Alternate Vent Scrubber	No emissions allowed except in emergency		
403	Tail Brine Surge Tanks Combined Vent (TT-01-063 & TT-01-066)	HBr	0.1	0.44
		Br <sub>2</sub>	0.1	0.44
		HCl	0.01	0.05
		Cl <sub>2</sub>	0.01	0.05
405	Bromine Production with Caustic Scrubber (VS-01-097)	HBr	0.5	2.19
		Br <sub>2</sub>	0.5	2.19
		HCl	0.01	0.05
		Cl <sub>2</sub>	0.01	0.05
411	Cooling Tower (CT-01-090)	PM	0.8	3.3
412	Cooling Tower (CT-01-127)	PM	0.1	0.5
		HBr	0.01	0.05
		HCl	0.01	0.05
413	Cooling Tower (CT-01-227)	PM	0.1	0.5
		HBr	0.01	0.05

SN	Description	Pollutant	lb/hr	tpy
		HCl	0.01	0.05
499	Bromine Production Unit Fugitive Equipment Leaks	HCl Cl <sub>2</sub>	0.32 1.08	1.4 4.7

3. Visible emissions may not exceed the limits specified in the following table of this permit as measured by EPA Reference Method 9.

SN	Description	Limit	Observation Frequency	Regulatory Citation
403	Tail Brine Surge Tanks Combined Vent (TT-01-063 & TT-01-066)	5%	Inspector Observation	Reg.18.501
405	Bromine Production with Caustic Scrubber (VS-01-097)	5%	Inspector Observation	Reg.18.501

4. Weekly observations of opacity from SN-403 shall be conducted by a person trained but not necessarily certified in EPA Reference Method 9. If visible emissions in excess of the permitted levels are detected, the permittee shall immediately take action to identify the cause of the visible emissions in excess of the permit limit, implement the corrective action within twelve hours, and perform an EPA Reference Method 9 test to verify emissions are not in excess of the permitted level. The permittee shall maintain records which contain the following items in order to demonstrate compliance with this Specific Condition. These records shall be updated weekly, kept on site, and made available to Department personnel upon request.
- The date and time of the observation.
  - If visible emissions which appeared to be above the permitted limit were detected.
  - If visible emissions which appeared to be above the permitted limit were detected, the cause of the exceedance of the opacity limit, the corrective action taken, and if visible emissions appeared to be below the permitted limit after the corrective action was taken.
  - The name of the person conducting the opacity observations.
5. The permittee shall maintain the control equipment parameters shown in the following table. The permittee shall monitor these parameters every twelve hours of operation of the source and keep written records of the readings. These records shall be kept on site and made available to Department personnel upon request. If the caustic concentration and caustic solution flow rate falls below the minimum listed value, corrective action shall be taken immediately and the situation corrected within twelve hours. The permittee shall maintain records of sampling and corrective actions taken. These parameters were established at the time of permit application. [Reg.19.303 and Ark. Code Ann. § 8-4-203 as referenced by Ark. Code Ann. §§ 8-4-304 and 8-4-311]

SN	Description	Control Equipment	Minimum Operating Limits
405	Bromine Production with Caustic Scrubber (VS-01-097)	Scrubber	5.0 gal/min of caustic solution  5% by wt. caustic concentration

6. The permittee shall test SN-405 as specified in the following table in accordance with the test procedures listed and according to the minimum scrubber parameters in Specific Condition 5. The facility shall document the production rate of the bromine production unit during the performance test and make production rate data available to the ADEQ inspector during the test. The permittee shall be limited to operating at no more than 10% above the tested production rate until the next performance test is conducted pursuant to this specific condition. The permittee may re-test at any time in order to establish a different production limit, provided that testing is conducted once every five year permit period. [Reg.18.1002 and Ark. Code Ann. § 8-4-203 as referenced by Ark. Code Ann. §§ 8-4-304 and 8-4-311]

Source	Pollutant	Test Method
SN-405	HBr BR <sub>2</sub>	EPA Reference Method 26 or 26A EPA Reference Method 26 or 26A

7. The permittee shall maintain monthly records which document that the production limit established in Specific Condition 6 has not been exceeded. The permittee shall maintain a twelve month rolling average and update the records by the fifteenth of the following month. These records shall be made submitted to Department in accordance with General Condition #7. [Reg.18.1004 and Ark. Code Ann. § 8-4-203 as referenced by Ark. Code Ann. §§ 8-4-304 and 8-4-311][Reg.18.1004 and Ark. Code Ann. § 8-4-203 as referenced by Ark. Code Ann. §§ 8-4-304 and 8-4-311]
8. The permittee shall use only the scrubbing parameters designated in Specific Condition 5. During the interim time between emissions testing and the receipt of the results, the permittee may continue to operate under the scrubber operating parameters present at the time of the emissions testing. In the event that emissions testing results indicate emissions in excess of the permitted limits, the permittee shall take corrective actions as quickly as practicable and shall notify the Department of the deviation as required by General Provision #8. [Reg.19.705, Ark. Code Ann. § 8-4-203 as referenced by Ark. Code Ann. §§ 8-4-304 and 8-4-311, and 40 C.F.R. § 70.6]
9. The permittee shall test SN-403 as specified in the following table in accordance with the test procedures listed. Each test shall consist of at least 3 sampling periods at a minimum of 1 hour each. The facility shall document the production rate of the bromine production

unit during the performance test and make production rate data available to the ADEQ inspector during the test. The permittee shall be limited to operating at no more than 10% above the tested production rate until the next performance test is conducted pursuant to this Specific condition. This testing is to be completed every 5 year permit period. This test data shall be used for determination of compliance with the conditions set forth in this permit. [Reg.18.1002 and Ark. Code Ann. § 8-4-203 as referenced by Ark. Code Ann. §§ 8-4-304 and 8-4-311]

Source	Pollutant	Test Method
SN-403	BR <sub>2</sub>	EPA Reference Method 26 or 26A

10. The permittee shall maintain monthly records which document that the production limit established in Specific Condition 9 has not been exceeded. The permittee shall maintain a twelve month rolling average and update the records by the fifteenth of the following month. These records shall be submitted to Department in accordance with General Condition #7. [Reg.18.1004 and Ark. Code Ann. § 8-4-203 as referenced by Ark. Code Ann. §§ 8-4-304 and 8-4-311]

11. The water flow rates, in the following table shall not be exceeded. The permittee shall maintain, on site, documentation that the physical flow capacities of SN-411, SN-412 and SN-413 meet the values in the table. [Reg.19.705, Ark. Code Ann. § 8-4-203 as referenced by Ark. Code Ann. §§ 8-4-304 and 8-4-311, and 40 C.F.R. § 70.6]

SN	Description	Maximum Water Flow Rate through Tower (gallons per minute)
411	Cooling Tower (CT-01-090)	2,500
412	Cooling Tower (CT-01-127)	1,500
413	Cooling Tower (CT-01-227)	1,500

12. The total dissolved solids concentrations or correlated conductivity, measured monthly, in the following table shall not be exceeded. The permittee shall demonstrate compliance by compliance with Specific Condition 13. [Reg.19.705, Ark. Code Ann. § 8-4-203 as referenced by Ark. Code Ann. §§ 8-4-304 and 8-4-311, and 40 C.F.R. § 70.6]

SN	Description	Maximum Total Dissolved Solids Concentration or Conductivity
411	Cooling Tower (CT-01-090)	12,000 ppm TDS/13,961 µS
412	Cooling Tower (CT-01-127)	375,000 ppm/431,592 µS
413	Cooling Tower	375,000 ppm/431/592 µS



Great Lakes Chemical Corporation - Central Plant

Permit #: 1077-AOP-R5

AFIN: 70-00012

SN	Description	Maximum Total Dissolved Solids Concentration or Conductivity
	(CT-01-227)	

13. The permittee shall monitor and maintain monthly records of the Total Dissolved Solids (TDS) or correlated conductivity. These records shall be kept on-site and made available to Department personnel upon request. [Reg.19.705 and 40 C.F.R. § 52 Subpart E]
14. The cooling towers shall be equipped with drift eliminators. Documentation shall be onsite to document compliance with this condition. [Reg.19.705, Ark. Code Ann. § 8-4-203 as referenced by Ark. Code Ann. §§ 8-4-304 and 8-4-311, and 40 C.F.R. § 70.6]

SN	Description	Maximum Drift Rate	Minimum control
411	Cooling Tower (CT-01-090)	0.005%	N/A
412	Cooling Tower (CT-01-127)	N/A	99%
413	Cooling Tower (CT-01-227)	N/A	99%

15. The permittee shall maintain records of any use of SN-402 and report by Reg.19.601. [Ark. Code Ann. § 8-4-203 as referenced by Ark. Code Ann. §§ 8-4-304 and §8-4-311]

Great Lakes Chemical Corporation - Central Plant  
Permit #: 1077-AOP-R5  
AFIN: 70-00012

SN-605, SN-612, SN-653, SN-654, SN-657, SN-658, SN-660, SN-661, SN-664, SN-672, SN-673, SN-699  
Alkyl Bromides Unit

### Source Description

GLCC Central manufactures various alkyl bromide products for commercial sale. Products manufactured include, but are not limited to:

- N-propyl bromide
- N-butyl bromide
- Ethyl bromide

The major steps in the production of alkyl bromides are described below.

- Raw materials are stored in tanks
- Raw materials are reacted with hydrogen bromide (HBr) from the HBr burner
- Crude reactor product is stripped of HBr
- HBr is collected in a storage tank
- Stripped product is neutralized, washed, and dried
- Raw product is stored in tanks
- Product is shipped via truck or drum

In addition, GLCC operates storage tanks for methyl bromide at the Alkyl Bromides Unit. Methyl bromide from other GLCC Central process units/areas is received, stored, and dried prior to transfer to other GLCC Central process units/areas or load out to truck and/or railcar.

### Air Pollutant Emissions

The predominant air pollutant emissions sources in the Alkyl Bromides Unit are raw material and product storage vessels. Emissions from the ethyl bromide storage tank are controlled using an overhead condenser. Emissions from other storage vessels are vented to the atmosphere. Vapors from the Methyl Bromide Storage operations are controlled using overhead condensers prior to being routed to the BRU.

Hydrogen bromide solution is made in the alkyl bromide reactor by absorbing gas in water. This process is similar to the production of HBr solution in the heavy fluids reactor. The final product is distilled and any hydrogen bromide gas that passes through the absorber is routed to a water scrubber that vents to the atmosphere at SN-657. This process was previously permitted as part of the Fine Chemicals Unit, but is now considered part of the Alkyl Bromide Plant.

The product storage tanks (SN-605, SN-653, and SN-672) are used to store alkyl bromides. A product mix tank (TT-22-653) can now vent to the atmosphere; it is an insignificant activity (A.13). SN-612 is an HBr scrap storage tank. SN-654 is a refrigerated methanol recirculation tank. This tank contains a solution of methanol in water kept at approximately 10°F. SN-658 is an HBr solution storage tank. SN-660 is a product storage tank kept at 10°F. SN-661 and SN-664 are raw material storage tanks. Emissions occur from the loadout (SN-673) of products to

trucks and railcars. Emissions occur at the various connectors, pumps, and valves associated with the piping for this process and are permitted at SN-699.

Process Changes

With this permit renewal, several sources are requested to be removed due to process changes, these include: SN-616, SN-655, SN-665, SN-670, and SN-671. As mentioned above, SN-657 is transferred from the Fine Chemicals Unit. This is a water scrubber not a caustic scrubber. Also, TK-22-653 is proposed to reflect possible emissions to the atmosphere from product mixing as an insignificant activity.

Regulatory Applicability

Beyond the regulatory applicability indicated in the Facility Regulatory Applicability Section, equipment associated with ethyl bromide production at the Alkyl Bromides Unit is subject to the *Standards of Performance for Equipment Leaks of VOC in the Synthetic Organic Chemicals Manufacturing Industry* - 40 CFR Part 60, Subpart VV.

Also, certain equipment located at the at the Alkyl Bromides Unit is also subject to the *National Emission Standards for Hazardous Air Pollutants for Organic Liquids Distribution* – 40 CFR Part 63 Subpart EEEE.

Also, certain equipment located at the Alkyl Bromides Unit is also subject to the *National Emission Standards for Hazardous Air Pollutants for Organic Liquids Distribution* – 40 CFR Part 63, Subpart EEEE.

Specific Conditions

16. The permittee shall not exceed the emission rates set forth in the following table. For SN-605, SN-653, SN-660, SN-661, SN-664, and SN-672, compliance shall be demonstrated by compliance with Specific Conditions 18 and 21. For SN-654, compliance shall be demonstrated by compliance with Specific Condition 22. [Reg. 19.501 et seq. and 40 C.F.R. § 52 Subpart E]

SN	Description	Pollutant	lb/hr	tpy
605	Product Storage Tank (TT-22-652)	VOC	15.4	2.9
653	Intermediate Product Tank (TT-22-631)	VOC	14.3	2.7
654	Refrigerated Methanol Tank (TT-22-040)	VOC	0.1	0.5
660	Ethyl Bromide Transfer and Storage (TT-22-031)	VOC	1.8	7.5
661	Raw Material Storage Tank (TT-22-647)	VOC	3.5	0.8
664	Raw Material Storage Tank (TT-22-648)	VOC	3.5	0.8

SN	Description	Pollutant	lb/hr	tpy
672	Product Storage Tank (TT-22-236)	VOC	13.0	2.5
673	Product Loadout Operations	VOC	30.8	8.1
699	Fugitive Equipment Leaks	VOC	3.5	15.4

17. The permittee shall not exceed the emission rates set forth in the following table. For SN-605, SN-653, SN-660, SN-661, SN-664, and SN-672, compliance shall be demonstrated by compliance with Specific Conditions 18 and 21. For SN-654, compliance shall be demonstrated by compliance with Specific Condition 22. For SN-657 compliance shall be demonstrated by compliance with Specific Condition 23. [Reg.18.801, and Ark. Code Ann. § 8-4-203 as referenced by Ark. Code Ann. §§ 8-4-304 and §8-4-311]

SN	Description	Pollutant	lb/hr	tpy
612	HBr Scrap Tank	HBr	0.30	1.31
		HCl	0.01	0.05
654	Refrigerated Methanol Tank (TT-22-040)	Methanol	0.10	0.44
657	HBr Absorber Scrubber Vent (HBr production in alkyl bromides reactor)	HCl	0.01	0.05
		HBr	1.00	4.38
		NH <sub>3</sub>	0.10	0.44
658	HBr Scrap Tank (TT-02-168)	HBr	0.10	0.44
		HCl	0.01	0.05
699	Fugitive Equipment Leaks	Methanol	1.76	7.69
		Methyl Bromide	1.76	7.69

18. The permittee will be limited to the following production lot rates in the following table: [Reg.19.705, Ark. Code Ann. § 8-4-203 as referenced by Ark. Code Ann. §§ 8-4-304 and 8-4-311, and 40 C.F.R. § 70.6]

Product	Production Lot Per Year
Ethyl Bromide	8,223
N-Butyl Bromide	8,223
N-Propyl Bromide	8,223

19. The permittee shall maintain monthly records of production listed in the table in Specific Condition 18. Compliance shall be determined on a monthly basis by totaling throughput for that month and the previous 11 months. Each 12-month rolling total shall be updated by the fifteenth day of the month following the month to which the records pertain. These records shall be kept on-site and shall be submitted in accordance with General Provision #7. [Reg.19.705 and 40 C.F.R. § 52 Subpart E]

20. The permittee shall not store any materials in the following storage tanks at the alkyl bromides unit unless the product of the vapor pressure (in psia, measured at 70°F) and the molecular weight (in lb/lbmol) is less than the value given in the following table.  
 [§19.705 of Regulation 19, Ark. Code Ann. § 8-4-203 as referenced by Ark. Code Ann. §§ 8-4-304 and §8-4-311, and 40 CFR Part 52 Subpart E]

SN	Description	VP * MW (psia * lb/lbmol)
605	Product Storage Tank (TT-22-652)	331.2
653	Intermediate Product Tank (TT-22-631)	331.2
661	Raw Material Storage Tank (TT-22-647)	40.1
664	Raw Material Storage Tank (TT-22-648)	40.1
672	Product Storage Tank (TT-22-236)	331.2

21. The permittee shall monitor the heat exchange fluid temperature downstream from the SN-660 condenser. This temperature shall not exceed 10 °F. The permittee shall monitor and record this temperature a minimum of once per operating day. These records shall be kept on site and made available to Department personnel upon request. [Reg.19.703, 40 C.F.R. § 52 Subpart E, and Ark. Code Ann. § 8-4-203 as referenced by Ark. Code Ann. §§ 8-4-304 and 8-4-311]
22. The SN-654 shall be kept at or below 10°F. The facility shall monitor and record the temperature at least once per day. Records of monitoring shall be kept on site and made available to Department personnel upon request. [Reg.19.705 and 40 C.F.R. § 52 Subpart E]
23. The permittee shall maintain the scrubber parameters shown in the following table for SN-657. The permittee shall monitor these parameters at least once every twelve hours and keep written records of the readings, the date and time of the readings, and the person conducting the readings. If the underlying process equipment is not in operation, then the records should note such. These records shall be kept on site and made available to Department personnel upon request. If the scrubber liquid flow rate falls below the minimum listed value, corrective action shall be taken within twelve hours. The permittee shall maintain records of the measurement and corrective actions taken. The permittee may conduct emissions testing in order to establish alternative parameters. The Department may approve the alternative parameters upon receipt of the information from the permittee. The alternative parameters will become the permitted parameters upon receiving written approval from the Department. [Reg.19.303, 40 C.F.R. § 64, Reg.18.1104 and Ark. Code Ann. § 8-4-203 as referenced by Ark. Code Ann. §§ 8-4-304 and §8-4-311]

SN	Control Equipment	Minimum Operating Parameters
657	Scrubber	8.0 gal/min of water flow

Great Lakes Chemical Corporation - Central Plant

Permit #: 1077-AOP-R5

AFIN: 70-00012

24. The permittee shall test SN-657 as specified in the following table. Each test shall consist of at least 3 sampling periods at a minimum of 1 hour each. The facility shall document the production rate from one of the products in Specific Condition 18 during the performance test and make production rate data available to the ADEQ inspector during the test. The permittee shall be limited to operating at no more than 10% above the tested production rate for any product until the next performance test is conducted pursuant to this specific condition. This testing is to be completed every 5 year permit period. This test data shall be used for determination of compliance with the conditions set forth in this permits. [Reg.18.1002 and Ark. Code Ann. § 8-4-203 as referenced by Ark. Code Ann. §§ 8-4-304 and 8-4-311]

Source	Pollutant	Test Method
SN-657	HCl	EPA Reference Method 26 or 26A
	HBr	EPA Reference Method 26 or 26A

Great Lakes Chemical Corporation - Central Plant  
Permit #: 1077-AOP-R5  
AFIN: 70-00012

SN-1001A, SN-1001B, SN-1002, SN-1003, SN-1005, SN-1006, SN-1007, SN-1008, SN-1014,  
SN-1015, SN-1016, SN-1019, SN-1025, SN-1030, SN-1031, SN-1099  
TBBPA Unit

### Source Description

Tetrabromobisphenol-A (TBBPA) is made by reacting bromine and bisphenol-A (BPA). TBBPA is used as a flame retardant as well as feed stock for other GLCC processes.

The process begins with BPA being dissolved in methanol prior to transfer to the reactor where bromine is added. Products of this reaction are TBBPA, MeBr, and hydrogen bromide (HBr). A slurry consisting of TBBPA in a hydrogen bromide solution is filtered, purified, and dried. The TBBPA is further dried and packaged.

In addition to being produced as a co-product of the TBBPA reaction, methyl bromide is produced from the solvent liquor in a vaporizer reactor and in a dedicated reactor at the TBBPA unit. In this reactor, hydrogen bromide is mixed with methanol to form methyl bromide. The crude methyl bromide is purified then treated with sulfuric acid.

Vapors from the bromine storage tanks are vented to one of two caustic scrubbers (SN-1001A or SN-1001B) before being released to the atmosphere. SN-1001A and SN-1001B can operate one at a time, in series, or in parallel. A water scrubber (SN-1019) controls emissions from two BPA mix tanks. Particulate matter emissions are controlled by baghouses (SN-1002, SN-1003, SN-1005, SN-1006, and SN-1007). Baghouse SN-1002 controls emissions from the BPA storage silo, SN-1003 and SN-1006 control emissions from the TBBPA air heaters. Baghouse SN-1005 controls dust emission from bulk loading and SN-1007 controls packaging emissions. The fresh methanol storage tank is controlled with a flare, SN-1008. Tank emissions vented to the atmosphere include a recycle water tank (SN-1014) and two chilled methanol recirculation tanks (SN-1015 and SN-1016). Process water at the TBBPA Unit passes through two cooling towers (SN-1030 and SN-1031). Emissions also occur at various connectors, pumps, and valves associated with piping for this unit (SN-1099).

An alternative operating scenario at this unit utilizes existing equipment, a caustic vent scrubber (SN-1025), and a spent caustic tank. This scenario will manufacture methyl bromide only.

### Regulatory Applicability

In addition to the regulatory applicability indicated in the Facility Regulatory Applicability Section, there is some additional applicability indicated below. The TBBPA Unit's methyl bromide process is subject to 40 CFR Part 60, Subpart VV—Standards of Performance for Equipment Leaks of VOC in the Synthetic Organic Chemicals Manufacturing Industry for which Construction, Reconstruction, or Modification Commenced After January 5, 1981, and on or Before November 7, 2006 (NSPS Subpart VV) as currently indicated in permit 1077-AOP-R1.

PAI MACT Applicability

Equipment associated with the production of methyl bromide (MeBr) at the TBBPA Unit is subject to the requirements of the Pesticide Active Ingredient MACT, 40 CFR Part 63 Subpart MMM.

MON MACT Applicability

The Miscellaneous Chemical Process Unit (MCPU) for the TBBPA/MeBr Unit includes all the equipment that collectively functions to produce TBBPA or methyl bromide and must comply with the Miscellaneous Organic Chemical Manufacturing MACT, 40 CFR Part 63 Subpart FFFF. The MON MACT allows equipment subject to the PAI MACT to comply with the PAI MACT in lieu of the MON MACT. The equipment that will comply with the MON MACT is the TBBPA equipment downstream of the solid discharge from the centrifuges and all equipment associated with methyl bromide processing and transfer downstream of the PAI MACT storage vessels.

Specific Conditions

25. The permittee shall not exceed the emission rates set forth in the following table. The permittee shall demonstrate compliance with this condition by compliance with Specific Conditions 27, 29, 37, 39, 40, and 41. SN-1014, SN-1015, and SN-1016 have been permitted at maximum capacity. [Reg.19.501 et seq. and 40 C.F.R. § 52, Subpart E]

SN	Description	Pollutant	lb/hr	tpy
1002	BPA Silo Baghouse (BH-08-591)	PM <sub>10</sub>	0.4	1.5
1003	Air Heater Baghouse (BH-08-105)	PM <sub>10</sub> VOC	1.8 1.0	7.6 4.4
1005	Bulk Loading Baghouse (BH-08-100)	PM <sub>10</sub>	2.2	9.5
1006	Air Heater Baghouse (BH-08-102)	PM <sub>10</sub> VOC	1.8 1.0	7.6 4.4
1007	Warehouse Baghouse (BH-08-102)	PM <sub>10</sub> VOC	1.8 1.0	7.6 4.4
1008	TBBPA Ground Flare (GF-08-001)	PM <sub>10</sub> SO <sub>2</sub> VOC CO NO <sub>x</sub>	0.1 0.1 1.6 3.4 0.7	0.1 0.1 0.3 2.2 0.4
1014	Recycle Water Tank (TT-08-266)	VOC	0.1	0.5
1015	Chilled Methanol Recirculation Tank (TT-08-909)	VOC	0.1	0.5
1016	Chilled Methanol Recirculation Tank (VS-08-919)	VOC	0.1	0.5



SN	Description	Pollutant	lb/hr	tpy
1019	BPA Mix Tanks Water Scrubber (VS-08-919)	VOC	1.2	5.3
1030	Cooling Tower (CT-08-102)	PM <sub>10</sub>	0.1	0.1
1031	Cooling Tower (CT-08-901)	PM <sub>10</sub>	0.1	0.1
1099	TBBPA Unit Fugitive Emissions (Equipment Leaks)	VOC	5.3	23.3

26. The permittee shall not exceed the emission rates set forth in the following table. The permittee shall demonstrate compliance with this condition by compliance with Specific Conditions 27, 29, 31, 37, 39, 40, and 41. [Reg.18.801, and Ark. Code Ann. § 8-4-203 as referenced by Ark. Code Ann. §§ 8-4-304 and §8-4-311]

SN	Description	Pollutant	lb/hr	tpy
1001 A & B	Caustic Scrubbers (VS-08-418 and VS-08-592)	Br <sub>2</sub> Cl <sub>2</sub>	0.50 0.01	2.19 0.05
1002	BPA Silo Baghouse (BH-08-591)	PM	0.4	1.5
1003	Air Heater Baghouse (BH-08-105)	PM Meth. & Methyl Br.	1.8 1.00	7.6 4.40
1005	Bulk Loading Baghouse (BH-08-105)	PM	2.2	9.5
1006	Air Heater Baghouse (BH-08-256)	PM Meth. & Methyl Br.	1.8 1.00	7.6 4.40
1007	Warehouse Baghouse (BH-08-102)	PM Meth. & Methyl Br.	1.8 1.00	7.6 4.40
1008	TBBPA Ground Flare (GF-08-102)	PM Methanol	0.1 1.52	0.1 0.28
1015	Chilled Methanol Recirculation Tank #1 (TT-08-906)	Methanol	0.10	0.44
1016	Chilled Methanol Recirculation Tank #2 (TT-08-909)	Methanol	0.10	0.44
1019	BPA Mix Tanks Water Scrubber (VS-08-919)	Methanol	1.20	5.26
1025	MeBr Caustic Vent Scrubber	Br <sub>2</sub> Cl <sub>2</sub>	0.50 0.01	2.20 0.05
1030	Cooling Tower (CT-08-102)	PM	0.1	0.1

SN	Description	Pollutant	lb/hr	tpy
1031	Cooling Tower (CT-08-901)	PM	0.1	0.1
1099	TBBPA Unit Fugitive Emissions (Equipment Leaks)	HCl Methanol Methyl Bromide	0.01 4.94 0.39	0.05 21.62 1.70

27. Visible emissions may not exceed the limits specified in the following table of this permit as measured by EPA Reference Method 9.

SN	Limit	Regulatory Citation
1002	5%	Reg.18.501
1003	5%	Reg.18.501
1005	5%	Reg.18.501
1006	5%	Reg.18.501
1007	5%	Reg.18.501
1008	20%	Reg.18.501

28. Weekly observation of the opacity from SN-1002, SN-1003, SN-1005, SN-1006, SN-1007, and SN-1008 shall be conducted by a person trained but not necessarily certified in EPA Reference Method 9. If visible emissions in excess of the permitted levels are detected, the permittee shall immediately take action to identify the cause of the visible emissions in excess of the permit limit, implement the corrective action within twelve hours, and perform an EPA Reference Method 9 test to verify emissions are not in excess of the permitted level. The permittee shall maintain records which contain the following items in order to demonstrate compliance with this Specific Condition. These records shall be updated weekly, kept on site, and made available to Department personnel upon request.
- The date and time of the observation.
  - If visible emissions which appeared to be above the permitted limit were detected.
  - If visible emissions which appeared to be above the permitted limit were detected, the cause of the exceedance of the opacity limit, the corrective action taken, and if visible emissions appeared to be below the permitted limit after the corrective action was taken.
  - The name of the person conducting the opacity observations.
29. The permittee will be limited to the following production lot rates in the following table:  
 [Reg.19.705, Ark. Code Ann. § 8-4-203 as referenced by Ark. Code Ann. §§ 8-4-304 and 8-4-311, and 40 C.F.R. § 70.6]

Product	Production Lot Per Year
TBBPA	9,336
Methyl Bromide	11,117

30. The permittee shall maintain monthly records of production listed in the table in Specific Condition 29. Compliance shall be determined on a monthly basis by totaling throughput for that month and the previous 11 months. Each 12-month rolling total shall be updated by the fifteenth day of the month following the month to which the records pertain. These records shall be kept on-site and shall be submitted in accordance with General Provision #7. [Reg.19.705 and 40 C.F.R. § 52 Subpart E]

SN-1001A, SN-1001B Conditions

31. The permittee shall maintain the control equipment parameters shown in the following table. The permittee shall monitor these parameters every twelve hours of operation of the source and keep written records of the readings. These records shall be kept on site and made available to Department personnel upon request. If the caustic concentration and caustic solution flow rate falls below the minimum listed value, corrective action shall be taken immediately and the situation corrected within twelve hours. The permittee shall maintain records of sampling and corrective actions taken. These parameters were established at the time of permit application. [Reg.19.303 and Ark. Code Ann. § 8-4-203 as referenced by Ark. Code Ann. §§ 8-4-304 and 8-4-311]

Control Equipment	Minimum Operating Parameters
Scrubber	8.0 gal/min of caustic solution 2.5% by wt. caustic concentration

32. The permittee shall measure the emissions from one of the caustic scrubbers as specified in the following table in accordance with the test procedures listed. Testing shall be conducted every five years during bromine tank filling operations to ensure that testing is conducted under worst-case conditions. Test results will be maintained on-site, made available to Department personnel upon request, and will be submitted to the Department in accordance with Plant wide Condition 3. The Department reserves the right to select the scrubber to be tested. [Reg.18.1002 and Ark. Code Ann. § 8-4-203 as referenced by Ark. Code Ann. §§ 8-4-304 and 8-4-311]

Source	Pollutant	Test Method
SN-1001A or SN-1001B	Br <sub>2</sub>	EPA Reference Method 26 or 26A

SN-1025 Conditions

33. The permittee shall maintain the control equipment parameters at SN-1025 shown in the following table. The permittee shall monitor these parameters every twelve hours of operation of the source and keep written records of the readings. These records shall be

kept on site and made available to Department personnel upon request. If the caustic concentration falls below the minimum listed value, corrective action shall be taken immediately and the situation corrected within twelve hours. The permittee shall maintain records of sampling and corrective actions taken. [§18.1004 and Ark. Code Ann. § 8-4-203 as referenced by Ark. Code Ann. §§ 8-4-304 and §8-4-311]

Scrubbing Operating Parameters
Scrubbing Media: Caustic (2.5% by wt. minimum concentration) Minimum Media Flow Rate: 10 gpm

34. The permittee shall test SN-1025 as specified in the following table in accordance with the test procedures listed while operating the source according to minimum scrubber parameters in Specific Condition 33. The testing of this source shall be conducted every five (5) years. [§18.1002 and Ark. Code Ann. § 8-4-203 as referenced by Ark. Code Ann. §§ 8-4-304 and §8-4-311]

Source	Pollutant	Test Method
SN-1025	Br <sub>2</sub>	EPA Reference Method 26 or 26A

SN-1002, SN-1003, SN-1005, SN-1006, and SN-1007 Conditions

35. The permittee shall measure the emissions from one of the baghouses: SN-1002, SN-1003, SN-1005, SN-1006, or SN-1007 as specified in the following table in accordance with the listed test procedures. If SN-1002 or SN-1005 is selected, then the testing shall be conducted during silo or railcar loading operations in order to capture the “worst case” emissions scenario. If another source is selected for testing (SN-1003, 1006, or 1007) the permittee shall document the TBBPA production rate from Specific Condition 29 during the performance test and make production rate data available to the ADEQ inspector during the test. Each test shall consist of at least 3 sampling periods at a minimum of 1 hour each. The permittee shall be limited to operating at no more than 10% above the tested production rate until the next performance test is conducted pursuant to this Specific Condition. This testing is to be conducted once every 5 year permit period. This test data shall be used for determination of compliance with the conditions set forth in this permits. [Reg.19.702 and 40 C.F.R. § 52 Subpart E]

Source	Pollutant	Test Method
SN-1002, SN-1003, SN-1005, SN-1006, or SN-1007	PM <sub>10</sub> VOC	EPA Reference Method 201 or 201A EPA Reference Method 18

36. The permittee shall maintain monthly records which document that the production limit established in Specific Condition 35 has not been exceeded. These records shall be maintained on-site and shall be made available to Department personnel upon request. [Reg.19.705 and 40 C.F.R. § 52 Subpart E]

SN-1008 Conditions

37. The methanol tank flare (SN-1008) shall be operated with a pilot flame present at all times. The presence of a flare pilot flame shall be monitored using a thermocouple or other equivalent device capable of continuous flame detection. [Reg.19.303 and Ark. Code Ann. § 8-4-203 as referenced by Ark. Code Ann. §§ 8-4-304 and 8-4-311]
38. The permittee shall maintain records which document compliance with Specific Condition 37. These records shall be maintained on-site and shall be made available to Department personnel upon request. [Reg.19.705 and 40 C.F.R. § 52 Subpart E]

SN-1019 Conditions

39. The permittee shall maintain the control equipment parameters shown in the following table. The permittee shall monitor these parameters every twelve hours of operation of the source and keep written records of the readings. These records shall be kept on site and made available to Department personnel upon request. If the flow rate falls below the minimum listed value, corrective action shall be taken immediately and the situation corrected within twelve hours. The permittee shall maintain records of sampling and corrective actions taken. These parameters were established at the time of permit application. [Reg.19.303 and Ark. Code Ann. § 8-4-203 as referenced by Ark. Code Ann. §§ 8-4-304 and 8-4-311]

SN	Description	Control Equipment	Minimum Operating Limits
1019	BPA Mix Tanks Water Scrubber	Scrubber	2.0 gal/min of water

SN-1030 and SN-1031 Conditions

40. The water flow rate shall not exceed 9,000 gallons per minute, at SN-1030 and SN-1031. The permittee shall maintain, on site, documentation that the physical flow capacity of SN-1030 and SN-1031 do not exceed 9,000 gallons per minute each. [Reg.19.705, Ark. Code Ann. § 8-4-203 as referenced by Ark. Code Ann. §§ 8-4-304 and 8-4-311, and 40 C.F.R. § 70.6]
41. The total dissolved solids concentrations or correlated conductivity, in the following table shall not be exceeded. The permittee shall demonstrate compliance by compliance with Specific Condition 42. [Reg.19.705, Ark. Code Ann. § 8-4-203 as referenced by Ark. Code Ann. §§ 8-4-304 and 8-4-311, and 40 C.F.R. § 70.6]

Source	Description	Maximum Total Dissolved Solids Concentration
SN-1030	Cooling Tower (CT-08-102)	12,000 ppm/13,961 µS
SN-1031	Cooling Tower (CT-08-901)	12,000 ppm/13,961 µS

Great Lakes Chemical Corporation - Central Plant

Permit #: 1077-AOP-R5

AFIN: 70-00012

42. The permittee shall monitor and maintain monthly records of the Total Dissolved Solids (TDS) or correlated conductivity. These records shall be kept on-site and made available to Department personnel upon request. [Reg.19.705 and 40 C.F.R. § 52 Subpart E]

SN-1102, SN-1103, SN-1104, SN-1105, SN-1106, SN-1107, SN-1109, SN-1112, SN-1113  
SN-1114, SN-1115, SN-1116, SN-1123, SN-1140, SN-1141, SN-1142, SN-1150, SN-1199  
BOC Unit

### Source Description

GLCC Central operates at the Brominated Organic Compounds (BOC) Unit to manufacture various brominated diphenyl oxide (DPO) and polyphenyl ether (PPE) products and heavy fluids for commercial sale.

#### Brominated DPO and PPE Production

The major steps in production of brominated DPO and PPE products in the BOC Unit are described below.

- Raw materials are stored in tanks
- Raw materials are reacted in the Brominator
- Excess reactants are removed from the raw product and dried
- Raw product is washed, filtered, ground, and dried
- Product is shipped

#### Heavy Fluids Production

The major steps in the production of heavy fluids products in the BOC Unit are described below.

- Raw materials are stored in tanks and silos
- Bromination occurs in absorber
- Crude product is filtered
- Product is stored prior to transfer to other GLCC Central units for shipping

#### Air Pollution Emissions

The predominant air pollutant emission sources in the BOC Unit are process vessels and storage vessels (previously permitted sources SN-1120, SN-1121, SN-1131, and SN-1132 are being updated to insignificant activities). Particulate matter emissions are controlled by baghouses (SN-1103, SN-1104, SN-1105, SN-1106, SN-1113, SN-1114, SN-1115, SN-1116, and SN-1023). Vent condensers are used to control some process vessels (i.e. reactors, strippers, etc.) operated in the BOC Unit along with various scrubbers (SN-1102 and SN-1112). Condensed materials are refluxed, and any non-condensable gases (NCGs) or other vapors are routed from the vent condensers to other GLCC Central units or to the heavy fluids absorber. A caustic scrubber (SN-1107) controls the heavy fluids absorber. The refrigerated methanol tank (SN-1150) is vented to the atmosphere. The filter belt vacuum pump (SN-1109) is vented to the atmosphere. Process water at the BOC Unit passes through three cooling towers (SN-1140, SN-1141, and SN-1142). Emissions also occur at various connectors, pumps, and valves associated with piping for this unit (SN-1199).

Process Changes

With this permit renewal, several sources are requested to be removed due to process changes, these include: SN-1108, 1110, 1130, 1133, and 1134. The tanks previously permitted as SN-1120, SN-1121, SN-1131, and SN-1132 storing DPO/PPE products are now classified as Group A.13 Insignificant Activities.

Regulatory Applicability

In addition to the regulatory applicability indicated in the Facility Regulatory Applicability Section, there is some additional applicability indicated below. The BOC unit contains existing sources that are subject to the requirements of 40 CFR 63 Subpart EEEE – *National Emission Standards for Hazardous Air Pollutants: Organic Liquids Distribution*. The BOC Unit is not subject to 40 CFR Part 60 Subpart NSPS VV – SOCOMI VOC Equipment Leaks, because this unit does not produce any listed chemicals as an intermediate or final product. Diphenyl oxide is present in the process unit, but is shipped in, not produced.

Specific Conditions

43. The permittee shall not exceed the emission rates set forth in the following table. For SN-1102 and SN-1112, compliance with the maximum hourly limits shall be demonstrated by compliance with Specific Conditions 49, 51 and the maximum usage of natural gas at the dryers. For SN-1103, SN-1104, SN-1105, SN-1106, SN-1113 through SN-1116, and SN-1123, compliance with the maximum hourly limits shall be demonstrated by Specific Condition 45 and the annual limits are based upon maximum operation of the source at the hourly rate. For SN-1109, the hourly and annual limits are based upon maximum operation of the source. For SN-1112, compliance with the maximum hourly limits shall be demonstrated by operating at maximum capacity; compliance with the annual limits shall be demonstrated by Specific Condition 47. For SN-1131 and SN-1132, compliance with the maximum hourly limits shall be demonstrated by operating at maximum capacity; compliance with the annual limits shall be demonstrated by Specific Condition 47. For SN-1140, SN-1141, and SN-1142, compliance with the maximum hourly limits shall be demonstrated by Specific Conditions, 57, 58 and 59 the annual limits are based upon maximum operation of the source at the hourly rate. Emissions for SN-1199 are calculated for maximum hourly and annual rates. [Reg.19.501 *et seq.* and Ark. Code Ann. § 8-4-203 as referenced by Ark. Code Ann. §§ 8-4-304 and 8-4-311]]

SN	Description	Pollutant	lb/hr	tpy
1102	Wet Scrubber (VS-10-105)	PM <sub>10</sub>	2.1	8.8
		SO <sub>2</sub>	0.1	0.1
		VOC	0.1	0.1
		CO	0.1	0.2
		NO <sub>x</sub>	0.1	0.3



SN	Description	Pollutant	lb/hr	tpy
1103	Crude Baghouse (BH-10-108)	PM <sub>10</sub>	1.1	4.9
1104	First Grind Baghouse (BH-10-109)	PM <sub>10</sub>	0.6	2.5
1105	Roasted Product Baghouse (BH-10-110)	PM <sub>10</sub>	0.6	2.5
1106	Final Product Baghouse (BH-10-111)	PM <sub>10</sub>	0.6	2.5
1109	Filter belt Vacuum Pump (FT-10-112)	VOC	0.1	0.5
1112	Wet Scrubber (VS-10-101)	PM <sub>10</sub>	3.1	13.2
		SO <sub>2</sub>	0.1	0.1
		VOC	0.1	0.1
		CO	0.1	0.2
		NO <sub>x</sub>	0.1	0.3
1113	Crude Baghouse (BH-10-103)	PM <sub>10</sub>	1.1	4.9
1114	First Grind Baghouse (BH-10-107)	PM <sub>10</sub>	0.6	2.4
1115	Roasted Product Baghouse (BH-10-104)	PM <sub>10</sub>	0.6	2.5
1116	Final Product Baghouse (BH-10-105)	PM <sub>10</sub>	0.6	2.7
1123	Packaging Baghouse (BH-10-112)	PM <sub>10</sub>	0.4	1.5
1140	Cooling Tower (CT-10-101)	PM <sub>10</sub>	0.6	2.3
1141	Cooling Tower (CT-10-102)	PM <sub>10</sub>	0.6	2.3
1142	Cooling Tower (CT-10-103)	PM <sub>10</sub>	0.6	2.3
1150	Methanol Surge Tank (TT-10-615)	VOC	0.3	0.3
1199	BOC Unit Fugitive Equipment Leaks	VOC	2.2	9.7

44. The permittee shall not exceed the emission rates set forth in the following table. For SN-1102 and SN-1112, compliance with the maximum hourly limits shall be demonstrated by compliance with Specific Conditions 49, 51 and usage of natural gas at the dryers. For SN-1103, SN-1104, SN-1105, SN-1106, SN-1113 through SN-1116, and SN-1123; the annual limits are based upon maximum operation of the source at the hourly rate. For SN-1107, compliance with the maximum hourly limits shall be demonstrated by Specific Conditions 53 and 54; the annual limits shall be demonstrated by Specific Conditions 47 and 53. For SN-1109, compliance with the maximum hourly limits shall be demonstrated by Specific Condition 56; annual limits are based upon maximum operation of the source. For SN-1112, compliance with the annual limits shall be demonstrated by Specific Condition 47. For SN-1131 and SN-1132, with the annual limits shall be demonstrated by Specific Condition 47. For SN-1140, SN-1141, and SN-1142, compliance with the maximum hourly limits shall be demonstrated by Specific

Conditions 57, 58 and 59; the annual limits are based upon maximum operation of the source at the hourly rate. Emissions for SN-1199 are calculated for maximum hourly and annual rates. [Reg.18.801, and Ark. Code Ann. § 8-4-203 as referenced by Ark. Code Ann. §§ 8-4-304 and §8-4-311]

SN	Description	Pollutant	lb/hr	tpy
1102	Wet Scrubber (VS-10-105)	PM	2.1	8.8
		HBr	0.5	2.2
		Br <sub>2</sub>	0.5	2.2
		HCl	0.01	0.05
		Cl <sub>2</sub>	0.01	0.05
1103	Crude Baghouse (BH-10-108)	PM	1.1	4.9
		HBr	2.0	8.76
		Br <sub>2</sub>	2.0	8.76
		HCl	0.02	0.09
		Cl <sub>2</sub>	0.02	0.09
1104	First Grind Baghouse (BH-10-109)	PM	0.6	2.5
		HBr	1.0	4.38
		Br <sub>2</sub>	1.0	4.38
		HCl	0.01	0.05
		Cl <sub>2</sub>	0.01	0.05
1105	Roasted Product Baghouse (BH-10-110)	PM	0.6	2.5
		HBr	0.5	2.19
		Br <sub>2</sub>	0.5	2.19
		HCl	0.01	0.03
		Cl <sub>2</sub>	0.01	0.03
1106	Final Product Baghouse (BH-10-111)	PM	0.6	2.5
		HBr	0.5	2.19
		Br <sub>2</sub>	0.5	2.19
		HCl	0.01	0.03
		Cl <sub>2</sub>	0.01	0.03
1107	Caustic Scrubber (VS-10-103)	HBr	0.5	2.20
		Br <sub>2</sub>	0.5	2.20
		HCl	0.01	0.05
		Cl <sub>2</sub>	0.01	0.05
1109	Filter Belt Vacuum Pump (FT-10-112)	HBr	0.5	2.20
		Br <sub>2</sub>	0.5	2.20
		HCl	0.01	0.05
		Cl <sub>2</sub>	0.01	0.05
1112	Wet Scrubber (VS-10-101)	PM	3.1	13.2
		HBr	0.5	2.20
		Br <sub>2</sub>	0.5	2.20
		HCl	0.01	0.05
		Cl <sub>2</sub>	0.01	0.05

Great Lakes Chemical Corporation - Central Plant  
 Permit #: 1077-AOP-R5  
 AFIN: 70-00012

SN	Description	Pollutant	lb/hr	tpy
1113	Crude Baghouse (BH-10-103)	PM	1.1	4.9
		HBr	2.00	8.76
		Br <sub>2</sub>	2.00	8.76
		HCl	0.02	0.09
		Cl <sub>2</sub>	0.02	0.09
1114	First Grind Baghouse (BH-10-107)	PM	0.6	2.4
		HBr	1.00	4.38
		Br <sub>2</sub>	1.00	4.38
		HCl	0.01	0.05
		Cl <sub>2</sub>	0.01	0.05
1115	Roasted Product Baghouse (BH-10-104)	PM	0.6	2.5
		HBr	0.5	2.19
		Br <sub>2</sub>	0.5	2.19
		HCl	0.01	0.03
		Cl <sub>2</sub>	0.01	0.03
1116	Final Product Baghouse (BH-10-105)	PM	0.6	2.7
		HBr	0.5	2.19
		Br <sub>2</sub>	0.5	2.19
		HCl	0.01	0.03
		Cl <sub>2</sub>	0.01	0.03
1123	Packaging Baghouse (BH-10-112)	PM	0.4	1.5
		HBr	0.5	2.19
		Br <sub>2</sub>	0.5	2.19
		HCl	0.01	0.03
		Cl <sub>2</sub>	0.01	0.03
1140	Cooling Tower (CT-10-101)	PM	0.6	2.3
1141	Cooling Tower (CT-10-102)	PM	0.6	2.3
1142	Cooling Tower (CT-10-103)	PM	0.6	2.3
1150	Refrigerated Methanol Tank (TT-10-615)	Methanol	0.26	0.26
1199	BOC Unit Fugitive Equipment Leaks	Hydrazine	0.001086	0.04758
		Methanol	2.194	9.608

45. Visible emissions may not exceed the limits specified in the following table as measured by EPA Reference Method 9. Compliance will be verified by meeting the requirements of Specific Condition 46 for SN-1103, 1104, 1105, 1106, 1113, 1114, 1115, 1116, and 1123. Compliance at SN-1102 and 1112 will be verified by meeting the requirements of Specific Conditions 49, 50, and 51. Compliance at SN-1107 will be verified by meeting the requirements of Specific Condition 53.

SN	Limit	Regulatory Citation
1102	5%	Reg.18.501
1103	5%	Reg.18.501
1104	5%	Reg.18.501
1105	5%	Reg.18.501
1106	5%	Reg.18.501
1107	5%	Reg.18.501
1112	5%	Reg.18.501
1113	5%	Reg.18.501
1114	5%	Reg.18.501
1115	5%	Reg.18.501
1116	5%	Reg.18.501
1123	5%	Reg.18.501

46. Weekly observations of the opacity from sources SN-1103, 1104, 1105, 1106, 1113, 1114, 1115, 1116 and 1123 shall be conducted by a person trained but not necessarily certified in EPA Reference Method 9. If visible emissions in excess of the permitted levels are detected, the permittee shall immediately take action to identify the cause of the visible emissions in excess of the permit limit, implement corrective action, and document that visible emissions did not appear to be in excess of the permitted opacity following the corrective action. The permittee shall maintain records which contain the following items in order to demonstrate compliance with this specific condition. These records shall be updated weekly, kept on site, and made available to Department personnel upon request.
- a. The date and time of the observation.
  - b. If visible emissions which appeared to be above the permitted limit were detected.
  - c. If visible emissions which appeared to be above the permitted limit were detected, the cause of the exceedance of the opacity limit, the corrective action taken, and if the visible emissions appeared to be below the permitted limit after the corrective action was taken.
  - d. The name of the person conducting the opacity observations.

47. The permittee will be limited to the following production lot rates in the following table for each consecutive 12-month period: [Reg.19.705, Ark. Code Ann. § 8-4-203 as referenced by Ark. Code Ann. §§ 8-4-304 and 8-4-311, and 40 C.F.R. § 70.6]

Product	Production Lot Per Year
DE-83 Wet End	20,929
DE-83 Dry End	24,528
CN3397	12,250
CN3384	10,000

48. The permittee shall maintain monthly records of production listed in the table in Specific Condition 47. Compliance shall be determined on a monthly basis by totaling throughput for that month and the previous 11 months. Each 12-month rolling total shall be updated by the fifteenth day of the month following the month to which the records pertain. These records shall be kept on-site and shall be submitted in accordance with General Provision #7. [Reg.19.705 and 40 C.F.R. § 52 Subpart E]

SN-1102 and SN-1112 Compliance Conditions

49. The Wet Scrubbers, SN-1102 and SN-1112, are subject to and shall comply with all applicable provisions §19.304 of Regulation 19, 40 CFR Part 52 Subpart E, and Part §64.6 for Compliance Assurance Monitoring.
- a. The permittee shall maintain a scrubber liquid flow rate of at least 10 gallons per minute as measured by flow meter. [40 CFR Part §64.6(c)(1)]
  - b. The permittee shall monitor and maintain daily records to demonstrate compliance with Specific Condition 55(a). Records shall be kept onsite and made available to the Department upon request. [40 CFR Part §64.6(c)(3)]
  - c. The permittee shall maintain the scrubber in good working condition at all times so that pollutant removal is maintained. [40 CFR Part §64.6(c)(1)]
50. The Wet Scrubbers, SN-1102 and SN-1112, is subject to and shall comply with all applicable provisions §19.304 of Regulation 19, 40 CFR Part 52 Subpart E, and Part §64.9 for Compliance Assurance Monitoring. The following information pertaining to exceedances or excursions from permitted values shall be submitted in semi-annual reports in accordance with General Provision #7 as outlined in 40 CFR §70.6.
- a. The permittee shall maintain records for SN-1102 and SN-1112 that summarize the number, duration, and cause of excursions or exceedances of emission limits as well as corrective action taken. [40 CFR §64.9(a)(2)(i) and §64.9(b)]
  - b. The permittee shall maintain records for SN-1102 and SN-1112 that summarize the number, duration, and cause of monitoring equipment downtime incidents, other than routine downtime for calibration checks. [40 CFR §64.9(a)(2)(ii) and §64.9(b)]
  - c. The permittee shall maintain a quality improvement plan (QIP) threshold for each indicator of no more than nine excursions or 5% of the daily averages in a six-month period. [40 CFR §64.9(a)(2)(iii) and §64.9(b)]

- d. The permittee shall develop and implement a new QIP if the threshold is exceeded during any six-month period. [40 CFR §64.9(a)(2)(iii) and §64.9(b)]
- e. The permittee shall maintain records for SN-1102 and SN-1112 that describe the actions taken to implement the QIP. Upon completion of the QIP, documentation shall be maintained to confirm that the plan was completed and reduced the likelihood of similar excursions or exceedances. [40 CFR §64.9(a)(2)(iii) and §64.9(b)]

51. The permittee shall test SN-1102 and SN-1112 as specified in the following table in accordance with the test procedures listed and while operating the minimum scrubber parameters for each source. The test shall consist of at least 3 sampling periods at a minimum of 1 hour each. The permittee shall document the BOC Unit production rate during the performance test and make the production data available to the ADEQ inspector during the test. The permittee shall be limited to operating at no more than 10% above the tested production rate for any product until the next performance test is conducted pursuant to this specific condition. This testing is to be completed every 5 year permit period. This test data shall be used for determination of compliance with the conditions set forth in this permits. [Reg.19.702 and Ark. Code Ann. § 8-4-203 as referenced by Ark. Code Ann. §§ 8-4-304 and 8-4-311]

Source	Pollutant	Test Method
SN-1102	PM <sub>10</sub>	EPA Reference Method 201 or 201A
SN-1112	PM <sub>10</sub>	EPA Reference Method 201 or 201A

52. The permittee may conduct additional emission testing in order to establish alternative parameters for SN-1102 and SN-1112. The Department may approve the alternative parameters upon receipt of the information from the permittee. The alternative parameters may become the permitted parameters upon receiving written approval from the Department. [Reg.19.303 and Ark. Code Ann. § 8-4-203 as referenced by Ark. Code Ann. §§ 8-4-304 and 8-4-311]

SN-1107 Compliance Conditions

53. The permittee shall maintain the control equipment parameters shown in the following table. The permittee shall monitor these parameters every twelve hours of operation of the source and keep written records of the readings. These records shall be kept on site and made available to Department personnel upon request. If the caustic concentration and caustic solution flow rate falls below the minimum listed value, corrective action shall be taken immediately and the situation corrected within twelve hours. The permittee shall maintain records of sampling and corrective actions taken. These parameters were established at the time of permit application. [Reg.19.303 and Ark. Code Ann. § 8-4-203 as referenced by Ark. Code Ann. §§ 8-4-304 and 8-4-311]

SN	Description	Control Equipment	Minimum Operating Limits
1107	Caustic Scrubber (VS-10-103)	Scrubber	10.0 gal/min of caustic solution 2.5% caustic concentration

54. The permittee shall test SN-1107 as specified in the following table in accordance with the test procedures listed. The test shall consist of at least 3 sampling periods at a minimum of 1 hour each. The permittee shall document the BOC Unit production rate during the performance test and make the production data available to the ADEQ inspector during the test. The permittee shall be limited to operating at no more than 10% above the tested production rate for any product until the next performance test is conducted pursuant to this specific condition. This testing is to be completed every 5 year permit period. This test data shall be used for determination of compliance with the conditions set forth in this permits. [Reg.19.702 and Ark. Code Ann. § 8-4-203 as referenced by Ark. Code Ann. §§ 8-4-304 and 8-4-311]

Source	Pollutant	Test Method
SN-1107	Br <sub>2</sub> HBr	EPA Reference Method 26 or 26A EPA Reference Method 26 or 26A

55. The permittee may conduct additional emission testing in order to establish alternative parameters for SN-1107. The Department may approve the alternative parameters upon receipt of the information from the permittee. The alternative parameters may become the permitted parameters upon receiving written approval from the Department. [Reg.19.303 and Ark. Code Ann. § 8-4-203 as referenced by Ark. Code Ann. §§ 8-4-304 and 8-4-311]

SN-1109 Compliance Conditions

56. The permittee shall test SN-1109 for Bromine and HBr emissions using EPA Reference Method 26A. The test shall consist of at least 3 sampling periods at a minimum of 1 hour each. The permittee shall document the BOC Unit production rate during the performance test and make the production data available to the ADEQ inspector during the test. The permittee shall be limited to operating at no more than 10% above the tested production rate for any product until the next performance test is conducted pursuant to this specific condition. This testing is to be completed every 5 year permit period. This test data shall be used for determination of compliance with the conditions set forth in this permits. [Reg.19.702 and Ark. Code Ann. § 8-4-203 as referenced by Ark. Code Ann. §§ 8-4-304 and 8-4-311]

SN-1140, SN-1141, and SN-1142 Compliance Conditions

57. The permittee shall maintain, on site, documentation that the physical flow capacities, of SN-1140, 1141, and 1142 meet the values in the table below. [Reg.19.705, Ark. Code Ann. § 8-4-203 as referenced by Ark. Code Ann. §§ 8-4-304 and 8-4-311, and 40 C.F.R. § 70.6]

Source Number	Maximum Flow Rate through Tower (gallons per minute)
SN-1140	1,000
SN-1141	1,000
SN-1142	1,000

58. The total dissolved solids concentrations or correlated conductivity in the following table shall not be exceeded. The permittee shall demonstrate compliance by compliance with Specific Condition 59. [Reg.19.705, Ark. Code Ann. § 8-4-203 as referenced by Ark. Code Ann. §§ 8-4-304 and 8-4-311, and 40 C.F.R. § 70.6]

Source	Description	Maximum Total Dissolved Concentration
1140	Cooling Tower (CT-10-101)	5,000 ppm/5,970 µS
1141	Cooling Tower (CT-10-102)	5,000 ppm/5,970 µS
1142	Cooling Tower (CT-10-103)	5,000 ppm/5,970 µS

59. The permittee shall monitor and maintain monthly records of Total Dissolved Solids (TDS) or correlated conductivity. These records shall be kept on-site and made available to Department personnel upon request. [Reg.19.705 and 40 C.F.R. § 52 Subpart E]



SN-1202, SN-1203, SN-1204, SN-1220, SN-1221, SN-1230, SN-1299  
CaBr<sub>2</sub>/HBr Unit

Source Description

The Calcium Bromide/Hydrogen Bromide (CaBr<sub>2</sub>/HBr) Plant at GLCC Central manufactures CaBr<sub>2</sub> and HBr for commercial sale. The manufacture of each product is addressed below.

Calcium Bromide Production

The Calcium Bromide (CaBr<sub>2</sub>) Unit at GLCC Central produces heavy fluids for commercial sale. The major steps in CaBr<sub>2</sub> production process are described below.

- Lime (calcium-containing inorganic material) is received, stored, and slurried in tanks
- HBr is reacted with the lime slurry
- Product is cooled and stored in storage tanks
- Product is shipped via truck, rail, totes, and drums

Hydrogen Bromide Production

The Hydrogen Bromide (HBr) Unit at GLCC Central produces anhydrous, purified, or 48% HBr for other GLCC process units/areas or for commercial sale. The major steps in HBr production process are described below.

- Raw materials are received
- Raw materials are stored in tanks
- Raw materials are vaporized
- Vaporized raw materials are combusted
- Raw product is purified, compressed, and/or treated
- Product is routed to storage tanks
- Product is shipped via truck, rail, totes, and drums

Miscellaneous Operations

In addition to the production of HBr and CaBr<sub>2</sub>, the CaBr<sub>2</sub>/HBr Plant conducts a water recovery system. The water recovery system decants water from other GLCC Central process units/areas and sends sludge off-site.

Air Pollutant Emissions

The predominant air pollutant emissions sources in the unit are the process vessels. Wet and/or caustic scrubbers are used to control emissions from the process vessels (i.e., reactors, storage tanks, etc.) in the CaBr<sub>2</sub> and HBr production processes. The bromine tanks are controlled with a scrubber (SN-1202). The fabric filter for the lime silo (SN-1203) controls emissions that occur

during those times when lime is being transferred from delivery vessel to the silo. The caustic scrubber (SN-1204) controls emissions from the reactors producing calcium bromide. The tanks previously permitted as SN-1206, SN-1207, SN-1209 through SN-1213, and SN-1225 storing HBr products are now classified as Insignificant Activities, Group A.13. Emissions from the cooling towers (SN-1220 and SN-1221) are estimated based on their respective maximum water flow rates. The HBr startup scrubber (SN-1230) controls emission from the bromine shot tank and start-up and purge gas from the HBr “Burner” No. 3. Emissions occur at various connectors, pumps, and valves associated with the piping for this process (SN-1299).

### Specific Conditions

60. The permittee shall not exceed the emission rates set forth in the following table. For SN-1203, compliance shall be demonstrated by compliance with Specific Condition 62. For SN-1220 and SN-1221 compliance shall be demonstrated by compliance with Specific Conditions 89 and 71. [Reg.19.501 et seq. and 40 C.F.R. § 52 Subpart E]

SN	Description	Pollutant	lb/hr	tpy
1203	Lime Silo with Fabric Filter (TT-12-801)	PM <sub>10</sub>	0.1	0.5
1220	Cooling Tower (CT-12-800)	PM <sub>10</sub>	0.4	1.5
1221	Cooling Tower	PM <sub>10</sub>	0.1	0.2

61. The permittee shall not exceed the emission rates set forth in the following table. For SN-1202, SN-1204, and SN-1230 compliance shall be demonstrated by compliance with Specific Conditions 62, 66, and 67. For SN-1203, compliance shall be demonstrated by compliance with Specific Conditions 62. For SN-1220 and SN-1221, compliance shall be demonstrated by compliance with Specific Conditions 70 and 71. [Reg.18.801 and Ark. Code Ann. § 8-4-203 as referenced by Ark. Code Ann. §§ 8-4-304 and 8-4-311]

SN	Description	Pollutant	lb/hr	tpy
1202	Bromine Tank Scrubber (VS-11-507)	Br <sub>2</sub>	0.1	0.5
		Cl <sub>2</sub>	0.01	0.05
1203	Lime Silo with Fabric Filter (TT-12-801)	PM	0.1	0.5
1204	Vent Caustic Scrubber (VS-12-827)	HBr	1.2	5.3
		Br <sub>2</sub>	1.2	5.3
		HCl	0.01	0.05
		Cl <sub>2</sub>	0.01	0.05
1220	Cooling Tower (CT-12-800)	PM	0.4	1.5
1221	Cooling Tower	PM	0.1	0.2

SN	Description	Pollutant	lb/hr	tpy
1230	HBr Startup Scrubber (VS-11-301)	HBr	0.1	0.5
		Br <sub>2</sub>	0.1	0.5
		HCl	0.01	0.05
		Cl <sub>2</sub>	0.01	0.05
1299	Fugitive Equipment Leaks	Hydrazine	0.08	0.33

62. Visible emissions may not exceed the limits specified in the following table of this permit as measured by EPA Reference Method 9. Compliance with this limit for SN-1202, 1204, and 1230 shall be verified by compliance with Specific Condition 66. Compliance with this limit for SN-1203 shall be verified by compliance with Specific Condition 63.

SN	Description	Opacity Limit	Regulatory Citation
1202	Bromine Tank Scrubber (VS-11-507)	5%	Reg.18.501
1203	Lime Silo with Fabric Filter (TT-12-801)	5%	Reg.18.501
1204	Vent Caustic Scrubber (VS-12-827)	5%	Reg.18.501
1230	HBr Startup Scrubber (VS-11-301)	5%	Reg.18.501

63. Weekly observations of the opacity from sources SN-1203 shall be conducted by a person trained but not necessarily certified in EPA Reference Method 9. If visible emissions in excess of the permitted levels are detected, the permittee shall immediately take action to identify the cause of the visible emissions in excess of the permit limit, implement corrective action, and document that visible emissions did not appear to be in excess of the permitted opacity following the corrective action. The permittee shall maintain records which contain the following items in order to demonstrate compliance with this specific condition. These records shall be updated weekly, kept on site, and made available to Department personnel upon request.
- The date and time of the observation.
  - If visible emissions which appeared to be above the permitted limit were detected.
  - If visible emissions which appeared to be above the permitted limit were detected, the cause of the exceedance of the opacity limit, the corrective action taken, and if the visible emissions appeared to be below the permitted limit after the corrective action was taken.
  - The name of the person conducting the opacity observations.

[Reg.18.501 of Regulation 19 and Ark. Code Ann. § 8-4-203 as referenced by Ark. Code Ann. §§ 8-4-304 and §8-4-311]

64. The permittee will be limited to the following production lot rates in the following table:  
 [Reg.19.705, Ark. Code Ann. § 8-4-203 as referenced by Ark. Code Ann. §§ 8-4-304 and 8-4-311, and 40 C.F.R. § 70.6]

Product	Production Lot Per Year
Calcium Bromide	51,100
48% HBr	36,500
Anhydrous HBr	1,095

SN-1202, SN-1204, and SN-1230 Compliance Conditions

65. The permittee shall maintain monthly records of production listed in the table in Specific Condition 64. Compliance shall be determined on a monthly basis by totaling throughput for that month and the previous 11 months. Each 12-month rolling total shall be updated by the fifteenth day of the month following the month to which the records pertain. These records shall be kept on-site and shall be submitted in accordance with General Provision #7. [Reg.19.705 and 40 C.F.R. § 52 Subpart E]
66. The permittee shall maintain the control equipment parameters shown in the following table. The permittee shall monitor these parameters every twelve hours of operation of the source and keep written records of the readings. These records shall be kept on site and made available to Department personnel upon request. If the caustic concentration and caustic solution flow rate falls below the minimum listed value, corrective action shall be taken immediately and the situation corrected within twelve hours. The permittee shall maintain records of sampling and corrective actions taken. These parameters were established at the time of permit application. [Reg.18.1004 and Ark. Code Ann. § 8-4-203 as referenced by Ark. Code Ann. §§ 8-4-304 and 8-4-311]

SN	Description	Control Equipment	Minimum Operating Parameters
1202	Bromine Tank Scrubber (VS-11-507)	Scrubber	10.0 gal/min of caustic solution 2.5% caustic concentration
1204	Vent Caustic Scrubber (VS-12-827)	Scrubber	10.0 gal/min of caustic solution 2.5% caustic concentration
1230	HBr Startup Scrubber (VS-11-301)	Scrubber	10.0 gal/min of caustic solution 2.5% caustic concentration

67. The permittee shall test SN-1202, SN-1204, and SN-1230 as specified in the following table in accordance with the test procedures listed. The facility shall document the Calcium Bromide production rate and minimum scrubber operating parameters stated in Specific Condition 66 during the test at SN-1204. The facility shall document the Anhydrous HBr production rates and minimum scrubber operating parameters stated in Specific Condition 66 during the test at SN-1202 and SN-1230. The facility shall make the production rate and scrubber operating data available to the ADEQ inspector during

the test. The permittee shall be limited to operating at no more than 10% above the tested production rate until the next performance test is conducted pursuant to this specific condition. The permittee may re-test at any time in order to establish a different production limit, provided that testing is conducted once every five years. [Reg.18.1002 and Ark. Code Ann. § 8-4-203 as referenced by Ark. Code Ann. §§ 8-4-304 and 8-4-311]

Source	Pollutant	Test Method
SN-1202	Br <sub>2</sub>	EPA Reference Method 26 or 26A
	HBr	EPA Reference Method 26 or 26A
SN-1204	Br <sub>2</sub>	EPA Reference Method 26 or 26A
	HBr	EPA Reference Method 26 or 26A
SN-1230	Br <sub>2</sub>	EPA Reference Method 26 or 26A
	HBr	EPA Reference Method 26 or 26A

68. The permittee shall maintain monthly records which document that the production limit established in Specific Condition 67 has not been exceeded. The permittee shall maintain a twelve month rolling average and update the records by the fifteenth of the following month. These records shall be maintained on-site and shall be made available to Department personnel upon request. [Reg.18.1004 and Ark. Code Ann. § 8-4-203 as referenced by Ark. Code Ann. §§ 8-4-304 and 8-4-311]
69. The permittee may conduct additional emission testing in order to establish alternative monitoring parameters for SN-1202, SN-1204, and SN-1230 at any time. The Department may approve the alternative parameters upon receipt of the information from the permittee. The alternative parameters may become the permitted parameters upon receiving written approval from the Department. [Reg.19.303 and Ark. Code Ann. § 8-4-203 as referenced by Ark. Code Ann. §§ 8-4-304 and 8-4-311]

SN-1220 and SN-1221 Compliance Conditions

70. The permittee shall maintain, on site, documentation that the physical flow capacities, of SN-1220 and 1221 meet the values in the table below. [Reg.19.705, Ark. Code Ann. § 8-4-203 as referenced by Ark. Code Ann. §§ 8-4-304 and 8-4-311, and 40 C.F.R. § 70.6]

SN	Description	Maximum water Flow Rate Through Tower (gallons per minute)
1220	Cooling Tower (CT-12-800)	1,300
1221	Cooling Tower	1,200

71. The total dissolved solids concentrations or correlated conductivity, measured monthly, in the following table shall not be exceeded. The permittee shall demonstrate compliance by compliance with Specific Condition 72. [Reg.19.705, Ark. Code Ann. § 8-4-203 as referenced by Ark. Code Ann. §§ 8-4-304 and 8-4-311, and 40 C.F.R. § 70.6]

Great Lakes Chemical Corporation - Central Plant

Permit #: 1077-AOP-R5

AFIN: 70-00012

SN	Description	Maximum Total Dissolved Solids Concentration
1220	Cooling Tower (CT-12-800)	12,000 ppm TDS/ or 13,961 $\mu$ S
1221	Cooling Tower	12,000 ppm TDS/ or 13,961 $\mu$ S

72. The permittee shall monitor and maintain monthly records of the Total Dissolved Solids (TDS) or correlated conductivity. These records shall be kept on-site and made available to Department personnel upon request. [Reg.19.705 and 40 C.F.R. § 52 Subpart E]

Great Lakes Chemical Corporation - Central Plant  
Permit #: 1077-AOP-R5  
AFIN: 70-00012

SN-1301, SN-1314, SN-1315, SN-1337, SN-1350, SN-1351, SN-1361, SN-1362, SN-1398, SN-1399

## OCP Unit

### Source Description

GLCC operates the Organic Chemicals Processing (OCP) Unit at the Central Plant to manufacture various products for commercial sale. Products manufactured in the OCP Unit include, but are not limited to:

- DP-45
- BZ-54
- Various Blended Products
- CN-3370 (Emerald Innovation 3000)

The manufacture of each manufactured product has been addressed below.

### DP-45 Production

GLCC may also blend Low Color DP-45 with various plasticizers, surfactants, etc. to provide a variety of products for commercial sale. Blended products manufactured in the OCP Unit use Low Color DP-45.

The major steps in the production of Low Color DP-45 and blends thereof manufactured in the OCP Unit are described below:

- Raw materials are stored in tanks and hoppers
- Raw materials are combined in a premix tank
- Raw materials are reacted
- Raw product slurry is washed, concentrated, neutralized, and purified (SN-1337)
- Raw product slurry is filtered
- Raw product is stored in tanks
- Raw product is blended (if necessary)
- Product is shipped via truck, tote, or drum

### BZ-54 Production

BZ-54 is the 2-EH monoester of PHT-4. GLCC may also blend BZ-54 with various plasticizers, surfactants, etc. to provide a variety of products for commercial sale. Blended products manufactured in the OCP Unit using BZ-54 include, but are not limited to:

- BZ-54HP
- FM-550
- FM-552

The major steps in production of BZ-54 and blends thereof manufactured in the OCP Unit are described below.

- Raw materials are stored in tanks and hoppers
- Raw materials are combined in a premix tank
- Raw materials are reacted
- Raw product slurry is washed and concentrated (IA A.13)
- Raw product is stored in tanks (IA A.13)
- Raw product is blended (if necessary)
- Product is shipped via truck, tote, railcar or drum

Both DP-45 and BZ-54 production has VOC emissions controlled by OCP Unit Flare (SN-1301). Cooling tower (SN-1362) provides cooling water for these processes emissions that occur at the various connectors, pumps, and valves associated with this process (SN-1399).

#### CN-3370 (Emerald Innovation 3000) Production

Production of CN-3370 involves a number of chemical process operations. The first portion of these processes is performed as batch operations, and the second portion of these processes is performed as a continuous operation.

The batch portion of the CN-3370 process begins with the receipt of both solid and liquid raw materials. These raw materials are processed through several bromination and reaction steps to produce the desired CN-3370 product. The product is then washed prior to further processing in the continuous portion of the process. Emission points associated with the batch portion of the process include the bromine storage tank vent scrubber (SN-1350) and polymer unloading into the storage hopper (SN-1351). All process vents from the batch portion of the process are routed through a closed-vent system to the Bromine Recovery Unit (BRU) for emission control.

In the continuous portion of the process, the CN-3370 product is processed through a precipitator followed by a solid/liquid separator to remove the solid product from solution. The solid product is then routed through a flash dryer and vacuum tray dryer in series. The dried product is then sent to a packaging silo (SN-1314) for storage prior to final packaging (SN-1315). The liquid from the solid-liquid separator is processed for solvent recovery. The recovered solvent is recycled for use in the batch portion of the process. All vents from the continuous portion of the process up to and including the dryers are routed to an IPA scrubber and then to the BRU for emission control. Additional emission sources associated with the CN3370 process at the OCP include cooling tower (SN-1361) and fugitive equipment leaks (SN-1398).

#### Air Emissions

The predominant air pollutant emissions sources in the OCP Unit are process vessels, storage vessels, and baghouses. Vent condensers are used to control some process vessels (i.e. reactors,



strippers, etc.) operated in the OCP Unit. Condensed materials are refluxed, and any non-condensable gases (NCGs) or other vapors (e.g. 2-EH) are routed from the vent condensers to flare or a caustic scrubber before venting to atmosphere. Some units with minimal air pollutant emissions (such as storage vessels and baghouses) vent directly to atmosphere.

### Regulatory Applicability

In addition to the regulatory applicability indicated in the Facility Regulatory Applicability Section, the CN-3370 process at the OCP Unit is subject to the provisions of 40 CFR Part 63 Subpart FFFF – *National Emission Standards for Hazardous Air Pollutants: Miscellaneous Organic Chemical Manufacturing* (MON MACT).

### Specific Conditions

73. The permittee shall not exceed the emission rates set forth in the following table. For SN-1301, compliance with the maximum hourly limits shall be demonstrated by compliance with Specific Condition 79 and maximum usage of natural gas. For SN-1314, SN-1315, and SN-1337 compliance with the maximum hourly limits shall be demonstrated by Specific Conditions 75; the annual limits are based upon maximum operation of the source at the hourly rate. For SN-1361 and SN-1362 compliance with the maximum hourly limits shall be demonstrated by Specific Conditions 75, 82, and 83; the annual limits are based upon maximum operation of the source. [Reg.19.501 et seq. and 40 C.F.R. § 52 Subpart E]

SN	Description	Pollutant	lb/hr	tpy
1301	OCP Facility Flare	PM <sub>10</sub>	0.1	0.2
		SO <sub>2</sub>	0.1	0.1
		VOC	1.1	4.9
		CO	1.8	7.9
		NO <sub>x</sub>	0.4	1.5
1314	SN3370a Packaging Silo Baghouse (BH-13-004)	PM <sub>10</sub>	0.2	0.7
		VOC	5.0	22.1
1315	SN3370a Packaging Baghouse (BH-13-005)	PM <sub>10</sub>	0.3	1.2
		VOC	0.1	0.6
1337	IAC Filter Receiver Fabric Filter (BH-13-297)	PM <sub>10</sub>	0.2	0.8
1351	CN-3370a Polymer Unloading	PM <sub>10</sub>	0.5	1.2
1361	CN-3370 Cooling Tower	PM <sub>10</sub>	0.5	1.9
1362	Cooling Tower	PM <sub>10</sub>	0.2	0.5
1398	CN-3370 Fugitives	VOC	1.5	6.6
1399	Fugitive Equipment Leaks	VOC	1.9	8.1

74. The permittee shall not exceed the emission rates set forth in the following table. For SN-1301, compliance with the maximum hourly limits shall be demonstrated by compliance with Specific Conditions 79, and maximum usage of natural gas; the annual limits shall be demonstrated by maximum usage of natural gas. For SN-1314, SN-1315, and SN-1337 compliance with the maximum hourly limits shall be demonstrated by Specific Condition 75; the annual limits are based upon maximum operation of the source at the hourly rate. For SN-1361 and SN-1362 compliance with the maximum hourly limits shall be demonstrated by Specific Conditions 75, 82, and 83; the annual limits are based upon maximum operation of the source. [Reg.18.801 and Ark. Code Ann. § 8-4-203 as referenced by Ark. Code Ann. §§ 8-4-304 and 8-4-311]

SN	Description	Pollutant	lb/hr	tpy
1301	OCP Facility Flare	PM	0.1	0.2
		Benzene	0.01	0.01
		Beryllium	0.01	0.01
		Cadmium	0.01	0.01
		Chromium	0.01	0.01
		Cobalt	0.01	0.01
		Dichlorobenzene	0.01	0.01
		Formaldehyde	0.01	0.01
		Hexane	0.01	0.01
		Manganese	0.01	0.01
		Mercury	0.01	0.01
		Naphthalene	0.01	0.01
		Nickel	0.01	0.01
		Selenium	0.01	0.01
		Toluene	0.01	0.01
POM	0.01	0.01		
1314	SN3370a Packaging Silo Baghouse (BH-13-004)	PM	0.2	0.7
1315	SN3370a Packaging Baghouse (BH-13-004)	PM	0.3	1.2
1337	IAC Filter Receiver Fabric Filter (BH-13-297)	PM	0.2	0.8
		Br <sub>2</sub>	1.00	4.38
		Cl <sub>2</sub>	0.01	0.05
1350	CN3370a Bromine Storage Tank Caustic Vent Scrubber	Br <sub>2</sub>	0.11	0.07
		Cl <sub>2</sub>	0.01	0.05
1351	CN3370 Polymer Unloading	PM	1.0	2.5
1361	CN-3370 Cooling Tower	PM	0.5	1.9
1362	Cooling Tower	PM	0.2	0.5
1398	CN-3370 Fugitives	Br <sub>2</sub>	1.5	6.52
		Methylene Chloride	1.5	6.52

SN	Description	Pollutant	lb/hr	tpy
1399	Fugitive Equipment Leaks	Methanol	1.85	8.07

75. The Visible emissions may not exceed the limits specified in the following table as measured by EPA Reference Method 9. Compliance will be verified by meeting the requirements of Specific Condition 76.

SN	Description	Limit
1314	SN3370a Packaging Silo Baghouse (BH-13-004)	5%
1315	SN3370a Packaging Baghouse (BH-13-005)	5%
1337	IAC Filter Receiver Fabric Filter (BH-13-297)	5%
1351	CN3370a Polymer Unloading	5%

76. Weekly observations of the opacity from sources SN-1314, 1315, and, 1337 shall be conducted by a person trained but not necessarily certified in EPA Reference Method 9. If visible emissions in excess of the permitted levels are detected, the permittee shall immediately take action to identify the cause of the visible emissions in excess of the permit limit, implement corrective action, and document that visible emissions did not appear to be in excess of the permitted opacity following the corrective action. The permittee shall maintain records which contain the following items in order to demonstrate compliance with this specific condition. These records shall be updated weekly, kept on site, and made available to Department personnel upon request.
- The date and time of the observation.
  - If visible emissions which appeared to be above the permitted limit were detected.
  - If visible emissions which appeared to be above the permitted limit were detected, the cause of the exceedance of the opacity limit, the corrective action taken, and if the visible emissions appeared to be below the permitted limit after the corrective action was taken.
  - The name of the person conducting the opacity observations.

[Reg.18.501 of Regulation 19 and Ark. Code Ann. § 8-4-203 as referenced by Ark. Code Ann. §§ 8-4-304 and §8-4-311]

77. The permittee will be limited to the following production lot rates in the following table:  
 [Reg.19.705, Ark. Code Ann. § 8-4-203 as referenced by Ark. Code Ann. §§ 8-4-304 and 8-4-311, and 40 C.F.R. § 70.6]

Product	Production Lot Per Year
BZ-54	1,095
DP-45	876
CN-3370	17,650
Polymer	20,650

78. The permittee shall maintain monthly records of production listed in the table in Specific Condition 77. Compliance shall be determined on a monthly basis by totaling throughput for that month and the previous 11 months. Each 12-month rolling total shall be updated by the fifteenth day of the month following the month to which the records pertain. These records shall be kept on-site and shall be submitted in accordance with General Provision #7. [Reg.19.705 and 40 C.F.R. § 52 Subpart E]

SN-1301 Compliance Conditions

79. The permittee shall use only pipeline quality natural gas as fuel for the flare pilot (SN-1301). [Reg.19.705, Ark. Code Ann. § 8-4-203 as referenced by Ark. Code Ann. §§ 8-4-304 and 8-4-311, and 40 C.F.R. § 70.6]
80. A pilot flame shall be present on the flare at all times. A camera or a thermocouple shall be used to monitor the presence of the flare pilot flame. An alarm (visible and/or audible) shall be triggered when the flame detection device fails to detect a flame. [Reg.19.303 and Ark. Code Ann. § 8-4-203 as referenced by Ark. Code Ann. §§ 8-4-304 and 8-4-311]

SN-1361 and SN-1362 Compliance Conditions

81. The water flow rates in the following table shall not be exceeded. The permittee shall maintain, on site, documentation that the physical flow capacities, of SN-1361 and SN-1362 meet the values in the table. [Reg.19.705, Ark. Code Ann. § 8-4-203 as referenced by Ark. Code Ann. §§ 8-4-304 and 8-4-311, and 40 C.F.R. § 70.6]

SN	Description	Maximum Water Flow Rate Through Tower (gallons per minute)
1361	CN-3370 Cooling Tower	14,400
1362	Cooling Tower	3,600

82. The total dissolved solids concentrations or correlated conductivity, measured monthly, in the following table shall not be exceeded. The permittee shall demonstrate compliance by compliance with Specific Condition 83. [Reg.19.705, Ark. Code Ann. § 8-4-203 as referenced by Ark. Code Ann. §§ 8-4-304 and 8-4-311, and 40 C.F.R. § 70.6]

SN	Description	Maximum Total Dissolved Solids Concentration
1361	CN-3370 Cooling Tower	12,000 ppm TDS 13,961 µS
1362	CN-3370 Cooling Tower	12,000 ppm TDS 13,961 µS

Great Lakes Chemical Corporation - Central Plant

Permit #: 1077-AOP-R5

AFIN: 70-00012

83. The permittee shall monitor and maintain monthly records of Total Dissolved Solids (TDS) or correlated conductivity. These records shall be kept on-site and made available to Department personnel upon request. [Reg.19.705 and 40 C.F.R. § 52 Subpart E]

Great Lakes Chemical Corporation - Central Plant  
Permit #: 1077-AOP-R5  
AFIN: 70-00012

SN-1403, SN-1404, SN-1406A, SN-1406B, SN-1409, SN-1413, SN-1420, SN-1421, SN-1422,  
SN-1423, SN-1430, SN-1431, SN-1433, SN-1435, SN-1499  
TCO Unit

### Source Description

GLCC operates the Tetrabromobisphenol-A carbonated oligomer (TCO) Unit at the Central Plant to produce oligomers for commercial sale. Oligomers produced in the TCO Unit include, but are not limited to, TBBPA and tribromophenol polymer chains capped with molecules including, but not limited to, phenol and tribromophenol.

The materials, methods of manufacturing, and air pollutant emissions during manufacture of these products differ only slightly from product to product. The major steps in oligomer production in the TCO Unit are described below.

- Raw materials are stored in tanks and hoppers
- Raw materials are combined in a premix tank
- Raw materials are reacted
- Raw product is centrifuged, decanted, and acid washed
- Oligomer slurry is centrifuged
- Oligomer cake is dried in the flash dryers
- Oligomer product is pneumatically transported to storage silos
- Oligomer product is bagged or shipped via truck

### Air Pollutant Emissions

The predominant air pollutant emissions sources in the TCO Unit are the process vessels. Vent condensers are used to control the process vessels (i.e. reactors, strippers, etc.) operated during oligomer production. Condensed materials are refluxed, and non-condensable gas (NCG) and other vapors (e.g. methylene chloride, phosgene, etc.) are routed from the vent condensers to the Methylene Chloride Recovery Unit (MCRU). MCRU tank emissions are routed to the MCRU Absorber (SN-1404) to recovers organic materials. A water scrubber (SN-1409) controls emissions from an Acid Tank. The raw material surge hopper particulate matter emissions are controlled by a vent filter (SN-1423). Oligomer slurry is sent to two centrifuges (SN-1406A and SN-1406B), before being sent to flash dryers, which are controlled by two baghouses (SN-1403 and SN-1413). Tank and sump emissions vented to the atmosphere include two water tanks (SN-1430 and 1431), two wastewater storage tanks (SN-1421 and SN-1422), and the TCO wastewater sump (SN-1420). Emissions from the cooling tower SN-1433 is estimated based on its maximum water flow rate. Emissions occur at various connectors, pumps, and valves associated with the piping for this process (SN-1499).

Regulatory Applicability

In addition to the regulatory applicability indicated in the Facility Regulatory Applicability Section, there is some additional applicability indicated below. The TCO Unit is subject to 40 CFR Part 63 Subpart UU *National Emission Standards for Equipment Leaks - Control Level 2 Standards*, Subpart YY *National Emission Standards for Hazardous Air Pollutants for Source Categories: Generic Maximum Achievable Control Technology Standards*, and Subpart FFFF *National Emission Standard for Hazardous Air Pollutants: Miscellaneous Organic Chemical Manufacturing*.

Specific Conditions

84. The permittee shall not exceed the emission rates set forth in the following table. For SN-1403, SN-1413, and SN-1423, compliance with the maximum hourly limits shall be demonstrated by compliance with Specific Conditions 86 and 93. For SN-1406A and SN-1406B, compliance with the maximum hourly limits shall be demonstrated by Specific Condition 92. For SN-1420, compliance with the maximum hourly limits shall be demonstrated by Specific Condition 92. For SN-1404, compliance with the maximum hourly limits shall be demonstrated by Specific Condition 92. For SN-1433 and SN-1434, compliance shall be demonstrated by Specific Conditions 94 and 95. For all sources, compliance with the ton per year limits shall be demonstrated by compliance with Specific Condition 88. [Reg.19.501 et seq. and 40 C.F.R. § 52 Subpart E]

SN	Description	Pollutant	lb/hr	tpy
1403	Oligomer Baghouse #2 (BH-14-002)	PM <sub>10</sub>	1.8	7.6
		VOC	1.0	4.4
1404	MCRU Absorber (CL-14-501)	VOC	2.0	8.8
		CO	0.1	0.5
1406A	Oligomer Slurry Centrifuge#1 (CF-14-001)	VOC	0.1	0.5
1406B	Oligomer Slurry Centrifuge #2 (CF-14-002)	VOC	0.1	0.5
1413	Oligomer Baghouse #1 (BH-14-001)	PM <sub>10</sub>	2.0	8.7
		VOC	1.0	4.4
1420	TCO Wastewater Sump	VOC	1.0	4.4
1421	Wastewater Storage Tank (TT-14-028)	VOC	0.1	0.1
1422	Wastewater Storage Tank (TT-14-029)	VOC	0.1	0.1
1423	Surge Hopper Vent Filter (BH-14-701)	PM <sub>10</sub>	0.3	1.2
1433	Cooling Tower (CT-14-101)	PM <sub>10</sub>	0.4	1.7
1499	Oligomer Process & MCRU Fugitive Equipment Leaks	VOC	3.3	14.1

## Great Lakes Chemical Corporation - Central Plant

Permit #: 1077-AOP-R5

AFIN: 70-00012

85. The permittee shall not exceed the emission rates set forth in the following table. For SN-1403, SN-1413, and SN-1423, compliance with the maximum hourly limits shall be demonstrated by compliance with Specific Conditions 88, 90, 91, and 92. For SN-1406A and SN-1406B, compliance with the maximum hourly limits shall be demonstrated by Specific Condition 92. For SN-1420, compliance with the maximum hourly limits shall be demonstrated by Specific Condition 92. For SN-1404, compliance with the maximum hourly limits shall be demonstrated by Specific Conditions 90 and 92. For SN-1409, compliance with the maximum hourly limits shall be demonstrated by Specific Conditions 91, and 99. For SN-1433 and SN-1434, compliance shall be demonstrated by Specific Conditions 94 and 94. For all sources, compliance with the ton per year limits shall be demonstrated by compliance with Specific Condition 86. [Reg.18.801 and Ark. Code Ann. § 8-4-203 as referenced by Ark. Code Ann. §§ 8-4-304 and 8-4-311]

SN	Description	Pollutant	lb/hr	tpy
1403	Oligomer Baghouse #2 (BH-14-002)	PM	1.8	7.6
		Ethyl Chloride	0.01	0.44
		Methylene Chloride	2.00	8.76
		Triethylamine	0.01	0.44
1404	MCRU Absorber (CL-14-501)	Ethyl Chloride	2.00	8.76
		Methylene Chloride	0.50	2.19
		Triethylamine	0.01	0.44
		TEA & Ethyl Chloride	0.01	0.44
1406A	Oligomer Slurry Centrifuge (CF-14-001)	Ethyl Chloride	0.01	0.44
		Methylene Chloride	0.01	0.44
		Triethylamine	0.01	0.44
1406B	Oligomer Slurry Centrifuge (CF-14-002)	Ethyl Chloride	0.01	0.44
		Methylene Chloride	0.01	0.44
		Triethylamine	0.01	0.44
1409	Acid Vent Scrubber (VS-14-225)	HCl	1.70	2.05
1413	Oligomer Baghouse #1 (BH-14-001)	PM	2.0	8.7
		Ethyl Chloride	0.01	0.44
		Methylene Chloride	2.00	8.76
		Triethylamine	0.01	0.44
1420	TCO Wastewater Sump	Ethyl Chloride	0.55	2.41
		Methylene Chloride	0.25	1.10
		Triethylamine	0.02	0.09
1421	Wastewater Storage Tank (TT-14-028)	Ethyl Chloride	0.01	0.01
		Methylene Chloride	0.04	0.02
		Triethylamine	0.01	0.01
1422	Wastewater Storage Tank (TT-14-029)	Ethyl Chloride	0.01	0.01
		Methylene Chloride	0.04	0.02
		Triethylamine	0.01	0.01



SN	Description	Pollutant	lb/hr	tpy
1423	Surge Hopper Vent Filter (BH-14-701)	PM	0.3	1.2
1430	Water Tank (TT-14-034)	Methylene Chloride	0.10	0.44
1431	Water Tank (TT-14-035)	Methylene Chloride	0.10	0.44
1433	Cooling Tower (CT-14-101)	PM	0.4	1.7
1435	Phosgene Scrubber	Phosgene	0.06	0.27
1499	Oligomer Process & MCRU Fugitive Equipment Leaks	Ethyl Chloride	0.83	3.67
		HCl	0.45	1.98
		Methylene Chloride	1.81	7.95
		Phosgene	0.83	3.67
		Triethylamine	2.41	10.56

86. Visible emissions may not exceed the limits specified in the following table of this permit as measured by EPA Reference Method 9. Compliance with this limit shall be verified by compliance with Specific Condition 87.

SN	Limit	Regulatory Citation
1403, 1413, and 1423	5%	Reg.18.501

87. Weekly observations of the opacity from sources SN-1403, SN-1413, and SN-1423 shall be conducted by a person trained but not necessarily certified in EPA Reference Method 9. If visible emissions in excess of the permitted levels are detected, the permittee shall immediately take action to identify the cause of the visible emissions in excess of the permit limit, implement corrective action, and document that visible emissions did not appear to be in excess of the permitted opacity following the corrective action. The permittee shall maintain records which contain the following items in order to demonstrate compliance with this specific condition. These records shall be updated weekly, kept on site, and made available to Department personnel upon request.
- The date and time of the observation.
  - If visible emissions which appeared to be above the permitted limit were detected.
  - If visible emissions which appeared to be above the permitted limit were detected, the cause of the exceedance of the opacity limit, the corrective action taken, and if the visible emissions appeared to be below the permitted limit after the corrective action was taken.
  - The name of the person conducting the opacity observations.
88. The permittee will be limited to the following production lot rates in the following table: [Reg.19.705, Ark. Code Ann. § 8-4-203 as referenced by Ark. Code Ann. §§ 8-4-304 and 8-4-311, and 40 C.F.R. § 70.6]

Product	Production Lot Per Year
TBBPA Oligomers	11,064

89. The permittee shall maintain monthly records of production listed in the table in Specific Condition 88. Compliance shall be determined on a monthly basis by totaling throughput for that month and the previous 11 months. Each 12-month rolling total shall be updated by the fifteenth day of the month following the month to which the records pertain. These records shall be kept on-site and shall be submitted in accordance with General Provision #7. [Reg.19.705 and 40 C.F.R. § 52 Subpart E]

90. The permittee shall maintain the control equipment parameters shown in the following table. The permittee shall monitor these parameters every twelve hours of operation of the source and keep written records of the readings. These records shall be kept on site and made available to Department personnel upon request. These parameters were established at the time of permit application. [Reg.19.303 and Ark. Code Ann. § 8-4-203 as referenced by Ark. Code Ann. §§ 8-4-304 and 8-4-311]

SN	Description	Control Equipment	Minimum Operating Limits
1404	MCRU Absorber (CL-14-501)	Absorber	Total water at 9.0 gallons/minute when the TCO is operating
			Recycle water at 5.0 gallons/minute at all other times

91. The permittee shall maintain the control equipment parameters shown in the following table. The permittee shall, for SN-1409, continuously monitor and record these parameters to demonstrate continuous compliance. These records shall be kept on site and made available to Department personnel upon request. The permittee may change the minimum operating limits based on the results of the testing required by the 40 CFR Part 63, Subpart FFFF. [Reg.19.304 and 40 C.F.R. § 63.2470(c)(1)]

SN	Description	Control Equipment	Minimum Operating Limits
1409	Acid Vent Scrubber (VS-14-225)	Scrubber	15.0 gallons/minute

92. For SN-1435, the permittee will measure once per shift to demonstrate compliance with the minimum caustic concentration in the table below and once every 4 hours to demonstrate compliance with the minimum flow rates. The record of flow rate should include indication of emergency operation, if applicable. Records of these measurements should be kept on site and made available to Department personnel upon request. [Reg.19.705, Ark. Code Ann. § 8-4-203 as referenced by Ark. Code Ann. §§ 8-4-304 and 8-4-311, and 40 C.F.R. § 70.6]

SN	Description	Control Equipment	Minimum Operating Limits
1435	Phosgene Scrubber	Scrubber	Normal: 350 gpm, 10 pH caustic Emergency: 1,400 gpm, 20% caustic

93. The permittee shall measure the emissions as specified in the following table in accordance with the test procedures also in the table. Testing shall be conducted at least once every five years. The permittee shall test one oligomer baghouse (SN-1403 or SN-1413) and one Oligomer Slurry Centrifuge (SN-1406A or SN-1406B), with the untested sources tested during the next event. The facility shall document the TBBPA Oligomer production rate in Specific Condition 88 during the performance test and make production rate data available to the ADEQ Inspector during the test. The permittee shall be limited to operating at no more than 10% above the tested production rate until the next performance test conducted pursuant to this Specific Condition. The permittee may re-test at any time in order to establish a different production limit, provided the testing is conducted at least once every five years. [Reg.19.702 and 40 C.F.R. § 52 Subpart E and Reg.18.1002 and Ark. Code Ann. § 8-4-203 as referenced by Ark. Code Ann. §§ 8-4-304 and 8-4-311]

Source	Pollutant	Test Method
SN-1403 or SN-1413	Organic HAPs Non-VOC Organic HAPs	EPA Reference Method 18 EPA Reference Method 18
SN-1406A or SN-1406B	Organic HAPs Non-VOC Organic HAPs	EPA Reference Method 18 EPA Reference Method 18
SN-1404	Organic HAPs Non-VOC Organic HAPs CO VOC	EPA Reference Method 18 EPA Reference Method 18 EPA Reference Method 10 EPA Reference Method 25 or 25A

94. The water flow rate in the following table shall not be exceeded. The permittee shall maintain, on site, documentation that the physical flow capacity of SN-1433 meets the value in the table. [Reg.19.705, Ark. Code Ann. § 8-4-203 as referenced by Ark. Code Ann. §§ 8-4-304 and 8-4-311, and 40 C.F.R. § 70.6]

SN	Description	Maximum Water Flow Rate Through Tower (gallons per minute)
1433	Cooling Tower (CT-14-101)	1,680

95. The total dissolved solids concentration for SN-1433 shall not exceed 9,000 ppm or a correlated conductivity of 10,509  $\mu$ S, measured monthly. The permittee shall demonstrate compliance with this condition by compliance with Specific Condition 96. [Reg.19.705, Ark. Code Ann. § 8-4-203 as referenced by Ark. Code Ann. §§ 8-4-304 and 8-4-311, and 40 C.F.R. § 70.6]

SN	Description	Maximum Total Dissolved Solids Concentration
1433	Cooling Tower (CT-14-101)	9,000 ppm TDS/10,509 $\mu$ S

96. The permittee shall monitor and record TDS or correlated conductivity on a monthly basis and maintain these records on a continuous, rolling 12-month average. These records shall be kept on-site and made available to Department personnel upon request. [Reg.19.705 and 40 C.F.R. § 52 Subpart E]
97. The permittee shall monitor the concentration of organic compounds in the wastewater at SN-1420. The concentration of organic compounds in the wastewater shall not exceed 4,000 ppm on a rolling 12-month average basis. The permittee shall conduct sampling and test the organic content of the wastewater once per month. [Reg.19.703, 40 C.F.R. § 52 Subpart E, and Ark. Code Ann. § 8-4-203 as referenced by Ark. Code Ann. §§ 8-4-304 and 8-4-311]
98. The permittee will maintain monthly records to demonstrate compliance with Specific Condition 97. The permittee will update the records by the fifteenth day of the month following the month. The permittee will keep the records onsite, and make the records available to Department personnel upon request. [Reg.19.705 and 40 C.F.R. § 52 Subpart E]

MACT Requirements

99. The TCO unit is subject to and shall comply with all applicable provisions of 40 CFR Part 63 Subpart YY - National Emission Standards for Hazardous Air Pollutants for Source Categories: Generic Maximum Achievable Control Technology Standards. The TCO unit is subject to this subpart due to the oligomer production being classified as “polycarbonate production” as defined in §63.1103(d) (2). A copy of Subpart YY has been attached to this permit as Appendix D. [Reg.19.304 and 40 C.F.R. § 63.1100]
100. In order to demonstrate compliance with 40 CFR Part 63 Subpart YY, the permittee has elected to comply with the requirements of 40 CFR Part 63 Subpart UU as specified in

Table 5 to §63.1103(d). The TCO Unit is subject to and shall comply with all applicable provisions of 40 CFR Part 63 Subpart UU as referenced by §63.1103(d) of Subpart YY. A copy of Subpart UU has been attached to this permit as Appendix C. [Reg.19.304 and 40 C.F.R. § 63.1103(d)]

101. The permittee shall comply with the following requirements of Subpart UU:
- a. All equipment subject to Subpart UU shall be properly identified in accordance with the requirements of §63.1022
  - b. The permittee shall comply with the requirements for instrument and sensory monitoring for leaks in accordance with the requirements of §63.1023.
  - c. The permittee shall comply with the requirements for leak repair in accordance with the requirements of §63.1024.
    - i. The permittee shall repair each leak detected as soon as practical, but not later than 15 calendar days after it is detected, except as provided in paragraphs (d) and (e) of §63.1024.
  - d. The permittee shall comply with the requirements for valves in gas and vapor service and in light liquid service in accordance with the requirements of §63.1025.
  - e. The permittee shall comply with the requirements for pumps in light liquid service in accordance with the requirements of §63.1026.
  - f. The permittee shall comply with the requirements for connectors in gas and vapor service and in light liquid service in accordance with the requirements of §63.1027.
  - g. The permittee shall comply with the requirements for agitators in gas and vapor service and in light liquid service in accordance with the requirements of §63.1028.
  - h. The permittee shall comply with the requirements for pumps, valves, connectors, and agitators in heavy liquid service; pressure relief devices in liquid service; and instrumentation systems in accordance with the requirements of §63.1029.
  - i. The permittee shall comply with the requirements for pressure relief devices in gas and vapor service in accordance with the requirements of §63.1030.
  - j. The permittee shall comply with the requirements for compressors in accordance with the requirements of §63.1031.
  - k. The permittee shall comply with the requirements for sampling connection systems in accordance with the requirements of §63.1032.
  - l. The permittee shall comply with the requirements for open-ended valves or lines in accordance with the requirements of §63.1033.
  - m. The permittee shall comply with the requirements for closed vent systems and control devices; or emissions routed to a fuel gas system or process in accordance with the requirements of §63.1034.

- n. The permittee shall comply with the recordkeeping requirements of §63.1038.
  - i. The permittee may comply with the recordkeeping requirements of Subpart UU for multiple regulated sources in one recordkeeping system. The recordkeeping system shall identify each record by regulated source and the type of program being implemented for each type of equipment. [§63.1038(a)]
  - ii. The permittee shall comply with the general equipment leak records requirements of §63.1038(b).
    - 1. The permittee shall keep general and specific equipment identification if the equipment is not physically tagged and the permittee is electing to identify the equipment subject to this subpart through written documentation such as a log or other designation. [§63.1038(b)(1)]
    - 2. The permittee shall keep a written plan as specified in §63.1022(c) (4) for any equipment that is designated as unsafe or difficult-to-monitor. [§63.1038(b)(2)]
    - 3. The permittee shall maintain a record of the identity and an explanation as specified in §63.1022(d) (2) for any equipment that is designated as unsafe-to-repair.
    - 4. As specified in §63.1022(e) the owner or operator shall maintain the identity of compressors operating with an instrument reading of less than 500 parts per million.
    - 5. The permittee shall keep records associated with the determination that equipment is in heavy liquid service as specified in §63.1022(f).
    - 6. The permittee shall keep records for leaking equipment as specified in §63.1023(e) (2).
    - 7. The permittee shall keep records for leak repair as specified in §63.1024(f) and records for delay of repair as specified in §63.1024(d).
  - iii. The permittee shall comply with the specific equipment leak records requirements of §63.1038(c).
    - 8. For valves, the permittee shall maintain the following records.
      - a. The monitoring schedule for each process unit as specified in §63.1025(b) (3) (vi).
      - b. The valve subgrouping records specified in §63.1025(b) (4) (iv) if applicable.
    - 9. For pumps, the permittee shall maintain the following records:

- a. Documentation of pump visual inspections as specified in §63.1026(b)(4).
  - b. Documentation of dual mechanical seal pump visual inspections as specified in §63.1026(e)(1)(v).
  - c. For the criteria as to the presence and frequency of drips for dual mechanical seal pumps, records of the design criteria and explanations and any changes and the reason for the changes as specified in §63.1026(e)(1)(i).
10. For connectors, the permittee shall maintain the monitoring schedule for each process unit as specified in §63.1027(b)(3)(v).
11. For agitators, the owner or operator shall maintain the following records:
  - a. Documentation of agitator seal visual inspections as specified in §63.1028.
  - b. For the criteria as to the presence and frequency of drips for agitators, the permittee shall keep records of the design criteria and explanations and any changes and the reason for the changes, as specified in §63.1028(e)(1)(vi).
12. For pressure relief devices in gas and vapor or light liquid service, the permittee shall keep records of the dates and results of monitoring following a pressure release, as specified in §63.1030(c)(3).
13. For compressors, the permittee shall maintain the following records:
  - a. For criteria as to failure of the seal system and/or the barrier fluid system, record the design criteria and explanations and any changes and the reason for the changes as specified in §63.1031(d)(2).
  - b. For compressors operating under the alternative compressor standard, record the dates and results of each compliance test as specified in §63.1031(f)(2).
- o. The permittee shall comply with the reporting requirements of §63.1039.
  - i. The permittee shall submit an initial compliance status report in accordance with the procedures of Subpart YY. The notification shall include the information listed in paragraphs (a)(1) through (a)(3) of §63.1039.
  - ii. The permittee shall report the information specified in paragraphs (b)(1) through (b)(8) of §63.1039, as applicable, in the periodic report specified

in Subpart YY. This report shall meet the requirements of §63.1110(e) of Subpart YY.

14. For the equipment specified in paragraphs (b)(1)(i) through (b)(1)(v) of §63.1039, the permittee shall report in a summary format by equipment type, the number of components for which leaks were detected and for valves, pumps, and connectors, show the percent leakers, and the total number of components monitored. Also include the number of leaking components that were not repaired as required by §63.1024, and for valves and connectors, identify the number of components that are determined by §63.1025(c)(3) to be nonrepairable.
15. Where any delay of repair is utilized pursuant to §63.1024(d), report that delay of repair has occurred and the number of instances of delay of repair.
16. If applicable, report the valve subgrouping information specified in §63.1025(b)(4)(iv).
17. For pressure relief devices in gas and vapor service pursuant to §63.1030(b) and for compressors pursuant to §63.1031(f) that are to be operated at a leak detection reading of less than 500 parts per million, report the results of all monitoring to show compliance conducted within the semiannual reporting period.
18. Report, if applicable, the initiation of a monthly monitoring program for valves pursuant to §63.1025(b)(3)(i).
19. Report, if applicable, the initiation of a quality improvement program for pumps pursuant to §63.1035.
20. Report the information listed in paragraph (a) of §63.1039 for the initial compliance report for process units or affected facilities with later compliance dates. Report any revisions to items in an earlier initial compliance status report if the method of compliance has changed since the last report.



Great Lakes Chemical Corporation - Central Plant  
Permit #: 1077-AOP-R5  
AFIN: 70-00012

SN-1501, SN-1504, SN-1551, SN-1552, SN-1599  
Packaging and Shipping Area

Source Description

At GLCC Central, products are placed into containers and bulk loaded at the Packaging and Shipping (P&S) Facility. Containers are emptied of returned product. These activities and associated emissions points are described in the following paragraphs.

Bromine Drum Cleaning and Bromine Container Filling

Bromine drums are returned to GLCC Central for reuse. These drums are emptied, cleaned (with water) and dried. Bromine vapors generated during these operations are collected and routed to a caustic scrubber (SN-1501).

Bromine is placed into drums, cylinders, and bottles to be shipped offsite. Vapors from these operations are vented to a caustic scrubber (SN-1551).

Product Packaging (other than Methyl Bromide)

Various products can be placed into drums and cylinders, including heavy fluids, alkyl bromides, ethylene dibromide, ethylene dibromide blends, ammonium bromide solution, and hydrogen bromide solution. Packaging of these products takes place at P&S at the South Drum Station (SN-1552) and the North Drum/Cylinder Station (SN-1504).

Air Pollutant Emissions

The process air pollutant emissions sources are explained for the processes described above. Additionally, the P&S Unit has an emergency vent stack in the event of an upset condition. This is not a permitted source as it is only used for an upset condition. Emissions occur at various connectors, pumps, and valves associated with piping for this process (SN-1599).

Regulatory Applicability

The P&S Facility methyl bromide and ethyl bromide units are subject to 40 CFR Part 60, Subpart VV—Standards of Performance for Equipment Leaks of VOC in the Synthetic Organic Chemicals Manufacturing Industry for which Construction, Reconstruction, or Modification Commenced After January 5, 1981, and on or Before November 7, 2006 (NSPS Subpart VV) as currently indicated in permit 1077-AOP-R1. Otherwise, the P&S Facility has no additional regulatory applicability beyond that indicated in the Facility Regulatory Applicability Section.

Specific Conditions

102. The permittee shall not exceed the emission rates set forth in the following table. For SN-1504, compliance with the maximum hourly emission rate shall be demonstrated by Specific Condition 108; annual emission rate is based upon maximum operation of the source at the specified control parameters of Specific Condition 110. For SN-1552, compliance with the maximum hourly emission rate shall be demonstrated by Specific Condition 109; annual limits shall be demonstrated by Specific Condition 110. [Reg.19.501 et seq. and 40 C.F.R. § 52 Subpart E]

SN	Description	Pollutant	lb/hr	tpy
1504	North Drum/Cylinder Station (WT003-005)	VOC	1.2	5.1
1552	South Drum Station (WT-03-001)	VOC	1.6	7.1
1599	Fugitive Equipment Leaks	VOC	1.5	6.5

103. The permittee shall not exceed the emission rates set forth in the following table. For SN-1501, compliance with the maximum hourly emission rate shall be demonstrated by Specific Conditions 105 and 106, annual emission rate is 8,760 hours of operation at the hourly rate. For SN-1504, compliance with the maximum hourly emission rates shall be demonstrated by Specific Condition 108 annual limits shall be demonstrated by Specific Condition 110. For SN-1551, compliance with the maximum hourly emission rate shall be demonstrated by Specific Conditions 105 and 106; annual emission rate is 8,760 hours of operation at the hourly rate. For SN-1552, compliance with the maximum hourly emission rates shall be demonstrated by Specific Condition 109; annual limits shall be demonstrated by Specific Condition 110. [Reg.18.801 and Ark. Code Ann. § 8-4-203 as referenced by Ark. Code Ann. §§ 8-4-304 and 8-4-311]

SN	Description	Pollutant	lb/hr	tpy
1501	Bromine Container Cleaning Scrubber (VS-03-008)	Br <sub>2</sub>	1.0	4.40
		Cl <sub>2</sub>	0.01	0.05
		HBr	1.00	4.40
1504	North Drum/Cylinder Station (WT-03-005)	HCl	0.01	0.05
		HBr	0.10	0.44
1551	Bromine Packaging Scrubber (VS-03-001)	Br <sub>2</sub>	0.5	2.2
		Cl <sub>2</sub>	0.10	0.44
1552	South Drum Station (WT-03-001)	Ammonium Bromide	0.01	0.02

P & S Vent Stack Compliance Conditions

104. Except during periods of planned routine BRU maintenance as allowed in the PAI MACT [40 CFR 63.1362(c)(5)], there shall be no emissions from the P&S Vent Stack. Emissions occurring outside of these allowed periods shall be documented as deviations or upset conditions and shall be reported under General Provision 8. [Reg.19.705 and 40 C.F.R. § 52 Subpart E]

SN-1501 and SN-1551 Compliance Conditions

105. The permittee shall maintain the control equipment parameters shown in the following table. The permittee shall monitor these parameters daily and keep written records of the readings. These records shall be kept on site and made available to Department personnel upon request. If the caustic concentration and caustic solution flow rate falls below the minimum listed value, corrective action shall be taken immediately and the situation corrected within twelve hours. The permittee shall maintain records of sampling and corrective actions taken. These parameters were established at the time of permit application. [Reg.19.303 and Ark. Code Ann. § 8-4-203 as referenced by Ark. Code Ann. §§ 8-4-304 and 8-4-311]

SN	Description	Control Equipment	Minimum Operating Limits
1501	Bromine Container Cleaning Scrubber (VS-03-008)	Scrubber	1.5 gal/min of caustic solution 2.5% caustic concentration
1551	Bromine Packaging Scrubber (VS-03-001)	Scrubber	1.5 gal/min of caustic solution 2.5% caustic concentration

106. The permittee shall verify, through periodic testing, that SN-1501 and SN-1551 are operating in compliance with the maximum hourly HBr and Br<sub>2</sub> emission rates established by Specific Condition 103. Testing shall be conducted every five years in accordance with EPA Reference Methods 26, 26A, or other pre-approved method. For SN-1501, this testing shall be conducted during bromine cylinder evacuation operations. For SN-1551, this testing shall be conducted during bromine cylinder filling operations. Both tests shall be conducted while operating the scrubbers at the minimum operating parameters in Specific Condition 105. [Reg.19.705 and 40 C.F.R. § 52 Subpart E]

Source	Pollutant	Test Method
1501	Br <sub>2</sub>	EPA Reference Method 26 or 26A
	HBr	EPA Reference Method 26 or 26A
1551	Br <sub>2</sub>	EPA Reference Method 26 or 26A

107. The permittee may conduct additional emission testing in order to establish alternative parameters for SN-1501 and SN-1551. The Department may approve the alternative

parameters upon receipt of the information from the permittee. The alternative parameters may become the permitted parameters upon receiving written approval from the Department. [Reg.19.303 and Ark. Code Ann. § 8-4-203 as referenced by Ark. Code Ann. §§ 8-4-304 and 8-4-311]

SN-1504 and SN-1552 Compliance Conditions

108. At the North Drum/Cylinder Station, SN-1504, the permittee is limited to the filling of drums or cylinders with VOC or Organic HAP compounds that have a vapor pressure of 7.74 psi or less, measured at 70°F. [Reg.19.705, Ark. Code Ann. § 8-4-203 as referenced by Ark. Code Ann. §§ 8-4-304 and 8-4-311, and 40 C.F.R. § 70.6 and Reg.18.1004 and Ark. Code Ann. § 8-4-203 as referenced by Ark. Code Ann. §§ 8-4-304 and 8-4-311]
109. At the South Drum/Cylinder Station, SN-1552, the permittee is limited to the filling of drums or cylinders with VOC compounds that have a vapor pressure of 7.74 psi or less, measured at 70°F. [Reg.19.705, Ark. Code Ann. § 8-4-203 as referenced by Ark. Code Ann. §§ 8-4-304 and 8-4-311, and 40 C.F.R. § 70.6 and Reg.18.1004 and Ark. Code Ann. § 8-4-203 as referenced by Ark. Code Ann. §§ 8-4-304 and 8-4-311]
110. The permittee is limited to no more than a total annual fill volume of 2,733,100 gallons at SN-1504 and 3,871,900 gallons at SN-1552. Records shall include vapor pressure and fill volume of each compound processed through the source. Compliance shall be determined on a monthly basis by totaling emissions for that month and the previous 11 months. Each 12-month rolling total shall be updated by the 15<sup>th</sup> day of the month following the month to which the records pertain. These records shall be kept on-site and shall be submitted in accordance with General Provision #7. [Reg.19.705, Ark. Code Ann. § 8-4-203 as referenced by Ark. Code Ann. §§ 8-4-304 and 8-4-311, and 40 C.F.R. § 70.6 and Reg.18.1004 and Ark. Code Ann. § 8-4-203 as referenced by Ark. Code Ann. §§ 8-4-304 and 8-4-311]

Great Lakes Chemical Corporation - Central Plant  
Permit #: 1077-AOP-R5  
AFIN: 70-00012

SN-301, SN-302, SN-303, SN-902, SN-906, SN-907, SN-908, SN-909  
Boilers and NaHS Process

Source Description

Boilers

GLCC Central operates three boilers which supply the plant with steam.

Boiler #2 (SN-301) is a 150 MMBtu/hr boiler which is permitted to operate on pipeline quality natural, partially sweet fuel gas from the NaHS Unit, or “sweetened” gas from the JV Amine unit at Lion Oil Company’s facility.

Boiler #3 (SN-302) is a 113 MMBtu/hr boiler which fires pipeline quality natural gas and “sweetened” gas from Lion Oil’s JV Amine Unit.

Boiler #4 (SN-303) is an 88.6 MMBtu/hr boiler which fires only pipeline quality natural gas. This boiler is subject to the requirements of NSPS Subpart Dc.

NaHS Process

The major steps in the production of sodium hydrosulfide (NaHS) are: sour gas and sodium hydroxide (caustic) are reacted and NaHS product is stored in tanks and then shipped off site. The various NaHS storage tanks are insignificant activities under category B-21.

Cooling towers (SN-906, 907, and 908) are used to cool the process water used in the NaHS unit.

Sour Gas Handling and Flaring Operations

Brine is pumped to the surface from the underlying Smackover foundation. The brine may contain dissolved hydrogen sulfide gas (sour gas) and oil, which must be separated from the brine before it is sent to the bromine towers. The brine and sour gas streams are piped to the plant. The crude oil is stored in tanks for future sales. From the GLCC Central processes the combined sour gas streams in one of the following ways:

Scenario #1: Amine Operation. The combined sour gas streams are transported via pipeline to Lion Oil Company, a neighboring petroleum refinery, where the sour gas is processed in Lion Oil's amine unit and returned as "sweet gas" to GLCC Central for use as fuel in Boilers #2 and #3; and/or

Scenario #2: NaHS/Amine Operation. All or a portion of the combined sour gas streams are processed in GLCC Central's Sodium Hydrosulfide Plant (NaHS Plant) where the sour gas is partially sweetened and the partially sweetened gas is routed to Lion Oils amine unit for further refinement and sweet gas is returned to GLCC Central for use as a fuel in Boilers #2 or #3; or

Great Lakes Chemical Corporation - Central Plant  
 Permit #: 1077-AOP-R5  
 AFIN: 70-00012

Scenario #3: NaHS Operation. When the sulfur-containing gas stream (sour gas or partially sweetened NaHS gas) cannot be routed to Lion Oil’s amine unit, the combined sour gas streams are processed in GLCC Central’s NaHS unit where the sour gas is sweetened and the partially sweet fuel gas from the NaHS Unit is routed directly to Boiler #2 for use as fuel.

When the fuel gas (“sweetened”) exceed the boilers short term fuel gas combustion capacity the excess fuel gases must be flared.

In the event of a startup, shutdown, malfunction, or upset condition of Lion Oil’s amine unit, the NaHS unit, or equipment integral to the processing of the combined sour gas streams, GLCC’s sour gas will be combusted in GLCC Central Plant Flare (SN-902). Any sour gas received from GLCC South and West plants may be combusted at the GLCC Central’s sour gas flare.

Emissions occur from various connectors, pumps, and valves associated with piping for this process (SN-999)

Regulatory Applicability

The three boilers (SN-301, 302, and 303) are subject to 40 CFR Part 63 Subpart DDDDD, National Emission Standard for Hazardous Air Pollutants for Major Sources: Industrial, Commercial, and Institutional Boilers and Process Heaters (Boiler MACT). The Notification of Applicability has been submitted by the facility to the appropriate Environmental Protection Agency office. The facility will submit a permit modification application to incorporate Boiler MACT regulatory applicability prior to the January 2016 compliance date. Boiler #4 (SN-303) is subject to NSPS Part 60 Subpart Dc as previously indicated in permit 1077-AOP-R1. Otherwise, the NaHS Production Unit has no additional regulatory applicability beyond that indicated in the Facility Regulatory Applicability Section.

Specific Conditions

111. The permittee shall not exceed the emission rates set forth in the following table. The permittee shall demonstrate compliance with this condition by compliance with Specific Conditions 113, 114, 117, 118, and 120. [Reg.19.501 et seq. and 40 C.F.R. § 52 Subpart E]

SN	Description	Pollutant	lb/hr	tpy
301	Boiler #2 (Natural Gas, Sweet Gas, and Partially Sweet Fuel Gas from the NaHS Unit)	PM <sub>10</sub>	11.2	58.4*
		SO <sub>2</sub>	120.0	525.6*
		VOC	0.9	17.6*
		CO	12.4	91.0*
		NO <sub>x</sub>	41.1	186.7*

SN	Description	Pollutant	lb/hr	tpy
302	Boiler #3	PM <sub>10</sub>	0.9	3.7
		SO <sub>2</sub>	3.5	15.2
		VOC	0.7	2.7
		CO	9.3	40.7
		NO <sub>x</sub>	31.0	135.5
303	Boiler #4	PM <sub>10</sub>	0.7	2.9
		SO <sub>2</sub>	0.1	0.3
		VOC	0.5	2.1
		CO	7.3	31.9
		NO <sub>x</sub>	8.7	38.0
902	Sour Gas Flare (Pilot Only)	PM <sub>10</sub>	0.1	0.1
903	Sour Gas Backup Flare (Pilot Only)	SO <sub>2</sub>	0.1	0.1
		VOC	0.1	0.1
		CO	0.2	0.5
903	Sour Gas Backup Flare (Pilot Only)	NO <sub>x</sub>	0.2	0.6
906	Cooling Tower	PM <sub>10</sub>	1.1	4.8
907	Cooling Tower	PM <sub>10</sub>	0.5	1.9
908	Cooling Tower	PM <sub>10</sub>	0.1	0.4
909	Cooling Tower	PM <sub>10</sub>	0.1	0.3

\*Combined annual emissions from Boiler #2 (SN-301), Sour Gas Flare (SN-902), and Sour Gas Backup Flare (SN-903) when burning (SN-301) and/or flaring (SN-902 and SN-903) partially sweet or sweetened gas.

112. The permittee shall not exceed the emission rates set forth in the following table. The permittee shall demonstrate compliance with this condition by compliance with Specific Conditions 113, 114, 117, 118, and 120. [Reg.18.801 and Ark. Code Ann. § 8-4-203 as referenced by Ark. Code Ann. §§ 8-4-304 and 8-4-311]

SN	Description	Pollutant	lb/hr	tpy
301	Boiler #2 (Natural Gas, Sweet Gas, and Partially Sweet Fuel Gas from the NaHS Unit)	PM	11.2	58.4*
		Arsenic	2.933E-05	1.534E-04*
		Benzene	3.079E-04	1.611E-03*
		Beryllium	1.760E-06	9.207E-06*
		Cadmium	1.613E-04	8.440E-04*
		Chromium	2.053E-04	1.074E-03*
		Cobalt	1.232E-05	6.445E-05*
		Dichlorobenzene	1.760E-04	9.207E-04*
		Formaldehyde	1.100E-02	5.754E-02*
		Hexane	2.639E-01	1.381*
		Manganese	5.572E-05	2.915E-04*

SN	Description	Pollutant	lb/hr	tpy
		Mercury	3.812E-05	1.995E-04*
		Naphthalene	8.944E-05	4.680E-04*
		Nickel	3.079E-04	1.611E-03*
		Selenium	3.519E-06	1.841E-05*
		Toluene	4.985E-04	2.609E-03*
		POM	1.293E-05	6.767E-05*
		H <sub>2</sub> S	1.3	5.7*
302	Boiler #3	PM	0.9	3.7
		Arsenic	0.01	0.01
		Benzene	0.01	0.01
		Beryllium	0.01	0.01
		Cadmium	0.01	0.01
		Chromium	0.01	0.01
		Cobalt	0.01	0.01
		Dichlorobenzene	0.01	0.01
		Formaldehyde	0.01	0.03
		Hexane	0.19	0.87
		Manganese	0.01	0.01
		Mercury	0.01	0.01
		Naphthalene	0.01	0.01
		Nickel	0.01	0.01
		Selenium	0.01	0.01
		Toluene	0.01	0.01
		POM	0.01	0.01
303	Boiler #4	PM	0.7	2.9
		Arsenic	0.01	0.01
		Benzene	0.01	0.01
		Beryllium	0.01	0.01
		Cadmium	0.01	0.01
		Chromium	0.01	0.01
		Cobalt	0.01	0.01
		Dichlorobenzene	0.01	0.01
		Formaldehyde	0.01	0.02
		Hexane	0.15	0.68
		Manganese	0.01	0.01
		Mercury	0.01	0.01
		Naphthalene	0.01	0.01
		Nickel	0.01	0.01
		Selenium	0.01	0.01
		Toluene	0.01	0.01
		POM	0.01	0.01
902	Sour Gas Flare (Pilot Only)	PM	0.1	0.1
		Arsenic	0.01	0.01



SN	Description	Pollutant	lb/hr	tpy
903	Sour Gas Backup Flare (Pilot Only)	Benzene	0.01	0.01
		Beryllium	0.01	0.01
		Cadmium	0.01	0.01
		Chromium	0.01	0.01
		Cobalt	0.01	0.01
		Dichlorobenzene	0.01	0.01
		Formaldehyde	0.01	0.01
		Hexane	0.01	0.01
		Manganese	0.01	0.01
		Mercury	0.01	0.01
		Naphthalene	0.01	0.01
		Nickel	0.01	0.01
		Selenium	0.01	0.01
		Toluene	0.01	0.01
		POM	0.01	0.01
906	Cooling Tower	PM	1.1	4.8
907	Cooling Tower	PM	0.5	1.9
908	Cooling Tower	PM	0.1	0.4
909	Cooling Tower	PM	0.1	0.3

\*Combined annual emissions from Boiler #2 (SN-301), Sour Gas Flare (SN-902), and Sour Gas Backup Flare (SN-903) when burning (SN-301) and/or flaring (SN-902 and SN-903 partially sweet or sweetened gas.

113. Visible emissions may not exceed the limits specified in the following table of this permit as measured by EPA Reference Method 9. Compliance with this condition will be shown by compliance with Specific Condition 114 and Plantwide Condition 5.

SN	Limit	Regulation Citation
301, 302, 303, 902 (Pilot only) & 903 (Pilot only)	5%	Reg.18.501 and A.C.A. §8-4-203 as referenced by §8-4-304 and §8-4-311

114. The permittee shall only combust the fuels in the Boiler #2, #3, and #4 (SN-301, 302, and 303) as specified in the table below. [Reg.19.705 and Ark. Code Ann. § 8-4-203 as referenced by Ark. Code Ann. §§ 8-4-304 and 8-4-311]

Boiler	Fuels
Boiler #2 SN-301	Pipeline quality natural gas, partially sweet fuel gas from the NaHS Unit, or “sweetened” gas from the JV Amine unit at Lion Oil Company’s facility
Boiler #3 SN-302	Pipeline quality natural gas or “sweetened” gas from the JV

Boiler	Fuels
	Amine unit at Lion Oil Company's facility
Boiler #4 SN-303	Pipeline quality natural gas

115. The permittee shall not operate the Sour Gas Flare (SN-902) and the Sour Gas Backup Flare (SN-903) simultaneously. [Reg.19.705, Ark. Code Ann. § 8-4-203 as referenced by Ark. Code Ann. §§ 8-4-304 and 8-4-311, and 40 C.F.R. § 70.6]
116. The permittee must maintain records anytime any sour gas backup flare (SN-903) is installed at the facility. These records must be kept up-to-date and readily accessible. The permittee shall make the records available to Department personnel upon request. The records shall include for any backup flare installed:
- a. The date of installation and operation,
  - b. Date any backup flare is removed from service,
  - c. Pilot heat input capacity, verifying it does not exceed 1.25 MMBtu/hr,
  - d. Stack height,
  - e. Stack diameter,
  - f. And stack gas flow rate.

[Reg.19.705 and 40 C.F.R. § 52 Subpart E]

117. The partially sweet fuel gas from the NaHS Unit burned in Boiler #2 (SN-301) shall contain no more than 63.75 pounds per hour of H<sub>2</sub>S. The permittee shall measure the H<sub>2</sub>S concentration of the gas leaving the NaHS unit a minimum of once every two hours when the plant is in operation. These measurements need only be conducted while the NaHS waste gas is being combusted in Boiler #2. These measurements shall be conducted using ASTM E-260, or the method contained in 40 CFR §60.648, or an equivalent method, provided it is approved by the Department prior to its use. The measured H<sub>2</sub>S shall be converted to SO<sub>2</sub> out the stack through the use of a mass balance. The results of these measurements shall be kept on-site and made available to Department personnel upon request. A report of these measurements shall be submitted to the Department in accordance with General Provision #7. [Reg.19.705, Ark. Code Ann. § 8-4-203 as referenced by Ark. Code Ann. §§ 8-4-304 and 8-4-311, and 40 C.F.R. § 70.6]
118. The water flow rates in the following table shall not be exceeded. The permittee shall maintain, on site, documentation that the physical flow capacities of SN-906, SN-907, and SN-908 meet the values in the table. [Reg.19.705, Ark. Code Ann. § 8-4-203 as referenced by Ark. Code Ann. §§ 8-4-304 and 8-4-311, and 40 C.F.R. § 70.6]

SN	Description	Maximum Water Flow Rate Through Tower (gallons per minute)
906	Cooling Tower	3,600
907	Cooling Tower	350
908	Cooling Tower	1,400
909	Cooling Tower	850

119. The total dissolved solids concentration or correlated conductivity in the following table shall not be exceeded. The permittee will demonstrate compliance with this condition by compliance with Specific Condition 120. [Reg.19.705, Ark. Code Ann. § 8-4-203 as referenced by Ark. Code Ann. §§ 8-4-304 and 8-4-311, and 40 C.F.R. § 70.6]

Source	Description	Maximum Total Dissolved Solids concentration
906	Cooling Tower	12,000 ppm TDS/13,961 µS
907	Cooling Tower	12,000 ppm TDS/13,961 µS
908	Cooling Tower	12,000 ppm TDS/13,961 µS
909	Cooling Tower	12,000 ppm TDS/13,961 µS

120. The permittee shall monitor and maintain records, measured monthly, of the Total Dissolved Solids (TDS) or correlated conductivity. These records shall be kept on-site and made available to Department personal upon request. [Reg.19.705 and 40 C.F.R. § 52 Subpart E]
121. The Boiler #4 (SN-303) is subject to and shall comply with the applicable provisions of 40 CFR Part 60 Subpart Dc – New Source Performance Standards for Small Industrial-Commercial-Institutional Steam Generating Units. The requirements of Subpart Dc, as applicable to the boiler, are outlined below. [Reg.19.304 and 40 C.F.R. § 60.48(c)]
122. The permittee shall maintain records of the amount of natural gas combusted in the Boiler #4 (SN-303) during each calendar month. [Reg.19.304 and 40 C.F.R. § 60.48c(g)(2)]
123. All records required under Subpart Dc shall be maintained by the permittee for a period of two years following the date of such record. [Reg.19.304 and 40 C.F.R. § 60.48c(i)]

Great Lakes Chemical Corporation - Central Plant  
Permit #: 1077-AOP-R5  
AFIN: 70-00012

SN-102, SN-199  
Bromine Recovery Unit

Source Description

GLCC Central operates the Bromine Recovery Unit (BRU) to recover bromine from brominated organic process streams. The sources of these streams are other GLCC Central process units.

During the operation of the BRU, gaseous and liquid process streams containing brominated organics are mixed with air and combusted in a natural gas-fired thermal oxidizer. The hot exhaust gas from the oxidizer is directed to a waste heat recovery unit and economizer. The steam produced is routed to a plant steam header for use throughout GLCC Central. The HBr contained in the cooled exhaust gases is absorbed in water in the HBr absorber. The HBr solution is sent to Feed Brine / Scrubber Brine Treatment Process for recovery. The gases from the HBr absorber are routed through a packed tower scrubber and then through a venturi scrubber to minimize emissions of HBr, HCl, Cl<sub>2</sub>, Br<sub>2</sub>, and MeCl. Treated gas from the thermal oxidizer is discharged to the atmosphere (SN-102).

Previously permitted UK-60 Feed Tanks (SN-101 and SN-103) have been removed from service and are requested to be removed from the permit. The liquid process streams previously stored in those tanks will be routed directly to the BRU thermal oxidizer from the production section, if required. The HBr Tank (TT-07-655) stores HBr solution generated in the HBr absorber (IA A.3).

The facility is currently authorized to combust natural gas, propane, and the following recycle streams in the thermal oxidizer of the BRU: TBBPA Bottoms (UK-60 material), TBBPA Vacuum Pump Vents, Methyl Bromide Area Vents, Methyl and Ethyl Bromide Transfer Area Vents, Soil Vapor Extraction Unit Vents and reactor vents from the production of CN-3370.

Source SN-199 accounts for BRU fugitive equipment leaks

Regulatory Applicability

In addition to the regulatory applicability indicated in the Facility Regulatory Applicability Section, the Thermal Oxidizer (SN-102) controls vapor streams from the TBBPA (TBBPA and Methyl Bromide (MeBr) process vents) and OCP (CN-3370 process vent).

TBBPA PIA MACT Process Vents

The TBBPA MeBr process vent stream is routed to BRU, specifically SN-102, and is subject to and shall comply with all applicable provisions of 40 CFR Part 63 Subpart MMM – *National Emission Standards for Hazardous Air Pollutants for Pesticide Active Ingredients Production* (PAI MACT).

TBBPA MON MACT Process Vents

The TBBPA unit's TBBPA and MeBr process vent streams are routed to BRU, specifically SN-102, and are subject to the provisions of 40 CFR Part 63 Subpart FFFF – *National Emission Standards for Hazardous Air Pollutants: Miscellaneous Organic Chemical Manufacturing* (MON MACT). The MON MACT allows equipment subject to the PAI MACT to comply with the PAI MACT in lieu of the MON MACT.

OCP MON MACT Process Vents

The OCP CN-3370 process vent stream is routed to BRU, specifically SN-102, and is subject to the provisions of 40 CFR Part 63 Subpart FFFF – *National Emission Standards for Hazardous Air Pollutants: Miscellaneous Organic Chemical Manufacturing* (MON MACT).

Specific Conditions

124. The permittee shall not exceed the emission rates set forth in the following table. The permittee shall demonstrate compliance with this condition by Specific Conditions 126 through 129. [Reg.19.501 et seq. and 40 C.F.R. § 52 Subpart E]

SN	Description	Pollutant	lb/hr	tpy
102	Thermal Oxidizer	PM <sub>10</sub>	1.0	4.4
		SO <sub>2</sub>	0.1	0.5
		VOC	10.0	43.4
		CO	33.5	146.8
		NO <sub>x</sub>	0.5	2.2
199	BRU Fugitive Equipment Leaks	VOC	4.4	19.1

125. The permittee shall not exceed the emission rates set forth in the following table. The permittee shall demonstrate compliance with this condition by Specific Conditions 126 through 129. [Reg.18.801 and Ark. Code Ann. § 8-4-203 as referenced by Ark. Code Ann. §§ 8-4-304 and 8-4-311]

SN	Description	Pollutant	lb/hr	tpy
102	Thermal Oxidizer	PM	1.0	4.4
		HBr + Br <sub>2</sub>	2.5	11.00
		HCl	0.46	2.02
		Methylene Chloride	1.62	7.10
199	BRU Fugitive Equipment Leaks	Methanol	4.353	19.07
		Methyl Bromide	0.02507	0.1098

126. Visible emissions may not exceed the limits specified in the following table of this permit as measured by EPA Reference Method 9. Compliance with this condition will be shown by compliance with Specific condition 127.

SN	Description	Limit	Regulatory Citation
102	Thermal Oxidizer	20%	§19.503 and 40 CFR Part 52, Subpart E

127. The permittee shall only combust natural gas, propane and the following recycle streams in the thermal oxidizer of the BRU: TBBPA Bottoms (UK-60 material), TBBPA Vacuum Pump Vents, Methyl Bromide Area Vents, Methyl and Ethyl Bromide Transfer Area Vents, Soil Vapor Extraction Unit Vents and reactor vents from the production of CN-3370. The permittee shall maintain a list of all process streams recycled by the BRU. These records shall be kept on site and made available to Department personnel upon request. [Reg.19.705, Ark. Code Ann. § 8-4-203 as referenced by Ark. Code Ann. §§ 8-4-304 and 8-4-311, and 40 C.F.R. § 70.6]

Fuels	Natural Gas Propane
Recycle Streams	TBBPA Bottoms (UK-60 material) TBBPA Vacuum Pump Vents Methyl Bromide Area Vents Methyl and Ethyl Bromide Transfer Area Vents, Soil Vapor Extraction Unit Vents Reactor vents from the production of CN-3370

128. The permittee shall test the emissions from SN-102 as specified in the following table in accordance with the test procedure listed. The test shall consist of at least 3 sampling periods at a minimum of 1 hour each. The facility shall document the Methyl Bromide and TBBPA production rates at the TBBPA Unit and the OCP Production Unit. The facility shall document and make production data available to the ADEQ inspector during the test. The permittee shall be limited to the operating at no more than 10% above the tested production rate until the next performance test is conducted pursuant to this specific condition. This testing is to be completed every 5 year permit period. This test data shall be used for determination of compliance with the conditions set forth in this permit. [Reg.19.702 and 40 C.F.R. § 52 Subpart E]

Source	Pollutant	Test Method
102	PM <sub>10</sub> VOC NO <sub>x</sub> HBr Br <sub>2</sub>	EPA Reference Method 201 or 201A EPA Reference Method 25A EPA Reference Method 7E EPA Reference Method 26 or 26A EPA Reference Method 26 or 26A

129. The BRU, SN-102, shall achieve an organic HAP emissions control efficiency of 98 percent by weight or greater. HCl and C<sub>12</sub> emissions, including HCl generated from combustion of halogenated process vent emissions, from the BRU thermal oxidizer shall be reduced by 94 percent or greater or to an outlet concentration less than or equal to 20 ppmv. [Reg.19.304 and 40 C.F.R. § 63.1362]
130. The permittee shall maintain a minimum temperature in the BRU thermal oxidizer of 2,350 °F when in vapor/liquid feed scenario or 2,029 ° F when in vapor only feed scenario. The permittee shall monitor the temperature of the gases exiting the combustion chamber of the BRU thermal oxidizer as the site-specific operating parameter which must be measured and recorded at least once every 15 minutes during the period in which the combustion device is controlling HAP from an emission stream subject to the standards in §63.1362 and Specific Condition 129. The temperature monitoring device must be accurate to within ±0.75 percent of the temperature measured in degrees Celsius or ±2.5 °C, whichever is greater. Compliance with the operating parameters is based on 24-hour block averages. The monitoring device must be calibrated annually. [Reg.19.304 and 40 C.F.R. § 63.1366(b)(1)(vii)]
131. The permittee shall maintain a minimum scrubbing liquid flow rate of 22.1 gal/min in the BRU Scrubber. The scrubbing liquid flow rate must be measured and recorded at least once every 15 minutes during the period in which the scrubber is controlling HAP from an emission stream as required by the standards in §63.1362 and Specific Condition 129. The permittee shall also maintain an effluent scrubber liquid minimum pH of 8.02. The effluent scrubber liquid pH shall also be monitored once a day. The minimum scrubber liquid flow rate or pressure drop shall be based on the conditions under which the initial compliance demonstration was conducted. The monitoring device used for measurement of scrubber liquid flowrate shall be certified by the manufacturer to be accurate to within ±10 percent of the design scrubber liquid flowrate. Compliance with the operating parameters is based on 24-hour block averages. The monitoring device shall be calibrated annually. [Reg.19.304 and 40 C.F.R. § 63.1366(b)(1)(ii)]
132. The permittee shall maintain a minimum scrubber liquid flow rate in the BRU Absorber of 21.3 gal/min. The scrubbing liquid flow rate must be measured and recorded at least once every 15 minutes during the period in which the scrubber is controlling HAP from an emission stream as required by the standards in §63.1362 and Specific Condition 129. The minimum scrubber liquid flow rate shall be based on the conditions under which the initial compliance demonstration was conducted. The monitoring device used for measurement of scrubber liquid flowrate shall be certified by the manufacturer to be accurate to within ±10 percent of the design scrubber liquid flowrate. The monitoring device shall be calibrated annually. [Reg.19.304 and 40 C.F.R. § 63.1366(b)(1)(ii)]

Great Lakes Chemical Corporation - Central Plant  
Permit #: 1077-AOP-R5  
AFIN: 70-00012

SN-201, SN-202, SN-299  
Process Water Treatment Plant

Source Description

GLCC Central operates the Process Water Treatment Plant (PWTP) to treat process water prior to deep well injection. The major steps in water treatment at the PWTP are described below.

- Process water from other GLCC Central process unit areas is collected in storage tanks
- The process water undergoes pH neutralization
- The process water is treated with corrosion inhibitors in the Treatment Basin
- The process water is stored in the Equalization Basin
- A flocculent is added and the process water is routed to clarifiers
- The clarified water is filtered and sent for deep well injection
- Solids from the clarification process are further dried and then pressed
- Sludge is transported off-site

Air Pollutant Emissions

Most storage vessels in the PWTP are open to the atmosphere. Some VOCs may be emitted since the process water contains organics in solution. An HCl storage tank is present at the PWTP. HCl emissions from the tank are minimized by utilizing a water scrubber (SN-201).

Group 1 wastewater streams from the TBBPA Unit subject to the PAI MACT rule and Group 1 wastewater streams from the OCP Unit subject to the MON MACT rule are not routed to the PWTP, but are segregated into a separate wastewater treatment system meeting PAI MACT and MON MACT requirements.

SN-202 accounts for emissions from PWTP area. Emissions also occur at various connectors, pumps, and valves associated with piping for this unit (SN-299).



Specific Conditions

133. The permittee shall not exceed the emission rates set forth in the following table. The permittee shall demonstrate compliance with this condition by complying with Specific Condition 138. [Reg.19.501 et seq. and 40 C.F.R. § 52 Subpart E]

SN	Description	Pollutant	lb/hr	tpy
202	PWTP Area	VOC	7.3	31.7

134. The permittee shall not exceed the emission rates set forth in the following table. The permittee shall demonstrate compliance with this condition by complying with Specific Condition 138. [Reg.18.801 and Ark. Code Ann. § 8-4-203 as referenced by Ark. Code Ann. §§ 8-4-304 and 8-4-311]

SN	Description	Pollutant	lb/hr	tpy
201	HCl Storage Tank Scrubber	HCl	1.68	2.04
202	PWTP Area	Organic HAP	7.23	31.64
299	Equipment	HCl	0.29	1.27

135. The permittee shall operate the scrubber within the limits stated in the table below. When in operation, the flow rate and specific gravity shall be measured and recorded daily. If the specific gravity or flow rate falls below limits listed in the table below, corrective action shall be taken within twelve (12) hours. [Reg.18.1004 and Ark. Code Ann. § 8-4-203 as referenced by Ark. Code Ann. §§ 8-4-304 and 8-4-311]

Source	Minimum Flow Rate (gal/min)	Minimum Monitored Value
201	9.0	1.1 specific gravity

136. The permittee will maintain monthly records to demonstrate compliance with Specific Condition 135. The permittee will update the records by the fifteenth day of the month following the month. The permittee will keep the records onsite, and make the records available to Department personnel upon request. [Reg.18.1004 and Ark. Code Ann. § 8-4-203 as referenced by Ark. Code Ann. §§ 8-4-304 and 8-4-311]
137. The permittee shall monitor the concentration of organic compounds in the wastewater at SN-202. The concentration of organic compounds in the wastewater shall not exceed 4,000 ppm on a rolling 12-month average basis. The permittee shall conduct sampling and test the organic content of the wastewater once per month. [Reg.19.705, Ark. Code

Great Lakes Chemical Corporation - Central Plant

Permit #: 1077-AOP-R5

AFIN: 70-00012

Ann. § 8-4-203 as referenced by Ark. Code Ann. §§ 8-4-304 and 8-4-311, and 40 C.F.R. § 70.6]

138. The permittee will maintain monthly records to demonstrate compliance with Specific Condition 137. The permittee will update the records by the fifteenth day of the month following the month. The permittee will keep the records onsite, and make the records available to Department personnel upon request. [Reg.19.705 and 40 C.F.R. § 52 Subpart E]

SN-901, SN-999  
 Brine Pretreatment and NaHS Production

Source Description

For the Brine Pretreatment and NaHS Production Area (Brine/NaHS) at GLCC Central, brine is pumped to the surface from the underlying Smackover foundation at GLCC's brine supply wells. The brine may contain dissolved hydrogen sulfide gas (sour gas) and oil, which must be separated from the brine before it is sent to the bromine towers. The brine and sour gas streams are piped to Brine/NaHS Plant. The crude oil is stored in tanks for future sales.

At the Brine/NaHS Plant, the incoming brine is acidified with hydrochloric or hydrobromic acid. Emissions from the acid storage tank are controlled with a scrubber (SN-901). The brine then enters a vacuum stripper, which removes additional sour gas. The stripped brine is then sent to the bromine towers, where bromine is extracted. Emissions occur at various connectors, pumps, and valves associated with piping for this process (SN-999).

The North Oil Separator Station Tanks previously permitted as part of the Brine Well Section are within the GLCC Central property boundary and thus will remain within the permit. The South Oil Separator Station Tank (SN-2051) has been removed from service and should be removed from the permit. The North Oil Separator Station Tank #1 and #2 (previously SN-2041 and SN-2042) are still on site, but are requested to be represented as Insignificant Activities thus should be removed from the permit as permitted sources. These units as Insignificant Activities are included within the Brine Pretreatment and NaHS Production Unit Section.

Specific Conditions

139. The permittee shall not exceed the emission rates set forth in the following table. The permittee shall demonstrate compliance with this condition by compliance with Specific Condition 140. [Reg.18.801 and Ark. Code Ann. § 8-4-203 as referenced by Ark. Code Ann. §§ 8-4-304 and 8-4-311]

SN	Description	Pollutant	lb/hr	tpy
901	Acid Storage Tanks Scrubber (VS-05-603)	HBr	0.04	0.03
		HCl	1.13	1.37
999	Fugitive Equipment Leaks	HCl	0.16	0.69

140. The permittee shall maintain the control equipment parameters shown in the following table. The permittee shall monitor these parameters every twelve hours of operation of the source and keep written records of the readings. These records shall be kept on site and made available to Department personnel upon request. If the scrubber media flow rate falls below the minimum listed value, corrective action shall be taken immediately and the situation corrected within twelve hours. The permittee shall maintain records of sampling and corrective actions taken. These parameters were established at the time of

Great Lakes Chemical Corporation - Central Plant

Permit #: 1077-AOP-R5

AFIN: 70-00012

permit application. [Reg.19.303 and Ark. Code Ann. § 8-4-203 as referenced by Ark. Code Ann. §§ 8-4-304 and 8-4-311]

SN	Description	Control Equipment	Minimum Operating Limits
901	Acid Storage Tanks Scrubber (VS-05-603)	Scrubber	6.0 gal/min of brine or fresh water

SN-406, SN-409, SN-410  
 Chlorine Dock Area and ISO Railcar Scrubber

Source Description

GLCC Central receives chemicals including, but not limited to chlorine, hydrogen chloride, and sodium bromide at the Chlorine Dock Area via railcar or truck. Shipments received are transferred to truck for transport to the GLCC South or West Plants. Scrubbers are used on the chlorine and HCl transfer operations in order to control emissions (SN-409 and 410).

Residual bromine is removed from returned ISO containers at 11 ISO stations. Bromine vapors are routed through two parallel caustic scrubbers (SN-406) to control emissions.

Specific Conditions

141. The permittee shall not exceed the emission rates set forth in the following table. The permittee shall demonstrate compliance with this condition by compliance with Specific Conditions 143, 144, and 145. [Reg.18.801 and Ark. Code Ann. § 8-4-203 as referenced by Ark. Code Ann. §§ 8-4-304 and 8-4-311]

SN	Description	Pollutant	lb/hr	tpy
406	ISO/Railcar Scrubber	Br <sub>2</sub>	0.10	0.50
		Cl <sub>2</sub>	0.01	0.05
409	Chlorine Transfer Scrubber (TT-01-702)	Cl <sub>2</sub>	0.10	0.44
410	HCl Transfer Scrubber (CL-01-717)	HCl	1.70	2.03

142. Visible emissions may not exceed the limits specified in the following table of this permit as measured by EPA Reference Method 9. Compliance with this limit shall be verified by compliance with Specific Condition 143.

SN	Description	Limit	Regulatory Citation
406	ISO/Railcar Scrubber	10%	Reg.18.501
409	Chlorine Transfer Scrubber (TT-01-702)	5%	Reg.18.501
410	HCl Transfer Scrubber (CL-01-717)	5%	Reg.18.501

143. The permittee shall operate the scrubbers within the limits stated in the table below. Flow rates, specific gravity, or caustic solution percent shall be measured and recorded daily. The flow rate and minimum monitored value of the liquid circulated will be monitored and recorded daily. If the caustic concentration and caustic solution flow rate for SN-406 or 409, or minimum monitored value for SN-410 falls below limits listed in

the table below, corrective action shall be taken within twelve (12) hours. [Regulation 18, §18.1004 and Ark. Code Ann. § 8-4-203 as referenced by Ark. Code Ann. §§ 8-4-304 and §8-4-311]

SN	Minimum Flow Rate (gal/min)	Minimum Monitored Value
406	10.0	2.5% caustic
	Establish in test.	Establish in test.
409	8.0	2.5% caustic
410	Establish in test.	1.0 specific gravity

144. The permittee shall maintain daily records which demonstrate compliance with Specific Condition 143. The permittee will update the records daily, keep the records onsite, and make the records available to Department personnel upon request. [Regulation 18, §18.1004 and Ark. Code Ann. § 8-4-203 as referenced by Ark. Code Ann. §§ 8-4-304 and §8-4-311]
145. The permittee shall test the emissions from SN-406 and SN-410 as specified in the following table in accordance with the test procedure listed. The test shall consist of at least 3 sampling periods at a minimum of 1 hour each. During this test the permittee shall verify the operating parameters in SN-406 and SN-410 and establish a minimum flow rate and caustic concentration for the scrubbers SN-406 and SN-410. The facility shall document the production rates during the performance test and make production data available to the ADEQ inspector during the test. The permittee shall be limited to the operating at no more than 10% above the tested production rate until the next performance test is conducted pursuant to this specific condition. This testing is to be completed every 5 year permit period. This test data shall be used for determination of compliance with the conditions set forth in this permit. [§19.702 of Regulation 19 and 40 CFR Part 52, Subpart E]

Source	Pollutant	Test Method
SN-406	Br <sub>2</sub>	EPA Reference Method 26 or 26A
SN-410	HCl	EPA Reference Method 26 or 26A

SN-1903, SN-1904, SN-1905, SN-1906, SN-1907, SN-1908, SN-1909  
 Emergency Generators and Engines

Source Description

GLCC Central has several stationary internal combustion engines at the facility. These engines provide emergency power or water for firefighting in the event of outages or emergencies. TBBPA Emergency Generator (SN-1903) and P&S Emergency Generator (SN-1904) provide backup power to the facility. The #1, #2, and #3 Generator Engines (SN-1907, 1908, and 1909) are each 598 hp and provide backup power for the sour gas compressors at the GLCC Central facility. The North Emergency Firewater Pump Engine (SN-1905) and South Emergency Firewater Pump Engine (SN-1906) are each 300 hp and provide emergency power for firefighting measures.

Regulatory Applicability

In addition to the regulatory applicability indicated in the Facility Regulatory Applicability Section, there is some additional applicability indicated below. The emergency generators and engines are subject to applicable requirements of 40 CFR Part 60 Subpart IIII *Standards of Performance for Stationary Compression Ignition Internal Combustion Engines* and 40 CFR Part 63 Subpart ZZZZ *National Emissions Standards for Hazardous Air Pollutants for Stationary Reciprocating Internal Combustion Engines*.

Specific Conditions

146. The permittee shall not exceed the emission rates set forth in the following table. The permittee shall demonstrate compliance with this condition by compliance with Specific Conditions 148, 149, and 151. [Reg.19.501 et seq. and 40 C.F.R. § 52 Subpart E]

SN	Description	Pollutant	lb/hr	tpy
1903	TBBPA Emergency Generator	PM <sub>10</sub>	0.5	0.2
		SO <sub>2</sub>	0.5	0.2
		VOC	0.6	0.2
		CO	1.5	0.4
		NO <sub>x</sub>	6.8	1.7
1904	P & S Emergency Generator	PM <sub>10</sub>	0.4	0.1
		SO <sub>2</sub>	0.4	0.1
		VOC	0.4	0.1
		CO	1.1	0.3
		NO <sub>x</sub>	4.9	1.3
1905	North Emergency Firewater Pump engine	PM <sub>10</sub>	0.7	0.2
		SO <sub>2</sub>	0.7	0.2
		VOC	0.8	0.2
		CO	2.0	0.5

SN	Description	Pollutant	lb/hr	tpy
		NO <sub>x</sub>	9.3	2.4
1906	South Emergency Firewater Pump Engine	PM <sub>10</sub>	0.7	0.2
		SO <sub>2</sub>	0.7	0.2
		VOC	0.8	0.2
		CO	2.0	0.5
		NO <sub>x</sub>	9.3	2.4
1907	#1 Generator Engine	PM <sub>10</sub>	1.4	0.4
		SO <sub>2</sub>	1.3	0.4
		VOC	1.5	0.4
		CO	4.0	1.0
		NO <sub>x</sub>	18.6	4.7
1908	#2 Generator Engine	PM <sub>10</sub>	1.4	0.4
		SO <sub>2</sub>	1.3	0.4
		VOC	1.5	0.4
		CO	4.0	1.0
		NO <sub>x</sub>	18.6	4.7
1909	#3 Generator Engine	PM <sub>10</sub>	1.4	0.4
		SO <sub>2</sub>	1.3	0.4
		VOC	1.5	0.4
		CO	4.0	1.0
		NO <sub>x</sub>	18.6	4.7

147. The permittee shall not exceed the emission rates set forth in the following table. The permittee shall demonstrate compliance with this condition by compliance with Specific Conditions 148, 149, and 151. [Reg.18.801 and Ark. Code Ann. § 8-4-203 as referenced by Ark. Code Ann. §§ 8-4-304 and 8-4-311]

SN	Description	Pollutant	lb/hr	tpy
1903	TBBPA Emergency Generator	PM	0.5	0.2
		Benzene	0.01	0.01
		Formaldehyde	0.01	0.01
		Naphthalene	0.01	0.01
		Toluene	0.01	0.01
		Acetaldehyde	0.01	0.01
		Acrolein	0.01	0.01
		1,3-Butadiene	0.01	0.01
		Xylenes	0.01	0.01
		POM	0.01	0.01
		1904	P & S Emergency Generator	PM
Benzene	0.01			0.01
Formaldehyde	0.01			0.01
Naphthalene	0.01			0.01



SN	Description	Pollutant	lb/hr	tpy
		Acetaldehyde	0.01	0.01
		Acrolein	0.01	0.01
		1,3-Butadiene	0.01	0.01
		Xylenes	0.01	0.01
		POM	0.01	0.01
1905	North Emergency Firewater Pump engine	PM	0.7	0.2
		Benzene	0.01	0.01
		Formaldehyde	0.01	0.01
		Naphthalene	0.01	0.01
		Toluene	0.01	0.01
		Acetaldehyde	0.01	0.01
		Acrolein	0.01	0.01
		1,3-Butadiene	0.01	0.01
		Xylenes	0.01	0.01
		POM	0.01	0.01
1906	South Emergency Firewater Pump Engine	PM	0.7	0.2
		Benzene	0.01	0.01
		Formaldehyde	0.01	0.01
		Naphthalene	0.01	0.01
		Toluene	0.01	0.01
		Acetaldehyde	0.01	0.01
		Acrolein	0.01	0.01
		1,3-Butadiene	0.01	0.01
		Xylenes	0.01	0.01
		POM	0.01	0.01
1907	#1 Generator Engine	PM	1.4	0.4
		Benzene	0.01	0.01
		Formaldehyde	0.01	0.01
		Naphthalene	0.01	0.01
		Toluene	0.01	0.01
		Acetaldehyde	0.01	0.01
		Acrolein	0.01	0.01
		1,3-Butadiene	0.01	0.01
		Xylenes	0.01	0.01
		POM	0.01	0.01
1908	#2 Generator Engine	PM	1.4	0.4
		Benzene	0.01	0.01
		Formaldehyde	0.01	0.01
		Naphthalene	0.01	0.01
		Toluene	0.01	0.01
		Acetaldehyde	0.01	0.01
		Acrolein	0.01	0.01
		1,3-Butadiene	0.01	0.01

SN	Description	Pollutant	lb/hr	tpy
		Xylenes	0.01	0.01
		POM	0.01	0.01
1909	#3 Generator Engine	PM	1.4	0.4
		Benzene	0.01	0.01
		Formaldehyde	0.01	0.01
		Naphthalene	0.01	0.01
		Toluene	0.01	0.01
		Acetaldehyde	0.01	0.01
		Acrolein	0.01	0.01
		1,3-Butadiene	0.01	0.01
		Xylenes	0.01	0.01
		POM	0.01	0.01

148. Visible emissions may not exceed the limits specified in the following table of this permit as measured by EPA Reference Method 9.

SN	Limit	Regulatory Citation
1903, 1904, 1905, 1906, 1907, 1908, 1909	20%	§19.501

149. Annual observations of the opacity from SN-1903, SN-1904, SN-1905, SN-1906, SN-1907, SN-1908, and SN-1909 shall be conducted by a person trained but not necessarily certified in EPA Reference Method 9. If visible emissions in excess of the permitted levels are detected, the permittee shall immediately take action to identify the cause of the visible emissions in excess of the permit limit, implement corrective action, and perform an EPA Reference Method 9 test to verify emissions are not in excess of the permitted level. The permittee shall maintain records which contain the following items in order to demonstrate compliance with this specific condition. These records shall be updated monthly kept on site, and made available to Department personnel upon request.
- The date and time of the observation.
  - If visible emissions which appeared to be above the permitted limit were detected.
  - If visible emissions which appeared to be above the permitted limit were detected, the cause of the exceedance of the opacity limit, the corrective action taken, and if the visible emissions appeared to be below the permitted limit after the corrective action was taken.
  - The name of the person conducting the opacity observations.

[Reg.19.705 and 40 C.F.R. § 52 Subpart E]

150. Diesel shall be the only fuel combusted at SN-1903, 1904, 1905, 1906, 1907, 1908, or 1909. The diesel combusted in these sources shall not exceed sulfur content of 0.5% by weight. The facility shall maintain records which demonstrate compliance with the sulfur content limit of this condition. These records shall be maintained on-site and shall be

made available to Department personnel upon request. [Reg.19.705 and 40 C.F.R. § 52 Subpart E]

151. The permittee shall not operate SN-1903, 1904, 1905, 1906, 1907, 1908, or 1909 in excess of 500 total hours (emergency and non-emergency) per calendar year in order to demonstrate compliance with the annual emission rate limits. Emergency operation in excess of these hours may be allowable but shall be reported and will be evaluated in accordance with Regulation 19 §19.602 and other applicable regulations. [§19.705 of Regulation 19, A.C.A. §8-4-203 as referenced by A.C.A. §8-4-304 and §8-4-311, and 40 CFR 70.6]
152. The permittee shall maintain monthly records to demonstrate compliance with Specific Condition 151. The permittee shall update these records by the fifteenth day of the month following the month to which the records pertain. The calendar year totals and each individual month's data shall be maintained on-site, made available to Department personnel upon request and submitted in accordance with General Provision 7. [Reg.19.705 and 40 C.F.R. § 52 Subpart E]

SN1903 and SN-1909, Part 60, IIII Conditions

153. The permittee shall not exceed the limits for SN-1909 in the following table:

Emission Standards in g/KW-hr (g/HP-hr)				
1909	HC	NO <sub>x</sub>	CO	PM
	1.3 (1.0)	9.2 (6.9)	11.4 (8.5)	0.54 (0.40)
1903	4.0 (3.0)		3.5 (2.6)	0.2 (0.15)

[§19.304 of Regulation 19 and 40 CFR §60.4205(a)]

154. The permittee must use diesel fuel that meets the requirements of 40 CFR 80.510(a). [§19.304 of Regulation 19 and 40 CFR §60.4207(a)]
155. The permittee must use diesel fuel that meets the requirements of 40 CFR 80.510(b) for nonroad diesel fuel, except that any existing diesel fuel purchased (or otherwise obtained) prior to October 1, 2010, may be used until depleted. [§19.304 of Regulation 19 and 40 CFR §60.4207(b)]
156. The permittee must operate and maintain SN-1903 and SN-1909 to that achieve the emission standards as required in Specific Condition 153 over the entire life of the engine. [§19.304 of Regulation 19 and 40 CFR §60.4206]
157. SN-1903 and SN-1909 must comply with the emission standards specified in this subpart, The permittee must do all of the following, except as permitted under paragraph (g) of this section:

- a. Operate and maintain SN-1909 internal combustion engine and control device according to the manufacturer's emission-related written instructions;
- b. Change only those emission-related settings that are permitted by the manufacturer; and
- c. Meet the emission standards as specified in Specific Condition 153.

[§19.304 of Regulation 19 and 40 CFR §60.4211(a)]

158. The permittee must demonstrate compliance according to one of the methods specified in paragraphs (a) through (e) of this section.
- a. Purchasing an engine certified according to, emission standards as specified in Specific Condition 153 for the same model year and maximum engine power. The engine must be installed and configured according to the manufacturer's specifications.
  - b. Keeping records of performance test results for each pollutant for a test conducted on a similar engine. The test must have been conducted using the same methods specified in this subpart and these methods must have been followed correctly.
  - c. Keeping records of engine manufacturer data indicating compliance with the standards.
  - d. Keeping records of control device vendor data indicating compliance with the standards.
  - e. Conducting an initial performance test to demonstrate compliance with the emission standards according to the requirements specified in §60.4212, as applicable.

[§19.304 of Regulation 19 and 40 CFR §60.4211(b)]

159. If the permittee does not install, configure, operate, and maintain SN-1909 according to the manufacturer's emission-related written instructions, or change emission-related settings in a way that is not permitted by the manufacturer the permittee must keep a maintenance plan and records of conducted maintenance and must, to the extent practicable, maintain and operate the engine in a manner consistent with good air pollution control practice for minimizing emissions. In addition, you must conduct an initial performance test to demonstrate compliance with the applicable emission standards within 1 year of startup, or within 1 year after an engine and control device is no longer installed, configured, operated, and maintained in accordance with the manufacturer's emission-related written instructions, or within 1 year after you change emission-related settings in a way that is not permitted by the manufacturer. You must conduct subsequent performance testing every 8,760 hours of engine operation or 3 years, whichever comes first, thereafter to demonstrate compliance with the applicable emission standards.

[§19.304 of Regulation 19 and 40 CFR §60.4211(g)]

160. The permittee, when conducting performance tests pursuant to this subpart must do so according to paragraphs (a) through (e) of this section.

- a. The performance test must be conducted according to the in-use testing procedures in 40 CFR part 1039, subpart F, for stationary CI ICE with a displacement of less than 10 liters per cylinder, and according to 40 CFR part 1042, subpart F, for stationary CI ICE with a displacement of greater than or equal to 10 liters per cylinder and less than 30 liters per cylinder.
- b. Exhaust emissions from stationary CI ICE that are complying with the emission standards for new CI engines in 40 CFR part 1039 must not exceed the not-to-exceed (NTE) standards for the same model year and maximum engine power as required in 40 CFR 1039.101(e) and 40 CFR 1039.102(g)(1), except as specified in 40 CFR 1039.104(d). This requirement starts when NTE requirements take effect for nonroad diesel engines under 40 CFR part 1039.
- c. Exhaust emissions from stationary CI ICE that are complying with the emission standards for new CI engines in 40 CFR 89.112 or 40 CFR 94.8, as applicable, must not exceed the NTE numerical requirements, rounded to the same number of decimal places as the applicable standard in 40 CFR 89.112 or 40 CFR 94.8, as applicable, determined from the following equation:

$$\text{NTE requirement for each pollutant} = (1.25) \times (\text{STD})$$

Where:

STD = The standard specified for that pollutant in 40 CFR 89.112 or 40 CFR 94.8, as applicable.

Alternatively, stationary CI ICE that are complying with the emission standards for new CI engines in 40 CFR 89.112 or 40 CFR 94.8 may follow the testing procedures specified in §60.4213 of this subpart, as appropriate.

- d. Exhaust emissions from stationary CI ICE that are complying with the emission standards for pre-2007 model year engines in §60.4204(a), §60.4205(a), or §60.4205(c) must not exceed the NTE numerical requirements, rounded to the same number of decimal places as the applicable standard in §60.4204(a), §60.4205(a), or §60.4205(c), determined from the equation in paragraph (c) of this section.

Where:

STD = The standard specified for that pollutant in §60.4204(a), §60.4205(a), or §60.4205(c).

- e. Exhaust emissions from stationary CI ICE that are complying with the emission standards for new CI engines in 40 CFR part 1042 must not exceed the NTE standards for the same model year and maximum engine power as required in 40 CFR 1042.101(c).

[§19.304 of Regulation 19 and 40 CFR §60.4212]

161. If SN-1903 does not meet the standards applicable to non-emergency engines, the permittee must install a non-resettable hour meter prior to startup of SN-1903. [Regulation 19, §19.304 and 40 CFR §60.4209(a)]
162. If SN-1903 is an emergency stationary internal combustion engine, the permittee is not required to submit an initial notification. Starting with model year 2011, if the emergency engine does not meet the standards applicable to non-emergency engines in the applicable model year, the permittee must keep records of the operation of the engine in emergency and non-emergency service that are recorded through a non-resettable hour meter. The permittee must record the time of operation of the engine and the reason the engine was in operation during that time. [Regulation 19, §19.304 and 40 CFR §60.4214(b)]
163. The permittee must operate the emergency stationary ICE according to the requirements in paragraphs (a) through (c) of this section. In order for the engine to be considered an emergency stationary ICE under this subpart, any operation other than emergency operation, maintenance and testing, emergency demand response, and operation in non-emergency situations for 50 hours per year, as described in paragraphs (a) through (c) of this section, is prohibited. If you do not operate the engine according to the requirements in paragraphs (a) through (c) of this section, the engine will not be considered an emergency engine under this subpart and must meet all requirements for non-emergency engines.
  - a. There is no time limit on the use of emergency stationary ICE in emergency situations.
  - b. The permittee may operate your emergency stationary ICE for any combination of the purposes specified in paragraphs (i) through (iii) of this section for a maximum of 100 hours per calendar year. Any operation for non-emergency situations as allowed by paragraph (c) of this section counts as part of the 100 hours per calendar year allowed by this paragraph (b).
    - i. Emergency stationary ICE may be operated for maintenance checks and readiness testing, provided that the tests are recommended by federal, state or local government, the manufacturer, the vendor, the regional transmission organization or equivalent balancing authority and transmission operator, or the insurance company associated with the engine. The owner or operator may petition the Administrator for approval of additional hours to be used for maintenance checks and readiness testing, but a petition is not required if the owner or operator maintains records indicating that federal, state, or local standards require maintenance and testing of emergency ICE beyond 100 hours per calendar year.

- ii. Emergency stationary ICE may be operated for emergency demand response for periods in which the Reliability Coordinator under the North American Electric Reliability Corporation (NERC) Reliability Standard EOP-002-3, Capacity and Energy Emergencies (incorporated by reference, see §60.17), or other authorized entity as determined by the Reliability Coordinator, has declared an Energy Emergency Alert Level 2 as defined in the NERC Reliability Standard EOP-002-3.
  - iii. Emergency stationary ICE may be operated for periods where there is a deviation of voltage or frequency of 5 percent or greater below standard voltage or frequency.
- c. Emergency stationary ICE may be operated for up to 50 hours per calendar year in non-emergency situations. The 50 hours of operation in non-emergency situations are counted as part of the 100 hours per calendar year for maintenance and testing and emergency demand response provided in paragraph (f)(2) of this section. Except as provided in paragraph (f)(3)(i) of this section, the 50 hours per calendar year for non-emergency situations cannot be used for peak shaving or non-emergency demand response, or to generate income for a facility to an electric grid or otherwise supply power as part of a financial arrangement with another entity.

[Regulation 19, §19.304 and 40 CFR §60.4211(f)]

SN-1904, SN-1905, and SN-1906 Part 63, ZZZZ Conditions

164. The permittee shall for SN-1904, SN-1905, and SN-1906:
- a. Change oil and filter every 500 hours of operation or annually, whichever comes first.
  - b. Inspect air cleaner every 1,000 hours of operation or annually, whichever comes first, and replace as necessary;
  - c. Inspect all hoses and belts every 500 hours of operation or annually, whichever comes first, and replace as necessary.

[§19.304 of Regulation 19 and 40 CFR Part 63, §63.6602, Table 2c]

165. SN-1904, SN-1905, and SN-1906 must be in compliance with the operating requirements within Specific condition 164 and other requirements in Subpart ZZZZ at all times.

[§19.304 of Regulation 19 and 40 CFR Part 63, §63.6605(a)]

166. The permittee must operate and maintain SN-1904, SN-1905, and SN-1906 including associated air pollution control equipment and monitoring equipment, in a manner consistent with safety and good air pollution control practices for minimizing emissions. The general duty to minimize emissions does not require you to make any further efforts

to reduce emissions if levels required by this standard have been achieved. Determination of whether such operation and maintenance procedures are being used will be based on information available to the Administrator which may include, but is not limited to, monitoring results, review of operation and maintenance procedures, review of operation and maintenance records, and inspection of the source. [§19.304 of Regulation 19 and 40 CFR Part 63, §63.6605(b)]

167. The permittee must operate and maintain SN-1904, SN-1905, and SN-1906 according to the manufacturer's emission-related written instructions or develop your own maintenance plan which must provide to the extent practicable for the maintenance and operation of the engine in a manner consistent with good air pollution control practice for minimizing emissions. [§19.304 of Regulation 19 and 40 CFR Part 63, §63.6625(e)(2)]
168. The permittee must for SN-1904, SN-1905, and SN-1906 install a non-resettable hour meter if one is not already installed. [§19.304 of Regulation 19 and 40 CFR Part 63, §63.6625(f)]
169. The permittee must minimize SN-1904, SN-1905, and SN-1906 time spent at idle during startup and minimize startup time to a period needed for appropriate and safe loading of the engine, not to exceed 30 minutes, after which time the emission standards in Specific Condition 164. [§19.304 of Regulation 19 and 40 CFR Part 63, §63.6625(h)]
170. The permittee has the option of utilizing an oil analysis program in order to extend the specified oil change requirement in Specific Condition 164. The oil analysis must be performed at the same frequency specified for changing the oil Specific Condition 164. The analysis program must at a minimum analyze the following three parameters: Total Base Number, viscosity, and percent water content. The condemning limits for these parameters are as follows: Total Base Number is less than 30 percent of the Total Base Number of the oil when new; viscosity of the oil has changed by more than 20 percent from the viscosity of the oil when new; or percent water content (by volume) is greater than 0.5. If all of these condemning limits are not exceeded, the permittee is not required to change the oil. If any of the limits are exceeded, the permittee must change the oil within 2 business days of receiving the results of the analysis; if the engine is not in operation when the results of the analysis are received, the permittee must change the oil within 2 business days or before commencing operation, whichever is later. If the permittee choose to utilize an oil analysis program, the permittee must keep records of the parameters that are analyzed as part of the program, the results of the analysis, and the oil changes for the engine. The analysis program must be part of the maintenance plan within Specific Condition 167, for the engine. [§19.304 of Regulation 19 and 40 CFR Part 63, §63.6625(i)]
171. The permittee must for SN-1904, SN-1905, and SN-1906:
  - a. Operate and maintain the stationary RICE according to the manufacturer's emission-related operation and maintenance instructions; or



- b. Develop and follow your own maintenance plan which must provide to the extent practicable for the maintenance and operation of the engine in a manner consistent with good air pollution control practice for minimizing emissions.

[§19.304 of Regulation 19 and 40 CFR Part 63, §63.6640, Table 6(9)]

SN-1909, SN-1907, and SN-1908 Part 63, ZZZZ Conditions

172. The permittee must for SN-1909, SN-1907, and SN-1908 minimize the engine's time spent at idle during startup and minimize the engine's startup time to a period needed for appropriate and safe loading of the engine, not to exceed 30 minutes, after which time the emission standards applicable to all times other than startup in Tables 1a, 2a, 2c, and 2d to this subpart apply. [§19.304 of Regulation 19 and Part 63, §63.6625(h)]
173. If you own or operate a stationary CI engine that is subject to the work, operation or management practices in items 1 or 2 of Table 2c to this subpart or in items 1 or 4 of Table 2d to this subpart, you have the option of utilizing an oil analysis program in order to extend the specified oil change requirement in Tables 2c and 2d to this subpart. The oil analysis must be performed at the same frequency specified for changing the oil in Table 2c or 2d to this subpart. The analysis program must at a minimum analyze the following three parameters: Total Base Number, viscosity, and percent water content. The condemning limits for these parameters are as follows: Total Base Number is less than 30 percent of the Total Base Number of the oil when new; viscosity of the oil has changed by more than 20 percent from the viscosity of the oil when new; or percent water content (by volume) is greater than 0.5. If all of these condemning limits are not exceeded, the engine owner or operator is not required to change the oil. If any of the limits are exceeded, the engine owner or operator must change the oil within 2 business days of receiving the results of the analysis; if the engine is not in operation when the results of the analysis are received, the engine owner or operator must change the oil within 2 business days or before commencing operation, whichever is later. The owner or operator must keep records of the parameters that are analyzed as part of the program, the results of the analysis, and the oil changes for the engine. [§19.304 of Regulation 19 and Part 63, §63.6625(i)]

SN-1903 Part 63, ZZZZ Conditions

174. SN-1903 meets the requirements of 40 CFR Part 63, Subpart ZZZZ by meeting the requirements of 40 CFR Part 60, Subpart IIII. No further requirements apply for such engines under 40 CFR Part 63, Subpart ZZZZ. [Regulation 18, §19.304 and 40 CFR §63.6590(c)(6)]

Alternative Operating Scenario  
 Sour Gas Flaring Events

During normal operations, GLCC sends sour gas to Lion Oil for processing to remove sulfur, thus “sweetening” the sour gas. The sweetened gas is then returned to GLCC for combustion as a fuel. During this shutdown period, GLCC will minimize emissions by treating sour gas in the NaHS Unit. However, the NaHS Unit will need periodic maintenance to repair and clean. After approximately two weeks of continuous use, the NaHS Unit must be taken off-line and cleaned. This process can take several hours, during which time gas would be flared. Although GLCC will make efforts to reduce the need to flare sour gas, sour gas flaring will be necessary during times when Lion Oil’s gas treating unit is down for extended periods of time.

175. During planned outages of Lion Oil’s amine unit, the Central Plant’s NaHS unit, and/or other equipment related to the off-site transfer or processing of sour gas (including startup and shutdown associated therewith), the permittee shall be allowed to combust the Central Plant’s sour gas in the Central Plant’s sour gas flare in accordance with Specific Conditions 176, 177, 178, and 179 or route the sour gas to another facility permitted to accept it. [Regulation 19, §19.601]
176. The permittee shall not exceed the emission rates set forth in the following table when flaring sour gas during planned outages of Lion Oil’s amine unit, the Central Plant’s NaHS unit, and/or other equipment related to the off-site transfer or processing of sour gas (including startup and shutdown associated therewith). The permittee shall demonstrate compliance with this condition through compliance with Specific Condition 177. [Reg.19.501 et seq. and 40 C.F.R. § 52 Subpart E]

SN	Description	Pollutant	lb/hr	tpy
902	Sour Gas Flare (Sour Gas Combustion)	PM <sub>10</sub>	2.3	0.2
		SO <sub>2</sub>	713.2	35.0
903	Sour Gas Backup Flare (Sour Gas Combustion)	VOC	3.0	0.2
		CO	7.9	0.4
		NO <sub>x</sub>	1.5	0.1

177. The permittee shall maintain records which document compliance with the emission limits listed in Specific Condition 176 as a rolling 12-month average. These records shall indicate the reason for flaring, the duration of each event, the total volume of gas flared during each event, and the air emissions resulting from each event in both lb/hr and tons/yr (tons per year shall be calculated as a twelve month rolling total). These records shall be updated for each flaring event, kept on site, and made available to Department personnel upon request and submitted to the Department in accordance with Current General Provision 7. If emissions exceed the limits in Specific Condition 176, the emissions must be reported in accordance with §19.601 or §19.602, as applicable. [Regulation No. 19, §19.705 and 40 CFR Part 52, Subpart E]

178. The permittee shall not exceed the emission rates set forth in the following table when flaring sour gas during planned outages of Lion Oil’s amine unit, the Central Plant’s NaHS unit, and/or other equipment related to the off-site transfer or processing of sour gas (including startup and shutdown associated therewith). The permittee shall demonstrate compliance with this condition through compliance with Specific Condition 179. [Regulation 18, §18.801 and Ark. Code Ann. § 8-4-203 as referenced by Ark. Code Ann. §§ 8-4-304 and §8-4-311]

SN	Description	Pollutant	lb/hr	tpy
902	Sour Gas Flare (Sour Gas Combustion)	PM H <sub>2</sub> S	2.3	0.2
903	Sour Gas Backup Flare (Sour Gas Combustion)		7.8	0.2

179. The permittee shall maintain calculations demonstrating compliance with Specific Condition 178. These records shall indicate the reason for flaring, the duration of each flaring event, the total volume of gas flared during each event, and the air emissions resulting from each event in both lb/hr and tons/yr. These records shall be updated for each flaring event, kept on site, made available to Department personnel upon request and submitted to the Department in accordance with Current General Provision 7. If emissions exceed the limits in Specific Condition 178, the emissions must be reported in accordance with §18.1101, as applicable. [Regulation 18, §18.1004 and A.C.A. §8-4-203 as referenced by §8-4-304 and 8-4-311]
180. Sour gas flaring of any duration during any unplanned outage of Lion Oil’s amine unit, the Central Plant’s NaHS unit, and/or other equipment related to the off-site transfer or processing of sour gas (including startup and shutdown associated therewith), shall be considered an “upset condition” or “emergency condition” and shall be reported in accordance with Regulations 19, §§ 19.601, 19.602, and Regulation 18, §§ 18.1101 and 18.105, as applicable. [Ark. Code Ann. § 8-4-203 as referenced by Ark. Code Ann. §§ 8-4-304 and §8-4-311]

Sweet Gas Flaring Events

Source Description

Under normal operations fuel gases are preferentially combusted within Boiler #2, however occasionally the amount of fuel gases may exceed the boilers short term fuel gas combustion capacity. On these occasions, the fuel gases cannot be stored due to the large volumes, so the excess fuel gases must be flared. Although it is very unlikely, the facility will flare gases at the flare's design capacity and simultaneously operate the boiler at design capacity.

Specific Conditions

181. The permittee shall not exceed the emission rates set forth in the following table. The permittee shall demonstrate compliance with this condition by compliance with Specific Conditions 183, 184, 185, 186, 187, and 189. [Reg.19.501 *et seq.* and 40 C.F.R. § 52 Subpart E]

SN	Description	Pollutant	lb/hr	tpy
902	Sour Gas Flare	PM <sub>10</sub>	13.2	*
		SO <sub>2</sub>	120.0	*
903	Sour Gas Backup Flare	VOC	19.4	*
		CO	51.1	*
		NO <sub>x</sub>	9.4	*

\*Combined annual emissions from Boiler #2 (SN-301), Sour Gas Flare (SN-902), and Sour Gas Backup Flare (SN-903) when burning (SN-301) and/or flaring (SN-902 and SN-903) partially sweet or sweetened gas.

182. The permittee shall not exceed the emission rates set forth in the following table. The permittee shall demonstrate compliance with this condition by compliance with Specific Conditions 183, 184, 185, 186, 188, and 189. [Reg.18.801 and Ark. Code Ann. § 8-4-203 as referenced by Ark. Code Ann. §§ 8-4-304 and 8-4-311]

SN	Description	Pollutant	lb/hr	tpy
902	Sour Gas Flare	PM	13.2	*
903	Sour Gas Backup Flare	Arsenic	3.450E-05	*
		Benzene	3.623E-04	*
		Beryllium	2.070E-06	*
		Cadmium	1.898E-04	*
		Chromium	2.415E-04	*
		Cobalt	1.449E-05	*
		Dichlorobenzene	2.070E-04	*
		Formaldehyde	1.294E-02	*
		Hexane	3.105E-01	*
		Manganese	6.555E-05	*
		Mercury	4.485E-05	*
		Naphthalene	1.052E-04	*
		Nickel	3.623E-04	*
		Selenium	4.140E-06	*
		Toluene	5.865E-04	*
POM	1.521E-05	*		
		H <sub>2</sub> S	1.3	*

\*Combined annual emissions from Boiler #2 (SN-301), Sour Gas Flare (SN-902), and Sour Gas Backup Flare (SN-903) when burning (SN-301) and/or flaring (SN-902 and SN-903) partially sweet or sweetened gas.

183. Visible emissions may not exceed the limits specified in the following table of this permit as measured by EPA Reference Method 9. Compliance with this condition will be shown by compliance with Specific Condition 184 and Plantwide Condition 5.

SN	Limit	Regulation Citation
902 (Pilot Only) & 903 (Pilot Only)	5%	Reg.18.501 and A.C.A. §8-4-203 as referenced by §8-4-304 and §8-4-311

184. The permittee shall only combust fuels in the Sour Gas Flare (SN-902) and Sour Gas Backup Flare (SN-903) as specified in the table below.

Source	Fuels
Sour Gas Flare (SN-902) and Sour Gas Backup Flare (SN-903)	Partially sweet fuel gas from the NaHS unit, or “sweetened” gas from the JV Amine unit at Lion Oil Company’s facility
Sour Gas Flare Pilot (SN-902) and Sour Gas Backup Flare Pilot (SN-903)	Pipeline quality natural gas

[Reg.19.705, Ark. Code Ann. §§ 8-4-203 as referenced by Ark. Code Ann. §§ 8-4-304 and 8-4-311, and 40 C.F.R. § 52 Subpart E]

185. The permittee will be limited to the following flaring rates in the following table:

Source	Fuels	Flaring Per Year
Sour Gas Flare (SN-902)	Partially sweet fuel gas from the NaHS unit and “sweetened” gas from the JV Amine unit at Lion Oil	250,000,000 scf
Sour Gas Backup Flare (SN-903)		

186. The permittee shall maintain monthly records of throughput listed in the table in Specific Condition 185. Compliance shall be determined on a monthly basis by totaling the throughput for that month and the previous 11 months. Each 12-month rolling total shall be updated by the fifteenth day of the month following the month to which the records pertain. These records shall be kept on-site and shall be submitted in accordance with General Provision #7. [Reg.19.705 and 40 C.F.R. § 52 Subpart E]
187. The permittee shall maintain monthly and annual records of the partially sweet fuel gas from the NaHS unit and “sweetened” fuel gas from the JV Amine Unit burned in SN-301, SN-902B and SN-903B to ensure emissions do not exceed the annual emission limits in Specific Condition 111 during any consecutive twelve month period for the pollutants listed. These records shall be kept on-site and shall be submitted in accordance with General Provision #7. [Reg.19.705 and 40 C.F.R. § 52 Subpart E]
188. The permittee shall maintain monthly and annual records of the partially sweet fuel gas from the NaHS unit and “sweetened” fuel gas from the JV Amine Unit burned in SN-301, SN-902B and SN-903B to ensure emissions do not exceed the annual emission limits in Specific Condition 112 during any consecutive twelve month period for the pollutants listed. These records shall be kept on-site and shall be submitted in accordance with General Provision #7. [Reg.18.1004 and Ark. Code Ann. § 8-4-203 as referenced by Ark. Code Ann. §§ 8-4-304 and 8-4-311]
189. The partially sweet fuel gas from the NaHS unit burned in Sour Gas Flares (SN-902 or SN-903) shall contain no more than 63.75 pounds per hour of H<sub>2</sub>S. The permittee shall

Great Lakes Chemical Corporation - Central Plant  
Permit #: 1077-AOP-R5  
AFIN: 70-00012

measure the H<sub>2</sub>S concentration of the partially sweet fuel gas from the NaHS Unit a minimum of once every two hours when the plant is in operation. These measurements need only be conducted while the partially sweet fuel gas from the NaHS unit is being combusted in Sour Gas Flares SN-902 or SN-903. These measurements shall be conducted using ASTM E-260, or the method contained in 40 CFR §60.648, or an equivalent method, provided it is approved by the Department prior to its use. The measured H<sub>2</sub>S shall be converted to SO<sub>2</sub> out the stack through the use of a mass balance. The results of these measurements shall be kept on-site and made available to Department personnel upon request. A report of these measurements shall be submitted to the Department in accordance with General Provision #7. [§19.705 of Regulation 19, Ark. Code Ann. § 8-4-203 as referenced by Ark. Code Ann. §§ 8-4-304 and §8-4-311, and 40 CFR Part 52 Subpart E]

Great Lakes Chemical Corporation - Central Plant  
Permit #: 1077-AOP-R5  
AFIN: 70-00012

## **SECTION V: COMPLIANCE PLAN AND SCHEDULE**

Great Lakes Chemical Corporation - Central Plant will continue to operate in compliance with those identified regulatory provisions. The facility will examine and analyze future regulations that may apply and determine their applicability with any necessary action taken on a timely basis.



## SECTION VI: PLANTWIDE CONDITIONS

1. The permittee shall notify the Director in writing within thirty (30) days after commencing construction, completing construction, first placing the equipment and/or facility in operation, and reaching the equipment and/or facility target production rate. [Reg.19.704, 40 C.F.R. § 52 Subpart E, and Ark. Code Ann. § 8-4-203 as referenced by Ark. Code Ann. §§ 8-4-304 and 8-4-311]
2. If the permittee fails to start construction within eighteen months or suspends construction for eighteen months or more, the Director may cancel all or part of this permit. [Reg.19.410(B) and 40 C.F.R. § 52 Subpart E]
3. The permittee must test any equipment scheduled for testing, unless otherwise stated in the Specific Conditions of this permit or by any federally regulated requirements, within the following time frames: (1) new equipment or newly modified equipment within sixty (60) days of achieving the maximum production rate, but no later than 180 days after initial start up of the permitted source or (2) operating equipment according to the time frames set forth by the Department or within 180 days of permit issuance if no date is specified. The permittee must notify the Department of the scheduled date of compliance testing at least fifteen (15) business days in advance of such test. The permittee shall submit the compliance test results to the Department within sixty (60) calendar days after completing the testing. [Reg.19.702 and/or Reg.18.1002 and Ark. Code Ann. § 8-4-203 as referenced by Ark. Code Ann. §§ 8-4-304 and 8-4-311]
4. The permittee must provide:
  - a. Sampling ports adequate for applicable test methods;
  - b. Safe sampling platforms;
  - c. Safe access to sampling platforms; and
  - d. Utilities for sampling and testing equipment.

[Reg.19.702 and/or Reg.18.1002 and Ark. Code Ann. § 8-4-203 as referenced by Ark. Code Ann. §§ 8-4-304 and 8-4-311]
5. The permittee must operate the equipment, control apparatus and emission monitoring equipment within the design limitations. The permittee shall maintain the equipment in good condition at all times. [Reg.19.303 and Ark. Code Ann. § 8-4-203 as referenced by Ark. Code Ann. §§ 8-4-304 and 8-4-311]
6. This permit subsumes and incorporates all previously issued air permits for this facility. [Reg. 26 and Ark. Code Ann. § 8-4-203 as referenced by Ark. Code Ann. §§ 8-4-304 and 8-4-311]
7. For any emission sources subject to requirements under this permit which are shut down or removed from service for all or a portion of the permit term, the permittee shall

maintain documentation of the date that the equipment was shut down or removed from service. If the source is returned to service at a later date, then this date shall also be documented on these records. These records shall be maintained in a well-organized format, made available to Department personnel upon request, and submitted in accordance with General Provision #7. Any emission source which is properly documented in accordance with this condition shall be exempt from applicable performance testing, monitoring, recordkeeping, and/or reporting requirements of this permit during the period that the source is not in operation. The permittee shall comply with all such applicable requirements at all times while a source is in operation. This condition does not relieve the permittee of the obligation to comply with applicable requirements contained in federal regulations to which the facility is subject.

8. Within 180 days of issuance of this permit the facility shall submit a non-critical pollutant control strategy (NCPCS) evaluation and for any pollutant listed in this condition that does not pass the strategy (NCPCS) the permittee shall submit a refined model of facility-wide emissions for that pollutant. The pollutants are: bromine, hydrogen bromide, Hydrogen Chloride, Hydrazine and trimethylamine. [§18.1004 of Regulation 18 and Ark. Code Ann. § 8-4-203 as referenced by Ark. Code Ann. §§ 8-4-304 and §8-4-311]
9. The permittee is subject to and shall comply with all applicable provisions of 40 CFR Part 60 Subpart VV – *Standards of Performance for Equipment Leaks of VOC in the Synthetic Organic Chemicals Manufacturing Industry*. Equipment effected by this regulation includes equipment associated with: ethyl bromide production at the Alkyl Bromides Unit, methyl bromide production at the Alkyl Bromides Unit, methyl bromide production at the TBBPA unit (for components not covered by the PAI MACT LDAR requirements), ethyl bromide and methyl bromide at the Packaging and Shipping Unit. [§19.304 of Regulation 19 and 40 CFR §60.480]
10. The equipment referenced in Plantwide Condition #9 is subject to the requirements of Subpart VV which are summarized below. [§19.304 of Regulation 19, and 40 CFR §§60.480]
  - a. Pursuant to § 60.482-1(a), the facility shall demonstrate compliance with the requirements of §§ 60.482-1 to 60.482-10 for all equipment within 180 days of initial startup.
  - b. Pursuant to § 60.482-1(b), compliance with §§ 60.482-1 to 60.482-10 will be determined by review of records and reports, review of performance test results, and inspection using the methods and procedures specified in § 60.485.
  - c. Pursuant to § 60.482-1(c)(1), the facility may request a determination of equivalence of a means of emission limitation to the requirements of §§

- 60.482-2, 60.482-3, 60.482-5, 60.482-6, 60.482-7, 60.482-8, and 60.482-10 as provided in § 60.484.
- d. Pursuant to § 60.482-1(c)(2), if the Administrator makes a determination that a means of emission limitation is at least equivalent to the requirements of §§ 60.482-2, 60.482-3, 60.482-5, 60.482-6, 60.482-7, 60.482-8, or 60.482-10, the facility shall comply with the requirements of that determination.
  - e. Pursuant to § 60.482-3(a), the compressors in hydrogen service are not subject to this subpart as per the exemption of § 60.593(b)(1).
  - f. Pursuant to § 60.482-4, the facility has no pressure relief devices in gas/vapor service and is not subject to this section.
  - g. Pursuant to § 60.482-6(a)(1), each open-ended valve or line shall be equipped with a cap, blind flange, plug, or a second valve, except as provided in § 60.482-1(c).
  - h. Pursuant to § 60.482-6(a)(2), the cap, blind flange, plug, or second valve shall seal the open end at all times except during operations requiring process fluid flow through the open-ended valve or line.
  - i. Pursuant to § 60.482-6(b), each open-ended valve or line equipped with a second valve shall be operated in a manner such that the valve on the process fluid end is closed before the second valve is closed.
  - j. Pursuant to § 60.482-6(c), when a double block-and-bleed system is being used, the bleed valve or line may remain open during operations that require venting the line between the block valves but shall comply with paragraph (a) at all other times.
  - k. Pursuant to § 60.482-7, the facility shall comply with the requirements for valves in gas/vapor service or in light liquid service.
  - l. Pursuant to § 60.482-10, the facility shall comply with the requirements for closed vent systems and control devices.
  - m. Pursuant to § 60.483-2, the facility has elected to comply with the alternative work practice specified in paragraphs (b)(3) of this section.
  - n. Pursuant to § 60.483-2(2), the facility has notified the Administrator before implementing these alternative work practices, as specified in § 60.487(d).
  - o. Pursuant to § 60.483-2(b)(1), the facility has initially complied with the requirements for valves in gas/vapor service and valves in light liquid service, as described in § 60.482-7.

- p. Pursuant to § 60.483-2(b)(3), after 5 consecutive quarterly leak detection periods with the percent of valves leaking equal to or less than 2.0, an owner or operator may begin to skip 3 of the quarterly leak detection periods for the valves in gas/vapor and light liquid service.
- q. Pursuant to § 60.483-2(b)(4), if the percent of valves leaking is greater than 2.0, the owner or operator shall comply with the requirements as described in § 60.482-7 but can again elect to use this section.
- r. Pursuant to § 60.485(a), in conducting the performance tests required in § 60.8, the facility shall use as reference methods and procedures the test methods in Appendix A of this part or other methods and procedures as specified in this section, except as provided in § 60.8(b).
- s. Pursuant to § 60.485(b), the facility shall determine compliance with the standards in §§ 60.482 and 60.483 as follows:
  - (1) Method 21 (or other approved method) shall be used to determine the presence of leaking sources. The instrument shall be calibrated before use each day of its use by the procedures specified in Method 21 (or other approved method). The following calibration gases shall be used:
    - (i) Zero air (less than 10 ppm of hydrocarbon in air); and
    - (ii) A mixture of methane or n-hexane and air at a concentration of about, but less than, 10,000 ppm methane or n-hexane.
- t. Pursuant to § 60.485(c), the facility shall determine compliance with the no detectable emission standards in §§ 60.482-2(e), and 60.482-3(i) as follows:
  - (1) The requirements of paragraph (b) shall apply.
  - (2) Method 21 (or other approved method) shall be used to determine the background level. All potential leak interfaces shall be traversed as close to the interface as possible. The arithmetic difference between the maximum concentration indicated by the instrument and the background level is compared with 500 ppm for determining compliance.
  - (3) Pursuant to § 60.485(f), samples used in conjunction with paragraphs (d), (e), and (g) shall be representative of the process fluid that is contained in or contacts the equipment or the gas being combusted in the flare.
  - (4) Pursuant to § 60.486(a)(1), the facility shall comply with the recordkeeping requirements of this section.
- u. Pursuant to § 60.486(a)(2), an owner or operator of more than one affected facility subject to the provisions of this subpart may comply with the

recordkeeping requirements for these facilities in one recordkeeping system if the system identifies each record by each facility.

- v. Pursuant to § 60.486(b), when each leak is detected as specified in §§ 60.482-2, 60.482-3, 60.482-7, 60.482-8, and 60.483-2, the following requirements apply:
  - (1) A weatherproof and readily visible identification, marked with the equipment identification number, shall be attached to the leaking equipment.
  - (2) The identification on a valve may be removed after it has been monitored for 2 successive months as specified in § 60.482-7(c) and no leak has been detected during those 2 months.
  - (3) The identification on equipment except on a valve, may be removed after it has been repaired.
- w. Pursuant to § 60.486(k), the provisions of § 60.7 (b) and (d) do not apply to affected facilities subject to this subpart.
- x. Pursuant to § 60.487(a), the facility shall submit semiannual reports to the Administrator beginning six months after the initial start up date.
- y. Pursuant to § 60.487(b), the initial semiannual report to the Administrator shall include the following information:
  - (1) Process unit identification.
    - (i) Number of valves subject to the requirements of § 60.482-7, excluding those valves designated for no detectable emissions under the provisions of § 60.482-7(f).
    - (ii) Number of pumps subject to the requirements of § 60.482-2, excluding those pumps designated for no detectable emissions under the provisions of § 60.482-2(e) and those pumps complying with § 60.482-2(f).
- z. Number of compressors subject to the requirements of § 60.482-3, excluding those compressors designated for no detectable emissions under the provisions of § 60.482-3(i) and those compressors complying with § 60.482-3(h).
  - (i) Pursuant to § 60.487(c), all semiannual reports to the Administrator shall include the following information, summarized from the information in § 60.486:
    - (2) Process unit identification.
    - (3) For each month during the semiannual reporting period,

- (i) Number of valves for which leaks were detected as described in § 60.482(7)(b) or § 60.483-2,
    - (ii) Number of valves for which leaks were not repaired as required in § 60.482-7(d)(1),
    - (iii) Number of pumps for which leaks were detected as described in § 60.482-2(b) and (d)(6)(i),
    - (iv) Number of pumps for which leaks were not repaired as required in § 60.482-2(c)(1) and (d)(6)(ii),
    - (v) Number of compressors for which leaks were detected as described in § 60.482-3(f),
    - (vi) Number of compressors for which leaks were not repaired as required in § 60.482-3(g)(1), and
    - (vii) The facts that explain each delay of repair and, where appropriate, why a process unit shutdown was technically infeasible.
  - (4) Dates of process unit shutdowns which occurred within the semiannual reporting period.
  - (5) Revisions to items reported according to paragraph (b) if changes have occurred since the initial report or subsequent revisions to the initial report.
  - aa. Pursuant to § 60.487(d), the facility has elected to comply with the provisions of § 60.483-2 and has notified the Administrator of the alternative standard selected 90 days before implementing the provision. If the facility decides to comply with the provisions of § 60.483-1, the facility shall notify the Administrator 90 days in advance before implementing the provisions.
  - bb. Pursuant to § 60.487(e), the facility shall report the results of all performance tests in accordance with § 60.8 of the General Provisions. The provisions of § 60.8(d) do not apply to affected facilities subject to the provisions of this subpart except that the facility must notify the Administrator of the schedule for the initial performance tests at least 30 days before the initial performance tests.
11. In order to demonstrate compliance with Subpart VV, the facility shall maintain a log of the following for the methyl bromide handling at the alkyl bromides unit: [§19.304 of Regulation 19, and 40 CFR Part 60 Subpart VV]
- a. Compliance with testing provisions as required by § 60.592(d).
  - b. Any exemptions for compressors considered to be in hydrogen service.

- c. Any exemptions for equipment that is in vacuum service as provided by § 60.482-1(d).
- d. Monthly monitoring results of § 60.482-2(a)(1).
- e. Weekly visual inspection checks of liquids dripping of § 60.482-2(a)(2).
- f. Record of instrument reading of § 60.482-2(b)(1).
- g. Record of leaks from pump seal in § 60.482-2(b)(2).
- h. Attempts to repair leak within 15 days as provided by § 60.482-2(c)(1).
- i. Attempts to repair leak within 5 days as provided by § 60.482-2(c)(2).
- j. Records of exemption for each pump equipped with a dual mechanical seal system as provided by § 60.482-2(d).
- k. Records of exemption for any pump designated for no detectable emission as provided by § 60.482-2(e).
- l. Records of exemption for any pump equipped with a closed vent system as provided by § 60.482-2(f).
- m. Records that each sampling connection system is equipped with a closed purge system or closed vent system in §60.482-5(a) and (b) or qualifies for the exemptions.
- n. All in-situ sampling systems that are exempt in § 60.482-5(c).
- o. Record of monitoring of potential leaks within 5 days as required by § 60.482-8(a).
- p. Record of leaks detected in § 60.482-8(b).
- q. Attempts to repair leak within 15 days as provided by § 60.482-8(c)(1).
- r. Attempts to repair leak within 5 days as provided by § 60.482-8(c)(2).
- s. Record of delay of repair of equipment as allowed in § 60.482-9(a) or (b).
- t. Record of delay of repair of equipment as allowed in § 60.482-9(c).
- u. Record of delay of repair of equipment as allowed in § 60.482-9(d).
- v. Delays of repair beyond a process unit shutdown as allowed in § 60.482-9(e).
- w. Record of the percent of valves leaking as required in § 60.483-2(5) and (6).
- x. Records of the tests and results of § 60.485(d).
- y. Results of § 60.485.
- z. Records of § 60.485(g).

- aa. Information required by § 60.486(c) for leaks.
- bb. Information required by § 60.486(d) for the design requirements for closed vent system/control device.
- cc. Information required by § 60.486(e) for the equipment.
- dd. Information required by § 60.486(f) for the valves.
- ee. Information required by § 60.486(g) for the valves.
- ff. Information required by § 60.486(h).
- gg. Requirements to show that equipment is not in VOC service as provided by §60.486(j).

NSPS Reporting Deadlines

12. All reporting required under any applicable NSPS standards, 40 CFR Parts 60, shall be submitted in accordance with General Provision #7, with the exception of the following standards. Reports for these listed standards shall be submitted each year by the dates listed in the following table. [§19.304 of Regulation 19]

<b>Regulation</b>	<b>Periodic Report Due Dates</b>
40 CFR Part 60, Subpart VV	10/31 and 4/30

MACT Requirements

PAI MACT (40 CFR Part 63 Subpart MMM)

13. The methyl bromide process units located at the TBBPA unit and the Bromine Recovery Unit (SN-102) are subject to and shall comply with all applicable provisions of 40 CFR Part 63 Subpart MMM – *National Emission Standards for Hazardous Air Pollutants for Pesticide Active Ingredients Production*. The emission sources associated with MeBr production are: SN-1001, 1002, 1003, 1005, 1006, 1007, 1008, 1019, and 1099. The requirements of this rule as they apply to this facility are summarized below. [Reg.19.304 and 40 C.F.R. § 63.1360]

- a. The requirements of the PAI MACT only apply to the MeBr production equipment located at the TBBPA unit during periods of MeBr production. The facility shall maintain records in a logbook or other similar format which clearly indicate the beginning and end of each MeBr production cycle. These records shall be maintained on-site and shall be made available to Department personnel upon request. These records shall be submitted in accordance with General



Provision #7. [§19.304 of Regulation 19 and Ark. Code Ann. § 8-4-203 as referenced by Ark. Code Ann. §§ 8-4-304 and §8-4-311]

- b. The permittee shall comply with all applicable general provisions of 40 CFR Part 63 Subpart A as referenced by Table 1 of Part 63 Subpart MMM. [Reg.19.304 and 40 C.F.R. § 63.1360(c)]
- c. The emission limitations of the PAI MACT (40 CFR Part 63 Subpart MMM) shall apply at all times during MeBr production, except during periods of non-operation of the affected source (or specific portion thereof) resulting in cessation of the emissions to which this subpart applies. [Reg.19.304 and 40 C.F.R. § 63.1360(e)]
- d. Organic HAP emissions from the bromine recovery unit (SN-102) shall be reduced by 98 percent or greater. [§19.304 and 40 CFR §63.1362(b)(2)(ii)]
- e. Organic HAP emissions from the BPA Mix Tanks (SN-1019) shall be reduced by 90 percent or greater. [Reg.19.304 and 40 C.F.R. § 63.1362(b)(2)(iii)]
- f. Emissions of HCl and Cl<sub>2</sub> from the bromine recovery unit (SN-102) shall be reduced by 94 percent or greater or to outlet concentrations less than or equal to 20 ppmv. [Reg.19.304 and 40 C.F.R. § 63.1362(b)(3)]
- g. The permittee shall determine the group status of each storage vessel or designate it as a Group 1 storage vessel. The permittee shall additionally determine the maximum true vapor pressure of the materials stored in each Group 1 storage vessel. This evaluation has been performed by the permittee and the results are summarized below. [Reg.19.304 and 40 C.F.R. § 63.1362(c)]

Source No.	Equipment Description	Design Capacity (gal)	Max. True Vapor Pressure (kPa)	Group Designation
1008	MeOH Storage Tank	60,000	19.1	1
N/A <sup>a</sup>	MeBr Storage	20,563	70.6	1
N/A <sup>a</sup>	MeBr Storage	5,148	N/A <sup>b</sup>	2
N/A <sup>a</sup>	UK-60 Tank	500	N/A <sup>b</sup>	2
N/A <sup>a</sup>	MeBr Storage	3,000	N/A <sup>b</sup>	2

<sup>a</sup>Emissions from these tanks are routed to the BRU (SN-102)

<sup>b</sup>These tanks are designated Group 2 due to design capacity less than 75 m<sup>3</sup>

- h. Each Group 1 storage vessel shall be equipped with one of the roof types or control devices as specified in §63.1362(c)(2)(i) through (iv). The effected sources and control type are detailed in the following table. [Reg.19.304 and 40 C.F.R. § 63.1362(c)(2)]

Source No.	Equipment Description	Compliance Option Selected	Emission Limitation
1008	MeOH Storage Tank	§63.1362(c)(2)(iv)(C)	Closed vent system and flare, no MACT emission limitation
N/A	MeBr Storage	§63.1362(c)(2)(iv)(A)	Closed vent system and control device (BRU). Reduce OHAP by 95% or greater by wt
N/A	MeBr Storage	§63.1362(c)(2)(iv)(A)	Closed vent system and control device (BRU). Reduce OHAP by 95% or greater by wt

- i. The permittee is exempt from the requirements of §63.1362(c)(2) through (4) (Plantwide Condition #0) during periods of planned routine maintenance of the control device that do not exceed 240 hours/year. [Reg.19.304 and 40 C.F.R. § 63.1362(c)(5)]
- j. Compliance with the provisions of paragraphs (c)(2) and (3) of 40 CFR §63.1362 (Plantwide Condition #0) shall be demonstrated by compliance with the initial compliance procedures of 40 CFR §63.1365(d) and the monitoring requirements of §63.1366 [Reg.19.304 and 40 C.F.R. § 63.1362(c)(7)]
- k. The permittee shall comply with the applicable provisions of 40 CFR §63.132 through §63.147 for each affected wastewater system, with the differences noted in paragraphs (d)(1) through (d)(16) of 40 CFR §63.1362. [Reg.19.304 and 40 C.F.R. § 63.1362(d)]
- l. Unless one of the conditions of 40 CFR §63.104(a)(1) through (6) are met, the permittee shall monitor each heat exchange system that is used to cool process equipment in PAI process units that are part of an affected source as defined in §63.1360(a) according to the provisions of either §63.104(b) or (c) of 40 CFR Part 63 Subpart F. When the term “chemical manufacturing process unit is used in §63.104(c) of Subpart F, the term “PAI process unit” shall apply for Subpart MMM. Whenever a leak is detected, the permittee shall comply with the requirements in §63.104(d) of Subpart F. Delay of repair of heat exchange systems for which leaks have been detected are allowed in accordance with the provisions of §63.104(c) of Subpart F. [Reg.19.304 and 40 C.F.R. § 63.1362(f)]
- m. Opening of a safety device, as defined in §63.1361, is allowed at any time conditions require it to avoid unsafe conditions. [Reg.19.304 and 40 C.F.R. § 63.1362(i)]
- n. The permittee shall comply with the provisions of subpart H of 40 CFR Part 63. Sections 63.160, 63.161, 63.162, 63.163, 63.167, 63.168, 63.170, 63.173, 63.175, 63.176, 63.181, and 63.182 of subpart H shall not apply for the purposes of this subpart MMM. The owner or operator shall comply with the provisions specified

- in paragraphs (b)(1)(i) through (viii) of 63.1363. [§19.304 of Regulation 19 and 40 CFR Part 63, Subpart MMM, §63.1363(b)]
- o. Each piece of equipment to which this section applies shall be identified such that it can be distinguished readily from equipment that is not subject to this section. Identification of the equipment does not require physical tagging of the equipment. For example, the equipment may be identified on a plant site plan, in log entries, or by designation of process boundaries by some form of weatherproof identification. If changes are made to the affected source subject to the leak detection requirements, equipment identification for each type of component shall be updated, if needed, within 15 calendar days of the end of each monitoring period for that component. [§19.304 of Regulation 19 and 40 CFR Part 63, Subpart MMM, §63.1363(a)]
  - p. When each leak is detected by visual, audible, or olfactory means, or by monitoring as described in §63.180(b) or (c) of subpart H of 40 CFR Part 63, the following requirements apply: A weatherproof and readily visible identification, marked with the equipment identification number, shall be attached to the leaking equipment. The identification on a valve in light liquid or gas/vapor service may be removed after it has been monitored as specified in paragraph (e)(7)(iii) of 63.1363, and no leak has been detected during the follow-up monitoring. If an owner or operator elects to comply with Sec. 63.174(c)(1)(i), the identification on a connector may be removed after it has been monitored as specified in Sec. 63.174(c)(1)(i) and no leak is detected during that monitoring. The identification on equipment, except as specified in paragraph (a)(10)(ii) of 63.1363, may be removed after it has been repaired. [Reg.19.304 and 40 C.F.R. § 63.1363(a)]
  - q. The permittee shall, for all equipment at subject to 40 CFR Subpart MMM, the PAI MACT, comply with the equipment specific standards outlined in 63.1363(c), (d), (e), and (f) of Subpart MMM; and the standards outlined in 63.164, 63.166, 63.169, 63.171, 63.172, 63.174, 63.177, 63.178, and 63.179 of Subpart H. [§19.304 of Regulation 19 and 40 CFR Part 63, Subpart MMM, and Subpart H]
  - r. The permittee shall, for all equipment at Subject to 40 CFR Subpart MMM, the PAI MACT, comply with the testing and procedure requirements as outlined in §63.180 of Subpart H. [§19.304 of Regulation 19 and 40 CFR Part 63, Subpart MMM, and Subpart H]
  - s. The permittee shall maintain records to show compliance with the equipment leak standards of 40 CFR Subpart MMM. These records must comply with the

provisions of 63.1363(g). [§19.304 of Regulation 19 and 40 CFR Part 63, Subpart MMM, 63.1363(g)]

- t. The permittee shall submit periodic reports to show compliance with the equipment leak standards of 40 CFR Subpart MMM. These reports must comply with the provisions of 63.1363(h). [§19.304 of Regulation 19 and 40 CFR Part 63, Subpart MMM, 63.1363(h)]
- u. The permittee must keep the records of the following items. These records must be kept up-to-date and readily accessible. Each measurement of a control device operating parameter monitored in accordance with § 63.1366 and each measurement of a treatment process parameter monitored in accordance with the provisions of § 63.1362(d). The initial calculations of uncontrolled and controlled emissions of gaseous organic HAP and HCl per batch for each process. The wastewater concentrations and flow rates per POD and process. The number of batches per year for each batch process. The operating hours per year for continuous processes. The number of batches and the number of operating hours for processes that contain both batch and continuous operations. The number of tank turnovers per year, if used in an emissions average or for determining applicability of a new PAI process unit. A description of absolute or hypothetical peak-case operating conditions as determined using the procedures in §63.1365(b)(11). Periods of planned routine maintenance as described in §63.1362(c)(5). Daily schedule or log of each operating scenario updated daily or, at a minimum, each time a different operating scenario is put into operation. All maintenance performed on the air pollution control equipment. [Reg.19.304 and 40 C.F.R. § 63.1367(b)]
- v. The permittee must maintain all records required by 40 CFR Part 63, Subpart MMM for a period of 5 years. [§19.304 of Regulation 19 and §63.1367(a)(1)]
- w. The permittee shall submit periodic reports to the Department. The permittee shall submit Periodic reports semiannually. The first report shall be submitted no later than 240 days after the date the Notification of Compliance Status report is due and shall cover the 6-month period beginning on the date the Notification of Compliance Status report is due. Each subsequent Periodic report shall cover the 6-month period following the preceding period and shall be submitted no later than 60 days after the end of the applicable period. Once the permittee reports excess emissions, the affected source shall follow a quarterly reporting format until a request to reduce reporting frequency is approved. [Reg.19.304 and 40 C.F.R. § 63.1368(g)]

- x. The permittee shall include the following information in the periodic reports required by §63.1368(g). Each Periodic report must include the information in §63.10(e)(3)(vi)(A) through (M) of subpart A of 40 CFR Part 63, as applicable. For each vapor collection system or closed vent system with a bypass line subject to §63.1362(j)(1), records required under § 63.1366(f) of all periods when the vent stream is diverted from the control device through a bypass line. For each vapor collection system or closed vent system with a bypass line subject to §63.1362(j)(2), records required under §63.1366(f) of all periods in which the seal mechanism is broken, the bypass valve position has changed, or the key to unlock the bypass line valve was checked out. For each storage vessel subject to control requirements: The actual periods of planned routine maintenance during the reporting period in which the control device does not meet the specifications of §63.1362(c)(5); and the anticipated periods of planned routine maintenance for the next reporting period. For each PAI process unit that does not meet the definition of primary use, the percentage of the production in the reporting period produced for use as a PAI. Updates to the corrective action plan. Records of process units added to each process unit group, if applicable. Records of redetermination of the primary product for a process unit group. For each inspection conducted in accordance with Sec. 63.1366(h)(2) or (3) during which a leak is detected, the records specify in Sec. 63.1367(h)(4) must be included in the next Periodic report. [Reg.19.304 and 40 C.F.R. § 63.1368(g)]
- y. If the total duration of excess emissions, parameter exceedances, or excursions for the reporting period is 1 percent or greater of the total operating time for the reporting period, or the total continuous monitoring system downtime for the reporting period is 5 percent or greater of the total operating time for the reporting period, the Periodic report must include the following information. Monitoring data, including 15-minute monitoring values as well as daily average values of monitored parameters, for all operating days when the average values were outside the ranges established in the Notification of Compliance Status report or operating permit. Duration of excursions, as defined in §63.1366(b)(7). Operating logs and operating scenarios for all operating days when the values are outside the levels established in the Notification of Compliance Status report or operating permit. When a continuous monitoring system is used, the information required in §63.10(c)(5) through (13) of Subpart A of 40 CFR Part 63. [Reg.19.304 and 40 C.F.R. § 63.1368(g)]
- z. The following information shall be stated in the Periodic report, when applicable: No excess emissions, No exceedances of a parameter, No excursions, No

continuous monitoring system has been inoperative, out of control, repaired, or adjusted. [Reg.19.304 and 40 C.F.R. § 63.1368(g)]

OLD MACT Requirements (40 CFR Part 63 Subpart EEEE)

14. This facility is subject to and shall comply with all applicable provisions of 40 CFR Part 63 Subpart EEEE – *National Emission Standards for Hazardous Air Pollutants for Organic Liquids Distribution*. The requirements of Subpart EEEE as they apply to this facility are summarized below. [Reg.19.304 and 40 C.F.R. § 63.2334]

a. The following tanks are subject to certain limited provisions of 40 CFR Part 63 Subpart EEEE. [Reg.19.304 and 40 C.F.R. § 63.2338]

Associated Unit	Description	Capacity (gal)	Annual average TVP of Total Table 1 OHAP (psia)
Alkyl Bromides	Chilled Methanol Storage (SN-654)	750	N/A – tanks less than 5,000 gal capacity
BOC	Methanol Surge Tank	750	
BOC	Methanol Surge Tank	3,760	
OCP	Toluene Storage	7,392	0.82
OCP	Methanol/Brine Storage Tank (SN-1347)	6,000	3.72

- b. For each tank subject to 40 CFR Part 63 Subpart EEEE with a capacity less than 5,000 gallons, the permittee must maintain documentation that verifies the tanks are not subject to the applicable control requirements. [§63.2343(a)]
- c. For each storage tank subject to 40 CFR Part 63 Subpart EEEE with a capacity greater than 5,000 gallons that does not meet the criteria for control in Table 2 of Subpart EEEE (TT-13-322 and TT-13-324), the permittee must submit the information in §63.2386(c)(1) through (3) and (10)(i) in the notification of compliance status due by October 3, 2007. [§63.2343(b)(1)(i)]
- d. For each storage tank subject to 40 CFR Part 63 Subpart EEEE with a capacity of greater than 5,000 gallons that does not meet the criteria for control in Table 2 of Subpart EEEE, the permittee must keep documentation, including a record of the annual average true vapor pressure of the total Table 1 organic HAP in the stored organic liquid, that verifies the storage tank is not required to be controlled under this subpart. The documentation must be kept up-to-date and must be in a form suitable and readily available for inspection and review in accordance with §63.10(b)(1). [§63.2343(b)(3)]

- e. If any storage tank becomes subject to control under 40 CFR Part 63 Subpart EEEE or any storage tank with a capacity equal to or greater than 5,000 gallons becomes part of the affected source but is not subject to any of the emission limitations, operating limits, or work practice standards of Subpart EEEE since the filing of the Notification of Compliance Status or the most recent compliance report, the permittee must submit a subsequent compliance report in accordance with §63.2343(b)(2). [§63.2343(b)(2)]
- f. For each transfer rack that is subject to 40 CFR Part 63 Subpart EEEE, but only unloads organic liquids, the permittee must maintain documentation which verifies the transfer rack is not subject to any applicable control requirements. [Reg.19.304 and 40 C.F.R. § 63.2343(a)]

Benzene Waste Operations MACT (40 CFR Part 61 Subpart FF)

- 15. The permittee is subject to and shall comply with all applicable provisions of 40 CFR Part 61 Subpart FF – *National Emissions Standard for Benzene Waste Operations*. [§19.304 of Regulation 19 and 40 CFR §61.340(a)]
- 16. The permittee shall submit a report within 90 days after January 7, 1993 to the Administrator which summarizes the regulatory status of each waste stream subject to §61.342 and is determined by the procedures specified in §61.355(c) to contain benzene. Each owner or operator subject to this subpart who has no benzene onsite in wastes, products, by-products, or intermediates shall submit an initial report that is a statement to this effect. If any new sources are constructed which would be subject to Subpart FF, this report shall be submitted prior to initial startup of the new source(s). This report shall contain all of the required information as outlined in §61.357(a)(1) through (4). Great Lakes submitted the required certification on December 3, 1996, that no benzene was onsite in wastes, products, by-products or intermediates. [§19.304 of Regulation 19 and 40 CFR §61.357(a)]

MON MACT (40 CFR Part 63 Subpart FFFF)

- 17. This facility is subject to and shall comply with all applicable provisions of 40 CFR Part 63 Subpart FFFF – *National Emission Standards for Hazardous Air Pollutants for Miscellaneous Organic Chemical Manufacturing*. The requirements of Subpart FFFF as they apply to this facility are summarized below. The process units affected by FFFF are in the table below. [Reg.19.304 and 40 C.F.R. § 63.2435]

Tetrabromobisphenol-A (TBBPA) Process		
Equipment Name	Group Determination	Notes

Tetrabromobisphenol-A (TBBPA) Process		
Equipment Name	Group Determination	Notes
Filter Belt Cloth Wash Tank	Batch Vent	Routed to the Bromine Recovery Unit (BRU) SN-102
MeBr and Chloropicrin Storage Tank	Batch Vent	
MeBr and Chloropicrin Storage Tank	Batch Vent	
TBBPA/MeBr Filter Belt	Continuous Vent	Combined with Group 1 Batch Process Vents – must be treated as a Group 1 batch process vent
TBBPA/MeBr Filter Belt	Continuous Vent	
Re-slurry Tank	Continuous Vent	
Re-slurry Tank	Continuous Vent	
Re-slurry Tank	Continuous Vent	
Bromine Storage Tank	Storage Tank	
Bromine Storage Tank	Storage Tank	
Recycle water Tank	Process Wastewater	
Vacuum Pump Knockout Pot	Process Wastewater	
Vacuum Pump Knockout Pot	Process Wastewater	
MeBr Railcar Loading at AB	Transfer Rack	Routed to the Bromine Recovery Unit (BRU) SN-102
MeBr OSP Trailer Loading	Transfer Rack	
Cooling Tower	Heat Exchange System	
Cooling Tower	Heat Exchange System	

TCO Unit		
Equipment Name	Group Determination	Notes
HCl Storage Tank	Storage Tank	
Cooling Tower	Heat Exchange System	
Cooling Tower	Heat Exchange System	

OCP Unit		
Equipment Name	Group Determination	Notes
35% Hydrazine Storage 850 gal	Storage Tank	
CN-3370a Cooling Tower	Heat Exchange System	
(HE-35-2405)	Halogenated Batch Process Vent	Combined emission stream of continuous process vents, batch process vents, storage tanks, and will be treated as Group 1 batch process vents as allowed by §63.2450(c)(2)(i) and §63.2460(b)(5).
(HE-35-2505)		
Brominator		
Lean TEAB		
TEAT		
Reactor A		
Reactor B1		
Reactor B2		
Wash 1		
Wash 2		



OCP Unit		
Equipment Name	Group Determination	Notes
MeCl Solution		
MeCl Storage		
Wash Water Storage		
Tar Storage		
DCM Decanter		
IPA Product Tank		
Mother Liquor Storage		
Solid/Liquid Separator		
Precipitator		
IPA Storage		
Solids Surge Hopper		
Solvent Recovery		

18. General Requirements

- a. The permittee must be in compliance with the emission limits and work practice standards in tables 1 through 7 of Subpart FFFF at all times, except during periods of startup, shutdown, and malfunction (SSM), and the permittee must meet the requirements specified in §§63.2455 through 63.2490 (or the alternative means of compliance in §63.2495, §63.2500, or §63.2505), except as specified in §63.2450(b) through §63.2450(s). The permittee must meet the notification, reporting, and recordkeeping requirements specified in §§63.2515, 63.2520, and 63.2525. [40 CFR §63.2450(a)]
- b. The permittee must determine if an emission stream is a halogenated vent stream, as defined in §63.2550, by calculating the mass emission rate of halogen atoms in accordance with §63.115(d)(2)(v). Alternatively, the permittee may elect to designate the emission stream as halogenated. [40 CFR §63.2450(b)]
- c. When organic HAP emissions from different emission types ( e.g., continuous process vents, batch process vents, storage tanks, transfer operations, and waste management units) are combined, the permittee must comply with the requirements of 40 CFR §63.2450(c)(1) or (2). [40 CFR §63.2450(c)]
  - (1) The permittee must comply with the applicable requirements of 40 CFR 63 Subpart FFFF for each kind of organic HAP emissions in the stream (e.g., the requirements of table 1 to subpart FFFF for continuous process vents and the requirements of table 4 to subpart FFFF for emissions from storage tanks). [40 CFR §63.2450(c)(1)]
  - (2) The permittee must determine the applicable requirements based on the hierarchy presented in paragraphs (c)(2)(i) through (vi) of 40 CFR

§63.2450(c). For a combined stream, the applicable requirements are specified in the highest-listed paragraph in the hierarchy that applies to any of the individual streams that make up the combined stream. For example, if a combined stream consists of emissions from Group 1 batch process vents and any other type of emission stream, then you must comply with the requirements in paragraph (c)(2)(i) of 40 CFR §63.2450(c) for the combined stream; compliance with the requirements in paragraph (c)(2)(i) of 40 CFR §63.2450(c) constitutes compliance for the other emission streams in the combined stream. Two exceptions are that the permittee must comply with the requirements in table 3 of 40 CFR Part 63 Subpart FFFF and §63.2465 for all process vents with hydrogen halide and halogen HAP emissions, and recordkeeping requirements for Group 2 applicability or compliance are still required ( e.g., the requirement in §63.2525(f) to track the number of batches produced and calculate rolling annual emissions for processes with Group 2 batch process vents). [40 CFR §63.2450(c)(2)]

- (i) The requirements of table 2 to Subpart FFFF and §63.2460 for Group 1 batch process vents, including applicable monitoring, recordkeeping, and reporting.
- (ii) The requirements of table 1 to Subpart FFFF and §63.2455 for continuous process vents that are routed to a control device, as defined in §63.981, including applicable monitoring, recordkeeping, and reporting.
- (iii) The requirements of table 5 to Subpart FFFF and §63.2475 for transfer operations, including applicable monitoring, recordkeeping, and reporting.
- (iv) The requirements of table 7 to Subpart FFFF and §63.2485 for emissions from waste management units that are used to manage and treat Group 1 wastewater streams and residuals from Group 1 wastewater streams, including applicable monitoring, recordkeeping, and reporting.
- (v) The requirements of table 4 to Subpart FFFF and §63.2470 for control of emissions from storage tanks, including applicable monitoring, recordkeeping, and reporting.
- (vi) The requirements of table 1 to Subpart FFFF and §63.2455 for continuous process vents after a recovery device including applicable monitoring, recordkeeping, and reporting.

- d. Reserved
- e. Requirements for control devices [40 CFR §63.2450(e)]
  - (1) Except when complying with §63.2485, if the permittee reduces organic HAP emissions by venting emissions through a closed-vent system to any combination of control devices (except a flare) or recovery devices, the permittee must meet the requirements of §63.982(c) and the requirements referenced therein. [40 CFR §63.2450(e)(1)]
  - (2) Except when complying with §63.2485, if the permittee reduces organic HAP emissions by venting emissions through a closed-vent system to a flare, the permittee must meet the requirements of §63.982(b) and the requirements referenced therein. [40 CFR §63.2450(e)(2)]
  - (3) If the permittee uses a halogen reduction device to reduce hydrogen halide and halogen HAP emissions from halogenated vent streams, the permittee must meet the requirements of §63.994 and the requirements referenced therein. If the permittee used a halogen reduction device before a combustion device, the permittee must determine the halogen atom emission rate prior to the combustion device according to the procedures in §63.115(d)(2)(v). [40 CFR §63.2450(e)(3)]
- f. Reserved
- g. The requirements specified in paragraphs 40 CFR §63.2450(g)(1) through (5) apply instead of or in addition to the requirements specified in subpart SS of 40 CFR Part 63. [40 CFR §63.2450(g)]
  - (1) Conduct gas molecular weight analysis using Method 3, 3A, or 3B in appendix A to part 60 of this chapter. [40 CFR §63.2450(g)(1)]
  - (2) Measure moisture content of the stack gas using Method 4 in appendix A to part 60 of this chapter. [40 CFR §63.2450(g)(2)]
  - (3) Reserved
  - (4) As an alternative to using Method 18, Method 25/25A, or Method 26/26A of 40 CFR part 60, appendix A, to comply with any of the emission limits specified in tables 1 through 7 of 40 CFR Subpart FFFF, the permittee may use Method 320 of 40 CFR part 60, appendix A. When using Method 320, the permittee must follow the analyte spiking procedures of section 13 of Method 320, unless the permittee demonstrates that the complete spiking procedure has been conducted at a similar source. [40 CFR §63.2450(g)(4)]

- (5) Section 63.997(c)(1) does not apply. For the purposes of this subpart, results of all initial compliance demonstrations must be included in the notification of compliance status report, which is due 150 days after the compliance date, as specified in §63.2520(d)(1). [40 CFR §63.2450(g)(5)]
- h. Reserved
- i. When §63.997(e)(2)(iii)(C) requires the permittee to correct the measured concentration at the outlet of a combustion device to 3 percent oxygen if the permittee adds supplemental combustion air, the requirements of 40 CFR §63.2450(i)(1) or (2) apply. [40 CFR §63.2450(i)]
  - (1) The permittee must correct the concentration in the gas stream at the outlet of the combustion device to 3 percent oxygen if the permittee adds supplemental gases, as defined in §63.2550, to the vent stream, or; [40 CFR §63.2450(i)(1)]
  - (2) The permittee must correct the measured concentration for supplemental gases using Equation 1 of §63.2460; the permittee may use process knowledge and representative operating data to determine the fraction of the total flow due to supplemental gas. [40 CFR §63.2450(i)(2)]
- j. Each continuous emissions monitoring system (CEMS) must be installed, operated, and maintained according to the requirements in §63.8 and 40 CFR §63.2450(j)(1) through (5). [40 CFR §63.2450(j)]
  - (1) Each CEMS must be installed, operated, and maintained according to the applicable Performance Specification of 40 CFR part 60, appendix B, and according to 40 CFR §63.2450(j)(2), except as specified in paragraph 40 CFR §63.2450(j)(1)(i). For any CEMS meeting Performance Specification 8, the permittee must also comply with appendix F, procedure 1 of 40 CFR part 60. [40 CFR §63.2450(j)(1)]
    - (i) If the permittee wishes to use a CEMS other than an Fourier Transform Infrared Spectroscopy (FTIR) meeting the requirements of Performance Specification 15 to measure hydrogen halide and halogen HAP before EPA promulgates a Performance Specification for such CEMS, the permittee must prepare a monitoring plan and submit it for approval in accordance with the procedures specified in §63.8. [40 CFR §63.2450(j)(1)(i)]
  - (2) The permittee must determine the calibration gases and reporting units for TOC CEMS in accordance with paragraph 40 CFR §63.2450(j)(2)(i), 40

CFR §63.2450 (j)(ii), or 40 CFR §63.2450 (j)(iii). [40 CFR §63.2450(j)(2)]

- (i) For CEMS meeting Performance Specification 9 or 15 requirements, the permittee must determine the target analyte(s) for calibration using either process knowledge of the control device inlet stream or the screening procedures of Method 18 on the control device inlet stream. [40 CFR §63.2450(j)(2)(i)]
  - (ii) For CEMS meeting Performance Specification 8 used to monitor performance of a combustion device, the permittee must calibrate the instrument on the predominant organic HAP and report the results as carbon (C1), and use Method 25A or any approved alternative as the reference method for the relative accuracy tests. [40 CFR §63.2450(j)(2)(ii)]
  - (iii) For CEMS meeting Performance Specification 8 used to monitor performance of a noncombustion device, the permittee must determine the predominant organic HAP using either process knowledge or the screening procedures of Method 18 on the control device inlet stream, calibrate the monitor on the predominant organic HAP, and report the results as C1. Use Method 18, ASTM D6420–99, or any approved alternative as the reference method for the relative accuracy tests, and report the results as C1. [40 CFR §63.2450(j)(2)(iv)]
- (3) The permittee must conduct a performance evaluation of each CEMS according to the requirements in 40 CFR 63.8 and according to the applicable Performance Specification of 40 CFR part 60, appendix B, except that the schedule in §63.8(e)(4) does not apply, and the results of the performance evaluation must be included in the notification of compliance status report. [40 CFR §63.2450(j)(3)]
- (4) The CEMS data must be reduced to operating day or operating block averages computed using valid data consistent with the data availability requirements specified in §63.999(c)(6)(i)(B) through (D), except monitoring data also are sufficient to constitute a valid hour of data if measured values are available for at least two of the 15-minute periods during an hour when calibration, quality assurance, or maintenance activities are being performed. An operating block is a period of time from the beginning to end of batch operations within a process. Operating block

- averages may be used only for batch process vent data. [40 CFR §63.2450(j)(4)]
- (5) If the permittee adds supplemental gases, the permittee must correct the measured concentrations in accordance with 40 CFR §63.2450(i) and §63.2460(c)(6). [40 CFR §63.2450(j)(5)]
- k. The provisions in paragraphs (k)(1) through (6) of 40 CFR §63.2450 apply in addition to the requirements for continuous parameter monitoring system (CPMS) in subpart SS of this part 63. [40 CFR §63.2450(k)]
- (1) The permittee must record the results of each calibration check and all maintenance performed on the CPMS as specified in §63.998(c)(1)(ii)(A). [40 CFR §63.2450(k)(1)]
- (2) When subpart SS of this part 63 uses the term “a range” or “operating range” of a monitored parameter, it means an “operating limit” for a monitored parameter for the purposes of this subpart. [40 CFR §63.2450(k)(2)]
- (3) As an alternative to continuously measuring and recording pH as specified in §§63.994(c)(1)(i) and 63.998(a)(2)(ii)(D), the permittee may elect to continuously monitor and record the caustic strength of the effluent. For halogen scrubbers used to control only batch process vents the permittee may elect to monitor and record either the pH or the caustic strength of the scrubber effluent at least once per day. [40 CFR §63.2450(k)(3)]
- (4) As an alternative to the inlet and outlet temperature monitoring requirements for catalytic incinerators as specified in §63.988(c)(2) and the related recordkeeping requirements specified in §63.998(a)(2)(ii)(B)( 2 ) and (c)(2)(ii), the permittee may elect to comply with the requirements specified in 40 CFR §63.2450(k)(4)(i) through (iv). [40 CFR §63.2450(k)(4)]
- (i) Monitor and record the inlet temperature as specified in subpart SS of this part 63. [40 CFR §63.2450(k)(4)(i)]
- (ii) Check the activity level of the catalyst at least every 12 months and take any necessary corrective action, such as replacing the catalyst to ensure that the catalyst is performing as designed. [40 CFR §63.2450(k)(4)(ii)]
- (iii) Maintain records of the annual checks of catalyst activity levels and the subsequent corrective actions. [40 CFR §63.2450(k)(4)(iii)]

- (iv) Recording the downstream temperature and temperature difference across the catalyst bed as specified in §63.998(a)(2)(ii)(B)( 2 ) and (b)(2)(ii) is not required. [40 CFR §63.2450(k)(4)(iv)]
- (5) For absorbers that control organic compounds and use water as the scrubbing fluid, the permittee must conduct monitoring and recordkeeping as specified 40 CFR §63.2450(k)(5)(i) through (iii) instead of the monitoring and recordkeeping requirements specified in §§63.990(c)(1), 63.993(c)(1), and 63.998(a)(2)(ii)(C). [40 CFR §63.2450(k)(5)]
  - (i) The permittee must use a flow meter capable of providing a continuous record of the absorber influent liquid flow. [40 CFR §63.2450(k)(5)(i)]
  - (ii) The permittee must determine gas stream flow using one of the procedures specified in §63.994(c)(1)(ii)(A) through (D). [40 CFR §63.2450(k)(5)(ii)]
  - (iii) The permittee must record the absorber liquid-to-gas ratio averaged over the time period of any performance test. [40 CFR §63.2450(k)(5)(iii)]
- (6) For a control device with total inlet HAP emissions less than 1 tpy, the permittee must establish an operating limit(s) for a parameter(s) that the permittee will measure and record at least once per averaging period (i.e., daily or block) to verify that the control device is operating properly. The permittee may elect to measure the same parameter(s) that is required for control devices that control inlet HAP emissions equal to or greater than 1 tpy. If the parameter will not be measured continuously, The permittee must request approval of the proposed procedure in the precompliance report. The permittee must identify the operating limit(s) and the measurement frequency, and the permittee must provide rationale to support how these measurements demonstrate the control device is operating properly. [40 CFR §63.2450(k)(6)]
  - l. Reserved
  - m. Reserved
  - n. Reserved
  - o. Reserved
  - p. Reserved
  - q. Reserved

- r. For each surge control vessel or bottoms receiver that meets the capacity and vapor pressure thresholds for a Group 1 storage tank, the permittee must meet emission limits and work practice standards specified in Table 4 to this subpart. [40 CFR §63.2450(r)]

19. Continuous Process Vent Requirements (TBBPA Unit)

- a. The permittee must meet each emission limit in the following table that applies to the continuous process vents. [40 CFR §63.2455(a)]

For Each	For Which	Great Lakes Must
Group 1 continuous process vent		<ul style="list-style-type: none"> <li>i. Reduce emissions of total OHAP by <math>\geq 98\%</math> by weight or to an outlet concentration of <math>\leq 20</math> ppmv as OHAP or TOC by venting emissions through a closed vent system to any combination of control devices (except a flare): or</li> <li>ii. Reduce emissions of total organic HAP by venting emissions through a closed vent system to a flare; or</li> <li>iii. Use a recovery device to maintain the TRE above 1.9</li> </ul>
Halogenated Group 1 Continuous Process Vent	A combustion control device is used to control organic HAP emissions.	<ul style="list-style-type: none"> <li>i. Use a halogen reduction device after the combustion device to reduce emissions of hydrogen halide and halogen HAP by <math>\geq 99\%</math> by weight, or to <math>\leq 0.45</math> kg/hr, or to <math>\leq 20</math> ppmv; or</li> <li>ii. Use a halogen reduction device before the combustion device to reduce the halogen atom mass emission rate to <math>\leq 0.45</math> kg/hr, or to <math>\leq 20</math> ppmv.</li> </ul>
Group 2 continuous process vent	A recovery device is used to maintain the TRE level $> 1.9$ but $\leq 5.0$ .	Comply with Subpart SS recovery device monitoring requirements

- b. For each continuous process vent, the permittee must either designate the vent as a Group 1 continuous process vent or determine the total resource effectiveness (TRE) index value as specified in §63.115(d), except as specified in 40 CFR §63.2455(b)(1) through (3). [40 CFR §63.2455(b)]
  - (1) The permittee is not required to determine the Group status or the TRE index value for any continuous process vent that is combined with Group 1 batch process vents before a control device or recovery device because



the requirements of §63.2450(c)(2)(i) apply to the combined stream. [40 CFR §63.2455(b)(1)]

- (2) When a TRE index value of 4.0 is referred to in §63.115(d), TRE index values of 5.0 for existing affected sources and 8.0 for new and reconstructed affected sources apply for the purposes of this subpart. [40 CFR §63.2455(b)(2)]
- (3) When §63.115(d) refers to “emission reductions specified in §63.113(a),” the reductions specified in Table 1 to this subpart apply for the purposes of this subpart. [40 CFR §63.2455(b)(3)]

c. If the permittee uses a recovery device to maintain the TRE above a specified threshold, the permittee must meet the requirements of §63.982(e) and the requirements referenced therein, except as specified in §63.2450 and 40 CFR §63.2455(c)(1). [40 CFR §63.2455(c)]

- (1) When §63.993 uses the phrase “the TRE index value is between the level specified in a referencing subpart and 4.0,” the phrase “the TRE index value is >1.9 but ≤5.0” applies for an existing affected source, and the phrase “the TRE index value is >5.0 but ≤8.0” applies for a new and reconstructed affected source, for the purposes of this subpart. [40 CFR §63.2455(c)(1)]

20. Batch Process Vent Requirements (TBBPA Unit and OCP Unit)

a. The permittee must meet each emission limit in the following table that applies to the batch process vents. [40 CFR §63.2460(a)]

For Each	For Which	Great Lakes Must
Process with Group 1 batch process vent	a. Reduce collective uncontrolled OHAP emissions from the sum of all batch process vents within the process by ≥98% by weight by venting emissions from a sufficient number of the vents through a closed-vent system to any combination of control devices (except a flare); or  b. Reduce collective uncontrolled OHAP emissions from the sum of all batch process vents within the process by ≥95% by weight by venting emissions from a sufficient number of vents through a closed-vent system to any combination of recovery devices; or	

For Each	For Which	Great Lakes Must
	c. For vents with neither a flare nor the alternative standard in §63.2505 is used to reduce OHAP to $\leq 20$ ppm as TOC, use a combination of a. or b. above to achieve at least 98% control or 95% recovery.	
Halogenated Group 1 Continuous Process Vent	a. Use a halogen reduction device after the combustion control device; or.	Reduce emissions of hydrogen halide and halogen HAP by $\geq 99\%$ by weight, or to $\leq 0.45$ kg/hr, or $\leq 20$ ppmv; or
	b. Use a halogen reduction device before the combustion control device.	Comply with Subpart SS recovery device monitoring requirements

- b. If a process has batch process vents, as defined in §63.2550, the permittee must determine the group status of the batch process vents by determining and summing the uncontrolled organic HAP emissions from each of the batch process vents within the process using the procedures specified in §63.1257(d)(2)(i) and (ii), except as specified in paragraphs (b)(1) through (7) of 40 CFR §63.2460. [40 CFR §63.2460(b)]
- (1) To calculate emissions caused by the heating of a vessel without a process condenser to a temperature lower than the boiling point, the permittee must use the procedures in §63.1257(d)(2)(i)(C)(3). [40 CFR §63.2460(b)(1)]
  - (2) To calculate emissions from depressurization of a vessel without a process condenser, the permittee must use the procedures in §63.1257(d)(2)(i)(D)(10). [40 CFR §63.2460(b)(2)]
  - (3) To calculate emissions from vacuum systems for the purposes of this subpart, the receiving vessel is part of the vacuum system, and terms used in Equation 33 to 40 CFR part 63, subpart GGG, are defined as follows: [40 CFR §63.2460(b)(3)]

$P_{\text{system}}$  = absolute pressure of the receiving vessel;

$P_i$  = partial pressure of the HAP determined at the exit temperature and exit pressure conditions of the condenser or at the conditions of the dedicated receiver;

$P_j$  = partial pressure of condensables (including HAP) determined at the exit temperature and exit pressure conditions of the condenser or at the conditions of the dedicated receiver;

MWHAP= molecular weight of the HAP determined at the exit temperature and exit pressure conditions of the condenser or at the conditions of the dedicated receiver.

- (4) To calculate uncontrolled emissions when a vessel is equipped with a process condenser, the permittee must use the procedures in §63.1257(d)(3)(i)(B), except as specified in paragraphs (b)(4)(i) through (vii) of 40 CFR §63.2460. [40 CFR §63.2460(b)(4)]
- (i) The permittee must determine the flowrate of gas (or volume of gas), partial pressures of condensables, temperature (T), and HAP molecular weight (MWHAP) at the exit temperature and exit pressure conditions of the condenser or at the conditions of the dedicated receiver. [40 CFR §63.2460(b)(4)(i)]
  - (ii) The permittee must assume that all of the components contained in the condenser exit vent stream are in equilibrium with the same components in the exit condensate stream (except for noncondensables). [40 CFR §63.2460(b)(4)(ii)]
  - (iii) The permittee must perform a material balance for each component. [40 CFR §63.2460(b)(4)(iii)]
  - (iv) For the emissions from gas evolution, the term for time, t, must be used in Equation 12 to 40 CFR part 63, subpart GGG. [40 CFR §63.2460(b)(4)(iv)]
  - (v) Emissions from empty vessel purging shall be calculated using Equation 36 to 40 CFR part 63, subpart GGG and the exit temperature and exit pressure conditions of the condenser or the conditions of the dedicated receiver. [40 CFR §63.2460(b)(4)(v)]
  - (vi) The permittee must conduct an engineering assessment as specified in §63.1257(d)(2)(ii) for each emission episode that is not due to vapor displacement, purging, heating, depressurization, vacuum operations, gas evolution, air drying, or empty vessel purging. The requirements of paragraphs (b)(3) through (4) of 40 CFR §63.2460 shall apply. [40 CFR §63.2460(b)(4)(vi)]
  - (vii) The permittee may elect to conduct an engineering assessment if the permittee can demonstrate to the Administrator that the methods in §63.1257(d)(3)(i)(B) are not appropriate. [40 CFR §63.2460(b)(4)(vii)]
- (5) The permittee may elect to designate the batch process vents within a process as Group 1 and not calculate uncontrolled emissions under either

of the situations in paragraph (b)(5)(i), (ii), or (iii) of 40 CFR §63.2460.  
[40 CFR §63.2460(b)(5)]

- (i) If the permittee complies with the alternative standard specified in §63.2505. [40 CFR §63.2460(b)(5)(i)]
  - (ii) If all Group 1 batch process vents within a process are controlled; the permittee conducts the performance test under hypothetical worst case conditions, as defined in §63.1257(b)(8)(i)(B); and the emission profile is based on capture and control system limitations as specified in §63.1257(b)(8)(ii)(C). [40 CFR §63.2460(b)(5)(ii)]
  - (iii) If the permittee complies with an emission limit using a flare that meets the requirements specified in §63.987. [40 CFR §63.2460(b)(5)(iii)]
- (6) The permittee may change from Group 2 to Group 1 in accordance with either paragraph (b)(6)(i) or (ii) of 40 CFR §63.2460. The permittee must comply with the requirements of 40 CFR §63.2460 and submit the test report in the next Compliance report. [40 CFR §63.2460(b)(6)]
- (i) The permittee may switch at any time after operating as Group 2 for at least 1 year so that the permittee can show compliance with the 10,000 pounds per year (lb/yr) threshold for Group 2 batch process vents for at least 365 days before the switch. The permittee may elect to start keeping records of emissions from Group 2 batch process vents before the compliance date. Report a switch based on this provision in the next compliance report in accordance with §63.2520(e)(10)(i). [40 CFR §63.2460(b)(6)(i)]
  - (ii) If the conditions in paragraph (b)(6)(i) of this section are not applicable, the permittee must provide a 60-day advance notice in accordance with §63.2520(e)(10)(ii) before switching. [40 CFR §63.2460(b)(6)(ii)]
- (7) As an alternative to determining the uncontrolled organic HAP emissions as specified in §63.1257(d)(2)(i) and (ii), the permittee may elect to demonstrate that non-reactive organic HAP are the only HAP used in the process and non-reactive HAP usage in the process is less than 10,000 lb/yr. the permittee must provide data and supporting rationale in the permittee's notification of compliance status report explaining why the non-reactive organic HAP usage will be less than 10,000 lb/yr. the permittee must keep records of the non-reactive organic HAP usage as

specified in §63.2525(e)(2) and include information in compliance reports as specified in §63.2520(e)(5)(iv). [40 CFR §63.2460(b)(7)]

- c. Exceptions to the requirements in subparts SS and WW of this part 63 are specified in paragraphs (c)(1) through (9) of 40 CFR §63.2460. [40 CFR §63.2460(c)]
- (1) Process condensers, as defined in §63.2550(i), are not considered to be control devices for batch process vents. The permittee must determine whether a condenser is a control device for a batch process vent or a process condenser from which the uncontrolled HAP emissions are evaluated as part of the initial compliance demonstration for each MCPU and report the results with supporting rationale in the notification of compliance status report. [40 CFR §63.2460(c)(1)]
  - (2) Initial compliance.
    - (i) To demonstrate initial compliance with a percent reduction emission limit in Table 2 to this subpart FFFF, the permittee must compare the sums of the controlled and uncontrolled emissions for the applicable Group 1 batch process vents within the process, and show that the specified reduction is met. This requirement does not apply if the permittee complies with the emission limits of Table 2 of FFFF by using a flare that meets the requirements of §63.987. [40 CFR §63.2460(c)(2)(i)]
    - (ii) When the permittee conducts a performance test or design evaluation for a non-flare control device used to control emissions from batch process vents, the permittee must establish emission profiles and conduct the test under worst-case conditions according to §63.1257(b)(8) instead of under normal operating conditions as specified in §63.7(e)(1). The requirements in §63.997(e)(1)(i) and (iii) also do not apply for performance tests conducted to determine compliance with the emission limits for batch process vents. For purposes of this subpart FFFF, references in §63.997(b)(1) to “methods specified in §63.997(e)” include the methods specified in §63.1257(b)(8). [40 CFR §63.2460(c)(2)(ii)]
    - (iii) As an alternative to conducting a performance test or design evaluation to demonstrate initial compliance with a percent reduction requirement for a condenser, the permittee may determine controlled emissions using the procedures specified in

- §63.1257(d)(3)(i)(B) and paragraphs (b)(3) through (4) of this section. [40 CFR §63.2460(c)(2)(iii)]
- (iv) When §63.1257(d)(3)(i)(B)( 7 ) specifies that condenser-controlled emissions from an air dryer must be calculated using Equation 11 of 40 CFR part 63, subpart GGG, with “V equal to the air flow rate,” it means “V equal to the dryer outlet gas flow rate,” for the purposes of this subpart. Alternatively, the permittee may use Equation 12 of 40 CFR part 63, subpart GGG, with V equal to the dryer inlet air flow rate. Account for time as appropriate in either equation. [40 CFR §63.2460(c)(2)(iv)]
  - (v) If a process condenser is used for any boiling operations, the permittee must demonstrate that it is properly operated according to the procedures specified in §63.1257(d)(2)(i)(C)( 4 )( ii ) and (d)(3)(iii)(B), and the demonstration must occur only during the boiling operation. The reference in §63.1257(d)(3)(iii)(B) to the alternative standard in §63.1254(c) means §63.2505 for the purposes of this subpart. As an alternative to measuring the exhaust gas temperature, as required by §63.1257(d)(3)(iii)(B), the permittee may elect to measure the liquid temperature in the receiver. [40 CFR §63.2460(c)(2)(v)]
  - (vi) The permittee must conduct a subsequent performance test or compliance demonstration equivalent to an initial compliance demonstration within 180 days of a change in the worst-case conditions. [40 CFR §63.2460(c)(2)(vi)]
- (3) The permittee must establish operating limits under the conditions required for the initial compliance demonstration, except the permittee may elect to establish operating limit(s) for conditions other than those under which a performance test was conducted as specified in paragraph (c)(3)(i) of 40 CFR §63.2460 and, if applicable, paragraph (c)(3)(ii) of 40 CFR §63.2460. [40 CFR §63.2460(c)(3)]
- (i) The operating limits may be based on the results of the performance test and supplementary information such as engineering assessments and manufacturer's recommendations. These limits may be established for conditions as unique as individual emission episodes for a batch process. The permittee must provide rationale in the precompliance report for the specific level for each operating limit, including any data and calculations

used to develop the limit and a description of why the limit indicates proper operation of the control device. The procedures provided in this paragraph (c)(3)(i) have not been approved by the Administrator and determination of the operating limit using these procedures is subject to review and approval by the Administrator. [40 CFR §63.2460(c)(3)(i)]

- (ii) If the permittee elects to establish separate monitoring levels for different emission episodes within a batch process, the permittee must maintain records in the daily schedule or log of processes indicating each point at which the permittee changes from one operating limit to another, even if the duration of the monitoring for an operating limit is less than 15 minutes. The permittee must maintain a daily schedule or log of processes according to §63.2525(c). [40 CFR §63.2460(c)(3)(ii)]
- (4) As an alternative to the requirement for daily averages in §63.998(b)(3), the permittee may determine averages for operating blocks. An operating block is a period of time that is equal to the time from the beginning to end of batch process operations within a process. [40 CFR §63.2460(c)(4)]
- (5) [Reserved]
- (6) Outlet concentration correction for supplemental gases. If the permittee uses a control device other than a combustion device to comply with a TOC, organic HAP, or hydrogen halide and halogen HAP outlet concentration emission limit for batch process vents, the permittee must correct the actual concentration for supplemental gases using Equation 1 of 40 CFR §63.2460; the permittee may use process knowledge and representative operating data to determine the fraction of the total flow due to supplemental gas. [40 CFR §63.2460(c)(6)]

$$C_a = C_m * \left( \frac{Q_s - Q_a}{Q_a} \right)$$

Where:

$C_a$ = corrected outlet TOC, organic HAP, or hydrogen halide and halogen HAP concentration, dry basis, ppmv;

$C_m$ = actual TOC, organic HAP, or hydrogen halide and halogen HAP concentration measured at control device outlet, dry basis, ppmv;

$Q_a$ = total volumetric flowrate of all gas streams vented to the control device, except supplemental gases;

$Q_s$  = total volumetric flowrate of supplemental gases.

- (7) If flow to a control device could be intermittent, the permittee must install, calibrate, and operate a flow indicator at the inlet or outlet of the control device to identify periods of no flow. Periods of no flow may not be used in daily or block averages, and it may not be used in fulfilling a minimum data availability requirement. [40 CFR §63.2460(c)(7)]
- (8) Terminology. When the term “storage vessel” is used in subpart WW of this part 63, the term “process tank,” as defined in §63.2550(i), applies for the purposes of this section. [40 CFR §63.2460(c)(8)]
- (9) Reserved.

21. Storage Tank Requirements for TCO

- a. The permittee must meet each emission limit in table for the storage tanks, and the permittee must meet each applicable requirement specified in paragraphs (b) through (e) of 40 CFR §63.2470. [40 CFR §63.2470(a)]

For Each	For Which	GLCC Must
Group 1 storage tank	The maximum true vapor pressure of HAP at the storage temperature is $\leq 76.6$ kPa	<ul style="list-style-type: none"> <li>i. Comply with the requirements of subpart WW of this part, except as specified in §63.2470; or</li> <li>ii. Reduce total HAP emissions by <math>\geq 95</math> percent by weight or to <math>\leq 20</math> ppmv of TOC or organic HAP and <math>\leq 20</math> ppmv of hydrogen halide and halogen HAP by venting emissions through a closed vent system to any combination of control devices (excluding a flare); or</li> <li>iii. Reduce total organic HAP emissions by venting emissions through a closed vent system to a flare; or</li> <li>iv. Reduce total HAP emissions by venting emissions to a fuel gas system or process in accordance with §63.982(d) and the requirements referenced therein.</li> </ul>
Halogenated vent stream from a Group 1 storage tank	A combustion control device to control organic HAP emissions	<ul style="list-style-type: none"> <li>i. Use a halogen reduction device after the combustion device to reduce emissions of hydrogen halide and halogen HAP by <math>\geq 99</math> percent by weight, or to <math>\leq 0.45</math> kg/hr, or to <math>\leq 20</math> ppmv; or</li> <li>ii. Use a halogen reduction device before the combustion device to reduce the halogen atom mass emission rate to <math>\leq 0.45</math> kg/hr or to a concentration <math>\leq 20</math> ppmv.</li> </ul>



- b. [Reserved]
- c. Exceptions to subparts SS and WW of this part 63. [40 CFR §63.2470(c)]
  - (1) If the permittee conducts a performance test or design evaluation for a control device used to control emissions only from storage tanks, the permittee must establish operating limits, conduct monitoring, and keep records using the same procedures as required in subpart SS of this part 63 for control devices used to reduce emissions from process vents instead of the procedures specified in §§63.985(c), 63.998(d)(2)(i), and 63.999(b)(2). [40 CFR §63.2470(c)(1)]
  - (2) When the term “storage vessel” is used in subparts SS and WW of this part 63, the term “storage tank,” as defined in §63.2550 applies for the purposes of this subpart. [40 CFR §63.2470(c)(2)]
- d. The emission limits in Table 4 to this subpart for control devices used to control emissions from storage tanks do not apply during periods of planned routine maintenance. Periods of planned routine maintenance of each control device, during which the control device does not meet the emission limit specified in Table 4 to this subpart, must not exceed 240 hours per year (hr/yr). The permittee may submit an application to the Administrator requesting an extension of this time limit to a total of 360 hr/yr. The application must explain why the extension is needed, it must indicate that no material will be added to the storage tank between the time the 240-hr limit is exceeded and the control device is again operational, and it must be submitted at least 60 days before the 240-hr limit will be exceeded. [40 CFR §63.2470(d)]
- e. As an alternative to the emission limits specified in Table 4 to this subpart, the permittee may elect to implement vapor balancing in accordance with §63.1253(f), except as specified in paragraphs (e)(1) through (3) of 40 CFR §63.2470. [40 CFR §63.2470(e)]
  - (1) When §63.1253(f)(6)(i) refers to a 90 percent reduction, 95 percent applies for the purposes of this subpart. [40 CFR §63.2470(e)(1)]
  - (2) To comply with §63.1253(f)(6)(i), the owner or operator of an offsite cleaning or reloading facility must comply with §§63.2445 through 63.2550 instead of complying with §63.1253(f)(7)(ii), except as specified in paragraph (e)(2)(i) or (ii) of 40 CFR §63.2470. [40 CFR §63.2470(e)(2)]

- (i) The reporting requirements in §63.2520 do not apply to the owner or operator of the offsite cleaning or reloading facility. [40 CFR §63.2470(e)(2)(i)]
- (ii) As an alternative to complying with the monitoring, recordkeeping, and reporting provisions in §§63.2445 through 63.2550, the owner or operator of an offsite cleaning or reloading facility may comply as specified in §63.2535(a)(2) with any other subpart of this part 63 which has monitoring, recordkeeping, and reporting provisions as specified in §63.2535(a)(2). [40 CFR §63.2470(e)(2)(ii)]
- (3) The permittee may elect to set a pressure relief device to a value less than the 2.5 pounds per square inch gage pressure (psig) required in §63.1253(f)(5) if the permittee provides rationale in the notification of compliance status report explaining why the alternative value is sufficient to prevent breathing losses at all times. [40 CFR §63.2470(e)(3)]
- (4) The permittee may comply with the vapor balancing alternative in §63.1253(f) when the storage tank is filled from a barge. All requirements for tank trucks and railcars specified in §63.1253(f) also apply to barges, except as specified in §63.2470(e)(4)(i). [40 CFR §63.2470(e)(4)]
  - (i) When §63.1253(f)(2) refers to pressure testing certifications, the requirements in 40 CFR 61.304(f) apply for barges. [40 CFR §63.2470(e)(4)(i)]

22. Equipment Leak Requirements

- a. The permittee must meet each requirement in following table that applies to the permittee’s equipment leaks, except as specified in paragraphs (b) through (d) of 40 CFR §63.2480. [40 CFR §63.2480(a)]

For All	GLCC Must
Equipment that is in organic HAP Service (TBBPA and TOC Units)	<ul style="list-style-type: none"> <li>a. Comply with the requirements of subpart UU of this part 63 and the requirements referenced therein, except as specified in §63.2480(b) and (d); or</li> <li>b. Comply with the requirements of subpart H of this part 63 and the requirements referenced therein, except as specified in §63.2480(b) and (d); or</li> <li>c. Comply with the requirements of 40 CFR part 65, subpart F and the requirements referenced therein, except as specified in §63.2480(c) and (d).</li> </ul>

For All	GLCC Must
Equipment that is in organic HAP service at a new source (OCP Unit)	a. Comply with the requirements of Subpart UU of 40 CFR Part 63 and the requirements referenced therein; or b. Comply with the requirements of Subpart F of 40 CFR Part 65 and the requirements referenced therein, except as specified in §63.2480(c) and (d).

- b. If the permittee complies with either subpart H or subpart UU of this part 63, the permittee may elect to comply with the provisions in paragraphs (b)(1) through (5) of this section as an alternative to the referenced provisions in subpart H or subpart UU of 40 CFR Part 63. [40 CFR §63.2480(b)]
- (1) The requirements for pressure testing in §63.179(b) or §63.1036(b) may be applied to all processes, not just batch processes. [40 CFR §63.2480(b)(1)]
  - (2) For the purposes of this subpart, pressure testing for leaks in accordance with §63.179(b) or §63.1036(b) is not required after reconfiguration of an equipment train if flexible hose connections are the only disturbed equipment. [40 CFR §63.2480(b)(2)]
  - (3) For an existing source, the permittee is not required to develop an initial list of identification numbers for connectors as would otherwise be required under §63.1022(b)(1) or §63.181(b)(1)(i). [40 CFR §63.2480(b)(3)]
  - (4) For connectors in gas/vapor and light liquid service at an existing source, the permittee may elect to comply with the requirements in §63.169 or §63.1029 for connectors in heavy liquid service, including all associated recordkeeping and reporting requirements, rather than the requirements of §63.174 or §63.1027. [40 CFR §63.2480(b)(4)]
  - (5) For pumps in light liquid service in an MCPU that has no continuous process vents and is part of an existing source, the permittee may elect to consider the leak definition that defines a leak to be 10,000 parts per million (ppm) or greater as an alternative to the values specified in §63.1026(b)(2)(i) through (iii) or §63.163(b)(2). [40 CFR §63.2480(b)(5)]
- c. If the permittee complies with 40 CFR part 65, subpart F, the permittee may elect to comply with the provisions in paragraphs (c)(1) through (9) of this section as an alternative to the referenced provisions in 40 CFR part 65, subpart F. [40 CFR §63.2480(c)]
- (1) The requirements for pressure testing in §65.117(b) may be applied to all processes, not just batch processes. [40 CFR §63.2480(c)(1)]

- (2) For the purposes of this subpart, pressure testing for leaks in accordance with §65.117(b) is not required after reconfiguration of an equipment train if flexible hose connections are the only disturbed equipment. [40 CFR §63.2480(c)(2)]
- (3) For an existing source, the permittee is not required to develop an initial list of identification numbers for connectors as would otherwise be required under §65.103(b)(1). [40 CFR §63.2480(c)(3)]
- (4) The permittee may elect to comply with the monitoring and repair requirements specified in §65.108(e)(3) as an alternative to the requirements specified in §65.108(a) through (d) for any connectors at the affected source. [40 CFR §63.2480(c)(4)]
- (5) For pumps in light liquid service in an MCPU that has no continuous process vents and is part of an existing source, the permittee may elect to consider the leak definition that defines a leak to be 10,000 ppm or greater as an alternative to the values specified in §65.107(b)(2)(i) through (iii). [40 CFR §63.2480(c)(5)]
- (6) When 40 CFR part 65, subpart F refers to the implementation date specified in §65.1(f), it means the compliance date specified in §63.2445. [40 CFR §63.2480(c)(6)]
- (7) When §§65.105(f) and 65.117(d)(3) refer to §65.4, it means §63.2525. [40 CFR §63.2480(c)(7)]
- (8) When §65.120(a) refers to §65.5(d), it means §63.2515. [40 CFR §63.2480(c)(8)]
- (9) When §65.120(b) refers to §65.5(e), it means §63.2520. [40 CFR §63.2480(c)(9)]

d. The provisions of this section do not apply to bench-scale processes, regardless of whether the processes are located at the same plant site as a process subject to the provisions of this subpart. [40 CFR §63.2480(d)]

23. Heat Exchange System Requirements for TBBPA, TOC, and OCP Units

a. The permittee must comply with each requirement in the following table that applies to the permittee's heat exchange systems, except as specified in paragraphs (b) and (c) of 40 CFR §63.2490. [40 CFR §63.2490(a)]

For each	GLCC must
Heat exchange system, as defined in 63.101	Comply with the requirements of 63.104 and the requirements referenced therein, except as specified in

For each	GLCC must
	63.2490

- b. The phrase “a chemical manufacturing process unit meeting the conditions of §63.100 (b)(1) through (b)(3) of this section” in §63.104(a) means “an MCPU meeting the conditions of §63.2435” for the purposes of this subpart. [40 CFR §63.2490(b)]
- c. Unless one or more of the conditions specified in paragraphs (a)(1) through (a)(6) of this section are met, the permittee shall monitor each heat exchange system used to cool process equipment in a chemical manufacturing process unit meeting the conditions of §63.100(b)(1) through (b)(3) of Subpart FF, except for chemical manufacturing process units meeting the condition specified in §63.100(c) of Subpart FF, according to the provisions in either paragraph (b) or (c) of 40 CFR §63.104. Whenever a leak is detected, the permittee shall comply with the requirements in paragraph (d) of 40 CFR §63.104. [40 CFR §63.104(a)]
- (1) The heat exchange system is operated with the minimum pressure on the cooling water side at least 35 kilopascals greater than the maximum pressure on the process side. [40 CFR §63.104(a)(1)]
  - (2) There is an intervening cooling fluid, containing less than 5 percent by weight of total hazardous air pollutants listed in table 4 of this subpart, between the process and the cooling water. This intervening fluid serves to isolate the cooling water from the process fluid and the intervening fluid is not sent through a cooling tower or discharged. For purposes of this section, discharge does not include emptying for maintenance purposes. [40 CFR §63.104(a)(2)]
  - (3) The once-through heat exchange system is subject to a National Pollution Discharge Elimination System (NPDES) permit with an allowable discharge limit of 1 part per million or less above influent concentration or 10 percent or less above influent concentration, whichever is greater. [40 CFR §63.104(a)(3)]
  - (4) The once-through heat exchange system is subject to an NPDES permit that: [40 CFR §63.104(a)(4)]
    - (i) Requires monitoring of a parameter(s) or condition(s) to detect a leak of process fluids into cooling water; [40 CFR §63.104(a)(4)(i)]
    - (ii) Specifies or includes the normal range of the parameter or condition; [40 CFR §63.104(a)(4)(ii)]

- (iii) Requires monitoring for the parameters selected as leak indicators no less frequently than monthly for the first six months and quarterly thereafter; and [40 CFR §63.104(a)(4)(iii)]
    - (iv) Requires the permittee to report and correct leaks to the cooling water when the parameter or condition exceeds the normal range. [40 CFR §63.104(a)(4)(iv)]
  - (5) The recirculating heat exchange system is used to cool process fluids that contain less than 5 percent by weight of total hazardous air pollutants listed in table 4 of this subpart. [40 CFR §63.105(a)(5)]
  - (6) The once-through heat exchange system is used to cool process fluids that contain less than 5 percent by weight of total hazardous air pollutants listed in table 9 of subpart G of this part. [40 CFR §63.104(a)(6)]
- d. The permittee can elect to comply with the requirements of paragraph (a) of 40 CFR §63.104 by monitoring the cooling water for the presence of one or more organic hazardous air pollutants or other representative substances whose presence in cooling water indicates a leak shall comply with the requirements specified in paragraphs (b)(1) through (b)(6) of 40 CFR §63.104. The cooling water shall be monitored for total hazardous air pollutants, total volatile organic compounds, total organic carbon, one or more speciated HAP compounds, or other representative substances that would indicate the presence of a leak in the heat exchange system. [40 CFR §63.104(b)]
  - (1) The cooling water shall be monitored monthly for the first 6 months and quarterly thereafter to detect leaks. [40 CFR §63.104(b)(1)]
  - (2) Reserved
    - (i) For recirculating heat exchange systems (cooling tower systems), the monitoring of speciated hazardous air pollutants or total hazardous air pollutants refers to the hazardous air pollutants listed in table 4 of this subpart. [40 CFR §63.104(b)(2)(i)]
    - (ii) For once-through heat exchange systems, the monitoring of speciated hazardous air pollutants or total hazardous air pollutants refers to the hazardous air pollutants listed in table 9 of subpart G of this part. [40 CFR §63.104(b)(2)(ii)]
  - (3) The concentration of the monitored substance(s) in the cooling water shall be determined using any EPA-approved method listed in part 136 of 40 CFR as long as the method is sensitive to concentrations as low as 10 parts per million and the same method is used for both entrance and exit

- samples. Alternative methods may be used upon approval by the Administrator. [40 CFR §63.104(b)(3)]
- (4) The samples shall be collected either at the entrance and exit of each heat exchange system or at locations where the cooling water enters and exits each heat exchanger or any combination of heat exchangers. [40 CFR §63.104(b)(4)]
- (i) For samples taken at the entrance and exit of recirculating heat exchange systems, the entrance is the point at which the cooling water leaves the cooling tower prior to being returned to the process equipment and the exit is the point at which the cooling water is introduced to the cooling tower after being used to cool the process fluid. [40 CFR §63.104(b)(4)(i)]
- (ii) For samples taken at the entrance and exit of once-through heat exchange systems, the entrance is the point at which the cooling water enters and the exit is the point at which the cooling water exits the plant site or chemical manufacturing process units. [40 CFR §63.104(b)(4)(ii)]
- (iii) For samples taken at the entrance and exit of each heat exchanger or any combination of heat exchangers in chemical manufacturing process units, the entrance is the point at which the cooling water enters the individual heat exchanger or group of heat exchangers and the exit is the point at which the cooling water exits the heat exchanger or group of heat exchangers. [40 CFR §63.104(b)(4)(iii)]
- (5) A minimum of three sets of samples shall be taken at each entrance and exit as defined in paragraph (b)(4) of this section. The average entrance and exit concentrations shall then be calculated. The concentration shall be corrected for the addition of any makeup water or for any evaporative losses, as applicable. [40 CFR §63.104(b)(5)]
- (6) A leak is detected if the exit mean concentration is found to be greater than the entrance mean using a one-sided statistical procedure at the 0.05 level of significance and the amount by which it is greater is at least 1 part per million or 10 percent of the entrance mean, whichever is greater. [40 CFR §63.104(b)(6)]
- e. The permittee who elects to comply with the requirement of paragraph (a) of 40 CFR §63.104 by monitoring using a surrogate indicator of heat exchange system leaks shall comply with the requirements specified in paragraphs (c)(1) through

- (c)(3) of 40 CFR §63.104. Surrogate indicators that could be used to develop an acceptable monitoring program are ion specific electrode monitoring, pH, conductivity or other representative indicators. [40 CFR §63.104(c)]
- (1) The permittee shall prepare and implement a monitoring plan that documents the procedures that will be used to detect leaks of process fluids into cooling water. The plan shall require monitoring of one or more surrogate indicators or monitoring of one or more process parameters or other conditions that indicate a leak. Monitoring that is already being conducted for other purposes may be used to satisfy the requirements of this section. The plan shall include the information specified in paragraphs (c)(1)(i) and (c)(1)(ii) of 40 CFR §63.104. [40 CFR §63.104(c)(1)]
    - (i) A description of the parameter or condition to be monitored and an explanation of how the selected parameter or condition will reliably indicate the presence of a leak. [40 CFR §63.104(c)(1)(i)]
    - (ii) The parameter level(s) or conditions(s) that shall constitute a leak. This shall be documented by data or calculations showing that the selected levels or conditions will reliably identify leaks. The monitoring must be sufficiently sensitive to determine the range of parameter levels or conditions when the system is not leaking. When the selected parameter level or condition is outside that range, a leak is indicated. [40 CFR §63.104(c)(1)(ii)]
    - (iii) The monitoring frequency which shall be no less frequent than monthly for the first 6 months and quarterly thereafter to detect leaks. [40 CFR §63.104(c)(1)(iii)]
    - (iv) The records that will be maintained to document compliance with the requirements of this section. [40 CFR §63.104(c)(1)(iv)]
  - (2) If a substantial leak is identified by methods other than those described in the monitoring plan and the method(s) specified in the plan could not detect the leak, the permittee shall revise the plan and document the basis for the changes. The permittee shall complete the revisions to the plan no later than 180 days after discovery of the leak. [40 CFR §63.104(c)(2)]
  - (3) The permittee shall maintain, at all times, the monitoring plan that is currently in use. The current plan shall be maintained on-site, or shall be accessible from a central location by computer or other means that provides access within 2 hours after a request. If the monitoring plan is superseded, the owner or operator shall retain the most recent superseded plan at least until 5 years from the date of its creation. The superseded



plan shall be retained on-site (or accessible from a central location by computer or other means that provides access within two hours after a request) for at least 6 months after its creation. [40 CFR §63.104(c)(3)]

- f. If a leak is detected according to the criteria of paragraph (b) or (c) of this section, the permittee shall comply with the requirements in paragraphs (d)(1) and (d)(2) of 40 CFR §63.104(d), except as provided in paragraph (e) of 40 CFR §63.104(d). [40 CFR §63.104(d)]
- (1) The leak shall be repaired as soon as practical but not later than 45 calendar days after the owner or operator receives results of monitoring tests indicating a leak. The leak shall be repaired unless the permittee demonstrates that the results are due to a condition other than a leak. [40 CFR §63.104(d)(1)]
  - (2) Once the leak has been repaired, the permittee shall confirm that the heat exchange system has been repaired within 7 calendar days of the repair or startup, whichever is later. [40 CFR §63.104(d)(2)]
- g. Delay of repair of heat exchange systems for which leaks have been detected is allowed if the equipment is isolated from the process. Delay of repair is also allowed if repair is technically infeasible without a shutdown and any one of the conditions in paragraph (e)(1) or (e)(2) of 40 CFR §63.104 is met. All time periods in paragraphs (e)(1) and (e)(2) of 40 CFR §63.104 shall be determined from the date when the permittee determines that delay of repair is necessary. [40 CFR §63.104(e)]
- (1) If a shutdown is expected within the next 2 months, a special shutdown before that planned shutdown is not required. [40 CFR §63.104(e)(1)]
  - (2) If a shutdown is not expected within the next 2 months, the permittee may delay repair as provided in paragraph (e)(2)(i) or (e)(2)(ii) of 40 CFR §63.104. Documentation of a decision to delay repair shall state the reasons repair was delayed and shall specify a schedule for completing the repair as soon as practical. [40 CFR §63.104(e)(2)]
    - (i) If a shutdown for repair would cause greater emissions than the potential emissions from delaying repair, the permittee may delay repair until the next shutdown of the process equipment associated with the leaking heat exchanger. The permittee shall document the basis for the determination that a shutdown for repair would cause greater emissions than the emissions likely to result from delaying repair as specified in paragraphs (e)(2)(i)(A) and (e)(2)(i)(B) of 40 CFR §63.104. [40 CFR §63.104(e)(2)(i)]

- (A) The permittee shall calculate the potential emissions from the leaking heat exchanger by multiplying the concentration of total hazardous air pollutants listed in table 4 of this subpart in the cooling water from the leaking heat exchanger by the flowrate of the cooling water from the leaking heat exchanger by the expected duration of the delay. The permittee may calculate potential emissions using total organic carbon concentration instead of total hazardous air pollutants listed in table 4 of this subpart. [40 CFR §63.104(e)(2)(i)(A)]
  - (B) The permittee shall determine emissions from purging and depressurizing the equipment that will result from the unscheduled shutdown for the repair. [40 CFR §63.104(e)(2)(i)(B)]
  - (ii) If repair is delayed for reasons other than those specified in paragraph (e)(2)(i) of 40 CFR §63.104, the permittee may delay repair up to a maximum of 120 calendar days. The permittee shall demonstrate that the necessary parts or personnel were not available. [40 CFR §63.104(e)(2)(ii)]
- h. Required records.
- (1) The permittee shall retain the records identified in paragraphs (f)(1)(i) through (f)(1)(iv) of 40 CFR §63.104 as specified in §63.103(c)(1). [40 CFR §63.104(f)(1)]
    - (i) Monitoring data required by this section indicating a leak and the date when the leak was detected, and if demonstrated not to be a leak, the basis for that determination; [40 CFR §63.104(f)(1)(i)]
    - (ii) Records of any leaks detected by procedures subject to paragraph (c)(2) of this section and the date the leak was discovered; [40 CFR §63.104(f)(1)(ii)]
    - (iii) The dates of efforts to repair leaks; and [40 CFR §63.104(f)(1)(iii)]
    - (iv) The method or procedure used to confirm repair of a leak and the date repair was confirmed. [40 CFR §63.104(f)(1)(iv)]
  - (2) If the permittee invokes the delay of repair provisions for a heat exchange system, the following information shall be submitted in the next semi-annual periodic report required by §63.152(c) of subpart G of part 63. If

the leak remains unrepaired, the information shall also be submitted in each subsequent periodic report, until repair of the leak is reported. [40 CFR §63.104(f)(2)]

- (i) The permittee shall report the presence of the leak and the date that the leak was detected. [40 CFR §63.104(f)(2)(i)]
- (ii) The permittee shall report whether or not the leak has been repaired. [40 CFR §63.104(f)(2)(ii)]
- (iii) The permittee shall report the reason(s) for delay of repair. If delay of repair is invoked due to the reasons described in paragraph (e)(2) of this section, documentation of emissions estimates must also be submitted. [40 CFR §63.104(f)(2)(iii)]
- (iv) If the leak remains unrepaired, the permittee shall report the expected date of repair. [40 CFR §63.104(f)(2)(iv)]
- (v) If the leak is repaired, the permittee shall report the date the leak was successfully repaired. [40 CFR §63.104(f)(2)(v)]

24. The permittee must keep the records specified in paragraphs (a) through (k) of 40 CFR §63.2525. [40 CFR §63.2525]
- a. Each applicable record required by subpart A of this part 63 and in referenced subparts F, G, SS, UU, WW, and GGG of this part 63 and in referenced subpart F of 40 CFR part 65. [40 CFR §63.2525(a)]
  - b. Records of each operating scenario as specified in paragraphs (b)(1) through (8) of this section. [40 CFR §63.2525(b)]
    - (1) A description of the process and the type of process equipment used. [40 CFR §63.2525(b)(1)]
    - (2) An identification of related process vents, including their associated emissions episodes if not complying with the alternative standard in §63.2505; wastewater point of determination (POD); storage tanks; and transfer racks. [40 CFR §63.2525(b)(2)]
    - (3) The applicable control requirements of this subpart, including the level of required control, and for vents, the level of control for each vent. [40 CFR §63.2525(b)(3)]
    - (4) The control device or treatment process used, as applicable, including a description of operating and/or testing conditions for any associated control device. [40 CFR §63.2525(b)(4)]

- (5) The process vents, wastewater POD, transfer racks, and storage tanks (including those from other processes) that are simultaneously routed to the control device or treatment process(s). [40 CFR §63.2525(b)(5)]
  - (6) The applicable monitoring requirements of this subpart and any parametric level that assures compliance for all emissions routed to the control device or treatment process. [40 CFR §63.2525(b)(6)]
  - (7) Calculations and engineering analyses required to demonstrate compliance. [40 CFR §63.2525(b)(7)]
  - (8) For reporting purposes, a change to any of these elements not previously reported, except for paragraph (b)(5) of 40 CFR §63.2525, constitutes a new operating scenario. [40 CFR §63.2525(b)(8)]
- c. A schedule or log of operating scenarios for processes with batch vents from batch operations updated each time a different operating scenario is put into effect. [40 CFR §63.2525(c)]
- d. The information specified in paragraphs (d)(1) and (2) of 40 CFR §63.2525 for Group 1 batch process vents in compliance with a percent reduction emission limit in Table 2 to this subpart if some of the vents are controlled to less the percent reduction requirement. [40 CFR §63.2525(d)]
- (1) Records of whether each batch operated was considered a standard batch. [40 CFR §63.2525(d)(1)]
  - (2) The estimated uncontrolled and controlled emissions for each batch that is considered to be a nonstandard batch. [40 CFR §63.2525(d)(2)]
- e. The information specified in paragraph (e)(2), (3), or (4) of 40 CFR §63.2525, as applicable, for each process with Group 2 batch process vents or uncontrolled hydrogen halide and halogen HAP emissions from the sum of all batch and continuous process vents less than 1,000 lb/yr. No records are required for situations described in paragraph (e)(1) of 40 CFR §63.2525.
- (1) No records are required if the permittee documented in the permittee's notification of compliance status report that the MCPU meets any of the situations described in paragraph (e)(1)(i), (ii), or (iii) of 40 CFR §63.2525. [40 CFR §63.2525(e)(1)]
    - (i) The MCPU does not process, use, or generate HAP. [40 CFR §63.2525(e)(1)(i)]

- (ii) The permittee controls the Group 2 batch process vents using a flare that meets the requirements of §63.987. [40 CFR §63.2525(e)(1)(ii)]
  - (iii) The permittee controls the Group 2 batch process vents using a control device for which your determination of worst case for initial compliance includes the contribution of all Group 2 batch process vents. [40 CFR §63.2525(e)(1)(iii)]
- (2) If the permittee documented in the notification of compliance status report that an MCPU has Group 2 batch process vents because the non-reactive organic HAP is the only HAP and usage is less than 10,000 lb/yr, as specified in §63.2460(b)(7), the permittee must keep records of the amount of HAP material used, and calculate the daily rolling annual sum of the amount used no less frequently than monthly. If a record indicates usage exceeds 10,000 lb/yr, the permittee must estimate emissions for the preceding 12 months based on the number of batches operated and the estimated emissions for a standard batch, and the permittee must begin recordkeeping as specified in paragraph (e)(4) of this section. After 1 year, the permittee may revert to recording only usage if the usage during the year is less than 10,000 lb. [40 CFR §63.2525(e)(2)]
- (3) If the permittee documented in the notification of compliance status report that total uncontrolled organic HAP emissions from the batch process vents in an MCPU will be less than 1,000 lb/yr for the anticipated number of standard batches, then the permittee must keep records of the number of batches operated and calculate a daily rolling annual sum of batches operated no less frequently than monthly. If the number of batches operated results in organic HAP emissions that exceed 1,000 lb/yr, the permittee must estimate emissions for the preceding 12 months based on the number of batches operated and the estimated emissions for a standard batch, and the permittee must begin recordkeeping as specified in paragraph (e)(4) of 40 CFR §63.2525. After 1 year, the permittee may revert to recording only the number of batches if the number of batches operated during the year results in less than 1,000 lb of organic HAP emissions. [40 CFR §63.2525(e)(3)]
- (4) If the permittee meets none of the conditions specified in paragraphs (e)(1) through (3) of 40 CFR §63.2525 the permittee must keep records of the information specified in paragraphs (e)(4)(i) through (iv) of 40 CFR §63.2525[40 CFR §63.2525(e)(4)].

- (i) A record of the day each batch was completed and/or the operating hours per day for continuous operations with hydrogen halide and halogen emissions. [40 CFR §63.2525(e)(4)(i)]
  - (ii) A record of whether each batch operated was considered a standard batch. [40 CFR §63.2525(e)(4)(ii)]
  - (iii) (The estimated uncontrolled and controlled emissions for each batch that is considered to be a nonstandard batch. [40 CFR §63.2525(e)(4)(iii)]
  - (iv) Records of the daily 365-day rolling summations of emissions, or alternative records that correlate to the emissions (e.g., number of batches), calculated no less frequently than monthly. [40 CFR §63.2525(e)(4)(iv)]
- f. A record of each time a safety device is opened to avoid unsafe conditions in accordance with §63.2450(s). [40 CFR §63.2525(f)]
- g. Records of the results of each CPMS calibration check and the maintenance performed, as specified in §63.2450(k)(1). [40 CFR §63.2525(g)]
- h. For each CEMS, the permittee must keep records of the date and time that each deviation started and stopped, and whether the deviation occurred during a period of startup, shutdown, or malfunction or during another period. [40 CFR §63.2525(h)]
- i. For each PUG, the permittee must keep records specified in paragraphs (i)(1) through (5) of 40 CFR §63.2525. [40 CFR §63.2525(i)]
  - (1) Descriptions of the MCPU and other process units in the initial PUG required by §63.2535(l)(1)(v). [40 CFR §63.2525(i)(1)]
  - (2) Rationale for including each MCPU and other process unit in the initial PUG ( i.e., identify the overlapping equipment between process units) required by §63.2535(l)(1)(v). 40 CFR §63.2525(i)(2)]
  - (3) Calculations used to determine the primary product for the initial PUG required by §63.2535(l)(2)(iv). 40 CFR §63.2525(i)(3)]
  - (4) Descriptions of process units added to the PUG after the creation date and rationale for including the additional process units in the PUG as required by §63.2535(l)(1)(v). 40 CFR §63.2525(i)(4)]
  - (5) The calculation of each primary product redetermination required by §63.2535(l)(2)(iv). 40 CFR §63.2525(i)(5)]

- j. In the SSMP required by §63.6(e)(3), the permittee is not required to include Group 2 emission points, unless those emission points are used in an emissions average. For equipment leaks, the SSMP requirement is limited to control devices and is optional for other equipment. [40 CFR §63.2525(j)]
- k. For each bag leak detector used to monitor PM HAP emissions from a fabric filter, maintain records of any bag leak detection alarm, including the date and time, with a brief explanation of the cause of the alarm and the corrective action taken. [40 CFR §63.2525(k)]

MACT Reporting Deadlines

- 25. All reporting required under any applicable MACT standards, 40 CFR Parts 61 and 63, shall be submitted in accordance with General Provision #7, with the exception of the following standards. Reports for these listed standards shall be submitted each year by the dates listed in the following table. [§19.304 of Regulation 19]

<b>Regulation</b>	<b>Periodic Report Due Dates</b>
40 CFR Part 63, Subpart YY	3/31 and 9/30
40 CFR Part 63, Subpart MMM	4/30 and 10/31
40 CFR Part 63, Subpart FFFF	2/28 and 8/31

**SECTION VII: INSIGNIFICANT ACTIVITIES**

The following sources are insignificant activities. Any activity that has a state or federal applicable requirement shall be considered a significant activity even if this activity meets the criteria of §26.304 of Regulation 26 or listed in the table below. Insignificant activity determinations rely upon the information submitted by the permittee in an application dated June 17, 2013, and November 16, 2016.

Description	Category
HBr Storage Tanks (TT-12-807, TT-12-827, TT-12-805, TT-12-665, TT-12-666, TT-12-812, TT-12-804)	A-13
HBr Loading	A-13
Hydrazine Tote (Tote 1)	A-13
Toluene Circulation Tank (TT-08-589)	A-13
DP-45 Loadout Operations	A-13
BZ-54 Loadout Operations	A-13
FM-550 Loadout Operations	A-13
2-Ethylhexanol Loadout Operations	A-13
Hydrazine Storage Tank (TT-13-1605)	A-13
Product Storage Tanks (TT-13-1605, TT-13-315, TT-13-415, TT- 13-318, TT-13-316, TT-13-326, TT-13-330)	A-13
Additive Storage Tank (TT-13-330)	A-13
Spent Scrubber Neutralization Tank (TT-07-583)	A-13
Tail Water Surge Tank (TT-21-110, TT-21-109)	A-13
Treated Leachate Surge Tank (TT-27-110)	A-13
North Oil Separator Station Oil Tanks #1 and #2	A-13
Product Mix Tank (TK-22-653)	A-13
Hydrazine Tote (Tote 1)	A-13
Hydrazine Tote (Tote 2)	A-13
Raw Material Storage Tank	A-13
Wastewater Storage Tank	A-13
Brominated DPO Storage Tanks (TT-10-218, TT-10-388)	A-13



Great Lakes Chemical Corporation - Central Plant  
 Permit #: 1077-AOP-R5  
 AFIN: 70-00012

Description	Category
DPO Storage Tanks (TT-10-202, TT-10-203)	A-13
Gasoline Storage Tanks (2,000 gallon and 1,000 Gallon	A-13
Polyphenyl Ether Railcar Loading Tanks (2)	A-13
25 kg Packaging System for E-3000 at Dock 9	A-13
Filter Oven	A-13
Polymer Storage Tank (TT-12-822)	A-3
DP-45 Storage Tanks (TT-13-306, TT-13-307, TT-13-308, TT-13-309, TT-13-310, TT-13-311, TT-13-314, TT-13-329)	A-3
Product Storage Tank (TT-13-332, RX-13-413)	A-3
BZ-45 Storage Tank (TT-13-456)	A-3
Product Storage (RX-13-413)	A-3
Product Day Tank (RX-13-349)	A-3
Pre-Coat Tank (TT-13-602)	A-3
Filter Feed Tank (TT-13-601)	A-3
Waste Removal Vacuum Tanks (SP-13-602, SP-13-601)	A-3
Phenol Storage Tank (TT-14-039)	A-3
HBr Tank (TT-07-655)	A-3
Stationary Engine Diesel Storage Tank	A-3
Diesel Storage Tanks (2)	A-3
65 Kw Microturbine Generator (Combustion Turbine)	A-1

### SECTION VIII: GENERAL PROVISIONS

1. Any terms or conditions included in this permit which specify and reference Arkansas Pollution Control & Ecology Commission Regulation 18 or the Arkansas Water and Air Pollution Control Act (Ark. Code Ann. § 8-4-101 *et seq.*) as the sole origin of and authority for the terms or conditions are not required under the Clean Air Act or any of its applicable requirements, and are not federally enforceable under the Clean Air Act. Arkansas Pollution Control & Ecology Commission Regulation 18 was adopted pursuant to the Arkansas Water and Air Pollution Control Act (Ark. Code Ann. § 8-4-101 *et seq.*). Any terms or conditions included in this permit which specify and reference Arkansas Pollution Control & Ecology Commission Regulation 18 or the Arkansas Water and Air Pollution Control Act (Ark. Code Ann. § 8-4-101 *et seq.*) as the origin of and authority for the terms or conditions are enforceable under this Arkansas statute. [40 C.F.R. § 70.6(b)(2)]
2. This permit shall be valid for a period of five (5) years beginning on the date this permit becomes effective and ending five (5) years later. [40 C.F.R. § 70.6(a)(2) and Reg.26.701(B)]
3. The permittee must submit a complete application for permit renewal at least six (6) months before permit expiration. Permit expiration terminates the permittee's right to operate unless the permittee submitted a complete renewal application at least six (6) months before permit expiration. If the permittee submits a complete application, the existing permit will remain in effect until the Department takes final action on the renewal application. The Department will not necessarily notify the permittee when the permit renewal application is due. [Reg.26.406]
4. Where an applicable requirement of the Clean Air Act, as amended, 42 U.S.C. 7401, *et seq.* (Act) is more stringent than an applicable requirement of regulations promulgated under Title IV of the Act, the permit incorporates both provisions into the permit, and the Director or the Administrator can enforce both provisions. [40 C.F.R. § 70.6(a)(1)(ii) and Reg.26.701(A)(2)]
5. The permittee must maintain the following records of monitoring information as required by this permit.
  - a. The date, place as defined in this permit, and time of sampling or measurements;
  - b. The date(s) analyses performed;
  - c. The company or entity performing the analyses;
  - d. The analytical techniques or methods used;
  - e. The results of such analyses; and
  - f. The operating conditions existing at the time of sampling or measurement.

[40 C.F.R. § 70.6(a)(3)(ii)(A) and Reg.26.701(C)(2)]

Great Lakes Chemical Corporation - Central Plant

Permit #: 1077-AOP-R5

AFIN: 70-00012

6. The permittee must retain the records of all required monitoring data and support information for at least five (5) years from the date of the monitoring sample, measurement, report, or application. Support information includes all calibration and maintenance records and all original strip chart recordings for continuous monitoring instrumentation, and copies of all reports required by this permit. [40 C.F.R. § 70.6(a)(3)(ii)(B) and Reg.26.701(C)(2)(b)]
7. The permittee must submit reports of all required monitoring every six (6) months. If the permit establishes no other reporting period, the reporting period shall end on the last day of the month six months after the issuance of the initial Title V permit and every six months thereafter. The report is due on the first day of the second month after the end of the reporting period. The first report due after issuance of the initial Title V permit shall contain six months of data and each report thereafter shall contain 12 months of data. The report shall contain data for all monitoring requirements in effect during the reporting period. If a monitoring requirement is not in effect for the entire reporting period, only those months of data in which the monitoring requirement was in effect are required to be reported. The report must clearly identify all instances of deviations from permit requirements. A responsible official as defined in Reg.26.2 must certify all required reports. The permittee will send the reports to the address below:

Arkansas Department of Environmental Quality  
Air Division  
ATTN: Compliance Inspector Supervisor  
5301 Northshore Drive  
North Little Rock, AR 72118-5317

[40 C.F.R. § 70.6(a)(3)(iii)(A) and Reg.26.701(C)(3)(a)]

8. The permittee shall report to the Department all deviations from permit requirements, including those attributable to upset conditions as defined in the permit.
  - a. For all upset conditions (as defined in Reg.19.601), the permittee will make an initial report to the Department by the next business day after the discovery of the occurrence. The initial report may be made by telephone and shall include:
    - i. The facility name and location;
    - ii. The process unit or emission source deviating from the permit limit;
    - iii. The permit limit, including the identification of pollutants, from which deviation occurs;
    - iv. The date and time the deviation started;
    - v. The duration of the deviation;
    - vi. The emissions during the deviation;
    - vii. The probable cause of such deviations;
    - viii. Any corrective actions or preventive measures taken or being taken to prevent such deviations in the future; and

ix. The name of the person submitting the report.

The permittee shall make a full report in writing to the Department within five (5) business days of discovery of the occurrence. The report must include, in addition to the information required by the initial report, a schedule of actions taken or planned to eliminate future occurrences and/or to minimize the amount the permit's limits were exceeded and to reduce the length of time the limits were exceeded. The permittee may submit a full report in writing (by facsimile, overnight courier, or other means) by the next business day after discovery of the occurrence, and the report will serve as both the initial report and full report.

- b. For all deviations, the permittee shall report such events in semi-annual reporting and annual certifications required in this permit. This includes all upset conditions reported in 8a above. The semi-annual report must include all the information as required by the initial and full reports required in 8a.

[Reg.19.601, Reg.19.602, Reg.26.701(C)(3)(b), and 40 C.F.R. § 70.6(a)(3)(iii)(B)]

9. If any provision of the permit or the application thereof to any person or circumstance is held invalid, such invalidity will not affect other provisions or applications hereof which can be given effect without the invalid provision or application, and to this end, provisions of this Regulation are declared to be separable and severable. [40 C.F.R. § 70.6(a)(5), Reg.26.701(E), and Ark. Code Ann. § 8-4-203 as referenced by Ark. Code Ann. §§ 8-4-304 and 8-4-311]
10. The permittee must comply with all conditions of this Part 70 permit. Any permit noncompliance with applicable requirements as defined in Regulation 26 constitutes a violation of the Clean Air Act, as amended, 42 U.S.C. § 7401, *et seq.* and is grounds for enforcement action; for permit termination, revocation and reissuance, for permit modification; or for denial of a permit renewal application. [40 C.F.R. § 70.6(a)(6)(i) and Reg.26.701(F)(1)]
11. It shall not be a defense for a permittee in an enforcement action that it would have been necessary to halt or reduce the permitted activity to maintain compliance with the conditions of this permit. [40 C.F.R. § 70.6(a)(6)(ii) and Reg.26.701(F)(2)]
12. The Department may modify, revoke, reopen and reissue the permit or terminate the permit for cause. The filing of a request by the permittee for a permit modification, revocation and reissuance, termination, or of a notification of planned changes or anticipated noncompliance does not stay any permit condition. [40 C.F.R. § 70.6(a)(6)(iii) and Reg.26.701(F)(3)]
13. This permit does not convey any property rights of any sort, or any exclusive privilege. [40 C.F.R. § 70.6(a)(6)(iv) and Reg.26.701(F)(4)]

Great Lakes Chemical Corporation - Central Plant

Permit #: 1077-AOP-R5

AFIN: 70-00012

14. The permittee must furnish to the Director, within the time specified by the Director, any information that the Director may request in writing to determine whether cause exists for modifying, revoking and reissuing, or terminating the permit or to determine compliance with the permit. Upon request, the permittee must also furnish to the Director copies of records required by the permit. For information the permittee claims confidentiality, the Department may require the permittee to furnish such records directly to the Director along with a claim of confidentiality. [40 C.F.R. § 70.6(a)(6)(v) and Reg.26.701(F)(5)]
15. The permittee must pay all permit fees in accordance with the procedures established in Regulation 9. [40 C.F.R. § 70.6(a)(7) and Reg.26.701(G)]
16. No permit revision shall be required, under any approved economic incentives, marketable permits, emissions trading and other similar programs or processes for changes provided for elsewhere in this permit. [40 C.F.R. § 70.6(a)(8) and Reg.26.701(H)]
17. If the permit allows different operating scenarios, the permittee shall, contemporaneously with making a change from one operating scenario to another, record in a log at the permitted facility a record of the operational scenario. [40 C.F.R. § 70.6(a)(9)(i) and Reg.26.701(I)(1)]
18. The Administrator and citizens may enforce under the Act all terms and conditions in this permit, including any provisions designed to limit a source's potential to emit, unless the Department specifically designates terms and conditions of the permit as being federally unenforceable under the Act or under any of its applicable requirements. [40 C.F.R. § 70.6(b) and Reg.26.702(A) and (B)]
19. Any document (including reports) required by this permit pursuant to 40 C.F.R. § 70 must contain a certification by a responsible official as defined in Reg.26.2. [40 C.F.R. § 70.6(c)(1) and Reg.26.703(A)]
20. The permittee must allow an authorized representative of the Department, upon presentation of credentials, to perform the following: [40 C.F.R. § 70.6(c)(2) and Reg.26.703(B)]
  - a. Enter upon the permittee's premises where the permitted source is located or emissions related activity is conducted, or where records must be kept under the conditions of this permit;
  - b. Have access to and copy, at reasonable times, any records required under the conditions of this permit;
  - c. Inspect at reasonable times any facilities, equipment (including monitoring and air pollution control equipment), practices, or operations regulated or required under this permit; and
  - d. As authorized by the Act, sample or monitor at reasonable times substances or parameters for assuring compliance with this permit or applicable requirements.

21. The permittee shall submit a compliance certification with the terms and conditions contained in the permit, including emission limitations, standards, or work practices. The permittee must submit the compliance certification annually. If the permit establishes no other reporting period, the reporting period shall end on the last day of the anniversary month of the initial Title V permit. The report is due on the first day of the second month after the end of the reporting period. The permittee must also submit the compliance certification to the Administrator as well as to the Department. All compliance certifications required by this permit must include the following: [40 C.F.R. § 70.6(c)(5) and Reg.26.703(E)(3)]
  - a. The identification of each term or condition of the permit that is the basis of the certification;
  - b. The compliance status;
  - c. Whether compliance was continuous or intermittent;
  - d. The method(s) used for determining the compliance status of the source, currently and over the reporting period established by the monitoring requirements of this permit; and
  - e. Such other facts as the Department may require elsewhere in this permit or by § 114(a)(3) and § 504(b) of the Act.
22. Nothing in this permit will alter or affect the following: [Reg.26.704(C)]
  - a. The provisions of Section 303 of the Act (emergency orders), including the authority of the Administrator under that section;
  - b. The liability of the permittee for any violation of applicable requirements prior to or at the time of permit issuance;
  - c. The applicable requirements of the acid rain program, consistent with § 408(a) of the Act; or
  - d. The ability of EPA to obtain information from a source pursuant to § 114 of the Act.
23. This permit authorizes only those pollutant emitting activities addressed in this permit. [Ark. Code Ann. § 8-4-203 as referenced by Ark. Code Ann. §§ 8-4-304 and 8-4-311]
24. The permittee may request in writing and at least 15 days in advance of the deadline, an extension to any testing, compliance or other dates in this permit. No such extensions are authorized until the permittee receives written Department approval. The Department may grant such a request, at its discretion in the following circumstances:
  - a. Such an extension does not violate a federal requirement;
  - b. The permittee demonstrates the need for the extension; and
  - c. The permittee documents that all reasonable measures have been taken to meet the current deadline and documents reasons it cannot be met.

[Reg.18.314(A), Reg.19.416(A), Reg.26.1013(A), Ark. Code Ann. § 8-4-203 as referenced by Ark. Code Ann. §§ 8-4-304 and 8-4-311, and 40 C.F.R. § 52 Subpart E]

25. The permittee may request in writing and at least 30 days in advance, temporary emissions and/or testing that would otherwise exceed an emission rate, throughput requirement, or other limit in this permit. No such activities are authorized until the permittee receives written Department approval. Any such emissions shall be included in the facility's total emissions and reported as such. The Department may grant such a request, at its discretion under the following conditions:
- a. Such a request does not violate a federal requirement;
  - b. Such a request is temporary in nature;
  - c. Such a request will not result in a condition of air pollution;
  - d. The request contains such information necessary for the Department to evaluate the request, including but not limited to, quantification of such emissions and the date/time such emission will occur;
  - e. Such a request will result in increased emissions less than five tons of any individual criteria pollutant, one ton of any single HAP and 2.5 tons of total HAPs; and
  - f. The permittee maintains records of the dates and results of such temporary emissions/testing.

[Reg.18.314(B), Reg.19.416(B), Reg.26.1013(B), Ark. Code Ann. § 8-4-203 as referenced by Ark. Code Ann. §§ 8-4-304 and 8-4-311, and 40 C.F.R. § 52 Subpart E]

26. The permittee may request in writing and at least 30 days in advance, an alternative to the specified monitoring in this permit. No such alternatives are authorized until the permittee receives written Department approval. The Department may grant such a request, at its discretion under the following conditions:
- a. The request does not violate a federal requirement;
  - b. The request provides an equivalent or greater degree of actual monitoring to the current requirements; and
  - c. Any such request, if approved, is incorporated in the next permit modification application by the permittee.

[Reg.18.314(C), Reg.19.416(C), Reg.26.1013(C), Ark. Code Ann. § 8-4-203 as referenced by Ark. Code Ann. §§ 8-4-304 and 8-4-311, and 40 C.F.R. § 52 Subpart E]

# **APPENDIX A**



## Electronic Code of Federal Regulations

---

[View past updates to the e-CFR.](#)

[Click here to learn more.](#)

---

e-CFR data is current as of January 17, 2017

[Title 40](#) → [Chapter I](#) → [Subchapter C](#) → [Part 60](#) → Subpart Dc

---

[Browse Previous](#) | [Browse Next](#)

Title 40: Protection of Environment

[PART 60—STANDARDS OF PERFORMANCE FOR NEW STATIONARY SOURCES](#)

---

### **Subpart Dc—Standards of Performance for Small Industrial-Commercial-Institutional Steam Generating Units**

---

#### **Contents**

[§60.40c Applicability and delegation of authority.](#)

[§60.41c Definitions.](#)

[§60.42c Standard for sulfur dioxide \(SO<sub>2</sub>\).](#)

[§60.43c Standard for particulate matter \(PM\).](#)

[§60.44c Compliance and performance test methods and procedures for sulfur dioxide.](#)

[§60.45c Compliance and performance test methods and procedures for particulate matter.](#)

[§60.46c Emission monitoring for sulfur dioxide.](#)

[§60.47c Emission monitoring for particulate matter.](#)

[§60.48c Reporting and recordkeeping requirements.](#)

---

Source: 72 FR 32759, June 13, 2007, unless otherwise noted.

[↑ Back to Top](#)

#### **§60.40c Applicability and delegation of authority.**

(a) Except as provided in paragraphs (d), (e), (f), and (g) of this section, the affected facility to which this subpart applies is each steam generating unit for which construction, modification, or reconstruction is commenced after June 9, 1989 and that has a maximum design heat input capacity of 29 megawatts (MW) (100 million British thermal units per hour (MMBtu/h)) or less, but greater than or equal to 2.9 MW (10 MMBtu/h).

(b) In delegating implementation and enforcement authority to a State under section 111(c) of the Clean Air Act, §60.48c(a)(4) shall be retained by the Administrator and not transferred to a State.

(c) Steam generating units that meet the applicability requirements in paragraph (a) of this section are not subject to the sulfur dioxide (SO<sub>2</sub>) or particulate matter (PM) emission limits, performance testing requirements, or monitoring requirements under this subpart (§§60.42c, 60.43c, 60.44c, 60.45c, 60.46c, or 60.47c) during periods of combustion research, as defined in §60.41c.

(d) Any temporary change to an existing steam generating unit for the purpose of conducting combustion research is not considered a modification under §60.14.

(e) Affected facilities (*i.e.* heat recovery steam generators and fuel heaters) that are associated with stationary combustion turbines and meet the applicability requirements of subpart KKKK of this part are not subject to this subpart. This subpart will continue to apply to all other heat recovery steam generators, fuel heaters, and other affected facilities that are capable of combusting more than or equal to 2.9 MW (10 MMBtu/h) heat input of fossil fuel but less than or equal to 29 MW (100 MMBtu/h) heat input of fossil fuel. If the heat recovery steam generator, fuel heater, or other affected facility is subject to this subpart, only emissions resulting from combustion of fuels in the steam generating unit are subject to this subpart. (The stationary combustion turbine emissions are subject to subpart GG or KKKK, as applicable, of this part.)

(f) Any affected facility that meets the applicability requirements of and is subject to subpart AAAA or subpart CCCC of this part is not subject to this subpart.

(g) Any facility that meets the applicability requirements and is subject to an EPA approved State or Federal section 111(d)/129 plan implementing subpart BBBB of this part is not subject to this subpart.

(h) Affected facilities that also meet the applicability requirements under subpart J or subpart Ja of this part are subject to the PM and NO<sub>x</sub> standards under this subpart and the SO<sub>2</sub> standards under subpart J or subpart Ja of this part, as applicable.

(i) Temporary boilers are not subject to this subpart.

[72 FR 32759, June 13, 2007, as amended at 74 FR 5090, Jan. 28, 2009; 77 FR 9461, Feb. 16, 2012]

[↑ Back to Top](#)

#### **§60.41c Definitions.**

As used in this subpart, all terms not defined herein shall have the meaning given them in the Clean Air Act and in subpart A of this part.

*Annual capacity factor* means the ratio between the actual heat input to a steam generating unit from an individual fuel or combination of fuels during a period of 12 consecutive calendar months and the potential heat input to the steam generating unit from all fuels had the steam generating unit been operated for 8,760 hours during that 12-month period at the maximum design heat input capacity. In the case of steam generating units that are rented or leased, the actual heat input shall be determined based on

the combined heat input from all operations of the affected facility during a period of 12 consecutive calendar months.

*Coal* means all solid fuels classified as anthracite, bituminous, subbituminous, or lignite by the American Society of Testing and Materials in ASTM D388 (incorporated by reference, see §60.17), coal refuse, and petroleum coke. Coal-derived synthetic fuels derived from coal for the purposes of creating useful heat, including but not limited to solvent refined coal, gasified coal not meeting the definition of natural gas, coal-oil mixtures, and coal-water mixtures, are also included in this definition for the purposes of this subpart.

*Coal refuse* means any by-product of coal mining or coal cleaning operations with an ash content greater than 50 percent (by weight) and a heating value less than 13,900 kilojoules per kilogram (kJ/kg) (6,000 Btu per pound (Btu/lb) on a dry basis).

*Combined cycle system* means a system in which a separate source (such as a stationary gas turbine, internal combustion engine, or kiln) provides exhaust gas to a steam generating unit.

*Combustion research* means the experimental firing of any fuel or combination of fuels in a steam generating unit for the purpose of conducting research and development of more efficient combustion or more effective prevention or control of air pollutant emissions from combustion, provided that, during these periods of research and development, the heat generated is not used for any purpose other than preheating combustion air for use by that steam generating unit (*i.e.*, the heat generated is released to the atmosphere without being used for space heating, process heating, driving pumps, preheating combustion air for other units, generating electricity, or any other purpose).

*Conventional technology* means wet flue gas desulfurization technology, dry flue gas desulfurization technology, atmospheric fluidized bed combustion technology, and oil hydrodesulfurization technology.

*Distillate oil* means fuel oil that complies with the specifications for fuel oil numbers 1 or 2, as defined by the American Society for Testing and Materials in ASTM D396 (incorporated by reference, see §60.17), diesel fuel oil numbers 1 or 2, as defined by the American Society for Testing and Materials in ASTM D975 (incorporated by reference, see §60.17), kerosine, as defined by the American Society of Testing and Materials in ASTM D3699 (incorporated by reference, see §60.17), biodiesel as defined by the American Society of Testing and Materials in ASTM D6751 (incorporated by reference, see §60.17), or biodiesel blends as defined by the American Society of Testing and Materials in ASTM D7467 (incorporated by reference, see §60.17).

*Dry flue gas desulfurization technology* means a SO<sub>2</sub> control system that is located between the steam generating unit and the exhaust vent or stack, and that removes sulfur oxides from the combustion gases of the steam generating unit by contacting the combustion gases with an alkaline reagent and water, whether introduced separately or as a premixed slurry or solution and forming a dry powder material. This definition includes devices where the dry powder material is subsequently converted to another form. Alkaline reagents used in dry flue gas desulfurization systems include, but are not limited to, lime and sodium compounds.

*Duct burner* means a device that combusts fuel and that is placed in the exhaust duct from another source (such as a stationary gas turbine, internal combustion engine, kiln, etc.) to allow the firing of additional fuel to heat the exhaust gases before the exhaust gases enter a steam generating unit.

*Emerging technology* means any SO<sub>2</sub> control system that is not defined as a conventional technology under this section, and for which the owner or operator of the affected facility has received approval from the Administrator to operate as an emerging technology under §60.48c(a)(4).

*Federally enforceable* means all limitations and conditions that are enforceable by the Administrator, including the requirements of 40 CFR parts 60 and 61, requirements within any applicable State implementation plan, and any permit requirements established under 40 CFR 52.21 or under 40 CFR 51.18 and 51.24.

*Fluidized bed combustion technology* means a device wherein fuel is distributed onto a bed (or series of beds) of limestone aggregate (or other sorbent materials) for combustion; and these materials are forced upward in the device by the flow of combustion air and the gaseous products of combustion. Fluidized bed combustion technology includes, but is not limited to, bubbling bed units and circulating bed units.

*Fuel pretreatment* means a process that removes a portion of the sulfur in a fuel before combustion of the fuel in a steam generating unit.

*Heat input* means heat derived from combustion of fuel in a steam generating unit and does not include the heat derived from preheated combustion air, recirculated flue gases, or exhaust gases from other sources (such as stationary gas turbines, internal combustion engines, and kilns).

*Heat transfer medium* means any material that is used to transfer heat from one point to another point.

*Maximum design heat input capacity* means the ability of a steam generating unit to combust a stated maximum amount of fuel (or combination of fuels) on a steady state basis as determined by the physical design and characteristics of the steam generating unit.

*Natural gas* means:

- (1) A naturally occurring mixture of hydrocarbon and nonhydrocarbon gases found in geologic formations beneath the earth's surface, of which the principal constituent is methane; or
- (2) Liquefied petroleum (LP) gas, as defined by the American Society for Testing and Materials in ASTM D1835 (incorporated by reference, see §60.17); or
- (3) A mixture of hydrocarbons that maintains a gaseous state at ISO conditions. Additionally, natural gas must either be composed of at least 70 percent methane by volume or have a gross calorific value between 34 and 43 megajoules (MJ) per dry standard cubic meter (910 and 1,150 Btu per dry standard cubic foot).

*Noncontinental area* means the State of Hawaii, the Virgin Islands, Guam, American Samoa, the Commonwealth of Puerto Rico, or the Northern Mariana Islands.

*Oil* means crude oil or petroleum, or a liquid fuel derived from crude oil or petroleum, including distillate oil and residual oil.

*Potential sulfur dioxide emission rate* means the theoretical SO<sub>2</sub> emissions (nanograms per joule (ng/J) or lb/MMBtu heat input) that would result from combusting fuel in an uncleaned state and without using emission control systems.

*Process heater* means a device that is primarily used to heat a material to initiate or promote a chemical reaction in which the material participates as a reactant or catalyst.

*Residual oil* means crude oil, fuel oil that does not comply with the specifications under the definition of distillate oil, and all fuel oil numbers 4, 5, and 6, as defined by the American Society for Testing and Materials in ASTM D396 (incorporated by reference, see §60.17).

*Steam generating unit* means a device that combusts any fuel and produces steam or heats water or heats any heat transfer medium. This term includes any duct burner that combusts fuel and is part of a combined cycle system. This term does not include process heaters as defined in this subpart.

*Steam generating unit operating day* means a 24-hour period between 12:00 midnight and the following midnight during which any fuel is combusted at any time in the steam generating unit. It is not necessary for fuel to be combusted continuously for the entire 24-hour period.

*Temporary boiler* means a steam generating unit that combusts natural gas or distillate oil with a potential SO<sub>2</sub> emissions rate no greater than 26 ng/J (0.060 lb/MMBtu), and the unit is designed to, and is capable of, being carried or moved from one location to another by means of, for example, wheels, skids, carrying handles, dollies, trailers, or platforms. A steam generating unit is not a temporary boiler if any one of the following conditions exists:

- (1) The equipment is attached to a foundation.
- (2) The steam generating unit or a replacement remains at a location for more than 180 consecutive days. Any temporary boiler that replaces a temporary boiler at a location and performs the same or similar function will be included in calculating the consecutive time period.
- (3) The equipment is located at a seasonal facility and operates during the full annual operating period of the seasonal facility, remains at the facility for at least 2 years, and operates at that facility for at least 3 months each year.
- (4) The equipment is moved from one location to another in an attempt to circumvent the residence time requirements of this definition.

*Wet flue gas desulfurization technology* means an SO<sub>2</sub> control system that is located between the steam generating unit and the exhaust vent or stack, and that removes sulfur oxides from the combustion gases of the steam generating unit by contacting the combustion gases with an alkaline slurry or solution and forming a liquid material. This definition includes devices where the liquid material is subsequently converted to another form. Alkaline reagents used in wet flue gas desulfurization systems include, but are not limited to, lime, limestone, and sodium compounds.

*Wet scrubber system* means any emission control device that mixes an aqueous stream or slurry with the exhaust gases from a steam generating unit to control emissions of PM or SO<sub>2</sub>.

*Wood* means wood, wood residue, bark, or any derivative fuel or residue thereof, in any form, including but not limited to sawdust, sanderdust, wood chips, scraps, slabs, millings, shavings, and processed pellets made from wood or other forest residues.

[72 FR 32759, June 13, 2007, as amended at 74 FR 5090, Jan. 28, 2009; 77 FR 9461, Feb. 16, 2012]

[↑ Back to Top](#)

**§60.42c Standard for sulfur dioxide (SO<sub>2</sub>).**

(a) Except as provided in paragraphs (b), (c), and (e) of this section, on and after the date on which the performance test is completed or required to be completed under §60.8, whichever date comes first, the owner or operator of an affected facility that combusts only coal shall neither: cause to be discharged into the atmosphere from the affected facility any gases that contain SO<sub>2</sub> in excess of 87 ng/J (0.20 lb/MMBtu) heat input or 10 percent (0.10) of the potential SO<sub>2</sub> emission rate (90 percent reduction), nor cause to be discharged into the atmosphere from the affected facility any gases that contain SO<sub>2</sub> in excess of 520 ng/J (1.2 lb/MMBtu) heat input. If coal is combusted with other fuels, the affected facility shall neither: cause to be discharged into the atmosphere from the affected facility any gases that contain SO<sub>2</sub> in excess of 87 ng/J (0.20 lb/MMBtu) heat input or 10 percent (0.10) of the potential SO<sub>2</sub> emission rate (90 percent reduction), nor cause to be discharged into the atmosphere from the affected facility any gases that contain SO<sub>2</sub> in excess of the emission limit is determined pursuant to paragraph (e)(2) of this section.

(b) Except as provided in paragraphs (c) and (e) of this section, on and after the date on which the performance test is completed or required to be completed under §60.8, whichever date comes first, the owner or operator of an affected facility that:

(1) Combusts only coal refuse alone in a fluidized bed combustion steam generating unit shall neither:

(i) Cause to be discharged into the atmosphere from that affected facility any gases that contain SO<sub>2</sub> in excess of 87 ng/J (0.20 lb/MMBtu) heat input or 20 percent (0.20) of the potential SO<sub>2</sub> emission rate (80 percent reduction); nor

(ii) Cause to be discharged into the atmosphere from that affected facility any gases that contain SO<sub>2</sub> in excess of SO<sub>2</sub> in excess of 520 ng/J (1.2 lb/MMBtu) heat input. If coal is fired with coal refuse, the affected facility subject to paragraph (a) of this section. If oil or any other fuel (except coal) is fired with coal refuse, the affected facility is subject to the 87 ng/J (0.20 lb/MMBtu) heat input SO<sub>2</sub> emissions limit or the 90 percent SO<sub>2</sub> reduction requirement specified in paragraph (a) of this section and the emission limit is determined pursuant to paragraph (e)(2) of this section.

(2) Combusts only coal and that uses an emerging technology for the control of SO<sub>2</sub> emissions shall neither:

(i) Cause to be discharged into the atmosphere from that affected facility any gases that contain SO<sub>2</sub> in excess of 50 percent (0.50) of the potential SO<sub>2</sub> emission rate (50 percent reduction); nor

(ii) Cause to be discharged into the atmosphere from that affected facility any gases that contain SO<sub>2</sub> in excess of 260 ng/J (0.60 lb/MMBtu) heat input. If coal is combusted with other fuels, the affected facility

is subject to the 50 percent SO<sub>2</sub> reduction requirement specified in this paragraph and the emission limit determined pursuant to paragraph (e)(2) of this section.

(c) On and after the date on which the initial performance test is completed or required to be completed under §60.8, whichever date comes first, no owner or operator of an affected facility that combusts coal, alone or in combination with any other fuel, and is listed in paragraphs (c)(1), (2), (3), or (4) of this section shall cause to be discharged into the atmosphere from that affected facility any gases that contain SO<sub>2</sub> in excess of the emission limit determined pursuant to paragraph (e)(2) of this section. Percent reduction requirements are not applicable to affected facilities under paragraphs (c)(1), (2), (3), or (4).

(1) Affected facilities that have a heat input capacity of 22 MW (75 MMBtu/h) or less;

(2) Affected facilities that have an annual capacity for coal of 55 percent (0.55) or less and are subject to a federally enforceable requirement limiting operation of the affected facility to an annual capacity factor for coal of 55 percent (0.55) or less.

(3) Affected facilities located in a noncontinental area; or

(4) Affected facilities that combust coal in a duct burner as part of a combined cycle system where 30 percent (0.30) or less of the heat entering the steam generating unit is from combustion of coal in the duct burner and 70 percent (0.70) or more of the heat entering the steam generating unit is from exhaust gases entering the duct burner.

(d) On and after the date on which the initial performance test is completed or required to be completed under §60.8, whichever date comes first, no owner or operator of an affected facility that combusts oil shall cause to be discharged into the atmosphere from that affected facility any gases that contain SO<sub>2</sub> in excess of 215 ng/J (0.50 lb/MMBtu) heat input from oil; or, as an alternative, no owner or operator of an affected facility that combusts oil shall combust oil in the affected facility that contains greater than 0.5 weight percent sulfur. The percent reduction requirements are not applicable to affected facilities under this paragraph.

(e) On and after the date on which the initial performance test is completed or required to be completed under §60.8, whichever date comes first, no owner or operator of an affected facility that combusts coal, oil, or coal and oil with any other fuel shall cause to be discharged into the atmosphere from that affected facility any gases that contain SO<sub>2</sub> in excess of the following:

(1) The percent of potential SO<sub>2</sub> emission rate or numerical SO<sub>2</sub> emission rate required under paragraph (a) or (b)(2) of this section, as applicable, for any affected facility that

(i) Combusts coal in combination with any other fuel;

(ii) Has a heat input capacity greater than 22 MW (75 MMBtu/h); and

(iii) Has an annual capacity factor for coal greater than 55 percent (0.55); and

(2) The emission limit determined according to the following formula for any affected facility that combusts coal, oil, or coal and oil with any other fuel:

$$E_s = \frac{(K_a H_a + K_b H_b + K_c H_c)}{(H_a + H_b + H_c)}$$

[View or download PDF](#)

Where:

$E_s$  = SO<sub>2</sub> emission limit, expressed in ng/J or lb/MMBtu heat input;

$K_a$  = 520 ng/J (1.2 lb/MMBtu);

$K_b$  = 260 ng/J (0.60 lb/MMBtu);

$K_c$  = 215 ng/J (0.50 lb/MMBtu);

$H_a$  = Heat input from the combustion of coal, except coal combusted in an affected facility subject to paragraph (b)(2) of this section, in Joules (J) [MMBtu];

$H_b$  = Heat input from the combustion of coal in an affected facility subject to paragraph (b)(2) of this section, in J (MMBtu); and

$H_c$  = Heat input from the combustion of oil, in J (MMBtu).

(f) Reduction in the potential SO<sub>2</sub> emission rate through fuel pretreatment is not credited toward the percent reduction requirement under paragraph (b)(2) of this section unless:

(1) Fuel pretreatment results in a 50 percent (0.50) or greater reduction in the potential SO<sub>2</sub> emission rate; and

(2) Emissions from the pretreated fuel (without either combustion or post-combustion SO<sub>2</sub> control) are equal to or less than the emission limits specified under paragraph (b)(2) of this section.

(g) Except as provided in paragraph (h) of this section, compliance with the percent reduction requirements, fuel oil sulfur limits, and emission limits of this section shall be determined on a 30-day rolling average basis.

(h) For affected facilities listed under paragraphs (h)(1), (2), (3), or (4) of this section, compliance with the emission limits or fuel oil sulfur limits under this section may be determined based on a certification from the fuel supplier, as described under §60.48c(f), as applicable.

(1) Distillate oil-fired affected facilities with heat input capacities between 2.9 and 29 MW (10 and 100 MMBtu/hr).

(2) Residual oil-fired affected facilities with heat input capacities between 2.9 and 8.7 MW (10 and 30 MMBtu/hr).

(3) Coal-fired affected facilities with heat input capacities between 2.9 and 8.7 MW (10 and 30 MMBtu/h).



(4) Other fuels-fired affected facilities with heat input capacities between 2.9 and 8.7 MW (10 and 30 MMBtu/h).

(i) The SO<sub>2</sub> emission limits, fuel oil sulfur limits, and percent reduction requirements under this section apply at all times, including periods of startup, shutdown, and malfunction.

(j) For affected facilities located in noncontinental areas and affected facilities complying with the percent reduction standard, only the heat input supplied to the affected facility from the combustion of coal and oil is counted under this section. No credit is provided for the heat input to the affected facility from wood or other fuels or for heat derived from exhaust gases from other sources, such as stationary gas turbines, internal combustion engines, and kilns.

[72 FR 32759, June 13, 2007, as amended at 74 FR 5090, Jan. 28, 2009; 77 FR 9462, Feb. 16, 2012]

[↑ Back to Top](#)

#### **§60.43c Standard for particulate matter (PM).**

(a) On and after the date on which the initial performance test is completed or required to be completed under §60.8, whichever date comes first, no owner or operator of an affected facility that commenced construction, reconstruction, or modification on or before February 28, 2005, that combusts coal or combusts mixtures of coal with other fuels and has a heat input capacity of 8.7 MW (30 MMBtu/h) or greater, shall cause to be discharged into the atmosphere from that affected facility any gases that contain PM in excess of the following emission limits:

(1) 22 ng/J (0.051 lb/MMBtu) heat input if the affected facility combusts only coal, or combusts coal with other fuels and has an annual capacity factor for the other fuels of 10 percent (0.10) or less.

(2) 43 ng/J (0.10 lb/MMBtu) heat input if the affected facility combusts coal with other fuels, has an annual capacity factor for the other fuels greater than 10 percent (0.10), and is subject to a federally enforceable requirement limiting operation of the affected facility to an annual capacity factor greater than 10 percent (0.10) for fuels other than coal.

(b) On and after the date on which the initial performance test is completed or required to be completed under §60.8, whichever date comes first, no owner or operator of an affected facility that commenced construction, reconstruction, or modification on or before February 28, 2005, that combusts wood or combusts mixtures of wood with other fuels (except coal) and has a heat input capacity of 8.7 MW (30 MMBtu/h) or greater, shall cause to be discharged into the atmosphere from that affected facility any gases that contain PM in excess of the following emissions limits:

(1) 43 ng/J (0.10 lb/MMBtu) heat input if the affected facility has an annual capacity factor for wood greater than 30 percent (0.30); or

(2) 130 ng/J (0.30 lb/MMBtu) heat input if the affected facility has an annual capacity factor for wood of 30 percent (0.30) or less and is subject to a federally enforceable requirement limiting operation of the affected facility to an annual capacity factor for wood of 30 percent (0.30) or less.

(c) On and after the date on which the initial performance test is completed or required to be completed under §60.8, whichever date comes first, no owner or operator of an affected facility that combusts coal, wood, or oil and has a heat input capacity of 8.7 MW (30 MMBtu/h) or greater shall cause to be discharged into the atmosphere from that affected facility any gases that exhibit greater than 20 percent opacity (6-minute average), except for one 6-minute period per hour of not more than 27 percent opacity. Owners and operators of an affected facility that elect to install, calibrate, maintain, and operate a continuous emissions monitoring system (CEMS) for measuring PM emissions according to the requirements of this subpart and are subject to a federally enforceable PM limit of 0.030 lb/MMBtu or less are exempt from the opacity standard specified in this paragraph (c).

(d) The PM and opacity standards under this section apply at all times, except during periods of startup, shutdown, or malfunction.

(e)(1) On and after the date on which the initial performance test is completed or is required to be completed under §60.8, whichever date comes first, no owner or operator of an affected facility that commences construction, reconstruction, or modification after February 28, 2005, and that combusts coal, oil, wood, a mixture of these fuels, or a mixture of these fuels with any other fuels and has a heat input capacity of 8.7 MW (30 MMBtu/h) or greater shall cause to be discharged into the atmosphere from that affected facility any gases that contain PM in excess of 13 ng/J (0.030 lb/MMBtu) heat input, except as provided in paragraphs (e)(2), (e)(3), and (e)(4) of this section.

(2) As an alternative to meeting the requirements of paragraph (e)(1) of this section, the owner or operator of an affected facility for which modification commenced after February 28, 2005, may elect to meet the requirements of this paragraph. On and after the date on which the initial performance test is completed or required to be completed under §60.8, whichever date comes first, no owner or operator of an affected facility that commences modification after February 28, 2005 shall cause to be discharged into the atmosphere from that affected facility any gases that contain PM in excess of both:

(i) 22 ng/J (0.051 lb/MMBtu) heat input derived from the combustion of coal, oil, wood, a mixture of these fuels, or a mixture of these fuels with any other fuels; and

(ii) 0.2 percent of the combustion concentration (99.8 percent reduction) when combusting coal, oil, wood, a mixture of these fuels, or a mixture of these fuels with any other fuels.

(3) On and after the date on which the initial performance test is completed or is required to be completed under §60.8, whichever date comes first, no owner or operator of an affected facility that commences modification after February 28, 2005, and that combusts over 30 percent wood (by heat input) on an annual basis and has a heat input capacity of 8.7 MW (30 MMBtu/h) or greater shall cause to be discharged into the atmosphere from that affected facility any gases that contain PM in excess of 43 ng/J (0.10 lb/MMBtu) heat input.

(4) An owner or operator of an affected facility that commences construction, reconstruction, or modification after February 28, 2005, and that combusts only oil that contains no more than 0.50 weight percent sulfur or a mixture of 0.50 weight percent sulfur oil with other fuels not subject to a PM standard under §60.43c and not using a post-combustion technology (except a wet scrubber) to reduce PM or SO<sub>2</sub> emissions is not subject to the PM limit in this section.

[72 FR 32759, June 13, 2007, as amended at 74 FR 5091, Jan. 28, 2009; 77 FR 9462, Feb. 16, 2012]

[↑ Back to Top](#)

**§60.44c Compliance and performance test methods and procedures for sulfur dioxide.**

(a) Except as provided in paragraphs (g) and (h) of this section and §60.8(b), performance tests required under §60.8 shall be conducted following the procedures specified in paragraphs (b), (c), (d), (e), and (f) of this section, as applicable. Section 60.8(f) does not apply to this section. The 30-day notice required in §60.8(d) applies only to the initial performance test unless otherwise specified by the Administrator.

(b) The initial performance test required under §60.8 shall be conducted over 30 consecutive operating days of the steam generating unit. Compliance with the percent reduction requirements and SO<sub>2</sub> emission limits under §60.42c shall be determined using a 30-day average. The first operating day included in the initial performance test shall be scheduled within 30 days after achieving the maximum production rate at which the affect facility will be operated, but not later than 180 days after the initial startup of the facility. The steam generating unit load during the 30-day period does not have to be the maximum design heat input capacity, but must be representative of future operating conditions.

(c) After the initial performance test required under paragraph (b) of this section and §60.8, compliance with the percent reduction requirements and SO<sub>2</sub> emission limits under §60.42c is based on the average percent reduction and the average SO<sub>2</sub> emission rates for 30 consecutive steam generating unit operating days. A separate performance test is completed at the end of each steam generating unit operating day, and a new 30-day average percent reduction and SO<sub>2</sub> emission rate are calculated to show compliance with the standard.

(d) If only coal, only oil, or a mixture of coal and oil is combusted in an affected facility, the procedures in Method 19 of appendix A of this part are used to determine the hourly SO<sub>2</sub> emission rate (E<sub>ho</sub>) and the 30-day average SO<sub>2</sub> emission rate (E<sub>ao</sub>). The hourly averages used to compute the 30-day averages are obtained from the CEMS. Method 19 of appendix A of this part shall be used to calculate E<sub>ao</sub> when using daily fuel sampling or Method 6B of appendix A of this part.

(e) If coal, oil, or coal and oil are combusted with other fuels:

(1) An adjusted E<sub>ho</sub> (E<sub>ho0</sub>) is used in Equation 19-19 of Method 19 of appendix A of this part to compute the adjusted E<sub>ao</sub> (E<sub>ao0</sub>). The E<sub>ho0</sub> is computed using the following formula:

$$E_{ho0} = \frac{E_{ho} - E_w(1 - X_1)}{X_1}$$

[View or download PDF](#)

Where:

E<sub>ho0</sub> = Adjusted E<sub>ho</sub>, ng/J (lb/MMBtu);

E<sub>ho</sub> = Hourly SO<sub>2</sub> emission rate, ng/J (lb/MMBtu);

$E_w$  = SO<sub>2</sub> concentration in fuels other than coal and oil combusted in the affected facility, as determined by fuel sampling and analysis procedures in Method 9 of appendix A of this part, ng/J (lb/MMBtu). The value  $E_w$  for each fuel lot is used for each hourly average during the time that the lot is being combusted. The owner or operator does not have to measure  $E_w$  if the owner or operator elects to assume  $E_w = 0$ .

$X_k$  = Fraction of the total heat input from fuel combustion derived from coal and oil, as determined by applicable procedures in Method 19 of appendix A of this part.

(2) The owner or operator of an affected facility that qualifies under the provisions of §60.42c(c) or (d) (where percent reduction is not required) does not have to measure the parameters  $E_w$  or  $X_k$  if the owner or operator of the affected facility elects to measure emission rates of the coal or oil using the fuel sampling and analysis procedures under Method 19 of appendix A of this part.

(f) Affected facilities subject to the percent reduction requirements under §60.42c(a) or (b) shall determine compliance with the SO<sub>2</sub> emission limits under §60.42c pursuant to paragraphs (d) or (e) of this section, and shall determine compliance with the percent reduction requirements using the following procedures:

(1) If only coal is combusted, the percent of potential SO<sub>2</sub> emission rate is computed using the following formula:

$$\%P_f = 100 \left( 1 - \frac{\%R_z}{100} \right) \left( 1 - \frac{\%R_f}{100} \right)$$

[View or download PDF](#)

Where:

$\%P_s$  = Potential SO<sub>2</sub> emission rate, in percent;

$\%R_g$  = SO<sub>2</sub> removal efficiency of the control device as determined by Method 19 of appendix A of this part, in percent; and

$\%R_f$  = SO<sub>2</sub> removal efficiency of fuel pretreatment as determined by Method 19 of appendix A of this part, in percent.

(2) If coal, oil, or coal and oil are combusted with other fuels, the same procedures required in paragraph (f)(1) of this section are used, except as provided in the following:

(i) To compute the  $\%P_s$ , an adjusted  $\%R_g$  ( $\%R_{g,o}$ ) is computed from  $E_{a,o}$  from paragraph (e)(1) of this section and an adjusted average SO<sub>2</sub> inlet rate ( $E_{ai,o}$ ) using the following formula:

$$\%R_{g,o} = 100 \left( 1 - \frac{E_w}{E_{ai,o}} \right)$$

[View or download PDF](#)

Where:

$\%R_{gO}$  = Adjusted  $\%R_g$ , in percent;

$E_{aO}$  = Adjusted  $E_{aO}$ , ng/J (lb/MMBtu); and

$E_{aiO}$  = Adjusted average  $SO_2$  inlet rate, ng/J (lb/MMBtu).

(ii) To compute  $E_{aiO}$ , an adjusted hourly  $SO_2$  inlet rate ( $E_{hiO}$ ) is used. The  $E_{hiO}$  is computed using the following formula:

$$E_{hiO} = \frac{E_{hi} - E_w(1 - X_k)}{X_k}$$

[View or download PDF](#)

Where:

$E_{hiO}$  = Adjusted  $E_{hi}$ , ng/J (lb/MMBtu);

$E_{hi}$  = Hourly  $SO_2$  inlet rate, ng/J (lb/MMBtu);

$E_w$  =  $SO_2$  concentration in fuels other than coal and oil combusted in the affected facility, as determined by fuel sampling and analysis procedures in Method 19 of appendix A of this part, ng/J (lb/MMBtu). The value  $E_w$  for each fuel lot is used for each hourly average during the time that the lot is being combusted. The owner or operator does not have to measure  $E_w$  if the owner or operator elects to assume  $E_w = 0$ ; and

$X_k$  = Fraction of the total heat input from fuel combustion derived from coal and oil, as determined by applicable procedures in Method 19 of appendix A of this part.

(g) For oil-fired affected facilities where the owner or operator seeks to demonstrate compliance with the fuel oil sulfur limits under §60.42c based on shipment fuel sampling, the initial performance test shall consist of sampling and analyzing the oil in the initial tank of oil to be fired in the steam generating unit to demonstrate that the oil contains 0.5 weight percent sulfur or less. Thereafter, the owner or operator of the affected facility shall sample the oil in the fuel tank after each new shipment of oil is received, as described under §60.46c(d)(2).

(h) For affected facilities subject to §60.42c(h)(1), (2), or (3) where the owner or operator seeks to demonstrate compliance with the  $SO_2$  standards based on fuel supplier certification, the performance test shall consist of the certification from the fuel supplier, as described in §60.48c(f), as applicable.

(i) The owner or operator of an affected facility seeking to demonstrate compliance with the  $SO_2$  standards under §60.42c(c)(2) shall demonstrate the maximum design heat input capacity of the steam generating unit by operating the steam generating unit at this capacity for 24 hours. This demonstration shall be made during the initial performance test, and a subsequent demonstration may be requested at any other time. If the demonstrated 24-hour average firing rate for the affected facility is less than the maximum design heat input capacity stated by the manufacturer of the affected facility, the demonstrated 24-hour average firing rate shall be used to determine the annual capacity factor for the affected facility; otherwise, the maximum design heat input capacity provided by the manufacturer shall be used.

(j) The owner or operator of an affected facility shall use all valid SO<sub>2</sub> emissions data in calculating %P<sub>s</sub> and E<sub>ho</sub> under paragraphs (d), (e), or (f) of this section, as applicable, whether or not the minimum emissions data requirements under §60.46c(f) are achieved. All valid emissions data, including valid data collected during periods of startup, shutdown, and malfunction, shall be used in calculating %P<sub>s</sub> or E<sub>ho</sub> pursuant to paragraphs (d), (e), or (f) of this section, as applicable.

[72 FR 32759, June 13, 2007, as amended at 74 FR 5091, Jan. 28, 2009]

[↑ Back to Top](#)

**§60.45c Compliance and performance test methods and procedures for particulate matter.**

(a) The owner or operator of an affected facility subject to the PM and/or opacity standards under §60.43c shall conduct an initial performance test as required under §60.8, and shall conduct subsequent performance tests as requested by the Administrator, to determine compliance with the standards using the following procedures and reference methods, except as specified in paragraph (c) of this section.

(1) Method 1 of appendix A of this part shall be used to select the sampling site and the number of traverse sampling points.

(2) Method 3A or 3B of appendix A-2 of this part shall be used for gas analysis when applying Method 5 or 5B of appendix A-3 of this part or 17 of appendix A-6 of this part.

(3) Method 5, 5B, or 17 of appendix A of this part shall be used to measure the concentration of PM as follows:

(i) Method 5 of appendix A of this part may be used only at affected facilities without wet scrubber systems.

(ii) Method 17 of appendix A of this part may be used at affected facilities with or without wet scrubber systems provided the stack gas temperature does not exceed a temperature of 160 °C (320 °F). The procedures of Sections 8.1 and 11.1 of Method 5B of appendix A of this part may be used in Method 17 of appendix A of this part only if Method 17 of appendix A of this part is used in conjunction with a wet scrubber system. Method 17 of appendix A of this part shall not be used in conjunction with a wet scrubber system if the effluent is saturated or laden with water droplets.

(iii) Method 5B of appendix A of this part may be used in conjunction with a wet scrubber system.

(4) The sampling time for each run shall be at least 120 minutes and the minimum sampling volume shall be 1.7 dry standard cubic meters (dscm) [60 dry standard cubic feet (dscf)] except that smaller sampling times or volumes may be approved by the Administrator when necessitated by process variables or other factors.

(5) For Method 5 or 5B of appendix A of this part, the temperature of the sample gas in the probe and filter holder shall be monitored and maintained at 160 ±14 °C (320±25 °F).

(6) For determination of PM emissions, an oxygen (O<sub>2</sub>) or carbon dioxide (CO<sub>2</sub>) measurement shall be obtained simultaneously with each run of Method 5, 5B, or 17 of appendix A of this part by traversing the duct at the same sampling location.

(7) For each run using Method 5, 5B, or 17 of appendix A of this part, the emission rates expressed in ng/J (lb/MMBtu) heat input shall be determined using:

(i) The O<sub>2</sub> or CO<sub>2</sub> measurements and PM measurements obtained under this section, (ii) The dry basis F factor, and

(iii) The dry basis emission rate calculation procedure contained in Method 19 of appendix A of this part.

(8) Method 9 of appendix A-4 of this part shall be used for determining the opacity of stack emissions.

(b) The owner or operator of an affected facility seeking to demonstrate compliance with the PM standards under §60.43c(b)(2) shall demonstrate the maximum design heat input capacity of the steam generating unit by operating the steam generating unit at this capacity for 24 hours. This demonstration shall be made during the initial performance test, and a subsequent demonstration may be requested at any other time. If the demonstrated 24-hour average firing rate for the affected facility is less than the maximum design heat input capacity stated by the manufacturer of the affected facility, the demonstrated 24-hour average firing rate shall be used to determine the annual capacity factor for the affected facility; otherwise, the maximum design heat input capacity provided by the manufacturer shall be used.

(c) In place of PM testing with Method 5 or 5B of appendix A-3 of this part or Method 17 of appendix A-6 of this part, an owner or operator may elect to install, calibrate, maintain, and operate a CEMS for monitoring PM emissions discharged to the atmosphere and record the output of the system. The owner or operator of an affected facility who elects to continuously monitor PM emissions instead of conducting performance testing using Method 5 or 5B of appendix A-3 of this part or Method 17 of appendix A-6 of this part shall install, calibrate, maintain, and operate a CEMS and shall comply with the requirements specified in paragraphs (c)(1) through (c)(14) of this section.

(1) Notify the Administrator 1 month before starting use of the system.

(2) Notify the Administrator 1 month before stopping use of the system.

(3) The monitor shall be installed, evaluated, and operated in accordance with §60.13 of subpart A of this part.

(4) The initial performance evaluation shall be completed no later than 180 days after the date of initial startup of the affected facility, as specified under §60.8 of subpart A of this part or within 180 days of notification to the Administrator of use of CEMS if the owner or operator was previously determining compliance by Method 5, 5B, or 17 of appendix A of this part performance tests, whichever is later.

(5) The owner or operator of an affected facility shall conduct an initial performance test for PM emissions as required under §60.8 of subpart A of this part. Compliance with the PM emission limit shall be determined by using the CEMS specified in paragraph (d) of this section to measure PM and calculating a 24-hour block arithmetic average emission concentration using EPA Reference Method 19 of appendix A of this part, section 4.1.

(6) Compliance with the PM emission limit shall be determined based on the 24-hour daily (block) average of the hourly arithmetic average emission concentrations using CEMS outlet data.

(7) At a minimum, valid CEMS hourly averages shall be obtained as specified in paragraph (c)(7)(i) of this section for 75 percent of the total operating hours per 30-day rolling average.

(i) At least two data points per hour shall be used to calculate each 1-hour arithmetic average.

(ii) [Reserved]

(8) The 1-hour arithmetic averages required under paragraph (c)(7) of this section shall be expressed in ng/J or lb/MMBtu heat input and shall be used to calculate the boiler operating day daily arithmetic average emission concentrations. The 1-hour arithmetic averages shall be calculated using the data points required under §60.13(e)(2) of subpart A of this part.

(9) All valid CEMS data shall be used in calculating average emission concentrations even if the minimum CEMS data requirements of paragraph (c)(7) of this section are not met.

(10) The CEMS shall be operated according to Performance Specification 11 in appendix B of this part.

(11) During the correlation testing runs of the CEMS required by Performance Specification 11 in appendix B of this part, PM and O<sub>2</sub> (or CO<sub>2</sub>) data shall be collected concurrently (or within a 30- to 60-minute period) by both the continuous emission monitors and performance tests conducted using the following test methods.

(i) For PM, Method 5 or 5B of appendix A-3 of this part or Method 17 of appendix A-6 of this part shall be used; and

(ii) For O<sub>2</sub> (or CO<sub>2</sub>), Method 3A or 3B of appendix A-2 of this part, as applicable shall be used.

(12) Quarterly accuracy determinations and daily calibration drift tests shall be performed in accordance with procedure 2 in appendix F of this part. Relative Response Audit's must be performed annually and Response Correlation Audits must be performed every 3 years.

(13) When PM emissions data are not obtained because of CEMS breakdowns, repairs, calibration checks, and zero and span adjustments, emissions data shall be obtained by using other monitoring systems as approved by the Administrator or EPA Reference Method 19 of appendix A of this part to provide, as necessary, valid emissions data for a minimum of 75 percent of total operating hours on a 30-day rolling average.

(14) As of January 1, 2012, and within 90 days after the date of completing each performance test, as defined in §60.8, conducted to demonstrate compliance with this subpart, you must submit relative accuracy test audit (*i.e.*, reference method) data and performance test (*i.e.*, compliance test) data, except opacity data, electronically to EPA's Central Data Exchange (CDX) by using the Electronic Reporting Tool (ERT) (see [http://www.epa.gov/ttn/chief/ert/ert\\_tool.html](http://www.epa.gov/ttn/chief/ert/ert_tool.html)) or other compatible electronic spreadsheet. Only data collected using test methods compatible with ERT are subject to this requirement to be submitted electronically into EPA's WebFIRE database.



(d) The owner or operator of an affected facility seeking to demonstrate compliance under §60.43c(e)(4) shall follow the applicable procedures under §60.48c(f). For residual oil-fired affected facilities, fuel supplier certifications are only allowed for facilities with heat input capacities between 2.9 and 8.7 MW (10 to 30 MMBtu/h).

[72 FR 32759, June 13, 2007, as amended at 74 FR 5091, Jan. 28, 2009; 76 FR 3523, Jan. 20, 2011; 77 FR 9463, Feb. 16, 2012]

[↑ Back to Top](#)

#### **§60.46c Emission monitoring for sulfur dioxide.**

(a) Except as provided in paragraphs (d) and (e) of this section, the owner or operator of an affected facility subject to the SO<sub>2</sub> emission limits under §60.42c shall install, calibrate, maintain, and operate a CEMS for measuring SO<sub>2</sub> concentrations and either O<sub>2</sub> or CO<sub>2</sub> concentrations at the outlet of the SO<sub>2</sub> control device (or the outlet of the steam generating unit if no SO<sub>2</sub> control device is used), and shall record the output of the system. The owner or operator of an affected facility subject to the percent reduction requirements under §60.42c shall measure SO<sub>2</sub> concentrations and either O<sub>2</sub> or CO<sub>2</sub> concentrations at both the inlet and outlet of the SO<sub>2</sub> control device.

(b) The 1-hour average SO<sub>2</sub> emission rates measured by a CEMS shall be expressed in ng/J or lb/MMBtu heat input and shall be used to calculate the average emission rates under §60.42c. Each 1-hour average SO<sub>2</sub> emission rate must be based on at least 30 minutes of operation, and shall be calculated using the data points required under §60.13(h)(2). Hourly SO<sub>2</sub> emission rates are not calculated if the affected facility is operated less than 30 minutes in a 1-hour period and are not counted toward determination of a steam generating unit operating day.

(c) The procedures under §60.13 shall be followed for installation, evaluation, and operation of the CEMS.

(1) All CEMS shall be operated in accordance with the applicable procedures under Performance Specifications 1, 2, and 3 of appendix B of this part.

(2) Quarterly accuracy determinations and daily calibration drift tests shall be performed in accordance with Procedure 1 of appendix F of this part.

(3) For affected facilities subject to the percent reduction requirements under §60.42c, the span value of the SO<sub>2</sub> CEMS at the inlet to the SO<sub>2</sub> control device shall be 125 percent of the maximum estimated hourly potential SO<sub>2</sub> emission rate of the fuel combusted, and the span value of the SO<sub>2</sub> CEMS at the outlet from the SO<sub>2</sub> control device shall be 50 percent of the maximum estimated hourly potential SO<sub>2</sub> emission rate of the fuel combusted.

(4) For affected facilities that are not subject to the percent reduction requirements of §60.42c, the span value of the SO<sub>2</sub> CEMS at the outlet from the SO<sub>2</sub> control device (or outlet of the steam generating unit if no SO<sub>2</sub> control device is used) shall be 125 percent of the maximum estimated hourly potential SO<sub>2</sub> emission rate of the fuel combusted.

(d) As an alternative to operating a CEMS at the inlet to the SO<sub>2</sub> control device (or outlet of the steam generating unit if no SO<sub>2</sub> control device is used) as required under paragraph (a) of this section, an owner or operator may elect to determine the average SO<sub>2</sub> emission rate by sampling the fuel prior to combustion. As an alternative to operating a CEMS at the outlet from the SO<sub>2</sub> control device (or outlet of the steam generating unit if no SO<sub>2</sub> control device is used) as required under paragraph (a) of this section, an owner or operator may elect to determine the average SO<sub>2</sub> emission rate by using Method 6B of appendix A of this part. Fuel sampling shall be conducted pursuant to either paragraph (d)(1) or (d)(2) of this section. Method 6B of appendix A of this part shall be conducted pursuant to paragraph (d)(3) of this section.

(1) For affected facilities combusting coal or oil, coal or oil samples shall be collected daily in an as-fired condition at the inlet to the steam generating unit and analyzed for sulfur content and heat content according to the Method 19 of appendix A of this part. Method 19 of appendix A of this part provides procedures for converting these measurements into the format to be used in calculating the average SO<sub>2</sub> input rate.

(2) As an alternative fuel sampling procedure for affected facilities combusting oil, oil samples may be collected from the fuel tank for each steam generating unit immediately after the fuel tank is filled and before any oil is combusted. The owner or operator of the affected facility shall analyze the oil sample to determine the sulfur content of the oil. If a partially empty fuel tank is refilled, a new sample and analysis of the fuel in the tank would be required upon filling. Results of the fuel analysis taken after each new shipment of oil is received shall be used as the daily value when calculating the 30-day rolling average until the next shipment is received. If the fuel analysis shows that the sulfur content in the fuel tank is greater than 0.5 weight percent sulfur, the owner or operator shall ensure that the sulfur content of subsequent oil shipments is low enough to cause the 30-day rolling average sulfur content to be 0.5 weight percent sulfur or less.

(3) Method 6B of appendix A of this part may be used in lieu of CEMS to measure SO<sub>2</sub> at the inlet or outlet of the SO<sub>2</sub> control system. An initial stratification test is required to verify the adequacy of the Method 6B of appendix A of this part sampling location. The stratification test shall consist of three paired runs of a suitable SO<sub>2</sub> and CO<sub>2</sub> measurement train operated at the candidate location and a second similar train operated according to the procedures in §3.2 and the applicable procedures in section 7 of Performance Specification 2 of appendix B of this part. Method 6B of appendix A of this part, Method 6A of appendix A of this part, or a combination of Methods 6 and 3 of appendix A of this part or Methods 6C and 3A of appendix A of this part are suitable measurement techniques. If Method 6B of appendix A of this part is used for the second train, sampling time and timer operation may be adjusted for the stratification test as long as an adequate sample volume is collected; however, both sampling trains are to be operated similarly. For the location to be adequate for Method 6B of appendix A of this part 24-hour tests, the mean of the absolute difference between the three paired runs must be less than 10 percent (0.10).

(e) The monitoring requirements of paragraphs (a) and (d) of this section shall not apply to affected facilities subject to §60.42c(h) (1), (2), or (3) where the owner or operator of the affected facility seeks to demonstrate compliance with the SO<sub>2</sub> standards based on fuel supplier certification, as described under §60.48c(f), as applicable.

(f) The owner or operator of an affected facility operating a CEMS pursuant to paragraph (a) of this section, or conducting as-fired fuel sampling pursuant to paragraph (d)(1) of this section, shall obtain emission data for at least 75 percent of the operating hours in at least 22 out of 30 successive steam generating unit operating days. If this minimum data requirement is not met with a single monitoring system, the owner or operator of the affected facility shall supplement the emission data with data collected with other monitoring systems as approved by the Administrator.

[↑ Back to Top](#)

**§60.47c Emission monitoring for particulate matter.**

(a) Except as provided in paragraphs (c), (d), (e), and (f) of this section, the owner or operator of an affected facility combusting coal, oil, or wood that is subject to the opacity standards under §60.43c shall install, calibrate, maintain, and operate a continuous opacity monitoring system (COMS) for measuring the opacity of the emissions discharged to the atmosphere and record the output of the system. The owner or operator of an affected facility subject to an opacity standard in §60.43c(c) that is not required to use a COMS due to paragraphs (c), (d), (e), or (f) of this section that elects not to use a COMS shall conduct a performance test using Method 9 of appendix A-4 of this part and the procedures in §60.11 to demonstrate compliance with the applicable limit in §60.43c by April 29, 2011, within 45 days of stopping use of an existing COMS, or within 180 days after initial startup of the facility, whichever is later, and shall comply with either paragraphs (a)(1), (a)(2), or (a)(3) of this section. The observation period for Method 9 of appendix A-4 of this part performance tests may be reduced from 3 hours to 60 minutes if all 6-minute averages are less than 10 percent and all individual 15-second observations are less than or equal to 20 percent during the initial 60 minutes of observation.

(1) Except as provided in paragraph (a)(2) and (a)(3) of this section, the owner or operator shall conduct subsequent Method 9 of appendix A-4 of this part performance tests using the procedures in paragraph (a) of this section according to the applicable schedule in paragraphs (a)(1)(i) through (a)(1)(iv) of this section, as determined by the most recent Method 9 of appendix A-4 of this part performance test results.

(i) If no visible emissions are observed, a subsequent Method 9 of appendix A-4 of this part performance test must be completed within 12 calendar months from the date that the most recent performance test was conducted or within 45 days of the next day that fuel with an opacity standard is combusted, whichever is later;

(ii) If visible emissions are observed but the maximum 6-minute average opacity is less than or equal to 5 percent, a subsequent Method 9 of appendix A-4 of this part performance test must be completed within 6 calendar months from the date that the most recent performance test was conducted or within 45 days of the next day that fuel with an opacity standard is combusted, whichever is later;

(iii) If the maximum 6-minute average opacity is greater than 5 percent but less than or equal to 10 percent, a subsequent Method 9 of appendix A-4 of this part performance test must be completed within 3 calendar months from the date that the most recent performance test was conducted or within 45 days of the next day that fuel with an opacity standard is combusted, whichever is later; or

(iv) If the maximum 6-minute average opacity is greater than 10 percent, a subsequent Method 9 of appendix A-4 of this part performance test must be completed within 45 calendar days from the date that the most recent performance test was conducted.

(2) If the maximum 6-minute opacity is less than 10 percent during the most recent Method 9 of appendix A-4 of this part performance test, the owner or operator may, as an alternative to performing subsequent Method 9 of appendix A-4 of this part performance tests, elect to perform subsequent monitoring using Method 22 of appendix A-7 of this part according to the procedures specified in paragraphs (a)(2)(i) and (ii) of this section.

(i) The owner or operator shall conduct 10 minute observations (during normal operation) each operating day the affected facility fires fuel for which an opacity standard is applicable using Method 22 of appendix A-7 of this part and demonstrate that the sum of the occurrences of any visible emissions is not in excess of 5 percent of the observation period (*i.e.*, 30 seconds per 10 minute period). If the sum of the occurrence of any visible emissions is greater than 30 seconds during the initial 10 minute observation, immediately conduct a 30 minute observation. If the sum of the occurrence of visible emissions is greater than 5 percent of the observation period (*i.e.*, 90 seconds per 30 minute period), the owner or operator shall either document and adjust the operation of the facility and demonstrate within 24 hours that the sum of the occurrence of visible emissions is equal to or less than 5 percent during a 30 minute observation (*i.e.*, 90 seconds) or conduct a new Method 9 of appendix A-4 of this part performance test using the procedures in paragraph (a) of this section within 45 calendar days according to the requirements in §60.45c(a)(8).

(ii) If no visible emissions are observed for 10 operating days during which an opacity standard is applicable, observations can be reduced to once every 7 operating days during which an opacity standard is applicable. If any visible emissions are observed, daily observations shall be resumed.

(3) If the maximum 6-minute opacity is less than 10 percent during the most recent Method 9 of appendix A-4 of this part performance test, the owner or operator may, as an alternative to performing subsequent Method 9 of appendix A-4 performance tests, elect to perform subsequent monitoring using a digital opacity compliance system according to a site-specific monitoring plan approved by the Administrator. The observations shall be similar, but not necessarily identical, to the requirements in paragraph (a)(2) of this section. For reference purposes in preparing the monitoring plan, see OAQPS "Determination of Visible Emission Opacity from Stationary Sources Using Computer-Based Photographic Analysis Systems." This document is available from the U.S. Environmental Protection Agency (U.S. EPA); Office of Air Quality and Planning Standards; Sector Policies and Programs Division; Measurement Policy Group (D243-02), Research Triangle Park, NC 27711. This document is also available on the Technology Transfer Network (TTN) under Emission Measurement Center Preliminary Methods.

(b) All COMS shall be operated in accordance with the applicable procedures under Performance Specification 1 of appendix B of this part. The span value of the opacity COMS shall be between 60 and 80 percent.

(c) Owners and operators of an affected facilities that burn only distillate oil that contains no more than 0.5 weight percent sulfur and/or liquid or gaseous fuels with potential sulfur dioxide emission rates of 26 ng/J (0.060 lb/MMBtu) heat input or less and that do not use a post-combustion technology to reduce SO<sub>2</sub>

or PM emissions and that are subject to an opacity standard in §60.43c(c) are not required to operate a COMS if they follow the applicable procedures in §60.48c(f).

(d) Owners or operators complying with the PM emission limit by using a PM CEMS must calibrate, maintain, operate, and record the output of the system for PM emissions discharged to the atmosphere as specified in §60.45c(c). The CEMS specified in paragraph §60.45c(c) shall be operated and data recorded during all periods of operation of the affected facility except for CEMS breakdowns and repairs. Data is recorded during calibration checks, and zero and span adjustments.

(e) Owners and operators of an affected facility that is subject to an opacity standard in §60.43c(c) and that does not use post-combustion technology (except a wet scrubber) for reducing PM, SO<sub>2</sub>, or carbon monoxide (CO) emissions, burns only gaseous fuels or fuel oils that contain less than or equal to 0.5 weight percent sulfur, and is operated such that emissions of CO discharged to the atmosphere from the affected facility are maintained at levels less than or equal to 0.15 lb/MMBtu on a boiler operating day average basis is not required to operate a COMS. Owners and operators of affected facilities electing to comply with this paragraph must demonstrate compliance according to the procedures specified in paragraphs (e)(1) through (4) of this section; or

(1) You must monitor CO emissions using a CEMS according to the procedures specified in paragraphs (e)(1)(i) through (iv) of this section.

(i) The CO CEMS must be installed, certified, maintained, and operated according to the provisions in §60.58b(i)(3) of subpart Eb of this part.

(ii) Each 1-hour CO emissions average is calculated using the data points generated by the CO CEMS expressed in parts per million by volume corrected to 3 percent oxygen (dry basis).

(iii) At a minimum, valid 1-hour CO emissions averages must be obtained for at least 90 percent of the operating hours on a 30-day rolling average basis. The 1-hour averages are calculated using the data points required in §60.13(h)(2).

(iv) Quarterly accuracy determinations and daily calibration drift tests for the CO CEMS must be performed in accordance with procedure 1 in appendix F of this part.

(2) You must calculate the 1-hour average CO emissions levels for each steam generating unit operating day by multiplying the average hourly CO output concentration measured by the CO CEMS times the corresponding average hourly flue gas flow rate and divided by the corresponding average hourly heat input to the affected source. The 24-hour average CO emission level is determined by calculating the arithmetic average of the hourly CO emission levels computed for each steam generating unit operating day.

(3) You must evaluate the preceding 24-hour average CO emission level each steam generating unit operating day excluding periods of affected source startup, shutdown, or malfunction. If the 24-hour average CO emission level is greater than 0.15 lb/MMBtu, you must initiate investigation of the relevant equipment and control systems within 24 hours of the first discovery of the high emission incident and, take the appropriate corrective action as soon as practicable to adjust control settings or repair equipment to reduce the 24-hour average CO emission level to 0.15 lb/MMBtu or less.

(4) You must record the CO measurements and calculations performed according to paragraph (e) of this section and any corrective actions taken. The record of corrective action taken must include the date and time during which the 24-hour average CO emission level was greater than 0.15 lb/MMBtu, and the date, time, and description of the corrective action.

(f) An owner or operator of an affected facility that is subject to an opacity standard in §60.43c(c) is not required to operate a COMS provided that the affected facility meets the conditions in either paragraphs (f)(1), (2), or (3) of this section.

(1) The affected facility uses a fabric filter (baghouse) as the primary PM control device and, the owner or operator operates a bag leak detection system to monitor the performance of the fabric filter according to the requirements in section §60.48Da of this part.

(2) The affected facility uses an ESP as the primary PM control device, and the owner or operator uses an ESP predictive model to monitor the performance of the ESP developed in accordance and operated according to the requirements in section §60.48Da of this part.

(3) The affected facility burns only gaseous fuels and/or fuel oils that contain no greater than 0.5 weight percent sulfur, and the owner or operator operates the unit according to a written site-specific monitoring plan approved by the permitting authority. This monitoring plan must include procedures and criteria for establishing and monitoring specific parameters for the affected facility indicative of compliance with the opacity standard. For testing performed as part of this site-specific monitoring plan, the permitting authority may require as an alternative to the notification and reporting requirements specified in §§60.8 and 60.11 that the owner or operator submit any deviations with the excess emissions report required under §60.48c(c).

[72 FR 32759, June 13, 2007, as amended at 74 FR 5091, Jan. 28, 2009; 76 FR 3523, Jan. 20, 2011; 77 FR 9463, Feb. 16, 2012]

[↑ Back to Top](#)

#### **§60.48c Reporting and recordkeeping requirements.**

(a) The owner or operator of each affected facility shall submit notification of the date of construction or reconstruction and actual startup, as provided by §60.7 of this part. This notification shall include:

(1) The design heat input capacity of the affected facility and identification of fuels to be combusted in the affected facility.

(2) If applicable, a copy of any federally enforceable requirement that limits the annual capacity factor for any fuel or mixture of fuels under §60.42c, or §60.43c.

(3) The annual capacity factor at which the owner or operator anticipates operating the affected facility based on all fuels fired and based on each individual fuel fired.

(4) Notification if an emerging technology will be used for controlling SO<sub>2</sub> emissions. The Administrator will examine the description of the control device and will determine whether the technology qualifies as an emerging technology. In making this determination, the Administrator may require the owner or

operator of the affected facility to submit additional information concerning the control device. The affected facility is subject to the provisions of §60.42c(a) or (b)(1), unless and until this determination is made by the Administrator.

(b) The owner or operator of each affected facility subject to the SO<sub>2</sub> emission limits of §60.42c, or the PM or opacity limits of §60.43c, shall submit to the Administrator the performance test data from the initial and any subsequent performance tests and, if applicable, the performance evaluation of the CEMS and/or COMS using the applicable performance specifications in appendix B of this part.

(c) In addition to the applicable requirements in §60.7, the owner or operator of an affected facility subject to the opacity limits in §60.43c(c) shall submit excess emission reports for any excess emissions from the affected facility that occur during the reporting period and maintain records according to the requirements specified in paragraphs (c)(1) through (3) of this section, as applicable to the visible emissions monitoring method used.

(1) For each performance test conducted using Method 9 of appendix A-4 of this part, the owner or operator shall keep the records including the information specified in paragraphs (c)(1)(i) through (iii) of this section.

(i) Dates and time intervals of all opacity observation periods;

(ii) Name, affiliation, and copy of current visible emission reading certification for each visible emission observer participating in the performance test; and

(iii) Copies of all visible emission observer opacity field data sheets;

(2) For each performance test conducted using Method 22 of appendix A-4 of this part, the owner or operator shall keep the records including the information specified in paragraphs (c)(2)(i) through (iv) of this section.

(i) Dates and time intervals of all visible emissions observation periods;

(ii) Name and affiliation for each visible emission observer participating in the performance test;

(iii) Copies of all visible emission observer opacity field data sheets; and

(iv) Documentation of any adjustments made and the time the adjustments were completed to the affected facility operation by the owner or operator to demonstrate compliance with the applicable monitoring requirements.

(3) For each digital opacity compliance system, the owner or operator shall maintain records and submit reports according to the requirements specified in the site-specific monitoring plan approved by the Administrator

(d) The owner or operator of each affected facility subject to the SO<sub>2</sub> emission limits, fuel oil sulfur limits, or percent reduction requirements under §60.42c shall submit reports to the Administrator.

(e) The owner or operator of each affected facility subject to the SO<sub>2</sub> emission limits, fuel oil sulfur limits, or percent reduction requirements under §60.42c shall keep records and submit reports as required under paragraph (d) of this section, including the following information, as applicable.

(1) Calendar dates covered in the reporting period.

(2) Each 30-day average SO<sub>2</sub> emission rate (ng/J or lb/MMBtu), or 30-day average sulfur content (weight percent), calculated during the reporting period, ending with the last 30-day period; reasons for any noncompliance with the emission standards; and a description of corrective actions taken.

(3) Each 30-day average percent of potential SO<sub>2</sub> emission rate calculated during the reporting period, ending with the last 30-day period; reasons for any noncompliance with the emission standards; and a description of the corrective actions taken.

(4) Identification of any steam generating unit operating days for which SO<sub>2</sub> or diluent (O<sub>2</sub> or CO<sub>2</sub>) data have not been obtained by an approved method for at least 75 percent of the operating hours; justification for not obtaining sufficient data; and a description of corrective actions taken.

(5) Identification of any times when emissions data have been excluded from the calculation of average emission rates; justification for excluding data; and a description of corrective actions taken if data have been excluded for periods other than those during which coal or oil were not combusted in the steam generating unit.

(6) Identification of the F factor used in calculations, method of determination, and type of fuel combusted.

(7) Identification of whether averages have been obtained based on CEMS rather than manual sampling methods.

(8) If a CEMS is used, identification of any times when the pollutant concentration exceeded the full span of the CEMS.

(9) If a CEMS is used, description of any modifications to the CEMS that could affect the ability of the CEMS to comply with Performance Specifications 2 or 3 of appendix B of this part.

(10) If a CEMS is used, results of daily CEMS drift tests and quarterly accuracy assessments as required under appendix F, Procedure 1 of this part.

(11) If fuel supplier certification is used to demonstrate compliance, records of fuel supplier certification as described under paragraph (f)(1), (2), (3), or (4) of this section, as applicable. In addition to records of fuel supplier certifications, the report shall include a certified statement signed by the owner or operator of the affected facility that the records of fuel supplier certifications submitted represent all of the fuel combusted during the reporting period.

(f) Fuel supplier certification shall include the following information:

(1) For distillate oil:

(i) The name of the oil supplier;



(ii) A statement from the oil supplier that the oil complies with the specifications under the definition of distillate oil in §60.41c; and

(iii) The sulfur content or maximum sulfur content of the oil.

(2) For residual oil:

(i) The name of the oil supplier;

(ii) The location of the oil when the sample was drawn for analysis to determine the sulfur content of the oil, specifically including whether the oil was sampled as delivered to the affected facility, or whether the sample was drawn from oil in storage at the oil supplier's or oil refiner's facility, or other location;

(iii) The sulfur content of the oil from which the shipment came (or of the shipment itself); and

(iv) The method used to determine the sulfur content of the oil.

(3) For coal:

(i) The name of the coal supplier;

(ii) The location of the coal when the sample was collected for analysis to determine the properties of the coal, specifically including whether the coal was sampled as delivered to the affected facility or whether the sample was collected from coal in storage at the mine, at a coal preparation plant, at a coal supplier's facility, or at another location. The certification shall include the name of the coal mine (and coal seam), coal storage facility, or coal preparation plant (where the sample was collected);

(iii) The results of the analysis of the coal from which the shipment came (or of the shipment itself) including the sulfur content, moisture content, ash content, and heat content; and

(iv) The methods used to determine the properties of the coal.

(4) For other fuels:

(i) The name of the supplier of the fuel;

(ii) The potential sulfur emissions rate or maximum potential sulfur emissions rate of the fuel in ng/J heat input; and

(iii) The method used to determine the potential sulfur emissions rate of the fuel.

(g)(1) Except as provided under paragraphs (g)(2) and (g)(3) of this section, the owner or operator of each affected facility shall record and maintain records of the amount of each fuel combusted during each operating day.

(2) As an alternative to meeting the requirements of paragraph (g)(1) of this section, the owner or operator of an affected facility that combusts only natural gas, wood, fuels using fuel certification in §60.48c(f) to demonstrate compliance with the SO<sub>2</sub> standard, fuels not subject to an emissions standard (excluding

opacity), or a mixture of these fuels may elect to record and maintain records of the amount of each fuel combusted during each calendar month.

(3) As an alternative to meeting the requirements of paragraph (g)(1) of this section, the owner or operator of an affected facility or multiple affected facilities located on a contiguous property unit where the only fuels combusted in any steam generating unit (including steam generating units not subject to this subpart) at that property are natural gas, wood, distillate oil meeting the most current requirements in §60.42C to use fuel certification to demonstrate compliance with the SO<sub>2</sub> standard, and/or fuels, excluding coal and residual oil, not subject to an emissions standard (excluding opacity) may elect to record and maintain records of the total amount of each steam generating unit fuel delivered to that property during each calendar month.

(h) The owner or operator of each affected facility subject to a federally enforceable requirement limiting the annual capacity factor for any fuel or mixture of fuels under §60.42c or §60.43c shall calculate the annual capacity factor individually for each fuel combusted. The annual capacity factor is determined on a 12-month rolling average basis with a new annual capacity factor calculated at the end of the calendar month.

(i) All records required under this section shall be maintained by the owner or operator of the affected facility for a period of two years following the date of such record.

(j) The reporting period for the reports required under this subpart is each six-month period. All reports shall be submitted to the Administrator and shall be postmarked by the 30th day following the end of the reporting period.

[72 FR 32759, June 13, 2007, as amended at 74 FR 5091, Jan. 28, 2009]

[↑ Back to Top](#)

# **APPENDIX B**

## Electronic Code of Federal Regulations

---

[View past updates to the e-CFR.](#)

[Click here to learn more.](#)

---

**e-CFR data is current as of January 17, 2017**

[Title 40](#) → [Chapter I](#) → [Subchapter C](#) → [Part 60](#) → [Subpart VV](#)

---

[Browse Previous](#) | [Browse Next](#)

Title 40: Protection of Environment

[PART 60—STANDARDS OF PERFORMANCE FOR NEW STATIONARY SOURCES](#)

---

### **Subpart VV—Standards of Performance for Equipment Leaks of VOC in the Synthetic Organic Chemicals Manufacturing Industry for which Construction, Reconstruction, or Modification Commenced After January 5, 1981, and on or Before November 7, 2006**

---

#### **Contents**

- [§60.480 Applicability and designation of affected facility.](#)
- [§60.481 Definitions.](#)
- [§60.482-1 Standards: General.](#)
- [§60.482-2 Standards: Pumps in light liquid service.](#)
- [§60.482-3 Standards: Compressors.](#)
- [§60.482-4 Standards: Pressure relief devices in gas/vapor service.](#)
- [§60.482-5 Standards: Sampling connection systems.](#)
- [§60.482-6 Standards: Open-ended valves or lines.](#)
- [§60.482-7 Standards: Valves in gas/vapor service and in light liquid service.](#)
- [§60.482-8 Standards: Pumps and valves in heavy liquid service, pressure relief devices in light liquid or heavy liquid service, and connectors.](#)
- [§60.482-9 Standards: Delay of repair.](#)
- [§60.482-10 Standards: Closed vent systems and control devices.](#)
- [§60.483-1 Alternative standards for valves—allowable percentage of valves leaking.](#)
- [§60.483-2 Alternative standards for valves—skip period leak detection and repair.](#)
- [§60.484 Equivalence of means of emission limitation.](#)
- [§60.485 Test methods and procedures.](#)
- [§60.486 Recordkeeping requirements.](#)
- [§60.487 Reporting requirements.](#)
- [§60.488 Reconstruction.](#)
- [§60.489 List of chemicals produced by affected facilities.](#)

---

Source: 48 FR 48335, Oct. 18, 1983, unless otherwise noted.

[↑ Back to Top](#)

**§60.480 Applicability and designation of affected facility.**

(a)(1) The provisions of this subpart apply to affected facilities in the synthetic organic chemicals manufacturing industry.

(2) The group of all equipment (defined in §60.481) within a process unit is an affected facility.

(b) Any affected facility under paragraph (a) of this section that commences construction, reconstruction, or modification after January 5, 1981, and on or before November 7, 2006, shall be subject to the requirements of this subpart.

(c) Addition or replacement of equipment for the purpose of process improvement which is accomplished without a capital expenditure shall not by itself be considered a modification under this subpart.

(d)(1) If an owner or operator applies for one or more of the exemptions in this paragraph, then the owner or operator shall maintain records as required in §60.486(i).

(2) Any affected facility that has the design capacity to produce less than 1,000 Mg/yr (1,102 ton/yr) of a chemical listed in §60.489 is exempt from §§60.482-1 through 60.482-10.

(3) If an affected facility produces heavy liquid chemicals only from heavy liquid feed or raw materials, then it is exempt from §§60.482-1 through 60.482-10.

(4) Any affected facility that produces beverage alcohol is exempt from §§60.482-1 through 60.482-10.

(5) Any affected facility that has no equipment in volatile organic compounds (VOC) service is exempt from §§60.482-1 through 60.482-10.

(e) *Alternative means of compliance*—(1) *Option to comply with part 65.* (i) Owners or operators may choose to comply with the provisions of 40 CFR part 65, subpart F, to satisfy the requirements of §§60.482 through 60.487 for an affected facility. When choosing to comply with 40 CFR part 65, subpart F, the requirements of §§60.485(d), (e), and (f) and 60.486(i) and (j) still apply. Other provisions applying to an owner or operator who chooses to comply with 40 CFR part 65 are provided in 40 CFR 65.1.

(ii) *Part 60, subpart A.* Owners or operators who choose to comply with 40 CFR part 65, subpart F must also comply with §§60.1, 60.2, 60.5, 60.6, 60.7(a)(1) and (4), 60.14, 60.15, and 60.16 for that equipment. All sections and paragraphs of subpart A of this part that are not mentioned in this paragraph (e)(1)(ii) do not apply to owners and operators of equipment subject to this subpart complying with 40 CFR part 65, subpart F, except that provisions required to be met prior to implementing 40 CFR part 65 still apply. Owners and operators who choose to comply with 40 CFR part 65, subpart F, must comply with 40 CFR part 65, subpart A.

(2) *Subpart VVa*. Owners or operators may choose to comply with the provisions of subpart VVa of this part 60 to satisfy the requirements of this subpart VV for an affected facility.

(f) *Stay of standards*. Owners or operators are not required to comply with the definition of “process unit” in §60.481 and the requirements in §60.482-1(g) of this subpart until the EPA takes final action to require compliance and publishes a document in the Federal Register. While the definition of “process unit” is stayed, owners or operators should use the following definition:

*Process unit* means components assembled to produce, as intermediate or final products, one or more of the chemicals listed in §60.489 of this part. A process unit can operate independently if supplied with sufficient feed or raw materials and sufficient storage facilities for the product.

[48 FR 48335, Oct. 18, 1983, as amended at 49 FR 22607, May 30, 1984; 65 FR 61762, Oct. 17, 2000; 65 FR 78276, Dec. 14, 2000; 72 FR 64879, Nov. 16, 2007, 73 FR 31379, June 2, 2008; 73 FR 31375, June 2, 2008]

[↑ Back to Top](#)

#### **§60.481 Definitions.**

As used in this subpart, all terms not defined herein shall have the meaning given them in the Act or in subpart A of part 60, and the following terms shall have the specific meanings given them.

*Capital expenditure* means, in addition to the definition in 40 CFR 60.2, an expenditure for a physical or operational change to an existing facility that:

(a) Exceeds P, the product of the facility's replacement cost, R, and an adjusted annual asset guideline repair allowance, A, as reflected by the following equation:  $P = R \times A$ , where

(1) The adjusted annual asset guideline repair allowance, A, is the product of the percent of the replacement cost, Y, and the applicable basic annual asset guideline repair allowance, B, divided by 100 as reflected by the following equation:

$$A = Y \times (B \div 100);$$

(2) The percent Y is determined from the following equation:  $Y = 1.0 - 0.575 \log X$ , where X is 1982 minus the year of construction; and

(3) The applicable basic annual asset guideline repair allowance, B, is selected from the following table consistent with the applicable subpart:

**Table for Determining Applicable Value for B**

<b>Subpart applicable to facility</b>	<b>Value of B to be used in equation</b>
VV	12.5

DDD	12.5
GGG	7.0
KKK	4.5

*Closed-loop system* means an enclosed system that returns process fluid to the process.

*Closed-purge system* means a system or combination of systems and portable containers to capture purged liquids. Containers for purged liquids must be covered or closed when not being filled or emptied.

*Closed vent system* means a system that is not open to the atmosphere and that is composed of hard-piping, ductwork, connections, and, if necessary, flow-inducing devices that transport gas or vapor from a piece or pieces of equipment to a control device or back to a process.

*Connector* means flanged, screwed, or other joined fittings used to connect two pipe lines or a pipe line and a piece of process equipment or that close an opening in a pipe that could be connected to another pipe. Joined fittings welded completely around the circumference of the interface are not considered connectors for the purpose of this subpart.

*Control device* means an enclosed combustion device, vapor recovery system, or flare.

*Distance piece* means an open or enclosed casing through which the piston rod travels, separating the compressor cylinder from the crankcase.

*Double block and bleed system* means two block valves connected in series with a bleed valve or line that can vent the line between the two block valves.

*Duct work* means a conveyance system such as those commonly used for heating and ventilation systems. It is often made of sheet metal and often has sections connected by screws or crimping. Hard-piping is not ductwork.

*Equipment* means each pump, compressor, pressure relief device, sampling connection system, open-ended valve or line, valve, and flange or other connector in VOC service and any devices or systems required by this subpart.

*First attempt at repair* means to take action for the purpose of stopping or reducing leakage of organic material to the atmosphere using best practices.

*Fuel gas* means gases that are combusted to derive useful work or heat.

*Fuel gas system* means the offsite and onsite piping and flow and pressure control system that gathers gaseous stream(s) generated by onsite operations, may blend them with other sources of gas, and transports the gaseous stream for use as fuel gas in combustion devices or in-process combustion equipment, such as furnaces and gas turbines, either singly or in combination.

*Hard-piping* means pipe or tubing that is manufactured and properly installed using good engineering judgment and standards such as ASME B31.3, Process Piping (available from the American Society of Mechanical Engineers, PO Box 2300, Fairfield, NJ 07007-2300).

*In gas/vapor service* means that the piece of equipment contains process fluid that is in the gaseous state at operating conditions.

*In heavy liquid service* means that the piece of equipment is not in gas/vapor service or in light liquid service.

*In light liquid service* means that the piece of equipment contains a liquid that meets the conditions specified in §60.485(e).

*In-situ sampling systems* means nonextractive samplers or in-line samplers.

*In vacuum service* means that equipment is operating at an internal pressure which is at least 5 kilopascals (kPa)(0.7 psia) below ambient pressure.

*In VOC service* means that the piece of equipment contains or contacts a process fluid that is at least 10 percent VOC by weight. (The provisions of §60.485(d) specify how to determine that a piece of equipment is not in VOC service.)

*Liquids dripping* means any visible leakage from the seal including spraying, misting, clouding, and ice formation.

*Open-ended valve or line* means any valve, except safety relief valves, having one side of the valve seat in contact with process fluid and one side open to the atmosphere, either directly or through open piping.

*Pressure release* means the emission of materials resulting from system pressure being greater than set pressure of the pressure relief device.

*Process improvement* means routine changes made for safety and occupational health requirements, for energy savings, for better utility, for ease of maintenance and operation, for correction of design deficiencies, for bottleneck removal, for changing product requirements, or for environmental control.

*Process unit* means the components assembled and connected by pipes or ducts to process raw materials and to produce, as intermediate or final products, one or more of the chemicals listed in §60.489. A process unit can operate independently if supplied with sufficient feed or raw materials and sufficient storage facilities for the product. For the purpose of this subpart, process unit includes any feed, intermediate and final product storage vessels (except as specified in §60.482-1(g)), product transfer racks, and connected ducts and piping. A process unit includes all equipment as defined in this subpart.

*Process unit shutdown* means a work practice or operational procedure that stops production from a process unit or part of a process unit during which it is technically feasible to clear process material from a process unit or part of a process unit consistent with safety constraints and during which repairs can be accomplished. The following are not considered process unit shutdowns:



(1) An unscheduled work practice or operational procedure that stops production from a process unit or part of a process unit for less than 24 hours.

(2) An unscheduled work practice or operational procedure that would stop production from a process unit or part of a process unit for a shorter period of time than would be required to clear the process unit or part of the process unit of materials and start up the unit, and would result in greater emissions than delay of repair of leaking components until the next scheduled process unit shutdown.

(3) The use of spare equipment and technically feasible bypassing of equipment without stopping production.

*Quarter* means a 3-month period; the first quarter concludes on the last day of the last full month during the 180 days following initial startup.

*Repaired* means that equipment is adjusted, or otherwise altered, in order to eliminate a leak as defined in the applicable sections of this subpart and, except for leaks identified in accordance with §§60.482-2(b)(2)(ii) and (d)(6)(ii) and (iii), 60.482-3(f), and 60.482-10(f)(1)(ii), is re-monitored as specified in §60.485(b) to verify that emissions from the equipment are below the applicable leak definition.

*Replacement cost* means the capital needed to purchase all the depreciable components in a facility.

*Sampling connection system* means an assembly of equipment within a process unit used during periods of representative operation to take samples of the process fluid. Equipment used to take nonroutine grab samples is not considered a sampling connection system.

*Sensor* means a device that measures a physical quantity or the change in a physical quantity such as temperature, pressure, flow rate, pH, or liquid level.

*Storage vessel* means a tank or other vessel that is used to store organic liquids that are used in the process as raw material feedstocks, produced as intermediates or final products, or generated as wastes. Storage vessel does not include vessels permanently attached to motor vehicles, such as trucks, railcars, barges, or ships.

*Synthetic organic chemicals manufacturing industry* means the industry that produces, as intermediates or final products, one or more of the chemicals listed in §60.489.

*Transfer rack* means the collection of loading arms and loading hoses, at a single loading rack, that are used to fill tank trucks and/or railcars with organic liquids.

*Volatile organic compounds* or VOC means, for the purposes of this subpart, any reactive organic compounds as defined in §60.2 Definitions.

[48 FR 48335, Oct. 18, 1983, as amended at 49 FR 22607, May 30, 1984; 49 FR 26738, June 29, 1984; 60 FR 43258, Aug. 18, 1995; 65 FR 61762, Oct. 17, 2000; 65 FR 78276, Dec. 14, 2000; 72 FR 64879, Nov. 16, 2007]

Effective Date Note: At 73 FR 31375, June 2, 2008, in §60.481, the definition of “process unit” was stayed until further notice.

[↑ Back to Top](#)

**§60.482-1 Standards: General.**

(a) Each owner or operator subject to the provisions of this subpart shall demonstrate compliance with the requirements of §§60.482-1 through 60.482-10 or §60.480(e) for all equipment within 180 days of initial startup.

(b) Compliance with §§60.482-1 to 60.482-10 will be determined by review of records and reports, review of performance test results, and inspection using the methods and procedures specified in §60.485.

(c)(1) An owner or operator may request a determination of equivalence of a means of emission limitation to the requirements of §§60.482-2, 60.482-3, 60.482-5, 60.482-6, 60.482-7, 60.482-8, and 60.482-10 as provided in §60.484.

(2) If the Administrator makes a determination that a means of emission limitation is at least equivalent to the requirements of §60.482-2, §60.482-3, §60.482-5, §60.482-6, §60.482-7, §60.482-8, or §60.482-10, an owner or operator shall comply with the requirements of that determination.

(d) Equipment that is in vacuum service is excluded from the requirements of §§60.482-2 to 60.482-10 if it is identified as required in §60.486(e)(5).

(e) Equipment that an owner or operator designates as being in VOC service less than 300 hours (hr)/yr is excluded from the requirements of §§60.482-2 through 60.482-10 if it is identified as required in §60.486(e)(6) and it meets any of the conditions specified in paragraphs (e)(1) through (3) of this section.

(1) The equipment is in VOC service only during startup and shutdown, excluding startup and shutdown between batches of the same campaign for a batch process.

(2) The equipment is in VOC service only during process malfunctions or other emergencies.

(3) The equipment is backup equipment that is in VOC service only when the primary equipment is out of service.

(f)(1) If a dedicated batch process unit operates less than 365 days during a year, an owner or operator may monitor to detect leaks from pumps and valves at the frequency specified in the following table instead of monitoring as specified in §§60.482-2, 60.482-7, and 60.483-2:

Operating time (percent of hours during year)	Equivalent monitoring frequency time in use		
	Monthly	Quarterly	Semiannually
0 to <25	Quarterly	Annually	Annually.
25 to <50	Quarterly	Semiannually	Annually.

50 to <75	Bimonthly	Three quarters	Semiannually.
75 to 100	Monthly	Quarterly	Semiannually.

(2) Pumps and valves that are shared among two or more batch process units that are subject to this subpart may be monitored at the frequencies specified in paragraph (f)(1) of this section, provided the operating time of all such process units is considered.

(3) The monitoring frequencies specified in paragraph (f)(1) of this section are not requirements for monitoring at specific intervals and can be adjusted to accommodate process operations. An owner or operator may monitor at any time during the specified monitoring period (e.g., month, quarter, year), provided the monitoring is conducted at a reasonable interval after completion of the last monitoring campaign. Reasonable intervals are defined in paragraphs (f)(3)(i) through (iv) of this section.

(i) When monitoring is conducted quarterly, monitoring events must be separated by at least 30 calendar days.

(ii) When monitoring is conducted semiannually (*i.e.*, once every 2 quarters), monitoring events must be separated by at least 60 calendar days.

(iii) When monitoring is conducted in 3 quarters per year, monitoring events must be separated by at least 90 calendar days.

(iv) When monitoring is conducted annually, monitoring events must be separated by at least 120 calendar days.

(g) If the storage vessel is shared with multiple process units, the process unit with the greatest annual amount of stored materials (predominant use) is the process unit the storage vessel is assigned to. If the storage vessel is shared equally among process units, and one of the process units has equipment subject to subpart VVa of this part, the storage vessel is assigned to that process unit. If the storage vessel is shared equally among process units, none of which have equipment subject to subpart VVa of this part, the storage vessel is assigned to any process unit subject to this subpart. If the predominant use of the storage vessel varies from year to year, then the owner or operator must estimate the predominant use initially and reassess every 3 years. The owner or operator must keep records of the information and supporting calculations that show how predominant use is determined. All equipment on the storage vessel must be monitored when in VOC service.

[48 FR 48335, Oct. 18, 1983, as amended at 49 FR 22608, May 30, 1984; 65 FR 78276, Dec. 14, 2000; 72 FR 64880, Nov. 16, 2007]

Effective Date Note: At 73 FR 31375, June 2, 2008, in §60.482-1, paragraph (g) was stayed until further notice.

[↑ Back to Top](#)

**§60.482-2 Standards: Pumps in light liquid service.**

(a)(1) Each pump in light liquid service shall be monitored monthly to detect leaks by the methods specified in §60.485(b), except as provided in §60.482-1(c) and (f) and paragraphs (d), (e), and (f) of this section. A pump that begins operation in light liquid service after the initial startup date for the process unit must be monitored for the first time within 30 days after the end of its startup period, except for a pump that replaces a leaking pump and except as provided in §60.482-1(c) and (f) and paragraphs (d), (e), and (f) of this section.

(2) Each pump in light liquid service shall be checked by visual inspection each calendar week for indications of liquids dripping from the pump seal, except as provided in §60.482-1(f).

(b)(1) If an instrument reading of 10,000 ppm or greater is measured, a leak is detected.

(2) If there are indications of liquids dripping from the pump seal, the owner or operator shall follow the procedure specified in either paragraph (b)(2)(i) or (ii) of this section. This requirement does not apply to a pump that was monitored after a previous weekly inspection if the instrument reading for that monitoring event was less than 10,000 ppm and the pump was not repaired since that monitoring event.

(i) Monitor the pump within 5 days as specified in §60.485(b). If an instrument reading of 10,000 ppm or greater is measured, a leak is detected. The leak shall be repaired using the procedures in paragraph (c) of this section.

(ii) Designate the visual indications of liquids dripping as a leak, and repair the leak within 15 days of detection by eliminating the visual indications of liquids dripping.

(c)(1) When a leak is detected, it shall be repaired as soon as practicable, but not later than 15 calendar days after it is detected, except as provided in §60.482-9.

(2) A first attempt at repair shall be made no later than 5 calendar days after each leak is detected. First attempts at repair include, but are not limited to, the practices described in paragraphs (c)(2)(i) and (ii) of this section, where practicable.

(i) Tightening the packing gland nuts;

(ii) Ensuring that the seal flush is operating at design pressure and temperature.

(d) Each pump equipped with a dual mechanical seal system that includes a barrier fluid system is exempt from the requirements of paragraph (a) of this section, provided the requirements specified in paragraphs (d)(1) through (6) of this section are met.

(1) Each dual mechanical seal system is—

(i) Operated with the barrier fluid at a pressure that is at all times greater than the pump stuffing box pressure; or

(ii) Equipped with a barrier fluid degassing reservoir that is routed to a process or fuel gas system or connected by a closed vent system to a control device that complies with the requirements of §60.482-10;  
or

(iii) Equipped with a system that purges the barrier fluid into a process stream with zero VOC emissions to the atmosphere.

(2) The barrier fluid system is in heavy liquid service or is not in VOC service.

(3) Each barrier fluid system is equipped with a sensor that will detect failure of the seal system, the barrier fluid system, or both.

(4)(i) Each pump is checked by visual inspection, each calendar week, for indications of liquids dripping from the pump seals.

(ii) If there are indications of liquids dripping from the pump seal at the time of the weekly inspection, the owner or operator shall follow the procedure specified in either paragraph (d)(4)(ii)(A) or (B) of this section.

(A) Monitor the pump within 5 days as specified in §60.485(b) to determine if there is a leak of VOC in the barrier fluid. If an instrument reading of 10,000 ppm or greater is measured, a leak is detected.

(B) Designate the visual indications of liquids dripping as a leak.

(5)(i) Each sensor as described in paragraph (d)(3) of this section is checked daily or is equipped with an audible alarm.

(ii) The owner or operator determines, based on design considerations and operating experience, a criterion that indicates failure of the seal system, the barrier fluid system, or both.

(iii) If the sensor indicates failure of the seal system, the barrier fluid system, or both, based on the criterion established in paragraph (d)(5)(ii) of this section, a leak is detected.

(6)(i) When a leak is detected pursuant to paragraph (d)(4)(ii)(A) of this section, it shall be repaired as specified in paragraph (c) of this section.

(ii) A leak detected pursuant to paragraph (d)(5)(iii) of this section shall be repaired within 15 days of detection by eliminating the conditions that activated the sensor.

(iii) A designated leak pursuant to paragraph (d)(4)(ii)(B) of this section shall be repaired within 15 days of detection by eliminating visual indications of liquids dripping.

(e) Any pump that is designated, as described in §60.486(e)(1) and (2), for no detectable emissions, as indicated by an instrument reading of less than 500 ppm above background, is exempt from the requirements of paragraphs (a), (c), and (d) of this section if the pump:

(1) Has no externally actuated shaft penetrating the pump housing,

(2) Is demonstrated to be operating with no detectable emissions as indicated by an instrument reading of less than 500 ppm above background as measured by the methods specified in §60.485(c), and

(3) Is tested for compliance with paragraph (e)(2) of this section initially upon designation, annually, and at other times requested by the Administrator.

(f) If any pump is equipped with a closed vent system capable of capturing and transporting any leakage from the seal or seals to a process or to a fuel gas system or to a control device that complies with the requirements of §60.482-10, it is exempt from paragraphs (a) through (e) of this section.

(g) Any pump that is designated, as described in §60.486(f)(1), as an unsafe-to-monitor pump is exempt from the monitoring and inspection requirements of paragraphs (a) and (d)(4) through (6) of this section if:

(1) The owner or operator of the pump demonstrates that the pump is unsafe-to-monitor because monitoring personnel would be exposed to an immediate danger as a consequence of complying with paragraph (a) of this section; and

(2) The owner or operator of the pump has a written plan that requires monitoring of the pump as frequently as practicable during safe-to-monitor times but not more frequently than the periodic monitoring schedule otherwise applicable, and repair of the equipment according to the procedures in paragraph (c) of this section if a leak is detected.

(h) Any pump that is located within the boundary of an unmanned plant site is exempt from the weekly visual inspection requirement of paragraphs (a)(2) and (d)(4) of this section, and the daily requirements of paragraph (d)(5) of this section, provided that each pump is visually inspected as often as practicable and at least monthly.

[48 FR 48335, Oct. 18, 1983, as amended at 65 FR 61762, Oct. 17, 2000; 65 FR 78276, Dec. 14, 2000; 72 FR 64880, Nov. 16, 2007]

[↑ Back to Top](#)

### **§60.482-3 Standards: Compressors.**

(a) Each compressor shall be equipped with a seal system that includes a barrier fluid system and that prevents leakage of VOC to the atmosphere, except as provided in §60.482-1(c) and paragraphs (h), (i), and (j) of this section.

(b) Each compressor seal system as required in paragraph (a) shall be:

(1) Operated with the barrier fluid at a pressure that is greater than the compressor stuffing box pressure; or

(2) Equipped with a barrier fluid system degassing reservoir that is routed to a process or fuel gas system or connected by a closed vent system to a control device that complies with the requirements of §60.482-10; or

(3) Equipped with a system that purges the barrier fluid into a process stream with zero VOC emissions to the atmosphere.

(c) The barrier fluid system shall be in heavy liquid service or shall not be in VOC service.

(d) Each barrier fluid system as described in paragraph (a) shall be equipped with a sensor that will detect failure of the seal system, barrier fluid system, or both.

(e)(1) Each sensor as required in paragraph (d) shall be checked daily or shall be equipped with an audible alarm.

(2) The owner or operator shall determine, based on design considerations and operating experience, a criterion that indicates failure of the seal system, the barrier fluid system, or both.

(f) If the sensor indicates failure of the seal system, the barrier system, or both based on the criterion determined under paragraph (e)(2), a leak is detected.

(g)(1) When a leak is detected, it shall be repaired as soon as practicable, but not later than 15 calendar days after it is detected, except as provided in §60.482-9.

(2) A first attempt at repair shall be made no later than 5 calendar days after each leak is detected.

(h) A compressor is exempt from the requirements of paragraphs (a) and (b) of this section, if it is equipped with a closed vent system to capture and transport leakage from the compressor drive shaft back to a process or fuel gas system or to a control device that complies with the requirements of §60.482-10, except as provided in paragraph (i) of this section.

(i) Any compressor that is designated, as described in §60.486(e) (1) and (2), for no detectable emissions, as indicated by an instrument reading of less than 500 ppm above background, is exempt from the requirements of paragraphs (a)-(h) if the compressor:

(1) Is demonstrated to be operating with no detectable emissions, as indicated by an instrument reading of less than 500 ppm above background, as measured by the methods specified in §60.485(c); and

(2) Is tested for compliance with paragraph (i)(1) of this section initially upon designation, annually, and at other times requested by the Administrator.

(j) Any existing reciprocating compressor in a process unit which becomes an affected facility under provisions of §60.14 or §60.15 is exempt from paragraphs (a) through (e) and (h) of this section, provided the owner or operator demonstrates that recasting the distance piece or replacing the compressor are the only options available to bring the compressor into compliance with the provisions of paragraphs (a) through (e) and (h) of this section.

[48 FR 48335, Oct. 18, 1983, as amended at 65 FR 61762, Oct. 17, 2000; 65 FR 78277, Dec. 14, 2000; 72 FR 64881, Nov. 16, 2007]

[↑ Back to Top](#)

#### **§60.482-4 Standards: Pressure relief devices in gas/vapor service.**

(a) Except during pressure releases, each pressure relief device in gas/vapor service shall be operated with no detectable emissions, as indicated by an instrument reading of less than 500 ppm above background, as determined by the methods specified in §60.485(c).

(b)(1) After each pressure release, the pressure relief device shall be returned to a condition of no detectable emissions, as indicated by an instrument reading of less than 500 ppm above background, as soon as practicable, but no later than 5 calendar days after the pressure release, except as provided in §60.482-9.

(2) No later than 5 calendar days after the pressure release, the pressure relief device shall be monitored to confirm the conditions of no detectable emissions, as indicated by an instrument reading of less than 500 ppm above background, by the methods specified in §60.485(c).

(c) Any pressure relief device that is routed to a process or fuel gas system or equipped with a closed vent system capable of capturing and transporting leakage through the pressure relief device to a control device as described in §60.482-10 is exempted from the requirements of paragraphs (a) and (b) of this section.

(d)(1) Any pressure relief device that is equipped with a rupture disk upstream of the pressure relief device is exempt from the requirements of paragraphs (a) and (b) of this section, provided the owner or operator complies with the requirements in paragraph (d)(2) of this section.

(2) After each pressure release, a new rupture disk shall be installed upstream of the pressure relief device as soon as practicable, but no later than 5 calendar days after each pressure release, except as provided in §60.482-9.

[48 FR 48335, Oct. 18, 1983, as amended at 65 FR 61762, Oct. 17, 2000; 65 FR 78277, Dec. 14, 2000]

[↑ Back to Top](#)

#### **§60.482-5 Standards: Sampling connection systems.**

(a) Each sampling connection system shall be equipped with a closed-purge, closed-loop, or closed-vent system, except as provided in §60.482-1(c) and paragraph (c) of this section.

(b) Each closed-purge, closed-loop, or closed-vent system as required in paragraph (a) of this section shall comply with the requirements specified in paragraphs (b)(1) through (4) of this section.

(1) Gases displaced during filling of the sample container are not required to be collected or captured.

(2) Containers that are part of a closed-purge system must be covered or closed when not being filled or emptied.

(3) Gases remaining in the tubing or piping between the closed-purge system valve(s) and sample container valve(s) after the valves are closed and the sample container is disconnected are not required to be collected or captured.

(4) Each closed-purge, closed-loop, or closed-vent system shall be designed and operated to meet requirements in either paragraph (b)(4)(i), (ii), (iii), or (iv) of this section.

(i) Return the purged process fluid directly to the process line.

(ii) Collect and recycle the purged process fluid to a process.



(iii) Capture and transport all the purged process fluid to a control device that complies with the requirements of §60.482-10.

(iv) Collect, store, and transport the purged process fluid to any of the following systems or facilities:

(A) A waste management unit as defined in §63.111, if the waste management unit is subject to and operated in compliance with the provisions of 40 CFR part 63, subpart G, applicable to Group 1 wastewater streams;

(B) A treatment, storage, or disposal facility subject to regulation under 40 CFR part 262, 264, 265, or 266;

(C) A facility permitted, licensed, or registered by a state to manage municipal or industrial solid waste, if the process fluids are not hazardous waste as defined in 40 CFR part 261;

(D) A waste management unit subject to and operated in compliance with the treatment requirements of §61.348(a), provided all waste management units that collect, store, or transport the purged process fluid to the treatment unit are subject to and operated in compliance with the management requirements of §§61.343 through 61.347; or

(E) A device used to burn off-specification used oil for energy recovery in accordance with 40 CFR part 279, subpart G, provided the purged process fluid is not hazardous waste as defined in 40 CFR part 261.

(c) In situ sampling systems and sampling systems without purges are exempt from the requirements of paragraphs (a) and (b) of this section.

[60 FR 43258, Aug. 18, 1995, as amended at 65 FR 61762, Oct. 17, 2000; 65 FR 78277, Dec. 14, 2000; 72 FR 64881, Nov. 16, 2007]

[↑ Back to Top](#)

#### **§60.482-6 Standards: Open-ended valves or lines.**

(a)(1) Each open-ended valve or line shall be equipped with a cap, blind flange, plug, or a second valve, except as provided in §60.482-1(c) and paragraphs (d) and (e) of this section.

(2) The cap, blind flange, plug, or second valve shall seal the open end at all times except during operations requiring process fluid flow through the open-ended valve or line.

(b) Each open-ended valve or line equipped with a second valve shall be operated in a manner such that the valve on the process fluid end is closed before the second valve is closed.

(c) When a double block-and-bleed system is being used, the bleed valve or line may remain open during operations that require venting the line between the block valves but shall comply with paragraph (a) at all other times.

(d) Open-ended valves or lines in an emergency shutdown system which are designed to open automatically in the event of a process upset are exempt from the requirements of paragraphs (a), (b) and (c) of this section.

(e) Open-ended valves or lines containing materials which would autocatalytically polymerize or would present an explosion, serious overpressure, or other safety hazard if capped or equipped with a double block and bleed system as specified in paragraphs (a) through (c) of this section are exempt from the requirements of paragraphs (a) through (c) of this section.

[48 FR 48335, Oct. 18, 1983, as amended at 49 FR 22607, May 30, 1984; 65 FR 78277, Dec. 14, 2000; 72 FR 64881, Nov. 16, 2007]

[↑ Back to Top](#)

#### **§60.482-7 Standards: Valves in gas/vapor service and in light liquid service.**

(a)(1) Each valve shall be monitored monthly to detect leaks by the methods specified in §60.485(b) and shall comply with paragraphs (b) through (e) of this section, except as provided in paragraphs (f), (g), and (h) of this section, §60.482-1(c) and (f), and §§60.483-1 and 60.483-2.

(2) A valve that begins operation in gas/vapor service or light liquid service after the initial startup date for the process unit must be monitored according to paragraphs (a)(2)(i) or (ii), except for a valve that replaces a leaking valve and except as provided in paragraphs (f), (g), and (h) of this section, §60.482-1(c), and §§60.483-1 and 60.483-2.

(i) Monitor the valve as in paragraph (a)(1) of this section. The valve must be monitored for the first time within 30 days after the end of its startup period to ensure proper installation.

(ii) If the valves on the process unit are monitored in accordance with §60.483-1 or §60.483-2, count the new valve as leaking when calculating the percentage of valves leaking as described in §60.483-2(b)(5). If less than 2.0 percent of the valves are leaking for that process unit, the valve must be monitored for the first time during the next scheduled monitoring event for existing valves in the process unit or within 90 days, whichever comes first.

(b) If an instrument reading of 10,000 ppm or greater is measured, a leak is detected.

(c)(1)(i) Any valve for which a leak is not detected for 2 successive months may be monitored the first month of every quarter, beginning with the next quarter, until a leak is detected.

(ii) As an alternative to monitoring all of the valves in the first month of a quarter, an owner or operator may elect to subdivide the process unit into 2 or 3 subgroups of valves and monitor each subgroup in a different month during the quarter, provided each subgroup is monitored every 3 months. The owner or operator must keep records of the valves assigned to each subgroup.

(2) If a leak is detected, the valve shall be monitored monthly until a leak is not detected for 2 successive months.

(d)(1) When a leak is detected, it shall be repaired as soon as practicable, but no later than 15 calendar days after the leak is detected, except as provided in §60.482-9.

(2) A first attempt at repair shall be made no later than 5 calendar days after each leak is detected.

(e) First attempts at repair include, but are not limited to, the following best practices where practicable:

- (1) Tightening of bonnet bolts;
- (2) Replacement of bonnet bolts;
- (3) Tightening of packing gland nuts;
- (4) Injection of lubricant into lubricated packing.

(f) Any valve that is designated, as described in §60.486(e)(2), for no detectable emissions, as indicated by an instrument reading of less than 500 ppm above background, is exempt from the requirements of paragraph (a) if the valve:

- (1) Has no external actuating mechanism in contact with the process fluid,
- (2) Is operated with emissions less than 500 ppm above background as determined by the method specified in §60.485(c), and
- (3) Is tested for compliance with paragraph (f)(2) of this section initially upon designation, annually, and at other times requested by the Administrator.

(g) Any valve that is designated, as described in §60.486(f)(1), as an unsafe-to-monitor valve is exempt from the requirements of paragraph (a) if:

- (1) The owner or operator of the valve demonstrates that the valve is unsafe to monitor because monitoring personnel would be exposed to an immediate danger as a consequence of complying with paragraph (a), and
- (2) The owner or operator of the valve adheres to a written plan that requires monitoring of the valve as frequently as practicable during safe-to-monitor times.

(h) Any valve that is designated, as described in §60.486(f)(2), as a difficult-to-monitor valve is exempt from the requirements of paragraph (a) if:

- (1) The owner or operator of the valve demonstrates that the valve cannot be monitored without elevating the monitoring personnel more than 2 meters above a support surface.
- (2) The process unit within which the valve is located either becomes an affected facility through §60.14 or §60.15 or the owner or operator designates less than 3.0 percent of the total number of valves as difficult-to-monitor, and
- (3) The owner or operator of the valve follows a written plan that requires monitoring of the valve at least once per calendar year.

[48 FR 48335, Oct. 18, 1983, as amended at 49 FR 22608, May 30, 1984; 65 FR 61762, Oct. 17, 2000; 72 FR 64881, Nov. 16, 2007]

[↑ Back to Top](#)

**§60.482-8 Standards: Pumps and valves in heavy liquid service, pressure relief devices in light liquid or heavy liquid service, and connectors.**

(a) If evidence of a potential leak is found by visual, audible, olfactory, or any other detection method at pumps and valves in heavy liquid service, pressure relief devices in light liquid or heavy liquid service, and connectors, the owner or operator shall follow either one of the following procedures:

(1) The owner or operator shall monitor the equipment within 5 days by the method specified in §60.485(b) and shall comply with the requirements of paragraphs (b) through (d) of this section.

(2) The owner or operator shall eliminate the visual, audible, olfactory, or other indication of a potential leak within 5 calendar days of detection.

(b) If an instrument reading of 10,000 ppm or greater is measured, a leak is detected.

(c)(1) When a leak is detected, it shall be repaired as soon as practicable, but not later than 15 calendar days after it is detected, except as provided in §60.482-9.

(2) The first attempt at repair shall be made no later than 5 calendar days after each leak is detected.

(d) First attempts at repair include, but are not limited to, the best practices described under §§60.482-2(c)(2) and 60.482-7(e).

[48 CFR 48335, Oct. 18, 1983, as amended at 65 FR 78277, Dec. 14, 2000; 72 FR 64882, Nov. 16, 2007]

[↑ Back to Top](#)

**§60.482-9 Standards: Delay of repair.**

(a) Delay of repair of equipment for which leaks have been detected will be allowed if repair within 15 days is technically infeasible without a process unit shutdown. Repair of this equipment shall occur before the end of the next process unit shutdown. Monitoring to verify repair must occur within 15 days after startup of the process unit.

(b) Delay of repair of equipment will be allowed for equipment which is isolated from the process and which does not remain in VOC service.

(c) Delay of repair for valves will be allowed if:

(1) The owner or operator demonstrates that emissions of purged material resulting from immediate repair are greater than the fugitive emissions likely to result from delay of repair, and

(2) When repair procedures are effected, the purged material is collected and destroyed or recovered in a control device complying with §60.482-10.

(d) Delay of repair for pumps will be allowed if:

(1) Repair requires the use of a dual mechanical seal system that includes a barrier fluid system, and

(2) Repair is completed as soon as practicable, but not later than 6 months after the leak was detected.

(e) Delay of repair beyond a process unit shutdown will be allowed for a valve, if valve assembly replacement is necessary during the process unit shutdown, valve assembly supplies have been depleted, and valve assembly supplies had been sufficiently stocked before the supplies were depleted. Delay of repair beyond the next process unit shutdown will not be allowed unless the next process unit shutdown occurs sooner than 6 months after the first process unit shutdown.

(f) When delay of repair is allowed for a leaking pump or valve that remains in service, the pump or valve may be considered to be repaired and no longer subject to delay of repair requirements if two consecutive monthly monitoring instrument readings are below the leak definition.

[48 FR 48335, Oct. 18, 1983, as amended at 65 FR 78277, Dec. 14, 2000; 72 FR 64882, Nov. 16, 2007]

[↑ Back to Top](#)

#### **§60.482-10 Standards: Closed vent systems and control devices.**

(a) Owners or operators of closed vent systems and control devices used to comply with provisions of this subpart shall comply with the provisions of this section.

(b) Vapor recovery systems (for example, condensers and absorbers) shall be designed and operated to recover the VOC emissions vented to them with an efficiency of 95 percent or greater, or to an exit concentration of 20 parts per million by volume, whichever is less stringent.

(c) Enclosed combustion devices shall be designed and operated to reduce the VOC emissions vented to them with an efficiency of 95 percent or greater, or to an exit concentration of 20 parts per million by volume, on a dry basis, corrected to 3 percent oxygen, whichever is less stringent or to provide a minimum residence time of 0.75 seconds at a minimum temperature of 816 °C.

(d) Flares used to comply with this subpart shall comply with the requirements of §60.18.

(e) Owners or operators of control devices used to comply with the provisions of this subpart shall monitor these control devices to ensure that they are operated and maintained in conformance with their designs.

(f) Except as provided in paragraphs (i) through (k) of this section, each closed vent system shall be inspected according to the procedures and schedule specified in paragraphs (f)(1) and (f)(2) of this section.

(1) If the vapor collection system or closed vent system is constructed of hard-piping, the owner or operator shall comply with the requirements specified in paragraphs (f)(1)(i) and (f)(1)(ii) of this section:

(i) Conduct an initial inspection according to the procedures in §60.485(b); and

(ii) Conduct annual visual inspections for visible, audible, or olfactory indications of leaks.

(2) If the vapor collection system or closed vent system is constructed of ductwork, the owner or operator shall:

(i) Conduct an initial inspection according to the procedures in §60.485(b); and

(ii) Conduct annual inspections according to the procedures in §60.485(b).

(g) Leaks, as indicated by an instrument reading greater than 500 parts per million by volume above background or by visual inspections, shall be repaired as soon as practicable except as provided in paragraph (h) of this section.

(1) A first attempt at repair shall be made no later than 5 calendar days after the leak is detected.

(2) Repair shall be completed no later than 15 calendar days after the leak is detected.

(h) Delay of repair of a closed vent system for which leaks have been detected is allowed if the repair is technically infeasible without a process unit shutdown or if the owner or operator determines that emissions resulting from immediate repair would be greater than the fugitive emissions likely to result from delay of repair. Repair of such equipment shall be complete by the end of the next process unit shutdown.

(i) If a vapor collection system or closed vent system is operated under a vacuum, it is exempt from the inspection requirements of paragraphs (f)(1)(i) and (f)(2) of this section.

(j) Any parts of the closed vent system that are designated, as described in paragraph (l)(1) of this section, as unsafe to inspect are exempt from the inspection requirements of paragraphs (f)(1)(i) and (f)(2) of this section if they comply with the requirements specified in paragraphs (j)(1) and (j)(2) of this section:

(1) The owner or operator determines that the equipment is unsafe to inspect because inspecting personnel would be exposed to an imminent or potential danger as a consequence of complying with paragraphs (f)(1)(i) or (f)(2) of this section; and

(2) The owner or operator has a written plan that requires inspection of the equipment as frequently as practicable during safe-to-inspect times.

(k) Any parts of the closed vent system that are designated, as described in paragraph (l)(2) of this section, as difficult to inspect are exempt from the inspection requirements of paragraphs (f)(1)(i) and (f)(2) of this section if they comply with the requirements specified in paragraphs (k)(1) through (k)(3) of this section:

(1) The owner or operator determines that the equipment cannot be inspected without elevating the inspecting personnel more than 2 meters above a support surface; and

(2) The process unit within which the closed vent system is located becomes an affected facility through §§60.14 or 60.15, or the owner or operator designates less than 3.0 percent of the total number of closed vent system equipment as difficult to inspect; and

(3) The owner or operator has a written plan that requires inspection of the equipment at least once every 5 years. A closed vent system is exempt from inspection if it is operated under a vacuum.

(l) The owner or operator shall record the information specified in paragraphs (l)(1) through (l)(5) of this section.

- (1) Identification of all parts of the closed vent system that are designated as unsafe to inspect, an explanation of why the equipment is unsafe to inspect, and the plan for inspecting the equipment.
  - (2) Identification of all parts of the closed vent system that are designated as difficult to inspect, an explanation of why the equipment is difficult to inspect, and the plan for inspecting the equipment.
  - (3) For each inspection during which a leak is detected, a record of the information specified in §60.486(c).
  - (4) For each inspection conducted in accordance with §60.485(b) during which no leaks are detected, a record that the inspection was performed, the date of the inspection, and a statement that no leaks were detected.
  - (5) For each visual inspection conducted in accordance with paragraph (f)(1)(ii) of this section during which no leaks are detected, a record that the inspection was performed, the date of the inspection, and a statement that no leaks were detected.
- (m) Closed vent systems and control devices used to comply with provisions of this subpart shall be operated at all times when emissions may be vented to them.

[48 FR 48335, Oct. 18, 1983, as amended at 51 FR 2702, Jan. 21, 1986; 60 FR 43258, Aug. 18, 1995; 61 FR 29878, June 12, 1996; 65 FR 78277, Dec. 14, 2000]

[↑ Back to Top](#)

#### **§60.483-1 Alternative standards for valves—allowable percentage of valves leaking.**

- (a) An owner or operator may elect to comply with an allowable percentage of valves leaking of equal to or less than 2.0 percent.
- (b) The following requirements shall be met if an owner or operator wishes to comply with an allowable percentage of valves leaking:
  - (1) An owner or operator must notify the Administrator that the owner or operator has elected to comply with the allowable percentage of valves leaking before implementing this alternative standard, as specified in §60.487(d).
  - (2) A performance test as specified in paragraph (c) of this section shall be conducted initially upon designation, annually, and at other times requested by the Administrator.
  - (3) If a valve leak is detected, it shall be repaired in accordance with §60.482-7(d) and (e).
- (c) Performance tests shall be conducted in the following manner:
  - (1) All valves in gas/vapor and light liquid service within the affected facility shall be monitored within 1 week by the methods specified in §60.485(b).
  - (2) If an instrument reading of 10,000 ppm or greater is measured, a leak is detected.

(3) The leak percentage shall be determined by dividing the number of valves for which leaks are detected by the number of valves in gas/vapor and light liquid service within the affected facility.

(d) Owners and operators who elect to comply with this alternative standard shall not have an affected facility with a leak percentage greater than 2.0 percent, determined as described in §60.485(h).

[48 FR 48335, Oct. 18, 1983, as amended at 65 FR 61762, Oct. 17, 2000; 65 FR 78278, Dec. 14, 2000; 72 FR 64882, Nov. 16, 2007]

[↑ Back to Top](#)

#### **§60.483-2 Alternative standards for valves—skip period leak detection and repair.**

(a)(1) An owner or operator may elect to comply with one of the alternative work practices specified in paragraphs (b)(2) and (3) of this section.

(2) An owner or operator must notify the Administrator before implementing one of the alternative work practices, as specified in §60.487(d).

(b)(1) An owner or operator shall comply initially with the requirements for valves in gas/vapor service and valves in light liquid service, as described in §60.482-7.

(2) After 2 consecutive quarterly leak detection periods with the percent of valves leaking equal to or less than 2.0, an owner or operator may begin to skip 1 of the quarterly leak detection periods for the valves in gas/vapor and light liquid service.

(3) After 5 consecutive quarterly leak detection periods with the percent of valves leaking equal to or less than 2.0, an owner or operator may begin to skip 3 of the quarterly leak detection periods for the valves in gas/vapor and light liquid service.

(4) If the percent of valves leaking is greater than 2.0, the owner or operator shall comply with the requirements as described in §60.482-7 but can again elect to use this section.

(5) The percent of valves leaking shall be determined as described in §60.485(h).

(6) An owner or operator must keep a record of the percent of valves found leaking during each leak detection period.

(7) A valve that begins operation in gas/vapor service or light liquid service after the initial startup date for a process unit following one of the alternative standards in this section must be monitored in accordance with §60.482-7(a)(2)(i) or (ii) before the provisions of this section can be applied to that valve.

[48 FR 48335, Oct. 18, 1983, as amended at 65 FR 61762, Oct. 17, 2000; 65 FR 78278, Dec. 14, 2000; 72 FR 64882, Nov. 16, 2007]

[↑ Back to Top](#)

#### **§60.484 Equivalence of means of emission limitation.**



(a) Each owner or operator subject to the provisions of this subpart may apply to the Administrator for determination of equivalence for any means of emission limitation that achieves a reduction in emissions of VOC at least equivalent to the reduction in emissions of VOC achieved by the controls required in this subpart.

(b) Determination of equivalence to the equipment, design, and operational requirements of this subpart will be evaluated by the following guidelines:

(1) Each owner or operator applying for an equivalence determination shall be responsible for collecting and verifying test data to demonstrate equivalence of means of emission limitation.

(2) The Administrator will compare test data for demonstrating equivalence of the means of emission limitation to test data for the equipment, design, and operational requirements.

(3) The Administrator may condition the approval of equivalence on requirements that may be necessary to assure operation and maintenance to achieve the same emission reduction as the equipment, design, and operational requirements.

(c) Determination of equivalence to the required work practices in this subpart will be evaluated by the following guidelines:

(1) Each owner or operator applying for a determination of equivalence shall be responsible for collecting and verifying test data to demonstrate equivalence of an equivalent means of emission limitation.

(2) For each affected facility for which a determination of equivalence is requested, the emission reduction achieved by the required work practice shall be demonstrated.

(3) For each affected facility, for which a determination of equivalence is requested, the emission reduction achieved by the equivalent means of emission limitation shall be demonstrated.

(4) Each owner or operator applying for a determination of equivalence shall commit in writing to work practice(s) that provide for emission reductions equal to or greater than the emission reductions achieved by the required work practice.

(5) The Administrator will compare the demonstrated emission reduction for the equivalent means of emission limitation to the demonstrated emission reduction for the required work practices and will consider the commitment in paragraph (c)(4).

(6) The Administrator may condition the approval of equivalence on requirements that may be necessary to assure operation and maintenance to achieve the same emission reduction as the required work practice.

(d) An owner or operator may offer a unique approach to demonstrate the equivalence of any equivalent means of emission limitation.

(e)(1) After a request for determination of equivalence is received, the Administrator will publish a notice in the Federal Register and provide the opportunity for public hearing if the Administrator judges that the request may be approved.

(2) After notice and opportunity for public hearing, the Administrator will determine the equivalence of a means of emission limitation and will publish the determination in the Federal Register.

(3) Any equivalent means of emission limitations approved under this section shall constitute a required work practice, equipment, design, or operational standard within the meaning of section 111(h)(1) of the Clean Air Act.

(f)(1) Manufacturers of equipment used to control equipment leaks of VOC may apply to the Administrator for determination of equivalence for any equivalent means of emission limitation that achieves a reduction in emissions of VOC achieved by the equipment, design, and operational requirements of this subpart.

(2) The Administrator will make an equivalence determination according to the provisions of paragraphs (b), (c), (d), and (e) of this section.

[48 FR 48335, Oct. 18, 1983, as amended at 65 FR 61762, Oct. 17, 2000; 72 FR 64882, Nov. 16, 2007]

[↑ Back to Top](#)

#### **§60.485 Test methods and procedures.**

(a) In conducting the performance tests required in §60.8, the owner or operator shall use as reference methods and procedures the test methods in appendix A of this part or other methods and procedures as specified in this section, except as provided in §60.8(b).

(b) The owner or operator shall determine compliance with the standards in §§60.482-1 through 60.482-10, 60.483, and 60.484 as follows:

(1) Method 21 shall be used to determine the presence of leaking sources. The instrument shall be calibrated before use each day of its use by the procedures specified in Method 21. The following calibration gases shall be used:

(i) Zero air (less than 10 ppm of hydrocarbon in air); and

(ii) A mixture of methane or n-hexane and air at a concentration of about, but less than, 10,000 ppm methane or n-hexane.

(c) The owner or operator shall determine compliance with the no detectable emission standards in §§60.482-2(e), 60.482-3(i), 60.482-4, 60.482-7(f), and 60.482-10(e) as follows:

(1) The requirements of paragraph (b) shall apply.

(2) Method 21 shall be used to determine the background level. All potential leak interfaces shall be traversed as close to the interface as possible. The arithmetic difference between the maximum concentration indicated by the instrument and the background level is compared with 500 ppm for determining compliance.

(d) The owner or operator shall test each piece of equipment unless he demonstrates that a process unit is not in VOC service, i.e., that the VOC content would never be reasonably expected to exceed 10 percent by weight. For purposes of this demonstration, the following methods and procedures shall be used:

(1) Procedures that conform to the general methods in ASTM E260-73, 91, or 96, E168-67, 77, or 92, E169-63, 77, or 93 (incorporated by reference—see §60.17) shall be used to determine the percent VOC content in the process fluid that is contained in or contacts a piece of equipment.

(2) Organic compounds that are considered by the Administrator to have negligible photochemical reactivity may be excluded from the total quantity of organic compounds in determining the VOC content of the process fluid.

(3) Engineering judgment may be used to estimate the VOC content, if a piece of equipment had not been shown previously to be in service. If the Administrator disagrees with the judgment, paragraphs (d) (1) and (2) of this section shall be used to resolve the disagreement.

(e) The owner or operator shall demonstrate that a piece of equipment is in light liquid service by showing that all the following conditions apply:

(1) The vapor pressure of one or more of the organic components is greater than 0.3 kPa at 20 °C (1.2 in. H<sub>2</sub>O at 68 °F). Standard reference texts or ASTM D2879-83, 96, or 97 (incorporated by reference—see §60.17) shall be used to determine the vapor pressures.

(2) The total concentration of the pure organic components having a vapor pressure greater than 0.3 kPa at 20 °C (1.2 in. H<sub>2</sub>O at 68 °F) is equal to or greater than 20 percent by weight.

(3) The fluid is a liquid at operating conditions.

(f) Samples used in conjunction with paragraphs (d), (e), and (g) of this section shall be representative of the process fluid that is contained in or contacts the equipment or the gas being combusted in the flare.

(g) The owner or operator shall determine compliance with the standards of flares as follows:

(1) Method 22 shall be used to determine visible emissions.

(2) A thermocouple or any other equivalent device shall be used to monitor the presence of a pilot flame in the flare.

(3) The maximum permitted velocity for air assisted flares shall be computed using the following equation:

$$V_{\max} = K_1 + K_2 H_T$$

[View or download PDF](#)

Where:

$V_{\max}$  = Maximum permitted velocity, m/sec (ft/sec)

$H_T$  = Net heating value of the gas being combusted, MJ/scm (Btu/scf).

$K_1$  = 8.706 m/sec (metric units)

= 28.56 ft/sec (English units)

$K_2$  = 0.7084 m<sup>4</sup>/(MJ-sec) (metric units)

= 0.087 ft<sup>4</sup>/(Btu-sec) (English units)

(4) The net heating value ( $H_T$ ) of the gas being combusted in a flare shall be computed using the following equation:

$$H_T = K \sum_{i=1}^n C_i H_i$$

[View or download PDF](#)

Where:

$K$  = Conversion constant,  $1.740 \times 10^{-7}$  (g-mole)(MJ)/(ppm-scm-kcal) (metric units) =  $4.674 \times 10^{-6}$  [(g-mole)(Btu)/(ppm-scf-kcal)] (English units)

$C_i$  = Concentration of sample component “i,” ppm

$H_i$  = Net heat of combustion of sample component “i” at 25 °C and 760 mm Hg (77 °F and 14.7 psi), kcal/g-mole

(5) Method 18 or ASTM D6420-99 (2004) (where the target compound(s) are those listed in Section 1.1 of ASTM D6420-99, and the target concentration is between 150 parts per billion by volume and 100 parts per million by volume) and ASTM D2504-67, 77 or 88 (Reapproved 1993) (incorporated by reference—see §60.17) shall be used to determine the concentration of sample component “i.”

(6) ASTM D2382-76 or 88 or D4809-95 (incorporated by reference—see §60.17) shall be used to determine the net heat of combustion of component “i” if published values are not available or cannot be calculated.

(7) Method 2, 2A, 2C, or 2D, as appropriate, shall be used to determine the actual exit velocity of a flare. If needed, the unobstructed (free) cross-sectional area of the flare tip shall be used.

(h) The owner or operator shall determine compliance with §60.483-1 or §60.483-2 as follows:

(1) The percent of valves leaking shall be determined using the following equation:

$$\% V_L = (V_L/V_T) * 100$$

Where:

$\% V_L$  = Percent leaking valves

$V_L$  = Number of valves found leaking

$V_T$  = The sum of the total number of valves monitored

(2) The total number of valves monitored shall include difficult-to-monitor and unsafe-to-monitor valves only during the monitoring period in which those valves are monitored.

(3) The number of valves leaking shall include valves for which repair has been delayed.

(4) Any new valve that is not monitored within 30 days of being placed in service shall be included in the number of valves leaking and the total number of valves monitored for the monitoring period in which the valve is placed in service.

(5) If the process unit has been subdivided in accordance with §60.482-7(c)(1)(ii), the sum of valves found leaking during a monitoring period includes all subgroups.

(6) The total number of valves monitored does not include a valve monitored to verify repair.

[54 FR 6678, Feb. 14, 1989, as amended at 54 FR 27016, June 27, 1989; 65 FR 61763, Oct. 17, 2000; 72 FR 64882, Nov. 16, 2007]

[↑ Back to Top](#)

#### **§60.486 Recordkeeping requirements.**

(a)(1) Each owner or operator subject to the provisions of this subpart shall comply with the recordkeeping requirements of this section.

(2) An owner or operator of more than one affected facility subject to the provisions of this subpart may comply with the recordkeeping requirements for these facilities in one recordkeeping system if the system identifies each record by each facility.

(b) When each leak is detected as specified in §§60.482-2, 60.482-3, 60.482-7, 60.482-8, and 60.483-2, the following requirements apply:

(1) A weatherproof and readily visible identification, marked with the equipment identification number, shall be attached to the leaking equipment.

(2) The identification on a valve may be removed after it has been monitored for 2 successive months as specified in §60.482-7(c) and no leak has been detected during those 2 months.

(3) The identification on equipment except on a valve, may be removed after it has been repaired.

(c) When each leak is detected as specified in §§60.482-2, 60.482-3, 60.482-7, 60.482-8, and 60.483-2, the following information shall be recorded in a log and shall be kept for 2 years in a readily accessible location:

(1) The instrument and operator identification numbers and the equipment identification number.

(2) The date the leak was detected and the dates of each attempt to repair the leak.

- (3) Repair methods applied in each attempt to repair the leak.
  - (4) "Above 10,000" if the maximum instrument reading measured by the methods specified in §60.485(a) after each repair attempt is equal to or greater than 10,000 ppm.
  - (5) "Repair delayed" and the reason for the delay if a leak is not repaired within 15 calendar days after discovery of the leak.
  - (6) The signature of the owner or operator (or designate) whose decision it was that repair could not be effected without a process shutdown.
  - (7) The expected date of successful repair of the leak if a leak is not repaired within 15 days.
  - (8) Dates of process unit shutdowns that occur while the equipment is unrepaired.
  - (9) The date of successful repair of the leak.
- (d) The following information pertaining to the design requirements for closed vent systems and control devices described in §60.482-10 shall be recorded and kept in a readily accessible location:
- (1) Detailed schematics, design specifications, and piping and instrumentation diagrams.
  - (2) The dates and descriptions of any changes in the design specifications.
  - (3) A description of the parameter or parameters monitored, as required in §60.482-10(e), to ensure that control devices are operated and maintained in conformance with their design and an explanation of why that parameter (or parameters) was selected for the monitoring.
  - (4) Periods when the closed vent systems and control devices required in §§60.482-2, 60.482-3, 60.482-4, and 60.482-5 are not operated as designed, including periods when a flare pilot light does not have a flame.
  - (5) Dates of startups and shutdowns of the closed vent systems and control devices required in §§60.482-2, 60.482-3, 60.482-4, and 60.482-5.
- (e) The following information pertaining to all equipment subject to the requirements in §§60.482-1 to 60.482-10 shall be recorded in a log that is kept in a readily accessible location:
- (1) A list of identification numbers for equipment subject to the requirements of this subpart.
  - (2)(i) A list of identification numbers for equipment that are designated for no detectable emissions under the provisions of §§60.482-2(e), 60.482-3(i) and 60.482-7(f).
  - (ii) The designation of equipment as subject to the requirements of §60.482-2(e), §60.482-3(i), or §60.482-7(f) shall be signed by the owner or operator. Alternatively, the owner or operator may establish a mechanism with their permitting authority that satisfies this requirement.
  - (3) A list of equipment identification numbers for pressure relief devices required to comply with §60.482-4.

(4)(i) The dates of each compliance test as required in §§60.482-2(e), 60.482-3(i), 60.482-4, and 60.482-7(f).

(ii) The background level measured during each compliance test.

(iii) The maximum instrument reading measured at the equipment during each compliance test.

(5) A list of identification numbers for equipment in vacuum service.

(6) A list of identification numbers for equipment that the owner or operator designates as operating in VOC service less than 300 hr/yr in accordance with §60.482-1(e), a description of the conditions under which the equipment is in VOC service, and rationale supporting the designation that it is in VOC service less than 300 hr/yr.

(f) The following information pertaining to all valves subject to the requirements of §60.482-7(g) and (h) and to all pumps subject to the requirements of §60.482-2(g) shall be recorded in a log that is kept in a readily accessible location:

(1) A list of identification numbers for valves and pumps that are designated as unsafe-to-monitor, an explanation for each valve or pump stating why the valve or pump is unsafe-to-monitor, and the plan for monitoring each valve or pump.

(2) A list of identification numbers for valves that are designated as difficult-to-monitor, an explanation for each valve stating why the valve is difficult-to-monitor, and the schedule for monitoring each valve.

(g) The following information shall be recorded for valves complying with §60.483-2:

(1) A schedule of monitoring.

(2) The percent of valves found leaking during each monitoring period.

(h) The following information shall be recorded in a log that is kept in a readily accessible location:

(1) Design criterion required in §§60.482-2(d)(5) and 60.482-3(e)(2) and explanation of the design criterion; and

(2) Any changes to this criterion and the reasons for the changes.

(i) The following information shall be recorded in a log that is kept in a readily accessible location for use in determining exemptions as provided in §60.480(d):

(1) An analysis demonstrating the design capacity of the affected facility,

(2) A statement listing the feed or raw materials and products from the affected facilities and an analysis demonstrating whether these chemicals are heavy liquids or beverage alcohol, and

(3) An analysis demonstrating that equipment is not in VOC service.

(j) Information and data used to demonstrate that a piece of equipment is not in VOC service shall be recorded in a log that is kept in a readily accessible location.

(k) The provisions of §60.7 (b) and (d) do not apply to affected facilities subject to this subpart.

[48 FR 48335, Oct. 18, 1983, as amended at 65 FR 61763, Oct. 17, 2000; 65 FR 78278, Dec. 14, 2000; 72 FR 64883, Nov. 16, 2007]

[↑ Back to Top](#)

**§60.487 Reporting requirements.**

(a) Each owner or operator subject to the provisions of this subpart shall submit semiannual reports to the Administrator beginning six months after the initial startup date.

(b) The initial semiannual report to the Administrator shall include the following information:

(1) Process unit identification.

(2) Number of valves subject to the requirements of §60.482-7, excluding those valves designated for no detectable emissions under the provisions of §60.482-7(f).

(3) Number of pumps subject to the requirements of §60.482-2, excluding those pumps designated for no detectable emissions under the provisions of §60.482-2(e) and those pumps complying with §60.482-2(f).

(4) Number of compressors subject to the requirements of §60.482-3, excluding those compressors designated for no detectable emissions under the provisions of §60.482-3(i) and those compressors complying with §60.482-3(h).

(c) All semiannual reports to the Administrator shall include the following information, summarized from the information in §60.486:

(1) Process unit identification.

(2) For each month during the semiannual reporting period,

(i) Number of valves for which leaks were detected as described in §60.482-7(b) or §60.483-2,

(ii) Number of valves for which leaks were not repaired as required in §60.482-7(d)(1),

(iii) Number of pumps for which leaks were detected as described in §60.482-2(b), (d)(4)(ii)(A) or (B), or (d)(5)(iii),

(iv) Number of pumps for which leaks were not repaired as required in §60.482-2(c)(1) and (d)(6),

(v) Number of compressors for which leaks were detected as described in §60.482-3(f),

(vi) Number of compressors for which leaks were not repaired as required in §60.482-3(g)(1), and

(vii) The facts that explain each delay of repair and, where appropriate, why a process unit shutdown was technically infeasible.

(3) Dates of process unit shutdowns which occurred within the semiannual reporting period.



(4) Revisions to items reported according to paragraph (b) if changes have occurred since the initial report or subsequent revisions to the initial report.

(d) An owner or operator electing to comply with the provisions of §§60.483-1 or 60.483-2 shall notify the Administrator of the alternative standard selected 90 days before implementing either of the provisions.

(e) An owner or operator shall report the results of all performance tests in accordance with §60.8 of the General Provisions. The provisions of §60.8(d) do not apply to affected facilities subject to the provisions of this subpart except that an owner or operator must notify the Administrator of the schedule for the initial performance tests at least 30 days before the initial performance tests.

(f) The requirements of paragraphs (a) through (c) of this section remain in force until and unless EPA, in delegating enforcement authority to a State under section 111(c) of the Act, approves reporting requirements or an alternative means of compliance surveillance adopted by such State. In that event, affected sources within the State will be relieved of the obligation to comply with the requirements of paragraphs (a) through (c) of this section, provided that they comply with the requirements established by the State.

[48 FR 48335, Oct. 18, 1983, as amended at 49 FR 22608, May 30, 1984; 65 FR 61763, Oct. 17, 2000; 72 FR 64883, Nov. 16, 2007]

[↑ Back to Top](#)

#### **§60.488 Reconstruction.**

For the purposes of this subpart:

(a) The cost of the following frequently replaced components of the facility shall not be considered in calculating either the “fixed capital cost of the new components” or the “fixed capital costs that would be required to construct a comparable new facility” under §60.15: pump seals, nuts and bolts, rupture disks, and packings.

(b) Under §60.15, the “fixed capital cost of new components” includes the fixed capital cost of all depreciable components (except components specified in §60.488 (a)) which are or will be replaced pursuant to all continuous programs of component replacement which are commenced within any 2-year period following the applicability date for the appropriate subpart. (See the “Applicability and designation of affected facility” section of the appropriate subpart.) For purposes of this paragraph, “commenced” means that an owner or operator has undertaken a continuous program of component replacement or that an owner or operator has entered into a contractual obligation to undertake and complete, within a reasonable time, a continuous program of component replacement.

[49 FR 22608, May 30, 1984]

[↑ Back to Top](#)

#### **§60.489 List of chemicals produced by affected facilities.**

The following chemicals are produced, as intermediates or final products, by process units covered under this subpart. The applicability date for process units producing one or more of these chemicals is January 5, 1981.

<b>CAS No. <sup>a</sup></b>	<b>Chemical</b>
105-57-7	Acetal.
75-07-0	Acetaldehyde.
107-89-1	Acetaldol.
60-35-5	Acetamide.
103-84-4	Acetanilide.
64-19-7	Acetic acid.
108-24-7	Acetic anhydride.
67-64-1	Acetone.
75-86-5	Acetone cyanohydrin.
75-05-8	Acetonitrile.
98-86-2	Acetophenone.
75-36-5	Acetyl chloride.
74-86-2	Acetylene.
107-02-8	Acrolein.
79-06-1	Acrylamide.
79-10-7	Acrylic acid.
107-13-1	Acrylonitrile.

124-04-9	Adipic acid.
111-69-3	Adiponitrile.
( <sup>b</sup> )	Alkyl naphthalenes.
107-18-6	Allyl alcohol.
107-05-1	Allyl chloride.
1321-11-5	Aminobenzoic acid.
111-41-1	Aminoethylethanolamine.
123-30-8	p-Aminophenol.
628-63-7, 123-92-2	Amyl acetates.
71-41-0 <sup>c</sup>	Amyl alcohols.
110-58-7	Amyl amine.
543-59-9	Amyl chloride.
110-66-7 <sup>c</sup>	Amyl mercaptans.
1322-06-1	Amyl phenol.
62-53-3	Aniline.
142-04-1	Aniline hydrochloride.
29191-52-4	Anisidine.
100-66-3	Anisole.
118-92-3	Anthranilic acid.
84-65-1	Anthraquinone.

100-52-7	Benzaldehyde.
55-21-0	Benzamide.
71-43-2	Benzene.
98-48-6	Benzenedisulfonic acid.
98-11-3	Benzenesulfonic acid.
134-81-6	Benzil.
76-93-7	Benzilic acid.
65-85-0	Benzoic acid.
119-53-9	Benzoin.
100-47-0	Benzonitrile.
119-61-9	Benzophenone.
98-07-7	Benzotrichloride.
98-88-4	Benzoyl chloride.
100-51-6	Benzyl alcohol.
100-46-9	Benzylamine.
120-51-4	Benzyl benzoate.
100-44-7	Benzyl chloride.
98-87-3	Benzyl dichloride.
92-52-4	Biphenyl.
80-05-7	Bisphenol A.

10-86-1	Bromobenzene.
27497-51-4	Bromonaphthalene.
106-99-0	Butadiene.
106-98-9	1-butene.
123-86-4	n-butyl acetate.
141-32-2	n-butyl acrylate.
71-36-3	n-butyl alcohol.
78-92-2	s-butyl alcohol.
75-65-0	t-butyl alcohol.
109-73-9	n-butylamine.
13952-84-6	s-butylamine.
75-64-9	t-butylamine.
98-73-7	p-tert-butyl benzoic acid.
107-88-0	1,3-butylene glycol.
123-72-8	n-butyraldehyde.
107-92-6	Butyric acid.
106-31-0	Butyric anhydride.
109-74-0	Butyronitrile.
105-60-2	Caprolactam.
75-1-50	Carbon disulfide.

558-13-4	Carbon tetrabromide.
56-23-5	Carbon tetrachloride.
9004-35-7	Cellulose acetate.
79-11-8	Chloroacetic acid.
108-42-9	m-chloroaniline.
95-51-2	o-chloroaniline.
106-47-8	p-chloroaniline.
35913-09-8	Chlorobenzaldehyde.
108-90-7	Chlorobenzene.
118-91-2, 535-80-8, 74-11-3 <sup>c</sup>	Chlorobenzoic acid.
2136-81-4, 2136-89-2, 5216-25-1 <sup>c</sup>	Chlorobenzotrichloride.
1321-03-5	Chlorobenzoyl chloride.
25497-29-4	Chlorodifluoromethane.
75-45-6	Chlorodifluoroethane.
67-66-3	Chloroform.
25586-43-0	Chloronaphthalene.
88-73-3	o-chloronitrobenzene.
100-00-5	p-chloronitrobenzene.
25167-80-0	Chlorophenols.
126-99-8	Chloroprene.

7790-94-5	Chlorosulfonic acid.
108-41-8	m-chlorotoluene.
95-49-8	o-chlorotoluene.
106-43-4	p-chlorotoluene.
75-72-9	Chlorotrifluoromethane.
108-39-4	m-cresol.
95-48-7	o-cresol.
106-44-5	p-cresol.
1319-77-3	Mixed cresols.
1319-77-3	Cresylic acid.
4170-30-0	Crotonaldehyde.
3724-65-0	Crotonic acid.
98-82-8	Cumene.
80-15-9	Cumene hydroperoxide.
372-09-8	Cyanoacetic acid.
506-77-4	Cyanogen chloride.
108-80-5	Cyanuric acid.
108-77-0	Cyanuric chloride.
110-82-7	Cyclohexane.
108-93-0	Cyclohexanol.

108-94-1	Cyclohexanone.
110-83-8	Cyclohexene.
108-91-8	Cyclohexylamine.
111-78-4	Cyclooctadiene.
112-30-1	Decanol.
123-42-2	Diacetone alcohol.
27576-04-1	Diaminobenzoic acid.
95-76-1, 95-82-9, 554-00-7, 608-27-5, 608-31-1, 626-43-7, 27134-27-6, 57311-92-9 <sup>c</sup>	Dichloroaniline.
541-73-1	m-dichlorobenzene.
95-50-1	o-dichlorobenzene.
106-46-7	p-dichlorobenzene.
75-71-8	Dichlorodifluoromethane.
111-44-4	Dichloroethyl ether.
107-06-2	1,2-dichloroethane (EDC).
96-23-1	Dichlorohydrin.
26952-23-8	Dichloropropene.
101-83-7	Dicyclohexylamine.
109-89-7	Diethylamine.
111-46-6	Diethylene glycol.



112-36-7	Diethylene glycol diethyl ether.
111-96-6	Diethylene glycol dimethyl ether.
112-34-5	Diethylene glycol monobutyl ether.
124-17-4	Diethylene glycol monobutyl ether acetate.
111-90-0	Diethylene glycol monoethyl ether.
112-15-2	Diethylene glycol monoethyl ether acetate.
111-77-3	Diethylene glycol monomethyl ether.
64-67-5	Diethyl sulfate.
75-37-6	Difluoroethane.
25167-70-8	Diisobutylene.
26761-40-0	Diisodecyl phthalate.
27554-26-3	Diisooctyl phthalate.
674-82-8	Diketene.
124-40-3	Dimethylamine.
121-69-7	N,N-dimethylaniline.
115-10-6	N,N-dimethyl ether.
68-12-2	N,N-dimethylformamide.
57-14-7	Dimethylhydrazine.
77-78-1	Dimethyl sulfate.

75-18-3	Dimethyl sulfide.
67-68-5	Dimethyl sulfoxide.
120-61-6	Dimethyl terephthalate.
99-34-3	3,5-dinitrobenzoic acid.
51-28-5	Dinitrophenol.
25321-14-6	Dinitrotoluene.
123-91-1	Dioxane.
646-06-0	Dioxilane.
122-39-4	Diphenylamine.
101-84-8	Diphenyl oxide.
102-08-9	Diphenyl thiourea.
25265-71-8	Dipropylene glycol.
25378-22-7	Dodecene.
28675-17-4	Dodecylaniline.
27193-86-8	Dodecylphenol.
106-89-8	Epichlorohydrin.
64-17-5	Ethanol.
141-43-5 <sup>c</sup>	Ethanolamines.
141-78-6	Ethyl acetate.
141-97-9	Ethyl acetoacetate.

140-88-5	Ethyl acrylate.
75-04-7	Ethylamine.
100-41-4	Ethylbenzene.
74-96-4	Ethyl bromide.
9004-57-3	Ethylcellulose.
75-00-3	Ethyl chloride.
105-39-5	Ethyl chloroacetate.
105-56-6	Ethylcyanoacetate.
74-85-1	Ethylene.
96-49-1	Ethylene carbonate.
107-07-3	Ethylene chlorohydrin.
107-15-3	Ethylenediamine.
106-93-4	Ethylene dibromide.
107-21-1	Ethylene glycol.
111-55-7	Ethylene glycol diacetate.
110-71-4	Ethylene glycol dimethyl ether.
111-76-2	Ethylene glycol monobutyl ether.
112-07-2	Ethylene glycol monobutyl ether acetate.
110-80-5	Ethylene glycol monoethyl ether.
111-15-9	Ethylene glycol monethyl ether acetate.

109-86-4	Ethylene glycol monomethyl ether.
110-49-6	Ethylene glycol monomethyl ether acetate.
122-99-6	Ethylene glycol monophenyl ether.
2807-30-9	Ethylene glycol monopropyl ether.
75-21-8	Ethylene oxide.
60-29-7	Ethyl ether
104-76-7	2-ethylhexanol.
122-51-0	Ethyl orthoformate.
95-92-1	Ethyl oxalate.
41892-71-1	Ethyl sodium oxalacetate.
50-00-0	Formaldehyde.
75-12-7	Formamide.
64-18-6	Formic acid.
110-17-8	Fumaric acid.
98-01-1	Furfural.
56-81-5	Glycerol.
26545-73-7	Glycerol dichlorohydrin.
25791-96-2	Glycerol triether.
56-40-6	Glycine.

107-22-2	Glyoxal.
118-74-1	Hexachlorobenzene.
67-72-1	Hexachloroethane.
36653-82-4	Hexadecyl alcohol.
124-09-4	Hexamethylenediamine.
629-11-8	Hexamethylene glycol.
100-97-0	Hexamethylenetetramine.
74-90-8	Hydrogen cyanide.
123-31-9	Hydroquinone.
99-96-7	p-hydroxybenzoic acid.
26760-64-5	Isoamylene.
78-83-1	Isobutanol.
110-19-0	Isobutyl acetate.
115-11-7	Isobutylene.
78-84-2	Isobutyraldehyde.
79-31-2	Isobutyric acid.
25339-17-7	Isodecanol.
26952-21-6	Isooctyl alcohol.
78-78-4	Isopentane.
78-59-1	Isophorone.

121-91-5	Isophthalic acid.
78-79-5	Isoprene.
67-63-0	Isopropanol.
108-21-4	Isopropyl acetate.
75-31-0	Isopropylamine.
75-29-6	Isopropyl chloride.
25168-06-3	Isopropylphenol.
463-51-4	Ketene.
( <sup>b</sup> )	Linear alkyl sulfonate.
123-01-3	Linear alkylbenzene (linear dodecylbenzene).
110-16-7	Maleic acid.
108-31-6	Maleic anhydride.
6915-15-7	Malic acid.
141-79-7	Mesityl oxide.
121-47-1	Metanilic acid.
79-41-4	Methacrylic acid.
563-47-3	Methallyl chloride.
67-56-1	Methanol.
79-20-9	Methyl acetate.

105-45-3	Methyl acetoacetate.
74-89-5	Methylamine.
100-61-8	n-methylaniline.
74-83-9	Methyl bromide.
37365-71-2	Methyl butynol.
74-87-3	Methyl chloride.
108-87-2	Methylcyclohexane.
1331-22-2	Methylcyclohexanone.
75-09-2	Methylene chloride.
101-77-9	Methylene dianiline.
101-68-8	Methylene diphenyl diisocyanate.
78-93-3	Methyl ethyl ketone.
107-31-3	Methyl formate.
108-11-2	Methyl isobutyl carbinol.
108-10-1	Methyl isobutyl ketone.
80-62-6	Methyl methacrylate.
77-75-8	Methylpentynol.
98-83-9	a-methylstyrene.
110-91-8	Morpholine.
85-47-2	a-naphthalene sulfonic acid.

120-18-3	b-naphthalene sulfonic acid.
90-15-3	a-naphthol.
135-19-3	b-naphthol.
75-98-9	Neopentanoic acid.
88-74-4	o-nitroaniline.
100-01-6	p-nitroaniline.
91-23-6	o-nitroanisole.
100-17-4	p-nitroanisole.
98-95-3	Nitrobenzene.
27178-83-2 <sup>c</sup>	Nitrobenzoic acid (o,m, and p).
79-24-3	Nitroethane.
75-52-5	Nitromethane.
88-75-5	2-Nitrophenol.
25322-01-4	Nitropropane.
1321-12-6	Nitrotoluene.
27215-95-8	Nonene.
25154-52-3	Nonylphenol.
27193-28-8	Octylphenol.
123-63-7	Paraldehyde.
115-77-5	Pentaerythritol.



109-66-0	n-pentane.
109-67-1	1-pentene
127-18-4	Perchloroethylene.
594-42-3	Perchloromethyl mercaptan.
94-70-2	o-phenetidine.
156-43-4	p-phenetidine.
108-95-2	Phenol.
98-67-9, 585-38-6, 609-46-1, 1333-39-7 <sup>c</sup>	Phenolsulfonic acids.
91-40-7	Phenyl anthranilic acid.
( <sup>b</sup> )	Phenylenediamine.
75-44-5	Phosgene.
85-44-9	Phthalic anhydride.
85-41-6	Phthalimide.
108-99-6	b-picoline.
110-85-0	Piperazine.
9003-29-6, 25036-29-7 <sup>c</sup>	Polybutenes.
25322-68-3	Polyethylene glycol.
25322-69-4	Polypropylene glycol.
123-38-6	Propionaldehyde.
79-09-4	Propionic acid.

71-23-8	n-propyl alcohol.
107-10-8	Propylamine.
540-54-5	Propyl chloride.
115-07-1	Propylene.
127-00-4	Propylene chlorohydrin.
78-87-5	Propylene dichloride.
57-55-6	Propylene glycol.
75-56-9	Propylene oxide.
110-86-1	Pyridine.
106-51-4	Quinone.
108-46-3	Resorcinol.
27138-57-4	Resorcylic acid.
69-72-7	Salicylic acid.
127-09-3	Sodium acetate.
532-32-1	Sodium benzoate.
9004-32-4	Sodium carboxymethyl cellulose.
3926-62-3	Sodium chloroacetate.
141-53-7	Sodium formate.
139-02-6	Sodium phenate.
110-44-1	Sorbic acid.

100-42-5	Styrene.
110-15-6	Succinic acid.
110-61-2	Succinonitrile.
121-57-3	Sulfanilic acid.
126-33-0	Sulfolane.
1401-55-4	Tannic acid.
100-21-0	Terephthalic acid.
79-34-5 <sup>c</sup>	Tetrachloroethanes.
117-08-8	Tetrachlorophthalic anhydride.
78-00-2	Tetraethyl lead.
119-64-2	Tetrahydronaphthalene.
85-43-8	Tetrahydrophthalic anhydride.
75-74-1	Tetramethyl lead.
110-60-1	Tetramethylenediamine.
110-18-9	Tetramethylethylenediamine.
108-88-3	Toluene.
95-80-7	Toluene-2,4-diamine.
584-84-9	Toluene-2,4-diisocyanate.
26471-62-5	Toluene diisocyanates (mixture).
1333-07-9	Toluenesulfonamide.

104-15-4 <sup>c</sup>	Toluenesulfonic acids.
98-59-9	Toluenesulfonyl chloride.
26915-12-8	Toluidines.
87-61-6, 108-70-3, 120-82-1 <sup>c</sup>	Trichlorobenzenes.
71-55-6	1,1,1-trichloroethane.
79-00-5	1,1,2-trichloroethane.
79-01-6	Trichloroethylene.
75-69-4	Trichlorofluoromethane.
96-18-4	1,2,3-trichloropropane.
76-13-1	1,1,2-trichloro-1,2,2-trifluoroethane.
121-44-8	Triethylamine.
112-27-6	Triethylene glycol.
112-49-2	Triethylene glycol dimethyl ether.
7756-94-7	Triisobutylene.
75-50-3	Trimethylamine.
57-13-6	Urea.
108-05-4	Vinyl acetate.
75-01-4	Vinyl chloride.
75-35-4	Vinylidene chloride.
25013-15-4	Vinyl toluene.

1330-20-7	Xylenes (mixed).
95-47-6	o-xylene.
106-42-3	p-xylene.
1300-71-6	Xylenol.
1300-73-8	Xylidine.

<sup>a</sup>CAS numbers refer to the Chemical Abstracts Registry numbers assigned to specific chemicals, isomers, or mixtures of chemicals. Some isomers or mixtures that are covered by the standards do not have CAS numbers assigned to them. The standards apply to all of the chemicals listed, whether CAS numbers have been assigned or not.

<sup>b</sup>No CAS number(s) have been assigned to this chemical, its isomers, or mixtures containing these chemicals.

<sup>c</sup>CAS numbers for some of the isomers are listed; the standards apply to all of the isomers and mixtures, even if CAS numbers have not been assigned.

[48 FR 48335, Oct. 18, 1983, as amended at 65 FR 61763, Oct. 17, 2000]

[↑ Back to Top](#)

# **APPENDIX C**

## Electronic Code of Federal Regulations

---

[View past updates to the e-CFR.](#)

[Click here to learn more.](#)

---

**e-CFR data is current as of January 17, 2017**

[Title 40](#) → [Chapter I](#) → [Subchapter C](#) → [Part 60](#) → [Subpart III](#)

---

[Browse Previous](#) | [Browse Next](#)

Title 40: Protection of Environment

[PART 60—STANDARDS OF PERFORMANCE FOR NEW STATIONARY SOURCES](#)  
(CONTINUED)

---

### **Subpart III—Standards of Performance for Stationary Compression Ignition Internal Combustion Engines**

---

#### **Contents**

[What This Subpart Covers](#)

[§60.4200 Am I subject to this subpart?](#)

[Emission Standards for Manufacturers](#)

[§60.4201 What emission standards must I meet for non-emergency engines if I am a stationary CI internal combustion engine manufacturer?](#)

[§60.4202 What emission standards must I meet for emergency engines if I am a stationary CI internal combustion engine manufacturer?](#)

[§60.4203 How long must my engines meet the emission standards if I am a manufacturer of stationary CI internal combustion engines?](#)

[Emission Standards for Owners and Operators](#)

[§60.4204 What emission standards must I meet for non-emergency engines if I am an owner or operator of a stationary CI internal combustion engine?](#)

[§60.4205 What emission standards must I meet for emergency engines if I am an owner or operator of a stationary CI internal combustion engine?](#)

[§60.4206 How long must I meet the emission standards if I am an owner or operator of a stationary CI internal combustion engine?](#)

## Fuel Requirements for Owners and Operators

§60.4207 What fuel requirements must I meet if I am an owner or operator of a stationary CI internal combustion engine subject to this subpart?

## Other Requirements for Owners and Operators

§60.4208 What is the deadline for importing or installing stationary CI ICE produced in previous model years?

§60.4209 What are the monitoring requirements if I am an owner or operator of a stationary CI internal combustion engine?

## Compliance Requirements

§60.4210 What are my compliance requirements if I am a stationary CI internal combustion engine manufacturer?

§60.4211 What are my compliance requirements if I am an owner or operator of a stationary CI internal combustion engine?

## Testing Requirements for Owners and Operators

§60.4212 What test methods and other procedures must I use if I am an owner or operator of a stationary CI internal combustion engine with a displacement of less than 30 liters per cylinder?

§60.4213 What test methods and other procedures must I use if I am an owner or operator of a stationary CI internal combustion engine with a displacement of greater than or equal to 30 liters per cylinder?

## Notification, Reports, and Records for Owners and Operators

§60.4214 What are my notification, reporting, and recordkeeping requirements if I am an owner or operator of a stationary CI internal combustion engine?

## Special Requirements

§60.4215 What requirements must I meet for engines used in Guam, American Samoa, or the Commonwealth of the Northern Mariana Islands?

§60.4216 What requirements must I meet for engines used in Alaska?

§60.4217 What emission standards must I meet if I am an owner or operator of a stationary internal combustion engine using special fuels?

## General Provisions

§60.4218 What parts of the General Provisions apply to me?

## Definitions

§60.4219 What definitions apply to this subpart?

Table 1 to Subpart III of Part 60—Emission Standards for Stationary Pre-2007 Model Year Engines With a Displacement of <10 Liters per Cylinder and 2007-2010 Model Year Engines >2,237 KW (3,000 HP) and With a Displacement of <10 Liters per Cylinder



[Table 2 to Subpart III of Part 60—Emission Standards for 2008 Model Year and Later Emergency Stationary CI ICE <37 KW \(50 HP\) With a Displacement of <10 Liters per Cylinder](#)

[Table 3 to Subpart III of Part 60—Certification Requirements for Stationary Fire Pump Engines](#)

[Table 4 to Subpart III of Part 60—Emission Standards for Stationary Fire Pump Engines](#)

[Table 5 to Subpart III of Part 60—Labeling and Recordkeeping Requirements for New Stationary Emergency Engines](#)

[Table 6 to Subpart III of Part 60—Optional 3-Mode Test Cycle for Stationary Fire Pump Engines](#)

[Table 7 to Subpart III of Part 60—Requirements for Performance Tests for Stationary CI ICE With a Displacement of  \$\geq 30\$  Liters per Cylinder](#)

[Table 8 to Subpart III of Part 60—Applicability of General Provisions to Subpart III](#)

---

Source: 71 FR 39172, July 11, 2006, unless otherwise noted.

[↑ Back to Top](#)

## What This Subpart Covers

[↑ Back to Top](#)

### **§60.4200 Am I subject to this subpart?**

(a) The provisions of this subpart are applicable to manufacturers, owners, and operators of stationary compression ignition (CI) internal combustion engines (ICE) and other persons as specified in paragraphs (a)(1) through (4) of this section. For the purposes of this subpart, the date that construction commences is the date the engine is ordered by the owner or operator.

(1) Manufacturers of stationary CI ICE with a displacement of less than 30 liters per cylinder where the model year is:

(i) 2007 or later, for engines that are not fire pump engines;

(ii) The model year listed in Table 3 to this subpart or later model year, for fire pump engines.

(2) Owners and operators of stationary CI ICE that commence construction after July 11, 2005, where the stationary CI ICE are:

(i) Manufactured after April 1, 2006, and are not fire pump engines, or

(ii) Manufactured as a certified National Fire Protection Association (NFPA) fire pump engine after July 1, 2006.

(3) Owners and operators of any stationary CI ICE that are modified or reconstructed after July 11, 2005 and any person that modifies or reconstructs any stationary CI ICE after July 11, 2005.

(4) The provisions of §60.4208 of this subpart are applicable to all owners and operators of stationary CI ICE that commence construction after July 11, 2005.

(b) The provisions of this subpart are not applicable to stationary CI ICE being tested at a stationary CI ICE test cell/stand.

(c) If you are an owner or operator of an area source subject to this subpart, you are exempt from the obligation to obtain a permit under 40 CFR part 70 or 40 CFR part 71, provided you are not required to obtain a permit under 40 CFR 70.3(a) or 40 CFR 71.3(a) for a reason other than your status as an area source under this subpart. Notwithstanding the previous sentence, you must continue to comply with the provisions of this subpart applicable to area sources.

(d) Stationary CI ICE may be eligible for exemption from the requirements of this subpart as described in 40 CFR part 1068, subpart C (or the exemptions described in 40 CFR part 89, subpart J and 40 CFR part 94, subpart J, for engines that would need to be certified to standards in those parts), except that owners and operators, as well as manufacturers, may be eligible to request an exemption for national security.

(e) Owners and operators of facilities with CI ICE that are acting as temporary replacement units and that are located at a stationary source for less than 1 year and that have been properly certified as meeting the standards that would be applicable to such engine under the appropriate nonroad engine provisions, are not required to meet any other provisions under this subpart with regard to such engines.

[71 FR 39172, July 11, 2006, as amended at 76 FR 37967, June 28, 2011]

[↑ Back to Top](#)

## **Emission Standards for Manufacturers**

[↑ Back to Top](#)

### **§60.4201 What emission standards must I meet for non-emergency engines if I am a stationary CI internal combustion engine manufacturer?**

(a) Stationary CI internal combustion engine manufacturers must certify their 2007 model year and later non-emergency stationary CI ICE with a maximum engine power less than or equal to 2,237 kilowatt (KW) (3,000 horsepower (HP)) and a displacement of less than 10 liters per cylinder to the certification emission standards for new nonroad CI engines in 40 CFR 89.112, 40 CFR 89.113, 40 CFR 1039.101, 40 CFR 1039.102, 40 CFR 1039.104, 40 CFR 1039.105, 40 CFR 1039.107, and 40 CFR 1039.115, as applicable, for all pollutants, for the same model year and maximum engine power.

(b) Stationary CI internal combustion engine manufacturers must certify their 2007 through 2010 model year non-emergency stationary CI ICE with a maximum engine power greater than 2,237 KW (3,000 HP) and a displacement of less than 10 liters per cylinder to the emission standards in table 1 to this subpart, for all pollutants, for the same maximum engine power.

(c) Stationary CI internal combustion engine manufacturers must certify their 2011 model year and later non-emergency stationary CI ICE with a maximum engine power greater than 2,237 KW (3,000 HP) and a displacement of less than 10 liters per cylinder to the certification emission standards for new nonroad CI engines in 40 CFR 1039.101, 40 CFR 1039.102, 40 CFR 1039.104, 40 CFR 1039.105, 40 CFR 1039.107, and 40 CFR 1039.115, as applicable, for all pollutants, for the same maximum engine power.

(d) Stationary CI internal combustion engine manufacturers must certify the following non-emergency stationary CI ICE to the certification emission standards for new marine CI engines in 40 CFR 94.8, as applicable, for all pollutants, for the same displacement and maximum engine power:

(1) Their 2007 model year through 2012 non-emergency stationary CI ICE with a displacement of greater than or equal to 10 liters per cylinder and less than 30 liters per cylinder;

(2) Their 2013 model year non-emergency stationary CI ICE with a maximum engine power greater than or equal to 3,700 KW (4,958 HP) and a displacement of greater than or equal to 10 liters per cylinder and less than 15 liters per cylinder; and

(3) Their 2013 model year non-emergency stationary CI ICE with a displacement of greater than or equal to 15 liters per cylinder and less than 30 liters per cylinder.

(e) Stationary CI internal combustion engine manufacturers must certify the following non-emergency stationary CI ICE to the certification emission standards and other requirements for new marine CI engines in 40 CFR 1042.101, 40 CFR 1042.107, 40 CFR 1042.110, 40 CFR 1042.115, 40 CFR 1042.120, and 40 CFR 1042.145, as applicable, for all pollutants, for the same displacement and maximum engine power:

(1) Their 2013 model year non-emergency stationary CI ICE with a maximum engine power less than 3,700 KW (4,958 HP) and a displacement of greater than or equal to 10 liters per cylinder and less than 15 liters per cylinder; and

(2) Their 2014 model year and later non-emergency stationary CI ICE with a displacement of greater than or equal to 10 liters per cylinder and less than 30 liters per cylinder.

(f) Notwithstanding the requirements in paragraphs (a) through (c) of this section, stationary non-emergency CI ICE identified in paragraphs (a) and (c) may be certified to the provisions of 40 CFR part 94 or, if Table 1 to 40 CFR 1042.1 identifies 40 CFR part 1042 as being applicable, 40 CFR part 1042, if the engines will be used solely in either or both of the following locations:

(1) Remote areas of Alaska; and

(2) Marine offshore installations.

(g) Notwithstanding the requirements in paragraphs (a) through (f) of this section, stationary CI internal combustion engine manufacturers are not required to certify reconstructed engines; however manufacturers may elect to do so. The reconstructed engine must be certified to the emission standards specified in paragraphs (a) through (e) of this section that are applicable to the model year, maximum engine power, and displacement of the reconstructed stationary CI ICE.

(h) Stationary CI ICE certified to the standards in 40 CFR part 1039 and equipped with auxiliary emission control devices (AECDs) as specified in 40 CFR 1039.665 must meet the Tier 1 certification emission standards for new nonroad CI engines in 40 CFR 89.112 while the AECD is activated during a qualified emergency situation. A qualified emergency situation is defined in 40 CFR 1039.665. When the qualified emergency situation has ended and the AECD is deactivated, the engine must resume meeting the otherwise applicable emission standard specified in this section.

[71 FR 39172, July 11, 2006, as amended at 76 FR 37967, June 28, 2011; 81 FR 44219, July 7, 2016]

[↑ Back to Top](#)

**§60.4202 What emission standards must I meet for emergency engines if I am a stationary CI internal combustion engine manufacturer?**

(a) Stationary CI internal combustion engine manufacturers must certify their 2007 model year and later emergency stationary CI ICE with a maximum engine power less than or equal to 2,237 KW (3,000 HP) and a displacement of less than 10 liters per cylinder that are not fire pump engines to the emission standards specified in paragraphs (a)(1) through (2) of this section.

(1) For engines with a maximum engine power less than 37 KW (50 HP):

(i) The certification emission standards for new nonroad CI engines for the same model year and maximum engine power in 40 CFR 89.112 and 40 CFR 89.113 for all pollutants for model year 2007 engines, and

(ii) The certification emission standards for new nonroad CI engines in 40 CFR 1039.104, 40 CFR 1039.105, 40 CFR 1039.107, 40 CFR 1039.115, and table 2 to this subpart, for 2008 model year and later engines.

(2) For engines with a maximum engine power greater than or equal to 37 KW (50 HP), the certification emission standards for new nonroad CI engines for the same model year and maximum engine power in 40 CFR 89.112 and 40 CFR 89.113 for all pollutants beginning in model year 2007.

(b) Stationary CI internal combustion engine manufacturers must certify their 2007 model year and later emergency stationary CI ICE with a maximum engine power greater than 2,237 KW (3,000 HP) and a displacement of less than 10 liters per cylinder that are not fire pump engines to the emission standards specified in paragraphs (b)(1) through (2) of this section.

(1) For 2007 through 2010 model years, the emission standards in table 1 to this subpart, for all pollutants, for the same maximum engine power.

(2) For 2011 model year and later, the certification emission standards for new nonroad CI engines for engines of the same model year and maximum engine power in 40 CFR 89.112 and 40 CFR 89.113 for all pollutants.

(c) [Reserved]

(d) Beginning with the model years in table 3 to this subpart, stationary CI internal combustion engine manufacturers must certify their fire pump stationary CI ICE to the emission standards in table 4 to this subpart, for all pollutants, for the same model year and NFPA nameplate power.

(e) Stationary CI internal combustion engine manufacturers must certify the following emergency stationary CI ICE that are not fire pump engines to the certification emission standards for new marine CI engines in 40 CFR 94.8, as applicable, for all pollutants, for the same displacement and maximum engine power:

(1) Their 2007 model year through 2012 emergency stationary CI ICE with a displacement of greater than or equal to 10 liters per cylinder and less than 30 liters per cylinder;

(2) Their 2013 model year and later emergency stationary CI ICE with a maximum engine power greater than or equal to 3,700 KW (4,958 HP) and a displacement of greater than or equal to 10 liters per cylinder and less than 15 liters per cylinder;

(3) Their 2013 model year emergency stationary CI ICE with a displacement of greater than or equal to 15 liters per cylinder and less than 30 liters per cylinder; and

(4) Their 2014 model year and later emergency stationary CI ICE with a maximum engine power greater than or equal to 2,000 KW (2,682 HP) and a displacement of greater than or equal to 15 liters per cylinder and less than 30 liters per cylinder.

(f) Stationary CI internal combustion engine manufacturers must certify the following emergency stationary CI ICE to the certification emission standards and other requirements applicable to Tier 3 new marine CI engines in 40 CFR 1042.101, 40 CFR 1042.107, 40 CFR 1042.115, 40 CFR 1042.120, and 40 CFR 1042.145, for all pollutants, for the same displacement and maximum engine power:

(1) Their 2013 model year and later emergency stationary CI ICE with a maximum engine power less than 3,700 KW (4,958 HP) and a displacement of greater than or equal to 10 liters per cylinder and less than 15 liters per cylinder; and

(2) Their 2014 model year and later emergency stationary CI ICE with a maximum engine power less than 2,000 KW (2,682 HP) and a displacement of greater than or equal to 15 liters per cylinder and less than 30 liters per cylinder.

(g) Notwithstanding the requirements in paragraphs (a) through (d) of this section, stationary emergency CI internal combustion engines identified in paragraphs (a) and (c) may be certified to the provisions of 40 CFR part 94 or, if Table 2 to 40 CFR 1042.101 identifies Tier 3 standards as being applicable, the requirements applicable to Tier 3 engines in 40 CFR part 1042, if the engines will be used solely in either or both of the following locations:

(1) Remote areas of Alaska; and

(2) Marine offshore installations.

(h) Notwithstanding the requirements in paragraphs (a) through (f) of this section, stationary CI internal combustion engine manufacturers are not required to certify reconstructed engines; however manufacturers may elect to do so. The reconstructed engine must be certified to the emission standards specified in paragraphs (a) through (f) of this section that are applicable to the model year, maximum engine power and displacement of the reconstructed emergency stationary CI ICE.

[71 FR 39172, July 11, 2006, as amended at 76 FR 37968, June 28, 2011; 81 FR 44219, July 7, 2016]

[↑ Back to Top](#)

### **§60.4203 How long must my engines meet the emission standards if I am a manufacturer of stationary CI internal combustion engines?**

Engines manufactured by stationary CI internal combustion engine manufacturers must meet the emission standards as required in §§60.4201 and 60.4202 during the certified emissions life of the engines.

[76 FR 37968, June 28, 2011]

[↑ Back to Top](#)

### **Emission Standards for Owners and Operators**

[↑ Back to Top](#)

### **§60.4204 What emission standards must I meet for non-emergency engines if I am an owner or operator of a stationary CI internal combustion engine?**

(a) Owners and operators of pre-2007 model year non-emergency stationary CI ICE with a displacement of less than 10 liters per cylinder must comply with the emission standards in table 1 to this subpart. Owners and operators of pre-2007 model year non-emergency stationary CI ICE with a displacement of greater than or equal to 10 liters per cylinder and less than 30 liters per cylinder must comply with the emission standards in 40 CFR 94.8(a)(1).

(b) Owners and operators of 2007 model year and later non-emergency stationary CI ICE with a displacement of less than 30 liters per cylinder must comply with the emission standards for new CI engines in §60.4201 for their 2007 model year and later stationary CI ICE, as applicable.

(c) Owners and operators of non-emergency stationary CI engines with a displacement of greater than or equal to 30 liters per cylinder must meet the following requirements:

(1) For engines installed prior to January 1, 2012, limit the emissions of  $\text{NO}_x$  in the stationary CI internal combustion engine exhaust to the following:

(i) 17.0 grams per kilowatt-hour (g/KW-hr) (12.7 grams per horsepower-hr (g/HP-hr)) when maximum engine speed is less than 130 revolutions per minute (rpm);

(ii)  $45 \cdot n^{-0.2}$  g/KW-hr ( $34 \cdot n^{-0.2}$  g/HP-hr) when maximum engine speed is 130 or more but less than 2,000 rpm, where n is maximum engine speed; and

(iii) 9.8 g/KW-hr (7.3 g/HP-hr) when maximum engine speed is 2,000 rpm or more.

(2) For engines installed on or after January 1, 2012 and before January 1, 2016, limit the emissions of  $\text{NO}_x$  in the stationary CI internal combustion engine exhaust to the following:

(i) 14.4 g/KW-hr (10.7 g/HP-hr) when maximum engine speed is less than 130 rpm;

(ii)  $44 \cdot n^{-0.23}$  g/KW-hr ( $33 \cdot n^{-0.23}$  g/HP-hr) when maximum engine speed is greater than or equal to 130 but less than 2,000 rpm and where n is maximum engine speed; and

(iii) 7.7 g/KW-hr (5.7 g/HP-hr) when maximum engine speed is greater than or equal to 2,000 rpm.

(3) For engines installed on or after January 1, 2016, limit the emissions of NO<sub>x</sub> in the stationary CI internal combustion engine exhaust to the following:

(i) 3.4 g/KW-hr (2.5 g/HP-hr) when maximum engine speed is less than 130 rpm;

(ii)  $9.0 \cdot n^{-0.20}$  g/KW-hr ( $6.7 \cdot n^{-0.20}$  g/HP-hr) where n (maximum engine speed) is 130 or more but less than 2,000 rpm; and

(iii) 2.0 g/KW-hr (1.5 g/HP-hr) where maximum engine speed is greater than or equal to 2,000 rpm.

(4) Reduce particulate matter (PM) emissions by 60 percent or more, or limit the emissions of PM in the stationary CI internal combustion engine exhaust to 0.15 g/KW-hr (0.11 g/HP-hr).

(d) Owners and operators of non-emergency stationary CI ICE with a displacement of less than 30 liters per cylinder who conduct performance tests in-use must meet the not-to-exceed (NTE) standards as indicated in §60.4212.

(e) Owners and operators of any modified or reconstructed non-emergency stationary CI ICE subject to this subpart must meet the emission standards applicable to the model year, maximum engine power, and displacement of the modified or reconstructed non-emergency stationary CI ICE that are specified in paragraphs (a) through (d) of this section.

(f) Owners and operators of stationary CI ICE certified to the standards in 40 CFR part 1039 and equipped with AECDs as specified in 40 CFR 1039.665 must meet the Tier 1 certification emission standards for new nonroad CI engines in 40 CFR 89.112 while the AECD is activated during a qualified emergency situation. A qualified emergency situation is defined in 40 CFR 1039.665. When the qualified emergency situation has ended and the AECD is deactivated, the engine must resume meeting the otherwise applicable emission standard specified in this section.

[71 FR 39172, July 11, 2006, as amended at 76 FR 37968, June 28, 2011; 81 FR 44219, July 7, 2016]

[↑ Back to Top](#)

#### **§60.4205 What emission standards must I meet for emergency engines if I am an owner or operator of a stationary CI internal combustion engine?**

(a) Owners and operators of pre-2007 model year emergency stationary CI ICE with a displacement of less than 10 liters per cylinder that are not fire pump engines must comply with the emission standards in Table 1 to this subpart. Owners and operators of pre-2007 model year emergency stationary CI ICE with a displacement of greater than or equal to 10 liters per cylinder and less than 30 liters per cylinder that are not fire pump engines must comply with the emission standards in 40 CFR 94.8(a)(1).

(b) Owners and operators of 2007 model year and later emergency stationary CI ICE with a displacement of less than 30 liters per cylinder that are not fire pump engines must comply with the emission standards for new nonroad CI engines in §60.4202, for all pollutants, for the same model year and maximum engine power for their 2007 model year and later emergency stationary CI ICE.

(c) Owners and operators of fire pump engines with a displacement of less than 30 liters per cylinder must comply with the emission standards in table 4 to this subpart, for all pollutants.

(d) Owners and operators of emergency stationary CI engines with a displacement of greater than or equal to 30 liters per cylinder must meet the requirements in this section.

(1) For engines installed prior to January 1, 2012, limit the emissions of NO<sub>x</sub> in the stationary CI internal combustion engine exhaust to the following:

(i) 17.0 g/KW-hr (12.7 g/HP-hr) when maximum engine speed is less than 130 rpm;

(ii)  $45 \cdot n^{-0.2}$  g/KW-hr ( $34 \cdot n^{-0.2}$  g/HP-hr) when maximum engine speed is 130 or more but less than 2,000 rpm, where n is maximum engine speed; and

(iii) 9.8 g/KW-hr (7.3 g/HP-hr) when maximum engine speed is 2,000 rpm or more.

(2) For engines installed on or after January 1, 2012, limit the emissions of NO<sub>x</sub> in the stationary CI internal combustion engine exhaust to the following:

(i) 14.4 g/KW-hr (10.7 g/HP-hr) when maximum engine speed is less than 130 rpm;

(ii)  $44 \cdot n^{-0.23}$  g/KW-hr ( $33 \cdot n^{-0.23}$  g/HP-hr) when maximum engine speed is greater than or equal to 130 but less than 2,000 rpm and where n is maximum engine speed; and

(iii) 7.7 g/KW-hr (5.7 g/HP-hr) when maximum engine speed is greater than or equal to 2,000 rpm.

(3) Limit the emissions of PM in the stationary CI internal combustion engine exhaust to 0.40 g/KW-hr (0.30 g/HP-hr).

(e) Owners and operators of emergency stationary CI ICE with a displacement of less than 30 liters per cylinder who conduct performance tests in-use must meet the NTE standards as indicated in §60.4212.

(f) Owners and operators of any modified or reconstructed emergency stationary CI ICE subject to this subpart must meet the emission standards applicable to the model year, maximum engine power, and displacement of the modified or reconstructed CI ICE that are specified in paragraphs (a) through (e) of this section.

[71 FR 39172, July 11, 2006, as amended at 76 FR 37969, June 28, 2011]

[↑ Back to Top](#)

#### **§60.4206 How long must I meet the emission standards if I am an owner or operator of a stationary CI internal combustion engine?**

Owners and operators of stationary CI ICE must operate and maintain stationary CI ICE that achieve the emission standards as required in §§60.4204 and 60.4205 over the entire life of the engine.

[76 FR 37969, June 28, 2011]

[↑ Back to Top](#)



## Fuel Requirements for Owners and Operators

[↑ Back to Top](#)

### **§60.4207 What fuel requirements must I meet if I am an owner or operator of a stationary CI internal combustion engine subject to this subpart?**

- (a) Beginning October 1, 2007, owners and operators of stationary CI ICE subject to this subpart that use diesel fuel must use diesel fuel that meets the requirements of 40 CFR 80.510(a).
- (b) Beginning October 1, 2010, owners and operators of stationary CI ICE subject to this subpart with a displacement of less than 30 liters per cylinder that use diesel fuel must use diesel fuel that meets the requirements of 40 CFR 80.510(b) for nonroad diesel fuel, except that any existing diesel fuel purchased (or otherwise obtained) prior to October 1, 2010, may be used until depleted.
- (c) [Reserved]
- (d) Beginning June 1, 2012, owners and operators of stationary CI ICE subject to this subpart with a displacement of greater than or equal to 30 liters per cylinder are no longer subject to the requirements of paragraph (a) of this section, and must use fuel that meets a maximum per-gallon sulfur content of 1,000 parts per million (ppm).
- (e) Stationary CI ICE that have a national security exemption under §60.4200(d) are also exempt from the fuel requirements in this section.

[71 FR 39172, July 11, 2006, as amended at 76 FR 37969, June 28, 2011; 78 FR 6695, Jan. 30, 2013]

[↑ Back to Top](#)

## Other Requirements for Owners and Operators

[↑ Back to Top](#)

### **§60.4208 What is the deadline for importing or installing stationary CI ICE produced in previous model years?**

- (a) After December 31, 2008, owners and operators may not install stationary CI ICE (excluding fire pump engines) that do not meet the applicable requirements for 2007 model year engines.
- (b) After December 31, 2009, owners and operators may not install stationary CI ICE with a maximum engine power of less than 19 KW (25 HP) (excluding fire pump engines) that do not meet the applicable requirements for 2008 model year engines.
- (c) After December 31, 2014, owners and operators may not install non-emergency stationary CI ICE with a maximum engine power of greater than or equal to 19 KW (25 HP) and less than 56 KW (75 HP) that do not meet the applicable requirements for 2013 model year non-emergency engines.

(d) After December 31, 2013, owners and operators may not install non-emergency stationary CI ICE with a maximum engine power of greater than or equal to 56 KW (75 HP) and less than 130 KW (175 HP) that do not meet the applicable requirements for 2012 model year non-emergency engines.

(e) After December 31, 2012, owners and operators may not install non-emergency stationary CI ICE with a maximum engine power of greater than or equal to 130 KW (175 HP), including those above 560 KW (750 HP), that do not meet the applicable requirements for 2011 model year non-emergency engines.

(f) After December 31, 2016, owners and operators may not install non-emergency stationary CI ICE with a maximum engine power of greater than or equal to 560 KW (750 HP) that do not meet the applicable requirements for 2015 model year non-emergency engines.

(g) After December 31, 2018, owners and operators may not install non-emergency stationary CI ICE with a maximum engine power greater than or equal to 600 KW (804 HP) and less than 2,000 KW (2,680 HP) and a displacement of greater than or equal to 10 liters per cylinder and less than 30 liters per cylinder that do not meet the applicable requirements for 2017 model year non-emergency engines.

(h) In addition to the requirements specified in §§60.4201, 60.4202, 60.4204, and 60.4205, it is prohibited to import stationary CI ICE with a displacement of less than 30 liters per cylinder that do not meet the applicable requirements specified in paragraphs (a) through (g) of this section after the dates specified in paragraphs (a) through (g) of this section.

(i) The requirements of this section do not apply to owners or operators of stationary CI ICE that have been modified, reconstructed, and do not apply to engines that were removed from one existing location and reinstalled at a new location.

[71 FR 39172, July 11, 2006, as amended at 76 FR 37969, June 28, 2011]

[↑ Back to Top](#)

#### **§60.4209 What are the monitoring requirements if I am an owner or operator of a stationary CI internal combustion engine?**

If you are an owner or operator, you must meet the monitoring requirements of this section. In addition, you must also meet the monitoring requirements specified in §60.4211.

(a) If you are an owner or operator of an emergency stationary CI internal combustion engine that does not meet the standards applicable to non-emergency engines, you must install a non-resettable hour meter prior to startup of the engine.

(b) If you are an owner or operator of a stationary CI internal combustion engine equipped with a diesel particulate filter to comply with the emission standards in §60.4204, the diesel particulate filter must be installed with a backpressure monitor that notifies the owner or operator when the high backpressure limit of the engine is approached.

[71 FR 39172, July 11, 2006, as amended at 76 FR 37969, June 28, 2011]

[↑ Back to Top](#)

## Compliance Requirements

[↑ Back to Top](#)

### **§60.4210 What are my compliance requirements if I am a stationary CI internal combustion engine manufacturer?**

(a) Stationary CI internal combustion engine manufacturers must certify their stationary CI ICE with a displacement of less than 10 liters per cylinder to the emission standards specified in §60.4201(a) through (c) and §60.4202(a), (b) and (d) using the certification procedures required in 40 CFR part 89, subpart B, or 40 CFR part 1039, subpart C, as applicable, and must test their engines as specified in those parts. For the purposes of this subpart, engines certified to the standards in table 1 to this subpart shall be subject to the same requirements as engines certified to the standards in 40 CFR part 89. For the purposes of this subpart, engines certified to the standards in table 4 to this subpart shall be subject to the same requirements as engines certified to the standards in 40 CFR part 89, except that engines with NFPA nameplate power of less than 37 KW (50 HP) certified to model year 2011 or later standards shall be subject to the same requirements as engines certified to the standards in 40 CFR part 1039.

(b) Stationary CI internal combustion engine manufacturers must certify their stationary CI ICE with a displacement of greater than or equal to 10 liters per cylinder and less than 30 liters per cylinder to the emission standards specified in §60.4201(d) and (e) and §60.4202(e) and (f) using the certification procedures required in 40 CFR part 94, subpart C, or 40 CFR part 1042, subpart C, as applicable, and must test their engines as specified in 40 CFR part 94 or 1042, as applicable.

(c) Stationary CI internal combustion engine manufacturers must meet the requirements of 40 CFR 1039.120, 1039.125, 1039.130, and 1039.135, and 40 CFR part 1068 for engines that are certified to the emission standards in 40 CFR part 1039. Stationary CI internal combustion engine manufacturers must meet the corresponding provisions of 40 CFR part 89, 40 CFR part 94 or 40 CFR part 1042 for engines that would be covered by that part if they were nonroad (including marine) engines. Labels on such engines must refer to stationary engines, rather than or in addition to nonroad or marine engines, as appropriate. Stationary CI internal combustion engine manufacturers must label their engines according to paragraphs (c)(1) through (3) of this section.

(1) Stationary CI internal combustion engines manufactured from January 1, 2006 to March 31, 2006 (January 1, 2006 to June 30, 2006 for fire pump engines), other than those that are part of certified engine families under the nonroad CI engine regulations, must be labeled according to 40 CFR 1039.20.

(2) Stationary CI internal combustion engines manufactured from April 1, 2006 to December 31, 2006 (or, for fire pump engines, July 1, 2006 to December 31 of the year preceding the year listed in table 3 to this subpart) must be labeled according to paragraphs (c)(2)(i) through (iii) of this section:

(i) Stationary CI internal combustion engines that are part of certified engine families under the nonroad regulations must meet the labeling requirements for nonroad CI engines, but do not have to meet the labeling requirements in 40 CFR 1039.20.

(ii) Stationary CI internal combustion engines that meet Tier 1 requirements (or requirements for fire pumps) under this subpart, but do not meet the requirements applicable to nonroad CI engines must be

labeled according to 40 CFR 1039.20. The engine manufacturer may add language to the label clarifying that the engine meets Tier 1 requirements (or requirements for fire pumps) of this subpart.

(iii) Stationary CI internal combustion engines manufactured after April 1, 2006 that do not meet Tier 1 requirements of this subpart, or fire pumps engines manufactured after July 1, 2006 that do not meet the requirements for fire pumps under this subpart, may not be used in the U.S. If any such engines are manufactured in the U.S. after April 1, 2006 (July 1, 2006 for fire pump engines), they must be exported or must be brought into compliance with the appropriate standards prior to initial operation. The export provisions of 40 CFR 1068.230 would apply to engines for export and the manufacturers must label such engines according to 40 CFR 1068.230.

(3) Stationary CI internal combustion engines manufactured after January 1, 2007 (for fire pump engines, after January 1 of the year listed in table 3 to this subpart, as applicable) must be labeled according to paragraphs (c)(3)(i) through (iii) of this section.

(i) Stationary CI internal combustion engines that meet the requirements of this subpart and the corresponding requirements for nonroad (including marine) engines of the same model year and HP must be labeled according to the provisions in 40 CFR parts 89, 94, 1039 or 1042, as appropriate.

(ii) Stationary CI internal combustion engines that meet the requirements of this subpart, but are not certified to the standards applicable to nonroad (including marine) engines of the same model year and HP must be labeled according to the provisions in 40 CFR parts 89, 94, 1039 or 1042, as appropriate, but the words “stationary” must be included instead of “nonroad” or “marine” on the label. In addition, such engines must be labeled according to 40 CFR 1039.20.

(iii) Stationary CI internal combustion engines that do not meet the requirements of this subpart must be labeled according to 40 CFR 1068.230 and must be exported under the provisions of 40 CFR 1068.230.

(d) An engine manufacturer certifying an engine family or families to standards under this subpart that are identical to standards applicable under 40 CFR parts 89, 94, 1039 or 1042 for that model year may certify any such family that contains both nonroad (including marine) and stationary engines as a single engine family and/or may include any such family containing stationary engines in the averaging, banking and trading provisions applicable for such engines under those parts.

(e) Manufacturers of engine families discussed in paragraph (d) of this section may meet the labeling requirements referred to in paragraph (c) of this section for stationary CI ICE by either adding a separate label containing the information required in paragraph (c) of this section or by adding the words “and stationary” after the word “nonroad” or “marine,” as appropriate, to the label.

(f) Starting with the model years shown in table 5 to this subpart, stationary CI internal combustion engine manufacturers must add a permanent label stating that the engine is for stationary emergency use only to each new emergency stationary CI internal combustion engine greater than or equal to 19 KW (25 HP) that meets all the emission standards for emergency engines in §60.4202 but does not meet all the emission standards for non-emergency engines in §60.4201. The label must be added according to the labeling requirements specified in 40 CFR 1039.135(b). Engine manufacturers must specify in the owner's manual that operation of emergency engines is limited to emergency operations and required maintenance and testing.

(g) Manufacturers of fire pump engines may use the test cycle in table 6 to this subpart for testing fire pump engines and may test at the NFPA certified nameplate HP, provided that the engine is labeled as “Fire Pump Applications Only”.

(h) Engine manufacturers, including importers, may introduce into commerce uncertified engines or engines certified to earlier standards that were manufactured before the new or changed standards took effect until inventories are depleted, as long as such engines are part of normal inventory. For example, if the engine manufacturers' normal industry practice is to keep on hand a one-month supply of engines based on its projected sales, and a new tier of standards starts to apply for the 2009 model year, the engine manufacturer may manufacture engines based on the normal inventory requirements late in the 2008 model year, and sell those engines for installation. The engine manufacturer may not circumvent the provisions of §60.4201 or §60.4202 by stockpiling engines that are built before new or changed standards take effect. Stockpiling of such engines beyond normal industry practice is a violation of this subpart.

(i) The replacement engine provisions of 40 CFR 89.1003(b)(7), 40 CFR 94.1103(b)(3), 40 CFR 94.1103(b)(4) and 40 CFR 1068.240 are applicable to stationary CI engines replacing existing equipment that is less than 15 years old.

(j) Stationary CI ICE manufacturers may equip their stationary CI internal combustion engines certified to the emission standards in 40 CFR part 1039 with AECDs for qualified emergency situations according to the requirements of 40 CFR 1039.665. Manufacturers of stationary CI ICE equipped with AECDs as allowed by 40 CFR 1039.665 must meet all of the requirements in 40 CFR 1039.665 that apply to manufacturers. Manufacturers must document that the engine complies with the Tier 1 standard in 40 CFR 89.112 when the AECD is activated. Manufacturers must provide any relevant testing, engineering analysis, or other information in sufficient detail to support such statement when applying for certification (including amending an existing certificate) of an engine equipped with an AECD as allowed by 40 CFR 1039.665.

[71 FR 39172, July 11, 2006, as amended at 76 FR 37969, June 28, 2011; 81 FR 44219, July 7, 2016]

[↑ Back to Top](#)

### **§60.4211 What are my compliance requirements if I am an owner or operator of a stationary CI internal combustion engine?**

(a) If you are an owner or operator and must comply with the emission standards specified in this subpart, you must do all of the following, except as permitted under paragraph (g) of this section:

(1) Operate and maintain the stationary CI internal combustion engine and control device according to the manufacturer's emission-related written instructions;

(2) Change only those emission-related settings that are permitted by the manufacturer; and

(3) Meet the requirements of 40 CFR parts 89, 94 and/or 1068, as they apply to you.

(b) If you are an owner or operator of a pre-2007 model year stationary CI internal combustion engine and must comply with the emission standards specified in §§60.4204(a) or 60.4205(a), or if you are an owner

or operator of a CI fire pump engine that is manufactured prior to the model years in table 3 to this subpart and must comply with the emission standards specified in §60.4205(c), you must demonstrate compliance according to one of the methods specified in paragraphs (b)(1) through (5) of this section.

(1) Purchasing an engine certified according to 40 CFR part 89 or 40 CFR part 94, as applicable, for the same model year and maximum engine power. The engine must be installed and configured according to the manufacturer's specifications.

(2) Keeping records of performance test results for each pollutant for a test conducted on a similar engine. The test must have been conducted using the same methods specified in this subpart and these methods must have been followed correctly.

(3) Keeping records of engine manufacturer data indicating compliance with the standards.

(4) Keeping records of control device vendor data indicating compliance with the standards.

(5) Conducting an initial performance test to demonstrate compliance with the emission standards according to the requirements specified in §60.4212, as applicable.

(c) If you are an owner or operator of a 2007 model year and later stationary CI internal combustion engine and must comply with the emission standards specified in §60.4204(b) or §60.4205(b), or if you are an owner or operator of a CI fire pump engine that is manufactured during or after the model year that applies to your fire pump engine power rating in table 3 to this subpart and must comply with the emission standards specified in §60.4205(c), you must comply by purchasing an engine certified to the emission standards in §60.4204(b), or §60.4205(b) or (c), as applicable, for the same model year and maximum (or in the case of fire pumps, NFPA nameplate) engine power. The engine must be installed and configured according to the manufacturer's emission-related specifications, except as permitted in paragraph (g) of this section.

(d) If you are an owner or operator and must comply with the emission standards specified in §60.4204(c) or §60.4205(d), you must demonstrate compliance according to the requirements specified in paragraphs (d)(1) through (3) of this section.

(1) Conducting an initial performance test to demonstrate initial compliance with the emission standards as specified in §60.4213.

(2) Establishing operating parameters to be monitored continuously to ensure the stationary internal combustion engine continues to meet the emission standards. The owner or operator must petition the Administrator for approval of operating parameters to be monitored continuously. The petition must include the information described in paragraphs (d)(2)(i) through (v) of this section.

(i) Identification of the specific parameters you propose to monitor continuously;

(ii) A discussion of the relationship between these parameters and NO<sub>x</sub> and PM emissions, identifying how the emissions of these pollutants change with changes in these parameters, and how limitations on these parameters will serve to limit NO<sub>x</sub> and PM emissions;

(iii) A discussion of how you will establish the upper and/or lower values for these parameters which will establish the limits on these parameters in the operating limitations;

(iv) A discussion identifying the methods and the instruments you will use to monitor these parameters, as well as the relative accuracy and precision of these methods and instruments; and

(v) A discussion identifying the frequency and methods for recalibrating the instruments you will use for monitoring these parameters.

(3) For non-emergency engines with a displacement of greater than or equal to 30 liters per cylinder, conducting annual performance tests to demonstrate continuous compliance with the emission standards as specified in §60.4213.

(e) If you are an owner or operator of a modified or reconstructed stationary CI internal combustion engine and must comply with the emission standards specified in §60.4204(e) or §60.4205(f), you must demonstrate compliance according to one of the methods specified in paragraphs (e)(1) or (2) of this section.

(1) Purchasing, or otherwise owning or operating, an engine certified to the emission standards in §60.4204(e) or §60.4205(f), as applicable.

(2) Conducting a performance test to demonstrate initial compliance with the emission standards according to the requirements specified in §60.4212 or §60.4213, as appropriate. The test must be conducted within 60 days after the engine commences operation after the modification or reconstruction.

(f) If you own or operate an emergency stationary ICE, you must operate the emergency stationary ICE according to the requirements in paragraphs (f)(1) through (3) of this section. In order for the engine to be considered an emergency stationary ICE under this subpart, any operation other than emergency operation, maintenance and testing, emergency demand response, and operation in non-emergency situations for 50 hours per year, as described in paragraphs (f)(1) through (3) of this section, is prohibited. If you do not operate the engine according to the requirements in paragraphs (f)(1) through (3) of this section, the engine will not be considered an emergency engine under this subpart and must meet all requirements for non-emergency engines.

(1) There is no time limit on the use of emergency stationary ICE in emergency situations.

(2) You may operate your emergency stationary ICE for any combination of the purposes specified in paragraphs (f)(2)(i) through (iii) of this section for a maximum of 100 hours per calendar year. Any operation for non-emergency situations as allowed by paragraph (f)(3) of this section counts as part of the 100 hours per calendar year allowed by this paragraph (f)(2).

(i) Emergency stationary ICE may be operated for maintenance checks and readiness testing, provided that the tests are recommended by federal, state or local government, the manufacturer, the vendor, the regional transmission organization or equivalent balancing authority and transmission operator, or the insurance company associated with the engine. The owner or operator may petition the Administrator for approval of additional hours to be used for maintenance checks and readiness testing, but a petition is not

required if the owner or operator maintains records indicating that federal, state, or local standards require maintenance and testing of emergency ICE beyond 100 hours per calendar year.

(ii) Emergency stationary ICE may be operated for emergency demand response for periods in which the Reliability Coordinator under the North American Electric Reliability Corporation (NERC) Reliability Standard EOP-002-3, Capacity and Energy Emergencies (incorporated by reference, see §60.17), or other authorized entity as determined by the Reliability Coordinator, has declared an Energy Emergency Alert Level 2 as defined in the NERC Reliability Standard EOP-002-3.

(iii) Emergency stationary ICE may be operated for periods where there is a deviation of voltage or frequency of 5 percent or greater below standard voltage or frequency.

(3) Emergency stationary ICE may be operated for up to 50 hours per calendar year in non-emergency situations. The 50 hours of operation in non-emergency situations are counted as part of the 100 hours per calendar year for maintenance and testing and emergency demand response provided in paragraph (f)(2) of this section. Except as provided in paragraph (f)(3)(i) of this section, the 50 hours per calendar year for non-emergency situations cannot be used for peak shaving or non-emergency demand response, or to generate income for a facility to an electric grid or otherwise supply power as part of a financial arrangement with another entity.

(i) The 50 hours per year for non-emergency situations can be used to supply power as part of a financial arrangement with another entity if all of the following conditions are met:

(A) The engine is dispatched by the local balancing authority or local transmission and distribution system operator;

(B) The dispatch is intended to mitigate local transmission and/or distribution limitations so as to avert potential voltage collapse or line overloads that could lead to the interruption of power supply in a local area or region.

(C) The dispatch follows reliability, emergency operation or similar protocols that follow specific NERC, regional, state, public utility commission or local standards or guidelines.

(D) The power is provided only to the facility itself or to support the local transmission and distribution system.

(E) The owner or operator identifies and records the entity that dispatches the engine and the specific NERC, regional, state, public utility commission or local standards or guidelines that are being followed for dispatching the engine. The local balancing authority or local transmission and distribution system operator may keep these records on behalf of the engine owner or operator.

(ii) [Reserved]

(g) If you do not install, configure, operate, and maintain your engine and control device according to the manufacturer's emission-related written instructions, or you change emission-related settings in a way that is not permitted by the manufacturer, you must demonstrate compliance as follows:



(1) If you are an owner or operator of a stationary CI internal combustion engine with maximum engine power less than 100 HP, you must keep a maintenance plan and records of conducted maintenance to demonstrate compliance and must, to the extent practicable, maintain and operate the engine in a manner consistent with good air pollution control practice for minimizing emissions. In addition, if you do not install and configure the engine and control device according to the manufacturer's emission-related written instructions, or you change the emission-related settings in a way that is not permitted by the manufacturer, you must conduct an initial performance test to demonstrate compliance with the applicable emission standards within 1 year of such action.

(2) If you are an owner or operator of a stationary CI internal combustion engine greater than or equal to 100 HP and less than or equal to 500 HP, you must keep a maintenance plan and records of conducted maintenance and must, to the extent practicable, maintain and operate the engine in a manner consistent with good air pollution control practice for minimizing emissions. In addition, you must conduct an initial performance test to demonstrate compliance with the applicable emission standards within 1 year of startup, or within 1 year after an engine and control device is no longer installed, configured, operated, and maintained in accordance with the manufacturer's emission-related written instructions, or within 1 year after you change emission-related settings in a way that is not permitted by the manufacturer.

(3) If you are an owner or operator of a stationary CI internal combustion engine greater than 500 HP, you must keep a maintenance plan and records of conducted maintenance and must, to the extent practicable, maintain and operate the engine in a manner consistent with good air pollution control practice for minimizing emissions. In addition, you must conduct an initial performance test to demonstrate compliance with the applicable emission standards within 1 year of startup, or within 1 year after an engine and control device is no longer installed, configured, operated, and maintained in accordance with the manufacturer's emission-related written instructions, or within 1 year after you change emission-related settings in a way that is not permitted by the manufacturer. You must conduct subsequent performance testing every 8,760 hours of engine operation or 3 years, whichever comes first, thereafter to demonstrate compliance with the applicable emission standards.

(h) The requirements for operators and prohibited acts specified in 40 CFR 1039.665 apply to owners or operators of stationary CI ICE equipped with AECDs for qualified emergency situations as allowed by 40 CFR 1039.665.

[71 FR 39172, July 11, 2006, as amended at 76 FR 37970, June 28, 2011; 78 FR 6695, Jan. 30, 2013; 81 FR 44219, July 7, 2016]

[↑ Back to Top](#)

## **Testing Requirements for Owners and Operators**

[↑ Back to Top](#)

**§60.4212 What test methods and other procedures must I use if I am an owner or operator of a stationary CI internal combustion engine with a displacement of less than 30 liters per cylinder?**

Owners and operators of stationary CI ICE with a displacement of less than 30 liters per cylinder who conduct performance tests pursuant to this subpart must do so according to paragraphs (a) through (e) of this section.

(a) The performance test must be conducted according to the in-use testing procedures in 40 CFR part 1039, subpart F, for stationary CI ICE with a displacement of less than 10 liters per cylinder, and according to 40 CFR part 1042, subpart F, for stationary CI ICE with a displacement of greater than or equal to 10 liters per cylinder and less than 30 liters per cylinder.

(b) Exhaust emissions from stationary CI ICE that are complying with the emission standards for new CI engines in 40 CFR part 1039 must not exceed the not-to-exceed (NTE) standards for the same model year and maximum engine power as required in 40 CFR 1039.101(e) and 40 CFR 1039.102(g)(1), except as specified in 40 CFR 1039.104(d). This requirement starts when NTE requirements take effect for nonroad diesel engines under 40 CFR part 1039.

(c) Exhaust emissions from stationary CI ICE that are complying with the emission standards for new CI engines in 40 CFR 89.112 or 40 CFR 94.8, as applicable, must not exceed the NTE numerical requirements, rounded to the same number of decimal places as the applicable standard in 40 CFR 89.112 or 40 CFR 94.8, as applicable, determined from the following equation:

$$\text{NTE requirement for each pollutant} = (1.25) \times (\text{STD}) \quad (\text{Eq. 1})$$

[View or download PDF](#)

Where:

STD = The standard specified for that pollutant in 40 CFR 89.112 or 40 CFR 94.8, as applicable.

Alternatively, stationary CI ICE that are complying with the emission standards for new CI engines in 40 CFR 89.112 or 40 CFR 94.8 may follow the testing procedures specified in §60.4213 of this subpart, as appropriate.

(d) Exhaust emissions from stationary CI ICE that are complying with the emission standards for pre-2007 model year engines in §60.4204(a), §60.4205(a), or §60.4205(c) must not exceed the NTE numerical requirements, rounded to the same number of decimal places as the applicable standard in §60.4204(a), §60.4205(a), or §60.4205(c), determined from the equation in paragraph (c) of this section.

Where:

STD = The standard specified for that pollutant in §60.4204(a), §60.4205(a), or §60.4205(c).

Alternatively, stationary CI ICE that are complying with the emission standards for pre-2007 model year engines in §60.4204(a), §60.4205(a), or §60.4205(c) may follow the testing procedures specified in §60.4213, as appropriate.

(e) Exhaust emissions from stationary CI ICE that are complying with the emission standards for new CI engines in 40 CFR part 1042 must not exceed the NTE standards for the same model year and maximum engine power as required in 40 CFR 1042.101(c).

[71 FR 39172, July 11, 2006, as amended at 76 FR 37971, June 28, 2011]

[↑ Back to Top](#)

**§60.4213 What test methods and other procedures must I use if I am an owner or operator of a stationary CI internal combustion engine with a displacement of greater than or equal to 30 liters per cylinder?**

Owners and operators of stationary CI ICE with a displacement of greater than or equal to 30 liters per cylinder must conduct performance tests according to paragraphs (a) through (f) of this section.

(a) Each performance test must be conducted according to the requirements in §60.8 and under the specific conditions that this subpart specifies in table 7. The test must be conducted within 10 percent of 100 percent peak (or the highest achievable) load.

(b) You may not conduct performance tests during periods of startup, shutdown, or malfunction, as specified in §60.8(c).

(c) You must conduct three separate test runs for each performance test required in this section, as specified in §60.8(f). Each test run must last at least 1 hour.

(d) To determine compliance with the percent reduction requirement, you must follow the requirements as specified in paragraphs (d)(1) through (3) of this section.

(1) You must use Equation 2 of this section to determine compliance with the percent reduction requirement:

$$\frac{C_i - C_o}{C_i} \times 100 = R \quad (\text{Eq. 2})$$

[View or download PDF](#)

Where:

$C_i$  = concentration of  $\text{NO}_x$  or PM at the control device inlet,

$C_o$  = concentration of  $\text{NO}_x$  or PM at the control device outlet, and

R = percent reduction of  $\text{NO}_x$  or PM emissions.

(2) You must normalize the  $\text{NO}_x$  or PM concentrations at the inlet and outlet of the control device to a dry basis and to 15 percent oxygen ( $\text{O}_2$ ) using Equation 3 of this section, or an equivalent percent carbon dioxide ( $\text{CO}_2$ ) using the procedures described in paragraph (d)(3) of this section.

$$C_{adj} = C_a \frac{5.9}{20.9 - \% \text{O}_2} \quad (\text{Eq. 3})$$

[View or download PDF](#)

Where:

$C_{adj}$  = Calculated  $NO_x$  or PM concentration adjusted to 15 percent  $O_2$ .

$C_d$  = Measured concentration of  $NO_x$  or PM, uncorrected.

5.9 = 20.9 percent  $O_2$ –15 percent  $O_2$ , the defined  $O_2$  correction value, percent.

% $O_2$  = Measured  $O_2$  concentration, dry basis, percent.

(3) If pollutant concentrations are to be corrected to 15 percent  $O_2$  and  $CO_2$  concentration is measured in lieu of  $O_2$  concentration measurement, a  $CO_2$  correction factor is needed. Calculate the  $CO_2$  correction factor as described in paragraphs (d)(3)(i) through (iii) of this section.

(i) Calculate the fuel-specific  $F_o$  value for the fuel burned during the test using values obtained from Method 19, Section 5.2, and the following equation:

$$F_o = \frac{0.209 F_d}{F_c} \quad (\text{Eq. 4})$$

[View or download PDF](#)

Where:

$F_o$  = Fuel factor based on the ratio of  $O_2$  volume to the ultimate  $CO_2$  volume produced by the fuel at zero percent excess air.

0.209 = Fraction of air that is  $O_2$ , percent/100.

$F_d$  = Ratio of the volume of dry effluent gas to the gross calorific value of the fuel from Method 19,  $dm^3/J$  (dscf/ $10^6$  Btu).

$F_c$  = Ratio of the volume of  $CO_2$  produced to the gross calorific value of the fuel from Method 19,  $dm^3/J$  (dscf/ $10^6$  Btu).

(ii) Calculate the  $CO_2$  correction factor for correcting measurement data to 15 percent  $O_2$ , as follows:

$$X_{CO_2} = \frac{5.9}{F_o} \quad (\text{Eq. 5})$$

[View or download PDF](#)

Where:

$X_{CO_2}$  =  $CO_2$  correction factor, percent.

5.9 = 20.9 percent  $O_2$ –15 percent  $O_2$ , the defined  $O_2$  correction value, percent.

(iii) Calculate the  $NO_x$  and PM gas concentrations adjusted to 15 percent  $O_2$  using  $CO_2$  as follows:

$$C_{adj} = C_d \frac{X_{CO_2}}{\%CO_2} \quad (\text{Eq. 6})$$

[View or download PDF](#)

Where:

$C_{adj}$  = Calculated NO<sub>x</sub> or PM concentration adjusted to 15 percent O<sub>2</sub>.

$C_d$  = Measured concentration of NO<sub>x</sub> or PM, uncorrected.

%CO<sub>2</sub> = Measured CO<sub>2</sub> concentration, dry basis, percent.

(e) To determine compliance with the NO<sub>x</sub> mass per unit output emission limitation, convert the concentration of NO<sub>x</sub> in the engine exhaust using Equation 7 of this section:

$$ER = \frac{C_d \times 1.912 \times 10^{-3} \times Q \times T}{\text{KW-hour}} \quad (\text{Eq. 7})$$

[View or download PDF](#)

Where:

ER = Emission rate in grams per KW-hour.

$C_d$  = Measured NO<sub>x</sub> concentration in ppm.

$1.912 \times 10^{-3}$  = Conversion constant for ppm NO<sub>x</sub> to grams per standard cubic meter at 25 degrees Celsius.

Q = Stack gas volumetric flow rate, in standard cubic meter per hour.

T = Time of test run, in hours.

KW-hour = Brake work of the engine, in KW-hour.

(f) To determine compliance with the PM mass per unit output emission limitation, convert the concentration of PM in the engine exhaust using Equation 8 of this section:

$$ER = \frac{C_{adj} \times Q \times T}{\text{KW-hour}} \quad (\text{Eq. 8})$$

[View or download PDF](#)

Where:

ER = Emission rate in grams per KW-hour.

$C_{adj}$  = Calculated PM concentration in grams per standard cubic meter.

Q = Stack gas volumetric flow rate, in standard cubic meter per hour.

T = Time of test run, in hours.

KW-hour = Energy output of the engine, in KW.

[71 FR 39172, July 11, 2006, as amended at 76 FR 37971, June 28, 2011]

[↑ Back to Top](#)

## Notification, Reports, and Records for Owners and Operators

[↑ Back to Top](#)

### **§60.4214 What are my notification, reporting, and recordkeeping requirements if I am an owner or operator of a stationary CI internal combustion engine?**

(a) Owners and operators of non-emergency stationary CI ICE that are greater than 2,237 KW (3,000 HP), or have a displacement of greater than or equal to 10 liters per cylinder, or are pre-2007 model year engines that are greater than 130 KW (175 HP) and not certified, must meet the requirements of paragraphs (a)(1) and (2) of this section.

(1) Submit an initial notification as required in §60.7(a)(1). The notification must include the information in paragraphs (a)(1)(i) through (v) of this section.

(i) Name and address of the owner or operator;

(ii) The address of the affected source;

(iii) Engine information including make, model, engine family, serial number, model year, maximum engine power, and engine displacement;

(iv) Emission control equipment; and

(v) Fuel used.

(2) Keep records of the information in paragraphs (a)(2)(i) through (iv) of this section.

(i) All notifications submitted to comply with this subpart and all documentation supporting any notification.

(ii) Maintenance conducted on the engine.

(iii) If the stationary CI internal combustion is a certified engine, documentation from the manufacturer that the engine is certified to meet the emission standards.

(iv) If the stationary CI internal combustion is not a certified engine, documentation that the engine meets the emission standards.

(b) If the stationary CI internal combustion engine is an emergency stationary internal combustion engine, the owner or operator is not required to submit an initial notification. Starting with the model years in table 5 to this subpart, if the emergency engine does not meet the standards applicable to non-emergency

engines in the applicable model year, the owner or operator must keep records of the operation of the engine in emergency and non-emergency service that are recorded through the non-resettable hour meter. The owner must record the time of operation of the engine and the reason the engine was in operation during that time.

(c) If the stationary CI internal combustion engine is equipped with a diesel particulate filter, the owner or operator must keep records of any corrective action taken after the backpressure monitor has notified the owner or operator that the high backpressure limit of the engine is approached.

(d) If you own or operate an emergency stationary CI ICE with a maximum engine power more than 100 HP that operates or is contractually obligated to be available for more than 15 hours per calendar year for the purposes specified in §60.4211(f)(2)(ii) and (iii) or that operates for the purposes specified in §60.4211(f)(3)(i), you must submit an annual report according to the requirements in paragraphs (d)(1) through (3) of this section.

(1) The report must contain the following information:

(i) Company name and address where the engine is located.

(ii) Date of the report and beginning and ending dates of the reporting period.

(iii) Engine site rating and model year.

(iv) Latitude and longitude of the engine in decimal degrees reported to the fifth decimal place.

(v) Hours operated for the purposes specified in §60.4211(f)(2)(ii) and (iii), including the date, start time, and end time for engine operation for the purposes specified in §60.4211(f)(2)(ii) and (iii).

(vi) Number of hours the engine is contractually obligated to be available for the purposes specified in §60.4211(f)(2)(ii) and (iii).

(vii) Hours spent for operation for the purposes specified in §60.4211(f)(3)(i), including the date, start time, and end time for engine operation for the purposes specified in §60.4211(f)(3)(i). The report must also identify the entity that dispatched the engine and the situation that necessitated the dispatch of the engine.

(2) The first annual report must cover the calendar year 2015 and must be submitted no later than March 31, 2016. Subsequent annual reports for each calendar year must be submitted no later than March 31 of the following calendar year.

(3) The annual report must be submitted electronically using the subpart specific reporting form in the Compliance and Emissions Data Reporting Interface (CEDRI) that is accessed through EPA's Central Data Exchange (CDX) ([www.epa.gov/cdx](http://www.epa.gov/cdx)). However, if the reporting form specific to this subpart is not available in CEDRI at the time that the report is due, the written report must be submitted to the Administrator at the appropriate address listed in §60.4.

(e) Owners or operators of stationary CI ICE equipped with AECDs pursuant to the requirements of 40 CFR 1039.665 must report the use of AECDs as required by 40 CFR 1039.665(e).

[71 FR 39172, July 11, 2006, as amended at 78 FR 6696, Jan. 30, 2013; 81 FR 44219, July 7, 2016]

[↑ Back to Top](#)

## Special Requirements

[↑ Back to Top](#)

### **§60.4215 What requirements must I meet for engines used in Guam, American Samoa, or the Commonwealth of the Northern Mariana Islands?**

- (a) Stationary CI ICE with a displacement of less than 30 liters per cylinder that are used in Guam, American Samoa, or the Commonwealth of the Northern Mariana Islands are required to meet the applicable emission standards in §§60.4202 and 60.4205.
- (b) Stationary CI ICE that are used in Guam, American Samoa, or the Commonwealth of the Northern Mariana Islands are not required to meet the fuel requirements in §60.4207.
- (c) Stationary CI ICE with a displacement of greater than or equal to 30 liters per cylinder that are used in Guam, American Samoa, or the Commonwealth of the Northern Mariana Islands are required to meet the following emission standards:
- (1) For engines installed prior to January 1, 2012, limit the emissions of NO<sub>x</sub> in the stationary CI internal combustion engine exhaust to the following:
- (i) 17.0 g/KW-hr (12.7 g/HP-hr) when maximum engine speed is less than 130 rpm;
  - (ii)  $45 \cdot n^{-0.2}$  g/KW-hr ( $34 \cdot n^{-0.2}$  g/HP-hr) when maximum engine speed is 130 or more but less than 2,000 rpm, where n is maximum engine speed; and
  - (iii) 9.8 g/KW-hr (7.3 g/HP-hr) when maximum engine speed is 2,000 rpm or more.
- (2) For engines installed on or after January 1, 2012, limit the emissions of NO<sub>x</sub> in the stationary CI internal combustion engine exhaust to the following:
- (i) 14.4 g/KW-hr (10.7 g/HP-hr) when maximum engine speed is less than 130 rpm;
  - (ii)  $44 \cdot n^{-0.23}$  g/KW-hr ( $33 \cdot n^{-0.23}$  g/HP-hr) when maximum engine speed is greater than or equal to 130 but less than 2,000 rpm and where n is maximum engine speed; and
  - (iii) 7.7 g/KW-hr (5.7 g/HP-hr) when maximum engine speed is greater than or equal to 2,000 rpm.
- (3) Limit the emissions of PM in the stationary CI internal combustion engine exhaust to 0.40 g/KW-hr (0.30 g/HP-hr).

[71 FR 39172, July 11, 2006, as amended at 76 FR 37971, June 28, 2011]

[↑ Back to Top](#)

### **§60.4216 What requirements must I meet for engines used in Alaska?**



(a) Prior to December 1, 2010, owners and operators of stationary CI ICE with a displacement of less than 30 liters per cylinder located in areas of Alaska not accessible by the FAHS should refer to 40 CFR part 69 to determine the diesel fuel requirements applicable to such engines.

(b) Except as indicated in paragraph (c) of this section, manufacturers, owners and operators of stationary CI ICE with a displacement of less than 10 liters per cylinder located in remote areas of Alaska may meet the requirements of this subpart by manufacturing and installing engines meeting the requirements of 40 CFR parts 94 or 1042, as appropriate, rather than the otherwise applicable requirements of 40 CFR parts 89 and 1039, as indicated in §§60.4201(f) and 60.4202(g).

(c) Manufacturers, owners and operators of stationary CI ICE that are located in remote areas of Alaska may choose to meet the applicable emission standards for emergency engines in §§60.4202 and 60.4205, and not those for non-emergency engines in §§60.4201 and 60.4204, except that for 2014 model year and later non-emergency CI ICE, the owner or operator of any such engine that was not certified as meeting Tier 4 PM standards, must meet the applicable requirements for PM in §§60.4201 and 60.4204 or install a PM emission control device that achieves PM emission reductions of 85 percent, or 60 percent for engines with a displacement of greater than or equal to 30 liters per cylinder, compared to engine-out emissions.

(d) The provisions of §60.4207 do not apply to owners and operators of pre-2014 model year stationary CI ICE subject to this subpart that are located in remote areas of Alaska.

(e) The provisions of §60.4208(a) do not apply to owners and operators of stationary CI ICE subject to this subpart that are located in areas of Alaska not accessible by the FAHS until after December 31, 2009.

(f) The provisions of this section and §60.4207 do not prevent owners and operators of stationary CI ICE subject to this subpart that are located in remote areas of Alaska from using fuels mixed with used lubricating oil, in volumes of up to 1.75 percent of the total fuel. The sulfur content of the used lubricating oil must be less than 200 parts per million. The used lubricating oil must meet the on-specification levels and properties for used oil in 40 CFR 279.11.

[76 FR 37971, June 28, 2011, as amended at 81 FR 44219, July 7, 2016]

[↑ Back to Top](#)

#### **§60.4217 What emission standards must I meet if I am an owner or operator of a stationary internal combustion engine using special fuels?**

Owners and operators of stationary CI ICE that do not use diesel fuel may petition the Administrator for approval of alternative emission standards, if they can demonstrate that they use a fuel that is not the fuel on which the manufacturer of the engine certified the engine and that the engine cannot meet the applicable standards required in §60.4204 or §60.4205 using such fuels and that use of such fuel is appropriate and reasonably necessary, considering cost, energy, technical feasibility, human health and environmental, and other factors, for the operation of the engine.

[76 FR 37972, June 28, 2011]

[↑ Back to Top](#)

## General Provisions

[↑ Back to Top](#)

### §60.4218 What parts of the General Provisions apply to me?

Table 8 to this subpart shows which parts of the General Provisions in §§60.1 through 60.19 apply to you.

[↑ Back to Top](#)

## Definitions

[↑ Back to Top](#)

### §60.4219 What definitions apply to this subpart?

As used in this subpart, all terms not defined herein shall have the meaning given them in the CAA and in subpart A of this part.

*Alaska Railbelt Grid* means the service areas of the six regulated public utilities that extend from Fairbanks to Anchorage and the Kenai Peninsula. These utilities are Golden Valley Electric Association; Chugach Electric Association; Matanuska Electric Association; Homer Electric Association; Anchorage Municipal Light & Power; and the City of Seward Electric System.

*Certified emissions life* means the period during which the engine is designed to properly function in terms of reliability and fuel consumption, without being remanufactured, specified as a number of hours of operation or calendar years, whichever comes first. The values for certified emissions life for stationary CI ICE with a displacement of less than 10 liters per cylinder are given in 40 CFR 1039.101(g). The values for certified emissions life for stationary CI ICE with a displacement of greater than or equal to 10 liters per cylinder and less than 30 liters per cylinder are given in 40 CFR 94.9(a).

*Combustion turbine* means all equipment, including but not limited to the turbine, the fuel, air, lubrication and exhaust gas systems, control systems (except emissions control equipment), and any ancillary components and sub-components comprising any simple cycle combustion turbine, any regenerative/recuperative cycle combustion turbine, the combustion turbine portion of any cogeneration cycle combustion system, or the combustion turbine portion of any combined cycle steam/electric generating system.

*Compression ignition* means relating to a type of stationary internal combustion engine that is not a spark ignition engine.

*Date of manufacture* means one of the following things:

(1) For freshly manufactured engines and modified engines, date of manufacture means the date the engine is originally produced.

(2) For reconstructed engines, date of manufacture means the date the engine was originally produced, except as specified in paragraph (3) of this definition.

(3) Reconstructed engines are assigned a new date of manufacture if the fixed capital cost of the new and refurbished components exceeds 75 percent of the fixed capital cost of a comparable entirely new facility. An engine that is produced from a previously used engine block does not retain the date of manufacture of the engine in which the engine block was previously used if the engine is produced using all new components except for the engine block. In these cases, the date of manufacture is the date of reconstruction or the date the new engine is produced.

*Diesel fuel* means any liquid obtained from the distillation of petroleum with a boiling point of approximately 150 to 360 degrees Celsius. One commonly used form is number 2 distillate oil.

*Diesel particulate filter* means an emission control technology that reduces PM emissions by trapping the particles in a flow filter substrate and periodically removes the collected particles by either physical action or by oxidizing (burning off) the particles in a process called regeneration.

*Emergency stationary internal combustion engine* means any stationary reciprocating internal combustion engine that meets all of the criteria in paragraphs (1) through (3) of this definition. All emergency stationary ICE must comply with the requirements specified in §60.4211(f) in order to be considered emergency stationary ICE. If the engine does not comply with the requirements specified in §60.4211(f), then it is not considered to be an emergency stationary ICE under this subpart.

(1) The stationary ICE is operated to provide electrical power or mechanical work during an emergency situation. Examples include stationary ICE used to produce power for critical networks or equipment (including power supplied to portions of a facility) when electric power from the local utility (or the normal power source, if the facility runs on its own power production) is interrupted, or stationary ICE used to pump water in the case of fire or flood, etc.

(2) The stationary ICE is operated under limited circumstances for situations not included in paragraph (1) of this definition, as specified in §60.4211(f).

(3) The stationary ICE operates as part of a financial arrangement with another entity in situations not included in paragraph (1) of this definition only as allowed in §60.4211(f)(2)(ii) or (iii) and §60.4211(f)(3)(i).

*Engine manufacturer* means the manufacturer of the engine. See the definition of “manufacturer” in this section.

*Fire pump engine* means an emergency stationary internal combustion engine certified to NFPA requirements that is used to provide power to pump water for fire suppression or protection.

*Freshly manufactured engine* means an engine that has not been placed into service. An engine becomes freshly manufactured when it is originally produced.

*Installed* means the engine is placed and secured at the location where it is intended to be operated.

*Manufacturer* has the meaning given in section 216(1) of the Act. In general, this term includes any person who manufactures a stationary engine for sale in the United States or otherwise introduces a new stationary engine into commerce in the United States. This includes importers who import stationary engines for sale or resale.

*Maximum engine power* means maximum engine power as defined in 40 CFR 1039.801.

*Model year* means the calendar year in which an engine is manufactured (see “date of manufacture”), except as follows:

(1) Model year means the annual new model production period of the engine manufacturer in which an engine is manufactured (see “date of manufacture”), if the annual new model production period is different than the calendar year and includes January 1 of the calendar year for which the model year is named. It may not begin before January 2 of the previous calendar year and it must end by December 31 of the named calendar year.

(2) For an engine that is converted to a stationary engine after being placed into service as a nonroad or other non-stationary engine, model year means the calendar year or new model production period in which the engine was manufactured (see “date of manufacture”).

*Other internal combustion engine* means any internal combustion engine, except combustion turbines, which is not a reciprocating internal combustion engine or rotary internal combustion engine.

*Reciprocating internal combustion engine* means any internal combustion engine which uses reciprocating motion to convert heat energy into mechanical work.

*Remote areas of Alaska* means areas of Alaska that meet either paragraph (1) or (2) of this definition.

(1) Areas of Alaska that are not accessible by the Federal Aid Highway System (FAHS).

(2) Areas of Alaska that meet all of the following criteria:

(i) The only connection to the FAHS is through the Alaska Marine Highway System, or the stationary CI ICE operation is within an isolated grid in Alaska that is not connected to the statewide electrical grid referred to as the Alaska Railbelt Grid.

(ii) At least 10 percent of the power generated by the stationary CI ICE on an annual basis is used for residential purposes.

(iii) The generating capacity of the source is less than 12 megawatts, or the stationary CI ICE is used exclusively for backup power for renewable energy.

*Rotary internal combustion engine* means any internal combustion engine which uses rotary motion to convert heat energy into mechanical work.

*Spark ignition* means relating to a gasoline, natural gas, or liquefied petroleum gas fueled engine or any other type of engine with a spark plug (or other sparking device) and with operating characteristics significantly similar to the theoretical Otto combustion cycle. Spark ignition engines usually use a throttle to regulate intake air flow to control power during normal operation. Dual-fuel engines in which a liquid

fuel (typically diesel fuel) is used for CI and gaseous fuel (typically natural gas) is used as the primary fuel at an annual average ratio of less than 2 parts diesel fuel to 100 parts total fuel on an energy equivalent basis are spark ignition engines.

*Stationary internal combustion engine* means any internal combustion engine, except combustion turbines, that converts heat energy into mechanical work and is not mobile. Stationary ICE differ from mobile ICE in that a stationary internal combustion engine is not a nonroad engine as defined at 40 CFR 1068.30 (excluding paragraph (2)(ii) of that definition), and is not used to propel a motor vehicle, aircraft, or a vehicle used solely for competition. Stationary ICE include reciprocating ICE, rotary ICE, and other ICE, except combustion turbines.

*Subpart* means 40 CFR part 60, subpart III.

[71 FR 39172, July 11, 2006, as amended at 76 FR 37972, June 28, 2011; 78 FR 6696, Jan. 30, 2013; 81 FR 44219, July 7, 2016]

[↑ Back to Top](#)

**Table 1 to Subpart III of Part 60—Emission Standards for Stationary Pre-2007 Model Year Engines With a Displacement of <10 Liters per Cylinder and 2007-2010 Model Year Engines >2,237 KW (3,000 HP) and With a Displacement of <10 Liters per Cylinder**

[As stated in §§60.4201(b), 60.4202(b), 60.4204(a), and 60.4205(a), you must comply with the following emission standards]

Maximum engine power	Emission standards for stationary pre-2007 model year engines with a displacement of <10 liters per cylinder and 2007-2010 model year engines >2,237 KW (3,000 HP) and with a displacement of <10 liters per cylinder in g/KW-hr (g/HP-hr)				
	NMHC + NO <sub>x</sub>	HC	NO <sub>x</sub>	CO	PM
KW<8 (HP<11)	10.5 (7.8)			8.0 (6.0)	1.0 (0.75)
8≤KW<19 (11≤HP<25)	9.5 (7.1)			6.6 (4.9)	0.80 (0.60)
19≤KW<37 (25≤HP<50)	9.5 (7.1)			5.5 (4.1)	0.80 (0.60)
37≤KW<56 (50≤HP<75)			9.2 (6.9)		
56≤KW<75			9.2 (6.9)		

(75≤HP<100)					
75≤KW<130 (100≤HP<175)			9.2 (6.9)		
130≤KW<225 (175≤HP<300)		1.3 (1.0)	9.2 (6.9)	11.4 (8.5)	0.54 (0.40)
225≤KW<450 (300≤HP<600)		1.3 (1.0)	9.2 (6.9)	11.4 (8.5)	0.54 (0.40)
450≤KW≤560 (600≤HP≤750)		1.3 (1.0)	9.2 (6.9)	11.4 (8.5)	0.54 (0.40)
KW>560 (HP>750)		1.3 (1.0)	9.2 (6.9)	11.4 (8.5)	0.54 (0.40)

[↑ Back to Top](#)

**Table 2 to Subpart IIII of Part 60—Emission Standards for 2008 Model Year and Later Emergency Stationary CI ICE <37 KW (50 HP) With a Displacement of <10 Liters per Cylinder**

[As stated in §60.4202(a)(1), you must comply with the following emission standards]

<b>Emission standards for 2008 model year and later emergency stationary CI ICE &lt;37 KW (50 HP) with a displacement of &lt;10 liters per cylinder in g/KW-hr (g/HP-hr)</b>				
<b>Engine power</b>	<b>Model year(s)</b>	<b>NO<sub>x</sub> + NMHC</b>	<b>CO</b>	<b>PM</b>
KW<8 (HP<11)	2008 +	7.5 (5.6)	8.0 (6.0)	0.40 (0.30)
8≤KW<19 (11≤HP<25)	2008 +	7.5 (5.6)	6.6 (4.9)	0.40 (0.30)
19≤KW<37 (25≤HP<50)	2008 +	7.5 (5.6)	5.5 (4.1)	0.30 (0.22)

[↑ Back to Top](#)

**Table 3 to Subpart IIII of Part 60—Certification Requirements for Stationary Fire Pump Engines**

As stated in §60.4202(d), you must certify new stationary fire pump engines beginning with the following model years:

<b>Engine power</b>	<b>Starting model year engine manufacturers must certify new stationary fire pump engines according to §60.4202(d)<sup>1</sup></b>
KW<75 (HP<100)	2011
75≤KW<130 (100≤HP<175)	2010
130≤KW≤560 (175≤HP≤750)	2009
KW>560 (HP>750)	2008

<sup>1</sup>Manufacturers of fire pump stationary CI ICE with a maximum engine power greater than or equal to 37 kW (50 HP) and less than 450 kW (600 HP) and a rated speed of greater than 2,650 revolutions per minute (rpm) are not required to certify such engines until three model years following the model year indicated in this Table 3 for engines in the applicable engine power category.

[71 FR 39172, July 11, 2006, as amended at 76 FR 37972, June 28, 2011]

[↑ Back to Top](#)

**Table 4 to Subpart IIII of Part 60—Emission Standards for Stationary Fire Pump Engines**

[As stated in §§60.4202(d) and 60.4205(c), you must comply with the following emission standards for stationary fire pump engines]

<b>Maximum engine power</b>	<b>Model year(s)</b>	<b>NMHC + NO<sub>x</sub></b>	<b>CO</b>	<b>PM</b>
KW<8 (HP<11)	2010 and earlier	10.5 (7.8)	8.0 (6.0)	1.0 (0.75)
	2011 +	7.5 (5.6)		0.40 (0.30)

8≤KW<19 (11≤HP<25)	2010 and earlier	9.5 (7.1)	6.6 (4.9)	0.80 (0.60)
	2011 +	7.5 (5.6)		0.40 (0.30)
19≤KW<37 (25≤HP<50)	2010 and earlier	9.5 (7.1)	5.5 (4.1)	0.80 (0.60)
	2011 +	7.5 (5.6)		0.30 (0.22)
37≤KW<56 (50≤HP<75)	2010 and earlier	10.5 (7.8)	5.0 (3.7)	0.80 (0.60)
	2011 + <sup>1</sup>	4.7 (3.5)		0.40 (0.30)
56≤KW<75 (75≤HP<100)	2010 and earlier	10.5 (7.8)	5.0 (3.7)	0.80 (0.60)
	2011 + <sup>1</sup>	4.7 (3.5)		0.40 (0.30)
75≤KW<130 (100≤HP<175)	2009 and earlier	10.5 (7.8)	5.0 (3.7)	0.80 (0.60)
	2010 + <sup>2</sup>	4.0 (3.0)		0.30 (0.22)
130≤KW<225 (175≤HP<300)	2008 and earlier	10.5 (7.8)	3.5 (2.6)	0.54 (0.40)
	2009 + <sup>3</sup>	4.0 (3.0)		0.20 (0.15)
225≤KW<450 (300≤HP<600)	2008 and earlier	10.5 (7.8)	3.5 (2.6)	0.54 (0.40)
	2009 + <sup>3</sup>	4.0 (3.0)		0.20 (0.15)
450≤KW≤560 (600≤HP≤750)	2008 and earlier	10.5 (7.8)	3.5 (2.6)	0.54 (0.40)
	2009 +	4.0 (3.0)		0.20 (0.15)
KW>560 (HP>750)	2007 and earlier	10.5 (7.8)	3.5 (2.6)	0.54 (0.40)
	2008 +	6.4 (4.8)		0.20 (0.15)

<sup>1</sup>For model years 2011-2013, manufacturers, owners and operators of fire pump stationary CI ICE in this engine power category with a rated speed of greater than 2,650 revolutions per minute (rpm) may comply with the emission limitations for 2010 model year engines.



<sup>2</sup>For model years 2010-2012, manufacturers, owners and operators of fire pump stationary CI ICE in this engine power category with a rated speed of greater than 2,650 rpm may comply with the emission limitations for 2009 model year engines.

<sup>3</sup>In model years 2009-2011, manufacturers of fire pump stationary CI ICE in this engine power category with a rated speed of greater than 2,650 rpm may comply with the emission limitations for 2008 model year engines.

[↑ Back to Top](#)

**Table 5 to Subpart IIII of Part 60—Labeling and Recordkeeping Requirements for New Stationary Emergency Engines**

[You must comply with the labeling requirements in §60.4210(f) and the recordkeeping requirements in §60.4214(b) for new emergency stationary CI ICE beginning in the following model years:]

Engine power	Starting model year
19≤KW<56 (25≤HP<75)	2013
56≤KW<130 (75≤HP<175)	2012
KW≥130 (HP≥175)	2011

[↑ Back to Top](#)

**Table 6 to Subpart IIII of Part 60—Optional 3-Mode Test Cycle for Stationary Fire Pump Engines**

[As stated in §60.4210(g), manufacturers of fire pump engines may use the following test cycle for testing fire pump engines:]

Mode No.	Engine speed <sup>1</sup>	Torque (percent) <sup>2</sup>	Weighting factors
1	Rated	100	0.30
2	Rated	75	0.50
3	Rated	50	0.20

<sup>1</sup>Engine speed: ±2 percent of point.

<sup>2</sup>Torque: NFPA certified nameplate HP for 100 percent point. All points should be ±2 percent of engine percent load value.

[↑ Back to Top](#)

**Table 7 to Subpart IIII of Part 60—Requirements for Performance Tests for Stationary CI ICE With a Displacement of  $\geq 30$  Liters per Cylinder**

As stated in §60.4213, you must comply with the following requirements for performance tests for stationary CI ICE with a displacement of  $\geq 30$  liters per cylinder:

<b>Each</b>	<b>Complying with the requirement to</b>	<b>You must</b>	<b>Using</b>	<b>According to the following requirements</b>
1. Stationary CI internal combustion engine with a displacement of $\geq 30$ liters per cylinder	a. Reduce NO <sub>x</sub> emissions by 90 percent or more;	i. Select the sampling port location and number/location of traverse points at the inlet and outlet of the control device;		(a) For NO <sub>x</sub> , O <sub>2</sub> , and moisture measurement, ducts $\leq 6$ inches in diameter may be sampled at a single point located at the duct centroid and ducts $>6$ and $\leq 12$ inches in diameter may be sampled at 3 traverse points located at 16.7, 50.0, and 83.3% of the measurement line ('3-point long line'). If the duct is $>12$ inches in diameter <i>and</i> the sampling port location meets the two and half-diameter criterion of Section 11.1.1 of Method 1 of 40 CFR part 60, appendix A-1, the duct may be sampled at '3-point long line'; otherwise, conduct the stratification testing and select sampling points according to Section 8.1.2 of Method 7E of 40 CFR part 60, appendix A-4.
		ii. Measure O <sub>2</sub> at the inlet and outlet of the control device;	(1) Method 3, 3A, or 3B of 40 CFR part 60, appendix A-2	(b) Measurements to determine O <sub>2</sub> concentration must be made at the same time as the measurements for NO <sub>x</sub> concentration.

		iii. If necessary, measure moisture content at the inlet and outlet of the control device; and	(2) Method 4 of 40 CFR part 60, appendix A-3, Method 320 of 40 CFR part 63, appendix A, or ASTM D 6348-03 (incorporated by reference, see §60.17)	(c) Measurements to determine moisture content must be made at the same time as the measurements for NO <sub>x</sub> concentration.
		iv. Measure NO <sub>x</sub> at the inlet and outlet of the control device.	(3) Method 7E of 40 CFR part 60, appendix A-4, Method 320 of 40 CFR part 63, appendix A, or ASTM D 6348-03 (incorporated by reference, see §60.17)	(d) NO <sub>x</sub> concentration must be at 15 percent O <sub>2</sub> , dry basis. Results of this test consist of the average of the three 1-hour or longer runs.
	b. Limit the concentration of NO <sub>x</sub> in the stationary CI internal combustion engine exhaust.	i. Select the sampling port location and number/location of traverse points at the exhaust of the stationary internal combustion engine;		(a) For NO <sub>x</sub> , O <sub>2</sub> , and moisture measurement, ducts ≤6 inches in diameter may be sampled at a single point located at the duct centroid and ducts >6 and ≤12 inches in diameter may be sampled at 3 traverse points located at 16.7, 50.0, and 83.3% of the measurement line ('3-point long line'). If the duct is >12 inches in diameter <i>and</i> the sampling port location meets the two and half-diameter criterion of Section 11.1.1 of Method 1 of 40 CFR part 60, appendix A-1, the duct may be sampled at '3-point long line'; otherwise, conduct the stratification testing and

				select sampling points according to Section 8.1.2 of Method 7E of 40 CFR part 60, appendix A-4.
		ii. Determine the O <sub>2</sub> concentration of the stationary internal combustion engine exhaust at the sampling port location;	(1) Method 3, 3A, or 3B of 40 CFR part 60, appendix A-2	(b) Measurements to determine O <sub>2</sub> concentration must be made at the same time as the measurement for NO <sub>x</sub> concentration.
		iii. If necessary, measure moisture content of the stationary internal combustion engine exhaust at the sampling port location; and	(2) Method 4 of 40 CFR part 60, appendix A-3, Method 320 of 40 CFR part 63, appendix A, or ASTM D 6348-03 (incorporated by reference, see §60.17)	(c) Measurements to determine moisture content must be made at the same time as the measurement for NO <sub>x</sub> concentration.
		iv. Measure NO <sub>x</sub> at the exhaust of the stationary internal combustion engine; if using a control device, the sampling site must be located at the outlet of the control device.	(3) Method 7E of 40 CFR part 60, appendix A-4, Method 320 of 40 CFR part 63, appendix A, or ASTM D 6348-03 (incorporated by reference, see §60.17)	(d) NO <sub>x</sub> concentration must be at 15 percent O <sub>2</sub> , dry basis. Results of this test consist of the average of the three 1-hour or longer runs.
	c. Reduce PM emissions by 60 percent or more	i. Select the sampling port location and the number of traverse points;	(1) Method 1 or 1A of 40 CFR part 60, appendix A-1	(a) Sampling sites must be located at the inlet and outlet of the control device.
		ii. Measure O <sub>2</sub> at the inlet and outlet of the	(2) Method 3, 3A, or 3B of 40 CFR	(b) Measurements to determine O <sub>2</sub> concentration

		control device;	part 60, appendix A-2	must be made at the same time as the measurements for PM concentration.
		iii. If necessary, measure moisture content at the inlet and outlet of the control device; and	(3) Method 4 of 40 CFR part 60, appendix A-3	(c) Measurements to determine and moisture content must be made at the same time as the measurements for PM concentration.
		iv. Measure PM at the inlet and outlet of the control device.	(4) Method 5 of 40 CFR part 60, appendix A-3	(d) PM concentration must be at 15 percent O <sub>2</sub> , dry basis. Results of this test consist of the average of the three 1-hour or longer runs.
	d. Limit the concentration of PM in the stationary CI internal combustion engine exhaust	i. Select the sampling port location and the number of traverse points;	(1) Method 1 or 1A of 40 CFR part 60, appendix A-1	(a) If using a control device, the sampling site must be located at the outlet of the control device.
		ii. Determine the O <sub>2</sub> concentration of the stationary internal combustion engine exhaust at the sampling port location;	(2) Method 3, 3A, or 3B of 40 CFR part 60, appendix A-2	(b) Measurements to determine O <sub>2</sub> concentration must be made at the same time as the measurements for PM concentration.
		iii. If necessary, measure moisture content of the stationary internal combustion engine exhaust at the sampling port location; and	(3) Method 4 of 40 CFR part 60, appendix A-3	(c) Measurements to determine moisture content must be made at the same time as the measurements for PM concentration.

		iv. Measure PM at the exhaust of the stationary internal combustion engine.	(4) Method 5 of 40 CFR part 60, appendix A-3	(d) PM concentration must be at 15 percent O <sub>2</sub> , dry basis. Results of this test consist of the average of the three 1-hour or longer runs.
--	--	---	--	--

[79 FR 11251, Feb. 27, 2014]

[↑ Back to Top](#)

**Table 8 to Subpart IIII of Part 60—Applicability of General Provisions to Subpart IIII**

[As stated in §60.4218, you must comply with the following applicable General Provisions:]

<b>General Provisions citation</b>	<b>Subject of citation</b>	<b>Applies to subpart</b>	<b>Explanation</b>
§60.1	General applicability of the General Provisions	Yes	
§60.2	Definitions	Yes	Additional terms defined in §60.4219.
§60.3	Units and abbreviations	Yes	
§60.4	Address	Yes	
§60.5	Determination of construction or modification	Yes	
§60.6	Review of plans	Yes	
§60.7	Notification and Recordkeeping	Yes	Except that §60.7 only applies as specified in §60.4214(a).
§60.8	Performance tests	Yes	Except that §60.8 only applies to stationary CI ICE with a displacement of (≥30 liters per cylinder and engines that are not certified.
§60.9	Availability of information	Yes	
§60.10	State Authority	Yes	

§60.11	Compliance with standards and maintenance requirements	No	Requirements are specified in subpart III.
§60.12	Circumvention	Yes	
§60.13	Monitoring requirements	Yes	Except that §60.13 only applies to stationary CI ICE with a displacement of ( $\geq$ 30 liters per cylinder.
§60.14	Modification	Yes	
§60.15	Reconstruction	Yes	
§60.16	Priority list	Yes	
§60.17	Incorporations by reference	Yes	
§60.18	General control device requirements	No	
§60.19	General notification and reporting requirements	Yes	

[↑ Back to Top](#)

# **APPENDIX D**



## Electronic Code of Federal Regulations

---

[View past updates to the e-CFR.](#)

[Click here to learn more.](#)

---

**e-CFR data is current as of January 17, 2017**

[Title 40](#) → [Chapter I](#) → [Subchapter C](#) → [Part 61](#) → [Subpart FF](#)

---

[Browse Previous](#)

Title 40: Protection of Environment

[PART 61—NATIONAL EMISSION STANDARDS FOR HAZARDOUS AIR POLLUTANTS](#)

---

### **Subpart FF—National Emission Standard for Benzene Waste Operations**

---

#### **Contents**

- [§61.340](#) Applicability.
- [§61.341](#) Definitions.
- [§61.342](#) Standards: General.
- [§61.343](#) Standards: Tanks.
- [§61.344](#) Standards: Surface impoundments.
- [§61.345](#) Standards: Containers.
- [§61.346](#) Standards: Individual drain systems.
- [§61.347](#) Standards: Oil-water separators.
- [§61.348](#) Standards: Treatment processes.
- [§61.349](#) Standards: Closed-vent systems and control devices.
- [§61.350](#) Standards: Delay of repair.
- [§61.351](#) Alternative standards for tanks.
- [§61.352](#) Alternative standards for oil-water separators.
- [§61.353](#) Alternative means of emission limitation.
- [§61.354](#) Monitoring of operations.
- [§61.355](#) Test methods, procedures, and compliance provisions.
- [§61.356](#) Recordkeeping requirements.
- [§61.357](#) Reporting requirements.
- [§61.358](#) Delegation of authority.
- [§61.359](#) [Reserved]
- [Appendix A to Part 61](#)
- [Appendix B to Part 61—Test Methods](#)
- [Appendix C to Part 61—Quality Assurance Procedures](#)

Source: 55 FR 8346, Mar. 7, 1990, unless otherwise noted.

[↑ Back to Top](#)

#### **§61.340 Applicability.**

(a) The provisions of this subpart apply to owners and operators of chemical manufacturing plants, coke by-product recovery plants, and petroleum refineries.

(b) The provisions of this subpart apply to owners and operators of hazardous waste treatment, storage, and disposal facilities that treat, store, or dispose of hazardous waste generated by any facility listed in paragraph (a) of this section. The waste streams at hazardous waste treatment, storage, and disposal facilities subject to the provisions of this subpart are the benzene-containing hazardous waste from any facility listed in paragraph (a) of this section. A hazardous waste treatment, storage, and disposal facility is a facility that must obtain a hazardous waste management permit under subtitle C of the Solid Waste Disposal Act.

(c) At each facility identified in paragraph (a) or (b) of this section, the following waste is exempt from the requirements of this subpart:

(1) Waste in the form of gases or vapors that is emitted from process fluids:

(2) Waste that is contained in a segregated stormwater sewer system.

(d) At each facility identified in paragraph (a) or (b) of this section, any gaseous stream from a waste management unit, treatment process, or wastewater treatment system routed to a fuel gas system, as defined in §61.341, is exempt from this subpart. No testing, monitoring, recordkeeping, or reporting is required under this subpart for any gaseous stream from a waste management unit, treatment process, or wastewater treatment unit routed to a fuel gas system.

[55 FR 8346, Mar. 7, 1990, as amended at 55 FR 37231, Sept. 10, 1990; 58 FR 3095, Jan. 7, 1993; 67 FR 68531, Nov. 12, 2002]

[↑ Back to Top](#)

#### **§61.341 Definitions.**

*Benzene concentration* means the fraction by weight of benzene in a waste as determined in accordance with the procedures specified in §61.355 of this subpart.

*Car-seal* means a seal that is placed on a device that is used to change the position of a valve (e.g., from opened to closed) in such a way that the position of the valve cannot be changed without breaking the seal.

*Chemical manufacturing plant* means any facility engaged in the production of chemicals by chemical, thermal, physical, or biological processes for use as a product, co-product, by-product, or intermediate including but not limited to industrial organic chemicals, organic pesticide products, pharmaceutical preparations, paint and allied products, fertilizers, and agricultural chemicals. Examples of chemical manufacturing plants include facilities at which process units are operated to produce one or more of the following chemicals: benzenesulfonic acid, benzene, chlorobenzene, cumene, cyclohexane, ethylene, ethylbenzene, hydroquinone, linear alkylbenzene, nitrobenzene, resorcinol, sulfolane, or styrene.

*Closed-vent system* means a system that is not open to the atmosphere and is composed of piping, ductwork, connections, and, if necessary, flow inducing devices that transport gas or vapor from an emission source to a control device.

*Coke by-product recovery plant* means any facility designed and operated for the separation and recovery of coal tar derivatives (by-products) evolved from coal during the coking process of a coke oven battery.

*Container* means any portable waste management unit in which a material is stored, transported, treated, or otherwise handled. Examples of containers are drums, barrels, tank trucks, barges, dumpsters, tank cars, dump trucks, and ships.

*Control device* means an enclosed combustion device, vapor recovery system, or flare.

*Cover* means a device or system which is placed on or over a waste placed in a waste management unit so that the entire waste surface area is enclosed and sealed to minimize air emissions. A cover may have openings necessary for operation, inspection, and maintenance of the waste management unit such as access hatches, sampling ports, and gauge wells provided that each opening is closed and sealed when not in use. Example of covers include a fixed roof installed on a tank, a lid installed on a container, and an air-supported enclosure installed over a waste management unit.

*External floating roof* means a pontoon-type or double-deck type cover with certain rim sealing mechanisms that rests on the liquid surface in a waste management unit with no fixed roof.

*Facility* means all process units and product tanks that generate waste within a stationary source, and all waste management units that are used for waste treatment, storage, or disposal within a stationary source.

*Fixed roof* means a cover that is mounted on a waste management unit in a stationary manner and that does not move with fluctuations in liquid level.

*Floating roof* means a cover with certain rim sealing mechanisms consisting of a double deck, pontoon single deck, internal floating cover or covered floating roof, which rests upon and is supported by the liquid being contained, and is equipped with a closure seal or seals to close the space between the roof edge and unit wall.

*Flow indicator* means a device which indicates whether gas flow is present in a line or vent system.

*Fuel gas system* means the offsite and onsite piping and control system that gathers gaseous streams generated by facility operations, may blend them with sources of gas, if available, and transports the blended gaseous fuel at suitable pressures for use as fuel in heaters, furnaces, boilers, incinerators, gas

turbines, and other combustion devices located within or outside the facility. The fuel is piped directly to each individual combustion device, and the system typically operates at pressures over atmospheric.

*Individual drain system* means the system used to convey waste from a process unit, product storage tank, or waste management unit to a waste management unit. The term includes all process drains and common junction boxes, together with their associated sewer lines and other junction boxes, down to the receiving waste management unit.

*Internal floating roof* means a cover that rests or floats on the liquid surface inside a waste management unit that has a fixed roof.

*Liquid-mounted seal* means a foam or liquid-filled primary seal mounted in contact with the liquid between the waste management unit wall and the floating roof continuously around the circumference.

*Loading* means the introduction of waste into a waste management unit but not necessarily to complete capacity (also referred to as filling).

*Maximum organic vapor pressure* means the equilibrium partial pressure exerted by the waste at the temperature equal to the highest calendar-month average of the waste storage temperature for waste stored above or below the ambient temperature or at the local maximum monthly average temperature as reported by the National Weather Service for waste stored at the ambient temperature, as determined:

- (1) In accordance with §60.17(c); or
- (2) As obtained from standard reference texts; or
- (3) In accordance with §60.17(a)(37); or
- (4) Any other method approved by the Administrator.

*No detectable emissions* means less than 500 parts per million by volume (ppmv) above background levels, as measured by a detection instrument reading in accordance with the procedures specified in §61.355(h) of this subpart.

*Oil-water separator* means a waste management unit, generally a tank or surface impoundment, used to separate oil from water. An oil-water separator consists of not only the separation unit but also the forebay and other separator basins, skimmers, weirs, grit chambers, sludge hoppers, and bar screens that are located directly after the individual drain system and prior to additional treatment units such as an air flotation unit, clarifier, or biological treatment unit. Examples of an oil-water separator include an API separator, parallel-plate interceptor, and corrugated-plate interceptor with the associated ancillary equipment.

*Petroleum refinery* means any facility engaged in producing gasoline, kerosene, distillate fuel oils, residual fuel oils, lubricants, or other products through the distillation of petroleum, or through the redistillation, cracking, or reforming of unfinished petroleum derivatives.

*Petroleum* means the crude oil removed from the earth and the oils derived from tar sands, shale, and coal.

*Point of waste generation* means the location where the waste stream exits the process unit component or storage tank prior to handling or treatment in an operation that is not an integral part of the production process, or in the case of waste management units that generate new wastes after treatment, the location where the waste stream exits the waste management unit component.

*Process unit* means equipment assembled and connected by pipes or ducts to produce intermediate or final products. A process unit can be operated independently if supplied with sufficient fuel or raw materials and sufficient product storage facilities.

*Process unit turnaround* means the shutting down of the operations of a process unit, the purging of the contents of the process unit, the maintenance or repair work, followed by restarting of the process.

*Process unit turnaround waste* means a waste that is generated as a result of a process unit turnaround.

*Process wastewater* means water which comes in contact with benzene during manufacturing or processing operations conducted within a process unit. Process wastewater is not organic wastes, process fluids, product tank drawdown, cooling tower blowdown, steam trap condensate, or landfill leachate.

*Process wastewater stream* means a waste stream that contains only process wastewater.

*Product tank* means a stationary unit that is designed to contain an accumulation of materials that are fed to or produced by a process unit, and is constructed primarily of non-earthen materials (e.g., wood, concrete, steel, plastic) which provide structural support.

*Product tank drawdown* means any material or mixture of materials discharged from a product tank for the purpose of removing water or other contaminants from the product tank.

*Safety device* means a closure device such as a pressure relief valve, frangible disc, fusible plug, or any other type of device which functions exclusively to prevent physical damage or permanent deformation to a unit or its air emission control equipment by venting gases or vapors directly to the atmosphere during unsafe conditions resulting from an unplanned, accidental, or emergency event. For the purpose of this subpart, a safety device is not used for routine venting of gases or vapors from the vapor headspace underneath a cover such as during filling of the unit or to adjust the pressure in this vapor headspace in response to normal daily diurnal ambient temperature fluctuations. A safety device is designed to remain in a closed position during normal operations and open only when the internal pressure, or another relevant parameter, exceeds the device threshold setting applicable to the air emission control equipment as determined by the owner or operator based on manufacturer recommendations, applicable regulations, fire protection and prevention codes, standard engineering codes and practices, or other requirements for the safe handling of flammable, ignitable, explosive, reactive, or hazardous materials.

*Segregated stormwater sewer system* means a drain and collection system designed and operated for the sole purpose of collecting rainfall runoff at a facility, and which is segregated from all other individual drain systems.

*Sewer line* means a lateral, trunk line, branch line, or other enclosed conduit used to convey waste to a downstream waste management unit.

*Slop oil* means the floating oil and solids that accumulate on the surface of an oil-water separator.

*Sour water stream* means a stream that:

- (1) Contains ammonia or sulfur compounds (usually hydrogen sulfide) at concentrations of 10 ppm by weight or more;
- (2) Is generated from separation of water from a feed stock, intermediate, or product that contained ammonia or sulfur compounds; and
- (3) Requires treatment to remove the ammonia or sulfur compounds.

*Sour water stripper* means a unit that:

- (1) Is designed and operated to remove ammonia or sulfur compounds (usually hydrogen sulfide) from sour water streams;
- (2) Has the sour water streams transferred to the stripper through hard piping or other enclosed system; and
- (3) Is operated in such a manner that the offgases are sent to a sulfur recovery unit, processing unit, incinerator, flare, or other combustion device.

*Surface impoundment* means a waste management unit which is a natural topographic depression, man-made excavation, or diked area formed primarily of earthen materials (although it may be lined with man-made materials), which is designed to hold an accumulation of liquid wastes or waste containing free liquids, and which is not an injection well. Examples of surface impoundments are holding, storage, settling, and aeration pits, ponds, and lagoons.

*Tank* means a stationary waste management unit that is designed to contain an accumulation of waste and is constructed primarily of nonearthen materials (e.g., wood, concrete, steel, plastic) which provide structural support.

*Treatment process* means a stream stripping unit, thin-film evaporation unit, waste incinerator, or any other process used to comply with §61.348 of this subpart.

*Vapor-mounted seal* means a foam-filled primary seal mounted continuously around the perimeter of a waste management unit so there is an annular vapor space underneath the seal. The annular vapor space is bounded by the bottom of the primary seal, the unit wall, the liquid surface, and the floating roof.

*Waste* means any material resulting from industrial, commercial, mining or agricultural operations, or from community activities that is discarded or is being accumulated, stored, or physically, chemically, thermally, or biologically treated prior to being discarded, recycled, or discharged.

*Waste management unit* means a piece of equipment, structure, or transport mechanism used in handling, storage, treatment, or disposal of waste. Examples of a waste management unit include a tank, surface impoundment, container, oil-water separator, individual drain system, steam stripping unit, thin-film evaporation unit, waste incinerator, and landfill.

*Waste stream* means the waste generated by a particular process unit, product tank, or waste management unit. The characteristics of the waste stream (e.g., flow rate, benzene concentration, water content) are

determined at the point of waste generation. Examples of a waste stream include process wastewater, product tank drawdown, sludge and slop oil removed from waste management units, and landfill leachate.

*Wastewater treatment system* means any component, piece of equipment, or installation that receives, manages, or treats process wastewater, product tank drawdown, or landfill leachate prior to direct or indirect discharge in accordance with the National Pollutant Discharge Elimination System permit regulations under 40 CFR part 122. These systems typically include individual drain systems, oil-water separators, air flotation units, equalization tanks, and biological treatment units.

*Water seal controls* means a seal pot, p-leg trap, or other type of trap filled with water (e.g., flooded sewers that maintain water levels adequate to prevent air flow through the system) that creates a water barrier between the sewer line and the atmosphere. The water level of the seal must be maintained in the vertical leg of a drain in order to be considered a water seal.

[55 FR 8346, Mar. 7, 1990; 55 FR 12444, Apr. 3, 1990, as amended at 58 FR 3095, Jan. 7, 1993; 67 FR 68531, Nov. 12, 2002]

[↑ Back to Top](#)

#### **§61.342 Standards: General.**

(a) An owner or operator of a facility at which the total annual benzene quantity from facility waste is less than 10 megagrams per year (Mg/yr) (11 ton/yr) shall be exempt from the requirements of paragraphs (b) and (c) of this section. The total annual benzene quantity from facility waste is the sum of the annual benzene quantity for each waste stream at the facility that has a flow-weighted annual average water content greater than 10 percent or that is mixed with water, or other wastes, at any time and the mixture has an annual average water content greater than 10 percent. The benzene quantity in a waste stream is to be counted only once without multiple counting if other waste streams are mixed with or generated from the original waste stream. Other specific requirements for calculating the total annual benzene waste quantity are as follows:

(1) Wastes that are exempted from control under §§61.342(c)(2) and 61.342(c)(3) are included in the calculation of the total annual benzene quantity if they have an annual average water content greater than 10 percent, or if they are mixed with water or other wastes at any time and the mixture has an annual average water content greater than 10 percent.

(2) The benzene in a material subject to this subpart that is sold is included in the calculation of the total annual benzene quantity if the material has an annual average water content greater than 10 percent.

(3) Benzene in wastes generated by remediation activities conducted at the facility, such as the excavation of contaminated soil, pumping and treatment of groundwater, and the recovery of product from soil or groundwater, are not included in the calculation of total annual benzene quantity for that facility. If the facility's total annual benzene quantity is 10 Mg/yr (11 ton/yr) or more, wastes generated by remediation activities are subject to the requirements of paragraphs (c) through (h) of this section. If the facility is managing remediation waste generated offsite, the benzene in this waste shall be included in the calculation of total annual benzene quantity in facility waste, if the waste streams have an annual average

water content greater than 10 percent, or if they are mixed with water or other wastes at any time and the mixture has an annual average water content greater than 10 percent.

(4) The total annual benzene quantity is determined based upon the quantity of benzene in the waste before any waste treatment occurs to remove the benzene except as specified in §61.355(c)(1)(i) (A) through (C).

(b) Each owner or operator of a facility at which the total annual benzene quantity from facility waste is equal to or greater than 10 Mg/yr (11 ton/yr) as determined in paragraph (a) of this section shall be in compliance with the requirements of paragraphs (c) through (h) of this section no later than 90 days following the effective date, unless a waiver of compliance has been obtained under §61.11, or by the initial startup for a new source with an initial startup after the effective date.

(1) The owner or operator of an existing source unable to comply with the rule within the required time may request a waiver of compliance under §61.10.

(2) As part of the waiver application, the owner or operator shall submit to the Administrator a plan under §61.10(b)(3) that is an enforceable commitment to obtain environmental benefits to mitigate the benzene emissions that result from extending the compliance date. The plan shall include the following information:

(i) A description of the method of compliance, including the control approach, schedule for installing controls, and quantity of the benzene emissions that result from extending the compliance date;

(ii) If the control approach involves a compliance strategy designed to obtain integrated compliance with multiple regulatory requirements, a description of the other regulations involved and their effective dates; and

(iii) A description of the actions to be taken at the facility to obtain mitigating environmental benefits, including how the benefits will be obtained, the schedule for these actions, and an estimate of the quantifiable benefits that directly result from these actions.

(c) Each owner or operator of a facility at which the total annual benzene quantity from facility waste is equal to or greater than 10 Mg/yr (11 ton/yr) as determined in paragraph (a) of this section shall manage and treat the facility waste as follows:

(1) For each waste stream that contains benzene, including (but not limited to) organic waste streams that contain less than 10 percent water and aqueous waste streams, even if the wastes are not discharged to an individual drain system, the owner or operator shall:

(i) Remove or destroy the benzene contained in the waste using a treatment process or wastewater treatment system that complies with the standards specified in §61.348 of this subpart.

(ii) Comply with the standards specified in §§61.343 through 61.347 of this subpart for each waste management unit that receives or manages the waste stream prior to and during treatment of the waste stream in accordance with paragraph (c)(1)(i) of this section.



(iii) Each waste management unit used to manage or treat waste streams that will be recycled to a process shall comply with the standards specified in §§61.343 through 61.347. Once the waste stream is recycled to a process, including to a tank used for the storage of production process feed, product, or product intermediates, unless this tank is used primarily for the storage of wastes, the material is no longer subject to paragraph (c) of this section.

(2) A waste stream is exempt from paragraph (c)(1) of this section provided that the owner or operator demonstrates initially and, thereafter, at least once per year that the flow-weighted annual average benzene concentration for the waste stream is less than 10 ppmw as determined by the procedures specified in §61.355(c)(2) or §61.355(c)(3).

(3) A waste stream is exempt from paragraph (c)(1) of this section provided that the owner or operator demonstrates initially and, thereafter, at least once per year that the conditions specified in either paragraph (c)(3)(i) or (c)(3)(ii) of this section are met.

(i) The waste stream is process wastewater that has a flow rate less than 0.02 liters per minute (0.005 gallons per minute) or an annual wastewater quantity of less than 10 Mg/yr (11 ton/yr); or

(ii) All of the following conditions are met:

(A) The owner or operator does not choose to exempt process wastewater under paragraph (c)(3)(i) of this section,

(B) The total annual benzene quantity in all waste streams chosen for exemption in paragraph (c)(3)(ii) of this section does not exceed 2.0 Mg/yr (2.2 ton/yr) as determined in the procedures in §61.355(j), and

(C) The total annual benzene quantity in a waste stream chosen for exemption, including process unit turnaround waste, is determined for the year in which the waste is generated.

(d) As an alternative to the requirements specified in paragraphs (c) and (e) of this section, an owner or operator of a facility at which the total annual benzene quantity from facility waste is equal to or greater than 10 Mg/yr (11 ton/yr) as determined in paragraph (a) of this section may elect to manage and treat the facility waste as follows:

(1) The owner or operator shall manage and treat facility waste other than process wastewater in accordance with the requirements of paragraph (c)(1) of this section.

(2) The owner or operator shall manage and treat process wastewater in accordance with the following requirements:

(i) Process wastewater shall be treated to achieve a total annual benzene quantity from facility process wastewater less than 1 Mg/yr (1.1 ton/yr). Total annual benzene from facility process wastewater shall be determined by adding together the annual benzene quantity at the point of waste generation for each untreated process wastewater stream plus the annual benzene quantity exiting the treatment process for each process wastewater stream treated in accordance with the requirements of paragraph (c)(1)(i) of this section.

(ii) Each treated process wastewater stream identified in paragraph (d)(2)(i) of this section shall be managed and treated in accordance with paragraph (c)(1) of this section.

(iii) Each untreated process wastewater stream identified in paragraph (d)(2)(i) of this section is exempt from the requirements of paragraph (c)(1) of this section.

(e) As an alternative to the requirements specified in paragraphs (c) and (d) of this section, an owner or operator of a facility at which the total annual benzene quantity from facility waste is equal to or greater than 10 Mg/yr (11 ton/yr) as determined in paragraph (a) of this section may elect to manage and treat the facility waste as follows:

(1) The owner or operator shall manage and treat facility waste with a flow-weighted annual average water content of less than 10 percent in accordance with the requirements of paragraph (c)(1) of this section; and

(2) The owner or operator shall manage and treat facility waste (including remediation and process unit turnaround waste) with a flow-weighted annual average water content of 10 percent or greater, on a volume basis as total water, and each waste stream that is mixed with water or wastes at any time such that the resulting mixture has an annual water content greater than 10 percent, in accordance with the following:

(i) The benzene quantity for the wastes described in paragraph (e)(2) of this section must be equal to or less than 6.0 Mg/yr (6.6 ton/yr), as determined in §61.355(k). Wastes as described in paragraph (e)(2) of this section that are transferred offsite shall be included in the determination of benzene quantity as provided in §61.355(k). The provisions of paragraph (f) of this section shall not apply to any owner or operator who elects to comply with the provisions of paragraph (e) of this section.

(ii) The determination of benzene quantity for each waste stream defined in paragraph (e)(2) of this section shall be made in accordance with §61.355(k).

(f) Rather than treating the waste onsite, an owner or operator may elect to comply with paragraph (c)(1)(i) of this section by transferring the waste offsite to another facility where the waste is treated in accordance with the requirements of paragraph (c)(1)(i) of this section. The owner or operator transferring the waste shall:

(1) Comply with the standards specified in §§61.343 through 61.347 of this subpart for each waste management unit that receives or manages the waste prior to shipment of the waste offsite.

(2) Include with each offsite waste shipment a notice stating that the waste contains benzene which is required to be managed and treated in accordance with the provisions of this subpart.

(g) Compliance with this subpart will be determined by review of facility records and results from tests and inspections using methods and procedures specified in §61.355 of this subpart.

(h) Permission to use an alternative means of compliance to meet the requirements of §§61.342 through 61.352 of this subpart may be granted by the Administrator as provided in §61.353 of this subpart.

[55 FR 8346, Mar. 7, 1990, as amended at 58 FR 3095, Jan. 7, 1993; 65 FR 62159, 62160, Oct. 17, 2000]

[↑ Back to Top](#)

### **§61.343 Standards: Tanks.**

(a) Except as provided in paragraph (b) of this section and in §61.351, the owner or operator must meet the standards in paragraph (a)(1) or (2) of this section for each tank in which the waste stream is placed in accordance with §61.342 (c)(1)(ii). The standards in this section apply to the treatment and storage of the waste stream in a tank, including dewatering.

(1) The owner or operator shall install, operate, and maintain a fixed-roof and closed-vent system that routes all organic vapors vented from the tank to a control device.

(i) The fixed-roof shall meet the following requirements:

(A) The cover and all openings (e.g., access hatches, sampling ports, and gauge wells) shall be designed to operate with no detectable emissions as indicated by an instrument reading of less than 500 ppmv above background, as determined initially and thereafter at least once per year by the methods specified in §61.355(h) of this subpart.

(B) Each opening shall be maintained in a closed, sealed position (e.g., covered by a lid that is gasketed and latched) at all times that waste is in the tank except when it is necessary to use the opening for waste sampling or removal, or for equipment inspection, maintenance, or repair.

(C) If the cover and closed-vent system operate such that the tank is maintained at a pressure less than atmospheric pressure, then paragraph (a)(1)(i)(B) of this section does not apply to any opening that meets all of the following conditions:

(1) The purpose of the opening is to provide dilution air to reduce the explosion hazard;

(2) The opening is designed to operate with no detectable emissions as indicated by an instrument reading of less than 500 ppmv above background, as determined initially and thereafter at least once per year by the methods specified in §61.355(h); and

(3) The pressure is monitored continuously to ensure that the pressure in the tank remains below atmospheric pressure.

(ii) The closed-vent system and control device shall be designed and operated in accordance with the requirements of §61.349 of this subpart.

(2) The owner or operator must install, operate, and maintain an enclosure and closed-vent system that routes all organic vapors vented from the tank, located inside the enclosure, to a control device in accordance with the requirements specified in paragraph (e) of this section.

(b) For a tank that meets all the conditions specified in paragraph (b)(1) of this section, the owner or operator may elect to comply with paragraph (b)(2) of this section as an alternative to the requirements specified in paragraph (a)(1) of this section.

(1) The waste managed in the tank complying with paragraph (b)(2) of this section shall meet all of the following conditions:

(i) Each waste stream managed in the tank must have a flow-weighted annual average water content less than or equal to 10 percent water, on a volume basis as total water.

(ii) The waste managed in the tank either:

(A) Has a maximum organic vapor pressure less than 5.2 kilopascals (kPa) (0.75 pounds per square inch (psi));

(B) Has a maximum organic vapor pressure less than 27.6 kPa (4.0 psi) and is managed in a tank having design capacity less than 151 m<sup>3</sup> (40,000 gal); or

(C) Has a maximum organic vapor pressure less than 76.6 kPa (11.1 psi) and is managed in a tank having a design capacity less than 75 m<sup>3</sup> (20,000 gal).

(2) The owner or operator shall install, operate, and maintain a fixed roof as specified in paragraph (a)(1)(i).

(3) For each tank complying with paragraph (b) of this section, one or more devices which vent directly to the atmosphere may be used on the tank provided each device remains in a closed, sealed position during normal operations except when the device needs to open to prevent physical damage or permanent deformation of the tank or cover resulting from filling or emptying the tank, diurnal temperature changes, atmospheric pressure changes or malfunction of the unit in accordance with good engineering and safety practices for handling flammable, explosive, or other hazardous materials.

(c) Each fixed-roof, seal, access door, and all other openings shall be checked by visual inspection initially and quarterly thereafter to ensure that no cracks or gaps occur and that access doors and other openings are closed and gasketed properly.

(d) Except as provided in §61.350 of this subpart, when a broken seal or gasket or other problem is identified, or when detectable emissions are measured, first efforts at repair shall be made as soon as practicable, but not later than 45 calendar days after identification.

(e) Each owner or operator who controls air pollutant emissions by using an enclosure vented through a closed-vent system to a control device must meet the requirements specified in paragraphs (e)(1) through (4) of this section.

(1) The tank must be located inside a total enclosure. The enclosure must be designed and operated in accordance with the criteria for a permanent total enclosure as specified in "Procedure T—Criteria for and Verification of a Permanent or Temporary Total Enclosure" in 40 CFR 52.741, appendix B. The enclosure may have permanent or temporary openings to allow worker access; passage of material into or out of the enclosure by conveyor, vehicles, or other mechanical means; entry of permanent mechanical or electrical equipment; or direct airflow into the enclosure. The owner or operator must perform the verification procedure for the enclosure as specified in section 5.0 of Procedure T initially when the enclosure is first installed and, thereafter, annually. A facility that has conducted an initial compliance demonstration and that performs annual compliance demonstrations in accordance with the requirements

for Tank Level 2 control requirements 40 CFR 264.1084(i) or 40 CFR 265(i) is not required to make repeat demonstrations of initial and continuous compliance for the purposes of this subpart.

(2) The enclosure must be vented through a closed-vent system to a control device that is designed and operated in accordance with the standards for control devices specified in §61.349.

(3) Safety devices, as defined in this subpart, may be installed and operated as necessary on any enclosure, closed-vent system, or control device used to comply with the requirements of paragraphs (e)(1) and (2) of this section.

(4) The closed-vent system must be designed and operated in accordance with the requirements of §61.349.

[55 FR 8346, Mar. 7, 1990, as amended at 55 FR 18331, May 2, 1990; 58 FR 3096, Jan. 7, 1993; 67 FR 68532, Nov. 12, 2002; 68 FR 6082, Feb. 6, 2003; 68 FR 67935, Dec. 4, 2003]

[↑ Back to Top](#)

#### **§61.344 Standards: Surface impoundments.**

(a) The owner or operator shall meet the following standards for each surface impoundment in which waste is placed in accordance with §61.342(c)(1)(ii) of this subpart:

(1) The owner or operator shall install, operate, and maintain on each surface impoundment a cover (e.g., air-supported structure or rigid cover) and closed-vent system that routes all organic vapors vented from the surface impoundment to a control device.

(i) The cover shall meet the following requirements:

(A) The cover and all openings (e.g., access hatches, sampling ports, and gauge wells) shall be designed to operate with no detectable emissions as indicated by an instrument reading of less than 500 ppmv above background, initially and thereafter at least once per year by the methods specified in §61.355(h) of this subpart.

(B) Each opening shall be maintained in a closed, sealed position (e.g., covered by a lid that is gasketed and latched) at all times that waste is in the surface impoundment except when it is necessary to use the opening for waste sampling or removal, or for equipment inspection, maintenance, or repair.

(C) If the cover and closed-vent system operate such that the enclosure of the surface impoundment is maintained at a pressure less than atmospheric pressure, then paragraph (a)(1)(i)(B) of this section does not apply to any opening that meets all of the following conditions:

(1) The purpose of the opening is to provide dilution air to reduce the explosion hazard;

(2) The opening is designed to operate with no detectable emissions as indicated by an instrument reading of less than 500 ppmv above background, as determined initially and thereafter at least once per year by the methods specified in §61.355(h) of this subpart; and

(3) The pressure is monitored continuously to ensure that the pressure in the enclosure of the surface impoundment remains below atmospheric pressure.

(D) The cover shall be used at all times that waste is placed in the surface impoundment except during removal of treatment residuals in accordance with 40 CFR 268.4 or closure of the surface impoundment in accordance with 40 CFR 264.228. (Note: the treatment residuals generated by these activities may be subject to the requirements of this part.)

(ii) The closed-vent system and control device shall be designed and operated in accordance with §61.349 of this subpart.

(b) Each cover seal, access hatch, and all other openings shall be checked by visual inspection initially and quarterly thereafter to ensure that no cracks or gaps occur and that access hatches and other openings are closed and gasketed properly.

(c) Except as provided in §61.350 of this subpart, when a broken seal or gasket or other problem is identified, or when detectable emissions are measured, first efforts at repair shall be made as soon as practicable, but not later than 15 calendar days after identification.

[55 FR 8346, Mar. 7, 1990, as amended at 58 FR 3097, Jan. 7, 1993]

[↑ Back to Top](#)

#### **§61.345 Standards: Containers.**

(a) The owner or operator shall meet the following standards for each container in which waste is placed in accordance with §61.342(c)(1)(ii) of this subpart:

(1) The owner or operator shall install, operate, and maintain a cover on each container used to handle, transfer, or store waste in accordance with the following requirements:

(i) The cover and all openings (e.g., bungs, hatches, and sampling ports) shall be designed to operate with no detectable emissions as indicated by an instrument reading of less than 500 ppmv above background, initially and thereafter at least once per year by the methods specified in §61.355(h) of this subpart.

(ii) Except as provided in paragraph (a)(4) of this section, each opening shall be maintained in a closed, sealed position (e.g., covered by a lid that is gasketed and latched) at all times that waste is in the container except when it is necessary to use the opening for waste loading, removal, inspection, or sampling.

(2) When a waste is transferred into a container by pumping, the owner or operator shall perform the transfer using a submerged fill pipe. The submerged fill pipe outlet shall extend to within two fill pipe diameters of the bottom of the container while the container is being loaded. During loading of the waste, the cover shall remain in place and all openings shall be maintained in a closed, sealed position except for those openings required for the submerged fill pipe, those openings required for venting of the container to prevent physical damage or permanent deformation of the container or cover, and any openings complying with paragraph (a)(4) of this section.

(3) Treatment of a waste in a container, including aeration, thermal or other treatment, must be performed by the owner or operator in a manner such that while the waste is being treated the container meets the standards specified in paragraphs (a)(3)(i) through (iii) of this section, except for covers and closed-vent systems that meet the requirements in paragraph (a)(4) of this section.

(i) The owner or operator must either:

(A) Vent the container inside a total enclosure which is exhausted through a closed-vent system to a control device in accordance with the requirements of paragraphs (a)(3)(ii)(A) and (B) of this section; or

(B) Vent the covered or closed container directly through a closed-vent system to a control device in accordance with the requirements of paragraphs (a)(3)(ii)(B) and (C) of this section.

(ii) The owner or operator must meet the following requirements, as applicable to the type of air emission control equipment selected by the owner or operator:

(A) The total enclosure must be designed and operated in accordance with the criteria for a permanent total enclosure as specified in section 5 of the “Procedure T—Criteria for and Verification of a Permanent or Temporary Total Enclosure” in 40 CFR 52.741, appendix B. The enclosure may have permanent or temporary openings to allow worker access; passage of containers through the enclosure by conveyor or other mechanical means; entry of permanent mechanical or electrical equipment; or direct airflow into the enclosure. The owner or operator must perform the verification procedure for the enclosure as specified in section 5.0 of “Procedure T—Criteria for and Verification of a Permanent or Temporary Total Enclosure” initially when the enclosure is first installed and, thereafter, annually. A facility that has conducted an initial compliance demonstration and that performs annual compliance demonstrations in accordance with the Container Level 3 control requirements in 40 CFR 264.1086(e)(2)(i) or 40 CFR 265.1086(e)(2)(i) is not required to make repeat demonstrations of initial and continuous compliance for the purposes of this subpart.

(B) The closed-vent system and control device must be designed and operated in accordance with the requirements of §61.349.

(C) For a container cover, the cover and all openings (*e.g.*, doors, hatches) must be designed to operate with no detectable emissions as indicated by an instrument reading of less than 500 ppmv above background, initially and thereafter at least once per year by the methods specified in §61.355(h).

(iii) Safety devices, as defined in this subpart, may be installed and operated as necessary on any container, enclosure, closed-vent system, or control device used to comply with the requirements of paragraph (a)(3)(i) of this section.

(4) If the cover and closed-vent system operate such that the container is maintained at a pressure less than atmospheric pressure, the owner or operator may operate the system with an opening that is not sealed and kept closed at all times if the following conditions are met:

(i) The purpose of the opening is to provide dilution air to reduce the explosion hazard;

(ii) The opening is designed to operate with no detectable emissions as indicated by an instrument reading of less than 500 ppmv above background, as determined initially and thereafter at least once per year by methods specified in §61.355(h); and

(iii) The pressure is monitored continuously to ensure that the pressure in the container remains below atmospheric pressure.

(b) Each cover and all openings shall be visually inspected initially and quarterly thereafter to ensure that they are closed and gasketed properly.

(c) Except as provided in §61.350 of this subpart, when a broken seal or gasket or other problem is identified, first efforts at repair shall be made as soon as practicable, but not later than 15 calendar days after identification.

[55 FR 8346, Mar. 7, 1990, as amended at 58 FR 3097, Jan. 7, 1993; 67 FR 68532, Nov. 12, 2002; 68 FR 67936, Dec. 4, 2003]

[↑ Back to Top](#)

#### **§61.346 Standards: Individual drain systems.**

(a) Except as provided in paragraph (b) of this section, the owner or operator shall meet the following standards for each individual drain system in which waste is placed in accordance with §61.342(c)(1)(ii) of this subpart:

(1) The owner or operator shall install, operate, and maintain on each drain system opening a cover and closed-vent system that routes all organic vapors vented from the drain system to a control device.

(i) The cover shall meet the following requirements:

(A) The cover and all openings (e.g., access hatches, sampling ports) shall be designed to operate with no detectable emissions as indicated by an instrument reading of less than 500 ppmv above background, initially and thereafter at least once per year by the methods specified in §61.355(h) of this subpart.

(B) Each opening shall be maintained in a closed, sealed position (e.g., covered by a lid that is gasketed and latched) at all times that waste is in the drain system except when it is necessary to use the opening for waste sampling or removal, or for equipment inspection, maintenance, or repair.

(C) If the cover and closed-vent system operate such that the individual drain system is maintained at a pressure less than atmospheric pressure, then paragraph (a)(1)(i)(B) of this section does not apply to any opening that meets all of the following conditions:

(1) The purpose of the opening is to provide dilution air to reduce the explosion hazard;

(2) The opening is designed to operate with no detectable emissions as indicated by an instrument reading of less than 500 ppmv above background, as determined initially and thereafter at least once per year by the methods specified in §61.355(h); and



(3) The pressure is monitored continuously to ensure that the pressure in the individual drain system remains below atmospheric pressure.

(ii) The closed-vent system and control device shall be designed and operated in accordance with §61.349 of this subpart.

(2) Each cover seal, access hatch, and all other openings shall be checked by visual inspection initially and quarterly thereafter to ensure that no cracks or gaps occur and that access hatches and other openings are closed and gasketed properly.

(3) Except as provided in §61.350 of this subpart, when a broken seal or gasket or other problem is identified, or when detectable emissions are measured, first efforts at repair shall be made as soon as practicable, but not later than 15 calendar days after identification.

(b) As an alternative to complying with paragraph (a) of this section, an owner or operator may elect to comply with the following requirements:

(1) Each drain shall be equipped with water seal controls or a tightly sealed cap or plug.

(2) Each junction box shall be equipped with a cover and may have a vent pipe. The vent pipe shall be at least 90 cm (3 ft) in length and shall not exceed 10.2 cm (4 in) in diameter.

(i) Junction box covers shall have a tight seal around the edge and shall be kept in place at all times, except during inspection and maintenance.

(ii) One of the following methods shall be used to control emissions from the junction box vent pipe to the atmosphere:

(A) Equip the junction box with a system to prevent the flow of organic vapors from the junction box vent pipe to the atmosphere during normal operation. An example of such a system includes use of water seal controls on the junction box. A flow indicator shall be installed, operated, and maintained on each junction box vent pipe to ensure that organic vapors are not vented from the junction box to the atmosphere during normal operation.

(B) Connect the junction box vent pipe to a closed-vent system and control device in accordance with §61.349 of this subpart.

(3) Each sewer line shall not be open to the atmosphere and shall be covered or enclosed in a manner so as to have no visual gaps or cracks in joints, seals, or other emission interfaces.

(4) Equipment installed in accordance with paragraphs (b)(1), (b)(2), or (b)(3) of this section shall be inspected as follows:

(i) Each drain using water seal controls shall be checked by visual or physical inspection initially and thereafter quarterly for indications of low water levels or other conditions that would reduce the effectiveness of water seal controls.

(ii) Each drain using a tightly sealed cap or plug shall be visually inspected initially and thereafter quarterly to ensure caps or plugs are in place and properly installed.

(iii) Each junction box shall be visually inspected initially and thereafter quarterly to ensure that the cover is in place and to ensure that the cover has a tight seal around the edge.

(iv) The unburied portion of each sewer line shall be visually inspected initially and thereafter quarterly for indication of cracks, gaps, or other problems that could result in benzene emissions.

(5) Except as provided in §61.350 of this subpart, when a broken seal, gap, crack or other problem is identified, first efforts at repair shall be made as soon as practicable, but not later than 15 calendar days after identification.

[55 FR 8346, Mar. 7, 1990, as amended at 55 FR 37231, Sept. 10, 1990; 58 FR 3097, Jan. 7, 1993]

[↑ Back to Top](#)

#### **§61.347 Standards: Oil-water separators.**

(a) Except as provided in §61.352 of this subpart, the owner or operator shall meet the following standards for each oil-water separator in which waste is placed in accordance with §61.342(c)(1)(ii) of this subpart:

(1) The owner or operator shall install, operate, and maintain a fixed-roof and closed-vent system that routes all organic vapors vented from the oil-water separator to a control device.

(i) The fixed-roof shall meet the following requirements:

(A) The cover and all openings (e.g., access hatches, sampling ports, and gauge wells) shall be designed to operate with no detectable emissions as indicated by an instrument reading of less than 500 ppmv above background, as determined initially and thereafter at least once per year by the methods specified in §61.355(h) of this subpart.

(B) Each opening shall be maintained in a closed, sealed position (e.g., covered by a lid that is gasketed and latched) at all times that waste is in the oil-water separator except when it is necessary to use the opening for waste sampling or removal, or for equipment inspection, maintenance, or repair.

(C) If the cover and closed-vent system operate such that the oil-water separator is maintained at a pressure less than atmospheric pressure, then paragraph (a)(1)(i)(B) of this section does not apply to any opening that meets all of the following conditions:

(1) The purpose of the opening is to provide dilution air to reduce the explosion hazard;

(2) The opening is designed to operate with no detectable emissions as indicated by an instrument reading of less than 500 ppmv above background, as determined initially and thereafter at least once per year by the methods specified in §61.355(h); and

(3) The pressure is monitored continuously to ensure that the pressure in the oil-water separator remains below atmospheric pressure.

(ii) The closed-vent system and control device shall be designed and operated in accordance with the requirements of §61.349 of this subpart.

(b) Each cover seal, access hatch, and all other openings shall be checked by visual inspection initially and quarterly thereafter to ensure that no cracks or gaps occur between the cover and oil-water separator wall and that access hatches and other openings are closed and gasketed properly.

(c) Except as provided in §61.350 of this subpart, when a broken seal or gasket or other problem is identified, or when detectable emissions are measured, first efforts at repair shall be made as soon as practicable, but not later than 15 calendar days after identification.

[55 FR 8346, Mar. 7, 1990, as amended at 58 FR 3098, Jan. 7, 1993]

[↑ Back to Top](#)

#### **§61.348 Standards: Treatment processes.**

(a) Except as provided in paragraph (a)(5) of this section, the owner or operator shall treat the waste stream in accordance with the following requirements:

(1) The owner or operator shall design, install, operate, and maintain a treatment process that either:

(i) Removes benzene from the waste stream to a level less than 10 parts per million by weight (ppmw) on a flow-weighted annual average basis,

(ii) Removes benzene from the waste stream by 99 percent or more on a mass basis, or

(iii) Destroys benzene in the waste stream by incinerating the waste in a combustion unit that achieves a destruction efficiency of 99 percent or greater for benzene.

(2) Each treatment process complying with paragraphs (a)(1)(i) or (a)(1)(ii) of this section shall be designed and operated in accordance with the appropriate waste management unit standards specified in §§61.343 through 61.347 of this subpart. For example, if a treatment process is a tank, then the owner or operator shall comply with §61.343 of this subpart.

(3) For the purpose of complying with the requirements specified in paragraph (a)(1)(i) of this section, the intentional or unintentional reduction in the benzene concentration of a waste stream by dilution of the waste stream with other wastes or materials is not allowed.

(4) An owner or operator may aggregate or mix together individual waste streams to create a combined waste stream for the purpose of facilitating treatment of waste to comply with the requirements of paragraph (a)(1) of this section except as provided in paragraph (a)(5) of this section.

(5) If an owner or operator aggregates or mixes any combination of process wastewater, product tank drawdown, or landfill leachate subject to §61.342(c)(1) of this subpart together with other waste streams to create a combined waste stream for the purpose of facilitating management or treatment of waste in a wastewater treatment system, then the wastewater treatment system shall be operated in accordance with paragraph (b) of this section. These provisions apply to above-ground wastewater treatment systems as well as those that are at or below ground level.

(b) Except for facilities complying with §61.342(e), the owner or operator that aggregates or mixes individual waste streams as defined in paragraph (a)(5) of this section for management and treatment in a wastewater treatment system shall comply with the following requirements:

(1) The owner or operator shall design and operate each waste management unit that comprises the wastewater treatment system in accordance with the appropriate standards specified in §§61.343 through 61.347 of this subpart.

(2) The provisions of paragraph (b)(1) of this section do not apply to any waste management unit that the owner or operator demonstrates to meet the following conditions initially and, thereafter, at least once per year:

(i) The benzene content of each waste stream entering the waste management unit is less than 10 ppmw on a flow-weighted annual average basis as determined by the procedures specified in §61.355(c) of this subpart; and

(ii) The total annual benzene quantity contained in all waste streams managed or treated in exempt waste management units comprising the facility wastewater treatment systems is less than 1 Mg/yr (1.1 ton/yr). For this determination, total annual benzene quantity shall be calculated as follows:

(A) The total annual benzene quantity shall be calculated as the sum of the individual benzene quantities determined at each location where a waste stream first enters an exempt waste management unit. The benzene quantity discharged from an exempt waste management unit shall not be included in this calculation.

(B) The annual benzene quantity in a waste stream managed or treated in an enhanced biodegradation unit shall not be included in the calculation of the total annual benzene quantity, if the enhanced biodegradation unit is the first exempt unit in which the waste is managed or treated. A unit shall be considered enhanced biodegradation if it is a suspended-growth process that generates biomass, uses recycled biomass, and periodically removes biomass from the process. An enhanced biodegradation unit typically operates at a food-to-microorganism ratio in the range of 0.05 to 1.0 kg of biological oxygen demand per kg of biomass per day, a mixed liquor suspended solids ratio in the range of 1 to 8 grams per liter (0.008 to 0.7 pounds per liter), and a residence time in the range of 3 to 36 hours.

(c) The owner and operator shall demonstrate that each treatment process or wastewater treatment system unit, except as provided in paragraph (d) of this section, achieves the appropriate conditions specified in paragraphs (a) or (b) of this section in accordance with the following requirements:

(1) Engineering calculations in accordance with requirements specified in §61.356(e) of this subpart; or

(2) Performance tests conducted using the test methods and procedures that meet the requirements specified in §61.355 of this subpart.

(d) A treatment process or waste stream is in compliance with the requirements of this subpart and exempt from the requirements of paragraph (c) of this section provided that the owner or operator documents that the treatment process or waste stream is in compliance with other regulatory requirements as follows:

(1) The treatment process is a hazardous waste incinerator for which the owner or operator has been issued a final permit under 40 CFR part 270 and complies with the requirements of 40 CFR part 264, subpart O;

(2) The treatment process is an industrial furnace or boiler burning hazardous waste for energy recovery for which the owner or operator has been issued a final permit under 40 CFR part 270 and complies with the requirements of 40 CFR part 266, subpart D;

(3) The waste stream is treated by a means or to a level that meets benzene-specific treatment standards in accordance with the Land Disposal Restrictions under 40 CFR part 268, and the treatment process is designed and operated with a closed-vent system and control device meeting the requirements of §61.349 of this subpart;

(4) The waste stream is treated by a means or to a level that meets benzene-specific effluent limitations or performance standards in accordance with the Effluent Guidelines and Standards under 40 CFR parts 401-464, and the treatment process is designed and operated with a closed-vent system and control device meeting the requirements of §61.349 of this subpart; or

(5) The waste stream is discharged to an underground injection well for which the owner or operator has been issued a final permit under 40 CFR part 270 and complies with the requirements of 40 CFR part 122.

(e) Except as specified in paragraph (e)(3) of this section, if the treatment process or wastewater treatment system unit has any openings (e.g., access doors, hatches, etc.), all such openings shall be sealed (e.g., gasketed, latched, etc.) and kept closed at all times when waste is being treated, except during inspection and maintenance.

(1) Each seal, access door, and all other openings shall be checked by visual inspections initially and quarterly thereafter to ensure that no cracks or gaps occur and that openings are closed and gasketed properly.

(2) Except as provided in §61.350 of this subpart, when a broken seal or gasket or other problem is identified, first efforts at repair shall be made as soon as practicable, but not later than 15 calendar days after identification.

(3) If the cover and closed-vent system operate such that the treatment process and wastewater treatment system unit are maintained at a pressure less than atmospheric pressure, the owner or operator may operate the system with an opening that is not sealed and kept closed at all times if the following conditions are met:

(i) The purpose of the opening is to provide dilution air to reduce the explosion hazard;

(ii) The opening is designed to operate with no detectable emissions as indicated by an instrument reading of less than 500 ppmv above background, as determined initially and thereafter at least once per year by the methods specified in §61.355(h); and

(iii) The pressure is monitored continuously to ensure that the pressure in the treatment process and wastewater treatment system unit remain below atmospheric pressure.

(f) Except for treatment processes complying with paragraph (d) of this section, the Administrator may request at any time an owner or operator demonstrate that a treatment process or wastewater treatment system unit meets the applicable requirements specified in paragraphs (a) or (b) of this section by conducting a performance test using the test methods and procedures as required in §61.355 of this subpart.

(g) The owner or operator of a treatment process or wastewater treatment system unit that is used to comply with the provisions of this section shall monitor the unit in accordance with the applicable requirements in §61.354 of this subpart.

[55 FR 8346, Mar. 7, 1990, as amended at 55 FR 37231, Sept. 10, 1990; 58 FR 3098, Jan. 7, 1993; 65 FR 62160, Oct. 17, 2000]

[↑ Back to Top](#)

#### **§61.349 Standards: Closed-vent systems and control devices.**

(a) For each closed-vent system and control device used to comply with standards in accordance with §§61.343 through 61.348 of this subpart, the owner or operator shall properly design, install, operate, and maintain the closed-vent system and control device in accordance with the following requirements:

(1) The closed-vent system shall:

(i) Be designed to operate with no detectable emissions as indicated by an instrument reading of less than 500 ppmv above background, as determined initially and thereafter at least once per year by the methods specified in §61.355(h) of this subpart.

(ii) Vent systems that contain any bypass line that could divert the vent stream away from a control device used to comply with the provisions of this subpart shall install, maintain, and operate according to the manufacturer's specifications a flow indicator that provides a record of vent stream flow away from the control device at least once every 15 minutes, except as provided in paragraph (a)(1)(ii)(B) of this section.

(A) The flow indicator shall be installed at the entrance to any bypass line that could divert the vent stream away from the control device to the atmosphere.

(B) Where the bypass line valve is secured in the closed position with a car-seal or a lock-and-key type configuration, a flow indicator is not required.

(iii) All gauging and sampling devices shall be gas-tight except when gauging or sampling is taking place.

(iv) For each closed-vent system complying with paragraph (a) of this section, one or more devices which vent directly to the atmosphere may be used on the closed-vent system provided each device remains in a closed, sealed position during normal operations except when the device needs to open to prevent physical damage or permanent deformation of the closed-vent system resulting from malfunction of the unit in accordance with good engineering and safety practices for handling flammable, explosive, or other hazardous materials.

(2) The control device shall be designed and operated in accordance with the following conditions:

(i) An enclosed combustion device (e.g., a vapor incinerator, boiler, or process heater) shall meet one of the following conditions:

(A) Reduce the organic emissions vented to it by 95 weight percent or greater;

(B) Achieve a total organic compound concentration of 20 ppmv (as the sum of the concentrations for individual compounds using Method 18) on a dry basis corrected to 3 percent oxygen; or

(C) Provide a minimum residence time of 0.5 seconds at a minimum temperature of 760 °C (1,400 °F). If a boiler or process heater issued as the control device, then the vent stream shall be introduced into the flame zone of the boiler or process heater.

(ii) A vapor recovery system (e.g., a carbon adsorption system or a condenser) shall recover or control the organic emissions vented to it with an efficiency of 95 weight percent or greater, or shall recover or control the benzene emissions vented to it with an efficiency of 98 weight percent or greater.

(iii) A flare shall comply with the requirements of 40 CFR 60.18.

(iv) A control device other than those described in paragraphs (a)(2) (i) through (iii) of this section may be used provided that the following conditions are met:

(A) The device shall recover or control the organic emissions vented to it with an efficiency of 95 weight percent or greater, or shall recover or control the benzene emissions vented to it with an efficiency of 98 weight percent or greater.

(B) The owner or operator shall develop test data and design information that documents the control device will achieve an emission control efficiency of either 95 percent or greater for organic compounds or 98 percent or greater for benzene.

(C) The owner or operator shall identify:

(1) The critical operating parameters that affect the emission control performance of the device;

(2) The range of values of these operating parameters that ensure the emission control efficiency specified in paragraph (a)(2)(iv)(A) of this section is maintained during operation of the device; and

(3) How these operating parameters will be monitored to ensure the proper operation and maintenance of the device.

(D) The owner or operator shall submit the information and data specified in paragraphs (a)(2)(iv) (B) and (C) of this section to the Administrator prior to operation of the alternative control device.

(E) The Administrator will determine, based on the information submitted under paragraph (a)(2)(iv)(D) of this section, if the control device subject to paragraph (a)(2)(iv) of this section meets the requirements of §61.349. The control device subject to paragraph (a)(2)(iv) of this section may be operated prior to receiving approval from the Administrator. However, if the Administrator determines that the control device does not meet the requirements of §61.349, the facility may be subject to enforcement action beginning from the time the control device began operation.

(b) Each closed-vent system and control device used to comply with this subpart shall be operated at all times when waste is placed in the waste management unit vented to the control device except when maintenance or repair of the waste management unit cannot be completed without a shutdown of the control device.

(c) An owner and operator shall demonstrate that each control device, except for a flare, achieves the appropriate conditions specified in paragraph (a)(2) of this section by using one of the following methods:

(1) Engineering calculations in accordance with requirements specified in §61.356(f) of this subpart; or

(2) Performance tests conducted using the test methods and procedures that meet the requirements specified in §61.355 of this subpart.

(d) An owner or operator shall demonstrate compliance of each flare in accordance with paragraph (a)(2)(iii) of this section.

(e) The Administrator may request at any time an owner or operator demonstrate that a control device meets the applicable conditions specified in paragraph (a)(2) of this section by conducting a performance test using the test methods and procedures as required in §61.355, and for control devices subject to paragraph (a)(2)(iv) of this section, the Administrator may specify alternative test methods and procedures, as appropriate.

(f) Each closed-vent system and control device shall be visually inspected initially and quarterly thereafter. The visual inspection shall include inspection of ductwork and piping and connections to covers and control devices for evidence of visible defects such as holes in ductwork or piping and loose connections.

(g) Except as provided in §61.350 of this subpart, if visible defects are observed during an inspection, or if other problems are identified, or if detectable emissions are measured, a first effort to repair the closed-vent system and control device shall be made as soon as practicable but no later than 5 calendar days after detection. Repair shall be completed no later than 15 calendar days after the emissions are detected or the visible defect is observed.

(h) The owner or operator of a control device that is used to comply with the provisions of this section shall monitor the control device in accordance with §61.354(c) of this subpart.

[55 FR 8346, Mar. 7, 1990; 55 FR 12444, Apr. 3, 1990, as amended at 55 FR 37231, Sept. 10, 1990; 58 FR 3098, Jan. 7, 1993; 65 FR 62160, Oct. 17, 2000]

[↑ Back to Top](#)

#### **§61.350 Standards: Delay of repair.**

(a) Delay of repair of facilities or units that are subject to the provisions of this subpart will be allowed if the repair is technically impossible without a complete or partial facility or unit shutdown.

(b) Repair of such equipment shall occur before the end of the next facility or unit shutdown.



[↑ Back to Top](#)

**§61.351 Alternative standards for tanks.**

(a) As an alternative to the standards for tanks specified in §61.343 of this subpart, an owner or operator may elect to comply with one of the following:

- (1) A fixed roof and internal floating roof meeting the requirements in 40 CFR 60.112b(a)(1);
- (2) An external floating roof meeting the requirements of 40 CFR 60.112b (a)(2); or
- (3) An alternative means of emission limitation as described in 40 CFR 60.114b.

(b) If an owner or operator elects to comply with the provisions of this section, then the owner or operator is exempt from the provisions of §61.343 of this subpart applicable to the same facilities.

[55 FR 8346, Mar. 7, 1990, as amended at 55 FR 37231, Sept. 10, 1990]

[↑ Back to Top](#)

**§61.352 Alternative standards for oil-water separators.**

(a) As an alternative to the standards for oil-water separators specified in §61.347 of this subpart, an owner or operator may elect to comply with one of the following:

- (1) A floating roof meeting the requirements in 40 CFR 60.693-2(a); or
- (2) An alternative means of emission limitation as described in 40 CFR 60.694.

(b) For portions of the oil-water separator where it is infeasible to construct and operate a floating roof, such as over the weir mechanism, a fixed roof vented to a vapor control device that meets the requirements in §§61.347 and 61.349 of this subpart shall be installed and operated.

(c) Except as provided in paragraph (b) of this section, if an owner or operator elects to comply with the provisions of this section, then the owner or operator is exempt from the provisions in §61.347 of this subpart applicable to the same facilities.

[↑ Back to Top](#)

**§61.353 Alternative means of emission limitation.**

(a) If, in the Administrator's judgment, an alternative means of emission limitation will achieve a reduction in benzene emissions at least equivalent to the reduction in benzene emissions from the source achieved by the applicable design, equipment, work practice, or operational requirements in §§61.342 through 61.349, the Administrator will publish in the Federal Register a notice permitting the use of the alternative means for purposes of compliance with that requirement. The notice may condition the permission on requirements related to the operation and maintenance of the alternative means.

(b) Any notice under paragraph (a) of this section shall be published only after public notice and an opportunity for a hearing.

(c) Any person seeking permission under this section shall collect, verify, and submit to the Administrator information showing that the alternative means achieves equivalent emission reductions.

[55 FR 8346, Mar. 7, 1990, as amended at 58 FR 3099, Jan. 7, 1993]

[↑ Back to Top](#)

#### **§61.354 Monitoring of operations.**

(a) Except for a treatment process or waste stream complying with §61.348(d), the owner or operator shall monitor each treatment process or wastewater treatment system unit to ensure the unit is properly operated and maintained by one of the following monitoring procedures:

(1) Measure the benzene concentration of the waste stream exiting the treatment process complying with §61.348(a)(1)(i) at least once per month by collecting and analyzing one or more samples using the procedures specified in §61.355(c)(3).

(2) Install, calibrate, operate, and maintain according to manufacturer's specifications equipment to continuously monitor and record a process parameter (or parameters) for the treatment process or wastewater treatment system unit that indicates proper system operation. The owner or operator shall inspect at least once each operating day the data recorded by the monitoring equipment (e.g., temperature monitor or flow indicator) to ensure that the unit is operating properly.

(b) If an owner or operator complies with the requirements of §61.348(b), then the owner or operator shall monitor each wastewater treatment system to ensure the unit is properly operated and maintained by the appropriate monitoring procedure as follows:

(1) For the first exempt waste management unit in each waste treatment train, other than an enhanced biodegradation unit, measure the flow rate, using the procedures of §61.355(b), and the benzene concentration of each waste stream entering the unit at least once per month by collecting and analyzing one or more samples using the procedures specified in §61.355(c)(3).

(2) For each enhanced biodegradation unit that is the first exempt waste management unit in a treatment train, measure the benzene concentration of each waste stream entering the unit at least once per month by collecting and analyzing one or more samples using the procedures specified in §61.355(c)(3).

(c) An owner or operator subject to the requirements in §61.349 of this subpart shall install, calibrate, maintain, and operate according to the manufacturer's specifications a device to continuously monitor the control device operation as specified in the following paragraphs, unless alternative monitoring procedures or requirements are approved for that facility by the Administrator. The owner or operator shall inspect at least once each operating day the data recorded by the monitoring equipment (e.g., temperature monitor or flow indicator) to ensure that the control device is operating properly.

(1) For a thermal vapor incinerator, a temperature monitoring device equipped with a continuous recorder. The device shall have an accuracy of  $\pm 1$  percent of the temperature being monitored in  $^{\circ}\text{C}$  or  $\pm 0.5$   $^{\circ}\text{C}$ ,

whichever is greater. The temperature sensor shall be installed at a representative location in the combustion chamber.

(2) For a catalytic vapor incinerator, a temperature monitoring device equipped with a continuous recorder. The device shall be capable of monitoring temperature at two locations, and have an accuracy of  $\pm 1$  percent of the temperature being monitored in  $^{\circ}\text{C}$  or  $\pm 0.5$   $^{\circ}\text{C}$ , whichever is greater. One temperature sensor shall be installed in the vent stream at the nearest feasible point to the catalyst bed inlet and a second temperature sensor shall be installed in the vent stream at the nearest feasible point to the catalyst bed outlet.

(3) For a flare, a monitoring device in accordance with 40 CFR 60.18(f)(2) equipped with a continuous recorder.

(4) For a boiler or process heater having a design heat input capacity less than 44 MW ( $150 \times 10^6$  BTU/hr), a temperature monitoring device equipped with a continuous recorder. The device shall have an accuracy of  $\pm 1$  percent of the temperature being monitored in  $^{\circ}\text{C}$  or  $\pm 0.5$   $^{\circ}\text{C}$ , whichever is greater. The temperature sensor shall be installed at a representative location in the combustion chamber.

(5) For a boiler or process heater having a design heat input capacity greater than or equal to 44 MW ( $150 \times 10^6$  BTU/hr), a monitoring device equipped with a continuous recorder to measure a parameter(s) that indicates good combustion operating practices are being used.

(6) For a condenser, either:

(i) A monitoring device equipped with a continuous recorder to measure either the concentration level of the organic compounds or the concentration level of benzene in the exhaust vent stream from the condenser; or

(ii) A temperature monitoring device equipped with a continuous recorder. The device shall be capable of monitoring temperature at two locations, and have an accuracy of  $\pm 1$  percent of the temperature being monitored in  $^{\circ}\text{C}$  or  $\pm 0.5$   $^{\circ}\text{C}$ , whichever is greater. One temperature sensor shall be installed at a location in the exhaust stream from the condenser, and a second temperature sensor shall be installed at a location in the coolant fluid exiting the condenser.

(7) For a carbon adsorption system that regenerates the carbon bed directly in the control device such as a fixed-bed carbon adsorber, either:

(i) A monitoring device equipped with a continuous recorder to measure either the concentration level of the organic compounds or the benzene concentration level in the exhaust vent stream from the carbon bed; or

(ii) A monitoring device equipped with a continuous recorder to measure a parameter that indicates the carbon bed is regenerated on a regular, predetermined time cycle.

(8) For a vapor recovery system other than a condenser or carbon adsorption system, a monitoring device equipped with a continuous recorder to measure either the concentration level of the organic compounds or the benzene concentration level in the exhaust vent stream from the control device.

(9) For a control device subject to the requirements of §61.349(a)(2)(iv), devices to monitor the parameters as specified in §61.349(a)(2)(iv)(C).

(d) For a carbon adsorption system that does not regenerate the carbon bed directly on site in the control device (e.g., a carbon canister), either the concentration level of the organic compounds or the concentration level of benzene in the exhaust vent stream from the carbon adsorption system shall be monitored on a regular schedule, and the existing carbon shall be replaced with fresh carbon immediately when carbon breakthrough is indicated. The device shall be monitored on a daily basis or at intervals no greater than 20 percent of the design carbon replacement interval, whichever is greater. As an alternative to conducting this monitoring, an owner or operator may replace the carbon in the carbon adsorption system with fresh carbon at a regular predetermined time interval that is less than the carbon replacement interval that is determined by the maximum design flow rate and either the organic concentration or the benzene concentration in the gas stream vented to the carbon adsorption system.

(e) An alternative operation or process parameter may be monitored if it can be demonstrated that another parameter will ensure that the control device is operated in conformance with these standards and the control device's design specifications.

(f) Owners or operators using a closed-vent system that contains any bypass line that could divert a vent stream from a control device used to comply with the provisions of this subpart shall do the following:

(1) Visually inspect the bypass line valve at least once every month, checking the position of the valve and the condition of the car-seal or closure mechanism required under §61.349(a)(1)(ii) to ensure that the valve is maintained in the closed position and the vent stream is not diverted through the bypass line.

(2) Visually inspect the readings from each flow monitoring device required by §61.349(a)(1)(ii) at least once each operating day to check that vapors are being routed to the control device as required.

(g) Each owner or operator who uses a system for emission control that is maintained at a pressure less than atmospheric pressure with openings to provide dilution air shall install, calibrate, maintain, and operate according to the manufacturer's specifications a device equipped with a continuous recorder to monitor the pressure in the unit to ensure that it is less than atmospheric pressure.

[55 FR 8346, Mar. 7, 1990, as amended at 58 FR 3099, Jan. 7, 1993; 65 FR 62160, Oct. 17, 2000]

[↑ Back to Top](#)

### **§61.355 Test methods, procedures, and compliance provisions.**

(a) An owner or operator shall determine the total annual benzene quantity from facility waste by the following procedure:

(1) For each waste stream subject to this subpart having a flow-weighted annual average water content greater than 10 percent water, on a volume basis as total water, or is mixed with water or other wastes at any time and the resulting mixture has an annual average water content greater than 10 percent as specified in §61.342(a), the owner or operator shall:

(i) Determine the annual waste quantity for each waste stream using the procedures specified in paragraph (b) of this section.

(ii) Determine the flow-weighted annual average benzene concentration for each waste stream using the procedures specified in paragraph (c) of this section.

(iii) Calculate the annual benzene quantity for each waste stream by multiplying the annual waste quantity of the waste stream times the flow-weighted annual average benzene concentration.

(2) Total annual benzene quantity from facility waste is calculated by adding together the annual benzene quantity for each waste stream generated during the year and the annual benzene quantity for each process unit turnaround waste annualized according to paragraph (b)(4) of this section.

(3) If the total annual benzene quantity from facility waste is equal to or greater than 10 Mg/yr (11 ton/yr), then the owner or operator shall comply with the requirements of §61.342 (c), (d), or (e).

(4) If the total annual benzene quantity from facility waste is less than 10 Mg/yr (11 ton/yr) but is equal to or greater than 1 Mg/yr (1.1 ton/yr), then the owner or operator shall:

(i) Comply with the recordkeeping requirements of §61.356 and reporting requirements of §61.357 of this subpart; and

(ii) Repeat the determination of total annual benzene quantity from facility waste at least once per year and whenever there is a change in the process generating the waste that could cause the total annual benzene quantity from facility waste to increase to 10 Mg/yr (11 ton/yr) or more.

(5) If the total annual benzene quantity from facility waste is less than 1 Mg/yr (1.1 ton/yr), then the owner or operator shall:

(i) Comply with the recordkeeping requirements of §61.356 and reporting requirements of §61.357 of this subpart; and

(ii) Repeat the determination of total annual benzene quantity from facility waste whenever there is a change in the process generating the waste that could cause the total annual benzene quantity from facility waste to increase to 1 Mg/yr (1.1 ton/yr) or more.

(6) The benzene quantity in a waste stream that is generated less than one time per year, except as provided for process unit turnaround waste in paragraph (b)(4) of this section, shall be included in the determination of total annual benzene quantity from facility waste for the year in which the waste is generated unless the waste stream is otherwise excluded from the determination of total annual benzene quantity from facility waste in accordance with paragraphs (a) through (c) of this section. The benzene quantity in this waste stream shall not be annualized or averaged over the time interval between the activities that resulted in generation of the waste, for purposes of determining the total annual benzene quantity from facility waste.

(b) For purposes of the calculation required by paragraph (a) of this section, an owner or operator shall determine the annual waste quantity at the point of waste generation, unless otherwise provided in

paragraphs (b) (1), (2), (3), and (4) of this section, by one of the methods given in paragraphs (b) (5) through (7) of this section.

(1) The determination of annual waste quantity for sour water streams that are processed in sour water strippers shall be made at the point that the water exits the sour water stripper.

(2) The determination of annual waste quantity for wastes at coke by-product plants subject to and complying with the control requirements of §61.132, 61.133, 61.134, or 61.139 of subpart L of this part shall be made at the location that the waste stream exits the process unit component or waste management unit controlled by that subpart or at the exit of the ammonia still, provided that the following conditions are met:

(i) The transfer of wastes between units complying with the control requirements of subpart L of this part, process units, and the ammonia still is made through hard piping or other enclosed system.

(ii) The ammonia still meets the definition of a sour water stripper in §61.341.

(3) The determination of annual waste quantity for wastes that are received at hazardous waste treatment, storage, or disposal facilities from offsite shall be made at the point where the waste enters the hazardous waste treatment, storage, or disposal facility.

(4) The determination of annual waste quantity for each process unit turnaround waste generated only at 2 year or greater intervals, may be made by dividing the total quantity of waste generated during the most recent process unit turnaround by the time period (in the nearest tenth of a year) between the turnaround resulting in generation of the waste and the most recent preceding process turnaround for the unit. The resulting annual waste quantity shall be included in the calculation of the annual benzene quantity as provided in paragraph (a)(1)(iii) of this section for the year in which the turnaround occurs and for each subsequent year until the unit undergoes the next process turnaround. For estimates of total annual benzene quantity as specified in the 90-day report, required under §61.357(a)(1), the owner or operator shall estimate the waste quantity generated during the most recent turnaround, and the time period between turnarounds in accordance with good engineering practices. If the owner or operator chooses not to annualize process unit turnaround waste, as specified in this paragraph, then the process unit turnaround waste quantity shall be included in the calculation of the annual benzene quantity for the year in which the turnaround occurs.

(5) Select the highest annual quantity of waste managed from historical records representing the most recent 5 years of operation or, if the facility has been in service for less than 5 years but at least 1 year, from historical records representing the total operating life of the facility;

(6) Use the maximum design capacity of the waste management unit; or

(7) Use measurements that are representative of maximum waste generation rates.

(c) For the purposes of the calculation required by §§61.355(a) of this subpart, an owner or operator shall determine the flow-weighted annual average benzene concentration in a manner that meets the requirements given in paragraph (c)(1) of this section using either of the methods given in paragraphs (c)(2) and (c)(3) of this section.

(1) The determination of flow-weighted annual average benzene concentration shall meet all of the following criteria:

(i) The determination shall be made at the point of waste generation except for the specific cases given in paragraphs (c)(1)(i)(A) through (D) of this section.

(A) The determination for sour water streams that are processed in sour water strippers shall be made at the point that the water exits the sour water stripper.

(B) The determination for wastes at coke by-product plants subject to and complying with the control requirements of §61.132, 61.133, 61.134, or 61.139 of subpart L of this part shall be made at the location that the waste stream exits the process unit component or waste management unit controlled by that subpart or at the exit of the ammonia still, provided that the following conditions are met:

(1) The transfer of wastes between units complying with the control requirements of subpart L of this part, process units, and the ammonia still is made through hard piping or other enclosed system.

(2) The ammonia still meets the definition of a sour water stripper in §61.341.

(C) The determination for wastes that are received from offsite shall be made at the point where the waste enters the hazardous waste treatment, storage, or disposal facility.

(D) The determination of flow-weighted annual average benzene concentration for process unit turnaround waste shall be made using either of the methods given in paragraph (c)(2) or (c)(3) of this section. The resulting flow-weighted annual average benzene concentration shall be included in the calculation of annual benzene quantity as provided in paragraph (a)(1)(iii) of this section for the year in which the turnaround occurs and for each subsequent year until the unit undergoes the next process unit turnaround.

(ii) Volatilization of the benzene by exposure to air shall not be used in the determination to reduce the benzene concentration.

(iii) Mixing or diluting the waste stream with other wastes or other materials shall not be used in the determination—to reduce the benzene concentration.

(iv) The determination shall be made prior to any treatment of the waste that removes benzene, except as specified in paragraphs (c)(1)(i)(A) through (D) of this section.

(v) For wastes with multiple phases, the determination shall provide the weighted-average benzene concentration based on the benzene concentration in each phase of the waste and the relative proportion of the phases.

(2) *Knowledge of the waste.* The owner or operator shall provide sufficient information to document the flow-weighted annual average benzene concentration of each waste stream. Examples of information that could constitute knowledge include material balances, records of chemicals purchases, or previous test results provided the results are still relevant to the current waste stream conditions. If test data are used, then the owner or operator shall provide documentation describing the testing protocol and the means by which sampling variability and analytical variability were accounted for in the determination of the flow-

weighted annual average benzene concentration for the waste stream. When an owner or operator and the Administrator do not agree on determinations of the flow-weighted annual average benzene concentration based on knowledge of the waste, the procedures under paragraph (c)(3) of this section shall be used to resolve the disagreement.

(3) Measurements of the benzene concentration in the waste stream in accordance with the following procedures:

(i) Collect a minimum of three representative samples from each waste stream. Where feasible, samples shall be taken from an enclosed pipe prior to the waste being exposed to the atmosphere.

(ii) For waste in enclosed pipes, the following procedures shall be used:

(A) Samples shall be collected prior to the waste being exposed to the atmosphere in order to minimize the loss of benzene prior to sampling.

(B) A static mixer shall be installed in the process line or in a by-pass line unless the owner or operator demonstrates that installation of a static mixer in the line is not necessary to accurately determine the benzene concentration of the waste stream.

(C) The sampling tap shall be located within two pipe diameters of the static mixer outlet.

(D) Prior to the initiation of sampling, sample lines and cooling coil shall be purged with at least four volumes of waste.

(E) After purging, the sample flow shall be directed to a sample container and the tip of the sampling tube shall be kept below the surface of the waste during sampling to minimize contact with the atmosphere.

(F) Samples shall be collected at a flow rate such that the cooling coil is able to maintain a waste temperature less than 10 °C (50 °F).

(G) After filling, the sample container shall be capped immediately (within 5 seconds) to leave a minimum headspace in the container.

(H) The sample containers shall immediately be cooled and maintained at a temperature below 10 °C (50 °F) for transfer to the laboratory.

(iii) When sampling from an enclosed pipe is not feasible, a minimum of three representative samples shall be collected in a manner to minimize exposure of the sample to the atmosphere and loss of benzene prior to sampling.

(iv) Each waste sample shall be analyzed using one of the following test methods for determining the benzene concentration in a waste stream:

(A) Method 8020, Aromatic Volatile Organics, in "Test Methods for Evaluating Solid Waste, Physical/Chemical Methods," EPA Publication No. SW-846 (incorporation by reference as specified in §61.18 of this part);



(B) Method 8021, Volatile Organic Compounds in Water by Purge and Trap Capillary Column Gas Chromatography with Photoionization and Electrolytic Conductivity Detectors in Series in “Test Methods for Evaluating Solid Waste, Physical/Chemical Methods,” EPA Publication No. SW-846 (incorporation by reference as specified in §61.18 of this part);

(C) Method 8240, Gas Chromatography/Mass Spectrometry for Volatile Organics in “Test Methods for Evaluating Solid Waste, Physical/Chemical Methods,” EPA Publication No. SW-846 (incorporation by reference as specified in §61.18 of this part);

(D) Method 8260, Gas Chromatography/Mass Spectrometry for Volatile Organics: Capillary Column Technique in “Test Methods for Evaluating Solid Waste, Physical/Chemical Methods,” EPA Publication No. SW-846 (incorporation by reference as specified in §61.18 of this part);

(E) Method 602, Purgeable Aromatics, as described in 40 CFR part 136, appendix A, Test Procedures for Analysis of Organic Pollutants, for wastewaters for which this is an approved EPA methods; or

(F) Method 624, Purgeables, as described in 40 CFR part 136, appendix A, Test Procedures for Analysis of Organic Pollutants, for wastewaters for which this is an approved EPA method.

(v) The flow-weighted annual average benzene concentration shall be calculated by averaging the results of the sample analyses as follows:

$$\bar{C} = \frac{1}{Q_t} \times \sum_{i=1}^n (Q_i)(C_i)$$

[View or download PDF](#)

Where:

$\bar{C}$  = Flow-weighted annual average benzene concentration for waste stream, ppmw.

$Q_t$  = Total annual waste quantity for waste stream, kg/yr (lb/yr).

$n$  = Number of waste samples (at least 3).

$Q_i$  = Annual waste quantity for waste stream represented by  $C_i$ , kg/yr (lb/yr).

$C_i$  = Measured concentration of benzene in waste sample  $i$ , ppmw.

(d) An owner or operator using performance tests to demonstrate compliance of a treatment process with §61.348 (a)(1)(i) shall measure the flow-weighted annual average benzene concentration of the waste stream exiting the treatment process by collecting and analyzing a minimum of three representative samples of the waste stream using the procedures in paragraph (c)(3) of this section. The test shall be conducted under conditions that exist when the treatment process is operating at the highest inlet waste stream flow rate and benzene content expected to occur. Operations during periods of startup, shutdown, and malfunction shall not constitute representative conditions for the purpose of a test. The owner or operator shall record all process information as is necessary to document the operating conditions during the test.

(e) An owner or operator using performance tests to demonstrate compliance of a treatment process with §61.348(a)(1)(ii) of this subpart shall determine the percent reduction of benzene in the waste stream on a mass basis by the following procedure:

(1) The test shall be conducted under conditions that exist when the treatment process is operating at the highest inlet waste stream flow rate and benzene content expected to occur. Operations during periods of startup, shutdown, and malfunction shall not constitute representative conditions for the purpose of a test. The owner or operator shall record all process information as is necessary to document the operating conditions during the test.

(2) All testing equipment shall be prepared and installed as specified in the appropriate test methods.

(3) The mass flow rate of benzene entering the treatment process ( $E_b$ ) shall be determined by computing the product of the flow rate of the waste stream entering the treatment process, as determined by the inlet flow meter, and the benzene concentration of the waste stream, as determined using the sampling and analytical procedures specified in paragraph (c)(2) or (c)(3) of this section. Three grab samples of the waste shall be taken at equally spaced time intervals over a 1-hour period. Each 1-hour period constitutes a run, and the performance test shall consist of a minimum of 3 runs conducted over a 3-hour period. The mass flow rate of benzene entering the treatment process is calculated as follows:

$$E_b = \frac{K}{n \times 10^6} \left[ \sum_{i=1}^n V_i C_i \right]$$

[View or download PDF](#)

Where:

$E_b$  = Mass flow rate of benzene entering the treatment process, kg/hr (lb/hr).

$K$  = Density of the waste stream, kg/m<sup>3</sup> (lb/ft<sup>3</sup>).

$V_i$  = Average volume flow rate of waste entering the treatment process during each run  $i$ , m<sup>3</sup>/hr (ft<sup>3</sup>/hr).

$C_i$  = Average concentration of benzene in the waste stream entering the treatment process during each run  $i$ , ppmw.

$n$  = Number of runs.

$10^6$  = Conversion factor for ppmw.

(4) The mass flow rate of benzene exiting the treatment process ( $E_a$ ) shall be determined by computing the product of the flow rate of the waste stream exiting the treatment process, as determined by the outlet flow meter or the inlet flow meter, and the benzene concentration of the waste stream, as determined using the sampling and analytical procedures specified in paragraph (c)(2) or (c)(3) of this section. Three grab samples of the waste shall be taken at equally spaced time intervals over a 1-hour period. Each 1-hour period constitutes a run, and the performance test shall consist of a minimum of 3 runs conducted over the same 3-hour period at which the mass flow rate of benzene entering the treatment process is determined. The mass flow rate of benzene exiting the treatment process is calculated as follows:

$$E_a = \frac{K}{n \times 10^6} \left[ \sum_{i=1}^n V_i C_i \right]$$

[View or download PDF](#)

Where:

$E_a$  = Mass flow rate of benzene exiting the treatment process, kg/hr (lb/hr).

$K$  = Density of the waste stream, kg/m<sup>3</sup> (lb/ft<sup>3</sup>).

$V_i$  = Average volume flow rate of waste exiting the treatment process during each run  $i$ , m<sup>3</sup>/hr (ft<sup>3</sup>/hr).

$C_i$  = Average concentration of benzene in the waste stream exiting the treatment process during each run  $i$ , ppmw.

$n$  = Number of runs.

$10^6$  = Conversion factor for ppmw.

(f) An owner or operator using performance tests to demonstrate compliance of a treatment process with §61.348(a)(1)(iii) of this subpart shall determine the benzene destruction efficiency for the combustion unit by the following procedure:

(1) The test shall be conducted under conditions that exist when the combustion unit is operating at the highest inlet waste stream flow rate and benzene content expected to occur. Operations during periods of startup, shutdown, and malfunction shall not constitute representative conditions for the purpose of a test. The owner or operator shall record all process information necessary to document the operating conditions during the test.

(2) All testing equipment shall be prepared and installed as specified in the appropriate test methods.

(3) The mass flow rate of benzene entering the combustion unit shall be determined by computing the product of the flow rate of the waste stream entering the combustion unit, as determined by the inlet flow meter, and the benzene concentration of the waste stream, as determined using the sampling procedures in paragraph (c)(2) or (c)(3) of this section. Three grab samples of the waste shall be taken at equally spaced time intervals over a 1-hour period. Each 1-hour period constitutes a run, and the performance test shall consist of a minimum of 3 runs conducted over a 3-hour period. The mass flow rate of benzene into the combustion unit is calculated as follows:

$$E_b = \frac{K}{n \times 10^6} \left[ \sum_{i=1}^n V_i C_i \right]$$

[View or download PDF](#)

Where:

$E_b$  = Mass flow rate of benzene entering the combustion unit, kg/hr (lb/hr).

$K$  = Density of the waste stream, kg/m<sup>3</sup> (lb/ft<sup>3</sup>).

$V_i$  = Average volume flow rate of waste entering the combustion unit during each run  $i$ ,  $m^3/hr$  ( $ft^3/hr$ ).

$C_i$  = Average concentration of benzene in the waste stream entering the combustion unit during each run  $i$ , ppmw.

$n$  = Number of runs.

$10^6$  = Conversion factor for ppmw.

(4) The mass flow rate of benzene exiting the combustion unit exhaust stack shall be determined as follows:

(i) The time period for the test shall not be less than 3 hours during which at least 3 stack gas samples are collected and be the same time period at which the mass flow rate of benzene entering the treatment process is determined. Each sample shall be collected over a 1-hour period (e.g., in a tedlar bag) to represent a time-integrated composite sample and each 1-hour period shall correspond to the periods when the waste feed is sampled.

(ii) A run shall consist of a 1-hour period during the test. For each run:

(A) The reading from each measurement shall be recorded;

(B) The volume exhausted shall be determined using Method 2, 2A, 2C, or 2D from appendix A of 40 CFR part 60, as appropriate.

(C) The average benzene concentration in the exhaust downstream of the combustion unit shall be determined using Method 18 from appendix A of 40 CFR part 60.

(iii) The mass of benzene emitted during each run shall be calculated as follows:

$$M_i = D_b VC(10^{-6})$$

[View or download PDF](#)

Where:

$M_i$  = Mass of benzene emitted during run  $i$ , kg (lb).

$V$  = Volume of air-vapor mixture exhausted at standard conditions,  $m^3$  ( $ft^3$ ).

$C$  = Concentration of benzene measured in the exhaust, ppmv.

$D_b$  = Density of benzene,  $3.24 \text{ kg/m}^3$  ( $0.202 \text{ lb/ft}^3$ ).

$10^6$  = Conversion factor for ppmv.

(iv) The benzene mass emission rate in the exhaust shall be calculated as follows:

$$E_a = \left( \sum_{i=1}^n M_i \right) / T$$

[View or download PDF](#)

Where:

$E_a$  = Mass flow rate of benzene emitted from the combustion unit, kg/hr (lb/hr).

$M_i$  = Mass of benzene emitted from the combustion unit during run i, kg (lb).

T = Total time of all runs, hr.

n = Number of runs.

(5) The benzene destruction efficiency for the combustion unit shall be calculated as follows:

$$R = \frac{E_b - E_a}{E_b} \times 100$$

[View or download PDF](#)

Where:

R = Benzene destruction efficiency for the combustion unit, percent.

$E_b$  = Mass flow rate of benzene entering the combustion unit, kg/hr (lb/hr).

$E_a$  = Mass flow rate of benzene emitted from the combustion unit, kg/hr (lb/hr).

(g) An owner or operator using performance tests to demonstrate compliance of a wastewater treatment system unit with §61.348(b) shall measure the flow-weighted annual average benzene concentration of the wastewater stream where the waste stream enters an exempt waste management unit by collecting and analyzing a minimum of three representative samples of the waste stream using the procedures in paragraph (c)(3) of this section. The test shall be conducted under conditions that exist when the wastewater treatment system is operating at the highest inlet wastewater stream flow rate and benzene content expected to occur. Operations during periods of startup, shutdown, and malfunction shall not constitute representative conditions for the purpose of a test. The owner or operator shall record all process information as is necessary to document the operating conditions during the test.

(h) An owner or operator shall test equipment for compliance with no detectable emissions as required in §§61.343 through 61.347, and §61.349 of this subpart in accordance with the following requirements:

(1) Monitoring shall comply with Method 21 from appendix A of 40 CFR part 60.

(2) The detection instrument shall meet the performance criteria of Method 21.

(3) The instrument shall be calibrated before use on each day of its use by the procedures specified in Method 21.

(4) Calibration gases shall be:

(i) Zero air (less than 10 ppm of hydrocarbon in air); and

(ii) A mixture of methane or n-hexane and air at a concentration of approximately, but less than, 10,000 ppm methane or n-hexane.

(5) The background level shall be determined as set forth in Method 21.

(6) The instrument probe shall be traversed around all potential leak interfaces as close as possible to the interface as described in Method 21.

(7) The arithmetic difference between the maximum concentration indicated by the instrument and the background level is compared to 500 ppm for determining compliance.

(i) An owner or operator using a performance test to demonstrate compliance of a control device with either the organic reduction efficiency requirement or the benzene reduction efficiency requirement specified under §61.349(a)(2) shall use the following procedures:

(1) The test shall be conducted under conditions that exist when the waste management unit vented to the control device is operating at the highest load or capacity level expected to occur. Operations during periods of startup, shutdown, and malfunction shall not constitute representative conditions for the purpose of a test. The owner or operator shall record all process information necessary to document the operating conditions during the test.

(2) Sampling sites shall be selected using Method 1 or 1A from appendix A of 40 CFR part 60, as appropriate.

(3) The mass flow rate of either the organics or benzene entering and exiting the control device shall be determined as follows:

(i) The time period for the test shall not be less than 3 hours during which at least 3 stack gas samples are collected. Samples of the vent stream entering and exiting the control device shall be collected during the same time period. Each sample shall be collected over a 1-hour period (e.g., in a tedlar bag) to represent a time-integrated composite sample.

(ii) A run shall consist of a 1-hour period during the test. For each run:

(A) The reading from each measurement shall be recorded;

(B) The volume exhausted shall be determined using Method 2, 2A, 2C, or 2D from appendix A of 40 CFR part 60, as appropriate;

(C) The organic concentration or the benzene concentration, as appropriate, in the vent stream entering and exiting the control shall be determined using Method 18 from appendix A of 40 CFR part 60.

(iii) The mass of organics or benzene entering and exiting the control device during each run shall be calculated as follows:

$$M_{aj} = \frac{K_1 V_{aj}}{10^6} \left( \sum_{i=1}^n C_{ai} MW_i \right)$$

[View or download PDF](#)

$$M_{bj} = \frac{K_1 V_{bj}}{10^6} \left( \sum_{i=1}^n C_{bi} MW_i \right)$$

[View or download PDF](#)

$M_{aj}$  = Mass of organics or benzene in the vent stream entering the control device during run j, kg (lb).

$M_{bj}$  = Mass of organics or benzene in the vent stream exiting the control device during run j, kg (lb).

$V_{aj}$  = Volume of vent stream entering the control device during run j, at standard conditions, m<sup>3</sup> (ft<sup>3</sup>).

$V_{bj}$  = Volume of vent stream exiting the control device during run j, at standard conditions, m<sup>3</sup> (ft<sup>3</sup>).

$C_{ai}$  = Organic concentration of compound i or the benzene concentration measured in the vent stream entering the control device as determined by Method 18, ppm by volume on a dry basis.

$C_{bi}$  = Organic concentration of compound i or the benzene concentration measured in the vent stream exiting the control device as determined by Method 18, ppm by volume on a dry basis.

$MW_i$  = Molecular weight of organic compound i in the vent stream, or the molecular weight of benzene, kg/kg-mol (lb/lb-mole).

n = Number of organic compounds in the vent stream; if benzene reduction efficiency is being demonstrated, then n = 1.

$K_1$  = Conversion factor for molar volume at standard conditions (293 K and 760 mm Hg (527 R and 14.7 psia))

$$= 0.0416 \text{ kg-mol/m}^3 \text{ (0.00118 lb-mol/ft}^3\text{)}$$

$10^{-6}$  = Conversion factor for ppmv.

(iv) The mass flow rate of organics or benzene entering and exiting the control device shall be calculated as follows:

$$E_a = \left( \sum_{j=1}^n M_{aj} \right) / T$$

$$E_b = \left( \sum_{j=1}^n M_{bj} \right) / T$$

[View or download PDF](#)

Where:

$E_a$  = Mass flow rate of organics or benzene entering the control device, kg/hr (lb/hr).

$E_b$  = Mass flow rate of organics or benzene exiting the control device, kg/hr (lb/hr).

$M_{aj}$  = Mass of organics or benzene in the vent stream entering the control device during run j, kg (lb).

$M_{bj}$  = Mass of organics or benzene in the vent stream exiting the control device during run j, kg (lb).

T = Total time of all runs, hr.

n = Number of runs.

(4) The organic reduction efficiency or the benzene reduction efficiency for the control device shall be calculated as follows:

$$R = \frac{E_a - E_b}{E_a} \times 100$$

[View or download PDF](#)

Where:

R = Total organic reduction of efficiency or benzene reduction efficiency for the control device, percent.

$E_b$  = Mass flow rate of organics or benzene entering the control device, kg/hr (lb/hr).

$E_a$  = Mass flow rate of organic or benzene emitted from the control device, kg/hr (lb/hr).

(j) An owner or operator shall determine the benzene quantity for the purposes of the calculation required by §61.342 (c)(3)(ii)(B) according to the provisions of paragraph (a) of this section, except that the procedures in paragraph (a) of this section shall also apply to wastes with a water content of 10 percent or less.

(k) An owner or operator shall determine the benzene quantity for the purposes of the calculation required by §61.342(e)(2) by the following procedure:

(1) For each waste stream that is not controlled for air emissions in accordance with §61.343, 61.344, 61.345, 61.346, 61.347, or 61.348(a), as applicable to the waste management unit that manages the waste, the benzene quantity shall be determined as specified in paragraph (a) of this section, except that paragraph (b)(4) of this section shall not apply, i.e., the waste quantity for process unit turnaround waste is not annualized but shall be included in the determination of benzene quantity for the year in which the waste is generated for the purposes of the calculation required by §61.342(e)(2).

(2) For each waste stream that is controlled for air emissions in accordance with §61.343, 61.344, 61.345, 61.346, 61.347, or 61.348(a), as applicable to the waste management unit that manages the waste, the determination of annual waste quantity and flow-weighted annual average benzene concentration shall be made at the first applicable location as described in paragraphs (k)(2)(i), (k)(2)(ii), and (k)(2)(iii) of this section and prior to any reduction of benzene concentration through volatilization of the benzene, using the methods given in (k)(2)(iv) and (k)(2)(v) of this section.

(i) Where the waste stream enters the first waste management unit not complying with §§61.343, 61.344, 61.345, 61.346, 61.347, and 61.348(a) that are applicable to the waste management unit,



(ii) For each waste stream that is managed or treated only in compliance with §§61.343 through 61.348(a) up to the point of final direct discharge from the facility, the determination of benzene quantity shall be prior to any reduction of benzene concentration through volatilization of the benzene, or

(iii) For wastes managed in units controlled for air emissions in accordance with §§61.343, 61.344, 61.345, 61.346, 61.347, and 61.348(a), and then transferred offsite, facilities shall use the first applicable offsite location as described in paragraphs (k)(2)(i) and (k)(2)(ii) of this section if they have documentation from the offsite facility of the benzene quantity at this location. Facilities without this documentation for offsite wastes shall use the benzene quantity determined at the point where the transferred waste leaves the facility.

(iv) Annual waste quantity shall be determined using the procedures in paragraphs (b)(5), (6), or (7) of this section, and

(v) The flow-weighted annual average benzene concentration shall be determined using the procedures in paragraphs (c)(2) or (3) of this section.

(3) The benzene quantity in a waste stream that is generated less than one time per year, including process unit turnaround waste, shall be included in the determination of benzene quantity as determined in paragraph (k)(6) of this section for the year in which the waste is generated. The benzene quantity in this waste stream shall not be annualized or averaged over the time interval between the activities that resulted in generation of the waste for purposes of determining benzene quantity as determined in paragraph (k)(6) of this section.

(4) The benzene in waste entering an enhanced biodegradation unit, as defined in §61.348(b)(2)(ii)(B), shall not be included in the determination of benzene quantity, determined in paragraph (k)(6) of this section, if the following conditions are met:

(i) The benzene concentration for each waste stream entering the enhanced biodegradation unit is less than 10 ppmw on a flow-weighted annual average basis, and

(ii) All prior waste management units managing the waste comply with §§61.343, 61.344, 61.345, 61.346, 61.347 and 61.348(a).

(5) The benzene quantity for each waste stream in paragraph (k)(2) of this section shall be determined by multiplying the annual waste quantity of each waste stream times its flow-weighted annual average benzene concentration.

(6) The total benzene quantity for the purposes of the calculation required by §61.342(e)(2) shall be determined by adding together the benzene quantities determined in paragraphs (k)(1) and (k)(5) of this section for each applicable waste stream.

(7) If the benzene quantity determined in paragraph (6) of this section exceeds 6.0 Mg/yr (6.6 ton/yr) only because of multiple counting of the benzene quantity for a waste stream, the owner or operator may use the following procedures for the purposes of the calculation required by §61.342(e)(2):

(i) Determine which waste management units are involved in the multiple counting of benzene;

(ii) Determine the quantity of benzene that is emitted, recovered, or removed from the affected units identified in paragraph (k)(7)(i) of this section, or destroyed in the units if applicable, using either direct measurements or the best available estimation techniques developed or approved by the Administrator.

(iii) Adjust the benzene quantity to eliminate the multiple counting of benzene based on the results from paragraph (k)(7)(ii) of this section and determine the total benzene quantity for the purposes of the calculation required by §61.342(e)(2).

(iv) Submit in the annual report required under §61.357(a) a description of the methods used and the resulting calculations for the alternative procedure under paragraph (k)(7) of this section, the benzene quantity determination from paragraph (k)(6) of this section, and the adjusted benzene quantity determination from paragraph (k)(7)(iii) of this section.

[55 FR 8346, Mar. 7, 1990; 55 FR 12444, Apr. 3, 1990, as amended at 55 FR 37231, Sept. 10, 1990; 58 FR 3099, Jan. 7, 1993; 65 FR 62160, Oct. 17, 2000]

[↑ Back to Top](#)

#### **§61.356 Recordkeeping requirements.**

(a) Each owner or operator of a facility subject to the provisions of this subpart shall comply with the recordkeeping requirements of this section. Each record shall be maintained in a readily accessible location at the facility site for a period not less than two years from the date the information is recorded unless otherwise specified.

(b) Each owner or operator shall maintain records that identify each waste stream at the facility subject to this subpart, and indicate whether or not the waste stream is controlled for benzene emissions in accordance with this subpart. In addition the owner or operator shall maintain the following records:

(1) For each waste stream not controlled for benzene emissions in accordance with this subpart, the records shall include all test results, measurements, calculations, and other documentation used to determine the following information for the waste stream: waste stream identification, water content, whether or not the waste stream is a process wastewater stream, annual waste quantity, range of benzene concentrations, annual average flow-weighted benzene concentration, and annual benzene quantity.

(2) For each waste stream exempt from §61.342(c)(1) in accordance with §61.342(c)(3), the records shall include:

(i) All measurements, calculations, and other documentation used to determine that the continuous flow of process wastewater is less than 0.02 liters (0.005 gallons) per minute or the annual waste quantity of process wastewater is less than 10 Mg/yr (11 ton/yr) in accordance with §61.342(c)(3)(i), or

(ii) All measurements, calculations, and other documentation used to determine that the sum of the total annual benzene quantity in all exempt waste streams does not exceed 2.0 Mg/yr (2.2 ton/yr) in accordance with §61.342(c)(3)(ii).

(3) For each facility where process wastewater streams are controlled for benzene emissions in accordance with §61.342(d) of this subpart, the records shall include for each treated process wastewater

stream all measurements, calculations, and other documentation used to determine the annual benzene quantity in the process wastewater stream exiting the treatment process.

(4) For each facility where waste streams are controlled for benzene emissions in accordance with §61.342(e), the records shall include for each waste stream all measurements, including the locations of the measurements, calculations, and other documentation used to determine that the total benzene quantity does not exceed 6.0 Mg/yr (6.6 ton/yr).

(5) For each facility where the annual waste quantity for process unit turnaround waste is determined in accordance with §61.355(b)(5), the records shall include all test results, measurements, calculations, and other documentation used to determine the following information: identification of each process unit at the facility that undergoes turnarounds, the date of the most recent turnaround for each process unit, identification of each process unit turnaround waste, the water content of each process unit turnaround waste, the annual waste quantity determined in accordance with §61.355(b)(5), the range of benzene concentrations in the waste, the annual average flow-weighted benzene concentration of the waste, and the annual benzene quantity calculated in accordance with §61.355(a)(1)(iii) of this section.

(6) For each facility where wastewater streams are controlled for benzene emissions in accordance with §61.348(b)(2), the records shall include all measurements, calculations, and other documentation used to determine the annual benzene content of the waste streams and the total annual benzene quantity contained in all waste streams managed or treated in exempt waste management units.

(c) An owner or operator transferring waste off-site to another facility for treatment in accordance with §61.342(f) shall maintain documentation for each offsite waste shipment that includes the following information: Date waste is shipped offsite, quantity of waste shipped offsite, name and address of the facility receiving the waste, and a copy of the notice sent with the waste shipment.

(d) An owner or operator using control equipment in accordance with §§61.343 through 61.347 shall maintain engineering design documentation for all control equipment that is installed on the waste management unit. The documentation shall be retained for the life of the control equipment. If a control device is used, then the owner or operator shall maintain the control device records required by paragraph (f) of this section.

(e) An owner or operator using a treatment process or wastewater treatment system unit in accordance with §61.348 of this subpart shall maintain the following records. The documentation shall be retained for the life of the unit.

(1) A statement signed and dated by the owner or operator certifying that the unit is designed to operate at the documented performance level when the waste stream entering the unit is at the highest waste stream flow rate and benzene content expected to occur.

(2) If engineering calculations are used to determine treatment process or wastewater treatment system unit performance, then the owner or operator shall maintain the complete design analysis for the unit. The design analysis shall include for example the following information: Design specifications, drawings, schematics, piping and instrumentation diagrams, and other documentation necessary to demonstrate the unit performance.

(3) If performance tests are used to determine treatment process or wastewater treatment system unit performance, then the owner or operator shall maintain all test information necessary to demonstrate the unit performance.

(i) A description of the unit including the following information: type of treatment process; manufacturer name and model number; and for each waste stream entering and exiting the unit, the waste stream type (e.g., process wastewater, sludge, slurry, etc.), and the design flow rate and benzene content.

(ii) Documentation describing the test protocol and the means by which sampling variability and analytical variability were accounted for in the determination of the unit performance. The description of the test protocol shall include the following information: sampling locations, sampling method, sampling frequency, and analytical procedures used for sample analysis.

(iii) Records of unit operating conditions during each test run including all key process parameters.

(iv) All test results.

(4) If a control device is used, then the owner or operator shall maintain the control device records required by paragraph (f) of this section.

(f) An owner or operator using a closed-vent system and control device in accordance with §61.349 of this subpart shall maintain the following records. The documentation shall be retained for the life of the control device.

(1) A statement signed and dated by the owner or operator certifying that the closed-vent system and control device is designed to operate at the documented performance level when the waste management unit vented to the control device is or would be operating at the highest load or capacity expected to occur.

(2) If engineering calculations are used to determine control device performance in accordance with §61.349(c), then a design analysis for the control device that includes for example:

(i) Specifications, drawings, schematics, and piping and instrumentation diagrams prepared by the owner or operator, or the control device manufacturer or vendor that describe the control device design based on acceptable engineering texts. The design analysis shall address the following vent stream characteristics and control device operating parameters:

(A) For a thermal vapor incinerator, the design analysis shall consider the vent stream composition, constituent concentrations, and flow rate. The design analysis shall also establish the design minimum and average temperature in the combustion zone and the combustion zone residence time.

(B) For a catalytic vapor incinerator, the design analysis shall consider the vent stream composition, constituent concentrations, and flow rate. The design analysis shall also establish the design minimum and average temperatures across the catalyst bed inlet and outlet.

(C) For a boiler or process heater, the design analysis shall consider the vent stream composition, constituent concentrations, and flow rate. The design analysis shall also establish the design minimum

and average flame zone temperatures, combustion zone residence time, and description of method and location where the vent stream is introduced into the flame zone.

(D) For a flare, the design analysis shall consider the vent stream composition, constituent concentrations, and flow rate. The design analysis shall also consider the requirements specified in 40 CFR 60.18.

(E) For a condenser, the design analysis shall consider the vent stream composition, constituent concentration, flow rate, relative humidity, and temperature. The design analysis shall also establish the design outlet organic compound concentration level or the design outlet benzene concentration level, design average temperature of the condenser exhaust vent stream, and the design average temperatures of the coolant fluid at the condenser inlet and outlet.

(F) For a carbon adsorption system that regenerates the carbon bed directly on-site in the control device such as a fixed-bed adsorber, the design analysis shall consider the vent stream composition, constituent concentration, flow rate, relative humidity, and temperature. The design analysis shall also establish the design exhaust vent stream organic compound concentration level or the design exhaust vent stream benzene concentration level, number and capacity of carbon beds, type and working capacity of activated carbon used for carbon beds, design total steam flow over the period of each complete carbon bed regeneration cycle, duration of the carbon bed steaming and cooling/drying cycles, design carbon bed temperature after regeneration, design carbon bed regeneration time, and design service life of carbon.

(G) For a carbon adsorption system that does not regenerate the carbon bed directly on-site in the control device, such as a carbon canister, the design analysis shall consider the vent stream composition, constituent concentration, flow rate, relative humidity, and temperature. The design analysis shall also establish the design exhaust vent stream organic compound concentration level or the design exhaust vent stream benzene concentration level, capacity of carbon bed, type and working capacity of activated carbon used for carbon bed, and design carbon replacement interval based on the total carbon working capacity of the control device and source operating schedule.

(H) For a control device subject to the requirements of §61.349(a)(2)(iv), the design analysis shall consider the vent stream composition, constituent concentration, and flow rate. The design analysis shall also include all of the information submitted under §61.349 (a)(2)(iv).

(ii) [Reserved]

(3) If performance tests are used to determine control device performance in accordance with §61.349(c) of this subpart:

(i) A description of how it is determined that the test is conducted when the waste management unit or treatment process is operating at the highest load or capacity level. This description shall include the estimated or design flow rate and organic content of each vent stream and definition of the acceptable operating ranges of key process and control parameters during the test program.

(ii) A description of the control device including the type of control device, control device manufacturer's name and model number, control device dimensions, capacity, and construction materials.

(iii) A detailed description of sampling and monitoring procedures, including sampling and monitoring locations in the system, the equipment to be used, sampling and monitoring frequency, and planned analytical procedures for sample analysis.

(iv) All test results.

(g) An owner or operator shall maintain a record for each visual inspection required by §§61.343 through 61.347 of this subpart that identifies a problem (such as a broken seal, gap or other problem) which could result in benzene emissions. The record shall include the date of the inspection, waste management unit and control equipment location where the problem is identified, a description of the problem, a description of the corrective action taken, and the date the corrective action was completed.

(h) An owner or operator shall maintain a record for each test of no detectable emissions required by §§61.343 through 61.347 and §61.349 of this subpart. The record shall include the following information: date the test is performed, background level measured during test, and maximum concentration indicated by the instrument reading measured for each potential leak interface. If detectable emissions are measured at a leak interface, then the record shall also include the waste management unit, control equipment, and leak interface location where detectable emissions were measured, a description of the problem, a description of the corrective action taken, and the date the corrective action was completed.

(i) For each treatment process and wastewater treatment system unit operated to comply with §61.348, the owner or operator shall maintain documentation that includes the following information regarding the unit operation:

(1) Dates of startup and shutdown of the unit.

(2) If measurements of waste stream benzene concentration are performed in accordance with §61.354(a)(1) of this subpart, the owner or operator shall maintain records that include date each test is performed and all test results.

(3) If a process parameter is continuously monitored in accordance with §61.354(a)(2) of this subpart, the owner or operator shall maintain records that include a description of the operating parameter (or parameters) to be monitored to ensure that the unit will be operated in conformance with these standards and the unit's design specifications, and an explanation of the criteria used for selection of that parameter (or parameters). This documentation shall be kept for the life of the unit.

(4) If measurements of waste stream benzene concentration are performed in accordance with §61.354(b), the owner or operator shall maintain records that include the date each test is performed and all test results.

(5) Periods when the unit is not operated as designed.

(j) For each control device, the owner or operator shall maintain documentation that includes the following information regarding the control device operation:

(1) Dates of startup and shutdown of the closed-vent system and control device.

(2) A description of the operating parameter (or parameters) to be monitored to ensure that the control device will be operated in conformance with these standards and the control device's design specifications and an explanation of the criteria used for selection of that parameter (or parameters). This documentation shall be kept for the life of the control device.

(3) Periods when the closed-vent system and control device are not operated as designed including all periods and the duration when:

(i) Any valve car-seal or closure mechanism required under §61.349(a)(1)(ii) is broken or the by-pass line valve position has changed.

(ii) The flow monitoring devices required under §61.349(a)(1)(ii) indicate that vapors are not routed to the control device as required.

(4) If a thermal vapor incinerator is used, then the owner or operator shall maintain continuous records of the temperature of the gas stream in the combustion zone of the incinerator and records of all 3-hour periods of operation during which the average temperature of the gas stream in the combustion zone is more than 28 °C (50 °F) below the design combustion zone temperature.

(5) If a catalytic vapor incinerator is used, then the owner or operator shall maintain continuous records of the temperature of the gas stream both upstream and downstream of the catalyst bed of the incinerator, records of all 3-hour periods of operation during which the average temperature measured before the catalyst bed is more than 28 °C (50 °F) below the design gas stream temperature, and records of all 3-hour periods of operation during which the average temperature difference across the catalyst bed is less than 80 percent of the design temperature difference.

(6) If a boiler or process heater is used, then the owner or operator shall maintain records of each occurrence when there is a change in the location at which the vent stream is introduced into the flame zone as required by §61.349(a)(2)(i)(C). For a boiler or process heater having a design heat input capacity less than 44 MW ( $150 \times 106$  BTU/hr), the owner or operator shall maintain continuous records of the temperature of the gas stream in the combustion zone of the boiler or process heater and records of all 3-hour periods of operation during which the average temperature of the gas stream in the combustion zone is more than 28 °C (50 °F) below the design combustion zone temperature. For a boiler or process heater having a design heat input capacity greater than or equal to 44 MW ( $150 \times 106$  BTU/hr), the owner or operator shall maintain continuous records of the parameter(s) monitored in accordance with the requirements of §61.354(c)(5).

(7) If a flare is used, then the owner or operator shall maintain continuous records of the flare pilot flame monitoring and records of all periods during which the pilot flame is absent.

(8) If a condenser is used, then the owner or operator shall maintain records from the monitoring device of the parameters selected to be monitored in accordance with §61.354(c)(6). If concentration of organics or concentration of benzene in the control device outlet gas stream is monitored, then the owner or operator shall record all 3-hour periods of operation during which the concentration of organics or the concentration of benzene in the exhaust stream is more than 20 percent greater than the design value. If the temperature of the condenser exhaust stream and coolant fluid is monitored, then the owner or operator shall record all 3-hour periods of operation during which the temperature of the condenser

exhaust vent stream is more than 6 °C (11 °F) above the design average exhaust vent stream temperature, or the temperature of the coolant fluid exiting the condenser is more than 6 °C (11 °F) above the design average coolant fluid temperature at the condenser outlet.

(9) If a carbon adsorber is used, then the owner or operator shall maintain records from the monitoring device of the concentration of organics or the concentration of benzene in the control device outlet gas stream. If the concentration of organics or the concentration of benzene in the control device outlet gas stream is monitored, then the owner or operator shall record all 3-hour periods of operation during which the concentration of organics or the concentration of benzene in the exhaust stream is more than 20 percent greater than the design value. If the carbon bed regeneration interval is monitored, then the owner or operator shall record each occurrence when the vent stream continues to flow through the control device beyond the predetermined carbon bed regeneration time.

(10) If a carbon adsorber that is not regenerated directly on site in the control device is used, then the owner or operator shall maintain records of dates and times when the control device is monitored, when breakthrough is measured, and shall record the date and time then the existing carbon in the control device is replaced with fresh carbon.

(11) If an alternative operational or process parameter is monitored for a control device, as allowed in §61.354(e) of this subpart, then the owner or operator shall maintain records of the continuously monitored parameter, including periods when the device is not operated as designed.

(12) If a control device subject to the requirements of §61.349(a)(2)(iv) is used, then the owner or operator shall maintain records of the parameters that are monitored and each occurrence when the parameters monitored are outside the range of values specified in §61.349(a)(2)(iv)(C), or other records as specified by the Administrator.

(k) An owner or operator who elects to install and operate the control equipment in §61.351 of this subpart shall comply with the recordkeeping requirements in 40 CFR 60.115b.

(l) An owner or operator who elects to install and operate the control equipment in §61.352 of this subpart shall maintain records of the following:

(1) The date, location, and corrective action for each visual inspection required by 40 CFR 60.693-2(a)(5), during which a broken seal, gap, or other problem is identified that could result in benzene emissions.

(2) Results of the seal gap measurements required by 40 CFR 60.693-2(a).

(m) If a system is used for emission control that is maintained at a pressure less than atmospheric pressure with openings to provide dilution air, then the owner or operator shall maintain records of the monitoring device and records of all periods during which the pressure in the unit is operated at a pressure that is equal to or greater than atmospheric pressure.

(n) Each owner or operator using a total enclosure to comply with control requirements for tanks in §61.343 or the control requirements for containers in §61.345 must keep the records required in paragraphs (n)(1) and (2) of this section. Owners or operators may use records as required in 40 CFR



264.1089(b)(2)(iv) or 40 CFR 265.1090(b)(2)(iv) for a tank or as required in 40 CFR 264.1089(d)(1) or 40 CFR 265.1090(d)(1) for a container to meet the recordkeeping requirement in paragraph (n)(1) of this section. The owner or operator must make the records of each verification of a total enclosure available for inspection upon request.

(1) Records of the most recent set of calculations and measurements performed to verify that the enclosure meets the criteria of a permanent total enclosure as specified in “Procedure T—Criteria for and Verification of a Permanent or Temporary Total Enclosure” in 40 CFR 52.741, appendix B;

(2) Records required for a closed-vent system and control device according to the requirements in paragraphs (d) (f), and (j) of this section.

[55 FR 8346, Mar. 7, 1990; 55 FR 12444, Apr. 3, 1990; 55 FR 18331, May 2, 1990, as amended at 58 FR 3103, Jan. 7, 1993; 65 FR 62161, Oct. 17, 2000; 67 FR 68533, Nov. 12, 2002]

[↑ Back to Top](#)

### **§61.357 Reporting requirements.**

(a) Each owner or operator of a chemical plant, petroleum refinery, coke by-product recovery plant, and any facility managing wastes from these industries shall submit to the Administrator within 90 days after January 7, 1993, or by the initial startup for a new source with an initial startup after the effective date, a report that summarizes the regulatory status of each waste stream subject to §61.342 and is determined by the procedures specified in §61.355(c) to contain benzene. Each owner or operator subject to this subpart who has no benzene onsite in wastes, products, by-products, or intermediates shall submit an initial report that is a statement to this effect. For all other owners or operators subject to this subpart, the report shall include the following information:

(1) Total annual benzene quantity from facility waste determined in accordance with §61.355(a) of this subpart.

(2) A table identifying each waste stream and whether or not the waste stream will be controlled for benzene emissions in accordance with the requirements of this subpart.

(3) For each waste stream identified as not being controlled for benzene emissions in accordance with the requirements of this subpart the following information shall be added to the table:

(i) Whether or not the water content of the waste stream is greater than 10 percent;

(ii) Whether or not the waste stream is a process wastewater stream, product tank drawdown, or landfill leachate;

(iii) Annual waste quantity for the waste stream;

(iv) Range of benzene concentrations for the waste stream;

(v) Annual average flow-weighted benzene concentration for the waste stream; and

(vi) Annual benzene quantity for the waste stream.

(4) The information required in paragraphs (a) (1), (2), and (3) of this section should represent the waste stream characteristics based on current configuration and operating conditions. An owner or operator only needs to list in the report those waste streams that contact materials containing benzene. The report does not need to include a description of the controls to be installed to comply with the standard or other information required in §61.10(a).

(b) If the total annual benzene quantity from facility waste is less than 1 Mg/yr (1.1 ton/yr), then the owner or operator shall submit to the Administrator a report that updates the information listed in paragraphs (a)(1) through (a)(3) of this section whenever there is a change in the process generating the waste stream that could cause the total annual benzene quantity from facility waste to increase to 1 Mg/yr (1.1 ton/yr) or more.

(c) If the total annual benzene quantity from facility waste is less than 10 Mg/yr (11 ton/yr) but is equal to or greater than 1 Mg/yr (1.1 ton/yr), then the owner or operator shall submit to the Administrator a report that updates the information listed in paragraphs (a)(1) through (a)(3) of this section. The report shall be submitted annually and whenever there is a change in the process generating the waste stream that could cause the total annual benzene quantity from facility waste to increase to 10 Mg/yr (11 ton/yr) or more. If the information in the annual report required by paragraphs (a)(1) through (a)(3) of this section is not changed in the following year, the owner or operator may submit a statement to that effect.

(d) If the total annual benzene quantity from facility waste is equal to or greater than 10 Mg/yr (11 ton/yr), then the owner or operator shall submit to the Administrator the following reports:

(1) Within 90 days after January 7, 1993, unless a waiver of compliance under §61.11 of this part is granted, or by the date of initial startup for a new source with an initial startup after the effective date, a certification that the equipment necessary to comply with these standards has been installed and that the required initial inspections or tests have been carried out in accordance with this subpart. If a waiver of compliance is granted under §61.11, the certification of equipment necessary to comply with these standards shall be submitted by the date the waiver of compliance expires.

(2) Beginning on the date that the equipment necessary to comply with these standards has been certified in accordance with paragraph (d)(1) of this section, the owner or operator shall submit annually to the Administrator a report that updates the information listed in paragraphs (a)(1) through (a)(3) of this section. If the information in the annual report required by paragraphs (a)(1) through (a)(3) of this section is not changed in the following year, the owner or operator may submit a statement to that effect.

(3) If an owner or operator elects to comply with the requirements of §61.342(c)(3)(ii), then the report required by paragraph (d)(2) of this section shall include a table identifying each waste stream chosen for exemption and the total annual benzene quantity in these exempted streams.

(4) If an owner or operator elects to comply with the alternative requirements of §61.342(d) of this subpart, then he shall include in the report required by paragraph (d)(2) of this section a table presenting the following information for each process wastewater stream:

(i) Whether or not the process wastewater stream is being controlled for benzene emissions in accordance with the requirements of this subpart;

(ii) For each process wastewater stream identified as not being controlled for benzene emissions in accordance with the requirements of this subpart, the table shall report the following information for the process wastewater stream as determined at the point of waste generation: annual waste quantity, range of benzene concentrations, annual average flow-weighted benzene concentration, and annual benzene quantity;

(iii) For each process wastewater stream identified as being controlled for benzene emissions in accordance with the requirements of this subpart, the table shall report the following information for the process wastewater stream as determined at the exit to the treatment process: Annual waste quantity, range of benzene concentrations, annual average flow-weighted benzene concentration, and annual benzene quantity.

(5) If an owner or operator elects to comply with the alternative requirements of §61.342(e), then the report required by paragraph (d)(2) of this section shall include a table presenting the following information for each waste stream:

(i) For each waste stream identified as not being controlled for benzene emissions in accordance with the requirements of this subpart; the table shall report the following information for the waste stream as determined at the point of waste generation: annual waste quantity, range of benzene concentrations, annual average flow-weighted benzene concentration, and annual benzene quantity;

(ii) For each waste stream identified as being controlled for benzene emissions in accordance with the requirements of this subpart; the table shall report the following information for the waste stream as determined at the applicable location described in §61.355(k)(2): Annual waste quantity, range of benzene concentrations, annual average flow-weighted benzene concentration, and annual benzene quantity.

(6) Beginning 3 months after the date that the equipment necessary to comply with these standards has been certified in accordance with paragraph (d)(1) of this section, the owner or operator shall submit quarterly to the Administrator a certification that all of the required inspections have been carried out in accordance with the requirements of this subpart.

(7) Beginning 3 months after the date that the equipment necessary to comply with these standards has been certified in accordance with paragraph (d)(1) of this section, the owner or operator shall submit a report quarterly to the Administrator that includes:

(i) If a treatment process or wastewater treatment system unit is monitored in accordance with §61.354(a)(1) of this subpart, then each period of operation during which the concentration of benzene in the monitored waste stream exiting the unit is equal to or greater than 10 ppmw.

(ii) If a treatment process or wastewater treatment system unit is monitored in accordance with §61.354(a)(2) of this subpart, then each 3-hour period of operation during which the average value of the monitored parameter is outside the range of acceptable values or during which the unit is not operating as designed.

(iii) If a treatment process or wastewater treatment system unit is monitored in accordance with §61.354(b), then each period of operation during which the flow-weighted annual average concentration

of benzene in the monitored waste stream entering the unit is equal to or greater than 10 ppmw and/or the total annual benzene quantity is equal to or greater than 1.0 mg/yr.

(iv) For a control device monitored in accordance with §61.354(c) of this subpart, each period of operation monitored during which any of the following conditions occur, as applicable to the control device:

(A) Each 3-hour period of operation during which the average temperature of the gas stream in the combustion zone of a thermal vapor incinerator, as measured by the temperature monitoring device, is more than 28 °C (50 °F) below the design combustion zone temperature.

(B) Each 3-hour period of operation during which the average temperature of the gas stream immediately before the catalyst bed of a catalytic vapor incinerator, as measured by the temperature monitoring device, is more than 28 °C (50 °F) below the design gas stream temperature, and any 3-hour period during which the average temperature difference across the catalyst bed (i.e., the difference between the temperatures of the gas stream immediately before and after the catalyst bed), as measured by the temperature monitoring device, is less than 80 percent of the design temperature difference.

(C) Each 3-hour period of operation during which the average temperature of the gas stream in the combustion zone of a boiler or process heater having a design heat input capacity less than 44 MW (150 × 106 BTU/hr), as measured by the temperature monitoring device, is more than 28 °C (50 °F) below the design combustion zone temperature.

(D) Each 3-hour period of operation during which the average concentration of organics or the average concentration of benzene in the exhaust gases from a carbon adsorber, condenser, or other vapor recovery system is more than 20 percent greater than the design concentration level of organics or benzene in the exhaust gas.

(E) Each 3-hour period of operation during which the temperature of the condenser exhaust vent stream is more than 6 °C (11 °F) above the design average exhaust vent stream temperature, or the temperature of the coolant fluid exiting the condenser is more than 6 °C (11 °F) above the design average coolant fluid temperature at the condenser outlet.

(F) Each period in which the pilot flame of a flare is absent.

(G) Each occurrence when there is a change in the location at which the vent stream is introduced into the flame zone of a boiler or process heater as required by §61.349(a)(2)(i)(C) of this subpart.

(H) Each occurrence when the carbon in a carbon adsorber system that is regenerated directly on site in the control device is not regenerated at the predetermined carbon bed regeneration time.

(I) Each occurrence when the carbon in a carbon adsorber system that is not regenerated directly on site in the control device is not replaced at the predetermined interval specified in §61.354(c) of this subpart.

(J) Each 3-hour period of operation during which the parameters monitored are outside the range of values specified in §61.349(a)(2)(iv)(C), or any other periods specified by the Administrator for a control device subject to the requirements of §61.349(a)(2)(iv).

(v) For a cover and closed-vent system monitored in accordance with §61.354(g), the owner or operator shall submit a report quarterly to the Administrator that identifies any period in which the pressure in the waste management unit is equal to or greater than atmospheric pressure.

(8) Beginning one year after the date that the equipment necessary to comply with these standards has been certified in accordance with paragraph (d)(1) of this section, the owner or operator shall submit annually to the Administrator a report that summarizes all inspections required by §§61.342 through 61.354 during which detectable emissions are measured or a problem (such as a broken seal, gap or other problem) that could result in benzene emissions is identified, including information about the repairs or corrective action taken.

(e) An owner or operator electing to comply with the provisions of §§61.351 or 61.352 of this subpart shall notify the Administrator of the alternative standard selected in the report required under §61.07 or §61.10 of this part.

(f) An owner or operator who elects to install and operate the control equipment in §61.351 of this subpart shall comply with the reporting requirements in 40 CFR 60.115b.

(g) An owner or operator who elects to install and operate the control equipment in §61.352 of this subpart shall submit initial and quarterly reports that identify all seal gap measurements, as required in 40 CFR 60.693-2(a), that are outside the prescribed limits.

[55 FR 8346, Mar. 7, 1990; 55 FR 12444, Apr. 3, 1990, as amended at 55 FR 37231, Sept. 10, 1990; 58 FR 3105, Jan. 7, 1993; 65 FR 62161, Oct. 17, 2000]

[↑ Back to Top](#)

#### **§61.358 Delegation of authority.**

(a) In delegating implementation and enforcement authority to a State under section 112(d) of the Clean Air Act, the authorities contained in paragraph (b) of this section shall be retained by the Administrator and not transferred to a State.

(b) Alternative means of emission limitation under §61.353 of this subpart will not be delegated to States.

[↑ Back to Top](#)

#### **§61.359 [Reserved]**

[↑ Back to Top](#)

### **Appendix A to Part 61**



1. **Pollutant Emitted** - Indicate the type of hazardous pollutant emitted by the process. Indicate "AS" for asbestos, "BE" for beryllium, or "HG" for mercury.

32	33	Regulation		48	49
Pollutant				EC	

2. **Process Description** - Provide a brief description of each process (e.g., "hydrogen end box" in a mercury chlor-alkali plant, "grinding machine" in a beryllium machine shop). Use additional sheets if necessary.

50	Process Description		74	80
----	---------------------	--	----	----

Dup 1-18	6 1	21			50
	19	20			
51	79			80	
Dup 1-18	6 2	21			50
	19	20			
51	79			80	

3. **Amount of Pollutant** - Indicate the average weight of the hazardous material named in Item 1 which enters the process in pounds per month (based on the previous twelve months of operation).

Dup 1-18	6 3	21		27	29	36	80
	19	20			lbs./mo.		

4. **Control Devices**

- a. Indicate the type of pollution control devices, if any, used to reduce the emissions from the process (e.g., venturi scrubber, baghouse, wet cyclone) and the estimated percent of the pollutant which the device removes from the process gas stream.

Dup 1-18	6 4	PRIMARY CONTROL DEVICE:		43
	19	20	21	

45	Primary Device Name		64	66	70	72		79
				Percent Removal Efficiency				

80
----

[View or download PDF](#)

Dup 1-18	6 5	SECONDARY CONTROL DEVICES:			45				
	19	20	21						
47	Secondary Device Name		64	66	70	72		79	80
				Percent Removal Efficiency		% EFFIC.			

- b. **Asbestos Emission Control Devices Only**

1. If a baghouse is specified in Item 4a, give the following information:

- The air flow permeability in cubic feet per minute per square foot of fabric area.

Air flow permeability = \_\_\_\_\_ cfm/ft<sup>2</sup>

- The pressure drop in inches water gauge across the filter at which the baghouse is operated.

Operating pressure drop = \_\_\_\_\_ inches w.g.

- If the baghouse material contains synthetic fill yarn, check whether this material is / / spun / / or not spun.

- If the baghouse utilizes a felted fabric, give the minimum thickness in inches and the density in ounces per square yard.

Thickness = \_\_\_\_\_ inches    Density = \_\_\_\_\_ oz/yd<sup>2</sup>

11. If a wet collection device is specified in Item 4a, give the designed unit contacting energy in inches water gauge.

- Unit contacting energy = \_\_\_\_\_ inches w.g.

- C. **DISPOSAL OF ASBESTOS-CONTAINING WASTES.** Part C should be completed separately for each asbestos-containing waste generation operation arising from sources subject to §61.22(a), (c), (e), and (h).

Dup 1-13	14	16	0 0	5	SCC		27	28	29	30	31
								NEDS X Ref		CS	SIP
A B	32	33	Regulation		48	49					
Pollutant						EC					

[View or download PDF](#)

1. Waste Generation - Provide a brief description of each process that generates asbestos-containing waste (e.g. disposal of control device wastes).

50 \_\_\_\_\_ Process Description \_\_\_\_\_ 79 80

2. Asbestos Concentration - Indicate the average percentage asbestos content of these materials.

Dup 1-18 6 1 \_\_\_\_\_ ASBESTOS CONCENTRATION: \_\_\_\_\_ 43 45 \_\_\_\_\_ 48  
19 20 21

50 \_\_\_\_\_ 80

3. Amount of Wastes - Indicate the average weight of asbestos-containing wastes disposed of, measured in kg/day.

Dup 1-18 6 2 \_\_\_\_\_ kg/day \_\_\_\_\_ 34 80  
19 20 21 \_\_\_\_\_ 27 29

4. Control Methods - Indicate the emission control methods used in all stages of waste disposal, from collection, processing, and packaging to transporting and deposition.

Dup 1-18 6 3 \_\_\_\_\_ Primary Control Method \_\_\_\_\_ 43  
19 20 21

45 \_\_\_\_\_ 79 80

Dup 1-18 6 4 \_\_\_\_\_  
19 20 21 \_\_\_\_\_ 50

51 \_\_\_\_\_ 79 80

5. Waste Disposal - Indicate the type of disposal site (sanitary landfill, open, covered) or incineration site (municipal, private) where the waste is disposed of and who operates the site (company, private, municipal). State the name and location of the site (closest city or town, county, state).

Dup 1-18 6 5 \_\_\_\_\_ TYPE OF SITE: \_\_\_\_\_ 33 35 \_\_\_\_\_ 50  
19 20 21

51 \_\_\_\_\_ 79 80

[View or download PDF](#)

Dup 1-18 6 6 \_\_\_\_\_ OPERATOR: \_\_\_\_\_ 31 \_\_\_\_\_ 50  
19 20 21 \_\_\_\_\_ 29

51 \_\_\_\_\_ 79 80

Dup 1-18 6 7 \_\_\_\_\_ LOCATION: \_\_\_\_\_ 29  
19 20 21

31 \_\_\_\_\_ 70

71 \_\_\_\_\_ 79 80

D. WASTE DISPOSAL SITES. Part D should be completed separately for each asbestos waste disposal site subject to section 61.22(1).

Dup 1-13 14 16 17 18 19 20 5CC 27 28 29 30 31  
NECS X Ref CS SIP

A B  
32 33 34 Regulation 48 49  
Pollutant EC

50 \_\_\_\_\_ WASTE DISPOSAL SITE \_\_\_\_\_ 68 80

1. Description - Provide a brief description of the site, including its size and configuration, and the distance to the closest city or town, closest residence, and closest primary road.

Dup 1-18 6 1 \_\_\_\_\_ SITE DESCRIPTION \_\_\_\_\_ 37 39 \_\_\_\_\_ 50  
19 20 21

51 \_\_\_\_\_ 79 80

Dup 1-18 6 2 \_\_\_\_\_ DISTANCE: \_\_\_\_\_ TOWN: \_\_\_\_\_ K M \_\_\_\_\_ 43  
19 20 21 \_\_\_\_\_ 29 30 \_\_\_\_\_ 34 \_\_\_\_\_ 36 \_\_\_\_\_ 40 \_\_\_\_\_ 42

45 \_\_\_\_\_ RESIDENCE: \_\_\_\_\_ 54 56 \_\_\_\_\_ 60 62 63 K M \_\_\_\_\_ ROAD: \_\_\_\_\_ 65 \_\_\_\_\_ 69 71 \_\_\_\_\_ 75

77 \_\_\_\_\_ 78 80



[View or download PDF](#)

2. *Inactivation* - After the site is inactivated, indicate the method or methods used to comply with the standard and send a list of the actions that will be undertaken to maintain the inactivated site.

Dup 1-18	6 8	19 20	21	COMPLIANCE METHOD/INACTIVE SITE:	52
54			79	80	

[View or download PDF](#)

## II. Waiver Requests

A. *Waiver of Compliance*. Owners or operators of sources unable to operate in compliance with the National Emission Standards for Hazardous Air Pollutants prior to 90 days after the effective date of any standards or amendments which require the submission of such information may request a waiver of compliance from the Administrator of the U.S. Environmental Protection Agency for the time period necessary to install appropriate control devices or make modifications to achieve compliance. The Administrator may grant a waiver of compliance with the standard for a period not exceeding two years from the effective date of the hazardous pollutant standards, if he finds that such period is necessary for the installation of controls and that steps will be taken during the period of the waiver to assure that the health of persons will be protected from imminent endangerment.

The report information provided in Section I must accompany this application. Applications should be sent to the appropriate EPA regional office.

1. *Processes Involved*—Indicate the process or processes emitting hazardous pollutants to which emission controls are to be applied.

2. *Controls*

- a. Describe the proposed type of control device to be added or modification to be made to the process to reduce the emission of hazardous pollutants to an acceptable level. (Use additional sheets if necessary.)

- b. Describe the measures that will be taken during the waiver period to assure that the health of persons will be protected from imminent endangerment. (Use additional sheets if necessary.)

3. *Increments of Progress*—Specify the dates by which the following increments of progress will be met.

Date by which contracts for emission control systems or process modifications will be awarded; or date by which orders will be issued for the purchase of the component parts to accomplish emission control or process modification.

Dup 1-16    0 1 7  
 17 19 53 54 55 60 61 MO/DY/YR 66 80  
 Date of initiation of on-site construction or installation of  
 emission control equipment or process change.

Dup 1-16    0 2 7  
 17 19 53 54 55 60 61 MO/DY/YR 66 80  
 Date by which on-site construction or installation of emission control  
 equipment or process modification is to be completed.

Dup 1-16    0 3 7  
 17 19 53 54 55 60 61 MO/DY/YR 66 80  
 Date by which final compliance is to be achieved.

Dup 1-16    0 4 7  
 17 19 53 54 55 60 61 MO/DY/YR 66 80

[View or download PDF](#)

B. *Waiver of Emission Tests.* A waiver of emission testing may be granted to owners or operators of sources subject to emission testing if, in the judgment of the Administrator of the Environmental Protection Agency the emissions from the source comply with the appropriate standard or if the owners or operators of the source have requested a waiver of compliance or have been granted a waiver of compliance.

This application should accompany the report information provided in Section I.

1. *Reason*—State the reasons for requesting a waiver of emission testing. If the reason stated is that the emissions from the source are within the prescribed limits, documentation of this condition must be attached.

Date

Signature of the owner or operator

(Sec. 114, of the Clean Air Act as amended (42 U.S.C. 7414))

[40 FR 48303, Oct. 14, 1975, as amended at 43 FR 8800, Mar. 3, 1978; 50 FR 46295, Sept. 9, 1985]

[↑ Back to Top](#)

### Appendix B to Part 61—Test Methods

Method 101—Determination of particulate and gaseous mercury emissions from chlor-alkali plants (air streams)

Method 101A—Determination of particulate and gaseous mercury emissions from sewage sludge incinerators

Method 102—Determination of particulate and gaseous mercury emissions from chlor-alkali plants (hydrogen streams)

Method 103—Beryllium screening method

Method 104—Determination of beryllium emissions from stationary sources

Method 105—Determination of mercury in wastewater treatment plant sewage sludges

Method 106—Determination of vinyl chloride emissions from stationary sources

Method 107—Determination of vinyl chloride content of in-process wastewater samples, and vinyl chloride content of polyvinyl chloride resin slurry, wet cake, and latex samples

Method 107A—Determination of vinyl chloride content of solvents, resin-solvent solution, polyvinyl chloride resin, resin slurry, wet resin, and latex samples

Method 108—Determination of particulate and gaseous arsenic emissions

Method 108A—Determination of arsenic content in ore samples from nonferrous smelters

Method 108B—Determination of arsenic content in ore samples from nonferrous smelters

Method 108C—Determination of arsenic content in ore samples from nonferrous smelters (molybdenum blue photometric procedure)

Method 111—Determination of Polonium—210 emissions from stationary sources

Method 101—Determination of Particulate and Gaseous Mercury Emissions From Chlor-Alkali Plants (Air Streams)

Note: This method does not include all of the specifications (*e.g.*, equipment and supplies) and procedures (*e.g.*, sampling and analytical) essential to its performance. Some material is incorporated by reference from methods in appendix A to 40 CFR part 60. Therefore, to obtain reliable results, persons using this method should have a thorough knowledge of at least the following additional test methods: Method 1, Method 2, Method 3, and Method 5.

### 1.0 Scope and Application

#### 1.1 Analytes.

Analyte	CAS No.	Sensitivity
Mercury (Hg)	7439-97-6	Dependent upon recorder and spectrophotometer.

1.2 Applicability. This method is applicable for the determination of Hg emissions, including both particulate and gaseous Hg, from chlor-alkali plants and other sources (as specified in the regulations) where the carrier-gas stream in the duct or stack is principally air.

1.3 Data Quality Objectives. Adherence to the requirements of this method will enhance the quality of the data obtained from air pollutant sampling methods.

## 2.0 *Summary of Method*

Particulate and gaseous Hg emissions are withdrawn isokinetically from the source and collected in acidic iodine monochloride (ICl) solution. The Hg collected (in the mercuric form) is reduced to elemental Hg, which is then aerated from the solution into an optical cell and measured by atomic absorption spectrophotometry.

## 3.0 *Definitions [Reserved]*

## 4.0 *Interferences*

4.1 Sample Collection. Sulfur dioxide (SO<sub>2</sub>) reduces ICl and causes premature depletion of the ICl solution.

4.2 Sample Analysis.

4.2.1 ICl concentrations greater than 10<sup>-4</sup> molar inhibit the reduction of the Hg (II) ion in the aeration cell.

4.2.2 Condensation of water vapor on the optical cell windows causes a positive interference.

## 5.0 *Safety*

5.1 Disclaimer. This method may involve hazardous materials, operations, and equipment. This test method does not purport to address all of the safety problems associated with its use. It is the responsibility of the user of this test method to establish appropriate safety and health practices and determine the applicability of regulatory limitations prior to performing this test method.

5.2 Corrosive Reagents. The following reagents are hazardous. Personal protective equipment and safe procedures are useful in preventing chemical splashes. If contact occurs, immediately flush with copious amounts of water for at least 15 minutes. Remove clothing under shower and decontaminate. Treat residual chemical burn as thermal burn.

5.2.1 Hydrochloric Acid (HCl). Highly toxic and corrosive. Causes severe damage to tissues. Vapors are highly irritating to eyes, skin, nose, and lungs, causing severe damage. May cause bronchitis, pneumonia, or edema of lungs. Exposure to concentrations of 0.13 to 0.2 percent can be lethal to humans in a few minutes. Provide ventilation to limit exposure. Reacts with metals, producing hydrogen gas.

5.2.2 Nitric Acid (HNO<sub>3</sub>). Highly corrosive to eyes, skin, nose, and lungs. Vapors cause bronchitis, pneumonia, or edema of lungs. Reaction to inhalation may be delayed as long as 30 hours and still be fatal. Provide ventilation to limit exposure. Strong oxidizer. Hazardous reaction may occur with organic materials such as solvents.

5.2.3 Sulfuric Acid (H<sub>2</sub>SO<sub>4</sub>). Rapidly destructive to body tissue. Will cause third degree burns. Eye damage may result in blindness. Inhalation may be fatal from spasm of the larynx, usually within 30 minutes. 3 mg/m<sup>3</sup> will cause lung damage. 1 mg/m<sup>3</sup> for 8 hours will cause lung damage or, in higher concentrations, death. Provide ventilation to limit inhalation. Reacts violently with metals and organics.

## 6.0 *Equipment and Supplies.*

6.1 Sample Collection. A schematic of the sampling train used in performing this method is shown in Figure 101-1; it is similar to the Method 5 sampling train. The following items are required for sample collection:

6.1.1 Probe Nozzle, Pitot Tube, Differential Pressure Gauge, Metering System, Barometer, and Gas Density Determination Equipment. Same as Method 5, Sections 6.1.1.1, 6.1.1.3, 6.1.1.4, 6.1.1.9, 6.1.2, and 6.1.3, respectively.

6.1.2 Probe Liner. Borosilicate or quartz glass tubing. A heating system capable of maintaining a gas temperature of  $120 \pm 14$  °C ( $248 \pm 25$  °F) at the probe exit during sampling may be used to prevent water condensation.

Note: Do not use metal probe liners.

6.1.3 Impingers. Four Greenburg-Smith impingers connected in series with leak-free ground glass fittings or any similar leak-free noncontaminating fittings. For the first, third, and fourth impingers, impingers that are modified by replacing the tip with a 13-mm ID (0.5-in.) glass tube extending to 13 mm (0.5 in.) from the bottom of the flask may be used.

6.1.4 Acid Trap. Mine Safety Appliances air line filter, Catalog number 81857, with acid absorbing cartridge and suitable connections, or equivalent.

6.2 Sample Recovery. The following items are needed for sample recovery:

6.2.1 Glass Sample Bottles. Leakless, with Teflon-lined caps, 1000- and 100-ml.

6.2.2 Graduated Cylinder. 250-ml.

6.2.3 Funnel and Rubber Policeman. To aid in transfer of silica gel to container; not necessary if silica gel is weighed in the field.

6.2.4 Funnel. Glass, to aid in sample recovery.

6.3 Sample Preparation and Analysis. The following items are needed for sample preparation and analysis:

6.3.1 Atomic Absorption Spectrophotometer. Perkin-Elmer 303, or equivalent, containing a hollow-cathode mercury lamp and the optical cell described in Section 6.3.2.

6.3.2 Optical Cell. Cylindrical shape with quartz end windows and having the dimensions shown in Figure 101-2. Wind the cell with approximately 2 meters (6 ft) of 24-gauge Nichrome wire, or equivalent, and wrap with fiberglass insulation tape, or equivalent; do not let the wires touch each other.

6.3.3 Aeration Cell. Constructed according to the specifications in Figure 101-3. Do not use a glass frit as a substitute for the blown glass bubbler tip shown in Figure 101-3.

6.3.4 Recorder. Matched to output of the spectrophotometer described in Section 6.3.1.

6.3.5 Variable Transformer. To vary the voltage on the optical cell from 0 to 40 volts.

6.3.6 Hood. For venting optical cell exhaust.

6.3.7 Flow Metering Valve.

6.3.8 Rate Meter. Rotameter, or equivalent, capable of measuring to within 2 percent a gas flow of 1.5 liters/min (0.053 cfm).

6.3.9 Aeration Gas Cylinder. Nitrogen or dry, Hg-free air, equipped with a single-stage regulator.

6.3.10 Tubing. For making connections. Use glass tubing (ungreased ball and socket connections are recommended) for all tubing connections between the solution cell and the optical cell; do not use Tygon tubing, other types of flexible tubing, or metal tubing as substitutes. Teflon, steel, or copper tubing may be used between the nitrogen tank and flow metering valve (Section 6.3.7), and Tygon, gum, or rubber tubing between the flow metering valve and the aeration cell.

6.3.11 Flow Rate Calibration Equipment. Bubble flow meter or wet-test meter for measuring a gas flow rate of  $1.5 \pm 0.1$  liters/min ( $0.053 \pm 0.0035$  cfm).

6.3.12 Volumetric Flasks. Class A with penny head standard taper stoppers; 100-, 250-, 500-, and 1000-ml.

6.3.13 Volumetric Pipets. Class A; 1-, 2-, 3-, 4-, and 5-ml.

6.3.14 Graduated Cylinder. 50-ml.

6.3.15 Magnetic Stirrer. General-purpose laboratory type.

6.3.16 Magnetic Stirring Bar. Teflon-coated.

6.3.17 Balance. Capable of weighing to  $\pm 0.5$  g.

6.3.18 Alternative Analytical Apparatus. Alternative systems are allowable as long as they meet the following criteria:

6.3.18.1 A linear calibration curve is generated and two consecutive samples of the same aliquot size and concentration agree within 3 percent of their average.

6.3.18.2 A minimum of 95 percent of the spike is recovered when an aliquot of a source sample is spiked with a known concentration of Hg (II) compound.

6.3.18.3 The reducing agent should be added after the aeration cell is closed.

6.3.18.4 The aeration bottle bubbler should not contain a frit.

6.3.18.5 Any Tygon tubing used should be as short as possible and conditioned prior to use until blanks and standards yield linear and reproducible results.

6.3.18.6 If manual stirring is done before aeration, it should be done with the aeration cell closed.

6.3.18.7 A drying tube should not be used unless it is conditioned as the Tygon tubing above.

## 7.0 Reagents and Standards

Unless otherwise indicated, all reagents must conform to the specifications established by the Committee on Analytical Reagents of the American Chemical Society; where such specifications are not available, use the best available grade.

7.1 Sample Collection. The following reagents are required for sample collection:

7.1.1 Water. Deionized distilled, to conform to ASTM D 1193-77 or 91 (incorporated by reference—see §61.18), Type 1. If high concentrations of organic matter are not expected to be present, the analyst may eliminate the  $\text{KMnO}_4$  test for oxidizable organic matter. Use this water in all dilutions and solution preparations.

7.1.2 Nitric Acid, 50 Percent (v/v). Mix equal volumes of concentrated  $\text{HNO}_3$  and water, being careful to add the acid to the water slowly.

7.1.3 Silica Gel. Indicating type, 6- to 16-mesh. If previously used, dry at  $175\text{ }^\circ\text{C}$  ( $350\text{ }^\circ\text{F}$ ) for 2 hours. The tester may use new silica gel as received.

7.1.4 Potassium Iodide (KI) Solution, 25 Percent. Dissolve 250 g of KI in water, and dilute to 1 liter.

7.1.5 Iodine Monochloride Stock Solution, 1.0 M. To 800 ml of 25 percent KI solution, add 800 ml of concentrated HCl. Cool to room temperature. With vigorous stirring, slowly add 135 g of potassium iodate ( $\text{KIO}_3$ ), and stir until all free iodine has dissolved. A clear orange-red solution occurs when all the  $\text{KIO}_3$  has been added. Cool to room temperature, and dilute to 1800 ml with water. Keep the solution in amber glass bottles to prevent degradation.

7.1.6 Absorbing Solution, 0.1 M ICl. Dilute 100 ml of the 1.0 M ICl stock solution to 1 liter with water. Keep the solution in amber glass bottles and in darkness to prevent degradation. This reagent is stable for at least two months.

7.2 Sample Preparation and Analysis. The following reagents and standards are required for sample preparation and analysis:

7.2.1 Reagents.

7.2.1.1 Tin (II) Solution. Prepare fresh daily, and keep sealed when not being used. Completely dissolve 20 g of tin (II) chloride (or 25 g of tin (II) sulfate) crystals (Baker Analyzed reagent grade or any other brand that will give a clear solution) in 25 ml of concentrated HCl. Dilute to 250 ml with water. Do not substitute  $\text{HNO}_3$ ,  $\text{H}_2\text{SO}_4$ , or other strong acids for the HCl.

7.2.1.2 Sulfuric Acid, 5 Percent (v/v). Dilute 25 ml of concentrated  $\text{H}_2\text{SO}_4$  to 500 ml with water.

7.2.2 Standards

7.2.2.1 Hg Stock Solution, 1 mg Hg/ml. Prepare and store all Hg standard solutions in borosilicate glass containers. Completely dissolve 0.1354 g of Hg (II) chloride in 75 ml of water in a 100-ml glass volumetric flask. Add 10 ml of concentrated  $\text{HNO}_3$ , and adjust the volume to exactly 100 ml with water. Mix thoroughly. This solution is stable for at least one month.

7.2.2.2 Intermediate Hg Standard Solution, 10 µg Hg/ml. Prepare fresh weekly. Pipet 5.0 ml of the Hg stock solution (Section 7.2.2.1) into a 500-ml glass volumetric flask, and add 20 ml of the 5 percent H<sub>2</sub>SO<sub>4</sub> solution. Dilute to exactly 500 ml with water. Thoroughly mix the solution.

7.2.2.3 Working Hg Standard Solution, 200 ng Hg/ml. Prepare fresh daily. Pipet 5.0 ml of the intermediate Hg standard solution (Section 7.2.2.2) into a 250-ml volumetric glass flask. Add 10 ml of the 5 percent H<sub>2</sub>SO<sub>4</sub> and 2 ml of the 0.1 M ICl absorbing solution taken as a blank (Section 8.7.4.3), and dilute to 250 ml with water. Mix thoroughly.

## 8.0 Sample Collection, Preservation, Transport, and Storage

Because of the complexity of this method, testers should be trained and experienced with the test procedures to ensure reliable results. Since the amount of Hg that is collected generally is small, the method must be carefully applied to prevent contamination or loss of sample.

8.1 Pretest Preparation. Follow the general procedure outlined in Method 5, Section 8.1, except omit Sections 8.1.2 and 8.1.3.

8.2 Preliminary Determinations. Follow the general procedure outlined in Method 5, Section 8.2, with the exception of the following:

8.2.1 Select a nozzle size based on the range of velocity heads to assure that it is not necessary to change the nozzle size in order to maintain isokinetic sampling rates below 28 liters/min (1.0 cfm).

8.2.2 Perform test runs such that samples are obtained over a period or periods that accurately determine the maximum emissions that occur in a 24-hour period. In the case of cyclic operations, run sufficient tests for the accurate determination of the emissions that occur over the duration of the cycle. A minimum sample time of 2 hours is recommended. In some instances, high Hg or high SO<sub>2</sub> concentrations make it impossible to sample for the desired minimum time. This is indicated by reddening (liberation of free iodine) in the first impinger. In these cases, the sample run may be divided into two or more subruns to ensure that the absorbing solution is not depleted.

## 8.3 Preparation of Sampling Train.

8.3.1 Clean all glassware (probe, impingers, and connectors) by rinsing with 50 percent HNO<sub>3</sub>, tap water, 0.1 M ICl, tap water, and finally deionized distilled water. Place 100 ml of 0.1 M ICl in each of the first three impingers. Take care to prevent the absorbing solution from contacting any greased surfaces. Place approximately 200 g of preweighed silica gel in the fourth impinger. More silica gel may be used, but care should be taken to ensure that it is not entrained and carried out from the impinger during sampling. Place the silica gel container in a clean place for later use in the sample recovery. Alternatively, determine and record the weight of the silica gel plus impinger to the nearest 0.5 g.

8.3.2 Install the selected nozzle using a Viton A O-ring when stack temperatures are less than 260 °C (500 °F). Use a fiberglass string gasket if temperatures are higher. See APTD-0576 (Reference 3 in Method 5) for details. Other connecting systems using either 316 stainless steel or Teflon ferrules may be used. Mark the probe with heat-resistant tape or by some other method to denote the proper distance into the stack or duct for each sampling point.



8.3.3 Assemble the train as shown in Figure 101-1, using (if necessary) a very light coat of silicone grease on all ground glass joints. Grease only the outer portion (see APTD-0576) to avoid the possibility of contamination by the silicone grease.

Note: An empty impinger may be inserted between the third impinger and the silica gel to remove excess moisture from the sample stream.

8.3.4 After the sampling train has been assembled, turn on and set the probe heating system, if applicable, at the desired operating temperature. Allow time for the temperatures to stabilize. Place crushed ice around the impingers.

8.4 Leak-Check Procedures. Follow the leak-check procedures outlined in Method 5, Section 8.4.

8.5 Sampling Train Operation. Follow the general procedure outlined in Method 5, Section 8.5. For each run, record the data required on a data sheet such as the one shown in Figure 101-4.

8.6 Calculation of Percent Isokinetic. Same as Method 5, Section 8.6.

8.7 Sample Recovery. Begin proper cleanup procedure as soon as the probe is removed from the stack at the end of the sampling period.

8.7.1 Allow the probe to cool. When it can be safely handled, wipe off any external particulate matter near the tip of the probe nozzle, and place a cap over it. Do not cap off the probe tip tightly while the sampling train is cooling. Capping would create a vacuum and draw liquid out from the impingers.

8.7.2 Before moving the sampling train to the cleanup site, remove the probe from the train, wipe off the silicone grease, and cap the open outlet of the probe. Be careful not to lose any condensate that might be present. Wipe off the silicone grease from the impinger. Use either ground-glass stoppers, plastic caps, or serum caps to close these openings.

8.7.3 Transfer the probe and impinger assembly to a cleanup area that is clean, protected from the wind, and free of Hg contamination. The ambient air in laboratories located in the immediate vicinity of Hg-using facilities is not normally free of Hg contamination.

8.7.4 Inspect the train before and during disassembly, and note any abnormal conditions. Treat the samples as follows.

8.7.4.1 Container No. 1 (Impingers and Probe).

8.7.4.1.1 Using a graduated cylinder, measure the liquid in the first three impingers to within 1 ml. Record the volume of liquid present (*e.g.*, see Figure 5-6 of Method 5). This information is needed to calculate the moisture content of the effluent gas. (Use only glass storage bottles and graduated cylinders that have been precleaned as in Section 8.3.1) Place the contents of the first three impingers into a 1000-ml glass sample bottle.

8.7.4.1.2 Taking care that dust on the outside of the probe or other exterior surfaces does not get into the sample, quantitatively recover the Hg (and any condensate) from the probe nozzle, probe fitting, and probe liner as follows: Rinse these components with two 50-ml portions of 0.1 M ICl. Next, rinse the

probe nozzle, fitting and liner, and each piece of connecting glassware between the probe liner and the back half of the third impinger with a maximum of 400 ml of water. Add all washings to the 1000-ml glass sample bottle containing the liquid from the first three impingers.

8.7.4.1.3 After all washings have been collected in the sample container, tighten the lid on the container to prevent leakage during shipment to the laboratory. Mark the height of the liquid to determine later whether leakage occurred during transport. Label the container to identify clearly its contents.

8.7.4.2 Container No. 2 (Silica Gel). Same as Method 5, Section 8.7.6.3.

8.7.4.3 Container No. 3 (Absorbing Solution Blank). Place 50 ml of the 0.1 M ICl absorbing solution in a 100-ml sample bottle. Seal the container. Use this blank to prepare the working Hg standard solution (Section 7.2.2.3).

## 9.0 *Quality Control*

### 9.1 Miscellaneous Quality Control Measures.

Section	Quality control measure	Effect
8.4 10.2	Sampling equipment leak-checks and calibration	Ensure accuracy and precision of sampling measurements.
10.5, 10.6	Spectrophotometer calibration	Ensure linearity of spectrophotometer response to standards.
11.3.3	Check for matrix effects	Eliminate matrix effects.

9.2 Volume Metering System Checks. Same as Method 5, Section 9.2.

## 10.0 *Calibration and Standardizations*

Note: Maintain a laboratory log of all calibrations.

10.1 Before use, clean all glassware, both new and used, as follows: brush with soap and tap water, liberally rinse with tap water, soak for 1 hour in 50 percent HNO<sub>3</sub>, and then rinse with deionized distilled water.

10.2 Sampling Equipment. Calibrate the sampling equipment according to the procedures outlined in the following sections of Method 5: Section 10.1 (Probe Nozzle), Section 10.2 (Pitot Tube Assembly), Section 10.3 (Metering System), Section 10.5 (Temperature Sensors), Section 10.6 (Barometer).

10.3 Aeration System Flow Rate Meter. Assemble the aeration system as shown in Figure 101-5. Set the outlet pressure on the aeration gas cylinder regulator to a minimum pressure of 500 mm Hg (10 psi), and use the flow metering valve and a bubble flowmeter or wet-test meter to obtain a flow rate of 1.5 ±0.1 liters/min (0.053 ±0.0035 cfm) through the aeration cell. After the calibration of the aeration system flow rate meter is complete, remove the bubble flowmeter from the system.

10.4 Optical Cell Heating System. Using a 50-ml graduated cylinder, add 50 ml of water to the bottle section of the aeration cell, and attach the bottle section to the bubbler section of the cell. Attach the aeration cell to the optical cell and while aerating at  $1.5 \pm 0.1$  liters/min ( $0.053 \pm 0.0035$  cfm), determine the minimum variable transformer setting necessary to prevent condensation of moisture in the optical cell and in the connecting tubing. (This setting should not exceed 20 volts.)

10.5 Spectrophotometer and Recorder.

10.5.1 The Hg response may be measured by either peak height or peak area.

Note: The temperature of the solution affects the rate at which elemental Hg is released from a solution and, consequently, it affects the shape of the absorption curve (area) and the point of maximum absorbance (peak height). Therefore, to obtain reproducible results, bring all solutions to room temperature before use.

10.5.2 Set the spectrophotometer wavelength at 253.7 nm, and make certain the optical cell is at the minimum temperature that will prevent water condensation. Then set the recorder scale as follows: Using a 50-ml graduated cylinder, add 50 ml of water to the aeration cell bottle. Add three drops of Antifoam B to the bottle, and then pipet 5.0 ml of the working Hg standard solution into the aeration cell.

Note: Always add the Hg-containing solution to the aeration cell after the 50 ml of water.

10.5.3 Place a Teflon-coated stirring bar in the bottle. Before attaching the bottle section to the bubbler section of the aeration cell, make certain that (1) the aeration cell exit arm stopcock (Figure 101-3) is closed (so that Hg will not prematurely enter the optical cell when the reducing agent is being added) and (2) there is no flow through the bubbler. If conditions (1) and (2) are met, attach the bottle section to the bubbler section of the aeration cell. Pipet 5 ml of tin (II) reducing solution into the aeration cell through the side arm, and immediately stopper the side arm. Stir the solution for 15 seconds, turn on the recorder, open the aeration cell exit arm stopcock, and immediately initiate aeration with continued stirring. Determine the maximum absorbance of the standard, and set this value to read 90 percent of the recorder full scale.

10.6 Calibration Curve.

10.6.1 After setting the recorder scale, repeat the procedure in Section 10.5 using 0.0-, 1.0-, 2.0-, 3.0-, 4.0-, and 5.0-ml aliquots of the working standard solution (final amount of Hg in the aeration cell is 0, 200, 400, 600, 800, and 1000 ng, respectively). Repeat this procedure on each aliquot size until two consecutive peaks agree within 3 percent of their average value.

Note: To prevent Hg carryover from one sample to another, do not close the aeration cell from the optical cell until the recorder pen has returned to the baseline.)

10.6.2 It should not be necessary to disconnect the aeration gas inlet line from the aeration cell when changing samples. After separating the bottle and bubbler sections of the aeration cell, place the bubbler section into a 600-ml beaker containing approximately 400 ml of water. Rinse the bottle section of the aeration cell with a stream of water to remove all traces of the tin (II) reducing agent. Also, to prevent the loss of Hg before aeration, remove all traces of the reducing agent between samples by washing with

water. It will be necessary, however, to wash the aeration cell parts with concentrated HCl if any of the following conditions occur: (1) A white film appears on any inside surface of the aeration cell, (2) the calibration curve changes suddenly, or (3) the replicate samples do not yield reproducible results.

10.6.3 Subtract the average peak height (or peak area) of the blank (0.0-ml aliquot)—which must be less than 2 percent of recorder full scale—from the averaged peak heights of the 1.0-, 2.0-, 3.0-, 4.0-, and 5.0-ml aliquot standards. If the blank absorbance is greater than 2 percent of full-scale, the probable cause is Hg contamination of a reagent or carry-over of Hg from a previous sample. Prepare the calibration curve by plotting the corrected peak height of each standard solution versus the corresponding final total Hg weight in the aeration cell (in ng), and draw the best fit straight line. This line should either pass through the origin or pass through a point no further from the origin than  $\pm 2$  percent of the recorder full scale. If the line does not pass through or very near to the origin, check for nonlinearity of the curve and for incorrectly prepared standards.

### *11.0 Analytical Procedure*

11.1 Sample Loss Check. Check the liquid level in each container to see whether liquid was lost during transport. If a noticeable amount of leakage occurred, either void the sample or use methods subject to the approval of the Administrator to account for the losses.

11.2 Sample Preparation. Treat each sample as follows:

11.2.1 Container No. 1 (Impingers and Probe). Carefully transfer the contents of Container No. 1 into a 1000-ml volumetric flask, and adjust the volume to exactly 1000 ml with water.

11.2.2 Dilutions. Pipet a 2-ml aliquot from the diluted sample from Section 11.2.1 into a 250-ml volumetric flask. Add 10 ml of 5 percent  $\text{H}_2\text{SO}_4$ , and adjust the volume to exactly 250 ml with water. This solution is stable for at least 72 hours.

Note: The dilution factor will be 250/2 for this solution.

11.3 Analysis. Calibrate the analytical equipment and develop a calibration curve as outlined in Sections 10.3 through 10.6.

11.3.1 Mercury Samples. Repeat the procedure used to establish the calibration curve with an appropriately sized aliquot (1 to 5 ml) of the diluted sample (from Section 11.2.2) until two consecutive peak heights agree within 3 percent of their average value. The peak maximum of an aliquot (except the 5-ml aliquot) must be greater than 10 percent of the recorder full scale. If the peak maximum of a 1.0-ml aliquot is off scale on the recorder, further dilute the original source sample to bring the Hg concentration into the calibration range of the spectrophotometer.

11.3.2 Run a blank and standard at least after every five samples to check the spectrophotometer calibration. The peak height of the blank must pass through a point no further from the origin than  $\pm 2$  percent of the recorder full scale. The difference between the measured concentration of the standard (the product of the corrected peak height and the reciprocal of the least squares slope) and the actual concentration of the standard must be less than 7 percent, or recalibration of the analyzer is required.

11.3.3 Check for Matrix Effects (optional). Use the Method of Standard Additions as follows to check at least one sample from each source for matrix effects on the Hg results. The Method of Standard Additions procedures described on pages 9-4 and 9-5 of the section entitled “General Information” of the Perkin Elmer Corporation Atomic Absorption Spectrophotometry Manual, Number 303-0152 (Reference 16 in Section 16.0) are recommended. If the results of the Method of Standard Additions procedure used on the single source sample do not agree to within  $\pm 5$  percent of the value obtained by the routine atomic absorption analysis, then reanalyze all samples from the source using the Method of Standard Additions procedure.

11.4 Container No. 2 (Silica Gel). Weigh the spent silica gel (or silica gel plus impinger) to the nearest 0.5 g using a balance. (This step may be conducted in the field.)

### 12.0 Data Analysis and Calculations

Carry out calculations, retaining at least one extra decimal significant figure beyond that of the acquired data. Round off figures only after the final calculation. Other forms of the equations may be used as long as they give equivalent results.

12.1 Average Dry Gas Meter Temperature and Average Orifice Pressure Drop, Dry Gas Volume, Volume of Water Vapor Condensed, Moisture Content, and Isokinetic Variation. Same as Method 5, Sections 12.2 through 12.5 and 12.11, respectively.

12.2 Stack Gas Velocity. Using the data from this test and Equation 2-9 of Method 2, calculate the average stack gas velocity  $v_s$ .

12.3 Total Mercury.

12.3.1 For each source sample, correct the average maximum absorbance of the two consecutive samples whose peak heights agree within 3 percent of their average for the contribution of the solution blank (see Section 10.6.3). Use the calibration curve and these corrected averages to determine the final total weight of Hg in ng in the aeration cell for each source sample.

12.3.2 Correct for any dilutions made to bring the sample into the working range of the spectrophotometer. Then calculate the Hg in the original solution,  $m_{\text{Hg}}$ , as follows:

$$m_{\text{Hg}} = [C_{\text{Hg(AC)}}(DF)(V_f)(10^{-3})]/S \quad \text{Eq. 101-1}$$

[View or download PDF](#)

Where:

$C_{\text{Hg(AC)}}$  = Total ng of Hg in aliquot analyzed (reagent blank subtracted).

DF = Dilution factor for the Hg-containing solution (before adding to the aeration cell; e.g., DF = 250/2 if the source samples were diluted as described in Section 11.2.2).

$V_f$  = Solution volume of original sample, 1000 ml for samples diluted as described in Section 11.2.1.

$10^{-3}$  = Conversion factor,  $\mu\text{g}/\text{ng}$ .

S = Aliquot volume added to aeration cell, ml.

12.4 Mercury Emission Rate. Calculate the daily Hg emission rate, R, using Equation 101-2. For continuous operations, the operating time is equal to 86,400 seconds per day. For cyclic operations, use only the time per day each stack is in operation. The total Hg emission rate from a source will be the summation of results from all stacks.

$$R = \frac{K_{m_{Hg}} V_s A_s (86,400 \times 10^{-6})}{[V_{m(std)} + V_{w(std)}] (T_s / P_s)} \quad \text{Eq. 101-2}$$

[View or download PDF](#)

Where:

$K_1 = 0.3858$  °K/mm Hg for metric units.

$K_1 = 17.64$  °R/in. Hg for English units.

$K_3 = 10^{-6}$  g/μg for metric units.

= 2.2046 “ × 10<sup>-9</sup> lb/μg for English units.

$P_s$  = Absolute stack gas pressure, mm Hg (in. Hg).

t = Daily operating time, sec/day.

$T_s$  = Absolute average stack gas temperature, °K (°R).

$V_{m(std)}$  = Dry gas sample volume at standard conditions, scm (scf).

$V_{w(std)}$  = Volume of water vapor at standard conditions, scm (scf).

12.5 Determination of Compliance. Each performance test consists of three repetitions of the applicable test method. For the purpose of determining compliance with an applicable national emission standard, use the average of the results of all repetitions.

### 13.0 Method Performance

The following estimates are based on collaborative tests, wherein 13 laboratories performed duplicate analyses on two Hg-containing samples from a chlor-alkali plant and on one laboratory-prepared sample of known Hg concentration. The sample concentrations ranged from 2 to 65 μg Hg/ml.

13.1 Precision. The estimated intra-laboratory and inter-laboratory standard deviations are 1.6 and 1.8 μg Hg/ml, respectively.

13.2 Accuracy. The participating laboratories that analyzed a 64.3 μg Hg/ml (in 0.1 M ICl) standard obtained a mean of 63.7 μg Hg/ml.

13.3 Analytical Range. After initial dilution, the range of this method is 0.5 to 120 μg Hg/ml. The upper limit can be extended by further dilution of the sample.

14.0 *Pollution Prevention. [Reserved]*

15.0 *Waste Management. [Reserved]*

16.0 *Alternative Procedures*

16.1 Alternative Analyzer. Samples may also be analyzed by cold vapor atomic fluorescence spectrometry.

17.0 *References*

Same as Method 5, Section 17.0, References 1-3, 5, and 6, with the addition of the following:

1. Determining Dust Concentration in a Gas Stream. ASME Performance Test Code No. 27. New York, NY. 1957.
2. DeVorkin, Howard, *et al.* Air Pollution Source Testing Manual. Air Pollution Control District. Los Angeles, CA. November 1963.
3. Hatch, W.R., and W.I. Ott. Determination of Sub-Microgram Quantities of Mercury by Atomic Absorption Spectrophotometry. *Anal. Chem.* 40:2085-87. 1968.
4. Mark, L.S. Mechanical Engineers' Handbook. McGraw-Hill Book Co., Inc. New York, NY. 1951.
5. Western Precipitation Division of Joy Manufacturing Co. Methods for Determination of Velocity, Volume, Dust and Mist Content of Gases. Bulletin WP-50. Los Angeles, CA. 1968.
6. Perry, J.H. Chemical Engineers' Handbook. McGraw-Hill Book Co., Inc. New York, NY. 1960.
7. Shigehara, R.T., W.F. Todd, and W.S. Smith. Significance of Errors in Stack Sampling Measurements. *Stack Sampling News.* 1(3):6-18. September 1973.
8. Smith, W.S., R.T. Shigehara, and W.F. Todd. A Method of Interpreting Stack Sampling Data. *Stack Sampling News.* 1(2):8-17. August 1973.
9. Standard Method for Sampling Stacks for Particulate Matter. In: 1971 Annual Book of ASTM Standards, Part 23. ASTM Designation D 2928-71. Philadelphia, PA 1971.
10. Vennard, J.K. Elementary Fluid Mechanics. John Wiley and Sons, Inc. New York. 1947.
11. Mitchell, W.J. and M.R. Midgett. Improved Procedure for Determining Mercury Emissions from Mercury Cell Chlor-Alkali Plants. *J. APCA.* 26:674-677. July 1976.
12. Shigehara, R.T. Adjustments in the EPA Nomograph for Different Pitot Tube Coefficients and Dry Molecular Weights. *Stack Sampling News.* 2:4-11. October 1974.
13. Vollaro, R.F. Recommended Procedure for Sample Traverses in Ducts Smaller than 12 Inches in Diameter. U.S. Environmental Protection Agency, Emission Measurement Branch. Research Triangle Park, NC. November 1976.

14. Klein, R. and C. Hach. Standard Additions: Uses and Limitation in Spectrophotometric Measurements. Amer. Lab. 9:21. 1977.

15. Perkin Elmer Corporation. Analytical Methods for Atomic Absorption Spectrophotometry. Norwalk, Connecticut. September 1976.

18.0 Tables, Diagrams, Flowcharts, and Validation Data

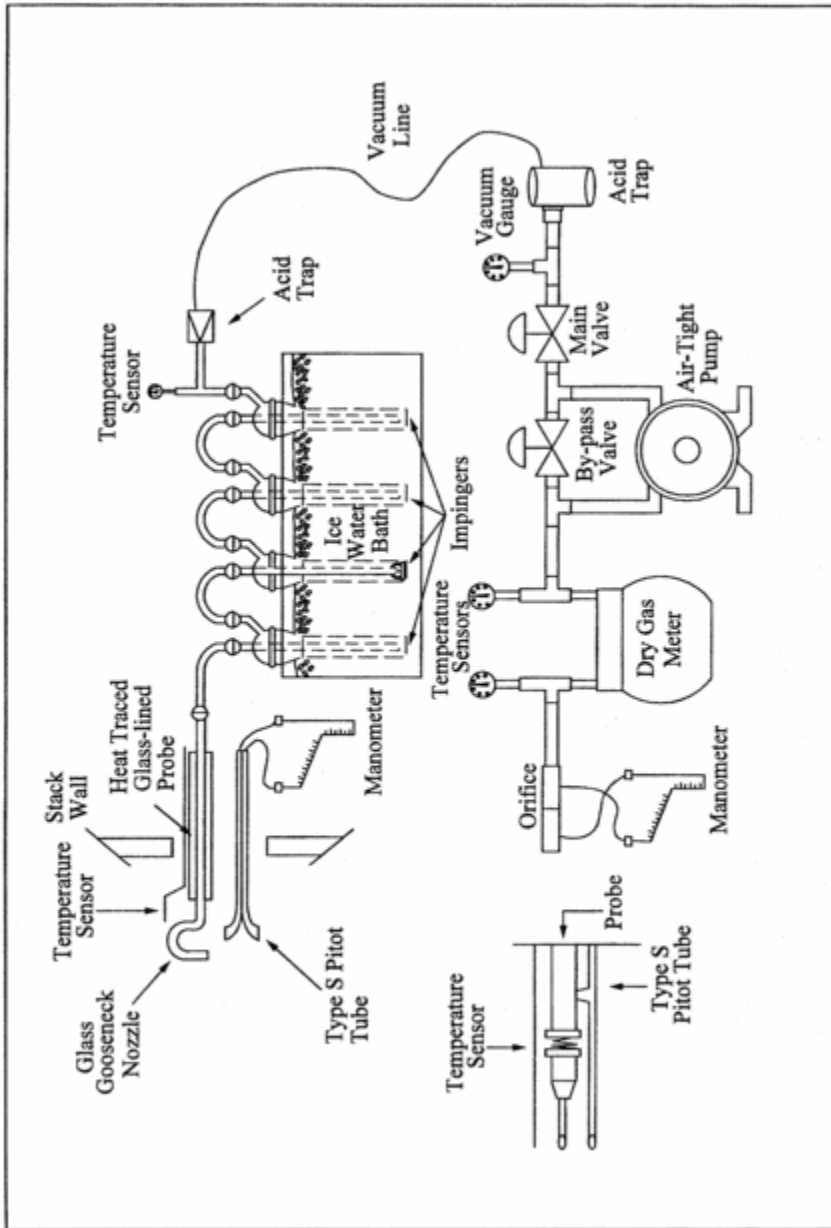

Figure 101-1. Mercury Sampling Train.

[View or download PDF](#)



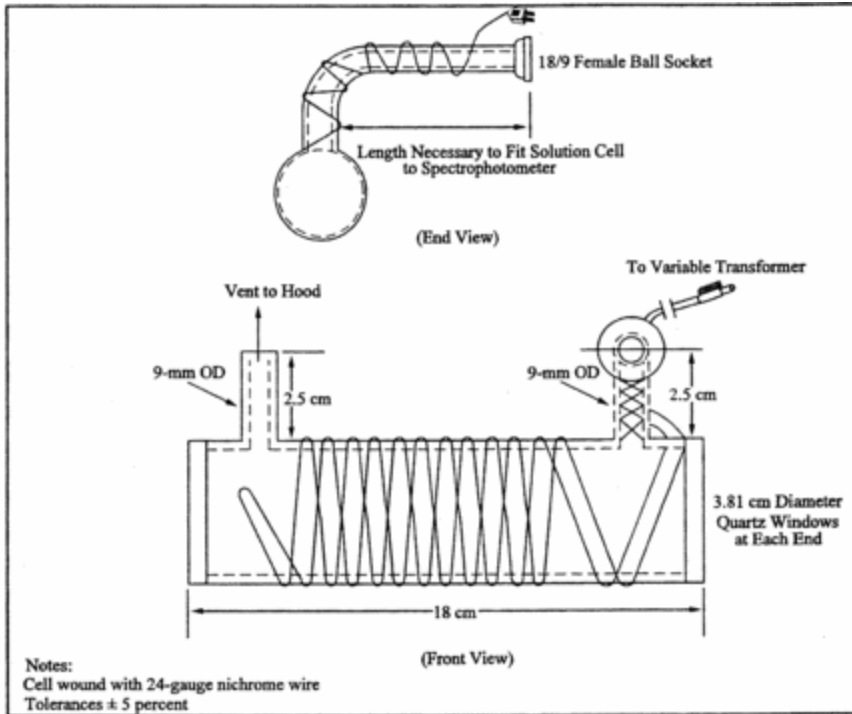

Figure 101-2. Optical Cell.

[View or download PDF](#)

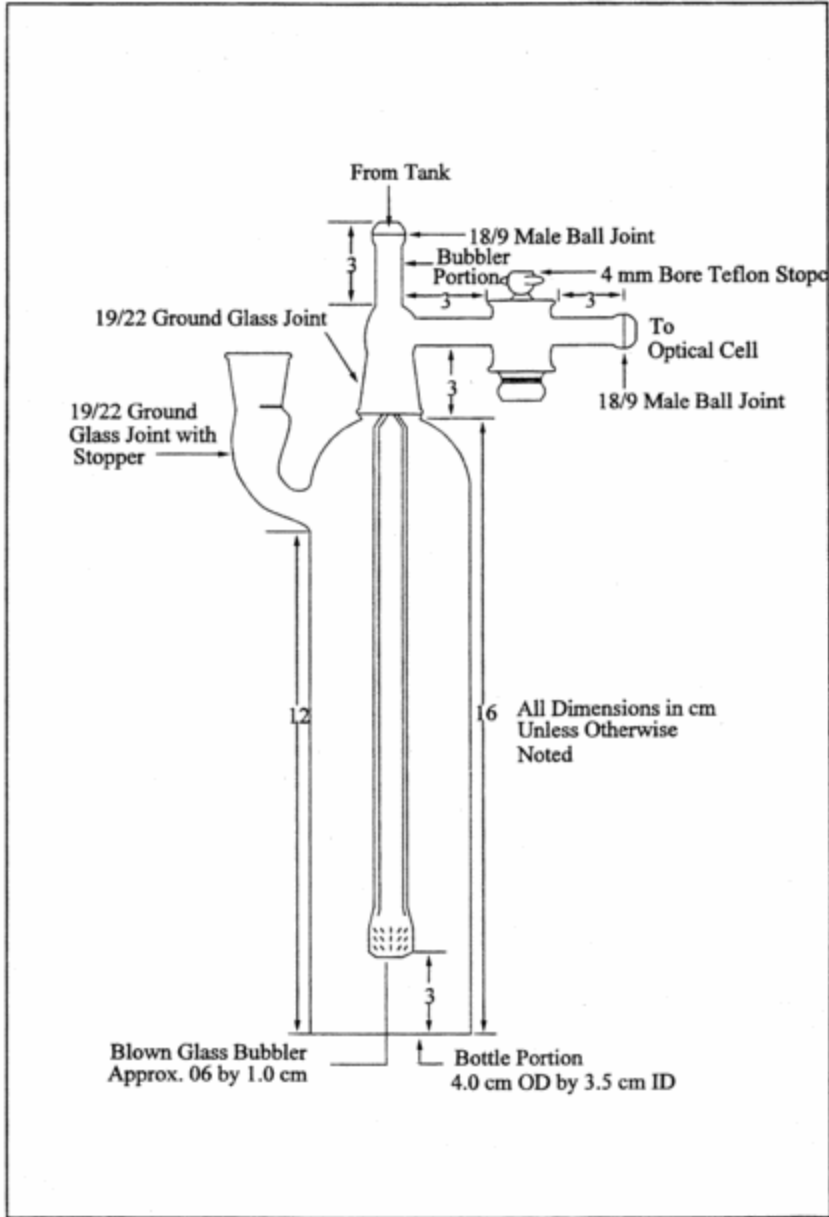

Figure 101-3. Aeration Cell.

[View or download PDF](#)



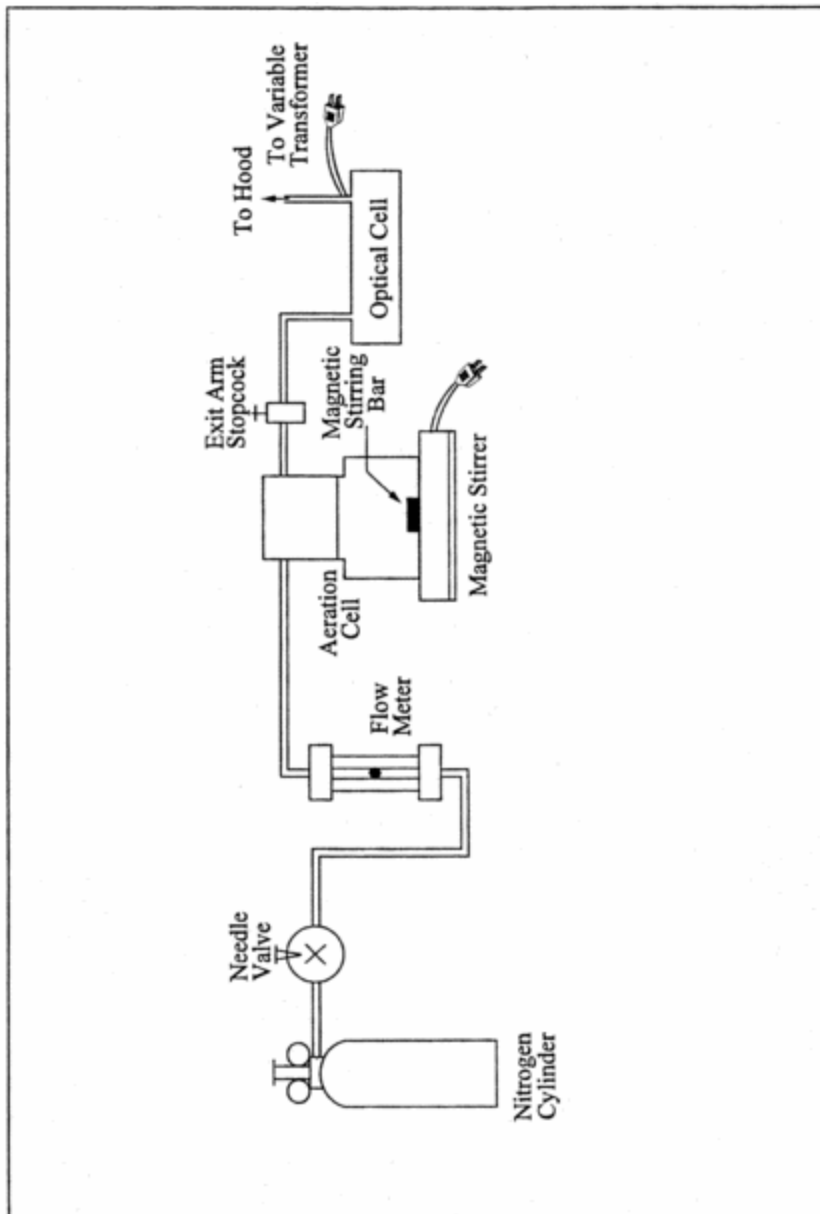

Figure 101-5. Schematic of Aeration System.

[View or download PDF](#)

### Method 101A—Determination of Particulate and Gaseous Mercury Emissions From Sewage Sludge Incinerators

Note: This method does not include all of the specifications (*e.g.*, equipment and supplies) and procedures (*e.g.*, sampling and analytical) essential to its performance. Some material is incorporated by reference from methods in appendix A to 40 CFR part 60 and in this part. Therefore, to obtain reliable results, persons using this method should also have a thorough knowledge of at least the following additional test methods: Methods 1, Method 2, Method 3, and Method 5 of part 60 (appendix A), and Method 101 part 61 (appendix B).

## 1.0 Scope and Application

### 1.1 Analytes.

Analyte	CAS No.	Sensitivity
Mercury (Hg)	7439-97-6	Dependent upon spectrophotometer and recorder.

1.2 Applicability. This method is applicable for the determination of Hg emissions from sewage sludge incinerators and other sources as specified in an applicable subpart of the regulations.

1.3 Data Quality Objectives. Adherence to the requirements of this method will enhance the quality of the data obtained from air pollutant sampling methods.

## 2.0 Summary of Method

2.1 Particulate and gaseous Hg emissions are withdrawn isokinetically from the source and are collected in acidic potassium permanganate (KMnO<sub>4</sub>) solution. The Hg collected (in the mercuric form) is reduced to elemental Hg, which is then aerated from the solution into an optical cell and measured by atomic absorption spectrophotometry.

## 3.0 Definitions. [Reserved]

## 4.0 Interferences

4.1 Sample Collection. Excessive oxidizable organic matter in the stack gas prematurely depletes the KMnO<sub>4</sub> solution and thereby prevents further collection of Hg.

4.2 Analysis. Condensation of water vapor on the optical cell windows causes a positive interference.

## 5.0 Safety

5.1 Disclaimer. This method may involve hazardous materials, operations, and equipment. This test method may not address all of the safety problems associated with its use. It is the responsibility of the user of this test method to establish appropriate safety and health practices and determine the applicability of regulatory limitations prior to performing this test method.

5.2 Corrosive Reagents. The following reagents are hazardous. Personal protective equipment and safe procedures are useful in preventing chemical splashes. If contact occurs, immediately flush with copious amounts of water for at least 15 minutes. Remove clothing under shower and decontaminate. Treat residual chemical burns as thermal burns.

5.2.1 Hydrochloric Acid (HCl). Highly toxic. Vapors are highly irritating to eyes, skin, nose, and lungs, causing severe damage. May cause bronchitis, pneumonia, or edema of lungs. Exposure to concentrations of 0.13 to 0.2 percent can be lethal to humans in a few minutes. Provide ventilation to limit exposure. Reacts with metals, producing hydrogen gas.

5.2.2 Nitric Acid ( $\text{HNO}_3$ ). Highly corrosive to eyes, skin, nose, and lungs. Vapors cause bronchitis, pneumonia, or edema of lungs. Reaction to inhalation may be delayed as long as 30 hours and still be fatal. Provide ventilation to limit exposure. Strong oxidizer. Hazardous reaction may occur with organic materials such as solvents.

5.2.3 Sulfuric acid ( $\text{H}_2\text{SO}_4$ ). Rapidly destructive to body tissue. Will cause third degree burns. Eye damage may result in blindness. Inhalation may be fatal from spasm of the larynx, usually within 30 minutes. May cause lung tissue damage with edema.  $3 \text{ mg/m}^3$  will cause lung damage in uninitiated.  $1 \text{ mg/m}^3$  for 8 hours will cause lung damage or, in higher concentrations, death. Provide ventilation to limit inhalation. Reacts violently with metals and organics.

5.3 Chlorine Evolution. Hydrochloric acid reacts with  $\text{KMnO}_4$  to liberate chlorine gas. Although this is a minimal concern when small quantities of HCl (5-10 ml) are used in the impinger rinse, a potential safety hazard may still exist. At sources that emit higher concentrations of oxidizable materials (*e.g.*, power plants), more HCl may be required to remove the larger amounts of brown deposit formed in the impingers. In such cases, the potential safety hazards due to sample container pressurization are greater, because of the larger volume of HCl rinse added to the recovered sample. These hazards are eliminated by storing and analyzing the HCl impinger wash separately from the permanganate impinger sample.

## 6.0 *Equipment and Supplies*

6.1 Sample Collection and Sample Recovery. Same as Method 101, Sections 6.1 and 6.2, respectively, with the following exceptions:

6.1.1 Probe Liner. Same as in Method 101, Section 6.1.2, except that if a filter is used ahead of the impingers, the probe heating system must be used to minimize the condensation of gaseous Hg.

6.1.2 Filter Holder (Optional). Borosilicate glass with a rigid stainless-steel wire-screen filter support (do not use glass frit supports) and a silicone rubber or Teflon gasket, designed to provide a positive seal against leakage from outside or around the filter. The filter holder must be equipped with a filter heating system capable of maintaining a temperature around the filter holder of  $120 \pm 14 \text{ }^\circ\text{C}$  ( $248 \pm 25 \text{ }^\circ\text{F}$ ) during sampling to minimize both water and gaseous Hg condensation. A filter may also be used in cases where the stream contains large quantities of particulate matter.

6.2 Sample Analysis. Same as Method 101, Section 6.3, with the following additions and exceptions:

6.2.1 Volumetric Pipets. Class A; 1-, 2-, 3-, 4-, 5-, 10-, and 20-ml.

6.2.2 Graduated Cylinder. 25-ml.

6.2.3 Steam Bath.

6.2.4 Atomic Absorption Spectrophotometer or Equivalent. Any atomic absorption unit with an open sample presentation area in which to mount the optical cell is suitable. Instrument settings recommended by the particular manufacturer should be followed. Instruments designed specifically for the measurement of mercury using the cold-vapor technique are commercially available and may be substituted for the atomic absorption spectrophotometer.

6.2.5 Optical Cell. Alternatively, a heat lamp mounted above the cell or a moisture trap installed upstream of the cell may be used.

6.2.6 Aeration Cell. Alternatively, aeration cells available with commercial cold vapor instrumentation may be used.

6.2.7 Aeration Gas Cylinder. Nitrogen, argon, or dry, Hg-free air, equipped with a single-stage regulator. Alternatively, aeration may be provided by a peristaltic metering pump. If a commercial cold vapor instrument is used, follow the manufacturer's recommendations.

## 7.0 Reagents and Standards

Unless otherwise indicated, it is intended that all reagents conform to the specifications established by the Committee on Analytical Reagents of the American Chemical Society, where such specifications are available; otherwise, use the best available grade.

7.1 Sample Collection and Recovery. The following reagents are required for sample collection and recovery:

7.1.1 Water. Deionized distilled, to conform to ASTM D 1193-77 or 91 Type 1. If high concentrations of organic matter are not expected to be present, the analyst may eliminate the  $\text{KMnO}_4$  test for oxidizable organic matter. Use this water in all dilutions and solution preparations.

7.1.2 Nitric Acid, 50 Percent (V/V). Mix equal volumes of concentrated  $\text{HNO}_3$  and water, being careful to add the acid to the water slowly.

7.1.3 Silica Gel. Indicating type, 6 to 16 mesh. If previously used, dry at  $175\text{ }^\circ\text{C}$  ( $350\text{ }^\circ\text{F}$ ) for 2 hours. New silica gel may be used as received.

7.1.4 Filter (Optional). Glass fiber filter, without organic binder, exhibiting at least 99.95 percent efficiency on  $0.3\text{-}\mu\text{m}$  dioctyl phthalate smoke particles. The filter in cases where the gas stream contains large quantities of particulate matter, but blank filters should be analyzed for Hg content.

7.1.5 Sulfuric Acid, 10 Percent (V/V). Carefully add and mix 100 ml of concentrated  $\text{H}_2\text{SO}_4$  to 900 ml of water.

7.1.6 Absorbing Solution, 4 Percent  $\text{KMnO}_4$  (W/V). Prepare fresh daily. Dissolve 40 g of  $\text{KMnO}_4$  in sufficient 10 percent  $\text{H}_2\text{SO}_4$  to make 1 liter. Prepare and store in glass bottles to prevent degradation.

7.1.7 Hydrochloric Acid, 8 N. Carefully add and mix 67 ml of concentrated HCl to 33 ml of water.

7.2 Sample Analysis. The following reagents and standards are required for sample analysis:

7.2.1 Water. Same as in Section 7.1.1.

7.2.2 Tin (II) Solution. Prepare fresh daily, and keep sealed when not being used. Completely dissolve 20 g of tin (II) chloride (or 25 g of tin (II) sulfate) crystals (Baker Analyzed reagent grade or any other brand that will give a clear solution) in 25 ml of concentrated HCl. Dilute to 250 ml with water. Do not substitute  $\text{HNO}_3$ ,  $\text{H}_2\text{SO}_4$ , or other strong acids for the HCl.

7.2.3 Sodium Chloride-Hydroxylamine Solution. Dissolve 12 g of sodium chloride and 12 g of hydroxylamine sulfate (or 12 g of hydroxylamine hydrochloride) in water and dilute to 100 ml.

7.2.4 Hydrochloric Acid, 8 N. Same as Section 7.1.7.

7.2.5 Nitric Acid, 15 Percent (V/V). Carefully add 15 ml HNO<sub>3</sub> to 85 ml of water.

7.2.6 Antifoam B Silicon Emulsion. J.T. Baker Company (or equivalent).

7.2.7 Mercury Stock Solution, 1 mg Hg/ml. Prepare and store all Hg standard solutions in borosilicate glass containers. Completely dissolve 0.1354 g of Hg (II) chloride in 75 ml of water. Add 10 ml of concentrated HNO<sub>3</sub>, and adjust the volume to exactly 100 ml with water. Mix thoroughly. This solution is stable for at least one month.

7.2.8 Intermediate Hg Standard Solution, 10 µg/ml. Prepare fresh weekly. Pipet 5.0 ml of the Hg stock solution (Section 7.2.7) into a 500 ml volumetric flask, and add 20 ml of 15 percent HNO<sub>3</sub> solution. Adjust the volume to exactly 500 ml with water. Thoroughly mix the solution.

7.2.9 Working Hg Standard Solution, 200 ng Hg/ml. Prepare fresh daily. Pipet 5.0 ml from the "Intermediate Hg Standard Solution" (Section 7.2.8) into a 250-ml volumetric flask. Add 5 ml of 4 percent KMnO<sub>4</sub> absorbing solution and 5 ml of 15 percent HNO<sub>3</sub>. Adjust the volume to exactly 250 ml with water. Mix thoroughly.

7.2.10 Potassium Permanganate, 5 Percent (W/V). Dissolve 5 g of KMnO<sub>4</sub> in water and dilute to 100 ml.

7.2.11 Filter. Whatman No. 40, or equivalent.

## 8.0 *Sample Collection, Preservation, Transport, and Storage*

Same as Method 101, Section 8.0, with the exception of the following:

8.1 Preliminary Determinations. Same as Method 101, Section 8.2, except that the liberation of free iodine in the first impinger due to high Hg or sulfur dioxide concentrations is not applicable. In this method, high oxidizable organic content may make it impossible to sample for the desired minimum time. This problem is indicated by the complete bleaching of the purple color of the KMnO<sub>4</sub> solution. In cases where an excess of water condensation is encountered, collect two runs to make one sample, or add an extra impinger in front of the first impinger (also containing acidified KMnO<sub>4</sub> solution).

8.2 Preparation of Sampling Train. Same as Method 101, Section 8.3, with the exception of the following:

8.2.1 In this method, clean all the glass components by rinsing with 50 percent HNO<sub>3</sub>, tap water, 8 N HCl, tap water, and finally with deionized distilled water. Then place 50 ml of absorbing solution in the first impinger and 100 ml in each of the second and third impingers.

8.2.2 If a filter is used, use a pair of tweezers to place the filter in the filter holder. Be sure to center the filter, and place the gasket in the proper position to prevent the sample gas stream from bypassing the filter. Check the filter for tears after assembly is completed. Be sure also to set the filter heating system at the desired operating temperature after the sampling train has been assembled.



8.3 Sampling Train Operation. In addition to the procedure outlined in Method 101, Section 8.5, maintain a temperature around the filter (if applicable) of  $120 \pm 14$  °C ( $248 \pm 25$  °F).

8.4 Sample Recovery. Same as Method 101, Section 8.7, with the exception of the following:

8.4.1 Transfer the probe, impinger assembly, and (if applicable) filter assembly to the cleanup area.

8.4.2 Treat the sample as follows:

8.4.2.1 Container No. 1 (Impinger, Probe, and Filter Holder) and, if applicable, Container No. 1A (HCl rinse).

8.4.2.1.1 Using a graduated cylinder, measure the liquid in the first three impingers to within 1 ml. Record the volume of liquid present (*e.g.*, see Figure 5-6 of Method 5). This information is needed to calculate the moisture content of the effluent gas. (Use only graduated cylinder and glass storage bottles that have been precleaned as in Section 8.2.1.) Place the contents of the first three impingers (four if an extra impinger was added as described in Section 8.1) into a 1000-ml glass sample bottle labeled Container No. 1.

Note: If a filter is used, remove the filter from its holder as outlined under Section 8.4.3.

8.4.2.1.2 Taking care that dust on the outside of the probe or other exterior surfaces does not get into the sample, quantitatively recover the Hg (and any condensate) from the probe nozzle, probe fitting, probe liner, front half of the filter holder (if applicable), and impingers as follows: Rinse these components with a total of 400 ml (350 ml if an extra impinger was added as described in Section 8.1) of fresh absorbing solution, carefully assuring removal of all loose particulate matter from the impingers; add all washings to the 1000 ml glass sample bottle. To remove any residual brown deposits on the glassware following the permanganate rinse, rinse with approximately 100 ml of water, carefully assuring removal of all loose particulate matter from the impingers. Add this rinse to Container No. 1.

8.4.2.1.3 If no visible deposits remain after this water rinse, do not rinse with 8 N HCl. If deposits do remain on the glassware after the water rinse, wash impinger walls and stems with 25 ml of 8 N HCl, and place the wash in a separate container labeled Container No. 1A as follows: Place 200 ml of water in a sample container labeled Container No. 1A. Wash the impinger walls and stem with the HCl by turning the impinger on its side and rotating it so that the HCl contacts all inside surfaces. Pour the HCl wash carefully with stirring into Container No. 1A.

8.4.2.1.4 After all washings have been collected in the appropriate sample container(s), tighten the lid(s) on the container(s) to prevent leakage during shipment to the laboratory. Mark the height of the fluid level to allow subsequent determination of whether leakage has occurred during transport. Label each container to identify its contents clearly.

8.4.3 Container No. 2 (Silica Gel). Same as Method 5, Section 8.7.6.3.

8.4.4 Container No. 3 (Filter). If a filter was used, carefully remove it from the filter holder, place it in a 100-ml glass sample bottle, and add 20 to 40 ml of absorbing solution. If it is necessary to fold the filter, be sure that the particulate cake is inside the fold. Carefully transfer to the 100-ml sample bottle any particulate matter and filter fibers that adhere to the filter holder gasket by using a dry Nylon bristle brush

and a sharp-edged blade. Seal the container. Label the container to identify its contents clearly. Mark the height of the fluid level to allow subsequent determination of whether leakage has occurred during transport.

8.4.5 Container No. 4 (Filter Blank). If a filter was used, treat an unused filter from the same filter lot as that used for sampling according to the procedures outlined in Section 8.4.4.

8.4.6 Container No. 5 (Absorbing Solution Blank). Place 650 ml of 4 percent  $\text{KMnO}_4$  absorbing solution in a 1000-ml sample bottle. Seal the container.

8.4.7 Container No. 6 (HCl Rinse Blank). Place 200 ml of water in a 1000-ml sample bottle, and add 25 ml of 8 N HCl carefully with stirring. Seal the container. Only one blank sample per 3 runs is required.

## 9.0 Quality Control

### 9.1 Miscellaneous Quality Control Measures.

Section	Quality control measure	Effect
8.0, 10.0	Sampling equipment leak-checks and calibration	Ensure accuracy and precision of sampling measurements.
10.2	Spectrophotometer calibration	Ensure linearity of spectrophotometer response to standards.
11.3.3	Check for matrix effects	Eliminate matrix effects.

9.2 Volume Metering System Checks. Same as Method 5, Section 9.2.

## 10.0 Calibration and Standardization

Same as Method 101, Section 10.0, with the following exceptions:

10.1 Optical Cell Heating System Calibration. Same as in Method 101, Section 10.4, except use a 25 ml graduated cylinder to add 25 ml of water to the bottle section of the aeration cell.

### 10.2 Spectrophotometer and Recorder Calibration.

10.2.1 The Hg response may be measured by either peak height or peak area.

Note: The temperature of the solution affects the rate at which elemental Hg is released from a solution and, consequently, it affects the shape of the absorption curve (area) and the point of maximum absorbance (peak height). To obtain reproducible results, all solutions must be brought to room temperature before use.

10.2.2 Set the spectrophotometer wave length at 253.7 nm, and make certain the optical cell is at the minimum temperature that will prevent water condensation. Then set the recorder scale as follows: Using

a 25-ml graduated cylinder, add 25 ml of water to the aeration cell bottle. Add three drops of Antifoam B to the bottle, and then pipet 5.0 ml of the working Hg standard solution into the aeration cell.

Note: Always add the Hg-containing solution to the aeration cell after the 25 ml of water.

10.2.3 Place a Teflon-coated stirring bar in the bottle. Add 5 ml of absorbing solution to the aeration bottle, and mix well. Before attaching the bottle section to the bubbler section of the aeration cell, make certain that (1) the aeration cell exit arm stopcock (Figure 101-3 of Method 101) is closed (so that Hg will not prematurely enter the optical cell when the reducing agent is being added) and (2) there is no flow through the bubbler. If conditions (1) and (2) are met, attach the bottle section to the bubbler section of the aeration cell. Add sodium chloride-hydroxylamine in 1 ml increments until the solution is colorless. Now add 5 ml of tin (II) solution to the aeration bottle through the side arm, and immediately stopper the side arm. Stir the solution for 15 seconds, turn on the recorder, open the aeration cell exit arm stopcock, and immediately initiate aeration with continued stirring. Determine the maximum absorbance of the standard, and set this value to read 90 percent of the recorder full scale.

### *11.0 Analytical Procedure*

11.1 Sample Loss Check. Check the liquid level in each container to see if liquid was lost during transport. If a noticeable amount of leakage occurred, either void the sample or use methods subject to the approval of the Administrator to account for the losses.

11.2 Sample Preparation. Treat sample containers as follows:

11.2.1 Containers No. 3 and No. 4 (Filter and Filter Blank).

11.2.1.1 If a filter is used, place the contents, including the filter, of Containers No. 3 and No. 4 in separate 250-ml beakers, and heat the beakers on a steam bath until most of the liquid has evaporated. Do not heat to dryness. Add 20 ml of concentrated HNO<sub>3</sub> to the beakers, cover them with a watch glass, and heat on a hot plate at 70 °C (160 °F) for 2 hours. Remove from the hot plate.

11.2.1.2 Filter the solution from digestion of the Container No. 3 contents through Whatman No. 40 filter paper, and save the filtrate for addition to the Container No. 1 filtrate as described in Section 11.2.2. Discard the filter paper.

11.2.1.3 Filter the solution from digestion of the Container No. 4 contents through Whatman No. 40 filter paper, and save the filtrate for addition to Container No. 5 filtrate as described in Section 11.2.3 below. Discard the filter paper.

11.2.2 Container No. 1 (Impingers, Probe, and Filter Holder) and, if applicable, No. 1A (HCl rinse).

11.2.2.1 Filter the contents of Container No. 1 through Whatman No. 40 filter paper into a 1 liter volumetric flask to remove the brown manganese dioxide (MnO<sub>2</sub>) precipitate. Save the filter for digestion of the brown MnO<sub>2</sub> precipitate. Add the sample filtrate from Container No. 3 to the 1-liter volumetric flask, and dilute to volume with water. If the combined filtrates are greater than 1000 ml, determine the volume to the nearest ml and make the appropriate corrections for blank subtractions. Mix thoroughly. Mark the filtrate as analysis Sample No. A.1 and analyze for Hg within 48 hr of the filtration step. Place the saved filter, which was used to remove the brown MnO<sub>2</sub> precipitate, into an appropriate sized

container. In a laboratory hood, add 25 ml of 8 N HCl to the filter and allow to digest for a minimum of 24 hours at room temperature.

11.2.2.2 Filter the contents of Container 1A through Whatman No. 40 filter paper into a 500-ml volumetric flask. Then filter the digestate of the brown MnO<sub>2</sub> precipitate from Container No. 1 through Whatman No. 40 filter paper into the same 500-ml volumetric flask, and dilute to volume with water. Mark this combined 500 ml dilute solution as analysis Sample No. A.2. Discard the filters.

11.2.3 Container No. 5 (Absorbing Solution Blank) and No. 6 (HCl Rinse Blank).

11.2.3.1 Treat Container No. 5 as Container No. 1 (as described in Section 11.2.2), except substitute the filter blank filtrate from Container No. 4 for the sample filtrate from Container No. 3, and mark as Sample A.1 Blank.

11.2.3.2 Treat Container No. 6 as Container No. 1A, (as described in Section 11.2.2, except substitute the filtrate from the digested blank MnO<sub>2</sub> precipitate for the filtrate from the digested sample MnO<sub>2</sub> precipitate, and mark as Sample No. A.2 Blank.

Note: When analyzing samples A.1 Blank and HCl A.2 Blank, always begin with 10 ml aliquots. This applies specifically to blank samples.

11.3 Analysis. Calibrate the analytical equipment and develop a calibration curve as outlined in Section 10.0.

11.3.1 Mercury Samples. Then repeat the procedure used to establish the calibration curve with appropriately sized aliquots (1 to 10 ml) of the samples (from Sections 11.2.2 and 11.2.3) until two consecutive peak heights agree within 3 percent of their average value. If the 10 ml sample is below the detectable limit, use a larger aliquot (up to 20 ml), but decrease the volume of water added to the aeration cell accordingly to prevent the solution volume from exceeding the capacity of the aeration bottle. If the peak maximum of a 1.0 ml aliquot is off scale, further dilute the original sample to bring the Hg concentration into the calibration range of the spectrophotometer. If the Hg content of the absorbing solution and filter blank is below the working range of the analytical method, use zero for the blank.

11.3.2 Run a blank and standard at least after every five samples to check the spectrophotometer calibration; recalibrate as necessary.

11.3.3 Check for Matrix Effects (optional). Same as Method 101, Section 11.3.3.

## 12.0 Data Analysis and Calculations

Note: Carry out calculations, retaining at least one extra decimal significant figure beyond that of the acquired data. Round off figures only after the final calculation. Other forms of the equations may be used as long as they give equivalent results.

12.1 Nomenclature.

$C_{(\text{filtr})\text{Hg}}$  = Total ng of Hg in aliquot of KMnO<sub>4</sub> filtrate and HNO<sub>3</sub> digestion of filter analyzed (aliquot of analysis Sample No. A.1).

$C_{(\text{filtr blank})\text{Hg}}$  = Total ng of Hg in aliquot of  $\text{KMnO}_4$  blank and  $\text{HNO}_3$  digestion of blank filter analyzed (aliquot of analysis Sample No. A.1 blank).

$C_{(\text{HCl blank})\text{Hg}}$  = Total ng of Hg analyzed in aliquot of the 500-ml analysis Sample No. HCl A.2 blank.

$C_{(\text{HCl})\text{Hg}}$  = Total ng of Hg analyzed in the aliquot from the 500-ml analysis Sample No. HCl A.2.

DF = Dilution factor for the HCl-digested Hg-containing solution, Analysis Sample No. "HCl A.2."

$DF_{\text{blk}}$  = Dilution factor for the HCl-digested Hg containing solution, Analysis Sample No. "HCl A.2 blank." (Refer to sample No. "HCl A.2" dilution factor above.)

$m_{(\text{filtr})\text{Hg}}$  = Total blank corrected  $\mu\text{g}$  of Hg in  $\text{KMnO}_4$  filtrate and  $\text{HNO}_3$  digestion of filter sample.

$m_{(\text{HCl})\text{Hg}}$  = Total blank corrected  $\mu\text{g}$  of Hg in HCl rinse and HCl digestate of filter sample.

$m_{\text{Hg}}$  = Total blank corrected Hg content in each sample,  $\mu\text{g}$ .

S = Aliquot volume of sample added to aeration cell, ml.

$S_{\text{blk}}$  = Aliquot volume of blank added to aeration cell, ml.

$V_{f(\text{blk})}$  = Solution volume of blank sample, 1000 ml for samples diluted as described in Section 11.2.2.

$V_{f(\text{filtr})}$  = Solution volume of original sample, normally 1000 ml for samples diluted as described in Section 11.2.2.

$V_{f(\text{HCl})}$  = Solution volume of original sample, 500 ml for samples diluted as described in Section 11.2.1.

$10^{-3}$  = Conversion factor,  $\mu\text{g}/\text{ng}$ .

12.2 Average Dry Gas Meter Temperature and Average Orifice Pressure Drop, Dry Gas Volume, Volume of Water Vapor Condensed, Moisture Content, Isokinetic Variation, and Stack Gas Velocity and Volumetric Flow Rate. Same as Method 5, Sections 12.2 through 12.5, 12.11, and 12.12, respectively.

### 12.3 Total Mercury.

12.3.1 For each source sample, correct the average maximum absorbance of the two consecutive samples whose peak heights agree within 3 percent of their average for the contribution of the blank. Use the calibration curve and these corrected averages to determine the final total weight of Hg in ng in the aeration cell for each source sample.

12.3.2 Correct for any dilutions made to bring the sample into the working range of the spectrophotometer.

$$m_{(\text{HCl})\text{Hg}} = \frac{[C_{(\text{HCl})\text{Hg}} \text{DF}]}{S} - \frac{[C_{(\text{HCl}\text{blk})\text{Hg}} \text{DF}_{\text{blk}}]}{S_{\text{blk}}} V_{f(\text{HCl})} (10^{-3}) \quad \text{Eq. 101A-1}$$

[View or download PDF](#)

Note: This dilution factor applies only to the intermediate dilution steps, since the original sample volume  $[(V_f)_{\text{HCL}}]$  of “HCl A.2” has been factored out in the equation along with the sample aliquot (S). In Eq. 101A-1, the sample aliquot, S, is introduced directly into the aeration cell for analysis according to the procedure outlined in Section 11.3.1. A dilution factor is required only if it is necessary to bring the sample into the analytical instrument's calibration range.

Note: The maximum allowable blank subtraction for the HCl is the lesser of the two following values: (1) the actual blank measured value (analysis Sample No. HCl A.2 blank), or (2) 5% of the Hg content in the combined HCl rinse and digested sample (analysis Sample No. HCl A.2).

$$m_{(\text{HCl})\text{Hg}} = \frac{[C_{(\text{HCl})\text{Hg}} \text{DF} V_{f(\text{HCl})}]}{S} - \frac{[C_{(\text{HCl} \text{ blk})\text{Hg}} \text{DF}_{\text{blk}} V_{f(\text{blk})}]}{S_{\text{blk}}} \quad \text{Eq. 101A-2}$$

[View or download PDF](#)

Note: The maximum allowable blank subtraction for the HCl is the lesser of the two following values: (1) the actual blank measured value (analysis Sample No. “A.1 blank”), or (2) 5% of the Hg content in the filtrate (analysis Sample No. “A.1”).

$$m_{\text{Hg}} = m_{(\text{HCl})\text{Hg}} + m_{(\text{HCl})\text{Hg}} \quad \text{Eq. 101A-3}$$

[View or download PDF](#)

12.3 Mercury Emission Rate. Same as Method 101, Section 12.3.

12.4 Determination of Compliance. Same as Method 101, Section 12.4.

### 13.0 Method Performance

13.1 Precision. Based on eight paired-train tests, the intra-laboratory standard deviation was estimated to be 4.8  $\mu\text{g/ml}$  in the concentration range of 50 to 130  $\mu\text{g/m}^3$ .

13.2 Bias. [Reserved]

13.3 Range. After initial dilution, the range of this method is 20 to 800 ng Hg/ml. The upper limit can be extended by further dilution of the sample.

14.0 Pollution Prevention [Reserved]

15.0 Waste Management [Reserved]

16.0 Alternative Procedures

16.1 Alternative Analyzers.

16.1.1 Inductively coupled plasma-atomic emission spectrometry (ICP-AES) may be used as an alternative to atomic absorption analysis provided the following conditions are met:

16.1.1.1 Sample collection, sample preparation, and analytical preparation procedures are as defined in the method except as necessary for the ICP-AES application.

16.1.1.2 The quality control procedures are conducted as prescribed.

16.1.1.3 The limit of quantitation for the ICP-AES must be demonstrated and the sample concentrations reported should be no less than two times the limit of quantitation. The limit of quantitation is defined as ten times the standard deviation of the blank value. The standard deviation of the blank value is determined from the analysis of seven blanks. It has been reported that for mercury and those elements that form hydrides, a continuous-flow generator coupled to an ICP-AES offers detection limits comparable to cold vapor atomic absorption.

16.1.2 Samples may also be analyzed by cold vapor atomic fluorescence spectrometry.

### 17.0 References

Same as Section 16.0 of Method 101, with the addition of the following:

1. Mitchell, W.J., *et al.* Test Methods to Determine the Mercury Emissions from Sludge Incineration Plants. U.S. Environmental Protection Agency. Research Triangle Park, NC. Publication No. EPA-600/4-79-058. September 1979.
2. Wilshire, Frank W., *et al.* Reliability Study of the U.S. EPA's Method 101A—Determination of Particulate and Gaseous Mercury Emissions. U.S. Environmental Protection Agency. Research Triangle Park, NC. Report No. 600/D-31/219 AREAL 367, NTIS Acc No. PB91-233361.
3. Memorandum from William J. Mitchell to Roger T. Shigehara discussing the potential safety hazard in Section 7.2 of Method 101A. February 28, 1990.

### 18.0 Tables, Diagrams, Flowcharts, And Validation Data [Reserved]

#### Method 102—Determination of Particulate and Gaseous Mercury Emissions From Chlor-Alkali Plants (Hydrogen Streams)

Note: This method does not include all of the specifications (*e.g.*, equipment and supplies) and procedures (*e.g.*, sampling and analytical) essential to its performance. Some material is incorporated by reference from other methods in this part and in appendix A to 40 CFR part 60. Therefore, to obtain reliable results, persons using this method should have a thorough knowledge of at least the following additional test methods: Method 1, Method 2, Method 3, Method 5, and Method 101.

### 1.0 Scope and Application

#### 1.1 Analytes.

Analyte	CAS No.	Sensitivity
Mercury (Hg)	7439-97-6	Dependent upon recorder and spectrophotometer.

1.2 Applicability. This method is applicable for the determination of Hg emissions, including both particulate and gaseous Hg, from chlor-alkali plants and other sources (as specified in the regulations) where the carrier-gas stream in the duct or stack is principally hydrogen.

1.3 Data Quality Objectives. Adherence to the requirements of this method will enhance the quality of the data obtained from air pollutant sampling methods.

## 2.0 Summary of Method

2.1 Particulate and gaseous Hg emissions are withdrawn isokinetically from the source and collected in acidic iodine monochloride (ICl) solution. The Hg collected (in the mercuric form) is reduced to elemental Hg, which is then aerated from the solution into an optical cell and measured by atomic absorption spectrophotometry.

## 3.0 Definitions [Reserved]

## 4.0 Interferences

Same as Method 101, Section 4.2.

## 5.0 Safety

5.1 Disclaimer. This method may involve hazardous materials, operations, and equipment. This test method may not address all of the safety problems associated with its use. It is the responsibility of the user of this test method to establish appropriate safety and health practices and determine the applicability of regulatory limitations prior to performing this test method.

5.2 Corrosive Reagents. Same as Method 101, Section 5.2.

5.3 Explosive Mixtures. The sampler must conduct the source test under conditions of utmost safety because hydrogen and air mixtures are explosive. Since the sampling train essentially is leakless, attention to safe operation can be concentrated at the inlet and outlet. If a leak does occur, however, remove the meter box cover to avoid a possible explosive mixture. The following specific precautions are recommended:

5.3.1 Operate only the vacuum pump during the test. The other electrical equipment, *e.g.*, heaters, fans, and timers, normally are not essential to the success of a hydrogen stream test.

5.3.2 Seal the sample port to minimize leakage of hydrogen from the stack.

5.3.3 Vent sampled hydrogen at least 3 m (10 ft) away from the train. This can be accomplished by attaching a 13-mm (0.50-in.) ID Tygon tube to the exhaust from the orifice meter.

Note: A smaller ID tubing may cause the orifice meter calibration to be erroneous. Take care to ensure that the exhaust line is not bent or pinched.

## 6.0 Equipment and Supplies

Same as Method 101, Section 6.0, with the exception of the following:

6.1 Probe Heating System. Do not use, unless otherwise specified.

6.2 Glass Fiber Filter. Do not use, unless otherwise specified.



## 7.0 Reagents and Standards

Same as Method 101, Section 7.0.

## 8.0 Sample Collection, Preservation, Transport, and Storage

Same as Method 101, Section 8.0, with the exception of the following:

### 8.1 Setting of Isokinetic Rates.

8.1.1 If a nomograph is used, take special care in the calculation of the molecular weight of the stack gas and in the setting of the nomograph to maintain isokinetic conditions during sampling (Sections 8.1.1.1 through 8.1.1.3 below).

8.1.1.1 Calibrate the meter box orifice. Use the techniques described in APTD-0576 (see Reference 9 in Section 17.0 of Method 5 of appendix A to part 60). Calibration of the orifice meter at flow conditions that simulate the conditions at the source is suggested. Calibration should either be done with hydrogen or with some other gas having a similar Reynolds Number so that there is similarity between the Reynolds Numbers during calibration and during sampling. Alternative mercury-free thermometers may be used if the thermometers are, at a minimum, equivalent in terms of performance or suitably effective for the specific temperature measurement application.

8.1.1.2 The nomograph described in APTD-0576 cannot be used to calculate the C factor because the nomograph is designed for use when the stack gas dry molecular weight is  $29 \pm 4$ . Instead, the following calculation should be made to determine the proper C factor:

$$C = 0.00154 \Delta H_{@} C_p^2 T_m (P_s / P_m) \frac{(1 - B_{ws})^2}{(1 - B_{ws}) + 18 B_{ws}} \quad \text{Eq. 102-1}$$

[View or download PDF](#)

Where:

$B_{ws}$  = Fraction by volume of water vapor in the stack gas.

$C_p$  = Pitot tube calibration coefficient, dimensionless.

$M_d$  = Dry molecular weight of stack gas, lb/lb-mole.

$P_s$  = Absolute pressure of stack gas, in. Hg.

$P_m$  = Absolute pressure of gas at the meter, in. Hg.

$T_m$  = Absolute temperature of gas at the orifice, °R.

$\Delta H_{@}$  = Meter box calibration factor obtained in Section 8.1.1.1, in. H<sub>2</sub>O.

0.00154 = (in. H<sub>2</sub>O/°R).

Note: This calculation is left in English units, and is not converted to metric units because nomographs are based on English units.

8.1.1.3 Set the calculated C factor on the operating nomograph, and select the proper nozzle diameter and K factor as specified in APTD-0576. If the C factor obtained in Section 8.1.1.2 exceeds the values specified on the existing operating nomograph, expand the C scale logarithmically so that the values can be properly located.

8.1.2 If a calculator is used to set isokinetic rates, it is suggested that the isokinetic equation presented in Reference 13 in Section 17.0 of Method 101 be consulted.

8.2 Sampling in Small (<12-in. Diameter) Stacks. When the stack diameter (or equivalent diameter) is less than 12 inches, conventional pitot tube-probe assemblies should not be used. For sampling guidelines, see Reference 14 in Section 17.0 of Method 101.

### *9.0 Quality Control*

Same as Method 101, Section 9.0.

### *10.0 Calibration and Standardizations*

Same as Method 101, Section 10.0.

### *11.0 Analytical Procedure*

Same as Method 101, Section 11.0.

### *12.0 Data Analysis and Calculations*

Same as Method 101, Section 12.0.

### *13.0 Method Performance*

Same as Method 101, Section 13.0.

13.1 Analytical Range. After initial dilution, the range of this method is 0.5 to 120  $\mu\text{g Hg/ml}$ . The upper limit can be extended by further dilution of the sample.

### *14.0 Pollution Prevention. [Reserved]*

### *15.0 Waste Management. [Reserved]*

### *16.0 References*

Same as Method 101, Section 16.0.

### *17.0 Tables, Diagrams, Flowcharts, and Validation Data. [Reserved]*

## Method 103—Beryllium Screening Method

### *1.0 Scope and Application*

## 1.1 Analytes.

Analyte	CAS No.	Sensitivity
Beryllium (Be)	7440-41-7	Dependent upon analytical procedure used.

1.2 Applicability. This procedure details guidelines and requirements for methods acceptable for use in determining Be emissions in ducts or stacks at stationary sources.

1.3 Data Quality Objectives. Adherence to the requirements of this method will enhance the quality of the data obtained from air pollutant sampling methods.

## 2.0 Summary of Method

2.1 Particulate Be emissions are withdrawn isokinetically from three points in a duct or stack and are collected on a filter. The collected sample is analyzed for Be using an appropriate technique.

## 3.0 Definitions. [Reserved]

## 4.0 Interferences. [Reserved]

## 5.0 Safety

5.1 Disclaimer. This method may involve hazardous materials, operations, and equipment. This test method may not address all of the safety problems associated with its use. It is the responsibility of the user of this test method to establish appropriate safety and health practices and determine the applicability of regulatory limitations prior to performing this test method.

5.2 Hydrochloric Acid (HCl). Highly corrosive and toxic. Vapors are highly irritating to eyes, skin, nose, and lungs, causing severe damage. May cause bronchitis, pneumonia, or edema of lungs. Exposure to concentrations of 0.13 to 0.2 percent can be lethal to humans in a few minutes. Provide ventilation to limit exposure. Reacts with metals, producing hydrogen gas. Personal protective equipment and safe procedures are useful in preventing chemical splashes. If contact occurs, immediately flush with copious amounts of water at least 15 minutes. Remove clothing under shower and decontaminate. Treat residual chemical burn as thermal burn.

## 6.0 Equipment and Supplies

6.1 Sample Collection. A schematic of the required sampling train configuration is shown in Figure 103-1 in Section 17.0. The essential components of the train are as follows:

6.1.1 Nozzle. Stainless steel, or equivalent, with sharp, tapered leading edge.

6.1.2 Probe. Sheathed borosilicate or quartz glass tubing.

6.1.3 Filter. Millipore AA, or equivalent, with appropriate filter holder that provides a positive seal against leakage from outside or around the filter. It is suggested that a Whatman 41, or equivalent, be placed immediately against the back side of the Millipore filter as a guard against breakage of the

Millipore. Include the backup filter in the analysis. To be equivalent, other filters shall exhibit at least 99.95 percent efficiency (0.05 percent penetration) on 0.3 micron dioctyl phthalate smoke particles, and be amenable to the Be analysis procedure. The filter efficiency tests shall be conducted in accordance with ASTM D 2986-71, 78, 95a (incorporated by reference—see §61.18). Test data from the supplier's quality control program are sufficient for this purpose.

6.1.4 Meter-Pump System. Any system that will maintain isokinetic sampling rate, determine sample volume, and is capable of a sampling rate of greater than 14 lpm (0.5 cfm).

6.2 Measurement of Stack Conditions. The following equipment is used to measure stack conditions:

6.2.1 Pitot Tube. Type S, or equivalent, with a constant coefficient ( $\pm 5$  percent) over the working range.

6.2.2 Inclined Manometer, or Equivalent. To measure velocity head to  $\pm 10$  percent of the minimum value.

6.2.3 Temperature Measuring Device. To measure stack temperature to  $\pm 1.5$  percent of the minimum absolute stack temperature.

6.2.4 Pressure Measuring Device. To measure stack pressure to  $\pm 2.5$  mm Hg (0.1 in. Hg).

6.2.5 Barometer. To measure atmospheric pressure to  $\pm 2.5$  mm Hg (0.1 in. Hg).

6.2.6 Wet and Dry Bulb Thermometers, Drying Tubes, Condensers, or Equivalent. To determine stack gas moisture content to  $\pm 1$  percent.

6.3 Sample Recovery.

6.3.1 Probe Cleaning Equipment. Probe brush or cleaning rod at least as long as probe, or equivalent. Clean cotton balls, or equivalent, should be used with the rod.

6.3.2 Leakless Glass Sample Bottles. To contain sample.

6.4 Analysis. All equipment necessary to perform an atomic absorption, spectrographic, fluorometric, chromatographic, or equivalent analysis.

## 7.0 *Reagents and Standards*

7.1 Sample Recovery.

7.1.1 Water. Deionized distilled, to conform to ASTM D 1193-77, 91 (incorporated by reference—see §61.18), Type 3.

7.1.2 Acetone. Reagent grade.

7.1.3 Wash Acid, 50 Percent (V/V) Hydrochloric Acid (HCl). Mix equal volumes of concentrated HCl and water, being careful to add the acid slowly to the water.

7.2 Analysis. Reagents and standards as necessary for the selected analytical procedure.

## 8.0 *Sample Collection, Preservation, Transport, and Storage*

Guidelines for source testing are detailed in the following sections. These guidelines are generally applicable; however, most sample sites differ to some degree and temporary alterations such as stack extensions or expansions often are required to insure the best possible sample site. Further, since Be is hazardous, care should be taken to minimize exposure. Finally, since the total quantity of Be to be collected is quite small, the test must be carefully conducted to prevent contamination or loss of sample.

8.1 Selection of a Sampling Site and Number of Sample Runs. Select a suitable sample site that is as close as practicable to the point of atmospheric emission. If possible, stacks smaller than one foot in diameter should not be sampled.

8.1.1 Ideal Sampling Site. The ideal sampling site is at least eight stack or duct diameters downstream and two diameters upstream from any flow disturbance such as a bend, expansion or contraction. For rectangular cross sections, use Equation 103-1 in Section 12.2 to determine an equivalent diameter,  $D_e$ .

8.1.2 Alternate Sampling Site. Some sampling situations may render the above sampling site criteria impractical. In such cases, select an alternate site no less than two diameters downstream and one-half diameter upstream from any point of flow disturbance. Additional sample runs are recommended at any sample site not meeting the criteria of Section 8.1.1.

8.1.3 Number of Sample Runs Per Test. Three sample runs constitute a test. Conduct each run at one of three different points. Select three points that proportionately divide the diameter, or are located at 25, 50, and 75 percent of the diameter from the inside wall. For horizontal ducts, sample on a vertical line through the centroid. For rectangular ducts, sample on a line through the centroid and parallel to a side. If additional sample runs are performed per Section 8.1.2, proportionately divide the duct to accommodate the total number of runs.

8.2 Measurement of Stack Conditions. Using the equipment described in Section 6.2, measure the stack gas pressure, moisture, and temperature to determine the molecular weight of the stack gas. Sound engineering estimates may be made in lieu of direct measurements. Describe the basis for such estimates in the test report.

8.3 Preparation of Sampling Train.

8.3.1 Assemble the sampling train as shown in Figure 103-1. It is recommended that all glassware be precleaned by soaking in wash acid for two hours.

8.3.2 Leak check the sampling train at the sampling site. The leakage rate should not be in excess of 1 percent of the desired sample rate.

8.4 Sampling Train Operation.

8.4.1 For each run, measure the velocity at the selected sampling point. Determine the isokinetic sampling rate. Record the velocity head and the required sampling rate. Place the nozzle at the sampling point with the tip pointing directly into the gas stream. Immediately start the pump and adjust the flow to isokinetic conditions. At the conclusion of the test, record the sampling rate. Again measure the velocity head at the sampling point. The required isokinetic rate at the end of the period should not have deviated

more than 20 percent from that originally calculated. Describe the reason for any deviation beyond 20 percent in the test report.

8.4.2 Sample at a minimum rate of 14 liters/min (0.5 cfm). Obtain samples over such a period or periods of time as are necessary to determine the maximum emissions which would occur in a 24-hour period. In the case of cyclic operations, perform sufficient sample runs so as to allow determination or calculation of the emissions that occur over the duration of the cycle. A minimum sampling time of two hours per run is recommended.

#### 8.5 Sample Recovery.

8.5.1 It is recommended that all glassware be precleaned as in Section 8.3. Sample recovery should also be performed in an area free of possible Be contamination. When the sampling train is moved, exercise care to prevent breakage and contamination. Set aside a portion of the acetone used in the sample recovery as a blank for analysis. The total amount of acetone used should be measured for accurate blank correction. Blanks can be eliminated if prior analysis shows negligible amounts.

8.5.2 Remove the filter (and backup filter, if used) and any loose particulate matter from filter holder, and place in a container.

8.5.3 Clean the probe with acetone and a brush or long rod and cotton balls. Wash into the container with the filter. Wash out the filter holder with acetone, and add to the same container.

#### 9.0 *Quality Control. [Reserved]*

#### 10.0 *Calibration and Standardization*

10.1 Sampling Train. As a procedural check, compare the sampling rate regulation with a dry gas meter, spirometer, rotameter (calibrated for prevailing atmospheric conditions), or equivalent, attached to the nozzle inlet of the complete sampling train.

10.2 Analysis. Perform the analysis standardization as suggested by the manufacturer of the instrument, or the procedures for the analytical method in use.

#### 11.0 *Analytical Procedure*

Make the necessary preparation of samples and analyze for Be. Any currently acceptable method (e.g., atomic absorption, spectrographic, fluorometric, chromatographic) may be used.

#### 12.0 *Data Analysis and Calculations*

12.1 Nomenclature.

$A_s(\text{avg}) = \text{Stack area, m}^2 (\text{ft}^2).$

L = Length.

R = Be emission rate, g/day.

$V_s(\text{avg})$  = Average stack gas velocity, m/sec (ft/sec).

$V_{\text{total}}$  = Total volume of gas sampled,  $\text{m}^3$  ( $\text{ft}^3$ ).

W = Width.

$W_t$  = Total weight of Be collected, mg.

$10^{-6}$  = Conversion factor, g/ $\mu\text{g}$ .

86,400 = Conversion factor, sec/day.

12.2 Calculate the equivalent diameter,  $D_e$ , for a rectangular cross section as follows:

$$D_e = \frac{2 \cdot L \cdot W}{L + W} \quad \text{Eq. 103-1}$$

[View or download PDF](#)

12.3 Calculate the Be emission rate, R, in g/day for each stack using Equation 103-2. For cyclic operations, use only the time per day each stack is in operation. The total Be emission rate from a source is the summation of results from all stacks.

$$R = \frac{W_t V_s(\text{avg}) A_s (86,400) (10^{-6})}{V_{\text{total}}} \quad \text{Eq. 103-2}$$

[View or download PDF](#)

12.4 Test Report. Prepare a test report that includes as a minimum: A detailed description of the sampling train used, results of the procedural check described in Section 10.1 with all data and calculations made, all pertinent data taken during the test, the basis for any estimates made, isokinetic sampling calculations, and emission results. Include a description of the test site, with a block diagram and brief description of the process, location of the sample points in the stack cross section, and stack dimensions and distances from any point of disturbance.

13.0 *Method Performance. [Reserved]*

14.0 *Pollution Prevention. [Reserved]*

15.0 *Waste Management. [Reserved]*

16.0 *References. [Reserved]*

17.0 *Tables, Diagrams, Flow Charts, and Validation Data*

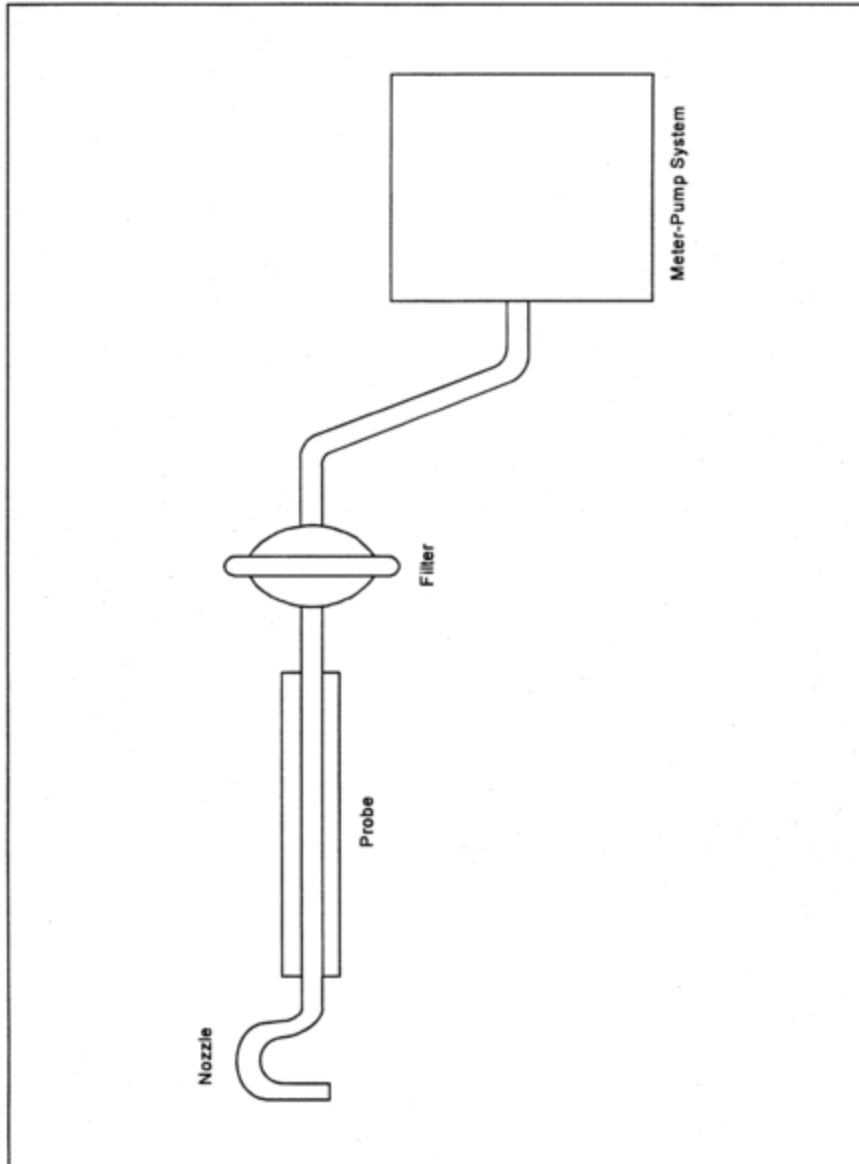

Figure 103-1. Beryllium Screening Method Sampling Train Schematic.

[View or download PDF](#)

#### Method 104—Determination of Beryllium Emissions From Stationary Sources

Note: This method does not include all of the specifications (*e.g.*, equipment and supplies) and procedures (*e.g.*, sampling and analytical) essential to its performance. Some material is incorporated by reference from methods in appendix A to 40 CFR part 60. Therefore, to obtain reliable results, persons using this method should have a thorough knowledge of at least the following additional test methods: Method 1, Method 2, Method 3, and Method 5 in appendix A, part 60.

##### 1.0 Scope and Application



## 1.1 Analytes.

Analyte	CAS No.	Sensitivity
Beryllium (Be)	7440-41-7	Dependent upon recorder and spectrophotometer.

1.2 Applicability. This method is applicable for the determination of Be emissions in ducts or stacks at stationary sources. Unless otherwise specified, this method is not intended to apply to gas streams other than those emitted directly to the atmosphere without further processing.

1.3 Data Quality Objectives. Adherences to the requirements of this method will enhance the quality of the data obtained from air pollutant sampling methods.

## 2.0 Summary of Method

2.1 Particulate and gaseous Be emissions are withdrawn isokinetically from the source and are collected on a glass fiber filter and in water. The collected sample is digested in an acid solution and is analyzed by atomic absorption spectrophotometry.

## 3.0 Definitions [Reserved]

## 4.0 Interferences

4.1 Matrix Effects. Analysis for Be by flame atomic absorption spectrophotometry is sensitive to the chemical composition and to the physical properties (*e.g.*, viscosity, pH) of the sample. Aluminum and silicon, in particular, are known to interfere when present in appreciable quantities. The analytical procedure includes (optionally) the use of the Method of Standard Additions to check for these matrix effects, and sample analysis using the Method of Standard Additions if significant matrix effects are found to be present (see Reference 2 in Section 17.0).

## 5.0 Safety

5.1 Disclaimer. This method may involve hazardous materials, operations, and equipment. This test method may not address all of the safety problems associated with its use. It is the responsibility of the user of this test method to establish appropriate safety and health practices and determine the applicability of regulatory limitations prior to performing this test method.

5.2 Corrosive reagents. The following reagents are hazardous. Personal protective equipment and safe procedures are useful in preventing chemical splashes. If contact occurs, immediately flush with copious amounts of water at least 15 minutes. Remove clothing under shower and decontaminate. Treat residual chemical burn as thermal burn.

5.2.1 Hydrochloric Acid (HC<sub>1</sub>). Highly toxic. Vapors are highly irritating to eyes, skin, nose, and lungs, causing severe damage. May cause bronchitis, pneumonia, or edema of lungs. Exposure to concentrations of 0.13 to 0.2 percent can be lethal to humans in a few minutes. Provide ventilation to limit exposure. Reacts with metals, producing hydrogen gas.

5.2.2 Hydrogen Peroxide (H<sub>2</sub>O<sub>2</sub>). Irritating to eyes, skin, nose, and lungs.

5.2.3 Nitric Acid (HNO<sub>3</sub>). Highly corrosive to eyes, skin, nose, and lungs. Vapors cause bronchitis, pneumonia, or edema of lungs. Reaction to inhalation may be delayed as long as 30 hours and still be fatal. Provide ventilation to limit exposure. Strong oxidizer. Hazardous reaction may occur with organic materials such as solvents.

5.2.4 Sodium Hydroxide (NaOH). Causes severe damage to eyes and skin. Inhalation causes irritation to nose, throat, and lungs. Reacts exothermically with limited amounts of water.

5.3 Beryllium is hazardous, and precautions should be taken to minimize exposure.

## 6.0 *Equipment and Supplies*

6.1 Sample Collection. Same as Method 5, Section 6.1, with the exception of the following:

6.1.1 Sampling Train. Same as Method 5, Section 6.1.1, with the exception of the following:

6.1.2 Probe Liner. Borosilicate or quartz glass tubing. A heating system capable of maintaining a gas temperature of 120 ±14 °C (248 ±25 °F) at the probe exit during sampling to prevent water condensation may be used.

Note: Do not use metal probe liners.

6.1.3 Filter Holder. Borosilicate glass, with a glass frit filter support and a silicone rubber gasket. Other materials of construction (*e.g.*, stainless steel, Teflon, Viton) may be used, subject to the approval of the Administrator. The holder design shall provide a positive seal against leakage from the outside or around the filter. The holder shall be attached immediately at the outlet of the probe. A heating system capable of maintaining the filter at a minimum temperature in the range of the stack temperature may be used to prevent condensation from occurring.

6.1.4 Impingers. Four Greenburg-Smith impingers connected in series with leak-free ground glass fittings or any similar leak-free noncontaminating fittings. For the first, third, and fourth impingers, use impingers that are modified by replacing the tip with a 13 mm-ID (0.5 in.) glass tube extending to 13 mm (0.5 in.) from the bottom of the flask may be used.

6.2 Sample Recovery. The following items are needed for sample recovery:

6.2.1 Probe Cleaning Rod. At least as long as probe.

6.2.2 Glass Sample Bottles. Leakless, with Teflon-lined caps, 1000 ml.

6.2.3 Petri Dishes. For filter samples, glass or polyethylene, unless otherwise specified by the Administrator.

6.2.4 Graduated Cylinder. 250 ml.

6.2.5 Funnel and Rubber Policeman. To aid in transfer of silica gel to container; not necessary if silica gel is weighed in the field.

6.2.6 Funnel. Glass, to aid in sample recovery.

6.2.7 Plastic Jar. Approximately 300 ml.

6.3 Analysis. The following items are needed for sample analysis:

6.3.1 Atomic Absorption Spectrophotometer. Perkin-Elmer 303, or equivalent, with nitrous oxide/acetylene burner.

6.3.2 Hot Plate.

6.3.3 Perchloric Acid Fume Hood.

## 7.0 *Reagents and Standards*

Note: Unless otherwise indicated, it is intended that all reagents conform to the specifications established by the Committee on Analytical Reagents of the American Chemical Society, where such specifications are available; otherwise, use the best available grade.

7.1 Sample Collection. Same as Method 5, Section 7.1, including deionized distilled water conforming to ASTM D 1193-77 or 91 (incorporated by reference—see §61.18), Type 3. The Millipore AA filter is recommended.

7.2 Sample Recovery. Same as Method 5 in appendix A, part 60, Section 7.2, with the addition of the following:

7.2.1 Wash Acid, 50 Percent (V/V) Hydrochloric Acid (HCl). Mix equal volumes of concentrated HCl and water, being careful to add the acid slowly to the water.

7.3 Sample Preparation and Analysis. The following reagents and standards and standards are needed for sample preparation and analysis:

7.3.1 Water. Same as in Section 7.1.

7.3.2. Perchloric Acid (HClO<sub>4</sub>). Concentrated (70 percent V/V).

7.3.3 Nitric Acid (HNO<sub>3</sub>). Concentrated.

7.3.4 Beryllium Powder. Minimum purity 98 percent.

7.3.5 Sulfuric Acid (H<sub>2</sub>SO<sub>4</sub>) Solution, 12 N. Dilute 33 ml of concentrated H<sub>2</sub>SO<sub>4</sub> to 1 liter with water.

7.3.6 Hydrochloric Acid Solution, 25 Percent HCl (V/V).

7.3.7 Stock Beryllium Standard Solution, 10 µg Be/ml. Dissolve 10.0 mg of Be in 80 ml of 12 N H<sub>2</sub>SO<sub>4</sub> in a 1000-ml volumetric flask. Dilute to volume with water. This solution is stable for at least one month. Equivalent strength Be stock solutions may be prepared from Be salts such as BeCl<sub>2</sub> and Be(NO<sub>3</sub>)<sub>2</sub> (98 percent minimum purity).

7.3.8 Working Beryllium Standard Solution, 1 µg Be/ml. Dilute a 10 ml aliquot of the stock beryllium standard solution to 100 ml with 25 percent HCl solution to give a concentration of 1 mg/ml. Prepare this dilute stock solution fresh daily.

#### 8.0 *Sample Collection, Preservation, Transport, and Storage*

The amount of Be that is collected is generally small, therefore, it is necessary to exercise particular care to prevent contamination or loss of sample.

8.1 Pretest Preparation. Same as Method 5, Section 8.1, except omit Section 8.1.3.

8.2 Preliminary Determinations. Same as Method 5, Section 8.2, with the exception of the following:

8.2.1 Select a nozzle size based on the range of velocity heads to assure that it is not necessary to change the nozzle size in order to maintain isokinetic sampling rates below 28 liters/min (1.0 cfm).

8.2.2 Obtain samples over a period or periods of time that accurately determine the maximum emissions that occur in a 24-hour period. In the case of cyclic operations, perform sufficient sample runs for the accurate determination of the emissions that occur over the duration of the cycle. A minimum sample time of 2 hours per run is recommended.

8.3 Preparation of Sampling Train. Same as Method 5, Section 8.3, with the exception of the following:

8.3.1 Prior to assembly, clean all glassware (probe, impingers, and connectors) by first soaking in wash acid for 2 hours, followed by rinsing with water.

8.3.2 Save a portion of the water for a blank analysis.

8.3.3 Procedures relating to the use of metal probe liners are not applicable.

8.3.4 Probe and filter heating systems are needed only if water condensation is a problem. If this is the case, adjust the heaters to provide a temperature at or above the stack temperature. However, membrane filters such as the Millipore AA are limited to about 107 °C (225 °F). If the stack gas is in excess of about 93 °C (200 °F), consideration should be given to an alternate procedure such as moving the filter holder downstream of the first impinger to insure that the filter does not exceed its temperature limit. After the sampling train has been assembled, turn on and set the probe heating system, if applicable, at the desired operating temperature. Allow time for the temperatures to stabilize. Place crushed ice around the impingers.

Note: An empty impinger may be inserted between the third impinger and the silica gel to remove excess moisture from the sample stream.

8.4 Leak Check Procedures, Sampling Train Operation, and Calculation of Percent Isokinetic. Same as Method 5, Sections 8.4, 8.5, and 8.6, respectively.

8.5 Sample Recovery. Same as Method 5, Section 8.7, except treat the sample as follows: Transfer the probe and impinger assembly to a cleanup area that is clean, protected from the wind, and free of Be contamination. Inspect the train before and during this assembly, and note any abnormal conditions. Treat the sample as follows: Disconnect the probe from the impinger train.

8.5.1 Container No. 1. Same as Method 5, Section 8.7.6.1.

8.5.2 Container No. 2. Place the contents (measured to 1 ml) of the first three impingers into a glass sample bottle. Use the procedures outlined in Section 8.7.6.2 of Method 5, where applicable, to rinse the probe nozzle, probe fitting, probe liner, filter holder, and all glassware between the filter holder and the back half of the third impinger with water. Repeat this procedure with acetone. Place both water and acetone rinse solutions in the sample bottle with the contents of the impingers.

8.5.3 Container No. 3. Same as Method 5, Section 8.7.6.3.

8.6 Blanks.

8.6.1 Water Blank. Save a portion of the water as a blank. Take 200 ml directly from the wash bottle being used and place it in a plastic sample container labeled "H<sub>2</sub>O blank."

8.6.2 Filter. Save two filters from each lot of filters used in sampling. Place these filters in a container labeled "filter blank."

8.7 Post-test Glassware Rinsing. If an additional test is desired, the glassware can be carefully double rinsed with water and reassembled. However, if the glassware is out of use more than 2 days, repeat the initial acid wash procedure.

9.0 Quality Control

Section	Quality control measure	Effect
8.4, 10.1	Sampling equipment leak checks and calibration	Ensure accuracy and precision of sampling measurements.
10.2	Spectrophotometer calibration	Ensure linearity of spectrophotometer response to standards.
11.5	Check for matrix effects	Eliminate matrix effects.

*10.0 Calibration and Standardization*

Note: Maintain a laboratory log of all calibrations.

10.1 Sampling Equipment. Same as Method 5, Section 10.0.

10.2 Preparation of Standard Solutions. Pipet 1, 3, 5, 8, and 10 ml of the 1.0 µg Be/ml working standard solution into separate 100 ml volumetric flasks, and dilute to the mark with water. The total amounts of Be in these standards are 1, 3, 5, 8, and 10 µg, respectively.

10.3 Spectrophotometer and Recorder. The Be response may be measured by either peak height or peak area. Analyze an aliquot of the 10-µg standard at 234.8 nm using a nitrous oxide/acetylene flame.

Determine the maximum absorbance of the standard, and set this value to read 90 percent of the recorder full scale.

#### 10.4 Calibration Curve.

10.4.1 After setting the recorder scale, analyze an appropriately sized aliquot of each standard and the BLANK (see Section 11) until two consecutive peaks agree within 3 percent of their average value.

10.4.3 Subtract the average peak height (or peak area) of the blank—which must be less than 2 percent of recorder full scale—from the averaged peak heights of the standards. If the blank absorbance is greater than 2 percent of full-scale, the probable cause is Be contamination of a reagent or carry-over of Be from a previous sample. Prepare the calibration curve by plotting the corrected peak height of each standard solution versus the corresponding total Be weight in the standard (in  $\mu\text{g}$ ).

10.5 Spectrophotometer Calibration Quality Control. Calculate the least squares slope of the calibration curve. The line must pass through the origin or through a point no further from the origin than  $\pm 2$  percent of the recorder full scale. Multiply the corrected peak height by the reciprocal of the least squares slope to determine the distance each calibration point lies from the theoretical calibration line. The difference between the calculated concentration values and the actual concentrations (i.e., 1, 3, 5, 8, and 10  $\mu\text{g}$  Be) must be less than 7 percent for all standards.

### 11.0 Analytical Procedure

11.1 Sample Loss Check. Prior to analysis, check the liquid level in Container No. 2. Note on the analytical data sheet whether leakage occurred during transport. If a noticeable amount of leakage occurred, either void the sample or take steps, subject to the approval of the Administrator, to adjust the final results.

11.2 Glassware Cleaning. Before use, clean all glassware according to the procedure of Section 8.3.1.

11.3 Sample Preparation. The digestion of Be samples is accomplished in part in concentrated  $\text{HClO}_4$ .

Note: The sample must be heated to light brown fumes after the initial  $\text{HNO}_3$  addition; otherwise, dangerous perchlorates may result from the subsequent  $\text{HClO}_4$  digestion.  $\text{HClO}_4$  should be used only under a hood.

11.3.1 Container No. 1. Transfer the filter and any loose particulate matter from Container No. 1 to a 150-ml beaker. Add 35 ml concentrated  $\text{HNO}_3$ . To oxidize all organic matter, heat on a hotplate until light brown fumes are evident. Cool to room temperature, and add 5 ml 12 N  $\text{H}_2\text{SO}_4$  and 5 ml concentrated  $\text{HClO}_4$ .

11.3.2 Container No. 2. Place a portion of the water and acetone sample into a 150 ml beaker, and put on a hotplate. Add portions of the remainder as evaporation proceeds and evaporate to dryness. Cool the residue, and add 35 ml concentrated  $\text{HNO}_3$ . To oxidize all organic matter, heat on a hotplate until light brown fumes are evident. Cool to room temperature, and add 5 ml 12 N  $\text{H}_2\text{SO}_4$  and 5 ml concentrated  $\text{HClO}_4$ . Then proceed with step 11.3.4.

11.3.3 Final Sample Preparation. Add the sample from Section 11.3.2 to the 150-ml beaker from Section 11.3.1. Replace on a hotplate, and evaporate to dryness in a  $\text{HClO}_4$  hood. Cool the residue to room temperature, add 10.0 ml of 25 percent V/V HCl, and mix to dissolve the residue.

11.3.4 Filter and Water Blanks. Cut each filter into strips, and treat each filter individually as directed in Section 11.3.1. Treat the 200-ml water blank as directed in Section 11.3.2. Combine and treat these blanks as directed in Section 11.3.3.

11.4 Spectrophotometer Preparation. Turn on the power; set the wavelength, slit width, and lamp current; and adjust the background corrector as instructed by the manufacturer's manual for the particular atomic absorption spectrophotometer. Adjust the burner and flame characteristics as necessary.

11.5 Analysis. Calibrate the analytical equipment and develop a calibration curve as outlined in Sections 10.4 and 10.5.

11.5.1 Beryllium Samples. Repeat the procedure used to establish the calibration curve with an appropriately sized aliquot of each sample (from Section 11.3.3) until two consecutive peak heights agree within 3 percent of their average value. The peak height of each sample must be greater than 10 percent of the recorder full scale. If the peak height of the sample is off scale on the recorder, further dilute the original source sample to bring the Be concentration into the calibration range of the spectrophotometer.

11.5.2 Run a blank and standard at least after every five samples to check the spectrophotometer calibration. The peak height of the blank must pass through a point no further from the origin than  $\pm 2$  percent of the recorder full scale. The difference between the measured concentration of the standard (the product of the corrected peak height and the reciprocal of the least squares slope) and the actual concentration of the standard must be less than 7 percent, or recalibration of the analyzer is required.

11.5.3 Check for Matrix Effects (optional). Use the Method of Standard Additions (see Reference 2 in Section 17.0) to check at least one sample from each source for matrix effects on the Be results. If the results of the Method of Standard Additions procedure used on the single source sample do not agree to within 5 percent of the value obtained by the routine atomic absorption analysis, then reanalyze all samples from the source using the Method of Standard Additions procedure.

11.6 Container No. 2 (Silica Gel). Weigh the spent silica gel (or silica gel plus impinger) to the nearest 0.5 g using a balance. (This step may be conducted in the field.)

## 12.0 Data Analysis and Calculations

Carry out calculations, retaining at least one extra decimal significant figure beyond that of the acquired data. Round off figures only after the final calculation. Other forms of the equations may be used as long as they give equivalent results.

12.1 Nomenclature.

$K_1 = 0.3858 \text{ } ^\circ\text{K/mm Hg}$  for metric units.

$= 17.64 \text{ } ^\circ\text{R/in. Hg}$  for English units.

$K_3 = 10^{-6}$  g/ $\mu$ g for metric units.

=  $2.2046 \times 10^{-9}$  lb/ $\mu$ g for English units.

$m_{Be}$  = Total weight of beryllium in the source sample.

$P_s$  = Absolute stack gas pressure, mm Hg (in. Hg).

$t$  = Daily operating time, sec/day.

$T_s$  = Absolute average stack gas temperature, °K (°R).

$V_{m(std)}$  = Dry gas sample volume at standard conditions, scm (scf).

$V_{w(std)}$  = Volume of water vapor at standard conditions, scm (scf).

12.2 Average Dry Gas Meter Temperature and Average Orifice Pressure Drop, Dry Gas Volume, Volume of Water Vapor Condensed, Moisture Content, Isokinetic Variation, and Stack Gas Velocity and Volumetric Flow Rate. Same as Method 5, Sections 12.2 through 12.5, 12.11, and 12.12, respectively.

12.3 Total Beryllium. For each source sample, correct the average maximum absorbance of the two consecutive samples whose peak heights agree within 3 percent of their average for the contribution of the solution blank (see Sections 11.3.4 and 11.5.2). Correcting for any dilutions if necessary, use the calibration curve and these corrected averages to determine the total weight of Be in each source sample.

12.4 Beryllium Emission Rate. Calculate the daily Hg emission rate, R, using Equation 104-1. For continuous operations, the operating time is equal to 86,400 seconds per day. For cyclic operations, use only the time per day each stack is in operation. The total Hg emission rate from a source will be the summation of results from all stacks.

$$R = \frac{K_1 K_3 t m_{Be} P_s V_s A_s}{T_s (V_{m(std)} + V_{w(std)})} \quad \text{Eq. 104-1}$$

[View or download PDF](#)

12.5 Determination of Compliance. Each performance test consists of three sample runs. For the purpose of determining compliance with an applicable national emission standard, use the average of the results of all sample runs.

13.0 *Method Performance. [Reserved]*

14.0 *Pollution Prevention. [Reserved]*

15.0 *Waste Management. [Reserved]*

16.0 *Alternative Procedures*

16.1 Inductively Coupled Plasma-Atomic Emission Spectrometry (ICP-AES) Analysis. ICP-AES may be used as an alternative to atomic absorption analysis provided the following conditions are met:



16.1.1 Sample collection, sample preparation, and analytical preparation procedures are as defined in the method except as necessary for the ICP-AES application.

16.1.2 Quality Assurance/Quality Control procedures, including audit material analysis, are conducted as prescribed in the method. The QA acceptance conditions must be met.

16.1.3 The limit of quantitation for the ICP-AES must be demonstrated and the sample concentrations reported should be no less than two times the limit of quantitation. The limit of quantitation is defined as ten times the standard deviation of the blank value. The standard deviation of the blank value is determined from the analysis of seven blanks. It has been reported that for mercury and those elements that form hydrides, a continuous-flow generator coupled to an ICP-AES offers detection limits comparable to cold vapor atomic absorption.

16.2 Inductively Coupled Plasma-Mass Spectrometry (ICP-MS) Analysis. ICP-MS may be used as an alternative to atomic absorption analysis.

16.3 Cold Vapor Atomic Fluorescence Spectrometry (CVAFS) Analysis. CVAFS may be used as an alternative to atomic absorption analysis.

### 17.0 References

Same as References 1, 2, and 4-11 of Section 16.0 of Method 101 with the addition of the following:

1. Amos, M.D., and J.B. Willis. Use of High-Temperature Pre-Mixed Flames in Atomic Absorption Spectroscopy. *Spectrochim. Acta.* 22:1325. 1966.
2. Fleet, B., K.V. Liberty, and T. S. West. A Study of Some Matrix Effects in the Determination of Beryllium by Atomic Absorption Spectroscopy in the Nitrous Oxide-Acetylene Flame. *Talanta* 17:203. 1970.

### 18.0 Tables, Diagrams, Flowcharts, And Validation Data [Reserved]

#### Method 105—Determination of Mercury in Wastewater Treatment Plant Sewage Sludges

Note: This method does not include all of the specifications (*e.g.*, equipment and supplies) and procedures (*e.g.*, sampling and analytical) essential to its performance. Some material is incorporated by reference from other methods in this part. Therefore, to obtain reliable results, persons using this method should also have a thorough knowledge of at least the following additional test methods: Method 101 and Method 101A.

### 1.0 Scope and Application

#### 1.1 Analytes.

Analyte	CAS No.	Sensitivity
Mercury (Hg)	7439-97-6	Dependent upon spectrophotometer and recorder.

1.2 **Applicability.** This method is applicable for the determination of total organic and inorganic Hg content in sewage sludges.

1.3 **Data Quality Objectives.** Adherence to the requirements of this method will enhance the quality of the data obtained from air pollutant sampling methods.

## 2.0 *Summary of Method*

2.1 Time-composite sludge samples are withdrawn from the conveyor belt subsequent to dewatering and before incineration or drying. A weighed portion of the sludge is digested in aqua regia and is oxidized by potassium permanganate (KMnO<sub>4</sub>). Mercury in the digested sample is then measured by the conventional spectrophotometric cold-vapor technique.

## 3.0 *Definitions [Reserved]*

## 4.0 *Interferences [Reserved]*

## 5.0 *Safety*

5.1 **Disclaimer.** This method may involve hazardous materials, operations, and equipment. This test method may not address all of the safety problems associated with its use. It is the responsibility of the user of this test method to establish appropriate safety and health practices and determine the applicability of regulatory limitations prior to performing this test method.

5.2 **Corrosive Reagents.** The following reagents are hazardous. Personal protective equipment and safe procedures are useful in preventing chemical splashes. If contact occurs, immediately flush with copious amounts of water at least 15 minutes. Remove clothing under shower and decontaminate. Treat residual chemical burn as thermal burn.

5.2.1 **Hydrochloric Acid (HCl).** Highly toxic. Vapors are highly irritating to eyes, skin, nose, and lungs, causing severe damage. May cause bronchitis, pneumonia, or edema of lungs. Exposure to concentrations of 0.13 to 0.2 percent can be lethal to humans in a few minutes. Provide ventilation to limit exposure. Reacts with metals, producing hydrogen gas.

5.2.2 **Nitric Acid (HNO<sub>3</sub>).** Highly corrosive to eyes, skin, nose, and lungs. Vapors cause bronchitis, pneumonia, or edema of lungs. Reaction to inhalation may be delayed as long as 30 hours and still be fatal. Provide ventilation to limit exposure. Strong oxidizer. Hazardous reaction may occur with organic materials such as solvents.

## 6.0 *Equipment and Supplies*

6.1 **Sample Collection and Mixing.** The following items are required for collection and mixing of the sludge samples:

6.1.1 **Container.** Plastic, 50-liter.

6.1.2 **Scoop.** To remove 950-ml (1 quart.) sludge sample.

6.1.3 **Mixer.** Mortar mixer, wheelbarrow-type, 57-liter (or equivalent) with electricity-driven motor.

6.1.4 Blender. Waring-type, 2-liter.

6.1.5 Scoop. To remove 100-ml and 20-ml samples of blended sludge.

6.1.6 Erlenmeyer Flasks. Four, 125-ml.

6.1.7 Beakers. Glass beakers in the following sizes: 50 ml (1), 200 ml (1), 400 ml (2).

6.2 Sample Preparation and Analysis. Same as Method 101, Section 6.3, with the addition of the following:

6.2.1 Hot Plate.

6.2.2 Desiccator.

6.2.3 Filter Paper. S and S No. 588 (or equivalent).

6.2.4 Beakers. Glass beakers, 200 ml and 400 ml (2 each).

### 7.0 *Reagents and Standards*

Note: Unless otherwise indicated, it is intended that all reagents conform to the specifications established by the Committee on Analytical Reagents of the American Chemical Society, where such specifications are available; otherwise, use the best available grade.

7.1 Sample Analysis. Same as Method 101A, Section 7.2, with the following additions and exceptions:

7.1.1 Hydrochloric Acid. The concentrated HCl specified in Method 101A, Section 7.2.4, is not required.

7.1.2 Aqua Regia. Prepare immediately before use. Carefully add one volume of concentrated HNO<sub>3</sub> to three volumes of concentrated HCl.

### 8.0 *Sample Collection, Preservation, Storage, and Transport*

8.1 Sludge Sampling. Withdraw equal volume increments of sludge [for a total of at least 15 liters (16 quarts)] at intervals of 30 min over an 8-hr period, and combine in a rigid plastic container.

8.2 Sludge Mixing. Transfer the entire 15-liter sample to a mortar mixer. Mix the sample for a minimum of 30 min at 30 rpm. Take six 100-ml portions of sludge, and combine in a 2-liter blender. Blend sludge for 5 min; add water as necessary to give a fluid consistency. Immediately after stopping the blender, withdraw four 20-ml portions of blended sludge, and place them in separate, tared 125-ml Erlenmeyer flasks. Reweigh each flask to determine the exact amount of sludge added.

8.3 Sample Holding Time. Samples shall be analyzed within the time specified in the applicable subpart of the regulations.

### 9.0 *Quality Control*

Section	Quality control measure	Effect
10.0	Spectrophotometer calibration	Ensure linearity of spectrophotometer response to standards.
11.0	Check for matrix effects	Eliminate matrix effects.

### 10.0 Calibration and Standardization

Same as Method 101A, Section 10.2.

### 11.0 Analytical Procedures

11.1 Solids Content of Blended Sludge. Dry one of the 20-ml blended samples from Section 8.2 in an oven at 105 °C (221 °F) to constant weight. Cool in a desiccator, weigh and record the dry weight of the sample.

11.2 Aqua Regia Digestion of Blended Samples.

11.2.1 To each of the three remaining 20-ml samples from Section 8.2 add 25 ml of aqua regia, and digest the on a hot plate at low heat (do not boil) for 30 min, or until samples are a pale yellow-brown color and are void of the dark brown color characteristic of organic matter. Remove from hotplate and allow to cool.

11.2.2 Filter each digested sample separately through an S and S No. 588 filter or equivalent, and rinse the filter contents with 50 ml of water. Transfer the filtrate and filter washing to a 100-ml volumetric flask, and carefully dilute to volume with water.

11.3 Solids Content of the Sludge Before Blending. Remove two 100-ml portions of mixed sludge from the mortar mixer and place in separate, tared 400-ml beakers. Reweigh each beaker to determine the exact amount of sludge added. Dry in oven at 105 °C (221 °F) and cool in a desiccator to constant weight.

11.4 Analysis for Mercury. Analyze the three aqua regia-digested samples using the procedures outlined in Method 101A, Section 11.0.

### 12.0 Data Analysis and Calculations

12.1 Nomenclature.

$C_m$  = Concentration of Hg in the digested sample,  $\mu\text{g/g}$ .

$F_{sb}$  = Weight fraction of solids in the blended sludge.

$F_{sm}$  = Weight fraction of solids in the collected sludge after mixing.

$M$  = Hg content of the sewage sludge (on a dry basis),  $\mu\text{g/g}$ .

$m$  = Mass of Hg in the aliquot of digested sample analyzed,  $\mu\text{g}$ .

$n$  = number of digested samples (specified in Section 11.2 as three).

$V_a$  = Volume of digested sample analyzed, ml.

$V_s$  = Volume of digested sample, ml.

$W_b$  = Weight of empty sample beaker, g.

$W_{bs}$  = Weight of sample beaker and sample, g.

$W_{bd}$  = Weight of sample beaker and sample after drying, g.

$W_f$  = Weight of empty sample flask, g.

$W_{fd}$  = Weight of sample flask and sample after drying, g.

$W_{fs}$  = Weight of sample flask and sample, g.

## 12.2 Mercury Content of Digested Sample (Wet Basis).

12.2.1 For each sample analyzed for Hg content, calculate the arithmetic mean maximum absorbance of the two consecutive samples whose peak heights agree  $\pm 3$  percent of their average. Correct this average value for the contribution of the blank. Use the calibration curve and these corrected averages to determine the final Hg concentration in the solution cell for each sludge sample.

12.2.2 Calculate the average Hg concentration of the digested samples by correcting for any dilutions made to bring the sample into the working range of the spectrophotometer and for the weight of the sludge portion digested, using Equation 105-1.

$$\bar{C}_m = \sum_{i=1}^n \left[ \frac{mV_s}{V_a(W_{fs} - W_f)} \right]_i \quad \text{Eq. 105-1}$$

[View or download PDF](#)

12.3 Solids Content of Blended Sludge. Determine the solids content of the blended sludge using Equation 105-2.

$$F_{sb} = 1 - \frac{W_{fs} - W_{fd}}{W_{fs} - W_f} \quad \text{Eq. 105-2}$$

[View or download PDF](#)

12.4 Solids Content of Bulk Sample (before blending but, after mixing in mortar mixer). Determine the solids content of each 100 ml aliquot (Section 11.3), and average the results.

$$F_{sm} = 1 - \frac{W_{bs} - W_{bd}}{W_{bs} - W_b} \quad \text{Eq. 105-3}$$

[View or download PDF](#)

12.5 Mercury Content of Bulk Sample (Dry Basis). Average the results from the three samples from each 8-hr composite sample, and calculate the Hg concentration of the composite sample on a dry basis.

$$M = \frac{\bar{C}_m}{F_{sb}} \quad \text{Eq. 105-4}$$

[View or download PDF](#)

### 13.0 Method Performance

13.1 Range. The range of this method is 0.2 to 5 micrograms per gram; it may be extended by increasing or decreasing sample size.

14.0 Pollution Prevention. [Reserved]

15.0 Waste Management. [Reserved]

### 16.0 References

1. Bishop, J.N. Mercury in Sediments. Ontario Water Resources Commission. Toronto, Ontario, Canada. 1971.
2. Salma, M. Private Communication. EPA California/Nevada Basin Office. Alameda, California.
3. Hatch, W.R. and W.L. Ott. Determination of Sub-Microgram Quantities of Mercury by Atomic Absorption Spectrophotometry. Analytical Chemistry. 40:2085. 1968.
4. Bradenberger, H., and H. Bader. The Determination of Nanogram Levels of Mercury in Solution by a Flameless Atomic Absorption Technique. Atomic Absorption Newsletter. 6:101. 1967.
5. Analytical Quality Control Laboratory (AQCL). Mercury in Sediment (Cold Vapor Technique) (Provisional Method). U.S. Environmental Protection Agency. Cincinnati, Ohio. April 1972.
6. Kopp, J.F., M.C. Longbottom, and L.B. Lobring. "Cold Vapor" Method for Determining Mercury. Journal AWWA. 64(1):20-25. 1972.
7. Manual of Methods for Chemical Analysis of Water and Wastes. U.S. Environmental Protection Agency. Cincinnati, Ohio. Publication No. EPA-624/2-74-003. December 1974. pp. 118-138.
8. Mitchell, W.J., M.R. Midgett, J. Suggs, R.J. Velton, and D. Albrink. Sampling and Homogenizing Sewage for Analysis. Environmental Monitoring and Support Laboratory, Office of Research and Development, U.S. Environmental Protection Agency. Research Triangle Park, N.C. March 1979. p. 7.

17.0 Tables, Diagrams, Flowcharts, and Validation Data. [Reserved]

## Method 106—Determination of Vinyl Chloride Emissions From Stationary Sources

### 1.0 Scope and Application

#### 1.1 Analytes.

Analyte	CAS No.	Sensitivity

Vinyl Chloride (CH <sub>2</sub> :CHCl)	75-01-4	Dependent upon analytical equipment.
--	---------	--------------------------------------

1.2 **Applicability.** This method is applicable for the determination of vinyl chloride emissions from ethylene dichloride, vinyl chloride, and polyvinyl chloride manufacturing processes. This method does not measure vinyl chloride contained in particulate matter.

1.3 **Data Quality Objectives.** Adherence to the requirements of this method will enhance the quality of the data obtained from air pollutant sampling methods.

## 2.0 *Summary of Method*

2.1 An integrated bag sample of stack gas containing vinyl chloride is subjected to GC analysis using a flame ionization detector (FID).

## 3.0 *Definitions. [Reserved]*

## 4.0 *Interferences*

4.1 Resolution interferences of vinyl chloride may be encountered on some sources. Therefore, the chromatograph operator should select the column and operating parameters best suited to the particular analysis requirements. The selection made is subject to approval of the Administrator. Approval is automatic, provided that confirming data are produced through an adequate supplemental analytical technique, and that the data are available for review by the Administrator. An example of this would be analysis with a different column or GC/mass spectroscopy.

## 5.0 *Safety*

5.1 **Disclaimer.** This method may involve hazardous materials, operations, and equipment. This test method may not address all of the safety problems associated with its use. It is the responsibility of the user of this test method to establish appropriate safety and health practices and determine the applicability of regulatory limitations prior to performing this test method.

5.2 **Toxic Analyte.** Care must be exercised to prevent exposure of sampling personnel to vinyl chloride, which is a carcinogen.

## 6.0 *Equipment and Supplies*

6.1 **Sample Collection** (see Figure 106-1). The sampling train consists of the following components:

6.1.1 **Probe.** Stainless steel, borosilicate glass, Teflon tubing (as stack temperature permits), or equivalent, equipped with a glass wool plug to remove particulate matter.

6.1.2 **Sample Lines.** Teflon, 6.4-mm outside diameter, of sufficient length to connect probe to bag. Use a new unused piece for each series of bag samples that constitutes an emission test, and discard upon completion of the test.

6.1.3 **Quick Connects.** Stainless steel, male (2) and female (2), with ball checks (one pair without), located as shown in Figure 106-1.

6.1.4 Tedlar Bags. 50- to 100-liter capacity, to contain sample. Aluminized Mylar bags may be used if the samples are analyzed within 24 hours of collection.

6.1.5 Bag Containers. Rigid leak-proof containers for sample bags, with covering to protect contents from sunlight.

6.1.6 Needle Valve. To adjust sample flow rates.

6.1.7 Pump. Leak-free, with minimum of 2-liter/min capacity.

6.1.8 Charcoal Tube. To prevent admission of vinyl chloride and other organics to the atmosphere in the vicinity of samplers.

6.1.9 Flowmeter. For observing sampling flow rate; capable of measuring a flow range from 0.10 to 1.00 liter/min.

6.1.10 Connecting Tubing. Teflon, 6.4-mm outside diameter, to assemble sampling train (Figure 106-1).

6.1.11 Tubing Fittings and Connectors. Teflon or stainless steel, to assemble sampling training.

6.2 Sample Recovery. Teflon tubing, 6.4-mm outside diameter, to connect bag to GC sample loop. Use a new unused piece for each series of bag samples that constitutes an emission test, and discard upon conclusion of analysis of those bags.

6.3 Analysis. The following equipment is required:

6.3.1 Gas Chromatograph. With FID potentiometric strip chart recorder and 1.0 to 5.0-ml heated sampling loop in automatic sample valve. The chromatographic system shall be capable of producing a response to 0.1-ppmv vinyl chloride that is at least as great as the average noise level. (Response is measured from the average value of the base line to the maximum of the wave form, while standard operating conditions are in use.)

6.3.2 Chromatographic Columns. Columns as listed below. Other columns may be used provided that the precision and accuracy of the analysis of vinyl chloride standards are not impaired and that information is available for review confirming that there is adequate resolution of vinyl chloride peak. (Adequate resolution is defined as an area overlap of not more than 10 percent of the vinyl chloride peak by an interferent peak. Calculation of area overlap is explained in Procedure 1 of appendix C to this part: "Determination of Adequate Chromatographic Peak Resolution.")

6.3.2.1 Column A. Stainless steel, 2.0 m by 3.2 mm, containing 80/100-mesh Chromasorb 102.

6.3.2.2 Column B. Stainless steel, 2.0 m by 3.2 mm, containing 20 percent GE SF-96 on 60/100-mesh Chromasorb P AW; or stainless steel, 1.0 m by 3.2 mm containing 80/100-mesh Porapak T. Column B is required as a secondary column if acetaldehyde is present. If used, column B is placed after column A. The combined columns should be operated at 120 °C (250 °F).

6.3.3 Rate Meters (2). Rotameter , or equivalent, 100-ml/min capacity, with flow control valves.

6.3.4 Gas Regulators. For required gas cylinders.



6.3.5 Temperature Sensor. Accurate to  $\pm 1$  °C ( $\pm 2$  °F), to measure temperature of heated sample loop at time of sample injection.

6.3.6 Barometer. Accurate to  $\pm 5$  mm Hg, to measure atmospheric pressure around GC during sample analysis.

6.3.7 Pump. Leak-free, with minimum of 100-ml/min capacity.

6.3.8 Recorder. Strip chart type, optionally equipped with either disc or electronic integrator.

6.3.9 Planimeter. Optional, in place of disc or electronic integrator on recorder, to measure chromatograph peak areas.

#### 6.4 Calibration and Standardization.

6.4.1 Tubing. Teflon, 6.4-mm outside diameter, separate pieces marked for each calibration concentration.

Note: The following items are required only if the optional standard gas preparation procedures (Section 10.1) are followed.

6.4.2 Tedlar Bags. Sixteen-inch-square size, with valve; separate bag marked for each calibration concentration.

6.4.3 Syringes. 0.5-ml and 50- $\mu$ l, gas tight, individually calibrated to dispense gaseous vinyl chloride.

6.4.4 Dry Gas Meter with Temperature and Pressure Gauges. Singer Model DTM-115 with 802 index, or equivalent, to meter nitrogen in preparation of standard gas mixtures, calibrated at the flow rate used to prepare standards.

#### 7.0 Reagents and Standards

7.1 Analysis. The following reagents are required for analysis.

7.1.1 Helium or Nitrogen. Purity 99.9995 percent or greater, for chromatographic carrier gas.

7.1.2 Hydrogen. Purity 99.9995 percent or greater.

7.1.3 Oxygen or Air. Either oxygen (purity 99.99 percent or greater) or air (less than 0.1 ppmv total hydrocarbon content), as required by detector.

7.2 Calibration. Use one of the following options: either Sections 7.2.1 and 7.2.2, or Section 7.2.3.

7.2.1 Vinyl Chloride. Pure vinyl chloride gas certified by the manufacturer to contain a minimum of 99.9 percent vinyl chloride. If the gas manufacturer maintains a bulk cylinder supply of 99.9 + percent vinyl chloride, the certification analysis may have been performed on this supply, rather than on each gas cylinder prepared from this bulk supply. The date of gas cylinder preparation and the certified analysis must have been affixed to the cylinder before shipment from the gas manufacturer to the buyer.

7.2.2 Nitrogen. Same as described in Section 7.1.1.

7.2.3 Cylinder Standards. Gas mixture standards (50-, 10-, and 5 ppmv vinyl chloride) in nitrogen cylinders may be used to directly prepare a chromatograph calibration curve as described in Section 10.3 if the following conditions are met: (a) The manufacturer certifies the gas composition with an accuracy of  $\pm 3$  percent or better. (b) The manufacturer recommends a maximum shelf life over which the gas concentration does not change by greater than  $\pm 5$  percent from the certified value. (c) The manufacturer affixes the date of gas cylinder preparation, certified vinyl chloride concentration, and recommended maximum shelf to the cylinder before shipment to the buyer.

7.2.3.1 Cylinder Standards Certification. The manufacturer shall certify the concentration of vinyl chloride in nitrogen in each cylinder by (a) directly analyzing each cylinder and (b) calibrating his analytical procedure on the day of cylinder analysis. To calibrate his analytical procedure, the manufacturer shall use as a minimum, a three point calibration curve. It is recommended that the manufacturer maintain (1) a high concentration calibration standard (between 50 and 100 ppmv) to prepare his calibration curve by an appropriate dilution technique and (2) a low-concentration calibration standard (between 5 and 10 ppmv) to verify the dilution technique used. If the difference between the apparent concentration read from the calibration curve and the true concentration assigned to the low-concentration calibration standard exceeds 5 percent of the true concentration, the manufacturer shall determine the source of error and correct it, then repeat the three-point calibration.

7.2.3.2 Verification of Manufacturer's Calibration Standards. Before using a standard, the manufacturer shall verify each calibration standard (a) by comparing it to gas mixtures prepared (with 99 mole percent vinyl chloride) in accordance with the procedure described in Section 7.2.1 or (b) calibrating it against vinyl chloride cylinder Standard Reference Materials (SRM's) prepared by the National Institute of Standards and Technology, if such SRM's are available. The agreement between the initially determined concentration value and the verification concentration value must be  $\pm 5$  percent. The manufacturer must reverify all calibration standards on a time interval consistent with the shelf life of the cylinder standards sold.

## 8.0 *Sample Collection, Preservation, Storage, and Transport*

Note: Performance of this method should not be attempted by persons unfamiliar with the operation of a gas chromatograph (GC) nor by those who are unfamiliar with source sampling, because knowledge beyond the scope of this presentation is required.

8.1 Bag Leak-Check. The following leak-check procedure is recommended, but not required, prior to sample collection. The post-test leak-check procedure is mandatory. Connect a water manometer and pressurize the bag to 5 to 10 cm H<sub>2</sub>O (2 to 4 in. H<sub>2</sub>O). Allow to stand for 10 min. Any displacement in the water manometer indicates a leak. Also, check the rigid container for leaks in this manner.

Note: An alternative leak-check method is to pressurize the bag to 5 to 10 cm H<sub>2</sub>O and allow it to stand overnight. A deflated bag indicates a leak. For each sample bag in its rigid container, place a rotameter in line between the bag and the pump inlet. Evacuate the bag. Failure of the rotameter to register zero flow when the bag appears to be empty indicates a leak.

8.2 Sample Collection. Assemble the sample train as shown in Figure 106-1. Join the quick connects as illustrated, and determine that all connection between the bag and the probe are tight. Place the end of the

probe at the centroid of the stack and start the pump with the needle valve adjusted to yield a flow that will fill over 50 percent of bag volume in the specific sample period. After allowing sufficient time to purge the line several times, change the vacuum line from the container to the bag and evacuate the bag until the rotameter indicates no flow. Then reposition the sample and vacuum lines and begin the actual sampling, keeping the rate proportional to the stack velocity. At all times, direct the gas exiting the rotameter away from sampling personnel. At the end of the sample period, shut off the pump, disconnect the sample line from the bag, and disconnect the vacuum line from the bag container. Protect the bag container from sunlight.

8.3 Sample Storage. Keep the sample bags out of direct sunlight. When at all possible, analysis is to be performed within 24 hours, but in no case in excess of 72 hours of sample collection. Aluminized Mylar bag samples must be analyzed within 24 hours.

8.4 Post-test Bag Leak-Check. Subsequent to recovery and analysis of the sample, leak-check the sample bag according to the procedure outlined in Section 8.1.

## 9.0 Quality Control

Section	Quality control measure	Effect
10.3	Chromatograph calibration	Ensure precision and accuracy of chromatograph.

### 10.0 Calibration and Standardization

Note: Maintain a laboratory log of all calibrations.

10.1 Preparation of Vinyl Chloride Standard Gas Mixtures. (Optional Procedure-delete if cylinder standards are used.) Evacuate a 16-inch square Tedlar bag that has passed a leak-check (described in Section 8.1) and meter in 5.0 liters of nitrogen. While the bag is filling, use the 0.5-ml syringe to inject 250  $\mu$ l of 99.9 + percent vinyl chloride gas through the wall of the bag. Upon withdrawing the syringe, immediately cover the resulting hole with a piece of adhesive tape. The bag now contains a vinyl chloride concentration of 50 ppmv. In a like manner use the 50  $\mu$ l syringe to prepare gas mixtures having 10- and 5-ppmv vinyl chloride concentrations. Place each bag on a smooth surface and alternately depress opposite sides of the bag 50 times to further mix the gases. These gas mixture standards may be used for 10 days from the date of preparation, after which time new gas mixtures must be prepared. (Caution: Contamination may be a problem when a bag is reused if the new gas mixture standard is a lower concentration than the previous gas mixture standard.)

10.2 Determination of Vinyl Chloride Retention Time. (This section can be performed simultaneously with Section 10.3.) Establish chromatograph conditions identical with those in Section 11.3. Determine proper attenuator position. Flush the sampling loop with helium or nitrogen and activate the sample valve. Record the injection time, sample loop temperature, column temperature, carrier gas flow rate, chart speed, and attenuator setting. Record peaks and detector responses that occur in the absence of vinyl chloride. Maintain conditions with the equipment plumbing arranged identically to Section 11.2, and flush the sample loop for 30 seconds at the rate of 100 ml/min with one of the vinyl chloride calibration mixtures. Then activate the sample valve. Record the injection time. Select the peak that corresponds to

vinyl chloride. Measure the distance on the chart from the injection time to the time at which the peak maximum occurs. This quantity divided by the chart speed is defined as the retention time. Since other organics may be present in the sample, positive identification of the vinyl chloride peak must be made.

10.3 Preparation of Chromatograph Calibration Curve. Make a GC measurement of each gas mixture standard (described in Section 7.2.3 or 10.1) using conditions identical to those listed in Sections 11.2 and 11.3. Flush the sampling loop for 30 seconds at the rate of 100 ml/min with one of the standard mixtures, and activate the sample valve. Record the concentration of vinyl chloride injected ( $C_c$ ), attenuator setting, chart speed, peak area, sample loop temperature, column temperature, carrier gas flow rate, and retention time. Record the barometric pressure. Calculate  $A_c$ , the peak area multiplied by the attenuator setting. Repeat until two consecutive injection areas are within 5 percent, then plot the average of those two values versus  $C_c$ . When the other standard gas mixtures have been similarly analyzed and plotted, draw a straight line through the points derived by the least squares method. Perform calibration daily, or before and after the analysis of each emission test set of bag samples, whichever is more frequent. For each group of sample analyses, use the average of the two calibration curves which bracket that group to determine the respective sample concentrations. If the two calibration curves differ by more than 5 percent from their mean value, then report the final results by both calibration curves.

#### 11.0 Analytical Procedure

11.2 Sample Recovery. With a new piece of Teflon tubing identified for that bag, connect a bag inlet valve to the gas chromatograph sample valve. Switch the valve to receive gas from the bag through the sample loop. Arrange the equipment so the sample gas passes from the sample valve to 100-ml/min rotameter with flow control valve followed by a charcoal tube and a 1-in.  $H_2O$  pressure gauge. Maintain the sample flow either by a vacuum pump or container pressurization if the collection bag remains in the rigid container. After sample loop purging is ceased, allow the pressure gauge to return to zero before activating the gas sampling valve.

#### 11.3 Analysis.

11.3.1 Set the column temperature to 100 °C (210 °F) and the detector temperature to 150 °C (300 °F). When optimum hydrogen and oxygen (or air) flow rates have been determined, verify and maintain these flow rates during all chromatography operations. Using helium or nitrogen as the carrier gas, establish a flow rate in the range consistent with the manufacturer's requirements for satisfactory detector operation. A flow rate of approximately 40 ml/min should produce adequate separations. Observe the base line periodically and determine that the noise level has stabilized and that base line drift has ceased. Purge the sample loop for 30 seconds at the rate of 100 ml/min, shut off flow, allow the sample loop pressure to reach atmospheric pressure as indicated by the  $H_2O$  manometer, then activate the sample valve. Record the injection time (the position of the pen on the chart at the time of sample injection), sample number, sample loop temperature, column temperature, carrier gas flow rate, chart speed, and attenuator setting. Record the barometric pressure. From the chart, note the peak having the retention time corresponding to vinyl chloride as determined in Section 10.2. Measure the vinyl chloride peak area,  $A_m$ , by use of a disc integrator, electronic integrator, or a planimeter. Measure and record the peak heights,  $H_m$ . Record  $A_m$  and retention time. Repeat the injection at least two times or until two consecutive values for the total area of the vinyl chloride peak agree within 5 percent of their average. Use the average value for these two total areas to compute the bag concentration.

11.3.2 Compare the ratio of  $H_m$  to  $A_m$  for the vinyl chloride sample with the same ratio for the standard peak that is closest in height. If these ratios differ by more than 10 percent, the vinyl chloride peak may not be pure (possibly acetaldehyde is present) and the secondary column should be employed (see Section 6.3.2.2).

11.4 Determination of Bag Water Vapor Content. Measure the ambient temperature and barometric pressure near the bag. From a water saturation vapor pressure table, determine and record the water vapor content of the bag,  $B_{wb}$ , as a decimal figure. (Assume the relative humidity to be 100 percent unless a lesser value is known.)

## 12.0 Calculations and Data Analysis

### 12.1 Nomenclature.

$A_m$  = Measured peak area.

$A_f$  = Attenuation factor.

$B_{wb}$  = Water vapor content of the bag sample, as analyzed, volume fraction.

$C_b$  = Concentration of vinyl chloride in the bag, ppmv.

$C_c$  = Concentration of vinyl chloride in the standard sample, ppmv.

$P_i$  = Laboratory pressure at time of analysis, mm Hg.

$P_r$  = Reference pressure, the laboratory pressure recorded during calibration, mm Hg.

$T_i$  = Absolute sample loop temperature at the time of analysis, °K (°R).

$T_r$  = Reference temperature, the sample loop temperature recorded during calibration, °K (°R).

12.2 Sample Peak Area. Determine the sample peak area,  $A_c$ , as follows:

$$A_c = A_m A_f \quad \text{Eq. 106-1}$$

[View or download PDF](#)

12.3 Vinyl Chloride Concentration. From the calibration curves prepared in Section 10.3, determine the average concentration value of vinyl chloride,  $C_c$ , that corresponds to  $A_c$ , the sample peak area. Calculate the concentration of vinyl chloride in the bag,  $C_b$ , as follows:

$$C_b = \frac{C_c P_r T_i}{P_i T_r (1 - B_{wb})} \quad \text{Eq. 106-2}$$

[View or download PDF](#)

## 13.0 Method Performance

13.1 Analytical Range. This method is designed for the 0.1 to 50 parts per million by volume (ppmv) range. However, common gas chromatograph (GC) instruments are capable of detecting 0.02 ppmv vinyl chloride. With proper calibration, the upper limit may be extended as needed.

*14.0 Pollution Prevention, [Reserved]*

*15.0 Waste Management, [Reserved]*

*16.0 References*

1. Brown D.W., E.W. Loy, and M.H. Stephenson. Vinyl Chloride Monitoring Near the B. F. Goodrich Chemical Company in Louisville, KY. Region IV, U.S. Environmental Protection Agency, Surveillance and Analysis Division, Athens, GA. June 24, 1974.
2. G.D. Clayton and Associates. Evaluation of a Collection and Analytical Procedure for Vinyl Chloride in Air. U.S. Environmental Protection Agency, Research Triangle Park, N.C. EPA Contract No. 68-02-1408, Task Order No. 2, EPA Report No. 75-VCL-1. December 13, 1974.
3. Midwest Research Institute. Standardization of Stationary Source Emission Method for Vinyl Chloride. U.S. Environmental Protection Agency, Research Triangle Park, N.C. Publication No. EPA-600/4-77-026. May 1977.
4. Scheil, G. and M.C. Sharp. Collaborative Testing of EPA Method 106 (Vinyl Chloride) that Will Provide for a Standardized Stationary Source Emission Measurement Method. U.S. Environmental Protection Agency, Research Triangle Park, N.C. Publication No. EPA 600/4-78-058. October 1978.

*17.0 Tables, Diagrams Flowcharts, and Validation Data.*

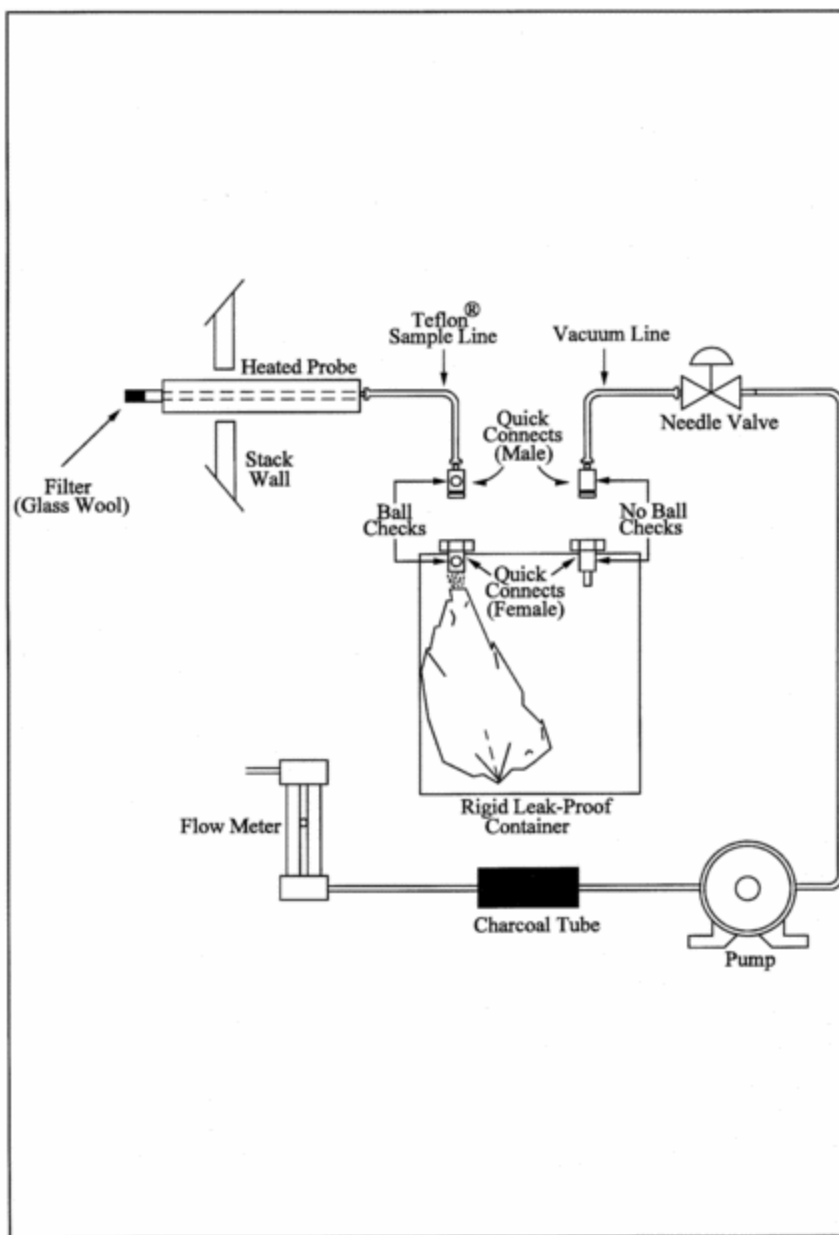

Figure 106-1. Integrated-bag sampling train.

[View or download PDF](#)

Method 107—Determination of Vinyl Chloride Content of In-Process Wastewater Samples, and Vinyl Chloride Content of Polyvinyl Chloride Resin Slurry, Wet Cake, and Latex Samples

Note: Performance of this method should not be attempted by persons unfamiliar with the operation of a gas chromatograph (GC) nor by those who are unfamiliar with source sampling, because knowledge beyond the scope of this presentation is required. This method does not include all of the specifications (*e.g.*, equipment and supplies) and procedures (*e.g.*, sampling and analytical) essential to its performance. Some material is incorporated by reference from other methods in this part. Therefore, to obtain reliable

results, persons using this method should have a thorough knowledge of at least the following additional test methods: Method 106.

### 1.0 Scope and Application

#### 1.1 Analytes.

Analyte	CAS No.	Sensitivity
Vinyl Chloride (CH <sub>2</sub> :CHCl)	75-01-4	Dependent upon analytical equipment.

1.2 Applicability. This method is applicable for the determination of the vinyl chloride monomer (VCM) content of in-process wastewater samples, and the residual vinyl chloride monomer (RVCM) content of polyvinyl chloride (PVC) resins, wet, cake, slurry, and latex samples. It cannot be used for polymer in fused forms, such as sheet or cubes. This method is not acceptable where methods from section 304(h) of the Clean Water Act, 33 U.S.C. 1251 *et seq.* (the Federal Water Pollution Control Amendments of 1972 as amended by the Clean Water Act of 1977) are required.

1.3 Data Quality Objectives. Adherence to the requirements of this method will enhance the quality of the data obtained from air pollutant sampling methods.

### 2.0 Summary of Method

2.1 The basis for this method relates to the vapor equilibrium that is established at a constant known temperature in a closed system between RVCM, PVC resin, water, and air. The RVCM in a PVC resin will equilibrate rapidly in a closed vessel, provided that the temperature of the PVC resin is maintained above the glass transition temperature of that specific resin.

2.2 A sample of PVC or in-process wastewater is collected in a vial or bottle and is conditioned. The headspace in the vial or bottle is then analyzed for vinyl chloride using gas chromatography with a flame ionization detector.

### 3.0 Definitions [Reserved]

### 4.0 Interferences

4.1 The chromatograph columns and the corresponding operating parameters herein described normally provide an adequate resolution of vinyl chloride; however, resolution interferences may be encountered on some sources. Therefore, the chromatograph operator shall select the column and operating parameters best suited to his particular analysis requirements, subject to the approval of the Administrator. Approval is automatic provided that confirming data are produced through an adequate supplemental analytical technique, such as analysis with a different column or GC/mass spectroscopy, and that these data are made available for review by the Administrator.

### 5.0 Safety



5.1 Disclaimer. This method may involve hazardous materials, operations, and equipment. This test method may not address all of the safety problems associated with its use. It is the responsibility of the user of this test method to establish appropriate safety and health practices and determine the applicability of regulatory limitations prior to performing this test method.

5.2 Toxic Analyte. Care must be exercised to prevent exposure of sampling personnel to vinyl chloride, which is a carcinogen. Do not release vinyl chloride to the laboratory atmosphere during preparation of standards. Venting or purging with VCM/air mixtures must be held to a minimum. When they are required, the vapor must be routed to outside air. Vinyl chloride, even at low ppm levels, must never be vented inside the laboratory. After vials have been analyzed, the gas must be vented prior to removal of the vial from the instrument turntable. Vials must be vented through a hypodermic needle connected to an activated charcoal tube to prevent release of vinyl chloride into the laboratory atmosphere. The charcoal must be replaced prior to vinyl chloride breakthrough.

## 6.0 *Equipment and Supplies*

6.1 Sample Collection. The following equipment is required:

6.1.1 Glass bottles. 60-ml (2-oz) capacity, with wax-lined screw-on tops, for PVC samples.

6.1.2 Glass Vials. Headspace vials, with Teflon-faced butyl rubber sealing discs, for water samples.

6.1.3 Adhesive Tape. To prevent loosening of bottle tops.

6.2 Sample Recovery. The following equipment is required:

6.2.1 Glass Vials. Headspace vials, with butyl rubber septa and aluminum caps. Silicone rubber is not acceptable.

6.2.2 Analytical Balance. Capable of determining sample weight within an accuracy of  $\pm 1$  percent.

6.2.3 Vial Sealer. To seal headspace vials.

6.2.4 Syringe. 100-ml capacity.

6.3 Analysis. The following equipment is required:

6.3.1 Headspace Sampler and Chromatograph. Capable of sampling and analyzing a constant amount of headspace gas from a sealed vial, while maintaining that vial at a temperature of  $90\text{ }^{\circ}\text{C} \pm 0.5\text{ }^{\circ}\text{C}$  ( $194\text{ }^{\circ}\text{F} \pm 0.9\text{ }^{\circ}\text{F}$ ). The chromatograph shall be equipped with a flame ionization detector (FID). Perkin-Elmer Corporation Models F-40, F-42, F-45, HS-6, and HS-100, and Hewlett-Packard Corporation Model 19395A have been found satisfactory. Chromatograph backflush capability may be required.

6.3.2 Chromatographic Columns. Stainless steel 1 m by 3.2 mm and 2 m by 3.2 mm, both containing 50/80-mesh Porapak Q. Other columns may be used provided that the precision and accuracy of the analysis of vinyl chloride standards are not impaired and information confirming that there is adequate resolution of the vinyl chloride peak are available for review. (Adequate resolution is defined as an area overlap of not more than 10 percent of the vinyl chloride peak by an interferant peak. Calculation of area overlap is explained in Procedure 1 of appendix C to this part: "Determination of Adequate

Chromatographic Peak Resolution.”) Two 1.83 m columns, each containing 1 percent Carbowax 1500 on Carbopak B, have been found satisfactory for samples containing acetaldehyde.

6.3.3 Temperature Sensor. Range 0 to 100 °C (32 to 212 °F) accurate to 0.1 °C.

6.3.4 Integrator-Recorder. To record chromatograms.

6.3.5 Barometer. Accurate to 1 mm Hg.

6.3.6 Regulators. For required gas cylinders.

6.3.7 Headspace Vial Pre-Pressurizer. Nitrogen pressurized hypodermic needle inside protective shield.

## 7.0 *Reagents and Standards*

7.1 Analysis. Same as Method 106, Section 7.1, with the addition of the following:

7.1.1 Water. Interference-free.

7.2 Calibration. The following items are required for calibration:

7.2.1 Cylinder Standards (4). Gas mixture standards (50-, 500-, 2000- and 4000-ppm vinyl chloride in nitrogen cylinders). Cylinder standards may be used directly to prepare a chromatograph calibration curve as described in Section 10.3, if the following conditions are met: (a) The manufacturer certifies the gas composition with an accuracy of  $\pm 3$  percent or better (see Section 7.2.1.1). (b) The manufacturer recommends a maximum shelf life over which the gas concentration does not change by greater than  $\pm 5$  percent from the certified value. (c) The manufacturer affixes the date of gas cylinder preparation, certified vinyl chloride concentration, and recommended maximum shelf life to the cylinder before shipment to the buyer.

7.2.1.1 Cylinder Standards Certification. The manufacturer shall certify the concentration of vinyl chloride in nitrogen in each cylinder by (a) directly analyzing each cylinder and (b) calibrating the analytical procedure on the day of cylinder analysis. To calibrate the analytical procedure, the manufacturer shall use, as a minimum, a 3-point calibration curve. It is recommended that the manufacturer maintain (1) a high-concentration calibration standard (between 4000 and 8000 ppm) to prepare the calibration curve by an appropriate dilution technique and (2) a low-concentration calibration standard (between 50 and 500 ppm) to verify the dilution technique used. If the difference between the apparent concentration read from the calibration curve and the true concentration assigned to the low-concentration calibration standard exceeds 5 percent of the true concentration, the manufacturer shall determine the source of error and correct it, then repeat the 3-point calibration.

7.2.1.2 Verification of Manufacturer's Calibration Standards. Before using, the manufacturer shall verify each calibration standard by (a) comparing it to gas mixtures prepared (with 99 mole percent vinyl chloride) in accordance with the procedure described in Section 10.1 of Method 106 or by (b) calibrating it against vinyl chloride cylinder Standard Reference Materials (SRMs) prepared by the National Institute of Standards and Technology, if such SRMs are available. The agreement between the initially determined concentration value and the verification concentration value must be within 5 percent. The

manufacturer must reverify all calibration standards on a time interval consistent with the shelf life of the cylinder standards sold.

## 8.0 Sample Collection, Preservation, Storage, and Transport

### 8.1 Sample Collection.

8.1.1 PVC Sampling. Allow the resin or slurry to flow from a tap on the tank or silo until the tap line has been well purged. Extend and fill a 60-ml sample bottle under the tap, and immediately tighten a cap on the bottle. Wrap adhesive tape around the cap and bottle to prevent the cap from loosening. Place an identifying label on each bottle, and record the date, time, and sample location both on the bottles and in a log book.

8.1.2 Water Sampling. At the sampling location fill the vials bubble-free to overflowing so that a convex meniscus forms at the top. The excess water is displaced as the sealing disc is carefully placed, with the Teflon side down, on the opening of the vial. Place the aluminum seal over the disc and the neck of the vial, and crimp into place. Affix an identifying label on the bottle, and record the date, time, and sample location both on the vials and in a log book.

8.2 Sample Storage. All samples must be analyzed within 24 hours of collection, and must be refrigerated during this period.

## 9.0 Quality Control

Section	Quality control measure	Effect
10.3	Chromatograph calibration	Ensure precision and accuracy of chromatograph.

## 10.0 Calibration and Standardization

Note: Maintain a laboratory log of all calibrations.

10.1 Preparation of Standards. Calibration standards are prepared as follows: Place 100 µl or about two equal drops of distilled water in the sample vial, then fill the vial with the VCM/nitrogen standard, rapidly seat the septum, and seal with the aluminum cap. Use a 1/8 -in. stainless steel line from the cylinder to the vial. Do not use rubber or Tygon tubing. The sample line from the cylinder must be purged (into a properly vented hood) for several minutes prior to filling the vials. After purging, reduce the flow rate to between 500 and 1000 cc/min. Place end of tubing into vial (near bottom). Position a septum on top of the vial, pressing it against the 1/8 -in. filling tube to minimize the size of the vent opening. This is necessary to minimize mixing air with the standard in the vial. Each vial is to be purged with standard for 90 seconds, during which time the filling tube is gradually slid to the top of the vial. After the 90 seconds, the tube is removed with the septum, simultaneously sealing the vial. Practice will be necessary to develop good technique. Rubber gloves should be worn during the above operations. The sealed vial must then be pressurized for 60 seconds using the vial prepressurizer. Test the vial for leakage by placing a drop of water on the septum at the needle hole. Prepressurization of standards is not required unless samples have been prepressurized.

10.2 Analyzer Calibration. Calibration is to be performed each 8-hour period the chromatograph is used. Alternatively, calibration with duplicate 50-, 500-, 2,000-, and 4,000-ppm standards (hereafter described as a four-point calibration) may be performed on a monthly basis, provided that a calibration confirmation test consisting of duplicate analyses of an appropriate standard is performed once per plant shift, or once per chromatograph carousel operation (if the chromatograph operation is less frequent than once per shift). The criterion for acceptance of each calibration confirmation test is that both analyses of 500-ppm standards [2,000-ppm standards if dispersion resin (excluding latex resin) samples are being analyzed] must be within 5 percent of the most recent four-point calibration curve. If this criterion is not met, then a complete four-point calibration must be performed before sample analyses can proceed.

10.3 Preparation of Chromatograph Calibration Curve. Prepare two vials each of 50-, 500-, 2,000-, and 4,000-ppm standards. Run the calibration samples in exactly the same manner as regular samples. Plot  $A_s$ , the integrator area counts for each standard sample, versus  $C_c$ , the concentration of vinyl chloride in each standard sample. Draw a straight line through the points derived by the least squares method.

### 11.0 Analytical Procedure

11.1 Preparation of Equipment. Install the chromatographic column and condition overnight at 160 °C (320 °F). In the first operation, Porapak columns must be purged for 1 hour at 230 °C (450 °F).

Do not connect the exit end of the column to the detector while conditioning. Hydrogen and air to the detector must be turned off while the column is disconnected.

11.2 Flow Rate Adjustments. Adjust flow rates as follows:

11.2.1. Nitrogen Carrier Gas. Set regulator on cylinder to read 50 psig. Set regulator on chromatograph to produce a flow rate of 30.0 cc/min. Accurately measure the flow rate at the exit end of the column using the soap film flowmeter and a stopwatch, with the oven and column at the analysis temperature. After the instrument program advances to the “B” (backflush) mode, adjust the nitrogen pressure regulator to exactly balance the nitrogen flow rate at the detector as was obtained in the “A” mode.

11.2.2. Vial Prepressurizer Nitrogen.

11.2.2.1 After the nitrogen carrier is set, solve the following equation and adjust the pressure on the vial prepressurizer accordingly.

$$P = \frac{T_1}{T_2} \left[ P_1 - \frac{P_{w1} - P_{w2}}{7.50} \right] - 10 \text{ kPa} \quad \text{Eq. 107-1}$$

[View or download PDF](#)

Where:

$T_1$  = Ambient temperature, °K (°R).

$T_2$  = Conditioning bath temperature, °K (°R).

$P_1$  = Gas chromatograph absolute dosing pressure (analysis mode), k Pa.

$P_{w1}$  = Water vapor pressure 525.8 mm Hg @ 90 °C.

$P_{w2}$  = Water vapor pressure 19.8 mm Hg @ 22 °C.

7.50 = mm Hg per k Pa.

10 kPa = Factor to adjust the prepressurized pressure to slightly less than the dosing pressure.

11.2.2.2 Because of gauge errors, the apparatus may over-pressurize the vial. If the vial pressure is at or higher than the dosing pressure, an audible double injection will occur. If the vial pressure is too low, errors will occur on resin samples because of inadequate time for head-space gas equilibrium. This condition can be avoided by running several standard gas samples at various pressures around the calculated pressure, and then selecting the highest pressure that does not produce a double injection. All samples and standards must be pressurized for 60 seconds using the vial prepressurizer. The vial is then placed into the 90 °C conditioning bath and tested for leakage by placing a drop of water on the septum at the needle hole. A clean, burr-free needle is mandatory.

11.2.3. Burner Air Supply. Set regulator on cylinder to read 50 psig. Set regulator on chromatograph to supply air to burner at a rate between 250 and 300 cc/min. Check with bubble flowmeter.

11.2.4. Hydrogen Supply. Set regulator on cylinder to read 30 psig. Set regulator on chromatograph to supply approximately  $35 \pm 5$  cc/min. Optimize hydrogen flow to yield the most sensitive detector response without extinguishing the flame. Check flow with bubble meter and record this flow.

11.3 Temperature Adjustments. Set temperatures as follows:

11.3.1. Oven (chromatograph column), 140 °C (280 °F).

11.3.2. Dosing Line, 150 °C (300 °F).

11.3.3. Injection Block, 170 °C (340 °F).

11.3.4. Sample Chamber, Water Temperature, 90 °C  $\pm 1.0$  °C (194 °F  $\pm 1.8$  °F).

11.4 Ignition of Flame Ionization Detector. Ignite the detector according to the manufacturer's instructions.

11.5 Amplifier Balance. Balance the amplifier according to the manufacturer's instructions.

11.6 Programming the Chromatograph. Program the chromatograph as follows:

11.6.1. I—Dosing or Injection Time. The normal setting is 2 seconds.

11.6.2. A—Analysis Time. The normal setting is approximately 70 percent of the VCM retention time. When this timer terminates, the programmer initiates backflushing of the first column.

11.6.3. B—Backflushing Time. The normal setting is double the analysis time.

11.6.4. W—Stabilization Time. The normal setting is 0.5 min to 1.0 min.

11.6.5. X—Number of Analyses Per Sample. The normal setting is one.

11.7. Sample Treatment. All samples must be recovered and analyzed within 24 hours after collection.

11.7.1 Resin Samples. The weight of the resin used must be between 0.1 and 4.5 grams. An exact weight must be obtained (within  $\pm 1$  percent) for each sample. In the case of suspension resins, a volumetric cup can be prepared for holding the required amount of sample. When the cup is used, open the sample bottle, and add the cup volume of resin to the tared sample vial (tared, including septum and aluminum cap). Obtain the exact sample weight, add 100 ml or about two equal drops of water, and immediately seal the vial. Report this value on the data sheet; it is required for calculation of RVC. In the case of dispersion resins, the cup cannot be used. Weigh the sample in an aluminum dish, transfer the sample to the tared vial, and accurately weigh it in the vial. After prepressurization of the samples, condition them for a minimum of 1 hour in the 90 °C (190 °F) bath. Do not exceed 5 hours. Prepressurization is not required if the sample weight, as analyzed, does not exceed 0.2 gram. It is also not required if solution of the prepressurization equation yields an absolute prepressurization value that is within 30 percent of the atmospheric pressure.

Note: Some aluminum vial caps have a center section that must be removed prior to placing into sample tray. If the cap is not removed, the injection needle will be damaged.

11.7.2 Suspension Resin Slurry and Wet Cake Samples. Decant the water from a wet cake sample, and turn the sample bottle upside down onto a paper towel. Wait for the water to drain, place approximately 0.2 to 4.0 grams of the wet cake sample in a tared vial (tared, including septum and aluminum cap) and seal immediately. Then determine the sample weight (1 percent). All samples weighing over 0.2 gram, must be prepressurized prior to conditioning for 1 hour at 90 °C (190 °F), except as noted in Section 11.7.1. A sample of wet cake is used to determine total solids (TS). This is required for calculating the RVC.

11.7.3 Dispersion Resin Slurry and Latex Samples. The materials should not be filtered. Sample must be thoroughly mixed. Using a tared vial (tared, including septum and aluminum cap) add approximately eight drops (0.25 to 0.35 g) of slurry or latex using a medicine dropper. This should be done immediately after mixing. Seal the vial as soon as possible. Determine sample weight (1 percent). Condition the vial for 1 hour at 90 °C (190 °F) in the analyzer bath. Determine the TS on the slurry sample (Section 11.10).

11.7.4 In-process Wastewater Samples. Using a tared vial (tared, including septum and aluminum cap) quickly add approximately 1 cc of water using a medicine dropper. Seal the vial as soon as possible. Determine sample weight (1 percent). Condition the vial for 1 hour at 90 °C (190 °F) in the analyzer bath.

11.8 Preparation of Sample Turntable.

11.8.1 Before placing any sample into turntable, be certain that the center section of the aluminum cap has been removed. The numbered sample vials should be placed in the corresponding numbered positions in the turntable. Insert samples in the following order:

11.8.1.1 Positions 1 and 2. Old 2000-ppm standards for conditioning. These are necessary only after the analyzer has not been used for 24 hours or longer.

11.8.1.2 Position 3. 50-ppm standard, freshly prepared.

11.8.1.3 Position 4. 500-ppm standard, freshly prepared.

11.8.1.4 Position 5. 2000-ppm standard, freshly prepared.

11.8.1.5 Position 6. 4000-ppm standard, freshly prepared.

11.8.1.6 Position 7. Sample No. 7 (This is the first sample of the day, but is given as 7 to be consistent with the turntable and the integrator printout.)

11.8.2 After all samples have been positioned, insert the second set of 50-, 500-, 2000-, and 4000-ppm standards. Samples, including standards, must be conditioned in the bath of 90 °C (190 °F) for a minimum of one hour and a maximum of five hours.

11.9 Start Chromatograph Program. When all samples, including standards, have been conditioned at 90 °C (190 °F) for at least one hour, start the analysis program according to the manufacturer's instructions. These instructions must be carefully followed when starting and stopping a program to prevent damage to the dosing assembly.

11.10 Determination of Total Solids. For wet cake, slurry, resin solution, and PVC latex samples, determine TS for each sample by accurately weighing approximately 3 to 4 grams of sample in an aluminum pan before and after placing in a draft oven (105 to 110 °C (221 to 230 °F)). Samples must be dried to constant weight. After first weighing, return the pan to the oven for a short period of time, and then reweigh to verify complete dryness. The TS are then calculated as the final sample weight divided by initial sample weight.

## 12.0 Calculations and Data Analysis

### 12.1 Nomenclature.

$A_s$  = Chromatogram area counts of vinyl chloride for the sample, area counts.

$A_s$  = Chromatogram area counts of vinyl chloride for the sample.

$C_c$  = Concentration of vinyl chloride in the standard sample, ppm.

$K_p$  = Henry's Law Constant for VCM in PVC 90 °C,  $6.52 \times 10^{-6}$  g/g/mm Hg.

$K_w$  = Henry's Law Constant for VCM in water 90 °C,  $7 \times 10^{-7}$  g/g/mm Hg.

$M_v$  = Molecular weight of VCM, 62.5 g/mole.

$m$  = Sample weight, g.

$P_a$  = Ambient atmospheric pressure, mm Hg.

$R$  = Gas constant, (62360<sup>3</sup> ml) (mm Hg)/(mole)(°K).

$R_f$  = Response factor in area counts per ppm VCM.

$R_s$  = Response factor, area counts/ppm.

$T_1$  = Ambient laboratory temperature, °K.

TS = Total solids expressed as a decimal fraction.

$T_2$  = Equilibrium temperature, °K.

$V_g$  = Volume of vapor phase, ml.

$$= V_v \frac{m(TS)}{1.36} - \frac{m(1-TS)}{0.9653}$$

[View or download PDF](#)

$V_v$  = Vial volume,<sup>3</sup> ml.

1.36 = Density of PVC at 90 °C, g/<sup>3</sup> ml.

0.9653 = Density of water at 90 °C, g/<sup>3</sup> ml.

12.2 Response Factor. If the calibration curve described in Section 10.3 passes through zero, an average response factor,  $R_f$ , may be used to facilitate computation of vinyl chloride sample concentrations.

12.2.1 To compute  $R_f$ , first compute a response factor,  $R_s$ , for each sample as follows:

$$R_s = \frac{A_s}{C_s} \quad \text{Eq. 107-2}$$

[View or download PDF](#)

12.2.2 Sum the individual response factors, and calculate  $R_f$ . If the calibration curve does not pass through zero, use the calibration curve to determine each sample concentration.

12.3 Residual Vinyl Chloride Monomer Concentration, ( $C_{rvc}$ ) or Vinyl Chloride Monomer Concentration. Calculate  $C_{rvc}$  in ppm or mg/kg as follows:

$$C_{rvc} = \frac{A_s P_2}{R_f T_1} \left[ \frac{M_v V_g}{R_m} + K_p (TS) T_2 K_w (1-TS) T_2 \right] \quad \text{Eq. 107-3}$$

[View or download PDF](#)

Note: Results calculated using these equations represent concentration based on the total sample. To obtain results based on dry PVC content, divide by TS.

### 13.0 Method Performance

13.1 Range and Sensitivity. The lower limit of detection of vinyl chloride will vary according to the sampling and chromatographic system. The system should be capable of producing a measurement for a 50-ppm vinyl chloride standard that is at least 10 times the standard deviation of the system background noise level.



13.2 An interlaboratory comparison between seven laboratories of three resin samples, each split into three parts, yielded a standard deviation of 2.63 percent for a sample with a mean of 2.09 ppm, 4.16 percent for a sample with a mean of 1.66 ppm, and 5.29 percent for a sample with a mean of 62.66 ppm.

#### 14.0 *Pollution Prevention [Reserved]*

#### 15.0 *Waste Management [Reserved]*

#### 16.0 *References*

1. B.F. Goodrich, Residual Vinyl Chloride Monomer Content of Polyvinyl Chloride Resins, Latex, Wet Cake, Slurry and Water Samples. B.F. Goodrich Chemical Group Standard Test Procedure No. 1005-E. B.F. Goodrich Technical Center, Avon Lake, Ohio. October 8, 1979.
2. Berens, A.R. The Diffusion of Vinyl Chloride in Polyvinyl Chloride. ACS-Division of Polymer Chemistry, Polymer Preprints 15 (2):197. 1974.
3. Berens, A.R. The Diffusion of Vinyl Chloride in Polyvinyl Chloride. ACS-Division of Polymer Chemistry, Polymer Preprints 15 (2):203. 1974.
4. Berens, A.R., *et. al.* Analysis for Vinyl Chloride in PVC Powders by Head-Space Gas Chromatography. Journal of Applied Polymer Science. 19:3169-3172. 1975.
5. Mansfield, R.A. The Evaluation of Henry's Law Constant (Kp) and Water Enhancement in the Perkin-Elmer Multifract F-40 Gas Chromatograph. B.F. Goodrich. Avon Lake, Ohio. February 10, 1978.

#### 17.0 *Tables, Diagrams, Flowcharts, and Validation Data [Reserved]*

Method 107A—Determination of Vinyl Chloride Content of Solvents, Resin-Solvent Solution, Polyvinyl Chloride Resin, Resin Slurry, Wet Resin, and Latex Samples

##### *Introduction*

Performance of this method should not be attempted by persons unfamiliar with the operation of a gas chromatograph (GC) or by those who are unfamiliar with source sampling because knowledge beyond the scope of this presentation is required. Care must be exercised to prevent exposure of sampling personnel to vinyl chloride, a carcinogen.

##### *1. Applicability and Principle*

1.1 *Applicability.* This is an alternative method and applies to the measurement of the vinyl chloride content of solvents, resin solvent solutions, polyvinyl chloride (PVC) resin, wet cake slurries, latex, and fabricated resin samples. This method is not acceptable where methods from Section 304(h) of the Clean Water Act, 33 U.S.C. 1251*et seq.*, (the Federal Water Pollution Control Act Amendments of 1972 as amended by the Clean Water Act of 1977) are required.

1.2 *Principle.* The basis for this method lies in the direct injection of a liquid sample into a chromatograph and the subsequent evaporation of all volatile material into the carrier gas stream of the chromatograph, thus permitting analysis of all volatile material including vinyl chloride.

## *2. Range and Sensitivity*

The lower limit of detection of vinyl chloride in dry PVC resin is 0.2 ppm. For resin solutions, latexes, and wet resin, this limit rises inversely as the nonvolatile (resin) content decreases.

With proper calibration, the upper limit may be extended as needed.

## *3. Interferences*

The chromatograph columns and the corresponding operating parameters herein described normally provide an adequate resolution of vinyl chloride. In cases where resolution interferences are encountered, the chromatograph operator shall select the column and operating parameters best suited to his particular analysis problem, subject to the approval of the Administrator. Approval is automatic, provided that the tester produces confirming data through an adequate supplemental analytical technique, such as analysis with a different column or GC/mass spectroscopy, and has the data available for review by the Administrator.

## *4. Precision and Reproducibility*

A standard sample of latex containing 181.8 ppm vinyl chloride analyzed 10 times by the alternative method showed a standard deviation of 7.5 percent and a mean error of 0.21 percent.

A sample of vinyl chloride copolymer resin solution was analyzed 10 times by the alternative method and showed a standard deviation of 6.6 percent at a level of 35 ppm.

## *5. Safety*

Do not release vinyl chloride to the laboratory atmosphere during preparation of standards. Venting or purging with vinyl chloride monomer (VCM) air mixtures must be held to minimum. When purging is required, the vapor must be routed to outside air. Vinyl chloride, even at low-ppm levels, must never be vented inside the laboratory.

## *6. Apparatus*

6.1 Sampling. The following equipment is required:

6.1.1 Glass Bottles. 16-oz wide mouth wide polyethylene-lined, screw-on tops.

6.1.2 Adhesive Tape. To prevent loosening of bottle tops.

6.2 Sample Recovery. The following equipment is required:

6.2.1 Glass Vials. 20-ml capacity with polycone screw caps.

6.2.2 Analytical Balance. Capable of weighing to  $\pm 0.01$  gram.

6.2.3 Syringe. 50-microliter size, with removable needle.

6.2.4 Fritted Glass Sparger. Fine porosity.

6.2.5 Aluminum Weighing Dishes.

6.2.6 Sample Roller or Shaker. To help dissolve sample.

6.3 Analysis. The following equipment is required:

6.3.1 Gas Chromatograph. Hewlett Packard Model 5720A or equivalent.

6.3.2 Chromatograph Column. Stainless steel, 6.1 m by 3.2 mm, packed with 20 percent Tergitol E-35 on Chromosorb W AW 60/80 mesh. The analyst may use other columns provided that the precision and accuracy of the analysis of vinyl chloride standards are not impaired and that he has available for review information confirming that there is adequate resolution of the vinyl chloride peak. (Adequate resolution is defined as an area overlap of not more than 10 percent of the vinyl chloride peak by an interfering peak. Calculation of area overlap is explained in Appendix C, Procedure 1: "Determination of Adequate Chromatographic Peak Resolution.")

6.3.3 Valco Instrument Six-Port Rotary Valve. For column back flush.

6.3.4 Septa. For chromatograph injection port.

6.3.5 Injection Port Liners. For chromatograph used.

6.3.6 Regulators. For required gas cylinders.

6.3.7 Soap Film Flowmeter. Hewlett Packard No. 0101-0113 or equivalent.

6.4 Calibration. The following equipment is required:

6.4.1 Analytical Balance. Capable of weighing to  $\pm 0.0001$  g.

6.4.2 Erlenmeyer Flask With Glass Stopper. 125 ml.

6.4.3 Pipets. 0.1, 0.5, 1, 5, 10, and 50 ml.

6.4.4 Volumetric Flasks. 10 and 100 ml.

## 7. *Reagents*

Use only reagents that are of chromatograph grade.

7.1 Analysis. The following items are required:

7.1.1 Hydrogen Gas. Zero grade.

7.1.2 Nitrogen Gas. Zero grade.

7.1.3 Air. Zero grade.

7.1.4 Tetrahydrofuran (THF). Reagent grade.

Analyze the THF by injecting 10 microliters into the prepared gas chromatograph. Compare the THF chromatogram with that shown in Figure 107A-1. If the chromatogram is comparable to A, the THF should be sparged with pure nitrogen for approximately 2 hours using the fritted glass sparger to attempt to remove the interfering peak. Reanalyze the sparged THF to determine whether the THF is acceptable for use. If the scan is comparable to B, the THF should be acceptable for use in the analysis.

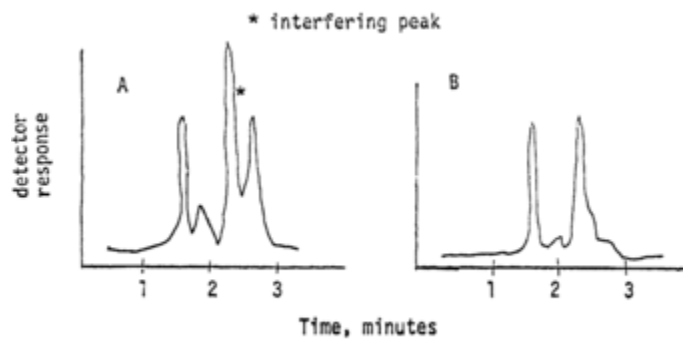

Figure 107A-1

[View or download PDF](#)

7.1.5 N, N-Dimethylacetamide (DMAC). Spectrographic grade. For use in place of THF.

7.2 Calibration. The following item is required:

7.2.1 Vinyl Chloride 99.9 Percent. Ideal Gas Products lecture bottle, or equivalent. For preparation of standard solutions.

## 8. Procedure

8.1 Sampling. Allow the liquid or dried resin to flow from a tap on the tank, silo, or pipeline until the tap has been purged. Fill a wide-mouth pint bottle, and immediately tightly cap the bottle. Place an identifying label on each bottle and record the date, time, sample location, and material.

8.2 Sample Treatment. Sample must be run within 24 hours.

8.2.1 Resin Samples. Weigh  $9.00 \pm 0.01$  g of THF or DMAC in a tared 20-ml vial. Add  $1.00 \pm 0.01$  g of resin to the tared vial containing the THF or DMAC. Close the vial tightly with the screw cap, and shake or otherwise agitate the vial until complete solution of the resin is obtained. Shaking may require several minutes to several hours, depending on the nature of the resin.

8.2.2 Suspension Resin Slurry and Wet Resin Sample. Slurry must be filtered using a small Buchner funnel with vacuum to yield a wet resin sample. The filtering process must be continued only as long as a steady stream of water is exiting from the funnel. Excessive filtration time could result in some loss of VCM. The wet resin sample is weighed into a tared 20-ml vial with THF or DMAC as described earlier for resin samples (8.2.1) and treated the same as the resin sample. A sample of the wet resin is used to determine total solids as required for calculating the residual VCM (Section 8.3.4).

8.2.3 Latex and Resin Solvent Solutions. Samples must be thoroughly mixed. Weigh  $1.00 \pm 0.01$  g of the latex or resin-solvent solution into a 20-ml vial containing  $9.00 \pm 0.01$  g of THF or DMAC as for the resin

samples (8.2.1). Cap and shake until complete solution is obtained. Determine the total solids of the latex or resin solution sample (Section 8.3.4).

8.2.4 Solvents and Non-viscous Liquid Samples. No preparation of these samples is required. The neat samples are injected directly into the GC.

### 8.3 Analysis.

8.3.1 Preparation of GC. Install the chromatographic column, and condition overnight at 70 °C. Do not connect the exit end of the column to the detector while conditioning.

8.3.1.1 Flow Rate Adjustments. Adjust the flow rate as follows:

- a. Nitrogen Carrier Gas. Set regulator on cylinder to read 60 psig. Set column flow controller on the chromatograph using the soap film flowmeter to yield a flow rate of 40 cc/min.
- b. Burner Air Supply. Set regulator on the cylinder at 40 psig. Set regulator on the chromatograph to supply air to the burner to yield a flow rate of 250 to 300 cc/min using the flowmeter.
- c. Hydrogen. Set regulator on cylinder to read 60 psig. Set regulator on the chromatograph to supply 30 to 40 cc/min using the flowmeter. Optimize hydrogen flow to yield the most sensitive detector response without extinguishing the flame. Check flow with flowmeter and record this flow.
- d. Nitrogen Back Flush Gas. Set regulator on the chromatograph using the soap film flowmeter to yield a flow rate of 40 cc/min.

8.3.1.2 Temperature Adjustments. Set temperature as follows:

- a. Oven (chromatographic column) at 70 °C.
- b. Injection Port at 100 °C.
- c. Detector at 300 °C.

8.3.1.3 Ignition of Flame Ionization Detector. Ignite the detector according to the manufacturer's instructions. Allow system to stabilize approximately 1 hour.

8.3.1.4 Recorder. Set pen at zero and start chart drive.

8.3.1.5 Attenuation. Set attenuation to yield desired peak height depending on sample VCM content.

8.3.2 Chromatographic Analyses.

- a. Sample Injection. Remove needle from 50-microliter syringe. Open sample vial and draw 50-microliters of THF or DMAC sample recovery solution into the syringe. Recap sample vial. Attach needle to the syringe and while holding the syringe vertically (needle uppermost), eject 40 microliters into an absorbent tissue. Wipe needle with tissue. Now inject 10 microliters into chromatograph system. Repeat the injection until two consecutive values for the height of the vinyl chloride peak do not vary more than 5 percent. Use the average value for these two peak heights to compute the sample concentration.

b. Back Flush. After 4 minutes has elapsed after sample injection, actuate the back flush valve to purge the first 4 feet of the chromatographic column of solvent and other high boilers.

c. Sample Data. Record on the chromatograph strip chart the data from the sample label.

d. Elution Time. Vinyl chloride elutes at 2.8 minutes. Acetaldehyde elutes at 3.7 minutes. Analysis is considered complete when chart pen becomes stable. After 5 minutes, reset back flush valve and inject next sample.

### 8.3.3 Chromatograph Servicing.

a. Septum. Replace after five sample injections.

b. Sample Port Liner. Replace the sample port liner with a clean spare after five sample injections.

c. Chromatograph Shutdown. If the chromatograph has been shut down overnight, rerun one or more samples from the preceding day to test stability and precision prior to starting on the current day's work.

8.3.4 Determination of Total Solids (TS). For wet resin, resin solution, and PVC latex samples, determine the TS for each sample by accurately weighing approximately 3 to 5 grams of sample into a tared aluminum pan. The initial procedure is as follows:

a. Where water is the major volatile component: Tare the weighing dish, and add 3 to 5 grams of sample to the dish. Weigh to the nearest milligram.

b. Where volatile solvent is the major volatile component: Transfer a portion of the sample to a 20-ml screw cap vial and cap immediately. Weigh the vial to the nearest milligram. Uncap the vial and transfer a 3- to 5-gram portion of the sample to a tared aluminum weighing dish. Recap the vial and reweigh to the nearest milligram. The vial weight loss is the sample weight.

To continue, place the weighing pan in a 130 °C oven for 1 hour. Remove the dish and allow to cool to room temperature in a desiccator. Weigh the pan to the nearest 0.1 mg. Total solids is the weight of material in the aluminum pan after heating divided by the net weight of sample added to the pan originally times 100.

## 9. Calibration of the Chromatograph

9.1 Preparation of Standards. Prepare a 1 percent by weight (approximate) solution of vinyl chloride in THF or DMAC by bubbling vinyl chloride gas from a cylinder into a tared 125-ml glass-stoppered flask containing THF or DMAC. The weight of vinyl chloride to be added should be calculated prior to this operation, i.e., 1 percent of the weight of THF or DMAC contained in the tared flask. This must be carried out in a laboratory hood. Adjust the vinyl chloride flow from the cylinder so that the vinyl chloride dissolves essentially completely in the THF or DMAC and is not blown to the atmosphere. Take particular care not to volatilize any of the solution. Stopper the flask and swirl the solution to effect complete mixing. Weigh the stoppered flask to nearest 0.1 mg to determine the exact amount of vinyl chloride added.

Pipet 10 ml of the approximately 1 percent solution into a 100-ml glass-stoppered volumetric flask, and add THF or DMAC to fill to the mark. Cap the flask and invert 10 to 20 times. This solution contains approximately 1,000 ppm by weight of vinyl chloride (note the exact concentration).

Pipet 50-, 10-, 5-, 1-, 0.5-, and 0.1-ml aliquots of the approximately 1,000 ppm solution into 10 ml glass stoppered volumetric flasks. Dilute to the mark with THF or DMAC, cap the flasks and invert each 10 to 20 times. These solutions contain approximately 500, 100, 50, 10, 5, and 1 ppm vinyl chloride. Note the exact concentration of each one. These standards are to be kept under refrigeration in stoppered bottles, and must be renewed every 3 months.

## 9.2 Preparation of Chromatograph Calibration Curve.

Obtain the GC for each of the six final solutions prepared in Section 9.1 by using the procedure in Section 8.3.2. Prepare a chart plotting peak height obtained from the chromatogram of each solution versus the known concentration. Draw a straight line through the points derived by the least squares method.

## 10. Calculations

10.1 Response Factor. From the calibration curve described in Section 9.2, select the value of  $C_c$  that corresponds to  $H_c$  for each sample. Compute the response factor,  $R_f$ , for each sample as follows:

$$R_f = \frac{C_c}{H_c} \quad \text{Eq. 107A-1}$$

[View or download PDF](#)

where:

$R_f$  = Chromatograph response factor, ppm/mm.

$C_c$  = Concentration of vinyl chloride in the standard sample, ppm.

$H_c$  = Peak height of the standard sample, mm.

10.2 Residual vinyl chloride monomer concentration ( $C_{rvc}$ ) or vinyl chloride monomer concentration in resin:

$$C_{rvc} = 10H_s R_f \quad \text{Eq.107A-2}$$

[View or download PDF](#)

Where:

$C_{rvc}$  = Concentration of residual vinyl chloride monomer, ppm.

$H_s$  = Peak height of sample, mm.

$R_f$  = Chromatograph response factor.

10.3 Samples containing volatile material, i.e., resin solutions, wet resin, and latexes:

$$C_{inc} = \frac{H_s R_f (1,000)}{TS} \quad \text{Eq. 107A-3}$$

[View or download PDF](#)

where:

TS = Total solids in the sample, weight fraction.

10.4 Samples of solvents and in process wastewater:

$$C_{inc} = \frac{H_s R_f}{0.888} \quad \text{Eq. 107A-4}$$

[View or download PDF](#)

Where:

0.888 = Specific gravity of THF.

## 11. Bibliography

1. Communication from R. N. Wheeler, Jr.; Union Carbide Corporation. Part 61 National Emissions Standards for Hazardous Air Pollutants appendix B, Method 107—Alternate Method, September 19, 1977.

### Method 108—Determination of Particulate and Gaseous Arsenic Emissions

Note: This method does not include all of the specifications (*e.g.*, equipment and supplies) and procedures (*e.g.*, sampling and analytical) essential to its performance. Some material is incorporated by reference from other methods in appendix A to 40 CFR part 60. Therefore, to obtain reliable results, persons using this method should have a thorough knowledge of at least the following additional test methods: Method 1, Method 2, Method 3, Method 5, and Method 12.

#### 1.0 Scope and Application.

##### 1.1 Analytes.

Analyte	CAS No.	Sensitivity
Arsenic compounds as arsenic (As)	7440-38-2	Lower limit 10 µg/ml or less.

1.2 Applicability. This method is applicable for the determination of inorganic As emissions from stationary sources as specified in an applicable subpart of the regulations.

1.3 Data Quality Objectives. Adherence to the requirements of this method will enhance the quality of the data obtained from air pollutant sampling methods.

#### 2.0 Summary of Method



Particulate and gaseous As emissions are withdrawn isokinetically from the source and are collected on a glass mat filter and in water. The collected arsenic is then analyzed by means of atomic absorption spectrophotometry (AAS).

### 3.0 *Definitions. [Reserved]*

### 4.0 *Interferences*

Analysis for As by flame AAS is sensitive to the chemical composition and to the physical properties (e.g., viscosity, pH) of the sample. The analytical procedure includes a check for matrix effects (Section 11.5).

### 5.0 *Safety*

5.1 This method may involve hazardous materials, operations, and equipment. This test method may not address all of the safety problems associated with its use. It is the responsibility of the user to establish appropriate safety and health practices and determine the applicability of regulatory limitations prior to performing this test method.

5.2 Corrosive reagents. The following reagents are hazardous. Personal protective equipment and safe procedures that prevent chemical splashes are recommended. If contact occurs, immediately flush with copious amounts of water for at least 15 minutes. Remove clothing under shower and decontaminate. Treat residual chemical burns as thermal burns.

5.2.1 Hydrochloric Acid (HCl). Highly corrosive liquid with toxic vapors. Vapors are highly irritating to eyes, skin, nose, and lungs, causing severe damage. May cause bronchitis, pneumonia, or edema of lungs. Exposure to concentrations of 0.13 to 0.2 percent can be lethal to humans in a few minutes. Provide ventilation to limit exposure. Reacts with metals, producing hydrogen gas.

5.2.2 Hydrogen Peroxide (H<sub>2</sub>O<sub>2</sub>). Very harmful to eyes. 30% H<sub>2</sub>O<sub>2</sub> can burn skin, nose, and lungs.

5.2.3 Nitric Acid (HNO<sub>3</sub>). Highly corrosive to eyes, skin, nose, and lungs. Vapors are highly toxic and can cause bronchitis, pneumonia, or edema of lungs. Reaction to inhalation may be delayed as long as 30 hours and still be fatal. Provide ventilation to limit exposure. Strong oxidizer. Hazardous reaction may occur with organic materials such as solvents.

5.2.4 Sodium Hydroxide (NaOH). Causes severe damage to eyes and skin. Inhalation causes irritation to nose, throat, and lungs. Reacts exothermically with small amounts of water.

### 6.0 *Equipment and Supplies*

6.1 Sample Collection. A schematic of the sampling train used in performing this method is shown in Figure 108-1; it is similar to the Method 5 sampling train of 40 CFR part 60, appendix A. The following items are required for sample collection:

6.1.1 Probe Nozzle, Probe Liner, Pitot Tube, Differential Pressure Gauge, Filter Holder, Filter Heating System, Temperature Sensor, Metering System, Barometer, and Gas Density Determination Equipment. Same as Method 5, Sections 6.1.1.1 to 6.1.1.7, 6.1.1.9, 6.1.2, and 6.1.3, respectively.

6.1.2 Impingers. Four impingers connected in series with leak-free ground-glass fittings or any similar leak-free noncontaminating fittings. For the first, third, and fourth impingers, use the Greenburg-Smith design, modified by replacing the tip with a 1.3-cm ID (0.5-in.) glass tube extending to about 1.3 cm (0.5 in.) from the bottom of the flask. For the second impinger, use the Greenburg-Smith design with the standard tip. Modifications (*e.g.*, flexible connections between the impingers, materials other than glass, or flexible vacuum lines to connect the filter holder to the condenser) are subject to the approval of the Administrator.

6.1.3 Temperature Sensor. Place a temperature sensor, capable of measuring temperature to within 1 °C (2 °F), at the outlet of the fourth impinger for monitoring purposes.

6.2 Sample Recovery. The following items are required for sample recovery:

6.2.1 Probe-Liner and Probe-Nozzle Brushes, Petri Dishes, Graduated Cylinder and/or Balance, Plastic Storage Containers, and Funnel and Rubber Policeman. Same as Method 5, Sections 6.2.1 and 6.2.4 to 6.2.8, respectively.

6.2.2 Wash Bottles. Polyethylene (2).

6.2.3 Sample Storage Containers. Chemically resistant, polyethylene or polypropylene for glassware washes, 500- or 1000-ml.

6.3 Analysis. The following items are required for analysis:

6.3.1 Spectrophotometer. Equipped with an electrodeless discharge lamp and a background corrector to measure absorbance at 193.7 nanometers (nm). For measuring samples having less than 10 µg As/ml, use a vapor generator accessory or a graphite furnace.

6.3.2 Recorder. To match the output of the spectrophotometer.

6.3.3 Beakers. 150 ml.

6.3.4 Volumetric Flasks. Glass 50-, 100-, 200-, 500-, and 1000-ml; and polypropylene, 50-ml.

6.3.5 Balance. To measure within 0.5 g.

6.3.6 Volumetric Pipets. 1-, 2-, 3-, 5-, 8-, and 10-ml.

6.3.7 Oven.

6.3.8 Hot Plate.

## 7.0 Reagents and Standards

Unless otherwise indicated, it is intended that all reagents conform to the specifications established by the Committee on Analytical Reagents of the American Chemical Society, where such specifications are available; otherwise, use the best available grade.

7.1 The following reagents are required for sample collection:

7.1.1 Filters. Same as Method 5, Section 7.1.1, except that the filters need not be unreactive to SO<sub>2</sub>.

7.1.2 Silica Gel, Crushed Ice, and Stopcock Grease. Same as Method 5, Sections 7.1.2, 7.1.4, and 7.1.5, respectively.

7.1.3 Water. Deionized distilled to meet ASTM D 1193-77 or 91 (incorporated by reference-see §61.18), Type 3. When high concentrations of organic matter are not expected to be present, the KMnO<sub>4</sub> test for oxidizable organic matter may be omitted.

7.2 Sample Recovery.

7.2.1 0.1 N NaOH. Dissolve 4.00 g of NaOH in about 500 ml of water in a 1-liter volumetric flask. Then, dilute to exactly 1.0 liter with water.

7.3 Analysis. The following reagents and standards are required for analysis:

7.3.1 Water. Same as Section 7.1.3.

7.3.2 Sodium Hydroxide, 0.1 N. Same as in Section 7.2.1.

7.3.3 Sodium Borohydride (NaBH<sub>4</sub>), 5 Percent Weight by Volume (W/V). Dissolve 50.0 g of NaBH<sub>4</sub> in about 500 ml of 0.1 N NaOH in a 1-liter volumetric flask. Then, dilute to exactly 1.0 liter with 0.1 N NaOH.

7.3.4 Hydrochloric Acid, Concentrated.

7.3.5 Potassium Iodide (KI), 30 Percent (W/V). Dissolve 300 g of KI in 500 ml of water in a 1 liter volumetric flask. Then, dilute to exactly 1.0 liter with water.

7.3.6 Nitric Acid, Concentrated.

7.3.7 Nitric Acid, 0.8 N. Dilute 52 ml of concentrated HNO<sub>3</sub> to exactly 1.0 liter with water.

7.3.8 Nitric Acid, 50 Percent by Volume (V/V). Add 50 ml concentrated HNO<sub>3</sub> to 50 ml water.

7.3.9 Stock Arsenic Standard, 1 mg As/ml. Dissolve 1.3203 g of primary standard grade As<sub>2</sub>O<sub>3</sub> in 20 ml of 0.1 N NaOH in a 150 ml beaker. Slowly add 30 ml of concentrated HNO<sub>3</sub>. Heat the resulting solution and evaporate just to dryness. Transfer the residue quantitatively to a 1-liter volumetric flask, and dilute to 1.0 liter with water.

7.3.10 Arsenic Working Solution, 1.0 µg As/ml. Pipet exactly 1.0 ml of stock arsenic standard into an acid-cleaned, appropriately labeled 1-liter volumetric flask containing about 500 ml of water and 5 ml of concentrated HNO<sub>3</sub>. Dilute to exactly 1.0 liter with water.

7.3.11 Air. Suitable quality for AAS analysis.

7.3.12 Acetylene. Suitable quality for AAS analysis.

7.3.13 Nickel Nitrate, 5 Percent Ni (W/V). Dissolve 24.780 g of nickel nitrate hexahydrate [Ni(NO<sub>3</sub>)<sub>2</sub>·6H<sub>2</sub>O] in water in a 100-ml volumetric flask, and dilute to 100 ml with water.

7.3.14 Nickel Nitrate, 1 Percent Ni (W/V). Pipet 20 ml of 5 percent nickel nitrate solution into a 100-ml volumetric flask, and dilute to exactly 100 ml with water.

7.3.15 Hydrogen Peroxide, 3 Percent by Volume. Pipet 50 ml of 30 percent H<sub>2</sub>O<sub>2</sub> into a 500-ml volumetric flask, and dilute to exactly 500 ml with water.

#### 8.0 *Sample Collection, Preservation, Transport, and Storage*

8.1 Pretest Preparation. Follow the general procedure given in Method 5, Section 8.1, except the filter need not be weighed, and the 200 ml of 0.1N NaOH and Container 4 should be tared to within 0.5 g.

8.2 Preliminary Determinations. Follow the general procedure given in Method 5, Section 8.2, except select the nozzle size to maintain isokinetic sampling rates below 28 liters/min (1.0 cfm).

8.3 Preparation of Sampling Train. Follow the general procedure given in Method 5, Section 8.3.

8.4 Leak-Check Procedures. Same as Method 5, Section 8.4.

8.5 Sampling Train Operation. Follow the general procedure given in Method 5, Section 8.5, except maintain isokinetic sampling flow rates below 28 liters/min (1.0 cfm). For each run, record the data required on a data sheet similar to the one shown in Figure 108-2.

8.6 Calculation of Percent Isokinetic. Same as Method 5, Section 8.6.

8.7 Sample Recovery. Same as Method 5, Section 8.7, except that 0.1 N NaOH is used as the cleanup solvent instead of acetone and that the impinger water is treated as follows:

8.7.1 Container Number 4 (Impinger Water). Clean each of the first three impingers and connecting glassware in the following manner:

8.7.1.1 Wipe the impinger ball joints free of silicone grease, and cap the joints.

8.7.1.2 Rotate and agitate each of the first two impingers, using the impinger contents as a rinse solution.

8.7.1.3 Transfer the liquid from the first three impingers to Container Number 4. Remove the outlet ball-joint cap, and drain the contents through this opening. Do not separate the impinger parts (inner and outer tubes) while transferring their contents to the container.

8.7.1.4 Weigh the contents of Container No. 4 to within 0.5 g. Record in the log the weight of liquid along with a notation of any color or film observed in the impinger catch. The weight of liquid is needed along with the silica gel data to calculate the stack gas moisture content.

Note: Measure and record the total amount of 0.1 N NaOH used for rinsing under Sections 8.7.1.5 and 8.7.1.6.

8.7.1.5 Pour approximately 30 ml of 0.1 NaOH into each of the first two impingers, and agitate the impingers. Drain the 0.1 N NaOH through the outlet arm of each impinger into Container Number 4. Repeat this operation a second time; inspect the impingers for any abnormal conditions.

8.7.1.6 Wipe the ball joints of the glassware connecting the impingers and the back half of the filter holder free of silicone grease, and rinse each piece of glassware twice with 0.1 N NaOH; transfer this rinse into Container Number 4. (DO NOT RINSE or brush the glass-fritted filter support.) Mark the height of the fluid level to determine whether leakage occurs during transport. Label the container to identify clearly its contents.

## 8.8 Blanks.

8.8.1 Sodium Hydroxide. Save a portion of the 0.1 N NaOH used for cleanup as a blank. Take 200 ml of this solution directly from the wash bottle being used and place it in a plastic sample container labeled "NaOH blank."

8.8.2 Water. Save a sample of the water, and place it in a container labeled "H<sub>2</sub>O blank."

8.8.3 Filter. Save two filters from each lot of filters used in sampling. Place these filters in a container labeled "filter blank."

## 9.0 *Quality Control*

### 9.1 Miscellaneous Quality Control Measures.

Section	Quality control measure	Effect
8.4, 10.1	Sampling equipment leak-checks and calibration	Ensures accuracy and precision of sampling measurements.
10.4	Spectrophotometer calibration	Ensures linearity of spectrophotometer response to standards.
11.5	Check for matrix effects	Eliminates matrix effects.

9.2 Volume Metering System Checks. Same as Method 5, Section 9.2.

### 10.0 *Calibration and Standardization*

Note: Maintain a laboratory log of all calibrations.

10.1 Sampling Equipment. Same as Method 5, Section 10.0.

#### 10.2 Preparation of Standard Solutions.

10.2.1 For the high level procedure, pipet 1, 3, 5, 8, and 10 ml of the 1.0 mg As/ml stock solution into separate 100 ml volumetric flasks, each containing 5 ml of concentrated HNO<sub>3</sub>. Dilute to the mark with water.

10.2.2 For the low level vapor generator procedure, pipet 1, 2, 3, and 5 ml of 1.0 µg As/ml standard solution into separate reaction tubes. Dilute to the mark with water.

10.2.3 For the low level graphite furnace procedure, pipet 1, 5, 10 and 15 ml of 1.0 µg As/ml standard solution into separate flasks along with 2 ml of the 5 percent nickel nitrate solution and 10 ml of the 3 percent H<sub>2</sub>O<sub>2</sub> solution. Dilute to the mark with water.

10.3 Calibration Curve. Analyze a 0.8 N HNO<sub>3</sub> blank and each standard solution according to the procedures outlined in section 11.4.1. Repeat this procedure on each standard solution until two consecutive peaks agree within 3 percent of their average value. Subtract the average peak height (or peak area) of the blank—which must be less than 2 percent of recorder full scale—from the averaged peak height of each standard solution. If the blank absorbance is greater than 2 percent of full-scale, the probable cause is As contamination of a reagent or carry-over of As from a previous sample. Prepare the calibration curve by plotting the corrected peak height of each standard solution versus the corresponding final total As weight in the solution.

10.4 Spectrophotometer Calibration Quality Control. Calculate the least squares slope of the calibration curve. The line must pass through the origin or through a point no further from the origin than ±2 percent of the recorder full scale. Multiply the corrected peak height by the reciprocal of the least squares slope to determine the distance each calibration point lies from the theoretical calibration line. The difference between the calculated concentration values and the actual concentrations (*e.g.*, 1, 3, 5, 8, and 10 mg As for the high-level procedure) must be less than 7 percent for all standards.

Note: For instruments equipped with direct concentration readout devices, preparation of a standard curve will not be necessary. In all cases, follow calibration and operational procedures in the manufacturers' instruction manual.

### 11.0 Analytical Procedure

11.1 Sample Loss Check. Prior to analysis, check the liquid level in Containers Number 2 and Number 4. Note on the analytical data sheet whether leakage occurred during transport. If a noticeable amount of leakage occurred, either void the sample or take steps, subject to the approval of the Administrator, to adjust the final results.

#### 11.2 Sample Preparation.

11.2.1 Container Number 1 (Filter). Place the filter and loose particulate matter in a 150 ml beaker. Also, add the filtered solid material from Container Number 2 (see Section 11.2.2). Add 50 ml of 0.1 N NaOH. Then stir and warm on a hot plate at low heat (do not boil) for about 15 minutes. Add 10 ml of concentrated HNO<sub>3</sub>, bring to a boil, then simmer for about 15 minutes. Filter the solution through a glass fiber filter. Wash with hot water, and catch the filtrate in a clean 150 ml beaker. Boil the filtrate, and evaporate to dryness. Cool, add 5 ml of 50 percent HNO<sub>3</sub>, and then warm and stir. Allow to cool. Transfer to a 50-ml volumetric flask, dilute to volume with water, and mix well.

#### 11.2.2 Container Number 2 (Probe Wash).

11.2.2.1 Filter (using a glass fiber filter) the contents of Container Number 2 into a 200 ml volumetric flask. Combine the filtered (solid) material with the contents of Container Number 1 (Filter).

11.2.2.2 Dilute the filtrate to exactly 200 ml with water. Then pipet 50 ml into a 150 ml beaker. Add 10 ml of concentrated HNO<sub>3</sub>, bring to a boil, and evaporate to dryness. Allow to cool, add 5 ml of 50 percent HNO<sub>3</sub>, and then warm and stir. Allow the solution to cool, transfer to a 50-ml volumetric flask, dilute to volume with water, and mix well.

11.2.3 Container Number 4 (Impinger Solution). Transfer the contents of Container Number 4 to a 500 ml volumetric flask, and dilute to exactly 500-ml with water. Pipet 50 ml of the solution into a 150-ml beaker. Add 10 ml of concentrated HNO<sub>3</sub>, bring to a boil, and evaporate to dryness. Allow to cool, add 5 ml of 50 percent HNO<sub>3</sub>, and then warm and stir. Allow the solution to cool, transfer to a 50-ml volumetric flask, dilute to volume with water, and mix well.

11.2.4 Filter Blank. Cut each filter into strips, and treat each filter individually as directed in Section 11.2.1, beginning with the sentence, "Add 50 ml of 0.1 N NaOH."

11.2.5 Sodium Hydroxide and Water Blanks. Treat separately 50 ml of 0.1 N NaOH and 50 ml water, as directed under Section 11.2.3, beginning with the sentence, "Pipet 50 ml of the solution into a 150-ml beaker."

11.3 Spectrophotometer Preparation. Turn on the power; set the wavelength, slit width, and lamp current. Adjust the background corrector as instructed by the manufacturer's manual for the particular atomic absorption spectrophotometer. Adjust the burner and flame characteristics as necessary.

11.4 Analysis. Calibrate the analytical equipment and develop a calibration curve as outlined in Sections 10.2 through 10.4.

11.4.1 Arsenic Samples. Analyze an appropriately sized aliquot of each diluted sample (from Sections 11.2.1 through 11.2.3) until two consecutive peak heights agree within 3 percent of their average value. If applicable, follow the procedures outlined in Section 11.4.1.1. If the sample concentration falls outside the range of the calibration curve, make an appropriate dilution with 0.8 N HNO<sub>3</sub> so that the final concentration falls within the range of the curve. Using the calibration curve, determine the arsenic concentration in each sample fraction.

Note: Because instruments vary between manufacturers, no detailed operating instructions will be given here. Instead, the instrument manufacturer's detailed operating instructions should be followed.

11.4.1.1 Arsenic Determination at Low Concentration. The lower limit of flame AAS is 10 µg As/ml. If the arsenic concentration of any sample is at a lower level, use the graphite furnace or vapor generator which is available as an accessory component. Flame, graphite furnace, or vapor generators may be used for samples whose concentrations are between 10 and 30 µg/ml. Follow the manufacturer's instructions in the use of such equipment.

11.4.1.1.1 Vapor Generator Procedure. Place a sample containing between 0 and 5 µg of arsenic in the reaction tube, and dilute to 15 ml with water. Since there is some trial and error involved in this procedure, it may be necessary to screen the samples by conventional atomic absorption until an approximate concentration is determined. After determining the approximate concentration, adjust the volume of the sample accordingly. Pipet 15 ml of concentrated HCl into each tube. Add 1 ml of 30 percent KI solution. Place the reaction tube into a 50 °C (120 °F) water bath for 5 minutes. Cool to room

temperature. Connect the reaction tube to the vapor generator assembly. When the instrument response has returned to baseline, inject 5.0 ml of 5 percent  $\text{NaBH}_4$ , and integrate the resulting spectrophotometer signal over a 30-second time period.

11.4.1.1.2 Graphite Furnace Procedure. Dilute the digested sample so that a 5 ml aliquot contains less than 1.5  $\mu\text{g}$  of arsenic. Pipet 5 ml of this digested solution into a 10-ml volumetric flask. Add 1 ml of the 1 percent nickel nitrate solution, 0.5 ml of 50 percent  $\text{HNO}_3$ , and 1 ml of the 3 percent hydrogen peroxide and dilute to 10 ml with water. The sample is now ready for analysis.

11.4.1.2 Run a blank (0.8 N  $\text{HNO}_3$ ) and standard at least after every five samples to check the spectrophotometer calibration. The peak height of the blank must pass through a point no further from the origin than  $\pm 2$  percent of the recorder full scale. The difference between the measured concentration of the standard (the product of the corrected average peak height and the reciprocal of the least squares slope) and the actual concentration of the standard must be less than 7 percent, or recalibration of the analyzer is required.

11.4.1.3 Determine the arsenic concentration in the filter blank (i.e., the average of the two blank values from each lot).

11.4.2 Container Number 3 (Silica Gel). This step may be conducted in the field. Weigh the spent silica gel (or silica gel plus impinger) to the nearest 0.5 g; record this weight.

11.5 Check for matrix effects on the arsenic results. Same as Method 12, Section 11.5.

## 12.0 Data Analysis and Calculations

### 12.1 Nomenclature

$B_{ws}$  = Water in the gas stream, proportion by volume.

$C_a$  = Concentration of arsenic as read from the standard curve,  $\mu\text{g}/\text{ml}$ .

$C_s$  = Arsenic concentration in stack gas, dry basis, converted to standard conditions,  $\text{g}/\text{dsm}^3$  ( $\text{gr}/\text{dscf}$ ).

$E_a$  = Arsenic mass emission rate,  $\text{g}/\text{hr}$  ( $\text{lb}/\text{hr}$ ).

$F_d$  = Dilution factor (equals 1 if the sample has not been diluted).

$I$  = Percent of isokinetic sampling.

$m_{bi}$  = Total mass of all four impingers and contents before sampling, g.

$m_{fi}$  = Total mass of all four impingers and contents after sampling, g.

$m_n$  = Total mass of arsenic collected in a specific part of the sampling train,  $\mu\text{g}$ .

$m_t$  = Total mass of arsenic collected in the sampling train,  $\mu\text{g}$ .

$T_m$  = Absolute average dry gas meter temperature (*see* Figure 108-2),  $^{\circ}\text{K}$  ( $^{\circ}\text{R}$ ).



$V_m$  = Volume of gas sample as measured by the dry gas meter, dry basis,  $m^3$  ( $ft^3$ ).

$V_{m(std)}$  = Volume of gas sample as measured by the dry gas meter, corrected to standard conditions,  $m^3$  ( $ft^3$ ).

$V_n$  = Volume of solution in which the arsenic is contained, ml.

$V_{w(std)}$  = Volume of water vapor collected in the sampling train, corrected to standard conditions,  $m^3$  ( $ft^3$ ).

$\Delta H$  = Average pressure differential across the orifice meter (*see* Figure 108-2), mm  $H_2O$  (in.  $H_2O$ ).

12.2 Average Dry Gas Meter Temperatures ( $T_m$ ) and Average Orifice Pressure Drop ( $\Delta H$ ). See data sheet (Figure 108-2).

12.3 Dry Gas Volume. Using data from this test, calculate  $V_{m(std)}$  according to the procedures outlined in Method 5, Section 12.3.

12.4 Volume of Water Vapor.

$$V_{w(std)} = K_2(m_{f1} - m_{f2}) \quad \text{Eq. 108-1}$$

[View or download PDF](#)

Where:

$K_2 = 0.001334 \text{ m}^3/\text{g}$  for metric units.

$= 0.047012 \text{ ft}^3/\text{g}$  for English units.

12.5 Moisture Content.

$$B_{ws} = \frac{V_{w(std)}}{V_{m(std)} + V_{w(std)}} \quad \text{Eq. 108-2}$$

[View or download PDF](#)

12.6 Amount of Arsenic Collected.

12.6.1 Calculate the amount of arsenic collected in each part of the sampling train, as follows:

$$m_n = C_n F_d V_n \quad \text{Eq. 108-3}$$

[View or download PDF](#)

12.6.2 Calculate the total amount of arsenic collected in the sampling train as follows:

$$m_t = m_{(filters)} + m_{(probe)} + m_{(impingers)} - m_{(filter\ blank)} - m_{(NaOH\ blank)} - m_{(water\ blank)} \quad \text{Eq. 108-4}$$

[View or download PDF](#)

12.7 Calculate the arsenic concentration in the stack gas (dry basis, adjusted to standard conditions) as follows:

$$C_s = K_3 (m_t / V_{m(\text{std})}) \quad \text{Eq. 108-5}$$

[View or download PDF](#)

Where:

$$K_3 = 10^{-6} \text{ g}/\mu\text{g for metric units}$$

$$= 1.54 \times 10^{-5} \text{ gr}/\mu\text{g for English units}$$

12.8 Stack Gas Velocity and Volumetric Flow Rate. Calculate the average stack gas velocity and volumetric flow rate using data obtained in this method and the equations in Sections 12.2 and 12.3 of Method 2.

12.9 Pollutant Mass Rate. Calculate the arsenic mass emission rate as follows:

$$E_s = C_s Q_{sd} \quad \text{Eq. 108-6}$$

[View or download PDF](#)

12.10 Isokinetic Variation. Same as Method 5, Section 12.11.

### 13.0 Method Performance

13.1 Sensitivity. The lower limit of flame AAS 10  $\mu\text{g As/ml}$ . The analytical procedure includes provisions for the use of a graphite furnace or vapor generator for samples with a lower arsenic concentration.

14.0 Pollution Prevention. [Reserved]

15.0 Waste Management. [Reserved]

16.0 Alternative Procedures

16.1 Inductively coupled plasma-atomic emission spectrometry (ICP-AES) Analysis. ICP-AES may be used as an alternative to atomic absorption analysis provided the following conditions are met:

16.1.1 Sample collection, sample preparation, and analytical preparation procedures are as defined in the method except as necessary for the ICP-AES application.

16.1.2 Quality Assurance/Quality Control procedures, including audit material analysis, are conducted as prescribed in the method. The QA acceptance conditions must be met.

16.1.3 The limit of quantitation for the ICP-AES must be demonstrated and the sample concentrations reported should be no less than two times the limit of quantitation. The limit of quantitation is defined as ten times the standard deviation of the blank value. The standard deviation of the blank value is determined from the analysis of seven blanks. It has been reported that for mercury and those elements

that form hydrides, a continuous-flow generator coupled to an ICP-AES offers detection limits comparable to cold vapor atomic absorption.

16.2 Inductively Coupled Plasma-Mass Spectrometry (ICP-MS) Analysis. ICP-MS may be used as an alternative to atomic absorption analysis.

16.3 Cold Vapor Atomic Fluorescence Spectrometry (CVAFS) Analysis. CVAFS may be used as an alternative to atomic absorption analysis.

### *17.0 References.*

Same as References 1 through 9 of Method 5, Section 17.0, with the addition of the following:

1. Perkin Elmer Corporation. Analytical Methods for Atomic Absorption Spectrophotometry. 303-0152. Norwalk, Connecticut. September 1976. pp. 5-6.
2. Standard Specification for Reagent Water. In: Annual Book of American Society for Testing and Materials Standards. Part 31: Water, Atmospheric Analysis. American Society for Testing and Materials. Philadelphia, PA. 1974. pp. 40-42.
3. Stack Sampling Safety Manual (Draft). U.S. Environmental Protection Agency, Office of Air Quality Planning and Standard, Research Triangle Park, NC. September 1978.

### *18.0 Tables, Diagrams, Flowcharts, and Validation Data*

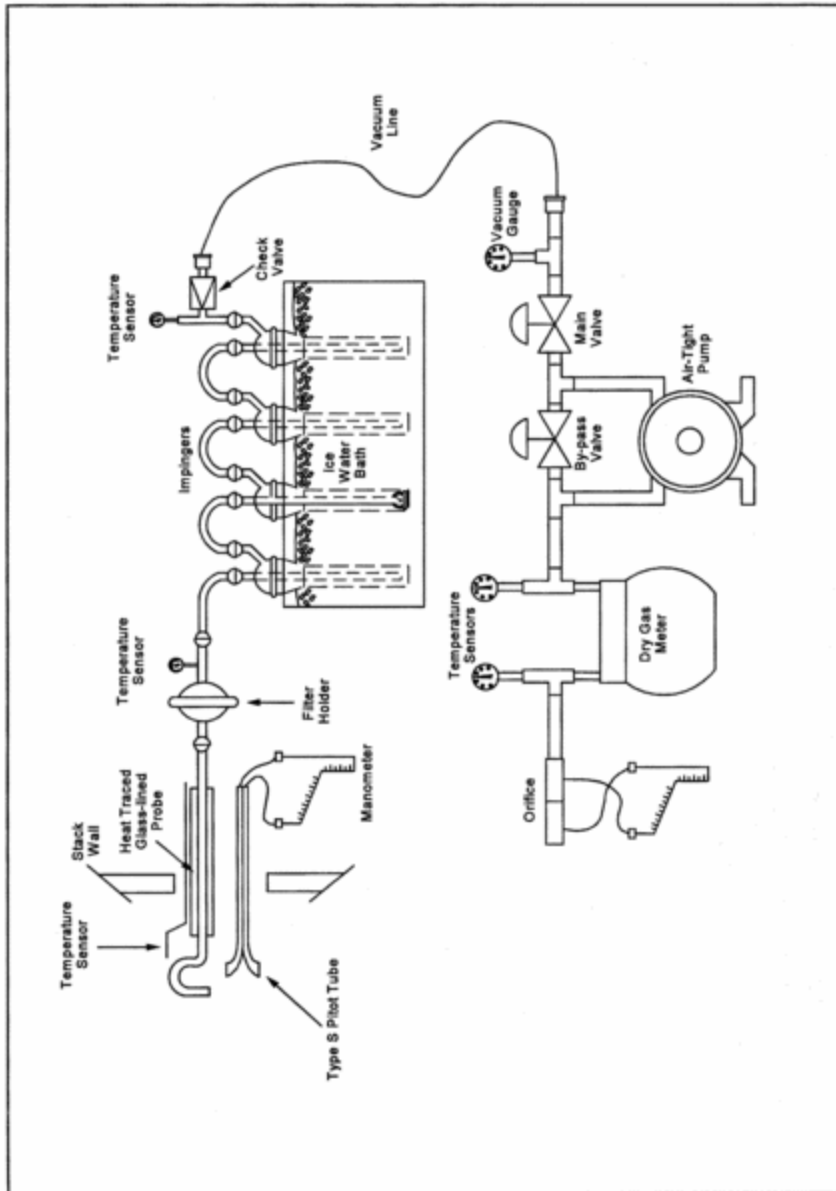

Figure 108-1. Arsenic Sampling Train

[View or download PDF](#)



Analyte	CAS No.	Sensitivity
Arsenic compounds as arsenic (As)	7440-38-2	Lower limit 10 µg/ml or less.

1.2 Applicability. This method applies to the determination of inorganic As content of process ore and reverberatory matte samples from nonferrous smelters and other sources as specified in an applicable subpart of the regulations.

1.3 Data Quality Objectives. Adherence to the requirements of this method will enhance the quality of the data obtained from air pollutant sampling methods.

## 2.0 Summary of Method

Arsenic bound in ore samples is liberated by acid digestion and analyzed by flame atomic absorption spectrophotometry (AAS).

## 3.0 Definitions [Reserved]

## 4.0 Interferences

Analysis for As by flame AAS is sensitive to the chemical composition and to the physical properties (e.g., viscosity, pH) of the sample. The analytical procedure includes a check for matrix effects (section 11.5).

## 5.0 Safety

5.1 Disclaimer. This method may involve hazardous materials, operations, and equipment. This test method may not address all of the safety problems associated with its use. It is the responsibility of the user to establish appropriate safety and health practices and determine the applicability of regulatory limitations prior to performing this test method.

5.2 Corrosive Reagents. The following reagents are hazardous. Personal protective equipment and safe procedures that prevent chemical splashes are recommended. If contact occurs, immediately flush with copious amounts of water for at least 15 minutes. Remove clothing under shower and decontaminate. Treat residual chemical burns as thermal burns.

5.2.1 Hydrochloric Acid (HCl). Highly corrosive liquid with toxic vapors. Vapors are highly irritating to eyes, skin, nose, and lungs, causing severe damage. May cause bronchitis, pneumonia, or edema of lungs. Exposure to concentrations of 0.13 to 0.2 percent can be lethal to humans in a few minutes. Provide ventilation to limit exposure. Reacts with metals, producing hydrogen gas.

5.2.2 Hydrofluoric Acid (HF). Highly corrosive to eyes, skin, nose, throat, and lungs. Reaction to exposure may be delayed by 24 hours or more. Provide ventilation to limit exposure.

5.2.3 Hydrogen Peroxide (H<sub>2</sub>O<sub>2</sub>). Very harmful to eyes. 30% H<sub>2</sub>O<sub>2</sub> can burn skin, nose, and lungs.

5.2.4 Nitric Acid (HNO<sub>3</sub>). Highly corrosive to eyes, skin, nose, and lungs. Vapors are highly toxic and can cause bronchitis, pneumonia, or edema of lungs. Reaction to inhalation may be delayed as long as 30

hours and still be fatal. Provide ventilation to limit exposure. Strong oxidizer. Hazardous reaction may occur with organic materials such as solvents.

5.2.5 Sodium Hydroxide (NaOH). Causes severe damage to eyes and skin. Inhalation causes irritation to nose, throat, and lungs. Reacts exothermically with limited amounts of water.

## 6.0 *Equipment and Supplies*

6.1 Sample Collection and Preparation. The following items are required for sample collection and preparation:

6.1.1 Parr Acid Digestion Bomb. Stainless steel with vapor-tight Teflon cup and cover.

6.1.2 Volumetric Pipets. 2- and 5-ml sizes.

6.1.3 Volumetric Flask. 50-ml polypropylene with screw caps, (one needed per standard).

6.1.4 Funnel. Polyethylene or polypropylene.

6.1.5 Oven. Capable of maintaining a temperature of approximately 105 °C (221 °F).

6.1.6 Analytical Balance. To measure to within 0.1 mg.

6.2 Analysis. The following items are required for analysis:

6.2.1 Spectrophotometer and Recorder. Equipped with an electrodeless discharge lamp and a background corrector to measure absorbance at 193.7 nm. For measuring samples having less than 10 µg As/ml, use a graphite furnace or vapor generator accessory. The recorder shall match the output of the spectrophotometer.

6.2.2 Volumetric Flasks. Class A, 50-ml (one needed per sample and blank), 500-ml, and 1-liter.

6.2.3 Volumetric Pipets. Class A, 1-, 5-, 10-, and 25-ml sizes.

## 7.0 *Reagents and Standards.*

Unless otherwise indicated, it is intended that all reagents conform to the specifications established by the Committee on Analytical Reagents of the American Chemical Society, where such specifications are available; otherwise, use the best available grade.

7.1 Sample Collection and Preparation. The following reagents are required for sample collection and preparation:

7.1.1 Water. Deionized distilled to meet ASTM D 1193-77 or 91 Type 3 (incorporated by reference— See §61.18). When high concentrations of organic matter are not expected to be present, the  $\text{KMnO}_4$  test for oxidizable organic matter may be omitted. Use in all dilutions requiring water.

7.1.2 Nitric Acid Concentrated.

7.1.3 Nitric Acid, 0.5 N. In a 1-liter volumetric flask containing water, add 32 ml of concentrated HNO<sub>3</sub> and dilute to volume with water.

7.1.4 Hydrofluoric Acid, Concentrated.

7.1.5 Potassium Chloride (KCl) Solution, 10 percent weight by volume (W/V). Dissolve 10 g KCl in water, add 3 ml concentrated HNO<sub>3</sub>, and dilute to 100 ml.

7.1.6 Filter. Teflon filters, 3-micron porosity, 47-mm size. (Available from Millipore Co., type FS, Catalog Number FSLW04700.)

7.1.7 Sodium Borohydride (NaBH<sub>4</sub>), 5 Percent (W/V). Dissolve 50.0 g of NaBH<sub>4</sub> in about 500 ml of 0.1 N NaOH in a 1-liter volumetric flask. Then, dilute to exactly 1.0 liter with 0.1 N NaOH.

7.1.8 Nickel Nitrate, 5 Percent Ni (W/V). Dissolve 24.780 g of nickel nitrate hexahydrate [Ni(NO<sub>3</sub>)<sub>2</sub>·6H<sub>2</sub>O] in water in a 100-ml volumetric flask, and dilute to 100 ml with water.

7.1.9 Nickel Nitrate, 1 Percent Ni (W/V). Pipet 20 ml of 5 percent nickel nitrate solution into a 100-ml volumetric flask, and dilute to 100 ml with water.

7.2 Analysis. The following reagents and standards are required for analysis:

7.2.2 Sodium Hydroxide, 0.1 N. Dissolve 2.00 g of NaOH in water in a 500-ml volumetric flask. Dilute to volume with water.

7.2.3 Nitric Acid, 0.5 N. Same as in Section 7.1.3.

7.2.4 Potassium Chloride Solution, 10 percent. Same as in Section 7.1.5.

7.2.5 Hydrochloric Acid, Concentrated.

7.2.6 Potassium Iodide (KI), 30 Percent (W/V). Dissolve 300 g of KI in about 500 ml of water in a 1-liter volumetric flask. Then, dilute to exactly 1.0 liter with water.

7.2.7 Hydrogen Peroxide, 3 Percent by Volume. Pipet 50 ml of 30 percent H<sub>2</sub>O<sub>2</sub> into a 500-ml volumetric flask, and dilute to exactly 500 ml with water.

7.2.8 Stock Arsenic Standard, 1 mg As/ml. Dissolve 1.3203 g of primary grade As<sub>2</sub>O<sub>3</sub> in 20 ml of 0.1 N NaOH. Slowly add 30 ml of concentrated HNO<sub>3</sub>, and heat in an oven at 105 °C (221 °F) for 2 hours. Allow to cool, and dilute to 1 liter with deionized distilled water.

7.2.9 Nitrous Oxide. Suitable quality for AAS analysis.

7.2.10 Acetylene. Suitable quality for AAS analysis.

7.2.11 Quality Assurance Audit Samples. When making compliance determinations, and upon availability, audit samples may be obtained from the appropriate EPA regional Office or from the responsible enforcement authority.



Note: The responsible enforcement authority should be notified at least 30 days prior to the test date to allow sufficient time for sample delivery.

### 8.0 Sample Collection, Preservation, Transport, and Storage

8.1 Sample Collection. A sample that is representative of the ore lot to be tested must be taken prior to analysis. (A portion of the samples routinely collected for metals analysis may be used provided the sample is representative of the ore being tested.)

8.2 Sample Preparation. The sample must be ground into a finely pulverized state.

### 9.0 Quality Control

Section	Quality control measure	Effect
10.2	Spectrophotometer calibration	Ensure linearity of spectrophotometer response to standards.
11.5	Check for matrix effects	Eliminate matrix effects.

### 10.0 Calibration and Standardizations

Note: Maintain a laboratory log of all calibrations.

10.1 Preparation of Standard Solutions. Pipet 1, 5, 10, and 25 ml of the stock As solution into separate 100-ml volumetric flasks. Add 10 ml KCl solution and dilute to the mark with 0.5 N HNO<sub>3</sub>. This will give standard concentrations of 10, 50, 100, and 250 µg As/ml. For low-level arsenic samples that require the use of a graphite furnace or vapor generator, follow the procedures in Section 11.3:1. Dilute 10 ml of KCl solution to 100 ml with 0.5 N HNO<sub>3</sub> and use as a reagent blank.

10.2 Calibration Curve. Analyze the reagent blank and each standard solution according to the procedures outlined in Section 11.3. Repeat this procedure on each standard solution until two consecutive peaks agree within 3 percent of their average value. Subtract the average peak height (or peak area) of the blank—which must be less than 2 percent of recorder full scale—from the averaged peak heights of each standard solution. If the blank absorbance is greater than 2 percent of full-scale, the probable cause is Hg contamination of a reagent or carry-over of As from a previous sample. Prepare the calibration curve by plotting the corrected peak height of each standard solution versus the corresponding final total As weight in the solution.

10.3 Spectrophotometer Calibration Quality Control. Calculate the least squares slope of the calibration curve. The line must pass through the origin or through a point no further from the origin than ±2 percent of the recorder full scale. Multiply the corrected peak height by the reciprocal of the least squares slope to determine the distance each calibration point lies from the theoretical calibration line. The difference between the calculated concentration values and the actual concentrations must be less than 7 percent for all standards.

Note: For instruments equipped with direct concentration readout devices, preparation of a standard curve will not be necessary. In all cases, follow calibration and operational procedures in the manufacturer's instruction manual.

### *11.0 Analytical Procedure*

11.1 Sample Preparation. Weigh 50 to 500 mg of finely pulverized sample to the nearest 0.1 mg. Transfer the sample into the Teflon cup of the digestion bomb, and add 2 ml each of concentrated  $\text{HNO}_3$  and HF. Seal the bomb immediately to prevent the loss of any volatile arsenic compounds that may form. Heat in an oven at 105 °C (221 °F) for 2 hours. Remove the bomb from the oven and allow to cool. Using a Teflon filter, quantitatively filter the digested sample into a 50-ml polypropylene volumetric flask. Rinse the bomb three times with small portions of 0.5 N  $\text{HNO}_3$ , and filter the rinses into the flask. Add 5 ml of KCl solution to the flask, and dilute to 50 ml with 0.5 N  $\text{HNO}_3$ .

### 11.2 Spectrophotometer Preparation.

11.2.1 Turn on the power; set the wavelength, slit width, and lamp current. Adjust the background corrector as instructed by the manufacturer's manual for the particular atomic absorption spectrophotometer. Adjust the burner and flame characteristics as necessary.

11.2.2 Develop a spectrophotometer calibration curve as outlined in Sections 10.2 and 10.3.

11.3 Arsenic Determination. Analyze an appropriately sized aliquot of each diluted sample (from Section 11.1) until two consecutive peak heights agree within 3 percent of their average value. If applicable, follow the procedures outlined in Section 11.3.1. If the sample concentration falls outside the range of the calibration curve, make an appropriate dilution with 0.5 N  $\text{HNO}_3$  so that the final concentration falls within the range of the curve. Using the calibration curve, determine the As concentration in each sample.

Note: Because instruments vary between manufacturers, no detailed operating instructions will be given here. Instead, the instrument manufacturer's detailed operating instructions should be followed.

11.3.1 Arsenic Determination at Low Concentration. The lower limit of flame AAS is 10  $\mu\text{g As/ml}$ . If the arsenic concentration of any sample is at a lower level, use the vapor generator or graphite furnace which is available as an accessory component. Flame, graphite furnace, or vapor generators may be used for samples whose concentrations are between 10 and 30  $\mu\text{g/ml}$ . Follow the manufacturer's instructions in the use of such equipment.

11.3.1.1 Vapor Generator Procedure. Place a sample containing between 0 and 5  $\mu\text{g}$  of arsenic in the reaction tube, and dilute to 15 ml with water. Since there is some trial and error involved in this procedure, it may be necessary to screen the samples by conventional AAS until an approximate concentration is determined. After determining the approximate concentration, adjust the volume of the sample accordingly. Pipet 15 ml of concentrated HCl into each tube. Add 1 ml of 30 percent KI solution. Place the reaction tube into a 50 °C (120 °F) water bath for 5 minutes. Cool to room temperature. Connect the reaction tube to the vapor generator assembly. When the instrument response has returned to baseline, inject 5.0 ml of 5 percent  $\text{NaBH}_4$  and integrate the resulting spectrophotometer signal over a 30-second time period.

11.3.1.2 Graphite Furnace Procedure. Pipet 5 ml of the digested solution into a 10-ml volumetric flask. Add 1 ml of the 1 percent nickel nitrate solution, 0.5 ml of 50 percent HNO<sub>3</sub>, and 1 ml of the 3 percent H<sub>2</sub>O<sub>2</sub>, and dilute to 10 ml with water. The sample is now ready to inject in the furnace for analysis.

11.4 Run a blank and standard at least after every five samples to check the spectrophotometer calibration. The peak height of the blank must pass through a point no further from the origin than  $\pm 2$  percent of the recorder full scale. The difference between the measured concentration of the standard (the product of the corrected average peak height and the reciprocal of the least squares slope) and the actual concentration of the standard must be less than 7 percent, or recalibration of the analyzer is required.

11.5 Mandatory Check for Matrix Effects on the Arsenic Results. Same as Method 12, Section 11.5.

## 12.0 Data Analysis and Calculations

12.1 Calculate the percent arsenic in the ore sample as follows:

$$\% \text{ As} = \frac{5C_a F_d}{W} \quad \text{Eq. 108A-1}$$

[View or download PDF](#)

Where:

C<sub>a</sub> = Concentration of As as read from the standard curve,  $\mu\text{g/ml}$ .

F<sub>d</sub> = Dilution factor (equals to 1 if the sample has not been diluted).

W = Weight of ore sample analyzed, mg.

5 = (50 ml sample " 100)/(10<sup>3</sup>  $\mu\text{g/mg}$ ).

## 13.0 Method Performance

13.1 Sensitivity. The lower limit of flame AAS is 10  $\mu\text{g As/ml}$ . The analytical procedure includes provisions for the use of a graphite furnace or vapor generator for samples with a lower arsenic concentration.

## 14.0 Pollution Prevention. [Reserved]

## 15.0 Waste Management. [Reserved]

## 16.0 Alternative Procedures

16.1 Alternative Analyzer. Inductively coupled plasma-atomic emission spectrometry (ICP-AES) may be used as an alternative to atomic absorption analysis provided the following conditions are met:

16.1.1 Sample collection, sample preparation, and analytical preparation procedures are as defined in the method except as necessary for the ICP-AES application.

16.1.2 Quality Assurance/Quality Control procedures, including audit material analysis, are conducted as prescribed in the method. The QA acceptance conditions must be met.

16.1.3 The limit of quantitation for the ICP-AES must be demonstrated and the sample concentrations reported should be no less than two times the limit of quantitation. The limit of quantitation is defined as ten times the standard deviation of the blank value. The standard deviation of the blank value is determined from the analysis of seven blanks. It has been reported that for mercury and those elements that form hydrides, a continuous-flow generator coupled to an ICP-AES offers detection limits comparable to cold vapor atomic absorption.

### 17.0 References

Same as References 1 through 9 of Section 17.0 of Method 5, with the addition of the following:

1. Perkin Elmer Corporation. Analytical Methods of Atomic Absorption Spectrophotometry. 303-0152. Norwalk, Connecticut. September 1976. pp 5-6.
2. Ringwald, D. Arsenic Determination on Process Materials from ASARCO's Copper Smelter in Tacoma, Washington. Unpublished Report. Prepared for Emission Measurement Branch, Emission Standards and Engineering Division, U.S. Environmental Protection Agency, Research Triangle Park, North Carolina. August 1980. 35 pp.
3. Stack Sampling Safety Manual (Draft). U.S. Environmental Protection Agency, Office of Air Quality Planning and Standard, Research Triangle Park, NC. September 1978.

### 18.0 Tables, Diagrams, Flowcharts, and Validation Data. [Reserved]

#### Method 108B—Determination of Arsenic Content in Ore Samples From Nonferrous Smelters

Note: This method does not include all of the specifications (*e.g.*, equipment and supplies) and procedures (*e.g.*, sampling and analytical) essential to its performance. Some material is incorporated by reference from other methods in this appendix and in appendix A to 40 CFR part 60. Therefore, to obtain reliable results, persons using this method should have a thorough knowledge of at least the following additional test methods: Method 12 and Method 108A.

### 1.0 Scope and Application

#### 1.1 Analytes.

Analyte	CAS No.	Sensitivity
Arsenic compounds as arsenic (As)	7440-38-2	Lower limit 10 µg/ml.

1.2 Applicability. This method applies to the determination of inorganic As content of process ore and reverberatory matte samples from nonferrous smelters and other sources as specified in an applicable subpart of the regulations. Samples resulting in an analytical concentration greater than 10 µg As/ml may be analyzed by this method. For lower level arsenic samples, Method 108C should be used.

1.3 Data Quality Objectives. Adherence to the requirements of this method will enhance the quality of the data obtained from air pollutant sampling methods.

## 2.0 *Summary of Method*

Arsenic bound in ore samples is liberated by acid digestion and analyzed by flame atomic absorption spectrophotometry (AAS).

## 3.0 *Definitions [Reserved]*

## 4.0 *Interferences*

Analysis for As by flame AAS is sensitive to the chemical composition and to the physical properties (e.g., viscosity, pH) of the sample. The analytical procedure includes a check for matrix effects (Section 11.4).

## 5.0 *Safety*

5.1 Disclaimer. This method may involve hazardous materials, operations, and equipment. This test method may not address all of the safety problems associated with its use. It is the responsibility of the user to establish appropriate safety and health practices and determine the applicability of regulatory limitations prior to performing this test method.

5.2 Corrosive Reagents. The following reagents are hazardous. Personal protective equipment and safe procedures that prevent chemical splashes are recommended. If contact occurs, immediately flush with copious amounts of water for at least 15 minutes. Remove clothing under shower and decontaminate. Treat residual chemical burns as thermal burns.

5.2.1 Hydrochloric acid (HCl). Highly corrosive liquid with toxic vapors. Vapors are highly irritating to eyes, skin, nose, and lungs, causing severe damage. May cause bronchitis, pneumonia, or edema of lungs. Exposure to concentrations of 0.13 to 0.2 percent can be lethal to humans in a few minutes. Provide ventilation to limit exposure. Reacts with metals, producing hydrogen gas.

5.2.2 Hydrofluoric Acid (HF). Highly corrosive to eyes, skin, nose, throat, and lungs. Reaction to exposure may be delayed by 24 hours or more. Provide ventilation to limit exposure.

5.2.3 Nitric Acid (HNO<sub>3</sub>). Highly corrosive to eyes, skin, nose, and lungs. Vapors are highly toxic and can cause bronchitis, pneumonia, or edema of lungs. Reaction to inhalation may be delayed as long as 30 hours and still be fatal. Provide ventilation to limit exposure. Strong oxidizer. Hazardous reaction may occur with organic materials such as solvents.

5.2.4 Perchloric Acid (HClO<sub>4</sub>). Corrosive to eyes, skin, nose, and throat. Provide ventilation to limit exposure. Very strong oxidizer. Keep separate from water and oxidizable materials to prevent vigorous evolution of heat, spontaneous combustion, or explosion. Heat solutions containing HClO<sub>4</sub> only in hoods specifically designed for HClO<sub>4</sub>.

## 6.0 *Equipment and Supplies*

6.1 Sample Preparation. The following items are required for sample preparation:

6.1.1 Teflon Beakers. 150-ml.

- 6.1.2 Graduated Pipets. 5-ml disposable.
- 6.1.3 Graduated Cylinder. 50-ml.
- 6.1.4 Volumetric Flask. 100-ml.
- 6.1.5 Analytical Balance. To measure within 0.1 mg.
- 6.1.6 Hot Plate.
- 6.1.7 Perchloric Acid Fume Hood.

6.2 Analysis. The following items are required for analysis:

- 6.2.1 Spectrophotometer. Equipped with an electrodeless discharge lamp and a background corrector to measure absorbance at 193.7 nm.
- 6.2.2 Beaker and Watch Glass. 400-ml.
- 6.2.3 Volumetric Flask. 1-liter.
- 6.2.4 Volumetric Pipets. 1-, 5-, 10-, and 25-ml.

### 7.0 *Reagents and Standards*

Unless otherwise indicated, it is intended that all reagents conform to the specifications established by the Committee on Analytical Reagents of the American Chemical Society, where such specifications are available; otherwise, use the best available grade.

7.1 Sample Preparation. The following reagents are required for sample preparation:

- 7.1.1 Water. Deionized distilled to meet ASTM D 1193-77 or 91 Type 3 (incorporated by reference—see §61.18).
- 7.1.2 Nitric Acid, Concentrated.
- 7.1.3 Hydrofluoric Acid, Concentrated.
- 7.1.4 Perchloric Acid, 70 Percent.
- 7.1.5 Hydrochloric Acid, Concentrated.

7.2 Analysis. The following reagents and standards are required for analysis:

- 7.2.1 Water. Same as in Section 7.1.1.
- 7.2.2 Stock Arsenic Standard, 1.0 mg As/ml. Dissolve 1.3203 g of primary grade  $\text{As}_2\text{O}_3$  [dried at 105 °C (221 °F)] in a 400-ml beaker with 10 ml of  $\text{HNO}_3$  and 5 ml of  $\text{HCl}$ . Cover with a watch glass, and heat gently until dissolution is complete. Add 10 ml of  $\text{HNO}_3$  and 25 ml of  $\text{HClO}_4$ , evaporate to strong fumes of  $\text{HClO}_4$ , and reduce to about 20 ml volume. Cool, add 100 ml of water and 100 ml of  $\text{HCl}$ , and transfer quantitatively to a 1-liter volumetric flask. Dilute to volume with water and mix.

7.2.3 Acetylene. Suitable quality for AAS analysis.

7.2.4 Air. Suitable quality for AAS analysis.

### 8.0 *Sample Collection, Preservation, Transport, and Storage*

Same as in Method 108A, Sections 8.1 and 8.2.

### 9.0 Quality Control

Section	Quality control measure	Effect
10.2	Spectrophotometer calibration	Ensure linearity of spectrophotometer response to standards.
11.4	Check for matrix effects	Eliminate matrix effects.

### 10.0 *Calibration and Standardization*

Note: Maintain a laboratory log of all calibrations.

10.1 Preparation of Standard Solutions. Pipet 1, 5, 10, and 25 ml of the stock As solution into separate 100-ml volumetric flasks. Add 2 ml of HClO<sub>4</sub>, 10 ml of HCl, and dilute to the mark with water. This will provide standard concentrations of 10, 50, 100, and 250 µg As/ml.

10.2 Calibration Curve and Spectrophotometer Calibration Quality Control. Same as Method 108A, Sections 10.2 and 10.3

### 11.0 *Analytical Procedure*

11.1 Sample Preparation. Weigh 100 to 1000 mg of finely pulverized sample to the nearest 0.1 mg. Transfer the sample to a 150-ml Teflon beaker. Dissolve the sample by adding 15 ml of HNO<sub>3</sub>, 10 ml of HCl, 10 ml of HF, and 10 ml of HClO<sub>4</sub> in the exact order as described, and let stand for 10 minutes. In a HClO<sub>4</sub> fume hood, heat on a hot plate until 2-3 ml of HClO<sub>4</sub> remain, then cool. Add 20 ml of water and 10 ml of HCl. Cover and warm until the soluble salts are in solution. Cool, and transfer quantitatively to a 100-ml volumetric flask. Dilute to the mark with water.

11.2 Spectrophotometer Preparation. Same as in Method 108A, Section 11.2.

11.3 Arsenic Determination. If the sample concentration falls outside the range of the calibration curve, make an appropriate dilution with 2 percent HClO<sub>4</sub>/10 percent HCl (prepared by diluting 2 ml concentrated HClO<sub>4</sub> and 10 ml concentrated HCl to 100 ml with water) so that the final concentration falls within the range of the curve. Using the calibration curve, determine the As concentration in each sample.

Note: Because instruments vary between manufacturers, no detailed operating instructions will be given here. Instead, the instrument manufacturer's detailed operating instructions should be followed.

Run a blank and standard at least after every five samples to check the spectrophotometer calibration. The peak height of the blank must pass through a point no further from the origin than  $\pm 2$  percent of the recorder full scale. The difference between the measured concentration of the standard (the product of the corrected average peak height and the reciprocal of the least squares slope) and the actual concentration of the standard must be less than 7 percent, or recalibration of the analyzer is required.

11.4 Mandatory Check for Matrix Effects on the Arsenic Results. Same as Method 12, Section 11.5.

*12.0 Data Analysis and Calculations*

Same as in Method 108A, Section 12.0.

*13.0 Method Performance*

13.1 Sensitivity. The lower limit of flame AAS is 10  $\mu\text{g As/ml}$ .

*14.0 Pollution Prevention [Reserved]*

*15.0 Waste Management [Reserved]*

*16.0 References*

Same as in Method 108A, Section 16.0.

*17.0 Tables, Diagrams, Flowcharts, and Validation Data [Reserved]*

Method 108C—Determination of Arsenic Content in Ore Samples From Nonferrous Smelters (Molybdenum Blue Photometric Procedure)

Note: This method does not include all of the specifications (*e.g.*, equipment and supplies) and procedures (*e.g.*, sampling and analytical) essential to its performance. Some material is incorporated by reference from other methods in this part. Therefore, to obtain reliable results, persons using this method should have a thorough knowledge of at least Method 108A.

*1.0 Scope and Application*

1.1 Analytes.

Analyte	CAS No.	Sensitivity
Arsenic compounds as arsenic (As)	7440-38-2	Lower limit 0.0002 percent As by weight.

1.2 Applicability. This method applies to the determination of inorganic As content of process ore and reverberatory matte samples from nonferrous smelters and other sources as specified in an applicable subpart of the regulations.

1.3 Data Quality Objectives. Adherence to the requirements of this method will enhance the quality of the data obtained from air pollutant sampling methods.



## 2.0 *Summary of Method*

Arsenic bound in ore samples is liberated by acid digestion and analyzed by the molybdenum blue photometric procedure.

## 3.0 *Definitions. [Reserved]*

## 4.0 *Interferences. [Reserved]*

## 5.0 *Safety*

5.1 **Disclaimer.** This method may involve hazardous materials, operations, and equipment. This test method may not address all of the safety problems associated with its use. It is the responsibility of the user to establish appropriate safety and health practices and determine the applicability of regulatory limitations prior to performing this test method.

5.2 **Corrosive Reagents.** The following reagents are hazardous. Personal protective equipment and safe procedures that prevent chemical splashes are recommended. If contact occurs, immediately flush with copious amounts of water for at least 15 minutes. Remove clothing under shower and decontaminate. Treat residual chemical burns as thermal burns.

5.2.1 **Hydrochloric Acid (HCl).** Highly corrosive liquid with toxic vapors. Vapors are highly irritating to eyes, skin, nose, and lungs, causing severe damage. May cause bronchitis, pneumonia, or edema of lungs. Exposure to concentrations of 0.13 to 0.2 percent can be lethal to humans in a few minutes. Provide ventilation to limit exposure. Reacts with metals, producing hydrogen gas.

5.2.2 **Hydrofluoric Acid (HF).** Highly corrosive to eyes, skin, nose, throat, and lungs. Reaction to exposure may be delayed by 24 hours or more. Provide ventilation to limit exposure.

5.2.3 **Nitric Acid (HNO<sub>3</sub>).** Highly corrosive to eyes, skin, nose, and lungs. Vapors are highly toxic and can cause bronchitis, pneumonia, or edema of lungs. Reaction to inhalation may be delayed as long as 30 hours and still be fatal. Provide ventilation to limit exposure. Strong oxidizer. Hazardous reaction may occur with organic materials such as solvents.

5.2.4 **Perchloric Acid (HClO<sub>4</sub>).** Corrosive to eyes, skin, nose, and throat. Provide ventilation to limit exposure. Very strong oxidizer. Keep separate from water and oxidizable materials to prevent vigorous evolution of heat, spontaneous combustion, or explosion. Heat solutions containing HClO<sub>4</sub> only in hoods specifically designed for HClO<sub>4</sub>.

5.2.5 **Sulfuric acid (H<sub>2</sub>SO<sub>4</sub>).** Rapidly destructive to body tissue. Will cause third degree burns. Eye damage may result in blindness. Inhalation may be fatal from spasm of the larynx, usually within 30 minutes. May cause lung tissue damage with edema. 3 mg/m<sup>3</sup> will cause lung damage in uninitiated. 1 mg/m<sup>3</sup> for 8 hours will cause lung damage or, in higher concentrations, death. Provide ventilation to limit inhalation. Reacts violently with metals and organics.

## 6.0 *Equipment and Supplies*

6.1 **Sample Preparation.** The following items are required for sample preparation:

- 6.1.1 Analytical Balance. To measure to within 0.1 mg.
- 6.1.2 Erlenmeyer Flask. 300-ml.
- 6.1.3 Hot Plate.
- 6.1.4 Distillation Apparatus. No. 6, in ASTM E 50-82, 86, or 90 (Reapproved 1995)(incorporated by reference—see §61.18); detailed in Figure 108C-1.
- 6.1.5 Graduated Cylinder. 50-ml.
- 6.1.6 Perchloric Acid Fume Hood.

6.2 Analysis. The following items are required for analysis:

- 6.2.1 Spectrophotometer. Capable of measuring at 660 nm.
- 6.2.2 Volumetric Flasks. 50- and 100-ml.

## 7.0 *Reagents and Standards*

Unless otherwise indicated, it is intended that all reagents conform to the specifications established by the Committee on Analytical Reagents of the American Chemical Society, where such specifications are available; otherwise, use the best available grade.

7.1 Sample Preparation. The following reagents are required for sample preparation:

- 7.1.1 Water. Deionized distilled to meet ASTM D 1193-77 or 91 Type 3 (incorporated by reference—see §61.18). When high concentrations of organic matter are not expected to be present, the  $\text{KMnO}_4$  test for oxidizable organic matter may be omitted. Use in all dilutions requiring water.
- 7.1.2 Nitric Acid, Concentrated.
- 7.1.3 Hydrofluoric Acid, Concentrated.
- 7.1.4 Sulfuric Acid, Concentrated.
- 7.1.5 Perchloric Acid, 70 Percent.
- 7.1.6 Hydrochloric Acid, Concentrated.
- 7.1.7 Dilute Hydrochloric Acid. Add one part concentrated HCl to nine parts water.
- 7.1.8 Hydrazine Sulfate  $(\text{NH}_2)_2 \cdot \text{H}_2\text{SO}_4$ .
- 7.1.9 Potassium Bromide (KBr).
- 7.1.10 Bromine Water, Saturated.

7.2 Analysis. The following reagents and standards are required for analysis:

7.2.1 Water. Same as in Section 7.1.1.

7.2.2 Methyl Orange Solution, 1 g/liter.

7.2.3 Ammonium Molybdate Solution, 5 g/liter. Dissolve 0.5 g  $(\text{NH}_4)\text{Mo}_7\text{O}_{24}\cdot 4\text{H}_2\text{O}$  in water in a 100-ml volumetric flask, and dilute to the mark. This solution must be freshly prepared.

7.2.4 Standard Arsenic Solution, 10  $\mu\text{g}$  As/ml. Dissolve 0.13203 g of  $\text{As}_2\text{O}_3$  in 100 ml HCl in a 1-liter volumetric flask. Add 200 ml of water, cool, dilute to the mark with water, and mix. Transfer 100 ml of this solution to a 1-liter volumetric flask, add 40 ml HCl, cool, dilute to the mark, and mix.

7.2.5 Hydrazine Sulfate Solution, 1 g/liter. Dissolve 0.1 g of  $[(\text{NH}_2)_2\cdot\text{H}_2\text{SO}_4]$  in water, and dilute to 100 ml in a volumetric flask. This solution must be freshly prepared.

7.2.6 Potassium Bromate ( $\text{KBrO}_3$ ) Solution, 0.03 Percent Weight by Volume (W/V). Dissolve 0.3 g  $\text{KBrO}_3$  in water, and dilute to 1 liter with water.

7.2.7 Ammonium Hydroxide ( $\text{NH}_4\text{OH}$ ), Concentrated.

7.2.8 Boiling Granules.

7.2.9 Hydrochloric Acid, 50 percent by volume. Dilute equal parts concentrated HCl with water.

## 8.0 Sample Collection, Preservation, Transport, and Storage

Same as in Method 108A, Sections 8.1 and 8.2.

## 9.0 Quality Control

Section	Quality control measure	Effect
10.2	Calibration curve preparation	Ensure linearity of spectrophotometric response to standards.

## 10.0 Calibration and Standardizations

Note: Maintain a laboratory log of all calibrations.

10.1 Preparation of Standard Solutions. Transfer 1.0, 2.0, 4.0, 8.0, 12.0, 16.0, and 20.0 ml of standard arsenic solution (10  $\mu\text{g}$ /ml) to each of seven 50-ml volumetric flasks. Dilute to 20 ml with dilute HCl. Add one drop of methyl orange solution and neutralize to the yellow color with dropwise addition of  $\text{NH}_4\text{OH}$ . Just bring back to the red color by dropwise addition of dilute HCl, and add 10 ml in excess. Proceed with the color development as described in Section 11.2.

10.2 Calibration Curve. Plot the spectrophotometric readings of the calibration solutions against  $\mu\text{g}$  As per 50 ml of solution. Use this curve to determine the As concentration of each sample.

10.3 Spectrophotometer Calibration Quality Control. Calculate the least squares slope of the calibration curve. The line must pass through the origin or through a point no further from the origin than  $\pm 2$  percent of the recorder full scale. Multiply the corrected peak height by the reciprocal of the least squares slope to

determine the distance each calibration point lies from the theoretical calibration line. The difference between the calculated concentration values and the actual concentrations must be less than 7 percent for all standards.

## 11.0 Analytical Procedure

### 11.1 Sample Preparation.

11.1.1 Weigh 1.0 g of finely pulverized sample to the nearest 0.1 mg. Transfer the sample to a 300 ml Erlenmeyer flask and add 15 ml of  $\text{HNO}_3$ , 4 ml  $\text{HCl}$ , 2 ml  $\text{HF}$ , 3 ml  $\text{HClO}_4$ , and 15 ml  $\text{H}_2\text{SO}_4$ , in the order listed. In a  $\text{HClO}_4$  fume hood, heat on a hot plate to decompose the sample. Then heat while swirling over an open flame until dense white fumes evolve. Cool, add 15 ml of water, swirl to hydrate the  $\text{H}_2\text{SO}_4$  completely, and add several boiling granules. Cool to room temperature.

11.1.2 Add 1 g of  $\text{KBr}$ , 1 g hydrazine sulfate, and 50 ml  $\text{HCl}$ . Immediately attach the distillation head with thermometer and dip the side arm into a 50-ml graduated cylinder containing 25 ml of water and 2 ml of bromine water. Keep the graduated cylinder immersed in a beaker of cold water during distillation. Distill until the temperature of the vapor in the flask reaches  $107^\circ\text{C}$  ( $225^\circ\text{F}$ ). When distillation is complete, remove the flask from the hot plate, and simultaneously wash down the side arm with water as it is removed from the cylinder.

11.1.3 If the expected arsenic content is in the range of 0.0020 to 0.10 percent, dilute the distillate to the 50-ml mark of the cylinder with water, stopper, and mix. Transfer a 5.0-ml aliquot to a 50-ml volumetric flask. Add 10 ml of water and a boiling granule. Place the flask on a hot plate, and heat gently until the bromine is expelled and the color of methyl orange indicator persists upon the addition of 1 to 2 drops. Cool the flask to room temperature. Neutralize just to the yellow color of the indicator with dropwise additions of  $\text{NH}_4\text{OH}$ . Bring back to the red color by dropwise addition of dilute  $\text{HCl}$ , and add 10 ml excess. Proceed with the molybdenum blue color development as described in Section 11.2.

11.1.4 If the expected arsenic content is in the range of 0.0002 to 0.0010 percent As, transfer either the entire initial distillate or the measured remaining distillate from Section 11.1.2 to a 250-ml beaker. Wash the cylinder with two successive portions of concentrated  $\text{HNO}_3$ , adding each portion to the distillate in the beaker. Add 4 ml of concentrated  $\text{HClO}_4$ , a boiling granule, and cover with a flat watch glass placed slightly to one side. Boil gently on a hot plate until the volume is reduced to approximately 10 ml. Add 3 ml of  $\text{HNO}_3$ , and continue the evaporation until  $\text{HClO}_4$  is refluxing on the beaker cover. Cool briefly, rinse the underside of the watch glass and the inside of the beaker with about 3-5 ml of water, cover, and continue the evaporation to expel all but 2 ml of the  $\text{HClO}_4$ .

Note: If the solution appears cloudy due to a small amount of antimony distilling over, add 4 ml of 50 percent  $\text{HCl}$  and 5 ml of water, cover, and warm gently until clear. If cloudiness persists, add 5 ml of  $\text{HNO}_3$  and 2 ml  $\text{H}_2\text{SO}_4$ . Continue the evaporation of volatile acids to solubilize the antimony until dense white fumes of  $\text{H}_2\text{SO}_4$  appear. Retain at least 1 ml of the  $\text{H}_2\text{SO}_4$ .

11.1.5 To the 2 ml of  $\text{HClO}_4$  solution or 1 ml of  $\text{H}_2\text{SO}_4$  solution, add 15 ml of water, boil gently for 2 minutes, and then cool. Proceed with the molybdenum blue color development by neutralizing the solution directly in the beaker just to the yellow indicator color by dropwise addition of  $\text{NH}_4\text{OH}$ . Obtain the red color by dropwise addition of dilute  $\text{HCl}$ . Transfer the solution to a 50-ml volumetric flask. Rinse

the beaker successively with 10 ml of dilute HCl, followed by several small portions of water. At this point the volume of solution in the flask should be no more than 40 ml. Continue with the color development as described in Section 11.2.

## 11.2 Analysis.

11.2.1 Add 1 ml of  $\text{KBrO}_3$  solution to the flask and heat on a low-temperature hot plate to about 50 °C (122 °F) to oxidize the arsenic and methyl orange. Add 5.0 ml of ammonium molybdate solution to the warm solution and mix. Add 2.0 ml of hydrazine sulfate solution, dilute until the solution comes within the neck of the flask, and mix. Place the flask in a 400 ml beaker, 80 percent full of boiling water, for 10 minutes. Enough heat must be supplied to prevent the water bath from cooling much below the boiling point upon inserting the volumetric flask. Remove the flask, cool to room temperature, dilute to the mark, and mix.

11.2.2 Transfer a suitable portion of the reference solution to an absorption cell, and adjust the spectrophotometer to the initial setting using a light band centered at 660 nm. While maintaining this spectrophotometer adjustment, take the readings of the calibration solutions followed by the samples.

## 12.0 *Data Analysis and Calculations*

Same as in Method 108A, Section 12.0.

## 13.0 *Method Performance. [Reserved]*

## 14.0 *Pollution Prevention. [Reserved]*

## 15.0 *Waste Management. [Reserved]*

## 16.0 *References*

1. Ringwald, D. Arsenic Determination on Process Materials from ASARCO's Copper Smelter in Tacoma, Washington. Unpublished Report. Prepared for the Emission Measurement Branch, Technical Support Division, U.S. Environmental Protection Agency, Research Triangle Park, North Carolina. August 1980. 35 pp.

## 17.0 Tables, Diagrams, Flowcharts, and Validation Data

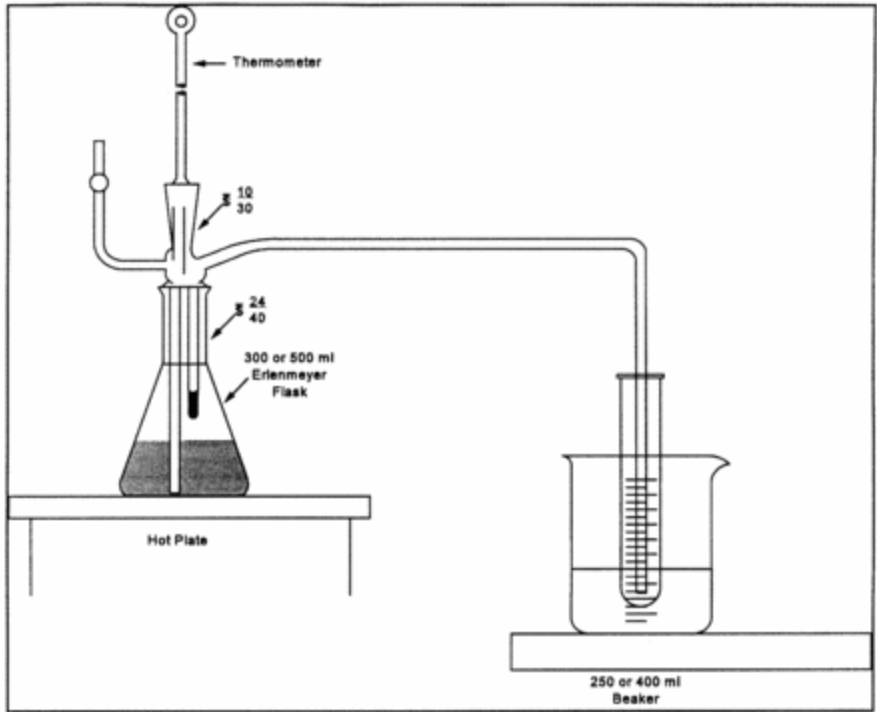

Figure 108C-1. Distillation Apparatus.

[View or download PDF](#)

Method 111—Determination of Polonium-210 Emissions From Stationary Sources

Note: This method does not include all of the specifications (*e.g.*, equipment and supplies) and procedures (*e.g.*, sampling and analytical) essential to its performance. Some material is incorporated by reference from methods in appendix A to 40 CFR part 60. Therefore, to obtain reliable results, persons using this method should have a thorough knowledge of at least the following additional test methods: Method 1, Method 2, Method 3, and Method 5.

1.0 Scope and Application

1.1 Analytes.

Analyte	CAS No.	Sensitivity
Polonium	7440-08-6	Not specified.

1.2 Applicability. This method is applicable for the determination of the polonium-210 content of particulate matter samples collected from stationary source exhaust stacks, and for the use of these data to calculate polonium-210 emissions from individual sources and from all affected sources at a facility.

1.3 Data Quality Objectives. Adherence to the requirements of this method will enhance the quality of the data obtained from air pollutant sampling methods.

2.0 Summary of Method

A particulate matter sample, collected according to Method 5, is analyzed for polonium-210 content: the polonium-210 in the sample is put in solution, deposited on a metal disc, and the radioactive disintegration rate measured. Polonium in acid solution spontaneously deposits on surfaces of metals that are more electropositive than polonium. This principle is routinely used in the radiochemical analysis of polonium-210. Data reduction procedures are provided, allowing the calculation of polonium-210 emissions from individual sources and from all affected sources at a facility, using data obtained from Methods 2 and 5 and from the analytical procedures herein.

### *3.0 Definitions [Reserved]*

### *4.0 Interferences [Reserved]*

### *5.0 Safety*

5.1 Disclaimer. This method may involve hazardous materials, operations, and equipment. This test method may not address all of the safety problems associated with its use. It is the responsibility of the user of this test method to establish appropriate safety and health practices and determine the applicability of regulatory limitations prior to performing this test method.

5.2 Corrosive Reagents. The following reagents are hazardous. Personal protective equipment and safe procedures are useful in preventing chemical splashes. If contact occurs, immediately flush with copious amounts of water at least 15 minutes. Remove clothing under shower and decontaminate. Treat residual chemical burns as thermal burns.

5.2.1 Hydrochloric Acid (HCl). Highly corrosive liquid with toxic vapors. Vapors are highly irritating to eyes, skin, nose, and lungs, causing severe damage. May cause bronchitis, pneumonia, or edema of lungs. Exposure to concentrations of 0.13 to 0.2 percent can be lethal to humans in a few minutes. Provide ventilation to limit exposure. Reacts with metals, producing hydrogen gas.

5.2.2 Hydrofluoric Acid (HF). Highly corrosive to eyes, skin, nose, throat, and lungs. Reaction to exposure may be delayed by 24 hours or more. Provide ventilation to limit exposure.

5.2.3 Nitric Acid (HNO<sub>3</sub>). Highly corrosive to eyes, skin, nose, and lungs. Vapors cause bronchitis, pneumonia, or edema of lungs. Reaction to inhalation may be delayed as long as 30 hours and still be fatal. Provide ventilation to limit exposure. Strong oxidizer. Hazardous reaction may occur with organic materials such as solvents.

5.2.4 Perchloric Acid (HClO<sub>4</sub>). Corrosive to eyes, skin, nose, and throat. Provide ventilation to limit exposure. Keep separate from water and oxidizable materials to prevent vigorous evolution of heat, spontaneous combustion, or explosion. Heat solutions containing HClO<sub>4</sub> only in hoods specifically designed for HClO<sub>4</sub>.

### *6.0 Equipment and Supplies*

6.1 Alpha Spectrometry System. Consisting of a multichannel analyzer, biasing electronics, silicon surface barrier detector, vacuum pump and chamber.

6.2 Constant Temperature Bath at 85 °C (185 °F).

- 6.3 Polished Silver Discs. 3.8 cm diameter, 0.4 mm thick with a small hole near the edge.
- 6.4 Glass Beakers. 400 ml, 150 ml.
- 6.5 Hot Plate, Electric.
- 6.6 Fume Hood.
- 6.7 Teflon Beakers, 150 ml.
- 6.8 Magnetic Stirrer.
- 6.9 Stirring Bar.
- 6.10 Hooks. Plastic or glass, to suspend plating discs.
- 6.11 Internal Proportional Counter. For measuring alpha particles.
- 6.12 Nucleopore Filter Membranes. 25 mm diameter, 0.2 micrometer pore size or equivalent.
- 6.13 Planchets. Stainless steel, 32 mm diameter with 1.5 mm lip.
- 6.14 Transparent Plastic Tape. 2.5 cm wide with adhesive on both sides.
- 6.15 Epoxy Spray Enamel.
- 6.16 Suction Filter Apparatus. For 25 mm diameter filter.
- 6.17 Wash Bottles, 250 ml capacity.
- 6.18 Graduated Cylinder, plastic, 25 ml capacity.
- 6.19 Volumetric Flasks, 100 ml, 250 ml.

#### 7.0 *Reagents and Standards*

Unless otherwise indicated, it is intended that all reagents conform to the specifications established by the Committee on Analytical Reagents of the American Chemical Society, where such specifications are available; otherwise, use the best available grade.

- 7.1 Ascorbic Acid.
- 7.2 Ammonium Hydroxide (NH<sub>4</sub>OH), 15 M.
- 7.3 Water. Deionized distilled, to conform to ASTM D 1193-77 or 91 (incorporated by reference—see §61.18), Type 3. Use in all dilutions requiring water.
- 7.4 Ethanol (C<sub>2</sub>H<sub>5</sub>OH), 95 percent.
- 7.5 Hydrochloric Acid, 12 M.
- 7.6 Hydrochloric Acid, 1 M. Dilute 83 ml of the 12 M HCl to 1 liter with distilled water.



7.7 Hydrofluoric Acid, 29 M.

7.8 Hydrofluoric Acid, 3 M. Dilute 52 ml of the 29 M HF to 500 ml with distilled water. Use a plastic graduated cylinder and storage bottle.

7.9 Lanthanum Carrier, 0.1 mg La<sup>+3</sup>/ml. Dissolve 0.078 gram lanthanum nitrate, La(NO<sub>3</sub>)<sub>3</sub>·6H<sub>2</sub>O in 250 ml of 1 M HCl.

7.10 Nitric Acid, 16 M.

7.11 Perchloric Acid, 12 M.

7.12 Polonium-209 Solution.

7.13 Silver Cleaner. Any mild abrasive commercial silver cleaner.

7.14 Degreaser.

7.15 Standard Solution. Standardized solution of an alpha-emitting actinide element, such as plutonium-239 or americium-241.

8.0 *Sample Collection, Preservation, Transport, and Storage. [Reserved]*

9.0 *Quality Control*

9.1 General Requirement.

9.1.1 All analysts using this method are required to demonstrate their ability to use the method and to define their respective accuracy and precision criteria.

9.2 Miscellaneous Quality Control Measures

Section	Quality control measure	Effect
10.1	Standardization of alpha spectrometry system	Ensure precision of sample analyses.
10.3	Standardization of internal proportional counter	Ensure precise sizing of sample aliquot.
11.1, 11.2	Determination of procedure background and instrument background	Minimize background effects.

10.0 *Calibration and Standardization*

10.1 Standardization of Alpha Spectrometry System.

10.1.1 Add a quantity of the actinide standard solution to a 100 ml volumetric flask so that the final concentration when diluted to a volume of 100 ml will be approximately 1 pCi/ml.

10.1.2 Add 10 ml of 16 M HNO<sub>3</sub> and dilute to 100 ml with water.

10.1.3 Add 20 ml of 1 M HCl to each of six 150 ml beakers. Add 1.0 ml of lanthanum carrier, 0.1 mg lanthanum per ml, to the acid solution in each beaker.

10.1.4 Add 1.0 ml of the 1 pCi/ml working solution (from Section 10.1.1) to each beaker. Add 5.0 ml of 3 M HF to each beaker.

10.1.5 Cover beakers and allow solutions to stand for a minimum of 30 minutes. Filter the contents of each beaker through a separate filter membrane using the suction filter apparatus. After each filtration, wash the filter membrane with 10 ml of distilled water and 5 ml of ethanol, and allow the filter membrane to air dry on the filter apparatus.

10.1.6 Carefully remove the filter membrane and mount it, filtration side up, with double-side tape on the inner surface of a planchet. Place planchet in an alpha spectrometry system and count each planchet for 1000 minutes.

10.1.7 Calculate the counting efficiency of the detector for each aliquot of the 1 pCi/ml actinide working solution using Eq. 111-1 in Section 12.2.

10.1.8 Determine the average counting efficiency of the detector,  $E_c$ , by calculating the average of the six determinations.

## 10.2 Preparation of Standardized Solution of Polonium-209.

10.2.1 Add a quantity of the Po-209 solution to a 100 ml volumetric flask so that the final concentration when diluted to a 100 ml volume will be approximately 1 pCi/ml.

10.2.2 Follow the procedures outlined in Sections 10.1.2 through 10.1.6, except substitute 1.0 ml of polonium-209 tracer solution (Section 10.2.1) and 3.0 ml of 15 M ammonium hydroxide for the 1 pCi/ml actinide working solution and the 3 M HF, respectively.

10.2.3 Calculate the activity of each aliquot of the polonium-209 tracer solution using Eq. 111-2 in Section 12.3.

10.2.4 Determine the average activity of the polonium-209 tracer solution,  $F$ , by averaging the results of the six determinations.

## 10.3 Standardization of Internal Proportional Counter

10.3.1 Add a quantity of the actinide standard solution to a 100 ml volumetric flask so that the final concentration when diluted to a 100 ml volume will be approximately 100 pCi/ml.

10.3.2 Follow the procedures outlined in Sections 10.1.2 through 10.1.6, except substitute the 100 pCi/ml actinide working solution for the 1 pCi/ml solution, place the planchet in an internal proportional counter (instead of an alpha spectrometry system), and count for 100 minutes (instead of 1000 minutes).

10.3.3 Calculate the counting efficiency of the internal proportional counter for each aliquot of the 100 pCi/ml actinide working solution using Eq. 111-3 in 12.4.

10.3.4 Determine the average counting efficiency of the internal proportional counter,  $E_I$ , by averaging the results of the six determinations.

## 11.0 Analytical Procedure

Note: Perform duplicate analyses of all samples, including background counts and Method 5 samples. Duplicate measurements are considered acceptable when the difference between them is less than two standard deviations as described in EPA 600/4-77-001 or subsequent revisions.

11.1 Determination of Procedure Background. Background counts used in all equations are determined by performing the specific analysis required using the analytical reagents only. All procedure background counts and sample counts for the internal proportional counter should utilize a counting time of 100 minutes; for the alpha spectrometry system, 1000 minutes. These background counts should be performed no less frequently than once per 10 sample analyses.

11.2 Determination of Instrument Background. Instrument backgrounds of the internal proportional counter and the alpha spectrometry system should be determined on a weekly basis. Instrument background should not exceed procedure background. If this occurs, it may be due to a malfunction or contamination, and should be corrected before use.

11.4 Sample Preparation. Treat the Method 5 samples [*i.e.*, the glass fiber filter (Container No. 1) and the acetone rinse (Container No. 2)] as follows:

11.4.1 Container No. 1. Transfer the filter and any loose particulate matter from the sample container to a 150-ml Teflon beaker.

11.4.2 Container No. 2. Note the level of liquid in the container, and confirm on the analysis sheet whether leakage occurred during transport. If a noticeable amount of leakage has occurred, either void the sample or use methods, subject to the approval of the Administrator, to correct the final results. Transfer the contents to a 400-ml glass beaker. Add polonium-209 tracer solution to the glass beaker in an amount approximately equal to the amount of polonium-210 expected in the total particulate sample. Record the activity of the tracer solution added. Add 16 M nitric acid to the beaker to digest and loosen the residue.

11.4.3 Transfer the contents of the glass beaker to the Teflon beaker containing the glass fiber filter. Rinse the glass beaker with 16 M  $\text{HNO}_3$ . If necessary, reduce the volume in the beaker by evaporation until all of the nitric acid  $\text{HNO}_3$  from the glass beaker has been transferred to the Teflon beaker.

11.4.4 Add 30 ml of 29 M HF to the Teflon beaker and evaporate to near dryness on a hot plate in a properly operating hood.

Note: Do not allow the residue to go to dryness and overheat; this will result in loss of polonium.

11.4.5 Repeat step 11.4.4 until the filter is dissolved.

11.4.6 Add 100 ml of 16 M  $\text{HNO}_3$  to the residue in the Teflon beaker and evaporate to near dryness.

Note: Do not allow the residue to go to dryness.

11.4.7 Add 50 ml of 16 M HNO<sub>3</sub> and 10 ml of 12 M perchloric acid to the Teflon beaker and heat until dense fumes of perchloric acid are evolved.

11.4.8 Repeat steps 11.4.4 to 11.4.7 as necessary until sample is completely dissolved.

11.4.9 Add 10 ml of 12 M HCl to the Teflon beaker and evaporate to dryness. Repeat additions and evaporations several times.

11.4.10 Transfer the sample to a 250-ml volumetric flask and dilute to volume with 3 M HCl.

11.5 Sample Screening. To avoid contamination of the alpha spectrometry system, check each sample as follows:

11.5.1 Add 20 ml of 1 M HCl, 1 ml of the lanthanum carrier solution (0.1 mg La/ml), a 1 ml aliquot of the sample solution from Section 11.4.10, and 3 ml of 15 M ammonium hydroxide to a 250-ml beaker in the order listed. Allow this solution to stand for a minimum of 30 minutes.

11.5.2 Filter the solution through a filter membrane using the suction filter apparatus. Wash the filter membrane with 10 ml of water and 5 ml of ethanol, and allow the filter membrane to air dry on the filter apparatus.

11.5.3 Carefully remove the filter membrane and mount it, filtration side up, with double-side tape on the inner surface of a planchet. Place the planchet in an internal proportional counter, and count for 100 minutes.

11.5.4 Calculate the activity of the sample using Eq. 11-4 in Section 12.5.

11.5.5 Determine the aliquot volume of the sample solution from Section 11.4.10 to be analyzed for polonium-210, such that the aliquot contains an activity between 1 and 4 picocuries. Use Eq. 11-5 in Section 12.6.

11.6 Preparation of Silver Disc for Spontaneous Electrodeposition.

11.6.1 Clean both sides of the polished silver disc with silver cleaner and with degreaser.

11.6.2 Place disc on absorbent paper and spray one side with epoxy spray enamel. This should be carried out in a well-ventilated area, with the disc lying flat to keep paint on one side only. Allow paint to dry for 24 hours before using disc for deposition.

11.7 Sample Analysis.

11.7.1 Add the aliquot of sample solution from Section 11.4.10 to be analyzed for polonium-210, the volume of which was determined in Section 11.5.5, to a suitable 200-ml container to be placed in a constant temperature bath.

Note: Aliquot volume may require a larger container.

11.7.2 If necessary, bring the volume to 100 ml with 1 M HCl. If the aliquot volume exceeds 100 ml, use total aliquot.

11.7.3 Add 200 mg of ascorbic acid and heat solution to 85 °C (185 °F) in a constant temperature bath.

11.7.4 Suspend a silver disc in the heated solution using a glass or plastic rod with a hook inserted through the hole in the disc. The disc should be totally immersed in the solution, and the solution must be stirred constantly, at all times during the plating operation. Maintain the disc in solution for 3 hours.

11.7.5 Remove the silver disc, rinse with deionized distilled water, and allow to air dry at room temperature.

11.7.6 Place the disc, with deposition side (unpainted side) up, on a planchet and secure with double-side plastic tape. Place the planchet with disc in alpha spectrometry system and count for 1000 minutes.

## 12.0 Data Analysis and Calculations.

### 12.1 Nomenclature.

$A$  = Picocuries of polonium-210 in the Method 5 sample (from Section 12.8).

$A_A$  = Picocuries of actinide added.

$A_L$  = Volume of sample aliquot used, in ml (specified in Section 11.5.1 as 1 ml).

$A_S$  = Aliquot to be analyzed, in ml.

$B_B$  = Procedure background counts measured in polonium-209 spectral region.

$B_T$  = Polonium-209 tracer counts in sample.

$C_T$  = Total counts in polonium-210 spectral region.

$D$  = Decay correction for time “t” (in days) from sample collection to sample counting, given by:  $D = e^{-0.005t}$

$E_C$  = Average counting efficiency of detector (from Section 10.1.8), as counts per disintegration.

$E_{Ci}$  = Counting efficiency of the detector for aliquot i of the actinide working solution, counts per disintegration.

$E_I$  = Average counting efficiency of the internal proportional counter, as determined in Section 10.3.4, counts per disintegration.

$E_{Ii}$  = Counting efficiency of the internal proportional counter for aliquot i of the 100 pCi/ml actinide working solution, counts per disintegration.

$E_Y$  = The fraction of polonium-209 recovered on the planchet (from Section 12.7).

$F$  = Average activity of polonium-209 in sample (from Section 10.2.4), in pCi.

$F_i$  = activity of aliquot  $i$  of the polonium-209 tracer solution, in pCi.

$L$  = Dilution factor (unitless). This is the volume of sample solution prepared (specified as 250 ml in Section 11.1.10) divided by the volume of the aliquot of sample solution analyzed for polonium-210 (from Section 11.7.1).

$M_i$  = Phosphorous rock processing rate of the source being tested, during run  $i$ , Mg/hr.

$M_k$  = Phosphate rock processed annually by source  $k$ , in Mg/yr.

$n$  = Number of calciners at the elemental phosphorus plant.

$P$  = Total activity of sample solution from Section 11.4.10, in pCi (see Eq. 111-4).

$Q_{sd}$  = Volumetric flow rate of effluent stream, as determined by Method 2, in dscm/hr.

$S$  = Annual polonium-210 emissions from the entire facility, in curies/yr.

$V_{m(std)}$  = Volume of air sample, as determined by Method 5, in dscm.

$X_k$  = Emission rate from source  $k$ , from Section 12.10, in curies/Mg.

$10^{-12}$  = Curies per picocurie.

2.22 = Disintegrations per minute per picocurie.

250 = Volume of solution from Section 11.4.10, in ml.

12.2 Counting Efficiency. Calculate the counting efficiency of the detector for each aliquot of the 1 pCi/ml actinide working solution using Eq. 111-1.

$$E_{Ci} = \frac{C_S - C_B}{2.22 A_A T} \quad \text{Eq. 111-1}$$

[View or download PDF](#)

Where:

$C_B$  = Background counts in same peak area as  $C_S$ .

$C_S$  = Gross counts in actinide peak.

$T$  = Counting time in minutes, specified in Section 10.1.6 as 1000 minutes.

12.3 Polonium-209 Tracer Solution Activity. Calculate the activity of each aliquot of the polonium-209 tracer solution using Eq. 111-2.

$$F_i = \frac{C_S - C_B}{2.22 E_{Ci} T} \quad \text{Eq. 111-2}$$

[View or download PDF](#)

Where:

$C_B$  = Background counts in the 4.88 MeV region of spectrum the in the counting time T.

$C_S$  = Gross counts of polonium-209 in the 4.88 MeV region of the spectrum in the counting time T.

T = Counting time, specified in Section 10.1.6 as 1000 minutes.

12.4 Control Efficiency of Internal Proportional Counter. Calculate the counting efficiency of the internal proportional counter for each aliquot of the 100 pCi/ml actinide working solution using Eq. 111-3.

$$E_{II} = \frac{C_S - C_B}{2.22 A_A T} \quad \text{Eq. 111-3}$$

[View or download PDF](#)

Where:

$C_B$  = Gross counts of procedure background.

$C_S$  = Gross counts of standard.

T = Counting time in minutes, specified in Section 10.3.2 as 100 minutes.

12.5 Calculate the activity of the sample using Eq. 111-4.

$$P = \frac{250 (C_S - C_B)}{2.22 \bar{E}_I A_L T} \quad \text{Eq. 111-4}$$

[View or download PDF](#)

Where:

$C_B$  = Total counts of procedure background. (See Section 11.1).

$C_S$  = Total counts of screening sample.

T = Counting time for sample and background (which must be equal), in minutes (specified in Section 11.5.3 as 100 minutes).

12.6 Aliquot Volume. Determine the aliquot volume of the sample solution from Section 11.4.10 to be analyzed for polonium-210, such that the aliquot contains an activity between 1 and 4 picocuries using Eq. 111-5.

$$A_s = \frac{250 (\text{desired picocuries in aliquot})}{P} \quad \text{Eq. 111-5}$$

[View or download PDF](#)

12.7 Polonium-209 Recovery. Calculate the fraction of polonium-209 recovered on the planchet,  $E_Y$ , using Eq. 111-6.

$$E_Y = \frac{B_T - B_B}{2.22 F E_C T} \quad \text{Eq. 111-6}$$

[View or download PDF](#)

Where:

T = Counting time, specified in Section 11.1 as 1000 minutes.

12.8 Polonium-210 Activity. Calculate the activity of polonium-210 in the Method 5 sample (including glass fiber filter and acetone rinse) using Eq. 111-7.

$$A = \frac{(C_T - C_B)L}{2.22 E_Y E_C T D} \quad \text{Eq. 111-7}$$

[View or download PDF](#)

Where:

C<sub>B</sub> = Procedure background counts in polonium-210 spectral region.

T = Counting time, specified in Section 11.1 as 1000 minutes for all alpha spectrometry sample and background counts.

12.9 Emission Rate from Each Stack.

12.9.1 For each test run, i, on a stack, calculate the measured polonium-210 emission rate, R<sub>Si</sub>, using Eq. 111-8.

$$R_{Si} = \frac{(10^{-12}) A Q_{sd}}{V_{m(s,d)} M_1} \quad \text{Eq. 111-8}$$

[View or download PDF](#)

12.9.2 Determine the average polonium-210 emission rate from the stack, R<sub>S</sub>, by taking the sum of the measured emission rates for all runs, and dividing by the number of runs performed.

12.9.3 Repeat steps 12.9.1 and 12.9.2 for each stack of each calciner.

12.10 Emission Rate from Each Source. Determine the total polonium-210 emission rate, X<sub>k</sub>, from each source, k, by taking the sum of the average emission rates from all stacks to which the source exhausts.

12.11 Annual Polonium-210 Emission Rate from Entire Facility. Determine the annual elemental phosphorus plant emissions of polonium-210, S, using Eq. 111-9.

$$S = \frac{\sum_{k=1}^n (X_k M_k)}{n} \quad \text{Eq. 111-9}$$

[View or download PDF](#)

13.0 Method Performance. [Reserved]



#### 14.0 *Pollution Prevention. [Reserved]*

#### 15.0 *Waste Management. [Reserved]*

#### 16.0 *References*

1. Blanchard, R.L. "Rapid Determination of Lead-210 and Polonium-210 in Environmental Samples by Deposition on Nickel." *Anal. Chem.*, 38:189, pp. 189-192. February 1966.

#### 17.0 *Tables, Diagrams, Flowcharts, and Validation Data [Reserved]*

### Method 114—Test Methods for Measuring Radionuclide Emissions from Stationary Sources

#### 1. *Purpose and Background*

This method provides the requirements for: (1) Stack monitoring and sample collection methods appropriate for radionuclides; (2) radiochemical methods which are used in determining the amounts of radionuclides collected by the stack sampling and; (3) quality assurance methods which are conducted in conjunction with these measurements. These methods are appropriate for emissions for stationary sources. A list of references is provided.

Many different types of facilities release radionuclides into air. These radionuclides differ in the chemical and physical forms, half-lives and type of radiation emitted. The appropriate combination of sample extraction, collection and analysis for an individual radionuclide is dependent upon many interrelated factors including the mixture of other radionuclides present. Because of this wide range of conditions, no single method for monitoring or sample collection and analysis of a radionuclide is applicable to all types of facilities. Therefore, a series of methods based on "principles of measurement" are described for monitoring and sample collection and analysis which are applicable to the measurement of radionuclides found in effluent streams at stationary sources. This approach provides the user with the flexibility to choose the most appropriate combination of monitoring and sample collection and analysis methods which are applicable to the effluent stream to be measured.

#### 2. *Stack Monitoring and Sample Collection Methods*

Monitoring and sample collection methods are described based on "principles of monitoring and sample collection" which are applicable to the measurement of radionuclides from effluent streams at stationary sources. Radionuclides of most elements will be in the particulate form in these effluent streams and can be readily collected using a suitable filter media. Radionuclides of hydrogen, oxygen, carbon, nitrogen, the noble gases and in some circumstances iodine will be in the gaseous form. Radionuclides of these elements will require either the use of an in-line or off-line monitor to directly measure the radionuclides, or suitable sorbers, condensers or bubblers to collect the radionuclides.

2.1 Radionuclides as Particulates. The extracted effluent stream is passed through a filter media to remove the particulates. The filter must have a high efficiency for removal of sub-micron particles. The guidance in ANSI/HPS N13.1-1999 (section 6.6.2 Filter media) shall be followed in using filter media to collect particulates (incorporated by reference—see §61.18 of this part).

2.2 Radionuclides as Gases.

2.2.1 The Radionuclide Tritium (H-3). Tritium in the form of water vapor is collected from the extracted effluent sample by sorption, condensation or dissolution techniques. Appropriate collectors may include silica gel, molecular sieves, and ethylene glycol or water bubblers.

Tritium in the gaseous form may be measured directly in the sample stream using Method B-1, collected as a gas sample or may be oxidized using a metal catalyst to tritiated water and collected as described above.

2.2.2 Radionuclides of Iodine. Iodine is collected from an extracted sample by sorption or dissolution techniques. Appropriate collectors may include charcoal, impregnated charcoal, metal zeolite and caustic solutions.

2.2.3 Radionuclides of Argon, Krypton and Xenon. Radionuclides of these elements are either measured directly by an in-line or off-line monitor, or are collected from the extracted sample by low temperature sorption techniques, Appropriate sorbers may include charcoal or metal zeolite.

2.2.4 Radionuclides of Oxygen, Carbon, Nitrogen and Radon. Radionuclides of these elements are measured directly using an in-line or off-line monitor. Radionuclides of carbon in the form of carbon dioxide may be collected by dissolution in caustic solutions.

### 2.3 Definition of Terms

*In-line monitor* means a continuous measurement system in which the detector is placed directly in or adjacent to the effluent stream. This may involve either gross radioactivity measurements or specific radionuclide measurements. Gross measurements shall be made in conformance with the conditions specified in Methods A-4, B-2 and G-4.

*Off-line monitor* means a measurement system in which the detector is used to continuously measure an extracted sample of the effluent stream. This may involve either gross radioactivity measurements or specific radionuclide measurements. Gross measurements shall be made in conformance with the conditions specified in Methods A-4, B-2 and G-4.

*Sample collection* means a procedure in which the radionuclides are removed from an extracted sample of the effluent using a collection media. These collection media include filters, absorbers, bubblers and condensers. The collected sample is analyzed using the methods described in Section 3.

### 3. Radionuclide Analysis Methods

A series of methods based on “principles of measurement” are described which are applicable to the analysis of radionuclides collected from airborne effluent streams at stationary sources. These methods are applicable only under the conditions stated and within the limitations described. Some methods specify that only a single radionuclide be present in the sample or the chemically separated sample. This condition should be interpreted to mean that no other radionuclides are present in quantities which would interfere with the measurement.

Also identified (Table 1) are methods for a selected list of radionuclides. The listed radionuclides are those which are most commonly used and which have the greatest potential for causing dose to members of the public. Use of methods based on principles of measurement other than those described in this

section must be approved in advance of use by the Administrator. For radionuclides not listed in Table 1, any of the described methods may be used provided the user can demonstrate that the applicability conditions of the method have been met.

The type of method applicable to the analysis of a radionuclide is dependent upon the type of radiation emitted, i.e., alpha, beta or gamma. Therefore, the methods described below are grouped according to principles of measurements for the analysis of alpha, beta and gamma emitting radionuclides.

### 3.1 Methods for Alpha Emitting Radionuclides

#### 3.1.1 Method A-1, Radiochemistry-Alpha Spectrometry.

*Principle:* The element of interest is separated from other elements, and from the sample matrix using radiochemical techniques. The procedure may involve precipitation, ion exchange, or solvent extraction. Carriers (elements chemically similar to the element of interest) may be used. The element is deposited on a planchet in a very thin film by electrodeposition or by coprecipitation on a very small amount of carrier, such as lanthanum fluoride. The deposited element is then counted with an alpha spectrometer. The activity of the nuclide of interest is measured by the number of alpha counts in the appropriate energy region. A correction for chemical yield and counting efficiency is made using a standardized radioactive nuclide (tracer) of the same element. If a radioactive tracer is not available for the element of interest, a predetermined chemical yield factor may be used.

*Applicability:* This method is applicable for determining the activity of any alpha-emitting radionuclide, regardless of what other radionuclides are present in the sample provided the chemical separation step produces a very thin sample and removes all other radionuclides which could interfere in the spectral region of interest. APHA-605(2), ASTM-D-3972(13).

#### 3.1.2 Method A-2, Radiochemistry-Alpha Counting.

*Principle:* The element of interest is separated from other elements, and from the sample matrix using radiochemistry. The procedure may involve precipitation, ion exchange, or solvent extraction. Carriers (elements chemically similar to the element of interest) may be used. The element is deposited on a planchet in a thin film and counted with an alpha counter. A correction for chemical yield (if necessary) is made. The alpha count rate measures the total activity of all emitting radionuclides of the separated element.

*Applicability:* This method is applicable for the measurement of any alpha-emitting radionuclide, provided no other alpha emitting radionuclide is present in the separated sample. It may also be applicable for determining compliance, when other radionuclides of the separated element are present, provided that the calculated emission rate is assigned to the radionuclide which could be present in the sample that has the highest dose conversion factor. IDO-12096(18).

#### 3.1.3 Method A-3, Direct Alpha Spectrometry.

*Principle:* The sample, collected on a suitable filter, is counted directly on an alpha spectrometer. The sample must be thin enough and collected on the surface of the filter so that any absorption of alpha particle energy in the sample or the filter, which would degrade the spectrum, is minimal.

*Applicability:* This method is applicable to simple mixtures of alpha emitting radionuclides and only when the amount of particulates collected on the filter paper are relatively small and the alpha spectra is adequately resolved. Resolutions should be 50 keV (FWHM) or better, ASTM-D-3084(16).

#### 3.1.4 Method A-4, Direct Alpha Counting (Gross alpha determination).

*Principle:* The sample, collected on a suitable filter, is counted with an alpha counter. The sample must be thin enough so that self-absorption is not significant and the filter must be of such a nature that the particles are retained on the surface.

*Applicability:* Gross alpha determinations may be used to measure emissions of specific radionuclides only (1) when it is known that the sample contains only a single radionuclide, or the identity and isotopic ratio of the radionuclides in the sample are well-known, and (2) measurements using either Method A-1, A-2 or A-5 have shown that this method provides a reasonably accurate measurement of the emission rate. Gross alpha measurements are applicable to unidentified mixtures of radionuclides only for the purposes and under the conditions described in section 3.7. APHA-601(3), ASTM-D-1943(10).

#### 3.1.5 Method A-5, Chemical Determination of Uranium.

*Principle:* Uranium may be measured chemically by either colorimetry or fluorometry. In both procedures, the sample is dissolved, the uranium is oxidized to the hexavalent form and extracted into a suitable solvent. Impurities are removed from the solvent layer. For colorimetry, dibenzoylmethane is added, and the uranium is measured by the absorbance in a colorimeter. For fluorometry, a portion of the solution is fused with a sodium fluoride-lithium fluoride flux and the uranium is determined by the ultraviolet activated fluorescence of the fused disk in a fluorometer.

*Applicability:* This method is applicable to the measurements of emission rates of uranium when the isotopic ratio of the uranium radionuclides is well known. ASTM-E-318(15), ASTM-D-2907(14).

#### 3.1.6 Method A-6, Radon-222—Continuous Gas Monitor.

*Principle:* Radon-222 is measured directly in a continuously extracted sample stream by passing the air stream through a calibrated scintillation cell. Prior to the scintillation cell, the air stream is treated to remove particulates and excess moisture. The alpha particles from radon-222 and its decay products strike a zinc sulfide coating on the inside of the scintillation cell producing light pulses. The light pulses are detected by a photomultiplier tube which generates electrical pulses. These pulses are processed by the system electronics and the read out is in pCi/l of radon-222.

*Applicability:* This method is applicable to the measurement of radon-222 in effluent streams which do not contain significant quantities of radon-220. Users of this method should calibrate the monitor in a radon calibration chamber at least twice per year. The background of the monitor should also be checked periodically by operating the instrument in a low radon environment. EPA 520/1-89-009(24).

#### 3.1.7 Method A-7, Radon-222-Alpha Track Detectors

*Principle:* Radon-222 is measured directly in the effluent stream using alpha track detectors (ATD). The alpha particles emitted by radon-222 and its decay products strike a small plastic strip and produce submicron damage tracks. The plastic strip is placed in a caustic solution that accentuates the damage

tracks which are counted using a microscope or automatic counting system. The number of tracks per unit area is correlated to the radon concentration in air using a conversion factor derived from data generated in a radon calibration facility.

*Applicability:* Prior approval from EPA is required for use of this method. This method is only applicable to effluent streams which do not contain significant quantities of radon-220, unless special detectors are used to discriminate against radon-220. This method may be used only when ATDs have been demonstrated to produce data comparable to data obtained with Method A-6. Such data should be submitted to EPA when requesting approval for the use of this method. EPA 520/1-89-009(24).

### 3.2 Methods for Gaseous Beta Emitting Radionuclides.

#### 3.2.1 Method B-1, Direct Counting in Flow-Through Ionization Chambers.

*Principle:* An ionization chamber containing a specific volume of gas which flows at a given flow rate through the chamber is used. The sample (effluent stream sample) acts as the counting gas for the chamber. The activity of the radionuclide is determined from the current measured in the ionization chamber.

*Applicability:* This method is applicable for measuring the activity of a gaseous beta-emitting radionuclide in an effluent stream that is suitable as a counting gas, when no other beta-emitting nuclides are present. DOE/EP-0096(17), NCRP-58(23).

#### 3.2.2 Method B-2, Direct Counting With In-line or Off-line Beta Detectors.

*Principle:* The beta detector is placed directly in the effluent stream (in-line) or an extracted sample of the effluent stream is passed through a chamber containing a beta detector (off-line). The activities of the radionuclides present in the effluent stream are determined from the beta count rate, and a knowledge of the radionuclides present and the relationship of the gross beta count rate and the specific radionuclide concentration.

*Applicability:* This method is applicable only to radionuclides with maximum beta particle energies greater than 0.2 MeV. This method may be used to measure emissions of specific radionuclides only when it is known that the sample contains only a single radionuclide or the identity and isotopic ratio of the radionuclides in the effluent stream are well known. Specific radionuclide analysis of periodic grab samples may be used to identify the types and quantities of radionuclides present and to establish the relationship between specific radionuclide analyses and gross beta count rates.

This method is applicable to unidentified mixtures of gaseous radionuclides only for the purposes and under the conditions described in section 3.7.

### 3.3 Methods for Non-Gaseous Beta Emitting Radionuclides.

#### 3.3.1 Method B-3, Radiochemistry-Beta Counting.

*Principle:* The element of interest is separated from other elements, and from the sample matrix by radiochemistry. This may involve precipitation, distillation, ion exchange, or solvent extraction. Carriers (elements chemically similar to the element of interest) may be used. The element is deposited on a

planchet, and counted with a beta counter. Corrections for chemical yield, and decay (if necessary) are made. The beta count rate determines the total activity of all radionuclides of the separated element. This method may also involve the radiochemical separation and counting of a daughter element, after a suitable period of ingrowth, in which case it is specific for the parent nuclide.

*Applicability:* This method is applicable for measuring the activity of any beta-emitting radionuclide, with a maximum energy greater than 0.2 MeV, provided no other radionuclide is present in the separated sample. APHA-608(5).

### 3.3.2 Method B-4, Direct Beta Counting (Gross beta determination).

*Principle:* The sample, collected on a suitable filter, is counted with a beta counter. The sample must be thin enough so that self-absorption corrections can be made.

*Applicability:* Gross beta measurements are applicable only to radionuclides with maximum beta particle energies greater than 0.2 MeV. Gross beta measurements may be used to measure emissions of specific radionuclides only (1) when it is known that the sample contains only a single radionuclide, and (2) measurements made using Method B-3 show reasonable agreement with the gross beta measurement. Gross beta measurements are applicable to mixtures of radionuclides only for the purposes and under the conditions described in section 3.7. APHA-602(4), ASTM-D-1890(11).

### 3.3.3 Method B-5, Liquid Scintillation Spectrometry.

*Principle:* An aliquot of a collected sample or the result of some other chemical separation or processing technique is added to a liquid scintillation “cocktail” which is viewed by photomultiplier tubes in a liquid scintillation spectrometer. The spectrometer is adjusted to establish a channel or “window” for the pulse energy appropriate to the nuclide of interest. The activity of the nuclide of interest is measured by the counting rate in the appropriate energy channel. Corrections are made for chemical yield where separations are made.

*Applicability:* This method is applicable to any beta-emitting nuclide when no other radionuclide is present in the sample or the separated sample provided that it can be incorporated in the scintillation cocktail. This method is also applicable for samples which contain more than one radionuclide but only when the energies of the beta particles are sufficiently separated so that they can be resolved by the spectrometer. This method is most applicable to the measurement of low-energy beta emitters such as tritium and carbon-14. APHA-609(6), EML-LV-539-17(19).

## 3.4 Gamma Emitting Radionuclides

### 3.4.1 Method G-1, High Resolution Gamma Spectrometry.

*Principle:* The sample is counted with a high resolution gamma detector, usually either a Ge(Li) or a high purity Ge detector, connected to a multichannel analyzer or computer. The gamma emitting radionuclides in the sample are measured from the gamma count rates in the energy regions characteristic of the individual radionuclide. Corrections are made for counts contributed by other radionuclides to the spectral regions of the radionuclides of interest. Radiochemical separations may be made prior to counting but are usually not necessary.

*Applicability:* This method is applicable to the measurement of any gamma emitting radionuclide with gamma energies greater than 20 keV. It can be applied to complex mixtures of radionuclides. The samples counted may be in the form of particulate filters, absorbers, liquids or gases. The method may also be applied to the analysis of gaseous gamma emitting radionuclides directly in an effluent stream by passing the stream through a chamber or cell containing the detector. ASTM-3649(9), IDO-12096(18).

#### 3.4.2 Method G-2, Low Resolution Gamma Spectrometry.

*Principle:* The sample is counted with a low resolution gamma detector, a thallium activated sodium iodide crystal. The detector is coupled to a photomultiplier tube and connected to a multichannel analyzer. The gamma emitting radionuclides in the sample are measured from the gamma count rates in the energy regions characteristic of the individual radionuclides. Corrections are made for counts contributed by other radionuclides to the spectral regions of the radionuclides of interest. Radiochemical separation may be used prior to counting to obtain less complex gamma spectra if needed.

*Applicability:* This method is applicable to the measurement of gamma emitting radionuclides with energies greater than 100 keV. It can be applied only to relatively simple mixtures of gamma emitting radionuclides. The samples counted may be in the form of particulate filters, absorbers, liquids or gas. The method can be applied to the analysis of gaseous radionuclides directly in an effluent stream by passing the gas stream through a chamber or cell containing the detector. ASTM-D-2459(12), EMSL-LV-0539-17(19).

#### 3.4.3 Method G-3, Single Channel Gamma Spectrometry.

*Principle:* The sample is counted with a thallium activated sodium iodide crystal. The detector is coupled to a photomultiplier tube connected to a single channel analyzer. The activity of a gamma emitting radionuclide is determined from the gamma counts in the energy range for which the counter is set.

*Applicability:* This method is applicable to the measurement of a single gamma emitting radionuclide. It is not applicable to mixtures of radionuclides. The samples counted may be in the form of particulate filters, absorbers, liquids or gas. The method can be applied to the analysis of gaseous radionuclides directly in an effluent stream by passing the gas stream through a chamber or cell containing the detector.

#### 3.4.4 Method G-4, Gross Gamma Counting.

*Principle:* The sample is counted with a gamma detector usually a thallium activated sodium iodine crystal. The detector is coupled to a photomultiplier tube and gamma rays above a specific threshold energy level are counted.

*Applicability:* Gross gamma measurements may be used to measure emissions of specific radionuclides only when it is known that the sample contains a single radionuclide or the identity and isotopic ratio of the radionuclides in the effluent stream are well known. When gross gamma measurements are used to determine emissions of specific radionuclides periodic measurements using Methods G-1 or G-2 should be made to demonstrate that the gross gamma measurements provide reliable emission data. This method may be applied to analysis of gaseous radionuclides directly in an effluent stream by placing the detector directly in or adjacent to the effluent stream or passing an extracted sample of the effluent stream through a chamber or cell containing the detector.

3.5 Counting Methods. All of the above methods with the exception of Method A-5 involve counting the radiation emitted by the radionuclide. Counting methods applicable to the measurement of alpha, beta and gamma radiations are listed below. The equipment needed and the counting principles involved are described in detail in ASTM-3648(8).

#### 3.5.1 Alpha Counting:

- *Gas Flow Proportional Counters.* The alpha particles cause ionization in the counting gas and the resulting electrical pulses are counted. These counters may be windowless or have very thin windows.
- *Scintillation Counters.* The alpha particles transfer energy to a scintillator resulting in a production of light photons which strike a photomultiplier tube converting the light photons to electrical pulses which are counted. The counters may involve the use of solid scintillation materials such as zinc sulfide or liquid scintillation solutions.
- *Solid-State Counters.* Semiconductor materials, such as silicon surface-barrier p-n junctions, act as solid ionization chambers. The alpha particles interact with the detector producing electron hole pairs. The charged pair is collected by an applied electrical field and the resulting electrical pulses are counted.
- *Alpha Spectrometers.* Semiconductor detectors used in conjunction with multichannel analyzers for energy discrimination.

#### 3.5.2 Beta Counting:

- *Ionization Chambers.* These chambers contain the beta-emitting nuclide in gaseous form. The ionization current produced is measured.
- *Geiger-Muller (GM) Counters-or Gas Flow Proportional Counters.* The beta particles cause ionization in the counting gas and the resulting electrical pulses are counted. Proportional gas flow counters which are heavily shielded by lead or other metal, and provided with an anti-coincidence shield to reject cosmic rays, are called low background beta counters.
- *Scintillation Counters.* The beta particles transfer energy to a scintillator resulting in a production of light photons, which strike a photomultiplier tube converting the light photon to electrical pulses which are counted. This may involve the use of anthracene crystals, plastic scintillator, or liquid scintillation solutions with organic phosphors.
- *Liquid Scintillation Spectrometers.* Liquid scintillation counters which use two photomultiplier tubes in coincidence to reduce background counts. This counter may also electronically discriminate among pulses of a given range of energy.

#### 3.5.3 Gamma Counting:

- *Low-Resolution Gamma Spectrometers.* The gamma rays interact with thallium activated sodium iodide or cesium iodide crystal resulting in the release of light photons which strike a photomultiplier tube converting the light pulses to electrical pulses proportional to the energy of the gamma ray. Multi-channel analyzers are used to separate and store the pulses according to the energy absorbed in the crystal.



- *High-Resolution gamma Spectrometers.* Gamma rays interact with a lithium-drifted (Ge(Li)) or high-purity germanium (HPGe) semiconductor detectors resulting in a production of electron-hole pairs. The charged pair is collected by an applied electrical field. A very stable low noise preamplifier amplifies the pulses of electrical charge resulting from the gamma photon interactions. Multichannel analyzers or computers are used to separate and store the pulses according to the energy absorbed in the crystal.
- *Single Channel Analyzers.* Thallium activated sodium iodide crystals used with a single window analyzer. Pulses from the photomultiplier tubes are separated in a single predetermined energy range.

3.5.4 Calibration of Counters. Counters are calibrated for specific radionuclide measurements using a standard of the radionuclide under either identical or very similar conditions as the sample to be counted. For gamma spectrometers a series of standards covering the energy range of interest may be used to construct a calibration curve relating gamma energy to counting efficiency.

In those cases where a standard is not available for a radionuclide, counters may be calibrated using a standard with energy characteristics as similar as possible to the radionuclide to be measured. For gross alpha and beta measurements of the unidentified mixtures of radionuclides, alpha counters are calibrated with a natural uranium standard and beta counters with a cesium-137 standard. The standard must contain the same weight and distribution of solids as the samples, and be mounted in an identical manner. If the samples contain variable amounts of solids, calibration curves relating weight of solids present to counting efficiency are prepared. Standards other than those prescribed may be used provided it can be shown that such standards are more applicable to the radionuclide mixture measured.

3.6 Radiochemical Methods for Selected Radionuclides. Methods for a selected list of radionuclides are listed in Table 1. The radionuclides listed are those which are most commonly used and which have the greatest potential for causing doses to members of the public. For radionuclides not listed in Table 1, methods based on any of the applicable “principles of measurement” described in section 3.1 through 3.4 may be used.

3.7 Applicability of Gross Alpha and Beta Measurements to Unidentified Mixtures of Radionuclides. Gross alpha and beta measurements may be used as a screening measurement as a part of an emission measurement program to identify the need to do specific radionuclide analyses or to confirm or verify that unexpected radionuclides are not being released in significant quantities.

Gross alpha (Method A-4) or gross beta (Methods B-2 or B-4) measurements may also be used for the purpose of comparing the measured concentrations in the effluent stream with the limiting “Concentration Levels for Environmental Compliance” in table 2 of appendix E. For unidentified mixtures, the measured concentration value shall be compared with the lowest environmental concentration limit for any radionuclide which is not known to be absent from the effluent stream.

**Table 1—List of Approved Methods for Specific Radionuclides**

Radionuclide	Approved methods of analysis
Am-241	A-1, A-2, A-3, A-4

Ar-41	B-1, B-2, G-1, G-2, G-3, G-4
Ba-140	G-1, G-2, G-3, G-4
Br-82	G-1, G-2, G-3, G-4
C-11	B-1, B-2, G-1, G-2, G-3, G-4
C-14	B-5
Ca-45	B-3, B-4, B-5
Ce-144	G-1, G-2, G-3, G-4
Cm-244	A-1, A-2, A-3, A-4
Co-60	G-1, G-2, G-3, G-4
Cr-51	G-1, G-2, G-3, G-4
Cs-134	G-1, G-2, G-3, G-4
Cs-137	G-1, G-2, G-3, G-4
Fe-55	B-5, G-1
Fe-59	G-1, G-2, G-3, G-4
Ga-67	G-1, G-2, G-3, G-4
H-3 (H <sub>2</sub> O)	B-5
H-3 (gas)	B-1
I-123	G-1, G-2, G-3, G-4
I-125	G-1
I-131	G-1, G-2, G-3, G-4

In-113m	G-1, G-2, G-3, G-4
Ir-192	G-1, G-2, G-3, G-4
Kr-85	B-1, B-2, B-5, G-1, G-2, G-3, G-4
Kr-87	B-1, B-2, G-1, G-2, G-3, G-4
Kr-88	B-1, B-2, G-1, G-2, G-3, G-4
Mn-54	G-1, G-2, G-3, G-4
Mo-99	G-1, G-2, G-3, G-4
N-13	B-1, B-2, G-1, G-2, G-3, G-4
O-15	B-1, B-2, G-1, G-2, G-3, G-4
P-32	B-3, B-4, B-5
Pm-147	B-3, B-4, B-5
Po-210	A-1, A-2, A-3, A-4
Pu-238	A-1, A-2, A-3, A-4
Pu-239	A-1, A-2, A-3, A-4
Pu-240	A-1, A-2, A-3, A-4
Ra-226	A-1, A-2, G-1, G-2
S-35	B-5
Se-75	G-1, G-2, G-3, G-4
Sr-90	B-3, B-4, B-5
Tc-99	B-3, B-4, B-5

Te-201	G-1, G-2, G-3, G-4
Uranium (total alpha)	A-1, A-2, A-3, A-4
Uranium (Isotopic)	A-1, A-3
Uranium (Natural)	A-5
Xe-133	G-1
Yb-169	G-1, G-2, G-3, G-4
Zn-65	G-1, G-2, G-3, G-4

#### 4. *Quality Assurance Methods*

Each facility required to measure their radionuclide emissions shall conduct a quality assurance program in conjunction with the radionuclide emission measurements. This program shall assure that the emission measurements are representative, and are of known precision and accuracy and shall include administrative controls to assure prompt response when emission measurements indicate unexpectedly large emissions. The program shall consist of a system of policies, organizational responsibilities, written procedures, data quality specifications, audits, corrective actions and reports. This quality assurance program shall include the following program elements:

4.1 The organizational structure, functional responsibilities, levels of authority and lines of communications for all activities related to the emissions measurement program shall be identified and documented.

4.2 Administrative controls shall be prescribed to ensure prompt response in the event that emission levels increase due to unplanned operations.

4.3 The sample collection and analysis procedures used in measuring the emissions shall be described including where applicable:

4.3.1 Identification of sampling sites and number of sampling points, including the rationale for site selections.

4.3.2 A description of sampling probes and representativeness of the samples.

4.3.3 A description of any continuous monitoring system used to measure emissions, including the sensitivity of the system, calibration procedures and frequency of calibration.

4.3.4 A description of the sample collection systems for each radionuclide measured, including frequency of collection, calibration procedures and frequency of calibration.

4.3.5 A description of the laboratory analysis procedures used for each radionuclide measured, including frequency of analysis, calibration procedures and frequency of calibration.

4.3.6 A description of the sample flow rate measurement systems or procedures, including calibration procedures and frequency of calibration.

4.3.7 A description of the effluent flow rate measurement procedures, including frequency of measurements, calibration procedures and frequency of calibration.

4.4 The objectives of the quality assurance program shall be documented and shall state the required precision, accuracy and completeness of the emission measurement data including a description of the procedures used to assess these parameters. Accuracy is the degree of agreement of a measurement with a true or known value. Precision is a measure of the agreement among individual measurements of the same parameters under similar conditions. Completeness is a measure of the amount of valid data obtained compared to the amount expected under normal conditions.

4.5 A quality control program shall be established to evaluate and track the quality of the emissions measurement data against preset criteria. The program should include where applicable a system of replicates, spiked samples, split samples, blanks and control charts. The number and frequency of such quality control checks shall be identified.

4.6 A sample tracking system shall be established to provide for positive identification of samples and data through all phases of the sample collection, analysis and reporting system. Sample handling and preservation procedures shall be established to maintain the integrity of samples during collection, storage and analysis.

4.7 Regular maintenance, calibration and field checks shall be performed for each sampling system in use by satisfying the requirements found in Table 2: Maintenance, Calibration and Field Check Requirements.

**Table 2—Maintenance, Calibration and Field Check Requirements**

<b>Sampling system components</b>	<b>Frequency of activity</b>
Cleaning of thermal anemometer elements	As required by application.
Inspect pitot tubes for contaminant deposits	At least annually.
Inspect pitot tube systems for leaks	At least annually.
Inspect sharp-edged nozzles for damage	At least annually or after maintenance that could cause damage.
Check nozzles for alignment, presence of deposits, or other potentially degrading	Annually.

factors	
Check transport lines of HEPA-filtered applications to determine if cleaning is required	Annually.
Clean transport lines	Visible deposits for HEPA-filtered applications. Mean mass of deposited material exceeds 1g/m <sup>2</sup> for other applications.
Inspect or test the sample transport system for leaks	At least annually.
Check mass flow meters of sampling systems with a secondary or transfer standard	At least quarterly.
Inspect rotameters of sampling systems for presence of foreign matter	At the start of each sampling period.
Check response of stack flow rate systems	At least quarterly.
Calibration of flow meters of sampling systems	At least annually.
Calibration of effluent flow measurement devices	At least annually.
Calibration of timing devices	At least annually.

4.8 Periodic internal and external audits shall be performed to monitor compliance with the quality assurance program. These audits shall be performed in accordance with written procedures and conducted by personnel who do not have responsibility for performing any of the operations being audited.

4.9 A corrective action program shall be established including criteria for when corrective action is needed, what corrective actions will be taken and who is responsible for taking the corrective action.

4.10 Periodic reports to responsible management shall be prepared on the performance of the emissions measurements program. These reports should include assessment of the quality of the data, results of audits and description of corrective actions.

4.11 The quality assurance program should be documented in a quality assurance project plan that should address each of the above requirements.

## 5. References

- (1) American National Standards Institute “Guide to Sampling Airborne Radioactive Materials in Nuclear Facilities”, ANSI-N13.1-1969, American National Standards Institute, New York, New York (1969).
- (2) American Public Health Association, “Methods of Air Sampling”, 2nd Edition, Method 605, “Tentative Method of Analysis for Plutonium Content of Atmospheric Particulate Matter”. American Public Health Association, New York, NY (1977).
- (3) Ibid, Method 601, “Tentative Method of Analysis for Gross Alpha Radioactivity Content of the Atmosphere”.
- (4) Ibid, Method 602, “Tentative Method of the Analysis for Gross Beta Radioactivity Content of the Atmosphere”.
- (5) Ibid, Method 608, “Tentative Method of Analysis for Strontium-90 Content of Atmospheric Particulate Matter”.
- (6) Ibid, Method 609, “Tentative Method of Analysis for Tritium Content of the Atmosphere”.
- (7) Ibid, Method 603, “Tentative Method of Analysis for Iodine-131 Content of the Atmosphere”.
- (8) American Society for Testing and Materials, 1986 Annual Book ASTM Standards, Designation D-3648-78, “Standard Practices for the Measurement of Radioactivity”. American Society for Testing and Materials, Philadelphia, PA (1986).
- (9) Ibid, Designation D-3649-85, “Standard Practice for High Resolution Gamma Spectrometry”.
- (10) Ibid, Designation D-1943-81, “Standard Test Method for Alpha Particle Radioactivity of Water”.
- (11) Ibid, Designation D-1890-81, “Standard Test Method for Beta Particle Radioactivity of Water”.
- (12) Ibid, Designation D-2459-72, “Standard Test Method for Gamma Spectrometry of Water”.
- (13) Ibid, Designation D-3972-82, “Standard Test Method for Isotopic Uranium in Water by Radiochemistry”.
- (14) Ibid, Designation D-2907-83, “Standard Test Methods for Microquantities of Uranium in Water by Fluorometry”.
- (15) Ibid, Designation E-318, “Standard Test Method for Uranium in Aqueous Solutions by Colorimetry”.
- (16) Ibid, Designation D-3084-75, “Standard Practice for Alpha Spectrometry of Water”.
- (17) Corley, J.P. and C.D. Corbit, “A Guide for Effluent Radiological Measurements at DOE Installations”, DOE/EP-0096, Pacific Northwest Laboratories, Richland, Washington (1983).
- (18) Department of Energy, “RESL Analytical Chemistry Branch Procedures Manual”, IDO-12096, U.S. Department of Energy, Idaho Falls, Idaho (1982).

(19) Environmental Protection Agency, "Radiochemical Analytical Procedures for Analysis of Environmental Samples", EMSL-LV-0539-17, U.S. Environmental Protection Agency, Environmental Monitoring and Support Laboratory, Las Vegas, Nevada (1979).

(20) Environmental Protection Agency, "Radiochemistry Procedures Manual", EPA 520/5-84-006, Eastern Environmental Radiation Facility, Montgomery, Alabama (1984).

(21) National Council on Radiation Protection and Measurements, NCRP Report No. 50, "Environmental Radiation Measurements", National Council on Radiation Protection and Measurement, Bethesda, Maryland (1976).

(22) Ibid, Report No. 47, "Tritium Measurement Techniques". (1976).

(23) Ibid, Report No. 58 "A Handbook of Radioactivity Measurement Procedures" (1985).

(24) Environmental Protection Agency, "Indoor Radon and Radon Decay Product Measurement Protocols", EPA 520/1-89-009, U.S. Environmental Protection Agency, Washington, DC (1989).

#### Method 115—Monitoring for Radon-222 Emissions

This appendix describes the monitoring methods which must be used in determining the radon-222 emissions from underground uranium mines, uranium mill tailings piles, phosphogypsum stacks, and other piles of waste material emitting radon.

##### 1. *Radon-222 Emissions from Underground Uranium Mine Vents*

1.1 Sampling Frequency and Calculation of Emissions. Radon-222 emissions from underground uranium mine vents shall be determined using one of the following methods:

1.1.1 Continuous Measurement. These measurements shall be made and the emissions calculated as follows:

(a) The radon-222 concentration shall be continuously measured at each mine vent whenever the mine ventilation system is operational.

(b) Each mine vent exhaust flow rate shall be measured at least 4 times per year.

(c) A weekly radon-222 emission rate for the mine shall be calculated and recorded weekly as follows:

$$A_w = C_1 Q_1 T_1 + C_2 Q_2 T_2 + \dots + C_i Q_i T_i$$

Where:

$A_w$  = Total radon-222 emitted from the mine during week (Ci)

$C_i$  = Average radon-222 concentration in mine vent  $i$  (Ci/m<sup>3</sup>)

$Q_i$  = Volumetric flow rate from mine vent  $i$  (m<sup>3</sup>/hr)

$T_i$  = Hours of mine ventilation system operation during week for mine vent  $i$  (hr)



(d) The annual radon-222 emission rate is the sum of the weekly emission rates during a calendar year.

1.1.2 Periodic Measurement. This method is applicable only to mines that continuously operate their ventilation system except for extended shutdowns. Mines which start up and shut down their ventilation system frequently must use the continuous measurement method describe in Section 1.1.1 above. Emission rates determined using periodic measurements shall be measured and calculated as follows:

(a) The radon-222 shall be continuously measured at each mine vent for at least one week every three months.

(b) Each mine vent exhaust flow rate shall be measured at least once during each of the radon-222 measurement periods.

(c) A weekly radon-222 emission rate shall be calculated for each weekly period according to the method described in Section 1.1.1. In this calculation  $T = 168$  hr.

(d) The annual radon-222 emission rate from the mine should be calculated as follows:

$$A_y = \frac{52 - W_s}{n} (A_{w1} + A_{w2} + \dots + A_{wn})$$

[View or download PDF](#)

Where:

$A_y$  = Annual radon-222 emission rate from the mine(Ci)

$A_{wi}$  = Weekly radon-222 emission rate during the measurement period i (Ci)

n = Number of weekly measurement periods per year

$W_s$  = Number of weeks during the year that the mine ventilation system is shut down in excess of 7 consecutive days, i.e. the sum of the number of weeks each shut down exceeds 7 days

## 1.2 Test Methods and Procedures

Each underground mine required to test its emissions, unless an equivalent or alternative method has been approved by the Administrator, shall use the following test methods:

1.2.1 Test Method 1 of appendix A to part 60 shall be used to determine velocity traverses. The sampling point in the duct shall be either the centroid of the cross section or the point of average velocity.

1.2.2 Test Method 2 of appendix A to part 60 shall be used to determine velocity and volumetric flow rates.

1.2.3 Test Methods A-6 or A-7 of appendix B, Method 114 to part 61 shall be used for the analysis of radon-222. Use of Method A-7 requires prior approval of EPA based on conditions described in appendix B.

1.2.4 A quality assurance program shall be conducted in conformance with the programs described for Continuous Radon Monitors and Alpha Track Detectors in EPA 520/1-89-009. (2)

## *2. Radon-222 Emissions from Uranium Mill Tailings Piles*

### 2.1 Measurement and Calculation of Radon Flux from Uranium Mill Tailings Piles.

2.1.1 Frequency of Flux Measurement. A single set of radon flux measurements may be made, or if the owner or operator chooses, more frequent measurements may be made over a one year period. These measurements may involve quarterly, monthly or weekly intervals. All radon measurements shall be made as described in paragraphs 2.1.2 through 2.1.6 except that for measurements made over a one year period, the requirement of paragraph 2.1.4(c) shall not apply. The mean radon flux from the pile shall be the arithmetic mean of the mean radon flux for each measurement period. The weather conditions, moisture content of the tailings and area of the pile covered by water existing at the time of the measurement shall be chosen so as to provide measurements representative of the long term radon flux from the pile and shall be subject to EPA review and approval.

2.1.2 Distribution of Flux Measurements. The distribution and number of radon flux measurements required on a pile will depend on clearly defined areas of the pile (called regions) that can have significantly different radon fluxes due to surface conditions. The mean radon flux shall be determined for each individual region of the pile. Regions that shall be considered for operating mill tailings piles are:

- (a) Water covered areas,
- (b) Water saturated areas (beaches),
- (c) Dry top surface areas, and
- (d) Sides, except where earthen material is used in dam construction.

For mill tailings after disposal the pile shall be considered to consist of only one region.

2.1.3 Number of Flux Measurements. Radon flux measurements shall be made within each region on the pile, except for those areas covered with water. Measurements shall be made at regularly spaced locations across the surface of the region, realizing that surface roughness will prohibit measurements in some areas of a region. The minimum number of flux measurements considered necessary to determine a representative mean radon flux value for each type of region on an operating pile is:

- (a) Water covered area—no measurements required as radon flux is assumed to be zero,
- (b) Water saturated beaches—100 radon flux measurements,
- (c) Loose and dry top surface—100 radon flux measurements,
- (d) Sides—100 radon flux measurements, except where earthen material is used in dam construction.

For a mill tailings pile after disposal which consists of only one region a minimum of 100 measurements are required.

2.1.4 Restrictions to Radon Flux Measurements. The following restrictions are placed on making radon flux measurements:

- (a) Measurements shall not be initiated within 24 hours of a rainfall.
- (b) If a rainfall occurs during the 24 hour measurements period, the measurement is invalid if the seal around the lip of the collector has washed away or if the collector is surrounded by water.
- (c) Measurements shall not be performed if the ambient temperature is below 35 °F or if the ground is frozen.

2.1.5 Areas of Pile Regions. The approximate area of each region of the pile shall be determined in units of square meters.

2.1.6 Radon Flux Measurement. Measuring radon flux involves the adsorption of radon on activated charcoal in a large-area collector. The radon collector is placed on the surface of the pile area to be measured and allowed to collect radon for a time period of 24 hours. The radon collected on the charcoal is measured by gamma-ray spectroscopy. The detailed measurement procedure provided in appendix A of EPA 520/5-85-0029(1) shall be used to measure the radon flux on uranium mill tailings, except the surface of the tailings shall not be penetrated by the lip of the radon collector as directed in the procedure, rather the collector shall be carefully positioned on a flat surface with soil or tailings used to seal the edge.

2.1.7 Calculations. The mean radon flux for each region of the pile and for the total pile shall be calculated and reported as follows:

- (a) The individual radon flux calculations shall be made as provided in appendix A EPA 86 (1). The mean radon flux for each region of the pile shall be calculated by summing all individual flux measurements for the region and dividing by the total number of flux measurements for the region.
- (b) The mean radon flux for the total uranium mill tailings pile shall be calculated as follows.

$$J_s = \frac{J_1 A_1 + \dots + J_2 A_2 + \dots + J_i A_i}{A_t}$$

[View or download PDF](#)

Where:

$J_s$  = Mean flux for the total pile (pCi/m<sup>2</sup>-s)

$J_i$  = Mean flux measured in region i (pCi/m<sup>2</sup>-s)

$A_i$  = Area of region i (m<sup>2</sup>)

$A_t$  = Total area of the pile (m<sup>2</sup>)

2.1.8 Reporting. The results of individual flux measurements, the approximate locations on the pile, and the mean radon flux for each region and the mean radon flux for the total stack shall be included in the emission test report. Any condition or unusual event that occurred during the measurements that could significantly affect the results should be reported.

### 3.0 Radon-222 Emissions from Phosphogypsum Stacks.

3.1 Measurement and Calculation of the Mean Radon Flux. Radon flux measurements shall be made on phosphogypsum stacks as described below:

3.1.1 Frequency of Measurements. A single set of radon flux measurements may be made after the phosphogypsum stack becomes inactive, or if the owner or operator chooses, more frequent measurements may be made over a one year period. These measurements may involve quarterly, monthly or weekly intervals. All radon measurements shall be made as described in paragraphs 3.1.2 through 3.1.6 except that for measurements made over a one year period, the requirement of paragraph 3.1.4(c) shall not apply. For measurements made over a one year period, the radon flux shall be the arithmetic mean of the mean radon flux for each measurement period.

3.1.2 Distribution and Number of Flux Measurements. The distribution and number of radon flux measurements required on a stack will depend on clearly defined areas of the stack (called regions) that can have significantly different radon fluxes due to surface conditions. The mean radon flux shall be determined for each individual region of the stack. Regions that shall be considered are:

- (a) Water covered areas,
- (b) Water saturated areas (beaches),
- (c) Loose and dry top surface areas,
- (d) Hard-packed roadways, and
- (e) Sides.

3.1.3 Number of Flux Measurements. Radon flux measurements shall be made within each region on the phosphogypsum stack, except for those areas covered with water. Measurements shall be made at regularly spaced locations across the surface of the region, realizing that surface roughness will prohibit measurements in some areas of a region. The minimum number of flux measurements considered necessary to determine a representative mean radon flux value for each type of region is:

- (a) Water covered area—no measurements required as radon flux is assumed to be zero,
- (b) Water saturated beaches—50 radon flux measurements,
- (c) Loose and dry top surface—100 radon flux measurements,
- (d) Hard-packed roadways—50 radon flux measurements, and
- (e) Sides—100 radon flux measurements.

A minimum of 300 measurements are required. A stack that has no water cover can be considered to consist of two regions, top and sides, and will require a minimum of only 200 measurements.

3.1.4 Restrictions to Radon Flux Measurements. The following restrictions are placed on making radon flux measurements:

- (a) Measurements shall not be initiated within 24 hours of a rainfall.
- (b) If a rainfall occurs during the 24 hour measurement period, the measurement is invalid if the seal around the lip of the collector has washed away or if the collector is surrounded by water.
- (c) Measurements shall not be performed if the ambient temperature is below 35 °F or if the ground is frozen.

3.1.5 Areas of Stack Regions. The approximate area of each region of the stack shall be determined in units of square meters.

3.1.6 Radon Flux Measurements. Measuring radon flux involves the adsorption of radon on activated charcoal in a large-area collector. The radon collector is placed on the surface of the stack area to be measured and allowed to collect radon for a time period of 24 hours. The radon collected on the charcoal is measured by gamma-ray spectroscopy. The detailed measurement procedure provided in appendix A of EPA 520/5-85-0029(1) shall be used to measure the radon flux on phosphogypsum stacks, except the surface of the phosphogypsum shall not be penetrated by the lip of the radon collector as directed in the procedure, rather the collector shall be carefully positioned on a flat surface with soil or phosphogypsum used to seal the edge.

3.1.7 Calculations. The mean radon flux for each region of the phosphogypsum stack and for the total stack shall be calculated and reported as follows:

- (a) The individual radon flux calculations shall be made as provided in appendix A EPA 86 (1). The mean radon flux for each region of the stack shall be calculated by summing all individual flux measurements for the region and dividing by the total number of flux measurements for the region.
- (b) The mean radon flux for the total phosphogypsum stack shall be calculated as follows.

$$J_s = \frac{J_1A_1 + J_2A_2 + \dots + J_iA_i}{A_t}$$

[View or download PDF](#)

Where:

$J_s$  = Mean flux for the total stack (pCi/m<sup>2</sup>-s)

$J_i$  = Mean flux measured in region i (pCi/m<sup>2</sup>-s)

$A_i$  = Area of region i (m<sup>2</sup>)

$A_t$  = Total area of the stack

3.1.8 Reporting. The results of individual flux measurements, the approximate locations on the stack, and the mean radon flux for each region and the mean radon flux for the total stack shall be included in the emission test report. Any condition or unusual event that occurred during the measurements that could significantly affect the results should be reported.

#### 4.0 Quality Assurance Procedures for Measuring Rn-222 Flux

## A. Sampling Procedures

Records of field activities and laboratory measurements shall be maintained. The following information shall be recorded for each charcoal canister measurement:

- (a) Site
- (b) Name of pile
- (c) Sample location
- (d) Sample ID number
- (e) Date and time on
- (f) Date and time off
- (g) Observations of meteorological conditions and comments

Records shall include all applicable information associated with determining the sample measurement, calculations, observations, and comments.

## B. Sample Custody

Custodial control of all charcoal samples exposed in the field shall be maintained in accordance with EPA chain-of-custody field procedures. A control record shall document all custody changes that occur between the field and laboratory personnel.

## C. Calibration Procedures and Frequency

The radioactivity of two standard charcoal sources, each containing a carefully determined quantity of radium-226 uniformly distributed through 180g of activated charcoal, shall be measured. An efficiency factor is computed by dividing the average measured radioactivity of the two standard charcoal sources, minus the background, in cpm by the known radioactivity of the charcoal sources in dpm. The same two standard charcoal sources shall be counted at the beginning and at the end of each day's counting as a check of the radioactivity counting equipment. A background count using unexposed charcoal should also be made at the beginning and at the end of each counting day to check for inadvertent contamination of the detector or other changes affecting the background. The unexposed charcoal comprising the blank is changed with each new batch of charcoal used.

## D. Internal Quality Control Checks and Frequency

The charcoal from every tenth exposed canister shall be recounted. Five percent of the samples analyzed shall be either blanks (charcoal having no radioactivity added) or samples spiked with known quantities of radium-226.

## E. Data Precision, Accuracy, and Completeness

The precision, accuracy, and completeness of measurements and analyses shall be within the following limits for samples measuring greater than 1.0 pCi/m<sup>2</sup>-s.

(a) Precision: 10%

(b) Accuracy: ±10%

(c) Completeness: at least 85% of the measurements must yield useable results.

## 5.0 References

(1) Hartley, J.N. and Freeman, H.D., "Radon Flux Measurements on Gardinier and Royster phosphogypsum Piles Near Tampa and Mulberry, Florida," U.S. Environmental Protection Agency Report, EPA 520/5-85-029, January 1986.

(2) Environmental Protection Agency, "Indoor Radon and Radon Decay Product Measurement Protocols", EPA 520/1-89-009, U.S. Environmental Protection Agency, Washington, DC. (1989).

[38 FR 8826, Apr. 6, 1973]

Editorial Notes: 1. For Federal Register citations affecting appendix B, see the List of CFR Sections Affected, which appears in the Finding Aids section of the printed volume and at [www.fdsys.gov](http://www.fdsys.gov).

2. At 65 FR 62161, Oct. 17, 2000, appendix B to part 61 was amended by revising Methods 101, 101A, 102, 103, 104, 105, 106, 107, 107A, 108, 108A, 108B, 108C, and 111. However, because the amendment contains no revised text for Method 107A, this part of the revision could not be incorporated.

[↑ Back to Top](#)

## Appendix C to Part 61—Quality Assurance Procedures

### *Procedure 1—Determination of Adequate Chromatographic Peak Resolution*

In this method of dealing with resolution, the extent to which one chromatographic peak overlaps another is determined.

For convenience, consider the range of the elution curve of each compound as running from  $-2\sigma$  to  $+2\sigma$ . This range is used in other resolution criteria, and it contains 95.45 percent of the area of a normal curve. If two peaks are separated by a known distance,  $b$ , one can determine the fraction of the area of one curve that lies within the range of the other. The extent to which the elution curve of a contaminant compound overlaps the curve of a compound that is under analysis is found by integrating the contaminant curve over the limits  $b-2\sigma_s$  to  $b+2\sigma_s$ , where  $\sigma_s$  is the standard deviation of the sample curve.

This calculation can be simplified in several ways. Overlap can be determined for curves of unit area; then actual areas can be introduced. Desired integration can be resolved into two integrals of the normal distribution function for which there are convenient calculation programs and tables. An example would be Program 15 in Texas Instruments Program Manual ST1, 1975, Texas Instruments, Inc., Dallas, Texas 75222.

$$\frac{1}{\sqrt{2\pi}\sigma_c} \int_{b-2\sigma_s}^{b+2\sigma_s} e^{\left(\frac{-t^2}{2\sigma_c^2}\right)} dt = \frac{1}{\sqrt{2\pi}} \int_{\frac{b-2\sigma_s}{\sigma_c}}^{\frac{b+2\sigma_s}{\sigma_c}} e^{\left(\frac{-x^2}{2}\right)} dx - \frac{1}{\sqrt{2\pi}} \int_{\frac{b+2\sigma_s}{\sigma_c}}^{\infty} e^{\left(\frac{-x^2}{2}\right)} dx$$

The following calculation steps are required:\*

$$1. 2\sigma_s = t_s / \sqrt{2 \ln 2}$$

$$2. \sigma_c = t_c / \sqrt{2 \ln 2}$$

$$3. x_1 = (b-2\sigma_s)/\sigma_c$$

$$4. x_2 = (b+2\sigma_s)/\sigma_c$$

$$5. Q(x_1) = \frac{1}{\sqrt{2\pi}} \int_{x_1}^{\infty} e^{\left(\frac{-x^2}{2}\right)} dx$$

$$6. Q(x_2) = \frac{1}{\sqrt{2\pi}} \int_{x_2}^{\infty} e^{\left(\frac{-x^2}{2}\right)} dx$$

$$7. I_o = Q(x_1) - Q(x_2)$$

$$8. A_o = I_o A_s / A_s$$

$$9. \text{Percentage overlap} = A_o \times 100$$

where:

$A_s$  = Area of the sample peak of interest determined by electronic integration or by the formula  $A_s = h_s t_s$ .

$A_c$  = Area of the contaminant peak, determined in the same manner as  $A_s$ .

$b$  = Distance on the chromatographic chart that separates the maxima of the two peaks.

$H_s$  = Peak height of the sample compound of interest, measured from the average value of the baseline to the maximum of the curve.

$t_s$  = Width of sample peak of interest at 1/2 peak height.

$t_c$  = Width of the contaminant peak at 1/2 of peak height.

$\sigma_s$  = Standard deviation of the sample compound of interest elution curve.

$\sigma_c$  = Standard deviation of the contaminant elution curve.

$Q(x_1)$  = Integral of the normal distribution function from  $x_1$  to infinity.

$Q(x_2)$  = Integral of the normal distribution function from  $x_2$  to infinity.

$I_o$  = Overlap integral.

$A_o$  = Area overlap fraction.

\*In most instances,  $Q(x_2)$  is very small and may be neglected.

## [View or download PDF](#)

In judging the suitability of alternate GC columns or the effects of altering chromatographic conditions, one can employ the area overlap as the resolution parameter with a specific maximum permissible value.

The use of Gaussian functions to describe chromatographic elution curves is widespread. However, some elution curves are highly asymmetric. In cases where the sample peak is followed by a contaminant that has a leading edge that rises sharply but the curve then tails off, it may be possible to define an effective width for  $t_c$  as "twice the distance from the leading edge to a perpendicular line through the maxim of the contaminant curve, measured along a perpendicular bisection of that line."

### *Procedure 2—Procedure for Field Auditing GC Analysis*

Responsibilities of audit supervisor and analyst at the source sampling site include the following:

A. The audit supervisor verifies that audit cylinders are stored in a safe location both before and after the audit to prevent vandalism.



B. At the beginning and conclusion of the audit, the analyst records each cylinder number and pressure. An audit cylinder is never analyzed when the pressure drops below 200 psi.

C. During the audit, the analyst performs a minimum of two consecutive analyses of each audit cylinder gas. The audit must be conducted to coincide with the analysis of source test samples, normally immediately after GC calibration and prior to sample analyses.

D. At the end of audit analyses, the audit supervisor requests the calculated concentrations from the analyst and compares the results with the actual audit concentrations. If each measured concentration agrees with the respective actual concentration within  $\pm 10$  percent, he directs the analyst to begin analyzing source samples. Audit supervisor judgment and/or supervisory policy determine action when agreement is not within  $\pm 10$  percent. When a consistent bias in excess of 10 percent is found, it may be possible to proceed with the sample analysis, with a corrective factor to be applied to the results at a later time. However, every attempt should be made to locate the cause of the discrepancy, as it may be misleading. The audit supervisor records each cylinder number, cylinder pressure (at the end of the audit), and all calculated concentrations. The individual being audited must not under any circumstance be told actual audit concentrations until calculated concentrations have been submitted to the audit supervisor.

Field Audit Report

*Part A*— To be filled out by organization supplying audit cylinders.

1. Organization supplying audit sample(s) and shipping address

2. Audit supervisor, organization, and phone number

3. Shipping instructions: Name, Address, Attention

4. Guaranteed arrival date for cylinders

5. Planned shipping date for cylinders

6. Details on audit cylinders from last analysis

	<b>Low conc.</b>	<b>High conc.</b>
--	------------------	-------------------

a. Date of last analysis		
b. Cylinder number		
c. Cylinder pressure, psi		
d. Audit gas(es)/balance gas		
e. Audit gas(es), ppm		
f. Cylinder construction		

*Part B*—To be filled out by audit supervisor.

1. Process sampled

2. Audit location

3. Name of individual audit

4. Audit date

5. Audit results:

	<b>Low conc. cylinder</b>	<b>High conc. cylinder</b>
a. Cylinder number		
b. Cylinder pressure before audit, psi		
c. Cylinder pressure after audit, psi		
d. Measured concentration, ppm Injection #1* Injection #2* Average		
e. Actual audit concentration, ppm (Part A, 6e)		
f. Audit accuracy: <sup>1</sup>		

Low Conc. Cylinder		
High Conc. Cylinder		
Percent <sup>1</sup> accuracy=		
Measured Conc. – Actual Conc.		
_____ × 100		
Actual Conc.		
g. Problems detected (if any)		

<sup>1</sup>Results of two consecutive injections that meet the sample analysis criteria of the test method.

[47 FR 39178, Sept. 7, 1982]

[↑ Back to Top](#)

## Appendix D to Part 61—Methods for Estimating Radionuclide Emissions

### 1. Purpose and Background

Facility owners or operators may estimate radionuclide emissions to the atmosphere for dose calculations instead of measuring emissions. Particulate emissions from mill tailings piles should be estimated using the procedures listed in reference re #2. All other emissions may be estimated by using the “Procedures” listed below, or using the method described in reference #1.

### 2. Procedure

To estimate emissions to the atmosphere:

(a) Determine the amount (in curies) used at facilities for the period under consideration. Radioactive materials in sealed packages that remain unopened, and have not leaked during the assessment period should not be included in the calculation.

(b) Multiply the amount used by the following factors which depend on the physical state of the radionuclide. They are:

(i) 1 for gases;

(ii)  $10^{-3}$  for liquids or particulate solids; and

(iii)  $10^{-6}$  for solids.

If any nuclide is heated to a temperature of 100 degrees Celsius or more, boils at a temperature of 100 degrees Celsius or less, or is intentionally dispersed into the environment, it must be considered to be a gas.

(c) If a control device is installed between the place of use and the point of release, multiply emissions from (b) by an adjustment factor. These are presented in Table 1.

**Table 1—Adjustment to Emission Factors for Effluent Controls**

<b>Controls</b>	<b>Types of radionuclides controlled</b>	<b>Adjustment factor to emissions</b>	<b>Comments and conditions</b>
HEPA filters	Particulates	0.01	Not applicable to gaseous radionuclides; periodic testing is prudent to ensure high removal efficiency.
Fabric filter	Particulates	0.1	Monitoring would be prudent to guard against tears in filter.
Sintered metal	Particulates	1	Insufficient data to make recommendation.
Activated carbon filters	Iodine gas	0.1	Efficiency is time dependent; monitoring is necessary to ensure effectiveness.
Douglas bags: Held one week or longer for decay	Xenon	0.5/wk	Based on xenon half-life of 5.3 days;
Douglas bags: Released within one week	Xenon	1	Provides no reduction of exposure to general public.
Venturi scrubbers	Particulates Gases	0.05 1	Although venturis may remove gases, variability in gaseous removal efficiency dictates adjustment factor for particulates only.
Packed bed scrubbers	Gases	0.1	Not applicable to particulates.
Electrostatic precipitators	Particulates	0.05	Not applicable for gaseous radionuclides

Xenon traps	Xenon	0.1	Efficiency is time dependent; monitoring is necessary to ensure effectiveness.
Fume hoods	All	1	Provides no reduction to general public exposures.
Vent stacks	All	1	Generally provides no reduction of exposure to general public.

*References*

(1) Environmental Protection Agency, “A Guide for Determining Compliance with the Clean Air Act Standards for Radionuclides Emissions from NRC-Licensed and Non-DOE Federal Facilities”, EPA 520/1-89-002, January 1989.

(2) Nuclear Regulatory Commission, “Methods for Estimating Radioactive and Toxic Airborne Source Terms for Uranium Milling Operations”, U.S. Nuclear Regulatory Commission Regulatory Guide 3.59, March 1987.

[54 FR 51711, Dec. 15, 1989]

[↑ Back to Top](#)

**Appendix E to Part 61—Compliance Procedures Methods for Determining Compliance With Subpart I**

*1. Purpose and Background*

This Appendix provides simplified procedures to reduce the burden on Nuclear Regulatory Commission (NRC) licensees, and non-Department of Energy Federal facilities in determining compliance with 40 CFR part 61, subpart I. The procedures consist of a series of increasingly more stringent steps, depending on the facility's potential to exceed the standard.

First, a facility can be found in compliance if the quantity of radioactive material possessed during the year is less than that listed in a table of annual possession quantities. A facility will also be in compliance if the average annual radionuclide emission concentration is less than that listed in a table of air concentration levels. If the facility is not in compliance by these tables, it can establish compliance by estimating a dose using screening procedure developed by the National Council on Radiation Protection and Measurements with a radiological source term derived using EPA approved emission factors. These procedures are described in a “Guide for Determining Compliance with the Clean Air Act Standards for Radionuclide Emissions From NRC-Licensed and Non-DOE Federal Facilities.”

A user-friendly computer program called COMPLY has been developed to reduce the burden on the regulated community. The Agency has also prepared a “User's Guide for the COMPLY Code” to assist the regulated community in using the code, and in handling more complex situations such as multiple release points. The basis for these compliance procedures are provided in “Background Information

Document: Procedures Approved for Demonstrating Compliance with 40 CFR Part 61, Subpart I”. The compliance model is the highest level in the COMPLY computer code and provides for the most realistic assessment of dose by allowing the use of site-specific information.

2. *Table of Annual Possession Quantity*

(a) Table 1 may be used for determining if facilities are in compliance with the standard. The possession table can only be used if the following conditions are met:

- (i) No person lives within 10 meters of any release point; and
- (ii) No milk, meat, or vegetables are produced within 100 meters of any release point.

(b) Procedures described in Reference (1) shall be used to determine compliance or exemption from reporting by use of Table 2.

**Table 1—Annual Possession Quantities for Environmental Compliance**

[Annual Possession Quantities (Ci/yr)]

<b>Radionuclide</b>	<b>Gaseous form*</b>	<b>Liquid/powder forms</b>	<b>Solid form*</b>
Ac-225	9.6E-05	9.6E-02	9.6E + 01
Ac-227	1.6E-07	1.6E-04	1.6E-01
Ac-228	3.4E-03	3.4E + 00	3.4E + 03
Ag-106	1.6E + 00	1.6E + 03	1.6E + 06
Ag-106m	2.6E-03	2.6E + 00	2.6E + 03
Ag-108m	6.5E-06	6.5E-03	6.5E + 00
Ag-110m	9.4E-05	9.4E-02	9.4E + 01
Ag-111	6.7E-02	6.7E + 01	6.7E + 04
Al-26	4.0E-06	4.0E-03	4.0E + 00
Am-241	2.3E-06	2.3E-03	2.3E + 00
Am-242	1.8E-02	1.8E + 01	1.8E + 04

Am-242m	2.5E-06	2.5E-03	2.5E + 00
Am-243	2.3E-06	2.3E-03	2.3E + 00
Am-244	4.6E-02	4.6E + 01	4.6E + 04
Am-245	7.0E + 00	7.0E + 03	7.0E + 06
Am-246	9.8E-01	9.8E + 02	9.8E + 05
Ar-37	1.4E + 06		
Ar-41	1.4E + 00		
As-72	2.9E-02	2.9E + 01	2.9E + 04
As-73	6.0E-02	6.0E + 01	6.0E + 04
As-74	4.3E-03	4.3E + 00	4.3E + 03
As-76	8.8E-02	8.8E + 01	8.8E + 04
As-77	7.9E-01	7.9E + 02	7.9E + 05
At-211	1.0E-02	1.0E + 01	1.0E + 04
Au-193	4.2E-01	4.2E + 02	4.2E + 05
Au-194	3.5E-02	3.5E + 01	3.5E + 04
Au-195	3.3E-03	3.3E + 00	3.3E + 03
Au-198	4.6E-02	4.6E + 01	4.6E + 04
Au-199	1.5E-01	1.5E + 02	1.5E + 05
Ba-131	1.0E-02	1.0E + 01	1.0E + 04
Ba-133	4.9E-05	4.9E-02	4.9E + 01

Ba-133m	9.3E-02	9.3E + 01	9.3E + 04
Ba-135m	5.8E-01	5.8E + 02	5.8E + 05
Ba-139	4.7E + 00	4.7E + 03	4.7E + 06
Ba-140	2.1E-03	2.1E + 00	2.1E + 03
Ba-141	1.3E + 00	1.3E + 03	1.3E + 06
Ba-142	1.1E + 00	1.1E + 03	1.1E + 06
Be-7	2.3E-02	2.3E + 01	2.3E + 04
Be-10	3.0E-03	3.0E + 00	3.0E + 03
Bi-206	3.1E-03	3.1E + 00	3.1E + 03
Bi-207	8.4E-06	8.4E-03	8.4E + 00
Bi-210	4.2E-03	4.2E + 00	4.2E + 03
Bi-212	4.7E-02	4.7E + 01	4.7E + 04
Bi-213	6.0E-02	6.0E + 01	6.0E + 04
Bi-214	1.4E-01	1.4E + 02	1.4E + 05
Bk-249	7.0E-04	7.0E-01	7.0E + 02
Bk-250	1.0E-01	1.0E + 02	1.0E + 05
Br-77	7.5E-02	7.5E + 01	7.5E + 04
Br-80	1.2E + 01	1.2E + 04	1.2E + 07
Br-80m	1.5E + 00	1.5E + 03	1.5E + 06
Br-82	1.6E-02	1.6E + 01	1.6E + 04



Br-83	9.9E + 00	9.9E + 03	9.9E + 06
Br-84	5.6E-01	5.6E + 02	5.6E + 05
C-11	1.3E + 00	1.3E + 03	1.3E + 06
C-14	2.9E-01	2.9E + 02	2.9E + 05
Ca-41	2.7E-02	2.7E + 01	2.7E + 04
Ca-45	5.8E-02	5.8E + 01	5.8E + 04
Ca-47	1.1E-02	1.1E + 01	1.1E + 04
Cd-109	5.0E-03	5.0E + 00	5.0E + 03
Cd-113	3.3E-04	3.3E-01	3.3E + 02
Cd-113m	4.4E-04	4.4E-01	4.4E + 02
Cd-115	5.4E-02	5.4E + 01	5.4E + 04
Cd-115m	1.0E-02	1.0E + 01	1.0E + 04
Cd-117	5.6E-02	5.6E + 01	5.6E + 04
Cd-117m	1.3E-01	1.3E + 02	1.3E + 05
Ce-139	2.6E-03	2.6E + 00	2.6E + 03
Ce-141	1.8E-02	1.8E + 01	1.8E + 04
Ce-143	1.0E-01	1.0E + 02	1.0E + 05
Ce-144	1.7E-03	1.7E + 00	1.7E + 03
Cf-248	2.0E-05	2.0E-02	2.0E + 01
Cf-249	1.7E-06	1.7E-03	1.7E + 00

Cf-250	4.0E-06	4.0E-03	4.0E + 00
Cf-251	1.7E-06	1.7E-03	1.7E + 00
Cf-252	6.4E-06	6.4E-03	6.4E + 00
Cf-253	3.3E-04	3.3E-01	3.3E + 02
Cf-254	3.6E-06	3.6E-03	3.6E + 00
Cl-36	1.9E-04	1.9E-01	1.9E + 02
Cl-38	6.5E-01	6.5E + 02	6.5E + 05
Cm-242	6.0E-05	6.0E-02	6.0E + 01
Cm-243	3.3E-06	3.3E-03	3.3E + 00
Cm-244	4.2E-06	4.2E-03	4.2E + 00
Cm-245	2.3E-06	2.3E-03	2.3E + 00
Cm-246	2.3E-06	2.3E-03	2.3E + 00
Cm-247	2.3E-06	2.3E-03	2.3E + 00
Cm-248	6.4E-07	6.4E-04	6.4E-01
Cm-249	4.6E + 00	4.6E + 03	4.6E + 06
Cm-250	1.1E-07	1.1E-04	1.1E-01
Co-56	2.4E-04	2.4E-01	2.4E + 02
Co-57	1.6E-03	1.6E + 00	1.6E + 03
Co-58	9.0E-04	9.0E-01	9.0E + 02
Co-58m	1.7E-01	1.7E + 02	1.7E + 05

Co-60	1.6E-05	1.6E-02	1.6E + 01
Co-60m	4.0E + 00	4.0E + 03	4.0E + 06
Co-61	3.8E + 00	3.8E + 03	3.8E + 06
Cr-49	9.0E-01	9.0E + 02	9.0E + 05
Cr-51	6.3E-02	6.3E + 01	6.3E + 04
Cs-129	1.5E-01	1.5E + 02	1.5E + 05
Cs-131	2.8E-01	2.8E + 02	2.8E + 05
Cs-132	1.3E-02	1.3E + 01	1.3E + 04
Cs-134	5.2E-05	5.2E-02	5.2E + 01
Cs-134m	3.2E-01	3.2E + 02	3.2E + 05
Cs-135	2.4E-02	2.4E + 01	2.4E + 04
Cs-136	2.1E-03	2.1E + 00	2.1E + 03
Cs-137	2.3E-05	2.3E-02	2.3E + 01
Cs-138	4.4E-01	4.4E + 02	4.4E + 05
Cu-61	4.0E-01	4.0E + 02	4.0E + 05
Cu-64	5.2E-01	5.2E + 02	5.2E + 05
Cu-67	1.5E-01	1.5E + 02	1.5E + 05
Dy-157	4.4E-01	4.4E + 02	4.4E + 05
Dy-165	5.6E + 00	5.6E + 03	5.6E + 06
Dy-166	8.1E-02	8.1E + 01	8.1E + 04

Er-169	4.0E-01	4.0E + 02	4.0E + 05
Er-171	3.6E-01	3.6E + 02	3.6E + 05
Es-253	2.6E-04	2.6E-01	2.6E + 02
Es-254	2.3E-05	2.3E-02	2.3E + 01
Es-254m	1.8E-03	1.8E + 00	1.8E + 03
Eu-152	1.6E-05	1.6E-02	1.6E + 01
Eu-152m	3.5E-01	3.5E + 02	3.5E + 05
Eu-154	2.0E-05	2.0E-02	2.0E + 01
Eu-155	5.2E-04	5.2E-01	5.2E + 02
Eu-156	3.2E-03	3.2E + 00	3.2E + 03
F-18	5.6E-01	5.6E + 02	5.6E + 05
Fe-52	4.9E-02	4.9E + 01	4.9E + 04
Fe-55	1.4E-01	1.4E + 02	1.4E + 05
Fe-59	1.3E-03	1.3E + 00	1.3E + 03
Fm-254	1.8E-02	1.8E + 01	1.8E + 04
Fm-255	4.0E-03	4.0E + 00	4.0E + 03
Fr-223	1.4E-01	1.4E + 02	1.4E + 05
Ga-66	5.6E-02	5.6E + 01	5.6E + 04
Ga-67	1.1E-01	1.1E + 02	1.1E + 05
Ga-68	7.6E-01	7.6E + 02	7.6E + 05

Ga-72	3.6E-02	3.6E + 01	3.6E + 04
Gd-152	4.4E-06	4.4E-03	4.4E + 00
Gd-153	2.0E-03	2.0E + 00	2.0E + 03
Gd-159	6.8E-01	6.8E + 02	6.8E + 05
Ge-68	2.3E-04	2.3E-01	2.3E + 02
Ge-71	2.6E + 00	2.6E + 03	2.6E + 06
Ge-77	1.0E-01	1.0E + 02	1.0E + 05
H-3	1.5E + 01	1.5E + 04	1.5E + 07
Hf-181	2.5E-03	2.5E + 00	2.5E + 03
Hg-193m	9.5E-02	9.5E + 01	9.5E + 04
Hg-197	2.4E-01	2.4E + 02	2.4E + 05
Hg-197m	2.5E-01	2.5E + 02	2.5E + 05
Hg-203	5.2E-03	5.2E + 00	5.2E + 03
Ho-166	2.8E-01	2.8E + 02	2.8E + 05
Ho-166m	6.0E-06	6.0E-03	6.0E + 00
I-123	4.9E-01	4.9E + 02	4.9E + 05
I-124	9.3E-03	9.3E + 00	9.3E + 03
I-125	6.2E-03	6.2E + 00	6.2E + 03
I-126	3.7E-03	3.7E + 00	3.7E + 03
I-128	9.3E + 00	9.3E + 03	9.3E + 06

I-129	2.6E-04	2.6E-01	2.6E + 02
I-130	4.6E-02	4.6E + 01	4.6E + 04
I-131	6.7E-03	6.7E + 00	6.7E + 03
I-132	2.0E-01	2.0E + 02	2.0E + 05
I-133	6.7E-02	6.7E + 01	6.7E + 04
I-134	3.2E-01	3.2E + 02	3.2E + 05
I-135	1.2E-01	1.2E + 02	1.2E + 05
In-111	4.9E-02	4.9E + 01	4.9E + 04
In-113m	2.1E + 00	2.1E + 03	2.1E + 06
In-114m	4.9E-03	4.9E + 00	4.9E + 03
In-115	2.7E-04	2.7E-01	2.7E + 02
In-115m	1.4E + 00	1.4E + 03	1.4E + 06
In-116m	3.5E-01	3.5E + 02	3.5E + 05
In-117	1.3E + 00	1.3E + 03	1.3E + 06
In-117m	7.6E-02	7.6E + 01	7.6E + 04
Ir-190	3.5E-03	3.5E + 00	3.5E + 03
Ir-192	9.7E-04	9.7E-01	9.7E + 02
Ir-194	2.5E-01	2.5E + 02	2.5E + 05
Ir-194m	1.5E-04	1.5E-01	1.5E + 02
K-40	6.8E-05	6.8E-02	6.8E + 01

K-42	2.9E-01	2.9E + 02	2.9E + 05
K-43	6.0E-02	6.0E + 01	6.0E + 04
K-44	4.9E-01	4.9E + 02	4.9E + 05
Kr-79	7.0E + 00		
Kr-81	1.8E + 02		
Kr-83m	2.0E + 04		
Kr-85	8.4E + 02		
Kr-85m	1.1E + 01		
Kr-87	2.0E + 00		
Kr-88	4.2E-01		
La-140	1.6E-02	1.6E + 01	1.6E + 04
La-141	1.1E + 00	1.1E + 03	1.1E + 06
La-142	2.3E-01	2.3E + 02	2.3E + 05
Lu-177	1.4E-01	1.4E + 02	1.4E + 05
Lu-177m	3.5E-04	3.5E-01	3.5E + 02
Mg-28	2.1E-02	2.1E + 01	2.1E + 04
Mn-52	3.5E-03	3.5E + 00	3.5E + 03
Mn-52m	5.2E-01	5.2E + 02	5.2E + 05
Mn-53	5.7E-02	5.7E + 01	5.7E + 04
Mn-54	2.5E-04	2.5E-01	2.5E + 02

Mn-56	2.5E-01	2.5E + 02	2.5E + 05
Mo-93	1.5E-03	1.5E + 00	1.5E + 03
Mo-99**	5.7E-02	5.7E + 01	5.7E + 04
Mo-101	8.4E-01	8.4E + 02	8.4E + 05
Na-22	3.2E-05	3.2E-02	3.2E + 01
Na-24	2.6E-02	2.6E + 01	2.6E + 04
Nb-90	2.5E-02	2.5E + 01	2.5E + 04
Nb-93m	1.2E-02	1.2E + 01	1.2E + 04
Nb-94	6.0E-06	6.0E-03	6.0E + 00
Nb-95	2.3E-03	2.3E + 00	2.3E + 03
Nb-95m	2.0E-02	2.0E + 01	2.0E + 04
Nb-96	2.5E-02	2.5E + 01	2.5E + 04
Nb-97	1.0E + 00	1.0E + 03	1.0E + 06
Nd-147	3.0E-02	3.0E + 01	3.0E + 04
Nd-149	1.1E + 00	1.1E + 03	1.1E + 06
Ni-56	2.0E-03	2.0E + 00	2.0E + 03
Ni-57	2.1E-02	2.1E + 01	2.1E + 04
Ni-59	2.2E-02	2.2E + 01	2.2E + 04
Ni-63	1.4E-01	1.4E + 02	1.4E + 05
Ni-65	7.0E-01	7.0E + 02	7.0E + 05



Np-235	3.0E-02	3.0E + 01	3.0E + 04
Np-237	1.8E-06	1.8E-03	1.8E + 00
Np-238	1.9E-02	1.9E + 01	1.9E + 04
Np-239	1.0E-01	1.0E + 02	1.0E + 05
Np-240	6.5E-01	6.5E + 02	6.5E + 05
Np-240m	4.7E + 00	4.7E + 03	4.7E + 06
Os-185	9.2E-04	9.2E-01	9.2E + 02
Os-191m	9.0E-01	9.0E + 02	9.0E + 05
Os-191	3.8E-02	3.8E + 01	3.8E + 04
Os-193	2.9E-01	2.9E + 02	2.9E + 05
P-32	1.7E-02	1.7E + 01	1.7E + 04
P-33	1.2E-01	1.2E + 02	1.2E + 05
Pa-230	6.3E-04	6.3E-01	6.3E + 02
Pa-231	8.3E-07	8.3E-04	8.3E-01
Pa-233	9.3E-03	9.3E + 00	9.3E + 03
Pa-234	9.3E-02	9.3E + 01	9.3E + 04
Pb-203	8.3E-02	8.3E + 01	8.3E + 04
Pb-205	1.2E-02	1.2E + 01	1.2E + 04
Pb-209	1.1E + 01	1.1E + 04	1.1E + 07
Pb-210	5.5E-05	5.5E-02	5.5E + 01

Pb-211	1.2E-01	1.2E + 02	1.2E + 05
Pb-212	6.0E-03	6.0E + 00	6.0E + 03
Pb-214	1.2E-01	1.2E + 02	1.2E + 05
Pd-103	2.1E-01	2.1E + 02	2.1E + 05
Pd-107	8.2E-02	8.2E + 01	8.2E + 04
Pd-109	9.4E-01	9.4E + 02	9.4E + 05
Pm-143	7.6E-04	7.6E-01	7.6E + 02
Pm-144	1.1E-04	1.1E-01	1.1E + 02
Pm-145	5.2E-04	5.2E-01	5.2E + 02
Pm-146	4.4E-05	4.4E-02	4.4E + 01
Pm-147	2.6E-02	2.6E + 01	2.6E + 04
Pm-148	1.7E-02	1.7E + 01	1.7E + 04
Pm-148m	7.6E-04	7.6E-01	7.6E + 02
Pm-149	2.8E-01	2.8E + 02	2.8E + 05
Pm-151	1.2E-01	1.2E + 02	1.2E + 05
Po-210	9.3E-05	9.3E-02	9.3E + 01
Pr-142	2.8E-01	2.8E + 02	2.8E + 05
Pr-143	1.0E-01	1.0E + 02	1.0E + 05
Pr-144	1.5E + 01	1.5E + 04	1.5E + 07
Pt-191	6.4E-02	6.4E + 01	6.4E + 04

Pt-193	2.1E-02	2.1E + 01	2.1E + 04
Pt-193m	4.8E-01	4.8E + 02	4.8E + 05
Pt-195m	1.4E-01	1.4E + 02	1.4E + 05
Pt-197	1.1E + 00	1.1E + 03	1.1E + 06
Pt-197m	3.6E + 00	3.6E + 03	3.6E + 06
Pu-236	7.0E-06	7.0E-03	7.0E + 00
Pu-237	2.3E-02	2.3E + 01	2.3E + 04
Pu-238	2.7E-06	2.7E-03	2.7E + 00
Pu-239	2.5E-06	2.5E-03	2.5E + 00
Pu-240	2.5E-06	2.5E-03	2.5E + 00
Pu-241	1.3E-04	1.3E-01	1.3E + 02
Pu-242	2.5E-06	2.5E-03	2.5E + 00
Pu-243	3.8E + 00	3.8E + 03	3.8E + 06
Pu-244	2.4E-06	2.4E-03	2.4E + 00
Pu-245	2.1E-01	2.1E + 02	2.1E + 05
Pu-246	4.8E-03	4.8E + 00	4.8E + 03
Ra-223	1.3E-04	1.3E-01	1.3E + 02
Ra-224	3.2E-04	3.2E-01	3.2E + 02
Ra-225	1.3E-04	1.3E-01	1.3E + 02
Ra-226	5.5E-06	5.5E-03	5.5E + 00

Ra-228	1.3E-05	1.3E-02	1.3E + 01
Rb-81	4.2E-01	4.2E + 02	4.2E + 05
Rb-83	1.4E-03	1.4E + 00	1.4E + 03
Rb-84	2.0E-03	2.0E + 00	2.0E + 03
Rb-86	1.7E-02	1.7E + 01	1.7E + 04
Rb-87	1.0E-02	1.0E + 01	1.0E + 04
Rb-88	1.7E + 00	1.7E + 03	1.7E + 06
Rb-89	6.4E-01	6.4E + 02	6.4E + 05
Re-184	1.8E-03	1.8E + 00	1.8E + 03
Re-184m	3.6E-04	3.6E-01	3.6E + 02
Re-186	1.9E-01	1.9E + 02	1.9E + 05
Re-187	9.3E + 00	9.3E + 03	9.3E + 06
Re-188	3.7E-01	3.7E + 02	3.7E + 05
Rh-103m	1.7E + 02	1.7E + 05	1.7E + 08
Rh-105	3.4E-01	3.4E + 02	3.4E + 05
Ru-97	8.3E-02	8.3E + 01	8.3E + 04
Ru-103	3.1E-03	3.1E + 00	3.1E + 03
Ru-105	2.9E-01	2.9E + 02	2.9E + 05
Ru-106	5.9E-04	5.9E-01	5.9E + 02
S-35	7.5E-02	7.5E + 01	7.5E + 04

Sb-117	2.0E + 00	2.0E + 03	2.0E + 06
Sb-122	3.9E-02	3.9E + 01	3.9E + 04
Sb-124	6.0E-04	6.0E-01	6.0E + 02
Sb-125	1.4E-04	1.4E-01	1.4E + 02
Sb-126	1.8E-03	1.8E + 00	1.8E + 03
Sb-126m	7.6E-01	7.6E + 02	7.6E + 05
Sb-127	2.0E-02	2.0E + 01	2.0E + 04
Sb-129	1.8E-01	1.8E + 02	1.8E + 05
Sc-44	1.4E-01	1.4E + 02	1.4E + 05
Sc-46	4.0E-04	4.0E-01	4.0E + 02
Sc-47	1.1E-01	1.1E + 02	1.1E + 05
Sc-48	1.1E-02	1.1E + 01	1.1E + 04
Sc-49	1.0E + 01	1.0E + 04	1.0E + 07
Se-73	1.6E-01	1.6E + 02	1.6E + 05
Se-75	1.1E-03	1.1E + 00	1.1E + 03
Se-79	6.9E-03	6.9E + 00	6.9E + 03
Si-31	4.7E + 00	4.7E + 03	4.7E + 06
Si-32	7.2E-04	7.2E-01	7.2E + 02
Sm-147	1.4E-05	1.4E-02	1.4E + 01
Sm-151	3.5E-02	3.5E + 01	3.5E + 04

Sm-153	2.4E-01	2.4E + 02	2.4E + 05
Sn-113	1.9E-03	1.9E + 00	1.9E + 03
Sn-117m	2.3E-02	2.3E + 01	2.3E + 04
Sn-119m	2.8E-02	2.8E + 01	2.8E + 04
Sn-123	1.8E-02	1.8E + 01	1.8E + 04
Sn-125	7.2E-03	7.2E + 00	7.2E + 03
Sn-126	4.7E-06	4.7E-03	4.7E + 00
Sr-82	1.9E-03	1.9E + 00	1.9E + 03
Sr-85	1.9E-03	1.9E + 00	1.9E + 03
Sr-85m	1.5E + 00	1.5E + 03	1.5E + 06
Sr-87m	1.2E + 00	1.2E + 03	1.2E + 06
Sr-89	2.1E-02	2.1E + 01	2.1E + 04
Sr-90	5.2E-04	5.2E-01	5.2E + 02
Sr-91	1.2E-01	1.2E + 02	1.2E + 05
Sr-92	2.5E-01	2.5E + 02	2.5E + 05
Ta-182	4.4E-04	4.4E-01	4.4E + 02
Tb-157	2.2E-03	2.2E + 00	2.2E + 03
Tb-160	8.4E-04	8.4E-01	8.4E + 02
Tc-95	9.0E-02	9.0E + 01	9.0E + 04
Tc-95m	1.4E-03	1.4E + 00	1.4E + 03

Tc-96	5.6E-03	5.6E + 00	5.6E + 03
Tc-96m	7.0E-01	7.0E + 02	7.0E + 05
Tc-97	1.5E-03	1.5E + 00	1.5E + 03
Tc-97m	7.2E-02	7.2E + 01	7.2E + 04
Tc-98	6.4E-06	6.4E-03	6.4E + 00
Tc-99	9.0E-03	9.0E + 00	9.0E + 03
Tc-99m	1.4E + 00	1.4E + 03	1.4E + 06
Tc-101	3.8E + 00	3.8E + 03	3.8E + 06
Te-121	6.0E-03	6.0E + 00	6.0E + 03
Te-121m	5.3E-04	5.3E-01	5.3E + 02
Te-123	1.2E-03	1.2E + 00	1.2E + 03
Te-123m	2.7E-03	2.7E + 00	2.7E + 03
Te-125m	1.5E-02	1.5E + 01	1.5E + 04
Te-127	2.9E + 00	2.9E + 03	2.9E + 06
Te-127m	7.3E-03	7.3E + 00	7.3E + 03
Te-129	6.5E + 00	6.5E + 03	6.5E + 06
Te-129m	6.1E-03	6.1E + 00	6.1E + 03
Te-131	9.4E-01	9.4E + 02	9.4E + 05
Te-131m	1.8E-02	1.8E + 01	1.8E + 04
Te-132	6.2E-03	6.2E + 00	6.2E + 03

Te-133	1.2E + 00	1.2E + 03	1.2E + 06
Te-133m	2.9E-01	2.9E + 02	2.9E + 05
Te-134	4.4E-01	4.4E + 02	4.4E + 05
Th-226	3.0E-02	3.0E + 01	3.0E + 04
Th-227	6.4E-05	6.4E-02	6.4E + 01
Th-228	2.9E-06	2.9E-03	2.9E + 00
Th-229	4.9E-07	4.9E-04	4.9E-01
Th-230	3.2E-06	3.2E-03	3.2E + 00
Th-231	8.4E-01	8.4E + 02	8.4E + 05
Th-232	6.0E-07	6.0E-04	6.0E-01
Th-234	2.0E-02	2.0E + 01	2.0E + 04
Ti-44	5.2E-06	5.2E-03	5.2E + 00
Ti-45	4.0E-01	4.0E + 02	4.0E + 05
Tl-200	4.4E-02	4.4E + 01	4.4E + 04
Tl-201	1.8E-01	1.8E + 02	1.8E + 05
Tl-202	1.0E-02	1.0E + 01	1.0E + 04
Tl-204	2.5E-02	2.5E + 01	2.5E + 04
Tm-170	2.4E-02	2.4E + 01	2.4E + 04
Tm-171	5.9E-02	5.9E + 01	5.9E + 04
U-230	5.0E-05	5.0E-02	5.0E + 01



U-231	1.4E-01	1.4E + 02	1.4E + 05
U-232	1.3E-06	1.3E-03	1.3E + 00
U-233	7.6E-06	7.6E-03	7.6E + 00
U-234	7.6E-06	7.6E-03	7.6E + 00
U-235	7.0E-06	7.0E-03	7.0E + 00
U-236	8.4E-06	8.4E-03	8.4E + 00
U-237	4.7E-02	4.7E + 01	4.7E + 04
U-238	8.6E-06	8.6E-03	8.6E + 00
U-239	8.3E + 00	8.3E + 03	8.3E + 06
U-240	1.8E-01	1.8E + 02	1.8E + 05
V-48	1.4E-03	1.4E + 00	1.4E + 03
V-49	1.3E + 00	1.3E + 03	1.3E + 06
W-181	1.1E-02	1.1E + 01	1.1E + 04
W-185	1.6E-01	1.6E + 02	1.6E + 05
W-187	1.1E-01	1.1E + 02	1.1E + 05
W-188	1.0E-02	1.0E + 01	1.0E + 04
Xe-122	7.6E-02	7.6E + 01	7.6E + 04
Xe-123	1.6E + 00	1.6E + 03	1.6E + 06
Xe-125	6.0E-01		
Xe-127	7.0E + 00		

Xe-129m	7.6E + 01		
Xe-131m	2.2E + 02		
Xe-133	5.2E + 01		
Xe-133m	6.0E + 01		
Xe-135	7.6E + 00		
Xe-135m	4.2E + 00		
Xe-138	9.9E-01		
Y-86	2.8E-02	2.8E + 01	2.8E + 04
Y-87	2.3E-02	2.3E + 01	2.3E + 04
Y-88	2.5E-04	2.5E-01	2.5E + 02
Y-90	1.1E-01	1.1E + 02	1.1E + 05
Y-90m	4.3E-01	4.3E + 02	4.3E + 05
Y-91	1.8E-02	1.8E + 01	1.8E + 04
Y-91m	1.6E + 00	1.6E + 03	1.6E + 06
Y-92	7.0E-01	7.0E + 02	7.0E + 05
Y-93	3.8E-01	3.8E + 02	3.8E + 05
Yb-169	5.5E-03	5.5E + 00	5.5E + 03
Yb-175	2.1E-01	2.1E + 02	2.1E + 05
Zn-62	8.6E-02	8.6E + 01	8.6E + 04
Zn-65	4.4E-04	4.4E-01	4.4E + 02

Zn-69	2.7E + 01	2.7E + 04	2.7E + 07
Zn-69m	2.0E-01	2.0E + 02	2.0E + 05
Zr-86	2.4E-02	2.4E + 01	2.4E + 04
Zr-88	2.7E-04	2.7E-01	2.7E + 02
Zr-89	1.6E-02	1.6E + 01	1.6E + 04
Zr-93	2.8E-03	2.8E + 00	2.8E + 03
Zr-95	6.4E-04	6.4E-01	6.4E + 02
Zr-97	4.6E-02	4.6E + 01	4.6E + 04

\*Radionuclides boiling at 100 °C or less, or exposed to a temperature of 100 °C, must be considered a gas. Capsules containing radionuclides in liquid or powder form can be considered to be solids.

\*\*Mo-99 contained in a generator to produce Technetium-99 can be assumed to be a solid.

### 3. Table of Concentration Levels

(a) Table 2 may be used for determining if facilities are in compliance with the standard.

1. The concentration table as applied to emission estimates can only be used if all releases are from point sources and concentrations have been measured at the stack or vent using EPA-approved methods, and the distance between each stack or vent and the nearest resident is greater than 3 times the diameter of the stack or vent. Procedures provided in Ref. (1) shall be used to determine compliance or exemption from reporting by use of Table 2.

2. The concentration table may be used to determine compliance with the standard based on environmental measurements provided these measurements are made in conformance with the requirements of §61.107(b)(5).

### 4. NCRP Screening Model

The procedures described in Reference (4) may be used to determine doses to members of the general public from emissions of radionuclides to the atmosphere. Both the total dose from all radionuclides emitted, and the dose caused by radioactive iodine must be considered in accordance with the procedures in Ref. (1).

### 5. The COMPLY Computer Code

The COMPLY computer code may be used to determine compliance with subpart I. The compliance model in the COMPLY computer code may be used to determine the dose to members of the general public from emissions of radionuclides to the atmosphere. The EPA may add radionuclides to all or any part of COMPLY to cover radionuclides that may be used by the regulated community.

**Table 2—Concentration Levels for Environmental Compliance**

<b>Radionuclide</b>	<b>Concentration (Ci/m<sup>3</sup>)</b>	<b>Radionuclide</b>	<b>Concentration (Ci/m<sup>3</sup>)</b>
Ac-225	9.1E-14	Bi-207	1.0E-14
Ac-227	1.6E-16	Bi-210	2.9E-13
Ac-228	3.7E-12	Bi-212	5.6E-11
Ag-106	1.9E-09	Bi-213	7.1E-11
Ag-106m	1.2E-12	Bi-214	1.4E-10
Ag-108m	7.1E-15	Bk-249	5.6E-13
Ag-110m	9.1E-14	Bk-250	9.1E-11
Ag-111	2.5E-12	Br-77	4.2E-11
Al-26	4.8E-15	Br-80	1.4E-08
Am-241	1.9E-15	Br-80m	1.8E-09
Am-242	1.5E-11	Br-82	1.2E-11
Am-242m	2.0E-15	Br-83	1.2E-08
Am-243	1.8E-15	Br-84	6.7E-10
Am-244	4.0E-11	C-11	1.5E-09
Am-245	8.3E-09	C-14	1.0E-11
Am-246	1.2E-09	Ca-41	4.2E-13

Ar-37	1.6E-03	Ca-45	1.3E-12
Ar-41	1.7E-09	Ca-47	2.4E-12
As-72	2.4E-11	Cd-109	5.9E-13
As-73	1.1E-11	Cd-113	9.1E-15
As-74	2.2E-12	Cd-113m	1.7E-14
As-76	5.0E-11	Cd-115	1.6E-11
As-77	1.6E-10	Cd-115m	8.3E-13
At-211	1.1E-11	Cd-117	6.7E-11
Au-193	3.8E-10	Cd-117m	1.6E-10
Au-194	3.2E-11	Ce-139	2.6E-12
Au-195	3.1E-12	Ce-141	6.3E-12
Au-198	2.1E-11	Ce-143	3.0E-11
Au-199	4.8E-11	Ce-144	6.2E-13
Ba-131	7.1E-12	Cf-248	1.8E-14
Ba-133	5.9E-14	Cf-249	1.4E-15
Ba-133m	5.9E-11	Cf-250	3.2E-15
Ba-135m	1.8E-10	Cf-251	1.4E-15
Ba-139	5.6E-09	Cf-252	5.6E-15
Ba-140	1.3E-12	Cf-253	3.1E-13
Ba-141	1.4E-09	Cf-254	3.0E-15

Ba-142	1.3E-09	Cl-36	2.7E-15
Be-7	2.3E-11	Cl-38	7.7E-10
Be-10	1.6E-12	Cm-242	5.3E-14
Bi-206	2.3E-12	Cm-243	2.6E-15
Cm-244	3.3E-15	Eu-156	1.9E-12
Cm-245	1.8E-15	F-18	6.7E-10
Cm-246	1.9E-15	Fe-52	5.6E-11
Cm-247	1.9E-15	Fe-55	9.1E-12
Cm-248	5.0E-16	Fe-59	6.7E-13
Cm-249	3.7E-09	Fm-254	2.0E-11
Cm-250	9.1E-17	Fm-255	4.3E-12
Co-56	1.8E-13	Fr-223	3.3E-11
Co-57	1.3E-12	Ga-66	6.2E-11
Co-58	6.7E-13	Ga-67	7.1E-11
Co-58m	1.2E-10	Ga-68	9.1E-10
Co-60	1.7E-14	Ga-72	3.8E-11
Co-60m	4.3E-09	Gd-152	5.0E-15
Co-61	4.5E-09	Gd-153	2.1E-12
Cr-49	1.1E-09	Gd-159	2.9E-10
Cr-51	3.1E-11	Ge-68	2.0E-13

Cs-129	1.4E-10	Ge-71	2.4E-10
Cs-131	3.3E-11	Ge-77	1.0E-10
Cs-132	4.8E-12	H-3	1.5E-09
Cs-134	2.7E-14	Hf-181	1.9E-12
Cs-134m	1.7E-10	Hg-193m	1.0E-10
Cs-135	4.0E-13	Hg-197	8.3E-11
Cs-136	5.3E-13	Hg-197m	1.1E-10
Cs-137	1.9E-14	Hg-203	1.0E-12
Cs-138	5.3E-10	Ho-166	7.1E-11
Cu-61	4.8E-10	Ho-166m	7.1E-15
Cu-64	5.3E-10	I-123	4.3E-10
Cu-67	5.0E-11	I-124	6.2E-13
Dy-157	5.0E-10	I-125	1.2E-13
Dy-165	6.7E-09	I-126	1.1E-13
Dy-166	1.1E-11	I-128	1.1E-08
Er-169	2.9E-11	I-129	9.1E-15
Er-171	4.0E-10	I-130	4.5E-11
Es-253	2.4E-13	I-131	2.1E-13
Es-254	2.0E-14	I-132	2.3E-10
Es-254m	1.8E-12	I-133	2.0E-11

Eu-152	2.0E-14	I-134	3.8E-10
Eu-152m	3.6E-10	I-135	1.2E-10
Eu-154	2.3E-14	In-111	3.6E-11
Eu-155	5.9E-13	In-113m	2.5E-09
In-114m	9.1E-13	Nb-95	2.2E-12
In-115	7.1E-14	Nb-95m	1.4E-11
In-115m	1.6E-09	Nb-96	2.4E-11
In-116m	4.2E-10	Nb-97	1.2E-09
In-117	1.6E-09	Nd-147	7.7E-12
In-117m	9.1E-11	Nd-149	7.1E-10
Ir-190	2.6E-12	Ni-56	1.7E-12
Ir-192	9.1E-13	Ni-57	1.8E-11
Ir-194	1.1E-10	Ni-59	1.5E-11
Ir-194m	1.7E-13	Ni-63	1.4E-11
K-40	2.7E-14	Ni-65	8.3E-10
K-42	2.6E-10	Np-235	2.5E-11
K-43	6.2E-11	Np-237	1.2E-15
K-44	5.9E-10	Np-238	1.4E-11
Kr-79	8.3E-09	Np-239	3.8E-11
Kr-81	2.1E-07	Np-240	7.7E-10



Kr-83m	2.3E-05	Np-240m	5.6E-09
Kr-85	1.0E-06	Os-185	1.0E-12
Kr-85m	1.3E-08	Os-191m	2.9E-10
Kr-87	2.4E-09	Os-191	1.1E-11
Kr-88	5.0E-10	Os-193	9.1E-11
La-140	1.2E-11	P-32	3.3E-13
La-141	7.7E-10	P-33	2.4E-12
La-142	2.7E-10	Pa-230	3.2E-13
Lu-177	2.4E-11	Pa-231	5.9E-16
Lu-177m	3.6E-13	Pa-233	4.8E-12
Mg-28	1.5E-11	Pa-234	1.1E-10
Mn-52	2.8E-12	Pb-203	6.2E-11
Mn-52m	6.2E-10	Pb-205	5.6E-12
Mn-53	1.5E-11	Pb-209	1.3E-08
Mn-54	2.8E-13	Pb-210	2.8E-15
Mn-56	2.9E-10	Pb-211	1.4E-10
Mo-93	1.1E-12	Pb-212	6.3E-12
Mo-99	1.4E-11	Pb-214	1.2E-10
Mo-101	1.0E-09	Pd-103	3.8E-11
Na-22	2.6E-14	Pd-107	3.1E-11

Na-24	2.6E-11	Pd-109	4.8E-10
Nb-90	2.6E-11	Pm-143	9.1E-13
Nb-93m	1.0E-11	Pm-144	1.3E-13
Nb-94	7.1E-15	Pm-145	6.2E-13
Pm-146	5.3E-14	Re-184m	3.7E-13
Pm-147	1.1E-11	Re-186	1.8E-11
Pm-148	5.0E-12	Re-187	2.6E-10
Pm-148m	6.7E-13	Re-188	1.7E-10
Pm-149	4.2E-11	Rh-103m	2.1E-07
Pm-151	7.1E-11	Rh-105	1.3E-10
Po-210	7.1E-15	Ru-97	6.7E-11
Pr-142	1.1E-10	Ru-103	2.6E-12
Pr-143	7.1E-12	Ru-105	2.8E-10
Pr-144	1.8E-08	Ru-106	3.4E-13
Pt-191	4.3E-11	S-35	1.3E-12
Pt-193	1.8E-11	Sb-117	2.4E-09
Pt-193m	4.8E-11	Sb-122	1.4E-11
Pt-195m	3.2E-11	Sb-124	5.3E-13
Pt-197	4.0E-10	Sb-125	1.6E-13
Pt-197m	2.6E-09	Sb-126	1.4E-12

Pu-236	5.9E-15	Sb-126m	9.1E-10
Pu-237	1.9E-11	Sb-127	7.1E-12
Pu-238	2.1E-15	Sb-129	7.7E-11
Pu-239	2.0E-15	Sc-44	1.7E-10
Pu-240	2.0E-15	Sc-46	4.2E-13
Pu-241	1.0E-13	Sc-47	3.8E-11
Pu-242	2.0E-15	Sc-48	9.1E-12
Pu-243	4.2E-09	Sc-49	1.2E-08
Pu-244	2.0E-15	Se-73	1.7E-10
Pu-245	2.1E-10	Se-75	1.7E-13
Pu-246	2.2E-12	Se-79	1.1E-13
Ra-223	4.2E-14	Si-31	5.6E-09
Ra-224	1.5E-13	Si-32	3.4E-14
Ra-225	5.0E-14	Sm-147	1.4E-14
Ra-226	3.3E-15	Sm-151	2.1E-11
Ra-228	5.9E-15	Sm-153	5.9E-11
Rb-81	5.0E-10	Sn-113	1.4E-12
Rb-83	3.4E-13	Sn-117m	5.6E-12
Rb-84	3.6E-13	Sn-119m	5.3E-12
Rb-86	5.6E-13	Sn-123	1.1E-12

Rb-87	1.6E-13	Sn-125	1.7E-12
Rb-88	2.1E-09	Sn-126	5.3E-15
Rb-89	7.1E-10	Sr-82	6.2E-13
Re-184	1.5E-12	Sr-85	1.8E-12
Sr-85m	1.6E-09	Th-232	6.2E-16
Sr-87m	1.4E-09	Th-234	2.2E-12
Sr-89	1.8E-12	Ti-44	6.2E-15
Sr-90	1.9E-14	Ti-45	4.8E-10
Sr-91	9.1E-11	Tl-200	4.5E-11
Sr-92	2.9E-10	Tl-201	1.0E-10
Ta-182	4.5E-13	Tl-202	5.0E-12
Tb-157	2.5E-12	Tl-204	1.2E-12
Tb-160	7.7E-13	Tm-170	3.3E-12
Tc-95	1.0E-10	Tm-171	2.6E-11
Tc-95m	1.4E-12	U-230	1.5E-14
Tc-96	5.6E-12	U-231	4.2E-11
Tc-96m	6.7E-10	U-232	1.3E-15
Tc-97	7.1E-13	U-233	7.1E-15
Tc-97m	7.1E-12	U-234	7.7E-15
Tc-98	6.7E-15	U-235	7.1E-15

Tc-99	1.4E-13	U-236	7.7E-15
Tc-99m	1.7E-09	U-237	1.0E-11
Tc-101	4.5E-09	U-238	8.3E-15
Te-121	1.0E-12	U-239	4.3E-09
Te-121m	1.2E-13	U-240	1.3E-10
Te-123	1.4E-13	V-48	1.0E-12
Te-123m	2.0E-13	V-49	1.6E-10
Te-125m	3.6E-13	W-181	6.7E-12
Te-127	1.0E-09	W-185	2.6E-12
Te-127m	1.5E-13	W-187	7.7E-11
Te-129	7.7E-09	W-188	5.3E-13
Te-129m	1.4E-13	Xe-122	9.1E-11
Te-131	9.1E-11	Xe-123	1.6E-09
Te-131m	1.0E-12	Xe-125	1.1E-11
Te-132	7.1E-13	Xe-127	8.3E-09
Te-133	9.1E-10	Xe-129m	9.1E-08
Te-133m	2.2E-10	Xe-131m	2.6E-07
Te-134	5.3E-10	Xe-133	6.2E-08
Th-226	3.4E-11	Xe-133m	7.1E-08
Th-227	3.8E-14	Xe-135	9.1E-09

Th-228	3.1E-15	Xe-135m	5.0E-09
Th-229	5.3E-16	Xe-138	1.2E-09
Th-230	3.4E-15	Y-86	3.0E-11
Th-231	2.9E-10	Y-87	1.7E-11
Y-88	2.7E-13	Zn-65	9.1E-14
Y-90	1.3E-11	Zn-69	3.2E-08
Y-90m	1.9E-10	Zn-69m	1.7E-10
Y-91	2.1E-12	Zr-86	2.4E-11
Y-91m	1.3E-09	Zr-88	3.1E-13
Y-92	8.3E-10	Zr-89	1.3E-11
Y-93	2.9E-10	Zr-93	2.6E-12
Yb-169	3.7E-12	Zr-95	6.7E-13
Yb-175	4.3E-11	Zr-97	3.8E-11
Zn-62	9.1E-11		

## 6. References

(1) Environmental Protection Agency, "A Guide for Determining Compliance with the Clean Air Act Standards for Radionuclides Emissions from NRC-Licensed and Non-DOE Federal Facilities", EPA 520/1-89-002, October 1989.

(2) Environmental Protection Agency, "User's Guide for the COMPLY Code", EPA 520/1-89-003, October 1989.

(3) Environmental Protection Agency, "Background Information Document: Procedures Approved for Demonstrating Compliance with 40 CFR Part 61, Subpart F", EPA 520/1-89-001, January 1989.

(4) National Council on Radiation Protection and Measurement, "Screening Techniques for Determining Compliance with Environmental Standards" NCRP Commentary No. 3, Revision of January 1989 with addendum of October, 1989.

[54 FR 51711, Dec. 15, 1989]

[↑ Back to Top](#)

# **APPENDIX E**



## Electronic Code of Federal Regulations

---

[View past updates to the e-CFR.](#)

[Click here to learn more.](#)

---

**e-CFR data is current as of January 17, 2017**

[Title 40](#) → [Chapter I](#) → [Subchapter C](#) → [Part 63](#) → [Subpart F](#)

---

[Browse Previous](#) | [Browse Next](#)

Title 40: Protection of Environment

[PART 63—NATIONAL EMISSION STANDARDS FOR HAZARDOUS AIR POLLUTANTS FOR SOURCE CATEGORIES](#)

---

### **Subpart F—National Emission Standards for Organic Hazardous Air Pollutants From the Synthetic Organic Chemical Manufacturing Industry**

---

#### **Contents**

[§63.100](#) Applicability and designation of source.

[§63.101](#) Definitions.

[§63.102](#) General standards.

[§63.103](#) General compliance, reporting, and recordkeeping provisions.

[§63.104](#) Heat exchange system requirements.

[§63.105](#) Maintenance wastewater requirements.

[§63.106](#) Implementation and enforcement.

[§63.107](#) Identification of process vents subject to this subpart.

[Table 1 to Subpart F of Part 63—Synthetic Organic Chemical Manufacturing Industry Chemicals](#)

[Table 2 to Subpart F of Part 63—Organic Hazardous Air Pollutants](#)

[Table 3 to Subpart F of Part 63—General Provisions Applicability to Subparts F, G, and H to Subpart F](#)

[Table 4 to Subpart F of Part 63—Organic Hazardous Air Pollutants Subject to Cooling Tower Monitoring Requirements in §63.104](#)

---

Source: 59 FR 19454, Apr. 22, 1994, unless otherwise noted.

[↑ Back to Top](#)

**§63.100** **Applicability and designation of source.**

(a) This subpart provides applicability provisions, definitions, and other general provisions that are applicable to subparts G and H of this part.

(b) Except as provided in paragraphs (b)(4) and (c) of this section, the provisions of subparts F, G, and H of this part apply to chemical manufacturing process units that meet all the criteria specified in paragraphs (b)(1), (b)(2), and (b)(3) of this section:

(1) Manufacture as a primary product one or more of the chemicals listed in paragraphs (b)(1)(i) or (b)(1)(ii) of this section.

(i) One or more of the chemicals listed in table 1 of this subpart; or

(ii) One or more of the chemicals listed in paragraphs (b)(1)(ii)(A) or (b)(1)(ii)(B) of this section:

(A) Tetrahydrobenzaldehyde (CAS Number 100-50-5); or

(B) Crotonaldehyde (CAS Number 123-73-9).

(2) Use as a reactant or manufacture as a product, or co-product, one or more of the organic hazardous air pollutants listed in table 2 of this subpart;

(3) Are located at a plant site that is a major source as defined in section 112(a) of the Act.

(4) The owner or operator of a chemical manufacturing processing unit is exempt from all requirements of subparts F, G, and H of this part until not later than April 22, 1997 if the owner or operator certifies, in a notification to the appropriate EPA Regional Office, not later than May 14, 1996, that the plant site at which the chemical manufacturing processing unit is located emits, and will continue to emit, during any 12-month period, less than 10 tons per year of any individual hazardous air pollutants (HAP), and less than 25 tons per year of any combination of HAP.

(i) If such a determination is based on limitations and conditions that are not federally enforceable (as defined in subpart A of this part), the owner or operator shall document the basis for the determination as specified in paragraphs (b)(4)(i)(A) through (b)(4)(i)(C) and comply with the recordkeeping requirement in 63.103(f).

(A) The owner or operator shall identify all HAP emission points at the plant site, including those emission points subject to and emission points not subject to subparts F, G, and H;

(B) The owner or operator shall calculate the amount of annual HAP emissions released from each emission point at the plant site, using acceptable measurement or estimating techniques for maximum expected operating conditions at the plant site. Examples of estimating procedures that are considered acceptable include the calculation procedures in §63.150 of subpart G, the early reduction demonstration procedures specified in §§63.74 (c)(2), (c)(3), (d)(2), (d)(3), and (g), or accepted engineering practices. If the total annual HAP emissions for the plant site are annually reported under Emergency Planning and Community Right-to-Know Act (EPCRA) section 313, then such reported annual emissions may be used to satisfy the requirements of §63.100(b)(4)(i)(B).

(C) The owner or operator shall sum the amount of annual HAP emissions from all emission points on the plant site. If the total emissions of any one HAP are less than 10 tons per year and the total emissions of any combination of HAP are less than 25 tons per year, the plant site qualifies for the exemption described in paragraph (b)(4) of this section, provided that emissions are kept below these thresholds.

(ii) If such a determination is based on limitations and conditions that are federally enforceable (as defined in subpart A of this part), the owner or operator is not subject to the provisions of paragraph (b)(4) of this section.

(c) The owner or operator of a chemical manufacturing process unit that meets the criteria specified in paragraphs (b)(1) and (b)(3) of this section but does not use as a reactant or manufacture as a product or co-product, any organic hazardous air pollutant listed in table 2 of this subpart shall comply only with the requirements of §63.103(e) of this subpart. To comply with this subpart, such chemical manufacturing process units shall not be required to comply with the provisions of subpart A of this part.

(d) The primary product of a chemical manufacturing process unit shall be determined according to the procedures specified in paragraphs (d)(1), (d)(2), (d)(3), and (d)(4) of this section.

(1) If a chemical manufacturing process unit produces more than one intended chemical product, the product with the greatest annual design capacity on a mass basis determines the primary product of the process.

(2) If a chemical manufacturing process unit has two or more products that have the same maximum annual design capacity on a mass basis and if one of those chemicals is listed in table 1 of this subpart, then the listed chemical is considered the primary product and the chemical manufacturing process unit is subject to this subpart. If more than one of the products is listed in table 1 of this subpart, then the owner or operator may designate as the primary product any of the listed chemicals and the chemical manufacturing process unit is subject to this subpart.

(3) For chemical manufacturing process units that are designed and operated as flexible operation units producing one or more chemicals listed in table 1 of this subpart, the primary product shall be determined for existing sources based on the expected utilization for the five years following April 22, 1994 and for new sources based on the expected utilization for the first five years after initial start-up.

(i) If the predominant use of the flexible operation unit, as described in paragraphs (d)(3)(i)(A) and (d)(3)(i)(B) of this section, is to produce one or more chemicals listed in table 1 of this subpart, then the flexible operation unit shall be subject to the provisions of subparts F, G, and H of this part.

(A) If the flexible operation unit produces one product for the greatest annual operating time, then that product shall represent the primary product of the flexible operation unit.

(B) If the flexible operation unit produces multiple chemicals equally based on operating time, then the product with the greatest annual production on a mass basis shall represent the primary product of the flexible operation unit.

(ii) The determination of applicability of this subpart to chemical manufacturing process units that are designed and operated as flexible operation units shall be reported as part of an operating permit application or as otherwise specified by the permitting authority.

(4) Notwithstanding the provisions of paragraph (d)(3) of this section, for chemical manufacturing process units that are designed and operated as flexible operation units producing a chemical listed in paragraph (b)(1)(ii) of this section, the primary product shall be determined for existing sources based on the expected utilization for the five years following May 12, 1998 and for new sources based on the expected utilization for the first five years after initial start-up.

(i) The predominant use of the flexible operation unit shall be determined according to paragraphs (d)(3)(i)(A) and (d)(3)(i)(B) of this section. If the predominant use is to produce one of the chemicals listed in paragraph (b)(1)(ii) of this section, then the flexible operation unit shall be subject to the provisions of this subpart and subparts G and H of this part.

(ii) The determination of applicability of this subpart to chemical manufacturing process units that are designed and operated as flexible operation units shall be reported as part of an operating permit application or as otherwise specified by the permitting authority.

(e) The source to which this subpart applies is the collection of all chemical manufacturing process units and the associated equipment at a major source that meet the criteria specified in paragraphs (b)(1) through (3) of this section. The source includes the process vents; storage vessels; transfer racks; waste management units; maintenance wastewater; heat exchange systems; equipment identified in §63.149; and pumps, compressors, agitators, pressure relief devices, sampling connection systems, open-ended valves or lines, valves, connectors, instrumentation systems, surge control vessels, and bottoms receivers that are associated with that collection of chemical manufacturing process units. The source also includes equipment required by, or utilized as a method of compliance with, subparts F, G, or H of this part which may include control devices and recovery devices.

(1) This subpart applies to maintenance wastewater and heat exchange systems within a source that is subject to this subpart.

(2) This subpart F and subpart G of this part apply to process vents, storage vessels, transfer racks, equipment identified in §63.149 of subpart G of this part, and wastewater streams and associated treatment residuals within a source that is subject to this subpart.

(3) This subpart F and subpart H of this part apply to pumps, compressors, agitators, pressure relief devices, sampling connection systems, open-ended valves or lines, valves, connectors, instrumentation systems, surge control vessels, and bottoms receivers within a source that is subject to this subpart. If specific items of equipment, comprising part of a chemical manufacturing process unit subject to this subpart, are managed by different administrative organizations (e.g., different companies, affiliates, departments, divisions, etc.), those items of equipment may be aggregated with any chemical manufacturing process unit within the source for all purposes under subpart H of this part, providing there is no delay in the applicable compliance date in §63.100(k).

(f) The source includes the emission points listed in paragraphs (f)(1) through (f)(11) of this section, but those emission points are not subject to the requirements of this subpart F and subparts G and H of this

part. This subpart does not require emission points that are listed in paragraphs (f)(1) through (f)(11) of this section to comply with the provisions of subpart A of this part.

(1) Equipment that is located within a chemical manufacturing process unit that is subject to this subpart but the equipment does not contain organic hazardous air pollutants.

(2) Stormwater from segregated sewers;

(3) Water from fire-fighting and deluge systems in segregated sewers;

(4) Spills;

(5) Water from safety showers;

(6) Water from testing of deluge systems;

(7) Water from testing of firefighting systems;

(8) Vessels storing organic liquids that contain organic hazardous air pollutants only as impurities;

(9) Loading racks, loading arms, or loading hoses that only transfer liquids containing organic hazardous air pollutants as impurities;

(10) Loading racks, loading arms, or loading hoses that vapor balance during all loading operations; and

(11) Equipment that is intended to operate in organic hazardous air pollutant service, as defined in §63.161 of subpart H of this part, for less than 300 hours during the calendar year.

(g) The owner or operator shall follow the procedures specified in paragraphs (g)(1) through (g)(4) of this section to determine whether a storage vessel is part of the source to which this subpart applies.

(1) Where a storage vessel is dedicated to a chemical manufacturing process unit, the storage vessel shall be considered part of that chemical manufacturing process unit.

(i) If the chemical manufacturing process unit is subject to this subpart according to the criteria specified in paragraph (b) of this section, then the storage vessel is part of the source to which this subpart applies.

(ii) If the chemical manufacturing process unit is not subject to this subpart according to the criteria specified in paragraph (b) of this section, then the storage vessel is not part of the source to which this subpart applies.

(2) If a storage vessel is not dedicated to a single chemical manufacturing process unit, then the applicability of this subpart F and subpart G of this part shall be determined according to the provisions in paragraphs (g)(2)(i) through (g)(2)(iii) of this section.

(i) If a storage vessel is shared among chemical manufacturing process units and one of the process units has the predominant use, as determined by paragraph (g)(2)(i)(A) and (g)(2)(i)(B) of this section, then the storage vessel is part of that chemical manufacturing process unit.

(A) If the greatest input into the storage vessel is from a chemical manufacturing process unit that is located on the same plant site, then that chemical manufacturing process unit has the predominant use.

(B) If the greatest input into the storage vessel is provided from a chemical manufacturing process unit that is not located on the same plant site, then the predominant use is the chemical manufacturing process unit on the same plant site that receives the greatest amount of material from the storage vessel.

(ii) If a storage vessel is shared among chemical manufacturing process units so that there is no single predominant use, and at least one of those chemical manufacturing process units is subject to this subpart, the storage vessel shall be considered to be part of the chemical manufacturing process unit that is subject to this subpart. If more than one chemical manufacturing process unit is subject to this subpart, the owner or operator may assign the storage vessel to any of the chemical manufacturing process units subject to this subpart.

(iii) If the predominant use of a storage vessel varies from year to year, then the applicability of this subpart shall be determined according to the criteria in paragraphs (g)(2)(iii)(A) and (g)(2)(iii)(B) of this section, as applicable. This determination shall be reported as part of an operating permit application or as otherwise specified by the permitting authority.

(A) For chemical manufacturing process units that produce one or more of the chemicals listed in table 1 of this subpart and meet the criteria in paragraphs (b)(2) and (b)(3) of this section, the applicability shall be based on the utilization that occurred during the 12-month period preceding April 22, 1994.

(B) For chemical manufacturing process units that produce one or more of the chemicals listed in paragraph (b)(1)(ii) of this section and meet the criteria in paragraphs (b)(2) and (b)(3) of this section, the applicability shall be based on the utilization that occurred during the 12-month period preceding May 12, 1998.

(iv) If there is a change in the material stored in the storage vessel, the owner or operator shall reevaluate the applicability of this subpart to the vessel.

(3) Where a storage vessel is located at a major source that includes one or more chemical manufacturing process units which place material into, or receive materials from the storage vessel, but the storage vessel is located in a tank farm (including a marine tank farm), the applicability of this subpart F and subpart G of this part shall be determined according to the provisions in paragraphs (g)(3)(i) through (g)(3)(iv) of this section.

(i) The storage vessel may only be assigned to a chemical manufacturing process unit that utilizes the storage vessel and does not have an intervening storage vessel for that product (or raw material, as appropriate). With respect to any chemical manufacturing process unit, an intervening storage vessel means a storage vessel connected by hard-piping to the chemical manufacturing process unit and to the storage vessel in the tank farm so that product or raw material entering or leaving the chemical manufacturing process unit flows into (or from) the intervening storage vessel and does not flow directly into (or from) the storage vessel in the tank farm.

(ii) If there is no chemical manufacturing process unit at the major source that meets the criteria of paragraph (g)(3)(i) of this section with respect to a storage vessel, this subpart F and subpart G of this part do not apply to the storage vessel.

(iii) If there is only one chemical manufacturing process unit at the major source that meets the criteria of paragraph (g)(3)(i) of this section with respect to a storage vessel, the storage vessel shall be assigned to that chemical manufacturing process unit. Applicability of this subpart F and subpart G to this part to the storage vessel shall then be determined according to the provisions of paragraph (b) of this section.

(iv) If there are two or more chemical manufacturing process units at the major source that meet the criteria of paragraph (g)(3)(i) of this section with respect to a storage vessel, the storage vessel shall be assigned to one of those chemical manufacturing process units according to the provisions of paragraph (g)(2) of this section. The predominant use shall be determined among only those chemical manufacturing process units that meet the criteria of paragraph (g)(3)(i) of this section. Applicability of this subpart F and subpart G of this part to the storage vessel shall then be determined according to the provisions of paragraph (b) of this section.

(4) If the storage vessel begins receiving material from (or sending material to) another chemical manufacturing process unit, or ceases to receive material from (or send material to) a chemical manufacturing process unit, or if the applicability of this subpart F and subpart G of this part to a storage vessel has been determined according to the provisions of paragraphs (g)(2)(i) and (g)(2)(ii) of this section and there is a change so that the predominant use may reasonably have changed, the owner or operator shall reevaluate the applicability of this subpart to the storage vessel.

(h) The owner or operator shall follow the procedures specified in paragraphs (h)(1) and (h)(2) of this section to determine whether the arms and hoses in a loading rack are part of the source to which this subpart applies.

(1) Where a loading rack is dedicated to a chemical manufacturing process unit, the loading rack shall be considered part of that specific chemical manufacturing process unit.

(i) If the chemical manufacturing process unit is subject to this subpart according to the criteria specified in paragraph (b) of this section and the loading rack does not meet the criteria specified in paragraphs (f)(9) and (f)(10) of this section, then the loading rack is considered a transfer rack (as defined in §63.101 of this subpart) and is part of the source to which this subpart applies.

(ii) If the chemical manufacturing process unit is not subject to this subpart according to the criteria specified in paragraph (b) of this section, then the loading rack is not considered a transfer rack (as defined in §63.101 of this subpart) and is not a part of the source to which this subpart applies.

(2) If a loading rack is shared among chemical manufacturing process units, then the applicability of this subpart F and subpart G of this part shall be determined at each loading arm or loading hose according to the provisions in paragraphs (h)(2)(i) through (h)(2)(iv) of this section.

(i) Each loading arm or loading hose that is dedicated to the transfer of liquid organic hazardous air pollutants listed in table 2 of this subpart from a chemical manufacturing process unit to which this subpart applies is part of that chemical manufacturing process unit and is part of the source to which this

subpart applies unless the loading arm or loading hose meets the criteria specified in paragraphs (f)(9) or (f)(10) of this section.

(ii) If a loading arm or loading hose is shared among chemical manufacturing process units, and one of the chemical manufacturing process units provides the greatest amount of the material that is loaded by the loading arm or loading hose, then the loading arm or loading hose is part of that chemical manufacturing process unit.

(A) If the chemical manufacturing process unit is subject to this subpart according to the criteria specified in paragraph (b) of this section, then the loading arm or loading hose is part of the source to which this subpart applies unless the loading arm or loading hose meets the criteria specified in paragraphs (f)(9) or (f)(10) of this section.

(B) If the chemical manufacturing process unit is not subject to this subpart according to the criteria specified in paragraph (b) of this section, then the loading arm or loading hose is not part of the source to which this subpart applies.

(iii) If a loading arm or loading hose is shared among chemical manufacturing process units so that there is no single predominant use as described in paragraph (h)(2)(ii) of this section and at least one of those chemical manufacturing process units is subject to this subpart, then the loading arm or hose is part of the chemical manufacturing process unit that is subject to this subpart. If more than one of the chemical manufacturing process units is subject to this subpart, the owner or operator may assign the loading arm or loading hose to any of the chemical manufacturing process units subject to this subpart.

(iv) If the predominant use of a loading arm or loading hose varies from year to year, then the applicability of this subpart shall be determined according to the criteria in paragraphs (h)(2)(iv)(A) and (h)(2)(iv)(B) of this section, as applicable. This determination shall be reported as part of an operating permit application or as otherwise specified by the permitting authority.

(A) For chemical manufacturing process units that produce one or more of the chemicals listed in table 1 of this subpart and meet the criteria in paragraphs (b)(2) and (b)(3) of this section, the applicability shall be based on the utilization that occurred during the 12-month period preceding April 22, 1994.

(B) For chemical manufacturing process units that produce one or more of the chemicals listed in paragraph (b)(1)(ii) of this section and meet the criteria in paragraphs (b)(2) and (b)(3) of this section, the applicability shall be based on the utilization that occurred during the year preceding May 12, 1998.

(3) If a loading rack that was dedicated to a single chemical manufacturing process unit begins to serve another chemical manufacturing process unit, or if applicability was determined under the provisions of paragraphs (h)(2)(i) through (h)(2)(iii) of this section and there is a change so that the predominant use may reasonably have changed, the owner or operator shall reevaluate the applicability of this subpart to the loading rack, loading arm, or loading hose.

(i) Except as provided in paragraph (i)(4) of this section, the owner or operator shall follow the procedures specified in paragraphs (i)(1) through (i)(3) and (i)(5) of this section to determine whether the vent(s) from a distillation unit is part of the source to which this subpart applies.



(1) Where a distillation unit is dedicated to a chemical manufacturing process unit, the distillation column shall be considered part of that chemical manufacturing process unit.

(i) If the chemical manufacturing process unit is subject to this subpart according to the criteria specified in paragraph (b) of this section, then the distillation unit is part of the source to which this subpart applies.

(ii) If the chemical manufacturing process unit is not subject to this subpart according to the criteria specified in paragraph (b) of this section, then the distillation unit is not part of the source to which this subpart applies.

(2) If a distillation unit is not dedicated to a single chemical manufacturing process unit, then the applicability of this subpart and subpart G of this part shall be determined according to the provisions in paragraphs (i)(2)(i) through (i)(2)(iv) of this section.

(i) If the greatest input to the distillation unit is from a chemical manufacturing process unit located on the same plant site, then the distillation unit shall be assigned to that chemical manufacturing process unit.

(ii) If the greatest input to the distillation unit is provided from a chemical manufacturing process unit that is not located on the same plant site, then the distillation unit shall be assigned to the chemical manufacturing process unit located at the same plant site that receives the greatest amount of material from the distillation unit.

(iii) If a distillation unit is shared among chemical manufacturing process units so that there is no single predominant use as described in paragraphs (i)(2)(i) and (i)(2)(ii) of this section, and at least one of those chemical manufacturing process units is subject to this subpart, the distillation unit shall be assigned to the chemical manufacturing process unit that is subject to this subpart. If more than one chemical manufacturing process unit is subject to this subpart, the owner or operator may assign the distillation unit to any of the chemical manufacturing process units subject to this subpart.

(iv) If the predominant use of a distillation unit varies from year to year, then the applicability of this subpart shall be determined according to the criteria in paragraphs (i)(2)(iv)(A) and (i)(2)(iv)(B), as applicable. This determination shall be included as part of an operating permit application or as otherwise specified by the permitting authority.

(A) For chemical manufacturing process units that produce one or more of the chemicals listed in table 1 of this subpart and meet the criteria in paragraphs (b)(2) and (b)(3) of this section, the applicability shall be based on the utilization that occurred during the year preceding April 22, 1994.

(B) For chemical manufacturing process units that produce one or more of the chemicals listed in paragraph (b)(1)(ii) of this section and meet the criteria in paragraphs (b)(2) and (b)(3) of this section, the applicability shall be based on the utilization that occurred during the year preceding May 12, 1998.

(3) If the chemical manufacturing process unit to which the distillation unit is assigned is subject to this subpart, then each vent from the individual distillation unit shall be considered separately to determine whether it is a process vent (as defined in §63.101 of this subpart). Each vent that is a process vent is part of the source to which this subpart applies.

(4) If the distillation unit is part of one of the chemical manufacturing process units listed in paragraphs (i)(4)(i) through (i)(4)(iii) of this section, then each vent from the individual distillation unit shall be considered separately to determine whether it is a process vent (as defined in §63.101 of this subpart). Each vent that is a process vent is part of the source to which this subpart applies:

(i) The Aromex unit that produces benzene, toluene, and xylene;

(ii) The unit that produces hexane; or

(iii) The unit that produces cyclohexane.

(5) If a distillation unit that was dedicated to a single chemical manufacturing process unit, or that was part of a chemical manufacturing unit identified in paragraphs (i)(4)(i) through (i)(4)(iii) of this section, begins to serve another chemical manufacturing process unit, or if applicability was determined under the provisions of paragraphs (i)(2)(i) through (i)(2)(iii) of this section and there is a change so that the predominant use may reasonably have changed, the owner or operator shall reevaluate the applicability of this subpart to the distillation unit.

(j) The provisions of subparts F, G, and H of this part do not apply to the processes specified in paragraphs (j)(1) through (j)(6) of this section. Subparts F, G, and H do not require processes specified in paragraphs (j)(1) through (j)(6) to comply with the provisions of subpart A of this part.

(1) Research and development facilities, regardless of whether the facilities are located at the same plant site as a chemical manufacturing process unit that is subject to the provisions of subparts F, G, or H of this part.

(2) Petroleum refining process units, regardless of whether the units supply feedstocks that include chemicals listed in table 1 of this subpart to chemical manufacturing process units that are subject to the provisions of subparts F, G, or H of this part.

(3) Ethylene process units, regardless of whether the units supply feedstocks that include chemicals listed in table 1 of this subpart to chemical manufacturing process units that are subject to the provisions of subpart F, G, or H of this part.

(4) Batch process vents within a chemical manufacturing process unit.

(5) Chemical manufacturing process units that are located in coke by-product recovery plants.

(6) Solvent reclamation, recovery, or recycling operations at hazardous waste TSDF facilities requiring a permit under 40 CFR part 270 that are separate entities and not part of a SOCFI chemical manufacturing process unit.

(k) Except as provided in paragraphs (l), (m), and (p) of this section, sources subject to subparts F, G, or H of this part are required to achieve compliance on or before the dates specified in paragraphs (k)(1) through (k)(8) of this section.

(1)(i) New sources that commence construction or reconstruction after December 31, 1992, but before August 27, 1996 shall be in compliance with this subpart F, subparts G and H of this part upon initial

start-up or by April 22, 1994, whichever is later, as provided in §63.6(b) of subpart A of this part, and further, where start-up occurs before January 17, 1997 shall also be in compliance with this subpart F and subparts G and H of this part (as amended on January 17, 1997) by January 17, 1997, except that, with respect to all new sources that commenced construction or reconstruction after December 31, 1992, and before August 27, 1996:

(A) Heat exchange systems and maintenance wastewater, that are part of a new source on which construction or reconstruction commenced after December 31, 1992, but before August 27, 1996, shall be in compliance with this subpart F no later than initial start-up or 180 days after January 17, 1997, whichever is later;

(B) Process wastewater streams and equipment subject to §63.149, that are part of a new source on which construction or reconstruction commenced after December 31, 1992, but before August 27, 1996, shall be in compliance with this subpart F and subpart G of this part no later than initial start-up or 180 days after January 17, 1997, whichever is later; and

(ii) New sources that commence construction after August 26, 1996 shall be in compliance with this subpart F, subparts G and H of this part upon initial start-up or by January 17, 1997, whichever is later.

(2) Existing sources shall be in compliance with this subpart F and subpart G of this part no later than the dates specified in paragraphs (k)(2)(i) and (k)(2)(ii) of this section, unless an extension has been granted by the Administrator as provided in §63.151(a)(6) of subpart G of this part or granted by the permitting authority as provided in §63.6(i) of subpart A of this part.

(i) Process vents, storage vessels, and transfer racks at an existing source shall be in compliance with the applicable sections of this subpart and subpart G of this part no later than April 22, 1997.

(ii) Heat exchange systems and maintenance wastewater shall be in compliance with the applicable sections of this subpart, and equipment subject to §63.149 and process wastewater streams shall be in compliance with the applicable sections of this subpart and subpart G of this part no later than April 22, 1999, except as provided in paragraphs (k)(2)(ii)(A) and (k)(2)(ii)(B) of this section.

(A) If a process wastewater stream or equipment subject to §63.149 is subject to the control requirements of subpart G of this part due to the contribution of nitrobenzene to the total annual average concentration (as determined according to the procedures in §63.144(b) of subpart G of this part), the wastewater stream shall be in compliance no later than January 18, 2000.

(B) If a process wastewater stream is used to generate credits in an emissions average in accordance with §63.150 of subpart G of this part, the process wastewater stream shall be in compliance with the applicable sections of subpart G of this part no later than April 22, 1997.

(3) Existing sources shall be in compliance with subpart H of this part no later than the dates specified in paragraphs (k)(3)(i) through (k)(3)(v) of this section, except as provided for in paragraphs (k)(4) through (k)(8) of this section, unless an extension has been granted by the Administrator as provided in §63.182(a)(6) of this part or granted by the permitting authority as provided in §63.6(i) of subpart A of this part. The group designation for each process unit is indicated in table 1 of this subpart.

(i) Group I: October 24, 1994.

(ii) Group II: January 23, 1995.

(iii) Group III: April 24, 1995.

(iv) Group IV: July 24, 1995.

(v) Group V: October 23, 1995.

(4) Existing chemical manufacturing process units in Groups I and II as identified in table 1 of this subpart shall be in compliance with the requirements of §63.164 of subpart H no later than May 10, 1995, for any compressor meeting one or more of the criteria in paragraphs (k)(4)(i) through (k)(4)(iv) of this section, if the work can be accomplished without a process unit shutdown, as defined in §63.161 in subpart H.

(i) The seal system will be replaced;

(ii) A barrier fluid system will be installed;

(iii) A new barrier fluid will be utilized which requires changes to the existing barrier fluid system; or

(iv) The compressor must be modified to permit connecting the compressor to a closed vent system.

(5) Existing chemical manufacturing process units shall be in compliance with the requirements of §63.164 in subpart H no later than 1 year after the applicable compliance date specified in paragraph (k)(3) of this section, for any compressor meeting the criteria in paragraphs (k)(5)(i) through (k)(5)(iv) of this section.

(i) The compressor meets one or more of the criteria specified in paragraphs (k)(4) (i) through (iv) of this section;

(ii) The work can be accomplished without a process unit shutdown as defined in §63.161 of subpart H;

(iii) The additional time is actually necessary due to the unavailability of parts beyond the control of the owner or operator; and

(iv) The owner or operator submits a request to the appropriate EPA Regional Office at the addresses listed in §63.13 of subpart A of this part no later than 45 days before the applicable compliance date in paragraph (k)(3) of this section, but in no event earlier than May 10, 1995. The request shall include the information specified in paragraphs (k)(5)(iv)(A) through (k)(5)(iv)(E) of this section. Unless the EPA Regional Office objects to the request within 30 days after receipt, the request shall be deemed approved.

(A) The name and address of the owner or operator and the address of the existing source if it differs from the address of the owner or operator;

(B) The name, address, and telephone number of a contact person for further information;

(C) An identification of the chemical manufacturing process unit, and of the specific equipment for which additional compliance time is required;

(D) The reason compliance can not reasonably be achieved by the applicable date specified in paragraphs (k)(3)(i) through (k)(3)(v) of this section; and

(E) The date by which the owner or operator expects to achieve compliance.

(6)(i) If compliance with the compressor provisions of §63.164 of subpart H of this part can not reasonably be achieved without a process unit shutdown, as defined in §63.161 of subpart H, the owner or operator shall achieve compliance no later than April 22, 1996, except as provided for in paragraph (k)(6)(ii) of this section. The owner or operator who elects to use this provision shall comply with the requirements of §63.103(g) of this subpart.

(ii) If compliance with the compressor provisions of §63.164 of subpart H of this part can not be achieved without replacing the compressor or recasting the distance piece, the owner or operator shall achieve compliance no later than April 22, 1997. The owner or operator who elects to use this provision shall also comply with the requirements of §63.103(g) of this subpart.

(7) Existing sources shall be in compliance with the provisions of §63.170 of subpart H no later than April 22, 1997.

(8) If an owner or operator of a chemical manufacturing process unit subject to the provisions of subparts F, G, and H of part 63 plans to implement pollution prevention measures to eliminate the use or production of HAP listed in table 2 of this subpart by October 23, 1995, the provisions of subpart H do not apply regardless of the compliance dates specified in paragraph (k)(3) of this section. The owner or operator who elects to use this provision shall comply with the requirements of §63.103(h) of this subpart.

(9) All terms in this subpart F or subpart G of this part that define a period of time for completion of required tasks (e.g., weekly, monthly, quarterly, annual), unless specified otherwise in the section or subsection that imposes the requirement, refer to the standard calendar periods.

(i) Notwithstanding time periods specified in this subpart F or subpart G of this part for completion of required tasks, such time periods may be changed by mutual agreement between the owner or operator and the Administrator, as specified in subpart A of this part (e.g., a period could begin on the compliance date or another date, rather than on the first day of the standard calendar period). For each time period that is changed by agreement, the revised period shall remain in effect until it is changed. A new request is not necessary for each recurring period.

(ii) Where the period specified for compliance is a standard calendar period, if the initial compliance date occurs after the beginning of the period, compliance shall be required according to the schedule specified in paragraphs (k)(9)(ii)(A) or (k)(9)(ii)(B) of this section, as appropriate.

(A) Compliance shall be required before the end of the standard calendar period within which the compliance deadline occurs, if there remain at least 3 days for tasks that must be performed weekly, at least 2 weeks for tasks that must be performed monthly, at least 1 month for tasks that must be performed each quarter, or at least 3 months for tasks that must be performed annually; or

(B) In all other cases, compliance shall be required before the end of the first full standard calendar period after the period within which the initial compliance deadline occurs.

(iii) In all instances where a provision of this subpart F or subpart G of this part requires completion of a task during each of multiple successive periods, an owner or operator may perform the required task at any time during the specified period, provided the task is conducted at a reasonable interval after completion of the task during the previous period.

(1)(1) If an additional chemical manufacturing process unit meeting the criteria specified in paragraph (b) of this section is added to a plant site that is a major source as defined in section 112(a) of the Act, the addition shall be subject to the requirements for a new source in subparts F, G, and H of this part if:

(i) It is an addition that meets the definition of construction in §63.2 of subpart A of this part;

(ii)(A) Such construction commenced after December 31, 1992 for chemical manufacturing process units that produce as a primary product one or more of the chemicals listed in table 1 of this subpart;

(B) Such construction commenced after August 22, 1997 for chemical manufacturing process units that produce as a primary product one or more of the chemicals listed in paragraph (b)(1)(ii) of this section; and

(iii) The addition has the potential to emit 10 tons per year or more of any HAP or 25 tons per year or more of any combination of HAP's, unless the Administrator establishes a lesser quantity.

(2) If any change is made to a chemical manufacturing process unit subject to this subpart, the change shall be subject to the requirements of a new source in subparts F, G, and H of this part if:

(i) It is a change that meets the definition of reconstruction in §63.2 of subpart A of this part; and

(ii)(A) Such reconstruction commenced after December 31, 1992 for chemical manufacturing process units that produce as a primary product one or more of the chemicals listed in table 1 of this subpart; and

(B) Such construction commenced after August 22, 1997 for chemical manufacturing process units that produce as a primary product one or more of the chemicals listed in paragraph (b)(1)(ii) of this section.

(3) If an additional chemical manufacturing process unit is added to a plant site or a change is made to a chemical manufacturing process unit and the addition or change is determined to be subject to the new source requirements according to paragraph (1)(1) or (1)(2) of this section:

(i) The new or reconstructed source shall be in compliance with the new source requirements of subparts F, G, and H of this part upon initial start-up of the new or reconstructed source or by April 22, 1994, whichever is later; and

(ii) The owner or operator of the new or reconstructed source shall comply with the reporting and recordkeeping requirements in subparts F, G, and H of this part that are applicable to new sources. The applicable reports include, but are not limited to:

- (A) The application for approval of construction or reconstruction which shall be submitted by the date specified in §63.151(b)(2)(ii) of subpart G of this part, or an Initial Notification as specified in §63.151(b)(2)(iii) of subpart G of this part;
- (B) Changes that meet the criteria in §63.151(j) of subpart G of this part, unless the information has been submitted in an operating permit application or amendment;
- (C) The Notification of Compliance Status as required by §63.152(b) of subpart G of this part for the new or reconstructed source;
- (D) Periodic Reports and Other Reports as required by §63.152(c) and (d) of subpart G of this part;
- (E) Reports required by §63.182 of subpart H of this part; and
- (F) Reports and notifications required by sections of subpart A of this part that are applicable to subparts F, G, and H of this part, as identified in table 3 of this subpart.
- (4) If an additional chemical manufacturing process unit is added to a plant site, or if an emission point is added to an existing chemical manufacturing process unit, or if another deliberate operational process change creating an additional Group 1 emission point(s) is made to an existing chemical manufacturing process unit, or if a surge control vessel or bottoms receiver becomes subject to §63.170 of subpart H, or if a compressor becomes subject to §63.164 of subpart H, and if the addition or change is not subject to the new source requirements as determined according to paragraph (l)(1) or (l)(2) of this section, the requirements in paragraphs (l)(4)(i) through (l)(4)(iii) of this section shall apply. Examples of process changes include, but are not limited to, changes in production capacity, feedstock type, or catalyst type, or whenever there is replacement, removal, or addition of recovery equipment. For purposes of this paragraph and paragraph (m) of this section, process changes do not include: Process upsets, unintentional temporary process changes, and changes that are within the equipment configuration and operating conditions documented in the Notification of Compliance Status required by §63.152(b) of subpart G of this part.
- (i) The added emission point(s) and any emission point(s) within the added or changed chemical manufacturing process unit are subject to the requirements of subparts F, G, and H of this part for an existing source;
- (ii) The added emission point(s) and any emission point(s) within the added or changed chemical manufacturing process unit shall be in compliance with subparts F, G, and H of this part by the dates specified in paragraph (l)(4)(ii) (A) or (B) of this section, as applicable.
- (A) If a chemical manufacturing process unit is added to a plant site or an emission point(s) is added to an existing chemical manufacturing process unit, the added emission point(s) shall be in compliance upon initial start-up of the added chemical manufacturing process unit or emission point(s) or by 3 years after April 22, 1994, whichever is later.
- (B) If a deliberate operational process change to an existing chemical manufacturing process unit causes a Group 2 emission point to become a Group 1 emission point, if a surge control vessel or bottoms receiver becomes subject to §63.170 of subpart H, or if a compressor becomes subject to §63.164 of subpart H, the

owner or operator shall be in compliance upon initial start-up or by 3 years after April 22, 1994, whichever is later, unless the owner or operator demonstrates to the Administrator that achieving compliance will take longer than making the change. If this demonstration is made to the Administrator's satisfaction, the owner or operator shall follow the procedures in paragraphs (m)(1) through (m)(3) of this section to establish a compliance date.

(iii) The owner or operator of a chemical manufacturing process unit or emission point that is added to a plant site and is subject to the requirements for existing sources shall comply with the reporting and recordkeeping requirements of subparts F, G, and H of this part that are applicable to existing sources, including, but not limited to, the reports listed in paragraphs (l)(4)(iii) (A) through (E) of this section. A change to an existing chemical manufacturing process unit shall be subject to the reporting requirements for existing sources, including but not limited to, the reports listed in paragraphs (l)(4)(iii)(A) through (E) of this section if the change meets the criteria specified in §63.118(g), (h), (i), or (j) of subpart G of this part for process vents or the criteria in §63.155(i) or (j) of subpart G of this part. The applicable reports include, but are not limited to:

(A) Reports specified in §63.151(i) and (j) of subpart G of this part, unless the information has been submitted in an operating permit application or amendment;

(B) The Notification of Compliance Status as required by §63.152(b) of subpart G of this part for the emission points that were added or changed;

(C) Periodic Reports and other reports as required by §63.152 (c) and (d) of subpart G of this part;

(D) Reports required by §63.182 of subpart H of this part; and

(E) Reports and notifications required by sections of subpart A of this part that are applicable to subparts F, G, and H of this part, as identified in table 3 of this subpart.

(m) If a change that does not meet the criteria in paragraph (l)(4) of this section is made to a chemical manufacturing process unit subject to subparts F and G of this part, and the change causes a Group 2 emission point to become a Group 1 emission point (as defined in §63.111 of subpart G of this part), then the owner or operator shall comply with the requirements of subpart G of this part for the Group 1 emission point as expeditiously as practicable, but in no event later than 3 years after the emission point becomes Group 1.

(1) The owner or operator shall submit to the Administrator for approval a compliance schedule, along with a justification for the schedule.

(2) The compliance schedule shall be submitted with the report required in §63.151(i)(2) of subpart G of this part for emission points included in an emissions average or §63.151(j)(1) or subpart G of this part for emission points not in an emissions average, unless the compliance schedule has been submitted in an operating permit application or amendment.

(3) The Administrator shall approve the compliance schedule or request changes within 120 calendar days of receipt of the compliance schedule and justification.



(n) *Rules stayed for reconsideration.* Notwithstanding any other provision of this subpart, the effectiveness of subpart F is stayed from October 24, 1994, to April 24, 1995, only as applied to those sources for which the owner or operator makes a representation in writing to the Administrator that the resolution of the area source definition issues could have an effect on the compliance status of the source with respect to subpart F.

(o) *Sections stayed for reconsideration.* Notwithstanding any other provision of this subpart, the effectiveness of §§63.164 and 63.170 of subpart H is stayed from October 28, 1994, to April 24, 1995, only as applied to those sources subject to §63.100(k)(3) (i) and (ii).

(p) *Compliance dates for chemical manufacturing process units that produce crotonaldehyde or tetrahydrobenzaldehyde.* Notwithstanding the provisions of paragraph (k) of this section, chemical manufacturing process units that meet the criteria in paragraphs (b)(1)(ii), (b)(2), and (b)(3) of this section shall be in compliance with this subpart and subparts G and H of this part by the dates specified in paragraphs (p)(1) and (p)(2) of this section, as applicable.

(1) If the source consists only of chemical manufacturing process units that produce as a primary product one or more of the chemicals listed in paragraph (b)(1)(ii) of this section, new sources shall comply by the date specified in paragraph (p)(1)(i) of this section and existing sources shall comply by the dates specified in paragraphs (p)(1)(ii) and (p)(1)(iii) of this section.

(i) Upon initial start-up or May 12, 1998, whichever is later.

(ii) This subpart and subpart G of this part by May 14, 2001, unless an extension has been granted by the Administrator as provided in §63.151(a)(6) or granted by the permitting authority as provided in §63.6(i) of subpart A of this part. When April 22, 1994 is referred to in this subpart and subpart G of this part, May 12, 1998 shall be used as the applicable date for that provision. When December 31, 1992 is referred to in this subpart and subpart G of this part, August 22, 1997 shall be used as the applicable date for that provision.

(iii) Subpart H of this part by May 12, 1999, unless an extension has been granted by the Administrator as provided in §63.151(a)(6) or granted by the permitting authority as provided in §63.6(i) of subpart A of this part. When April 22, 1994 is referred to in subpart H of this part, May 12, 1998 shall be used as the applicable date for that provision. When December 31, 1992 is referred to in subpart H of this part, August 22, 1997 shall be used as the applicable date for that provision.

(2) If the source consists of a combination of chemical manufacturing process units that produce as a primary product one or more of the chemicals listed in paragraphs (b)(1)(i) and (b)(1)(ii) of this section, new chemical manufacturing process units that meet the criteria in paragraph (b)(1)(ii) of this section shall comply by the date specified in paragraph (p)(1)(i) of this section and existing chemical manufacturing process units producing crotonaldehyde and/or tetrahydrobenzaldehyde shall comply by the dates specified in paragraphs (p)(1)(ii) and (p)(1)(iii) of this section.

(q) If the owner or operator of a process vent, or of a gas stream transferred subject to §63.113(i), is unable to comply with the provisions of §§63.113 through 63.118 by the applicable compliance date specified in paragraph (k), (l), or (m) of this section for the reasons stated in paragraph (q)(1), (3), or (5) of this section, the owner or operator shall comply with the applicable provisions in §§63.113 through

63.118 as expeditiously as practicable, but in no event later than the date approved by the Administrator pursuant to paragraph (q)(2), (4), or (6) of this section, respectively. For requests under paragraph (q)(1) or (3) of this section, the date approved by the Administrator may be earlier than, and shall not be later than, the later of January 22, 2004 or 3 years after the transferee's refusal to accept the stream for disposal. For requests submitted under paragraph (q)(5) of this section, the date approved by the Administrator may be earlier than, and shall not be later than, 3 years after the date of publication of the amendments to this subpart or to subpart G of this part which created the need for an extension of the compliance.

(1) If the owner or operator has been sending a gas stream for disposal as described in §63.113(i) prior to January 22, 2001, and the transferee does not submit a written certification as described in §63.113(i)(2) and ceases to accept the gas stream for disposal, the owner or operator shall comply with paragraph (q)(2) of this section.

(2)(i) An owner or operator directed to comply with paragraph (q)(2) of this section shall submit to the Administrator for approval a compliance schedule, along with a justification for the schedule.

(ii) The compliance schedule and justification shall be submitted no later than 90 days after the transferee ceases to accept the gas stream for disposal.

(iii) The Administrator shall approve the compliance schedule or request changes within 120 days of receipt of the compliance schedule and justification.

(3) If the owner or operator has been sending the gas stream for disposal as described in §63.113(i) to a transferee who had submitted a written certification as described in §63.113(i)(2), and the transferee revokes its written certification, the owner or operator shall comply with paragraph (q)(4) of this section. During the period between the date when the owner or operator receives notice of revocation of the transferee's written certification and the compliance date established under paragraph (q)(4) of this section, the owner or operator shall implement, to the extent reasonably available, measures to prevent or minimize excess emissions to the extent practical. For purposes of this paragraph (q)(3), the term "excess emissions" means emissions in excess of those that would have occurred if the transferee had continued managing the gas stream in compliance with the requirements in §§63.113 through 63.118. The measures to be taken shall be identified in the applicable startup, shutdown, and malfunction plan. If the measures that can be reasonably taken will change over time, so that a more effective measure which could not reasonably be taken initially would be reasonable at a later date, the Administrator may require the more effective measure by a specified date (in addition to or instead of any other measures taken sooner or later than that date) as a condition of approval of the compliance schedule.

(4)(i) An owner or operator directed to comply with this paragraph (q)(4) shall submit to the Administrator for approval the documents specified in paragraphs (q)(4)(i)(A) through (E) of this section no later than 90 days after the owner or operator receives notice of revocation of the transferee's written certification.

(A) A request for determination of a compliance date.

(B) A justification for the request for determination of a compliance date.

(C) A compliance schedule.

(D) A justification for the compliance schedule.

(E) A description of the measures that will be taken to minimize excess emissions until the new compliance date, and the date when each measure will first be implemented. The owner or operator shall describe how, and to what extent, each measure will minimize excess emissions, and shall justify any period of time when measures are not in place.

(ii) The Administrator shall approve or disapprove the request for determination of a compliance date and the compliance schedule, or request changes, within 120 days after receipt of the documents specified in paragraphs (q)(4)(i)(A) through (E) of this section. Upon approving the request for determination and compliance schedule, the Administrator shall specify a reasonable compliance date consistent with the introductory text in paragraph (q) of this section.

(5) If the owner's or operator's inability to meet otherwise applicable compliance deadlines is due to amendments of this subpart or of subpart G of this part published on or after January 22, 2001 and neither condition specified in paragraph (q)(1) or (3) of this section is applicable, the owner or operator shall comply with paragraph (q)(6) of this section.

(6)(i) An owner or operator directed to comply with this paragraph (6)(i) shall submit to the Administrator for approval, a request for determination of a compliance date, a compliance schedule, a justification for the determination of a compliance date, and a justification for the compliance schedule.

(ii) The documents required to be submitted under paragraph (q)(6)(i) of this section shall be submitted no later than 120 days after publication of the amendments of this subpart or of subpart G of this part which necessitate the request for an extension.

(iii) The Administrator shall approve or disapprove the request for a determination of a compliance date, or request changes, within 120 days after receipt of the request for determination of a compliance date, the compliance schedule, and the two justifications. If the request for determination of a compliance date is disapproved, the compliance schedule is disapproved and the owner or operator shall comply by the applicable date specified in paragraph (k),(l), or (m) of this section. If the request for the determination of a compliance date is approved, the Administrator shall specify, at the time of approval, a reasonable compliance date consistent with the introductory text in paragraph (q) of this section.

[59 FR 19454, Apr. 22, 1994, as amended at 59 FR 53360, Oct. 24, 1994; 59 FR 54132, Oct. 28, 1994; 60 FR 5321, Jan. 27, 1995; 60 FR 18023, 18028, Apr. 10, 1995; 60 FR 63626, Dec. 12, 1995; 61 FR 7718, Feb. 29, 1996; 61 FR 64574, Dec. 5, 1996; 62 FR 2729, Jan. 17, 1997; 63 FR 26081, May 12, 1998; 64 FR 20191, Apr. 26, 1999; 66 FR 6927, Jan. 22, 2001]

[↑ Back to Top](#)

### **§63.101 Definitions.**

(a) The following terms as used in subparts F, G, and H of this part shall have the meaning given them in subpart A of this part: Act, actual emissions, Administrator, affected source, approved permit program,

commenced, compliance date, construction, continuous monitoring system, continuous parameter monitoring system, effective date, emission standard, emissions averaging, EPA, equivalent emission limitation, existing source, Federally enforceable, fixed capital cost, hazardous air pollutant, lesser quantity, major source, malfunction, new source, owner or operator, performance evaluation, performance test, permit program, permitting authority, reconstruction, relevant standard, responsible official, run, standard conditions, State, and stationary source.

(b) All other terms used in this subpart and subparts G and H of this part shall have the meaning given them in the Act and in this section. If the same term is defined in subpart A of this part and in this section, it shall have the meaning given in this section for purposes of subparts F, G, and H of this part.

*Air oxidation reactor* means a device or vessel in which air, or a combination of air and oxygen, is used as an oxygen source in combination with one or more organic reactants to produce one or more organic compounds. Air oxidation reactor includes the product separator and any associated vacuum pump or steam jet.

*Batch operation* means a noncontinuous operation in which a discrete quantity or batch of feed is charged into a unit operation within a chemical manufacturing process unit and processed at one time. Batch operation includes noncontinuous operations in which the equipment is fed intermittently or discontinuously. Addition of raw material and withdrawal of product do not occur simultaneously in a batch operation. After each batch operation, the equipment is generally emptied before a fresh batch is started.

*Batch process vent* means gaseous venting to the atmosphere from a batch operation.

*Bottoms receiver* means a tank that collects distillation bottoms before the stream is sent for storage or for further downstream processing.

*By-product* means a chemical that is produced coincidentally during the production of another chemical.

*Chemical manufacturing process unit* means the equipment assembled and connected by pipes or ducts to process raw materials and to manufacture an intended product. A chemical manufacturing process unit consists of more than one unit operation. For the purpose of this subpart, chemical manufacturing process unit includes air oxidation reactors and their associated product separators and recovery devices; reactors and their associated product separators and recovery devices; distillation units and their associated distillate receivers and recovery devices; associated unit operations; associated recovery devices; and any feed, intermediate and product storage vessels, product transfer racks, and connected ducts and piping. A chemical manufacturing process unit includes pumps, compressors, agitators, pressure relief devices, sampling connection systems, open-ended valves or lines, valves, connectors, instrumentation systems, and control devices or systems. A chemical manufacturing process unit is identified by its primary product.

*Control device* means any combustion device, recovery device, or recapture device. Such equipment includes, but is not limited to, absorbers, carbon adsorbers, condensers, incinerators, flares, boilers, and process heaters. For process vents (as defined in this section), recapture devices are considered control devices but recovery devices are not considered control devices. For a steam stripper, a primary condenser is not considered a control device.

*Co-product* means a chemical that is produced during the production of another chemical.

*Distillate receiver* means overhead receivers, overhead accumulators, reflux drums, and condenser(s) including ejector-condenser(s) associated with a distillation unit.

*Distillation unit* means a device or vessel in which one or more feed streams are separated into two or more exit streams, each exit stream having component concentrations different from those in the feed stream(s). The separation is achieved by the redistribution of the components between the liquid and the vapor phases by vaporization and condensation as they approach equilibrium within the distillation unit. Distillation unit includes the distillate receiver, reboiler, and any associated vacuum pump or steam jet.

*Emission point* means an individual process vent, storage vessel, transfer rack, wastewater stream, or equipment leak.

*Equipment leak* means emissions of organic hazardous air pollutants from a connector, pump, compressor, agitator, pressure relief device, sampling connection system, open-ended valve or line, valve, surge control vessel, bottoms receiver, or instrumentation system in organic hazardous air pollutant service as defined in §63.161.

*Ethylene process* or *ethylene process unit* means a chemical manufacturing process unit in which ethylene and/or propylene are produced by separation from petroleum refining process streams or by subjecting hydrocarbons to high temperatures in the presence of steam. The ethylene process unit includes the separation of ethylene and/or propylene from associated streams such as a C<sub>4</sub> product, pyrolysis gasoline, and pyrolysis fuel oil. The ethylene process does not include the manufacture of SOCOMI chemicals such as the production of butadiene from the C<sub>4</sub> stream and aromatics from pyrolysis gasoline.

*Flexible operation unit* means a chemical manufacturing process unit that manufactures different chemical products periodically by alternating raw materials or operating conditions. These units are also referred to as campaign plants or blocked operations.

*Fuel gas* means gases that are combusted to derive useful work or heat.

*Fuel gas system* means the offsite and onsite piping and flow and pressure control system that gathers gaseous stream(s) generated by onsite operations, may blend them with other sources of gas, and transports the gaseous stream for use as fuel gas in combustion devices or in in-process combustion equipment such as furnaces and gas turbines either singly or in combination.

*Heat exchange system* means any cooling tower system or once-through cooling water system (e.g., river or pond water). A heat exchange system can include more than one heat exchanger and can include an entire recirculating or once-through cooling system.

*Impurity* means a substance that is produced coincidentally with the primary product, or is present in a raw material. An impurity does not serve a useful purpose in the production or use of the primary product and is not isolated.

*Initial start-up* means the first time a new or reconstructed source begins production, or, for equipment added or changed as described in §63.100 (l) or (m) of this subpart, the first time the equipment is put into operation. Initial start-up does not include operation solely for testing equipment. For purposes of subpart

G of this part, initial start-up does not include subsequent start-ups (as defined in this section) of chemical manufacturing process units following malfunctions or shutdowns or following changes in product for flexible operation units or following recharging of equipment in batch operation. For purposes of subpart H of this part, initial start-up does not include subsequent start-ups (as defined in §63.161 of subpart H of this part) of process units (as defined in §63.161 of subpart H of this part) following malfunctions or process unit shutdowns.

*Loading rack* means a single system used to fill tank trucks and railcars at a single geographic site. Loading equipment and operations that are physically separate (i.e., do not share common piping, valves, and other equipment) are considered to be separate loading racks.

*Maintenance wastewater* means wastewater generated by the draining of process fluid from components in the chemical manufacturing process unit into an individual drain system prior to or during maintenance activities. Maintenance wastewater can be generated during planned and unplanned shutdowns and during periods not associated with a shutdown. Examples of activities that can generate maintenance wastewaters include descaling of heat exchanger tubing bundles, cleaning of distillation column traps, draining of low legs and high point bleeds, draining of pumps into an individual drain system, and draining of portions of the chemical manufacturing process unit for repair.

*On-site* or *On site* means, with respect to records required to be maintained by this subpart, that the records are stored at a location within a major source which encompasses the affected source. On-site includes, but is not limited to, storage at the chemical manufacturing process unit to which the records pertain, or storage in central files elsewhere at the major source.

*Operating permit* means a permit required by 40 CFR part 70 or 71.

*Organic hazardous air pollutant* or *organic HAP* means one of the chemicals listed in table 2 of this subpart.

*Petroleum refining process*, also referred to as a *petroleum refining process unit*, means a process that for the purpose of producing transportation fuels (such as gasoline and diesel fuels), heating fuels (such as fuel gas, distillate, and residual fuel oils), or lubricants separates petroleum or separates, cracks, or reforms unfinished derivatives. Examples of such units include, but are not limited to, alkylation units, catalytic hydrotreating, catalytic hydrorefining, catalytic hydrocracking, catalytic reforming, catalytic cracking, crude distillation, and thermal processes.

*Plant site* means all contiguous or adjoining property that is under common control, including properties that are separated only by a road or other public right-of-way. Common control includes properties that are owned, leased, or operated by the same entity, parent entity, subsidiary, or any combination thereof.

*Process vent* means the point of discharge to the atmosphere (or the point of entry into a control device, if any) of a gas stream if the gas stream has the characteristics specified in §63.107(b) through (h), or meets the criteria specified in §63.107(i). For purposes of §§63.113 through 63.118, all references to the characteristics of a process vent (e.g., flow rate, total HAP concentration, or TRE index value) shall mean the characteristics of the gas stream.

*Process wastewater* means wastewater which, during manufacturing or processing, comes into direct contact with or results from the production or use of any raw material, intermediate product, finished product, by-product, or waste product. Examples are product tank drawdown or feed tank drawdown; water formed during a chemical reaction or used as a reactant; water used to wash impurities from organic products or reactants; water used to cool or quench organic vapor streams through direct contact; and condensed steam from jet ejector systems pulling vacuum on vessels containing organics.

*Product* means a compound or chemical which is manufactured as the intended product of the chemical manufacturing process unit. By-products, isolated intermediates, impurities, wastes, and trace contaminants are not considered products.

*Product separator* means phase separators, flash drums, knock-out drums, decanters, degassers, and condenser(s) including ejector-condenser(s) associated with a reactor or an air oxidation reactor.

*Reactor* means a device or vessel in which one or more chemicals or reactants, other than air, are combined or decomposed in such a way that their molecular structures are altered and one or more new organic compounds are formed. Reactor includes the product separator and any associated vacuum pump or steam jet.

*Recapture device* means an individual unit of equipment capable of and used for the purpose of recovering chemicals, but not normally for use, reuse, or sale. For example, a recapture device may recover chemicals primarily for disposal. Recapture devices include, but are not limited to, absorbers, carbon adsorbers, and condensers.

*Recovery device* means an individual unit of equipment capable of and normally used for the purpose of recovering chemicals for fuel value (i.e., net positive heating value), use, reuse or for sale for fuel value, use, or reuse. Examples of equipment that may be recovery devices include absorbers, carbon adsorbers, condensers, oil-water separators or organic-water separators, or organic removal devices such as decanters, strippers, or thin-film evaporation units. For purposes of the monitoring, recordkeeping, and reporting requirements of subpart G of this part, recapture devices are considered recovery devices.

*Research and development facility* means laboratory and pilot plant operations whose primary purpose is to conduct research and development into new processes and products, where the operations are under the close supervision of technically trained personnel, and is not engaged in the manufacture of products for commercial sale, except in a *de minimis* manner.

*Shutdown* means for purposes including, but not limited to, periodic maintenance, replacement of equipment, or repair, the cessation of operation of a chemical manufacturing process unit or a reactor, air oxidation reactor, distillation unit, waste management unit, equipment required or used to comply with this subpart F, subparts G, or H of this part or the emptying and degassing of a storage vessel. Shutdown does not include the routine rinsing or washing of equipment in batch operation between batches.

*Source* means the collection of emission points to which this subpart applies as determined by the criteria in §63.100 of this subpart. For purposes of subparts F, G, and H of this part, the term *affected source* as used in subpart A of this part has the same meaning as the term *source* defined here.

*Start-up* means the setting into operation of a chemical manufacturing process unit or a reactor, air oxidation reactor, distillation unit, waste management unit, or equipment required or used to comply with this subpart F, subpart G, or H of this part or a storage vessel after emptying and degassing. Start-up includes initial start-up, operation solely for testing equipment, the recharging of equipment in batch operation, and transitional conditions due to changes in product for flexible operation units.

*Start-up, shutdown, and malfunction plan* means the plan required under §63.6(e)(3) of subpart A of this part. This plan details the procedures for operation and maintenance of the source during periods of start-up, shutdown, and malfunction.

*Storage vessel* means a tank or other vessel that is used to store organic liquids that contain one or more of the organic HAP's listed in table 2 of this subpart and that has been assigned, according to the procedures in §63.100(g) of this subpart, to a chemical manufacturing process unit that is subject to this subpart. Storage vessel does not include:

- (1) Vessels permanently attached to motor vehicles such as trucks, railcars, barges, or ships;
- (2) Pressure vessels designed to operate in excess of 204.9 kilopascals and without emissions to the atmosphere;
- (3) Vessels with capacities smaller than 38 cubic meters;
- (4) Vessels storing organic liquids that contain organic hazardous air pollutants only as impurities;
- (5) Bottoms receiver tanks;
- (6) Surge control vessels; or
- (7) Wastewater storage tanks. Wastewater storage tanks are covered under the wastewater provisions.

*Surge control vessel* means feed drums, recycle drums, and intermediate vessels. Surge control vessels are used within a chemical manufacturing process unit when in-process storage, mixing, or management of flow rates or volumes is needed to assist in production of a product.

*Transfer operation* means the loading, into a tank truck or railcar, of organic liquids that contain one or more of the organic hazardous air pollutants listed in table 2 of this subpart from a transfer rack (as defined in this section). Transfer operations do not include loading at an operating pressure greater than 204.9 kilopascals.

*Transfer rack* means the collection of loading arms and loading hoses, at a single loading rack, that are assigned to a chemical manufacturing process unit subject to this subpart according to the procedures specified in §63.100(h) of this subpart and are used to fill tank trucks and/or railcars with organic liquids that contain one or more of the organic hazardous air pollutants listed in table 2 of this subpart. Transfer rack includes the associated pumps, meters, shutoff valves, relief valves, and other piping and valves. Transfer rack does not include:

- (1) Racks, arms, or hoses that only transfer liquids containing organic hazardous air pollutants as impurities;



- (2) Racks, arms, or hoses that vapor balance during all loading operations; or
- (3) Racks transferring organic liquids that contain organic hazardous air pollutants only as impurities.

*Unit operation* means one or more pieces of process equipment used to make a single change to the physical or chemical characteristics of one or more process streams. Unit operations include, but are not limited to, reactors, distillation units, extraction columns, absorbers, decanters, dryers, condensers, and filtration equipment.

*Vapor balancing system* means a piping system that is designed to collect organic hazardous air pollutants vapors displaced from tank trucks or railcars during loading; and to route the collected organic hazardous air pollutants vapors to the storage vessel from which the liquid being loaded originated, or to another storage vessel connected by a common header or to compress and route to a process or a fuel gas system the collected organic hazardous air pollutants vapors.

*Waste management unit* means the equipment, structure(s), and/or device(s) used to convey, store, treat, or dispose of wastewater streams or residuals. Examples of waste management units include: Wastewater tanks, surface impoundments, individual drain systems, and biological wastewater treatment units. Examples of equipment that may be waste management units include containers, air flotation units, oil-water separators or organic-water separators, or organic removal devices such as decanters, strippers, or thin-film evaporation units. If such equipment is used for recovery then it is part of a chemical manufacturing process unit and is not a waste management unit.

*Wastewater* means water that:

- (1) Contains either:
  - (i) An annual average concentration of Table 9 compounds (as defined in §63.111 of subpart G of this part) of at least 5 parts per million by weight and has an annual average flow rate of 0.02 liter per minute or greater, or
  - (ii) An annual average concentration of Table 9 compounds (as defined in §63.111 of subpart G) of at least 10,000 parts per million by weight at any flow rate, and that
- (2) Is discarded from a chemical manufacturing process unit that meets all of the criteria specified in §63.100 (b)(1) through (b)(3) of this subpart. Wastewater is process wastewater or maintenance wastewater.

[59 FR 19454, Apr. 22, 1994, as amended at 60 FR 18024, Apr. 10, 1995; 60 FR 63626, Dec. 12, 1995; 62 FR 2731, Jan. 17, 1997; 65 FR 26497, May 8, 2000; 66 FR 6928, Jan. 22, 2001]

[↑ Back to Top](#)

### **§63.102 General standards.**

- (a) Owners and operators of sources subject to this subpart shall comply with the requirements of subparts G and H of this part.

(1) The provisions set forth in this subpart F and subpart G of this part shall apply at all times except during periods of start-up or shutdown (as defined in §63.101 of this subpart), malfunction, or non-operation of the chemical manufacturing process unit (or specific portion thereof) resulting in cessation of the emissions to which this subpart F and subpart G of this part apply. However, if a start-up, shutdown, malfunction or period of non-operation of one portion of a chemical manufacturing process unit does not affect the ability of a particular emission point to comply with the specific provisions to which it is subject, then that emission point shall still be required to comply with the applicable provisions of this subpart F and subpart G of this part during the start-up, shutdown, malfunction or period of non-operation. For example, if there is an overpressure in the reactor area, a storage vessel in the chemical manufacturing process unit would still be required to be controlled in accordance with §63.119 of subpart G of the part. Similarly, the degassing of a storage vessel would not affect the ability of a process vent to meet the requirements of §63.113 of subpart G of this part.

(2) The provisions set forth in subpart H of this part shall apply at all times except during periods of start-up or shutdown, as defined in §63.101(b) of this subpart, malfunction, process unit shutdown (as defined in §63.161 of subpart H of this part), or non-operation of the chemical manufacturing process unit (or specific portion thereof) in which the lines are drained and depressurized resulting in cessation of the emissions to which subpart H of this part applies.

(3) The owner or operator shall not shut down items of equipment that are required or utilized for compliance with the provisions of this subpart F, subpart G or H of this part during times when emissions (or, where applicable, wastewater streams or residuals) are being routed to such items of equipment, if the shutdown would contravene requirements of this subpart F, subpart G or H of this part applicable to such items of equipment. This paragraph does not apply if the item of equipment is malfunctioning, or if the owner or operator must shut down the equipment to avoid damage due to a contemporaneous start-up, shutdown, or malfunction of the chemical manufacturing process unit or portion thereof.

(4) During start-ups, shutdowns, and malfunctions when the requirements of this subpart F, subparts G and/or H of this part do not apply pursuant to paragraphs (a)(1) through (a)(3) of this section, the owner or operator shall implement, to the extent reasonably available, measures to prevent or minimize excess emissions to the extent practical. The general duty to minimize emissions during a period of startup, shutdown, or malfunction does not require the owner or operator to achieve emission levels that would be required by the applicable standard at other times if this is not consistent with safety and good air pollution control practices, nor does it require the owner or operator to make any further efforts to reduce emissions if levels required by the applicable standard have been achieved. Determination of whether such operation and maintenance procedures are being used will be based on information available to the Administrator which may include, but is not limited to, monitoring results, review of operation and maintenance procedures (including the startup, shutdown, and malfunction plan required in §63.6(e)(3)), review of operation and maintenance records, and inspection of the source. The measures to be taken may include, but are not limited to, air pollution control technologies, recovery technologies, work practices, pollution prevention, monitoring, and/or changes in the manner of operation of the source. Back-up control devices are not required, but may be used if available.

(b) If, in the judgment of the Administrator, an alternative means of emission limitation will achieve a reduction in organic HAP emissions at least equivalent to the reduction in organic HAP emissions from

that source achieved under any design, equipment, work practice, or operational standards in subpart G or H of this part, the Administrator will publish in the Federal Register a notice permitting the use of the alternative means for purposes of compliance with that requirement.

(1) The notice may condition the permission on requirements related to the operation and maintenance of the alternative means.

(2) Any notice under paragraph (b) of this section shall be published only after public notice and an opportunity for a hearing.

(3) Any person seeking permission to use an alternative means of compliance under this section shall collect, verify, and submit to the Administrator information showing that the alternative means achieves equivalent emission reductions.

(c) Each owner or operator of a source subject to this subpart shall obtain a permit under 40 CFR part 70 or part 71 from the appropriate permitting authority by the date determined by 40 CFR part 70 or part 71, as appropriate.

(1) If the EPA has approved a State operating permit program under 40 CFR Part 70, the permit shall be obtained from the State authority. If the State operating permit program has not been approved, the source shall apply to the EPA Regional Office.

(2) [Reserved]

(d) The requirements in subparts F, G, and H of this part are Federally enforceable under section 112 of the Act on and after the dates specified in §63.100(k) of this subpart.

[59 FR 19454, Apr. 22, 1994, as amended at 60 FR 63626, Dec. 12, 1995; 61 FR 64575, Dec. 5, 1996; 62 FR 2732, Jan. 17, 1997; 71 FR 20455, Apr. 20, 2006]

[↑ Back to Top](#)

### **§63.103 General compliance, reporting, and recordkeeping provisions.**

(a) Table 3 of this subpart specifies the provisions of subpart A that apply and those that do not apply to owners and operators of sources subject to subparts F, G, and H of this part.

(b) Initial performance tests and initial compliance determinations shall be required only as specified in subparts G and H of this part.

(1) Performance tests and compliance determinations shall be conducted according to the schedule and procedures in §63.7(a) of subpart A of this part and the applicable sections of subparts G and H of this part.

(2) The owner or operator shall notify the Administrator of the intention to conduct a performance test at least 30 calendar days before the performance test is scheduled to allow the Administrator the opportunity to have an observer present during the test.

(3) Performance tests shall be conducted according to the provisions of §63.7(e) of subpart A of this part, except that performance tests shall be conducted at maximum representative operating conditions for the process. During the performance test, an owner or operator may operate the control or recovery device at maximum or minimum representative operating conditions for monitored control or recovery device parameters, whichever results in lower emission reduction.

(4) Data shall be reduced in accordance with the EPA-approved methods specified in the applicable subpart or, if other test methods are used, the data and methods shall be validated according to the protocol in Method 301 of appendix A of this part.

(5) Performance tests may be waived with approval of the Administrator as specified in §63.7(h)(2) of subpart A of this part. Owners or operators of sources subject to subparts F, G, and H of this part who apply for a waiver of a performance test shall submit the application by the dates specified in paragraph (b)(5)(i) of this section rather than the dates specified in §63.7(h)(3) of subpart A of this part.

(i) If a request is made for an extension of compliance under §63.151(a)(6) of subpart G or §63.6(i) of subpart A of this part, the application for a waiver of an initial performance test shall accompany the information required for the request for an extension of compliance. If no extension of compliance is requested, the application for a waiver of an initial performance test shall be submitted no later than 90 calendar days before the Notification of Compliance Status required in §63.152(b) of subpart G of this part is due to be submitted.

(ii) Any application for a waiver of a performance test shall include information justifying the owner or operator's request for a waiver, such as the technical or economic infeasibility, or the impracticality, of the source performing the required test.

(6) The owner or operator of a flexible operation unit shall conduct all required compliance demonstrations during production of the primary product. The owner or operator is not required to conduct compliance demonstrations for operating conditions during production of a product other than the primary product. Except as otherwise provided in this subpart or in subpart G or subpart H of this part, as applicable, the owner or operator shall operate each control device, recovery device, and/or recapture device that is required or used for compliance, and associated monitoring systems, without regard for whether the product that is being produced is the primary product or a different product. Except as otherwise provided in this subpart, subpart G and/or subpart H of this part, as applicable, operation of a control device, recapture device and/or recovery device required or used for compliance such that the daily average of monitored parameter values is outside the parameter range established pursuant to §63.152(b)(2), or such that the monitoring data show operation inconsistent with the monitoring plan established pursuant to §63.120(d)(2) or §63.181(g)(1)(iv), shall constitute a violation of the required operating conditions.

(c) Each owner or operator of a source subject to subparts F, G, and H of this part shall keep copies of all applicable reports and records required by subparts F, G, and H of this part for at least 5 years; except that, if subparts G or H require records to be maintained for a time period different than 5 years, those records shall be maintained for the time specified in subpart G or H of this part. If an owner or operator submits copies of reports to the applicable EPA Regional Office, the owner or operator is not required to

maintain copies of reports. If the EPA Regional Office has waived the requirement of §63.10(a)(4)(ii) for submittal of copies of reports, the owner or operator is not required to maintain copies of reports.

(1) All applicable records shall be maintained in such a manner that they can be readily accessed. The most recent 6 months of records shall be retained on site or shall be accessible from a central location by computer or other means that provides access within 2 hours after a request. The remaining four and one-half years of records may be retained offsite. Records may be maintained in hard copy or computer-readable form including, but not limited to, on paper, microfilm, computer, floppy disk, magnetic tape, or microfiche.

(2) The owner or operator subject to subparts F, G, and H of this part shall keep the records specified in this paragraph, as well as records specified in subparts G and H.

(i) Records of the occurrence and duration of each start-up, shutdown, and malfunction of operation of process equipment or of air pollution control equipment or continuous monitoring systems used to comply with this subpart F, subpart G, or H of this part during which excess emissions (as defined in §63.102(a)(4)) occur.

(ii) For each start-up, shutdown, and malfunction during which excess emissions (as defined in §63.102(a)(4)) occur, records that the procedures specified in the source's start-up, shutdown, and malfunction plan were followed, and documentation of actions taken that are not consistent with the plan. For example, if a start-up, shutdown, and malfunction plan includes procedures for routing a control device to a backup control device (e.g., the incinerator for a halogenated stream could be routed to a flare during periods when the primary control device is out of service), records must be kept of whether the plan was followed. These records may take the form of a "checklist," or other form of recordkeeping that confirms conformance with the start-up, shutdown, and malfunction plan for the event.

(iii) For continuous monitoring systems used to comply with subpart G of this part, records documenting the completion of calibration checks and maintenance of continuous monitoring systems that are specified in the manufacturer's instructions or other written procedures that provide adequate assurance that the equipment would reasonably be expected to monitor accurately.

(3) Records of start-up, shutdown and malfunction and continuous monitoring system calibration and maintenance are not required if they pertain solely to Group 2 emission points, as defined in §63.111 of subpart G of this part, that are not included in an emissions average.

(d) All reports required under subparts F, G, and H of this part shall be sent to the Administrator at the addresses listed in §63.13 of subpart A of this part, except that requests for permission to use an alternative means of compliance as provided for in §63.102(b) of this subpart and application for approval of a nominal efficiency as provided for in §63.150 (i)(1) through (i)(6) of subpart G of this part shall be submitted to the Director of the EPA Office of Air Quality Planning and Standards rather than to the Administrator or delegated authority.

(1) Wherever subpart A of this part specifies "postmark" dates, submittals may be sent by methods other than the U.S. Mail (e.g., by fax or courier). Submittals shall be sent on or before the specified date.

(2) If acceptable to both the Administrator and the owner or operator of a source, reports may be submitted on electronic media.

(e) The owner or operator of a chemical manufacturing process unit which meets the criteria of §63.100(b)(1) and §63.100(b)(3), but not the criteria of §63.100(b)(2), shall comply with the requirements of either paragraph (e)(1) or (e)(2) of this section.

(1) Retain information, data, and analysis used to determine that the chemical manufacturing process unit does not use as a reactant or manufacture as a product or co-product any organic hazardous air pollutant. Examples of information that could document this include, but are not limited to, records of chemicals purchased for the process, analyses of process stream composition, engineering calculations, or process knowledge.

(2) When requested by the Administrator, demonstrate that the chemical manufacturing process unit does not use as a reactant or manufacture as a product or co-product any organic hazardous air pollutant.

(f) To qualify for the exemption specified in §63.100(b)(4) of this subpart, the owner or operator shall maintain the documentation of the information required pursuant to §63.100(b)(4)(i), and documentation of any update of this information requested by the EPA Regional Office, and shall provide the documentation to the EPA Regional Office upon request. The EPA Regional Office will notify the owner or operator, after reviewing such documentation, if the source does not qualify for the exemption specified in §63.100(b)(4) of this section. In such cases, compliance with subpart H shall be required no later than 90 days after expiration of the applicable compliance date in §63.100(k)(3), but in no event earlier than 90 days after the date of such notification by the EPA Regional Office. Compliance with this subpart F and subpart G of this part shall be no later than April 22, 1997, or as otherwise specified in §63.100(k)(2)(ii) of this subpart, unless an extension has been granted by the EPA Regional Office or permitting authority as provided in §63.6(i) of subpart A of this part.

(g) An owner or operator who elects to use the compliance extension provisions of §63.100(k)(6)(i) or (ii) shall submit a compliance extension request to the appropriate EPA Regional Office no later than 45 days before the applicable compliance date in §63.100(k)(3), but in no event is submittal required earlier than May 10, 1995. The request shall contain the information specified in §63.100(k)(5)(iv) and the reason compliance can not reasonably be achieved without a process unit shutdown, as defined in 40 CFR 63.161 or without replacement of the compressor or recasting of the distance piece.

(h) An owner or operator who elects to use the compliance extension provisions of §63.100(k)(8) shall submit to the appropriate EPA Regional Office a brief description of the process change, identify the HAP eliminated, and the expected date of cessation of use or production of HAP. The description shall be submitted no later than May 10, 1995, or with the Notice of Compliance Status as required in §63.182(c) of subpart H, whichever is later.

[59 FR 19454, Apr. 22, 1994, as amended at 59 FR 48176, Sept. 20, 1994; 60 FR 18024, Apr. 10, 1995; 62 FR 2733, Jan. 17, 1997; 63 FR 26082, May 12, 1998]

[↑ Back to Top](#)

#### **§63.104 Heat exchange system requirements.**

(a) Unless one or more of the conditions specified in paragraphs (a)(1) through (a)(6) of this section are met, owners and operators of sources subject to this subpart shall monitor each heat exchange system used to cool process equipment in a chemical manufacturing process unit meeting the conditions of §63.100 (b)(1) through (b)(3) of this subpart, except for chemical manufacturing process units meeting the condition specified in §63.100(c) of this subpart, according to the provisions in either paragraph (b) or (c) of this section. Whenever a leak is detected, the owner or operator shall comply with the requirements in paragraph (d) of this section.

(1) The heat exchange system is operated with the minimum pressure on the cooling water side at least 35 kilopascals greater than the maximum pressure on the process side.

(2) There is an intervening cooling fluid, containing less than 5 percent by weight of total hazardous air pollutants listed in table 4 of this subpart, between the process and the cooling water. This intervening fluid serves to isolate the cooling water from the process fluid and the intervening fluid is not sent through a cooling tower or discharged. For purposes of this section, discharge does not include emptying for maintenance purposes.

(3) The once-through heat exchange system is subject to a National Pollution Discharge Elimination System (NPDES) permit with an allowable discharge limit of 1 part per million or less above influent concentration or 10 percent or less above influent concentration, whichever is greater.

(4) The once-through heat exchange system is subject to an NPDES permit that:

(i) Requires monitoring of a parameter(s) or condition(s) to detect a leak of process fluids into cooling water;

(ii) Specifies or includes the normal range of the parameter or condition;

(iii) Requires monitoring for the parameters selected as leak indicators no less frequently than monthly for the first six months and quarterly thereafter; and

(iv) Requires the owner or operator to report and correct leaks to the cooling water when the parameter or condition exceeds the normal range.

(5) The recirculating heat exchange system is used to cool process fluids that contain less than 5 percent by weight of total hazardous air pollutants listed in table 4 of this subpart.

(6) The once-through heat exchange system is used to cool process fluids that contain less than 5 percent by weight of total hazardous air pollutants listed in table 9 of subpart G of this part.

(b) The owner or operator who elects to comply with the requirements of paragraph (a) of this section by monitoring the cooling water for the presence of one or more organic hazardous air pollutants or other representative substances whose presence in cooling water indicates a leak shall comply with the requirements specified in paragraphs (b)(1) through (b)(6) of this section. The cooling water shall be monitored for total hazardous air pollutants, total volatile organic compounds, total organic carbon, one or more speciated HAP compounds, or other representative substances that would indicate the presence of a leak in the heat exchange system.

(1) The cooling water shall be monitored monthly for the first 6 months and quarterly thereafter to detect leaks.

(2)(i) For recirculating heat exchange systems (cooling tower systems), the monitoring of speciated hazardous air pollutants or total hazardous air pollutants refers to the hazardous air pollutants listed in table 4 of this subpart.

(ii) For once-through heat exchange systems, the monitoring of speciated hazardous air pollutants or total hazardous air pollutants refers to the hazardous air pollutants listed in table 9 of subpart G of this part.

(3) The concentration of the monitored substance(s) in the cooling water shall be determined using any EPA-approved method listed in part 136 of this chapter as long as the method is sensitive to concentrations as low as 10 parts per million and the same method is used for both entrance and exit samples. Alternative methods may be used upon approval by the Administrator.

(4) The samples shall be collected either at the entrance and exit of each heat exchange system or at locations where the cooling water enters and exits each heat exchanger or any combination of heat exchangers.

(i) For samples taken at the entrance and exit of recirculating heat exchange systems, the entrance is the point at which the cooling water leaves the cooling tower prior to being returned to the process equipment and the exit is the point at which the cooling water is introduced to the cooling tower after being used to cool the process fluid.

(ii) For samples taken at the entrance and exit of once-through heat exchange systems, the entrance is the point at which the cooling water enters and the exit is the point at which the cooling water exits the plant site or chemical manufacturing process units.

(iii) For samples taken at the entrance and exit of each heat exchanger or any combination of heat exchangers in chemical manufacturing process units, the entrance is the point at which the cooling water enters the individual heat exchanger or group of heat exchangers and the exit is the point at which the cooling water exits the heat exchanger or group of heat exchangers.

(5) A minimum of three sets of samples shall be taken at each entrance and exit as defined in paragraph (b)(4) of this section. The average entrance and exit concentrations shall then be calculated. The concentration shall be corrected for the addition of any makeup water or for any evaporative losses, as applicable.

(6) A leak is detected if the exit mean concentration is found to be greater than the entrance mean using a one-sided statistical procedure at the 0.05 level of significance and the amount by which it is greater is at least 1 part per million or 10 percent of the entrance mean, whichever is greater.

(c) The owner or operator who elects to comply with the requirement of paragraph (a) of this section by monitoring using a surrogate indicator of heat exchange system leaks shall comply with the requirements specified in paragraphs (c)(1) through (c)(3) of this section. Surrogate indicators that could be used to develop an acceptable monitoring program are ion specific electrode monitoring, pH, conductivity or other representative indicators.



(1) The owner or operator shall prepare and implement a monitoring plan that documents the procedures that will be used to detect leaks of process fluids into cooling water. The plan shall require monitoring of one or more surrogate indicators or monitoring of one or more process parameters or other conditions that indicate a leak. Monitoring that is already being conducted for other purposes may be used to satisfy the requirements of this section. The plan shall include the information specified in paragraphs (c)(1)(i) and (c)(1)(ii) of this section.

(i) A description of the parameter or condition to be monitored and an explanation of how the selected parameter or condition will reliably indicate the presence of a leak.

(ii) The parameter level(s) or conditions(s) that shall constitute a leak. This shall be documented by data or calculations showing that the selected levels or conditions will reliably identify leaks. The monitoring must be sufficiently sensitive to determine the range of parameter levels or conditions when the system is not leaking. When the selected parameter level or condition is outside that range, a leak is indicated.

(iii) The monitoring frequency which shall be no less frequent than monthly for the first 6 months and quarterly thereafter to detect leaks.

(iv) The records that will be maintained to document compliance with the requirements of this section.

(2) If a substantial leak is identified by methods other than those described in the monitoring plan and the method(s) specified in the plan could not detect the leak, the owner or operator shall revise the plan and document the basis for the changes. The owner or operator shall complete the revisions to the plan no later than 180 days after discovery of the leak.

(3) The owner or operator shall maintain, at all times, the monitoring plan that is currently in use. The current plan shall be maintained on-site, or shall be accessible from a central location by computer or other means that provides access within 2 hours after a request. If the monitoring plan is superseded, the owner or operator shall retain the most recent superseded plan at least until 5 years from the date of its creation. The superseded plan shall be retained on-site (or accessible from a central location by computer or other means that provides access within two hours after a request) for at least 6 months after its creation.

(d) If a leak is detected according to the criteria of paragraph (b) or (c) of this section, the owner or operator shall comply with the requirements in paragraphs (d)(1) and (d)(2) of this section, except as provided in paragraph (e) of this section.

(1) The leak shall be repaired as soon as practical but not later than 45 calendar days after the owner or operator receives results of monitoring tests indicating a leak. The leak shall be repaired unless the owner or operator demonstrates that the results are due to a condition other than a leak.

(2) Once the leak has been repaired, the owner or operator shall confirm that the heat exchange system has been repaired within 7 calendar days of the repair or startup, whichever is later.

(e) Delay of repair of heat exchange systems for which leaks have been detected is allowed if the equipment is isolated from the process. Delay of repair is also allowed if repair is technically infeasible without a shutdown and any one of the conditions in paragraph (e)(1) or (e)(2) of this section is met. All

time periods in paragraphs (e)(1) and (e)(2) of this section shall be determined from the date when the owner or operator determines that delay of repair is necessary.

(1) If a shutdown is expected within the next 2 months, a special shutdown before that planned shutdown is not required.

(2) If a shutdown is not expected within the next 2 months, the owner or operator may delay repair as provided in paragraph (e)(2)(i) or (e)(2)(ii) of this section. Documentation of a decision to delay repair shall state the reasons repair was delayed and shall specify a schedule for completing the repair as soon as practical.

(i) If a shutdown for repair would cause greater emissions than the potential emissions from delaying repair, the owner or operator may delay repair until the next shutdown of the process equipment associated with the leaking heat exchanger. The owner or operator shall document the basis for the determination that a shutdown for repair would cause greater emissions than the emissions likely to result from delaying repair as specified in paragraphs (e)(2)(i)(A) and (e)(2)(i)(B) of this section.

(A) The owner or operator shall calculate the potential emissions from the leaking heat exchanger by multiplying the concentration of total hazardous air pollutants listed in table 4 of this subpart in the cooling water from the leaking heat exchanger by the flowrate of the cooling water from the leaking heat exchanger by the expected duration of the delay. The owner or operator may calculate potential emissions using total organic carbon concentration instead of total hazardous air pollutants listed in table 4 of this subpart.

(B) The owner or operator shall determine emissions from purging and depressurizing the equipment that will result from the unscheduled shutdown for the repair.

(ii) If repair is delayed for reasons other than those specified in paragraph (e)(2)(i) of this section, the owner or operator may delay repair up to a maximum of 120 calendar days. The owner shall demonstrate that the necessary parts or personnel were not available.

(f)(1) *Required records.* The owner or operator shall retain the records identified in paragraphs (f)(1)(i) through (f)(1)(iv) of this section as specified in §63.103(c)(1).

(i) Monitoring data required by this section indicating a leak and the date when the leak was detected, and if demonstrated not to be a leak, the basis for that determination;

(ii) Records of any leaks detected by procedures subject to paragraph (c)(2) of this section and the date the leak was discovered;

(iii) The dates of efforts to repair leaks; and

(iv) The method or procedure used to confirm repair of a leak and the date repair was confirmed.

(2) *Reports.* If an owner or operator invokes the delay of repair provisions for a heat exchange system, the following information shall be submitted in the next semi-annual periodic report required by §63.152(c) of subpart G of this part. If the leak remains unrepaired, the information shall also be submitted in each subsequent periodic report, until repair of the leak is reported.

- (i) The owner or operator shall report the presence of the leak and the date that the leak was detected.
- (ii) The owner or operator shall report whether or not the leak has been repaired.
- (iii) The owner or operator shall report the reason(s) for delay of repair. If delay of repair is invoked due to the reasons described in paragraph (e)(2) of this section, documentation of emissions estimates must also be submitted.
- (iv) If the leak remains unrepaired, the owner or operator shall report the expected date of repair.
- (v) If the leak is repaired, the owner or operator shall report the date the leak was successfully repaired.

[62 FR 2733, Jan. 17, 1997]

[↑ Back to Top](#)

### **§63.105 Maintenance wastewater requirements.**

- (a) Each owner or operator of a source subject to this subpart shall comply with the requirements of paragraphs (b) through (e) of this section for maintenance wastewaters containing those organic HAP's listed in table 9 of subpart G of this part.
- (b) The owner or operator shall prepare a description of maintenance procedures for management of wastewaters generated from the emptying and purging of equipment in the process during temporary shutdowns for inspections, maintenance, and repair (i.e., a maintenance-turnaround) and during periods which are not shutdowns (i.e., routine maintenance). The descriptions shall:
  - (1) Specify the process equipment or maintenance tasks that are anticipated to create wastewater during maintenance activities.
  - (2) Specify the procedures that will be followed to properly manage the wastewater and control organic HAP emissions to the atmosphere; and
  - (3) Specify the procedures to be followed when clearing materials from process equipment.
- (c) The owner or operator shall modify and update the information required by paragraph (b) of this section as needed following each maintenance procedure based on the actions taken and the wastewaters generated in the preceding maintenance procedure.
- (d) The owner or operator shall incorporate the procedures described in paragraphs (b) and (c) of this section as part of the startup, shutdown, and malfunction plan required under §63.6(e)(3).
- (e) The owner or operator shall maintain a record of the information required by paragraphs (b) and (c) of this section as part of the start-up, shutdown, and malfunction plan required under §63.6(e)(3) of subpart A of this part.

[59 FR 19454, Apr. 22, 1994, as amended at 60 FR 63626, Dec. 12, 1995; 71 FR 20456, Apr. 20, 2006]

[↑ Back to Top](#)

### **§63.106 Implementation and enforcement.**

(a) This subpart can be implemented and enforced by the U.S. EPA, or a delegated authority such as the applicable State, local, or Tribal agency. If the U.S. EPA Administrator has delegated authority to a State, local, or Tribal agency, then that agency, in addition to the U.S. EPA, has the authority to implement and enforce this subpart. Contact the applicable U.S. EPA Regional Office to find out if implementation and enforcement of this subpart is delegated to a State, local, or Tribal agency.

(b) In delegating implementation and enforcement authority of this subpart to a State, local, or Tribal agency under subpart E of this part, the authorities contained in paragraph (c) of this section are retained by the Administrator of U.S. EPA and cannot be transferred to the State, local, or Tribal agency.

(c) The authorities that cannot be delegated to State, local, or Tribal agencies are as specified in paragraphs (c)(1) through (4) of this section.

(1) Approval of alternatives to requirements in §§63.100, 63.102, and 63.104. Where these standards reference another subpart, the cited provisions will be delegated according to the delegation provisions of the referenced subpart.

(2) Approval of major alternatives to test methods under §63.7(e)(2)(ii) and (f), as defined in §63.90, and as required in this subpart.

(3) Approval of major alternatives to monitoring under §63.8(f), as defined in §63.90, and as required in this subpart.

(4) Approval of major alternatives to recordkeeping and reporting under §63.10(f), as defined in §63.90, and as required in this subpart.

[68 FR 37344, June 23, 2003]

[↑ Back to Top](#)

### **§63.107 Identification of process vents subject to this subpart.**

(a) The owner or operator shall use the criteria specified in this §63.107 to determine whether there are any process vents associated with an air oxidation reactor, distillation unit, or reactor that is in a source subject to this subpart. A process vent is the point of discharge to the atmosphere (or the point of entry into a control device, if any) of a gas stream if the gas stream has the characteristics specified in paragraphs (b) through (h) of this section, or meets the criteria specified in paragraph (i) of this section.

(b) Some, or all, of the gas stream originates as a continuous flow from an air oxidation reactor, distillation unit, or reactor during operation of the chemical manufacturing process unit.

(c) The discharge to the atmosphere (with or without passing through a control device) meets at least one of the conditions specified in paragraphs (c)(1) through (3) of this section.

(1) Is directly from an air oxidation reactor, distillation unit, or reactor; or

(2) Is from an air oxidation reactor, distillation unit, or reactor after passing solely (i.e., without passing through any other unit operation for a process purpose) through one or more recovery devices within the chemical manufacturing process unit; or

(3) Is from a device recovering only mechanical energy from a gas stream that comes either directly from an air oxidation reactor, distillation unit, or reactor, or from an air oxidation reactor, distillation unit, or reactor after passing solely (i.e., without passing through any other unit operation for a process purpose) through one or more recovery devices within the chemical manufacturing process unit.

(d) The gas stream contains greater than 0.005 weight percent total organic HAP at the point of discharge to the atmosphere (or at the point of entry into a control device, if any).

(e) The air oxidation reactor, distillation unit, or reactor is part of a chemical manufacturing process unit that meets the criteria of §63.100(b).

(f) The gas stream is in the gas phase from the point of origin at the air oxidation reactor, distillation unit, or reactor to the point of discharge to the atmosphere (or to the point of entry into a control device, if any).

(g) The gas stream is discharged to the atmosphere either on-site, off-site, or both.

(h) The gas stream is not any of the items identified in paragraphs (h)(1) through (9) of this section.

(1) A relief valve discharge.

(2) A leak from equipment subject to subpart H of this part.

(3) A gas stream going to a fuel gas system as defined in §63.101.

(4) A gas stream exiting a control device used to comply with §63.113.

(5) A gas stream transferred to other processes (on-site or off-site) for reaction or other use in another process (i.e., for chemical value as a product, isolated intermediate, byproduct, or coproduct, or for heat value).

(6) A gas stream transferred for fuel value (i.e., net positive heating value), use, reuse, or for sale for fuel value, use, or reuse.

(7) A storage vessel vent or transfer operation vent subject to §63.119 or §63.126.

(8) A vent from a waste management unit subject to §§63.132 through 63.137.

(9) A gas stream exiting an analyzer.

(i) The gas stream would meet the characteristics specified in paragraphs (b) through (g) of this section, but, for purposes of avoiding applicability, has been deliberately interrupted, temporarily liquefied, routed through any item of equipment for no process purpose, or disposed of in a flare that does not meet the criteria in §63.11(b), or an incinerator that does not reduce emissions of organic HAP by 98 percent or to a concentration of 20 parts per million by volume, whichever is less stringent.

[66 FR 6928, Jan. 22, 2001]

[↑ Back to Top](#)

**Table 1 to Subpart F of Part 63—Synthetic Organic Chemical Manufacturing Industry Chemicals**

<b>Chemical name<sup>a</sup></b>	<b>CAS No.<sup>b</sup></b>	<b>Group</b>
Acenaphthene	83329	V
Acetal	105577	V
Acetaldehyde	75070	II
Acetamide	60355	II
Acetanilide	103844	II
Acetic acid	64197	II
Acetic anhydride	108247	II
Acetoacetanilide	102012	III
Acetone	67641	I
Acetone cyanohydrin	75865	V
Acetonitrile	75058	I
Acetophenone	98862	I
Acrolein	107028	IV
Acrylamide	79061	I
Acrylic acid	79107	IV
Acrylonitrile	107131	I

Adiponitrile	111693	I
Alizarin	72480	V
Alkyl anthraquinones	008	V
Allyl alcohol	107186	I
Allyl chloride	107051	IV
Allyl cyanide	109751	IV
Aminophenol sulfonic acid	0010	V
Aminophenol (p-)	123308	I
Aniline	62533	I
Aniline hydrochloride	142041	III
Anisidine (o-)	90040	II
Anthracene	120127	V
Anthraquinone	84651	III
Azobenzene	103333	I
Benzaldehyde	100527	III
Benzene	71432	I
Benzenedisulfonic acid	98486	I
Benzenesulfonic acid	98113	I
Benzil	134816	III
Benzilic acid	76937	III

Benzoic acid	65850	III
Benzoin	119539	III
Benzonitrile	100470	III
Benzophenone	119619	I
Benzotrichloride	98077	III
Benzoyl chloride	98884	III
Benzyl acetate	140114	III
Benzyl alcohol	100516	III
Benzyl benzoate	120514	III
Benzyl chloride	100447	III
Benzyl dichloride	98873	III
Biphenyl	92524	I
Bisphenol A	80057	III
Bis(Chloromethyl) Ether	542881	I
Bromobenzene	108861	I
Bromoform	75252	V
Bromonaphthalene	27497514	IV
Butadiene (1,3-)	106990	II
Butanediol (1,4-)	110634	I
Butyl acrylate (n-)	141322	V



Butylene glycol (1,3-)	107880	II
Butyrolactone	96480	I
Caprolactam	105602	II
Carbaryl	63252	V
Carbazole	86748	V
Carbon disulfide	75150	IV
Carbon tetrabromide	558134	II
Carbon tetrachloride	56235	I
Carbon tetrafluoride	75730	II
Chloral	75876	II
Chloroacetic acid	79118	II
Chloroacetophenone (2-)	532274	I
Chloroaniline (p-)	106478	II
Chlorobenzene	108907	I
2-Chloro-1,3-butadiene (Chloroprene)	126998	II
Chlorodifluoroethane	25497294	V
Chlorodifluoromethane	75456	I
Chloroform	67663	I
Chloronaphthalene	25586430	IV
Chloronitrobenzene	121733	I

(m-).		
Chloronitrobenzene	88733	I
(o-).		
Chloronitrobenzene	100005	I
(p-).		
Chlorophenol (m-)	108430	II
Chlorophenol (o-)	95578	II
Chlorophenol (p-)	106489	II
Chlorotoluene (m-)	108418	III
Chlorotoluene (o-)	95498	III
Chlorotoluene (p-)	106434	III
Chlorotrifluoromethane	75729	II
Chrysene	218019	V
Cresol and cresylic acid (m-)	108394	III
Cresol and cresylic acid (o-)	95487	III
Cresol and cresylic acid (p-)	106445	III
Cresols and cresylic acids (mixed)	1319773	III
Cumene	98828	I
Cumene hydroperoxide	80159	I
Cyanoacetic acid	372098	II

Cyclohexane	110827	I
Cyclohexanol	108930	I
Cyclohexanone	108941	I
Cyclohexylamine	108918	III
Cyclooctadienes	29965977	II
Decahydronaphthalene	91178	IV
Diacetoxy-2-Butene (1,4-)	0012	V
Diaminophenol hydrochloride	137097	V
Dibromomethane	74953	V
Dichloroaniline (mixed isomers)	27134276	I
Dichlorobenzene (p-)	106467	I
Dichlorobenzene (m-)	541731	I
Dichlorobenzene (o-)	95501	I
Dichlorobenzidine	91941	I
(3,3'-)		
Dichlorodifluoromethane	75718	I
Dichloroethane (1,2-) (Ethylenedichloride) (EDC)	107062	I
Dichloroethyl ether (bis(2-chloroethyl)ether)	111444	I
Dichloroethylene (1,2-)	540590	II
Dichlorophenol (2,4-)	120832	III

Dichloropropene (1,3-)	542756	II
Dichlorotetrafluoro-	1320372	V
ethane.		
Dichloro-1-butene (3,4-)	760236	II
Dichloro-2-butene (1,4-)	764410	V
Diethanolamine (2,2'-Iminodiethanol)	111422	I
Diethyl sulfate	64675	II
Diethylamine	109897	IV
Diethylaniline (2,6-)	579668	V
Diethylene glycol	111466	I
Diethylene glycol dibutyl ether	112732	I
Diethylene glycol diethyl ether	112367	I
Diethylene glycol dimethyl ether	111966	I
Diethylene glycol monobutyl ether acetate	124174	I
Diethylene glycol monobutyl ether	112345	I
Diethylene glycol monoethyl ether acetate	112152	I
Diethylene glycol monoethyl ether	111900	I
Diethylene glycol monohexyl ether	112594	V
Diethylene glycol monomethyl ether acetate	629389	V
Diethylene glycol monomethyl ether	111773	I

Dihydroxybenzoic acid (Resorcylic acid)	27138574	V
Dimethylbenzidine	119937	II
(3,3'-).		
Dimethyl ether	115106	IV
Dimethylformamide (N,N-)	68122	II
Dimethylhydrazine	57147	II
(1,1-).		
Dimethyl sulfate	77781	I
Dimethyl terephthalate	120616	II
Dimethylamine	124403	IV
Dimethylaminoethanol (2-)	108010	I
Dimethylaniline (N,N')	121697	III
Dinitrobenzenes (NOS) <sup>c</sup>	25154545	I
Dinitrophenol (2,4-)	51285	III
Dinitrotoluene (2,4-)	121142	III
Dioxane (1,4-) (1,4-Diethyleneoxide)	1239	11I
Dioxolane (1,3-)	646060	I
Diphenyl methane	101815	I
Diphenyl oxide	101848	I
Diphenyl thiourea	102089	III

Diphenylamine	122394	III
Dipropylene glycol	110985	I
Di-o-tolyguanidine	97392	III
Dodecanedioic acid	693232	I
Dodecyl benzene (branched)	123013	V
Dodecyl phenol (branched)	121158585	V
Dodecylaniline	28675174	V
Dodecylbenzene (n-)	121013	I
Dodecylphenol	27193868	III
Epichlorohydrin (1-chloro-2,3-epoxypropane)	106898	I
Ethanolamine	141435	I
Ethyl acrylate	140885	II
Ethylbenzene	100414	I
Ethyl chloride (Chloroethane)	75003	IV
Ethyl chloroacetate	105395	II
Ethylamine	75047	V
Ethylaniline (N-)	103695	III
Ethylaniline (o-)	578541	III
Ethylcellulose	9004573	V
Ethylcyanoacetate	105566	V

Ethylene carbonate	96491	I
Ethylene dibromide (Dibromoethane)	106934	I
Ethylene glycol	107211	I
Ethylene glycol diacetate	111557	I
Ethylene glycol dibutyl ether	112481	V
Ethylene glycol diethyl ether	629141	I
(1,2-diethoxyethane).		
Ethylene glycol	110714	I
dimethyl ether		
Ethylene glycol monoacetate	542596	V
Ethylene glycol monobutyl ether	112072	I
acetate.		
Ethylene glycol monobutyl ether	111762	I
Ethylene glycol monoethyl ether	111159	I
acetate.		
Ethylene glycol monoethyl ether	110805	I
Ethylene glycol monohexyl ether	112254	V
Ethylene glycol monomethyl ether acetate	110496	I
Ethylene glycol monomethyl ether	109864	I
Ethylene glycol monoethyl ether	002	V

Ethylene glycol monophenyl ether	122996	I
Ethylene glycol monopropyl ether	2807309	I
Ethylene oxide	75218	I
Ethylenediamine	107153	II
Ethylenediamine tetraacetic acid	60004	V
Ethylenimine (Aziridine)	151564	II
Ethylhexyl acrylate (2-isomer)	103117	II
Fluoranthene	206440	V
Formaldehyde	50000	I
Formamide	75127	II
Formic acid	64186	II
Fumaric acid	110178	I
Glutaraldehyde	111308	IV
Glyceraldehyde	367475	V
Glycerol	56815	II
Glycine	56406	II
Glyoxal	107222	II
Hexachlorobenzene	118741	II
Hexachlorobutadiene	87683	II
Hexachloroethane	67721	II



Hexadiene (1,4-)	592450	II
Hexamethylene-	100970	I
tetramine.		
Hexane	110543	V
Hexanetriol (1,2,6-)	106694	IV
Hydroquinone	123319	I
Hydroxyadipaldehyde	141311	V
Isobutyl acrylate	106638	V
Isobutylene	115117	V
Isophorone	78591	IV
Isophorone nitrile	0017	V
Isophthalic acid	121915	III
Isopropylphenol	25168063	III
Linear alkylbenzene	_ d	I
Maleic anhydride	108316	I
Maleic hydrazide	123331	I
Malic acid	6915157	I
Metanilic acid	121471	I
Methacrylic acid	79414	V
Methanol	67561	IV

Methionine	63683	I
Methyl acetate	79209	IV
Methyl acrylate	96333	V
Methyl bromide (Bromomethane)	74839	IV
Methyl chloride (Chloromethane)	74873	IV
Methyl ethyl ketone (2-butanone)	78933	V
Methyl formate	107313	II
Methyl hydrazine	60344	IV
Methyl isobutyl carbinol	108112	IV
Methyl isobutyl ketone (Hexone)	108101	IV
Methyl isocyanate	624839	IV
Methyl mercaptan	74931	IV
Methyl methacrylate	80626	IV
Methyl phenyl carbinol	98851	II
Methyl tert-butyl ether	1634044	V
Methylamine	74895	IV
Methylaniline (N-)	100618	III
Methylcyclohexane	108872	III
Methylcyclohexanol	25639423	V
Methylcyclohexanone	1331222	III

Methylene chloride (Dichloromethane)	75092	I
Methylene dianiline (4,4'-isomer)	101779	I
Methylene diphenyl diisocyanate (4,4'-) (MDI)	101688	III
Methylionones (a-)	79696	V
Methylpentynol	77758	V
Methylstyrene (a-)	98839	I
Naphthalene	91203	IV
Naphthalene sulfonic acid (a-)	85472	IV
Naphthalene sulfonic acid (b-)	120183	IV
Naphthol (a-)	90153	IV
Naphthol (b-)	135193	IV
Naphtholsulfonic acid (1-)	567180	V
Naphthylamine sulfonic acid (1,4-)	84866	V
Naphthylamine sulfonic acid (2,1-)	81163	V
Naphthylamine (1-)	134327	V
Naphthylamine (2-)	91598	V
Nitroaniline (m-)	99092	II
Nitroaniline (o-)	88744	I
Nitroanisole (o-)	91236	III
Nitroanisole (p-)	100174	III

Nitrobenzene	98953	I
Nitronaphthalene (1-)	86577	IV
Nitrophenol (p-)	100027	III
Nitrophenol (o-)	88755	III
Nitropropane (2-)	79469	II
Nitrotoluene (all isomers)	1321126	III
Nitrotoluene (o-)	88722	III
Nitrotoluene (m-)	99081	III
Nitrotoluene (p-)	99990	III
Nitroxylene	25168041	V
Nonylbenzene (branched)	1081772	V
Nonylphenol	25154523	V
Octene-1	111660	I
Octylphenol	27193288	III
Paraformaldehyde	30525894	I
Paraldehyde	123637	II
Pentachlorophenol	87865	III
Pentaerythritol	115775	I
Peracetic acid	79210	II
Perchloromethyl mercaptan	594423	IV

Phenanthrene	85018	V
Phenetidine (p-)	156434	III
Phenol	108952	III
Phenolphthalein	77098	III
Phenolsulfonic acids (all isomers)	1333397	III
Phenyl anthranilic acid (all isomers)	91407	III
Phenylenediamine (p-)	106503	I
Phloroglucinol	108736	III
Phosgene	75445	IV
Phthalic acid	88993	III
Phthalic anhydride	85449	III
Phthalimide	85416	III
Phthalonitrile	91156	III
Picoline (b-)	108996	II
Piperazine	110850	I
Propiolactone (beta-)	57578	I
Propionaldehyde	123386	IV
Propionic acid	79094	I
Propylene carbonate	108327	V
Propylene dichloride (1,2-dichloropropane)	78875	IV

Propylene glycol	57556	I
Propylene glycol monomethyl ether	107982	I
Propylene oxide	75569	I
Pyrene	129000	V
Pyridine	110861	II
p-tert-Butyl toluene	98511	III
Quinone	106514	III
Resorcinol	108463	I
Salicylic acid	69727	III
Sodium methoxide	124414	IV
Sodium phenate	139026	III
Stilbene	588590	III
Styrene	100425	I
Succinic acid	110156	I
Succinonitrile	110612	I
Sulfanilic acid	121573	III
Sulfolane	126330	II
Tartaric acid	526830	I
Terephthalic acid	100210	II
Tetrabromophthalic anhydride	632791	III

Tetrachlorobenzene (1,2,4,5-)	95943	I
Tetrachloroethane (1,1,2,2-)	79345	II
Tetrachloroethylene (Perchloroethylene)	127184	I
Tetrachlorophthalic-	117088	III
anhydride.		
Tetraethyl lead	78002	IV
Tetraethylene glycol	112607	I
Tetraethylene-	112572	V
pentamine.		
Tetrahydrofuran	109999	I
Tetrahydronaphthalene	119642	IV
Tetrahydrophthalic anhydride	85438	II
Tetramethylene-	110601	II
diamine.		
Tetramethylethylenediamine	110189	V
Tetramethyllead	75741	V
Toluene	108883	I
Toluene 2,4 diamine	95807	II
Toluene 2,4 diisocyanate	584849	II
Toluene diisocyanates (mixture)	26471625	II

Toluene sulfonic acids	104154	III
Toluenesulfonyl chloride	98599	III
Toluidine (o-)	95534	II
Trichloroaniline-	634935	III
(2,4,6-).		
Trichlorobenzene (1,2,3-)	87616	V
Trichlorobenzene (1,2,4-)	120821	I
Trichloroethane	71556	II
(1,1,1-)		
Trichloroethane (1,1,2-) (Vinyl trichloride)	79005	II
Trichloroethylene	79016	I
Trichlorofluoromethane	75694	I
Trichlorophenol	95954	I
(2,4,5-).		
(1,1,2-) Trichloro	76131	I
(1,2,2-) trifluoroethane.		
Triethanolamine	102716	I
Triethylamine	121448	IV
Triethylene glycol	112276	I
Triethylene glycol	112492	I



dimethyl ether.		
Triethylene glycol monoethyl ether	112505	V
Triethylene glycol monomethyl ether	112356	I
Trimethylamine	75503	IV
Trimethylcyclohexanol	933482	IV
Trimethylcyclo-	2408379	IV
hexanone.		
Trimethylcyclo-	34216347	V
hexylamine.		
Trimethylolpropane	77996	I
Trimethylpentane (2,2,4-)	540841	V
Tripropylene glycol	24800440	V
Vinyl acetate	108054	II
Vinyl chloride (Chloroethylene)	75014	I
Vinyl toluene	25013154	III
Vinylcyclohexene (4-)	100403	II
Vinylidene chloride	75354	II
(1,1-dichloroethylene).		
Vinyl(N-)-pyrrolidone(2-)	88120	V
Xanthates	140896	V

Xylene sulfonic acid	25321419	III
Xylenes (NOS) <sup>c</sup>	1330207	I
Xylene (m-)	108383	I
Xylene (o-)	95476	I
Xylene (p-)	106423	I
Xylenols (Mixed)	1300716	V
Xylidene	1300738	III

<sup>a</sup>Isomer means all structural arrangements for the same number of atoms of each element and does not mean salts, esters, or derivatives.

<sup>b</sup>CAS Number = Chemical Abstract Service number.

<sup>c</sup>NOS = not otherwise specified.

<sup>d</sup>No CAS number assigned.

[59 FR 19454, Apr. 22, 1994, as amended at 59 FR 48176, Sept. 20, 1994; 61 FR 31439, June 20, 1996; 63 FR 26082, May 12, 1998]

[↑ Back to Top](#)

**Table 2 to Subpart F of Part 63—Organic Hazardous Air Pollutants**

Chemical name <sup>a b</sup>	CAS No. <sup>c</sup>
Acenaphthene	83329
Acetaldehyde	75070
Acetamide	60355
Acetonitrile	75058
Acetophenone	98862

Acrolein	107028
Acrylamide	79061
Acrylic acid	79107
Acrylonitrile	107131
Alizarin	72480
Allyl chloride	107051
Aniline	62533
Anisidine (o-)	90040
Anthracene	120127
Anthraquinone	84651
Benzene	71432
Benzotrichloride	98077
Benzyl chloride	100447
Biphenyl	92524
Bis(chloromethyl)ether	542881
Bromoform	75252
Bromonaphthalene	27497514
Butadiene (1,3-)	106990
Carbon disulfide	75150
Carbon tetrachloride	56235

Chloroacetic acid	79118
Chloroacetophenone (2-)	532274
Chlorobenzene	108907
2-Chloro-,1,3-butadiene (Chloroprene)	126998
Chloroform	67663
Chloronaphthalene	25586430
Chrysene	218019
Cresols and cresylic acids (mixed)	1319773
Cresol and cresylic acid (o-)	95487
Cresol and cresylic acid (m-)	108394
Cresol and cresylic acid (p-)	106445
Cumene	98828
Dichlorobenzene (p-)	106467
Dichlorobenzidine (3,3'-)	91941
Dichloroethane (1,2-) (Ethylene dichloride) (EDC)	107062
Dichloroethylether (Bis(2-chloroethyl)ether)	111444
Dichloropropene (1,3-)	542756
Diethanolamine (2,2'-Iminodiethanol)	111422
Dimethylaniline (N,N-)	121697
Diethyl sulfate	64675

Dimethylbenzidine (3,3'-)	119937
Dimethylformamide (N,N-)	68122
Dimethylhydrazine (1,1-)	58147
Dimethylphthalate	131113
Dimethylsulfate	77781
Dinitrophenol (2,4-)	51285
Dinitrotoluene (2,4-)	121142
Dioxane (1,4-) (1,4-Diethyleneoxide)	123911
1,2-Diphenylhydrazine	122667
Epichlorohydrin (1-Chloro-2,3-epoxypropane)	106898
Ethyl acrylate	140885
Ethylbenzene	100414
Ethyl chloride (Chloroethane)	75003
Ethylene dibromide (Dibromoethane)	106934
Ethylene glycol	107211
Ethylene oxide	75218
Ethylidene dichloride (1,1-Dichloroethane)	75343
Fluoranthene	206440
Formaldehyde	50000
Glycol ethers <sup>d</sup>	

Hexachlorobenzene	118741
Hexachlorobutadiene	87683
Hexachloroethane	67721
Hexane	110543
Hydroquinone	123319
Isophorone	78591
Maleic anhydride	108316
Methanol	67561
Methylbromide (Bromomethane)	74839
Methylchloride (Chloromethane)	74873
Methyl hydrazine	60344
Methyl isobutyl ketone (Hexone)	108101
Methyl isocyanate	624839
Methyl methacrylate	80626
Methyl tert-butyl ether	1634044
Methylene chloride (Dichloromethane)	75092
Methylene diphenyl diisocyanate (4,4'-) (MDI)	101688
Methylenedianiline (4,4'-)	101779
Naphthalene	91203
Naphthalene sulfonic acid ( $\alpha$ )	85472

Naphthalene sulfonic acid ( $\beta$ )	120183
Naphthol ( $\alpha$ )	90153
Naphthol ( $\beta$ )	135193
Naphtholsulfonic acid (1-)	567180
Naphthylamine sulfonic acid (1,4-)	84866
Naphthylamine sulfonic acid (2,1-)	81163
Naphthylamine (1-)	134327
Naphthylamine (2-)	91598
Nitronaphthalene (1-)	86577
Nitrobenzene	98953
Nitrophenol (p-)	100027
Nitropropane (2-)	79469
Phenanthrene	85018
Phenol	108952
Phenylenediamine (p-)	106503
Phosgene	75445
Phthalic anhydride	85449
Propiolactone (beta-)	57578
Propionaldehyde	123386
Propylene dichloride (1,2-Dichloropropane)	78875

Propylene oxide	75569
Pyrene	129000
Quinone	106514
Styrene	100425
Tetrachloroethane (1,1,2,2-)	79345
Tetrachloroethylene (Perchloroethylene)	127184
Tetrahydronaphthalene	119642
Toluene	108883
Toluene diamine (2,4-)	95807
Toluene diisocyanate (2,4-)	584849
Toluidine (o-)	95534
Trichlorobenzene (1,2,4-)	120821
Trichloroethane (1,1,1-) (Methyl chloroform)	71556
Trichloroethane (1,1,2-) (Vinyl trichloride)	79005
Trichloroethylene	79016
Trichlorophenol (2,4,5-)	95954
Triethylamine	121448
Trimethylpentane (2,2,4-)	540841
Vinyl acetate	108054
Vinyl chloride (Chloroethylene)	75014



Vinylidene chloride (1,1-Dichloroethylene)	75354
Xylenes (NOS)	1330207
Xylene (m-)	108383
Xylene (o-)	95476
Xylene (p-)	106423

<sup>a</sup>For all Listings above containing the word “Compounds,” the following applies: Unless otherwise specified, these listings are defined as including any unique chemical substance that contains the named chemical (i.e., antimony, arsenic) as part of that chemical's infrastructure.

<sup>b</sup>Isomer means all structural arrangements for the same number of atoms of each element and does not mean salts, esters, or derivatives.

<sup>c</sup>CAS No. = Chemical Abstract Service number.

<sup>d</sup>Includes mono- and di- ethers of ethylene glycol, diethylene glycol, and triethylene glycol R-(OCH<sub>2</sub> CH<sub>2n</sub>-OR where:

n = 1, 2, or 3;

R = alkyl or aryl groups; and

R'' = R, H or groups which, when removed, yield glycol ethers with the structure:



Polymers are excluded from the glycol category.

[62 FR 2735, Jan. 17, 1997, as amended at 71 FR 76614, Dec. 21, 2006]

[↑ Back to Top](#)

**Table 3 to Subpart F of Part 63—General Provisions Applicability to Subparts F, G, and H<sup>a</sup> to Subpart F**

Reference	Applies to subparts F, G, and H	Comment
63.1(a)(1)	Yes	Overlap clarified in §63.101, §63.111, §63.161.

63.1(a)(2)	Yes	
63.1(a)(3)	Yes	§63.110 and §63.160(b) of subparts G and H identify which standards are overridden.
63.1(a)(4)	No	Subpart F specifies applicability of each paragraph in subpart A to subparts F, G, and H.
63.1 (a)(5)-(a)(9)	No	
63.1(a)(10)	No	Subparts F, G, and H specify calendar or operating day.
63.1(a)(11)	No	Subpart F §63.103(d) specifies acceptable methods for submitting reports. <sup>a</sup>
63.1 (a)(12)-(a)(14)	Yes	
63.1(b)(1)	No	Subpart F specifies applicability.
63.1(b)(2)	Yes	
63.1(b)(3)	No	
63.1(c)(1)	No	Subpart F specifies applicability.
63.1(c)(2)	No	Area sources are not subject to subparts F, G, and H.
63.1(c)(3)	No	
63.1(c)(4)	Yes	
63.1(c)(5)	No	Subparts G and H specify applicable notification requirements.
63.1(d)	No	
63.1(e)	No	Subparts F, G, and H established before permit program.
63.2	Yes	Subpart F §63.101(a) specifies those subpart A definitions that apply to the HON. Subpart F definition of “source” is equivalent to subpart A

		definition of “affected source.”
63.3	No	Units of measure are spelled out in subparts F, G, and H.
63.4 (a)(1)-(a)(3)	Yes	
63.4(a)(4)	No	This is a reserved paragraph in subpart A of part 63.
63.4(a)(5)	Yes	
63.4(b)	Yes	
63.4(c)	Yes	
63.5(a)(1)	Yes	Except the terms “source” and “stationary source” in §63.5(a)(1) should be interpreted as having the same meaning as “affected source.”
63.5(a)(2)	Yes	
63.5(b)(1)	Yes	Except §63.100(l) defines when construction or reconstruction is subject to standards for new sources.
63.5(b)(2)	No	This is a reserved paragraph in subpart A of part 63.
63.5(b)(3)	Yes	
63.5(b)(4)	Yes	Except the cross reference to §63.9(b) is limited to §63.9(b) (4) and (5). Subpart F overrides §63.9 (b)(1) through (b)(3).
63.5(b)(5)	Yes	
63.5(b)(6)	Yes	Except §63.100(l) defines when construction or reconstruction is subject to standards for new sources.
63.5(c)	No	This is a reserved paragraph in subpart A of part 63.
63.5(d)(1)(i)	No	For subpart G, see §63.151(b) (2)(ii) and (2)(iii) for the applicability and timing of this submittal; for subpart H, see §63.182(b) (2)(ii) and (b)(2)(iii) for applicability and timing of this submittal.

63.5(d)(1)(ii)	Yes	Except §63.5(d)(1)(ii)(H) does not apply.
63.5(d)(1)(iii)	No	Subpart G requires submittal of the Notification of Compliance Status in §63.152(b); subpart H specifies requirements in §63.182(c).
63.5(d)(2)	No	
63.5(d)(3)	Yes— subpart G No—subpart H	Except §63.5(d)(3)(ii) does not apply to subpart G.
63.5(d)(4)	Yes	
63.5(e)	Yes	
63.5(f)(1)	Yes	
63.5(f)(2)	Yes	Except the cross-reference to §63.5(d)(1) is changed to §63.151(b)(2)(ii) of subpart G and to §63.182(b)(2)(ii) of subpart H. The cross-reference to §63.5(b)(2) does not apply.
63.6(a)	Yes	
63.6(b)(1)	No	Subparts F and H specify compliance dates for sources subject to subparts F, G, and H.
63.6(b)(2)	No	
63.6(b)(3)	Yes	
63.6(b)(4)	No	May apply when standards are proposed under Section 112(f) of the Clean Air Act.
63.6(b)(5)	No	Subparts G and H include notification requirements.
63.6(b)(6)	No	
63.6(b)(7)	No	

63.6(c)(1)	No	Subpart F specifies the compliance dates for subparts G and H.
63.6(c)(2)	No	
63.6(c)(3)	No	
63.6(c)(4)	No	
63.6(c)(5)	Yes	
63.6(d)	No	
63.6(e)	Yes	Except as otherwise specified for individual paragraphs. Does not apply to Group 2 emission points unless they are included in an emissions average. <sup>b</sup>
63.6(e)(1)(i)	No	This is addressed by §63.102(a)(4) of subpart F.
63.6(e)(1)(ii)	Yes	
63.6(e)(1)(iii)	Yes	
63.6(e)(2)	Yes	
63.6(e)(3)(i)	Yes	For subpart H, the startup, shutdown, and malfunction plan requirement of §63.6(e)(3)(i) is limited to control devices subject to the provisions of subpart H and is optional for other equipment subject to subpart H. The startup, shutdown, and malfunction plan may include written procedures that identify conditions that justify a delay of repair.
63.6(e)(3)(i)(A)	No	This is addressed by §63.102(a)(4).
63.6(e)(3)(i)(B)	Yes	
63.6(e)(3)(i)(C)	Yes	
63.6(e)(3)(ii)	Yes	
63.6(e)(3)(iii)	No	Recordkeeping and reporting are specified in §63.103(c)(2) of subpart F and §63.152(d)(1) of subpart G.

63.6(e)(3)(iv)	No	Recordkeeping and reporting are specified in §63.103(c)(2) of subpart F and §63.152(d)(1) of subpart G.
63.6(e)(3)(v)	No	Records retention requirements are specified in §63.103(c).
63.6(e)(3)(vi)	Yes	
63.6(e)(3)(vii)	Yes	
63.6(e)(3)(vii)(A)	Yes	
63.6(e)(3)(vii)(B)	Yes	Except the plan must provide for operation in compliance with §63.102(a)(4).
63.6(e)(3)(vii)(C)	Yes	
63.6(e)(3)(viii)	Yes	
63.6(e)(3)(ix)	Yes	
63.6(f)(1)	No	§63.102(a) of subpart F specifies when the standards apply.
63.6(f)(2)(i)	Yes	
63.6(f)(2)(ii)	Yes— subpart G No—subpart H	§63.152(c)(2) of subpart G specifies the use of monitoring data in determining compliance with subpart G.
63.6(f)(2)(iii) (A), (B), and (C)	Yes	
63.6(f)(2)(iii)(D)	No	
63.6(f)(2)(iv)	Yes	
63.6(f)(2)(v)	Yes	
63.6(f)(3)	Yes	

63.6(g)	No	Procedures specified in §63.102(b) of subpart F.
63.6(h)	No	
63.6(i)(1)	Yes	
63.6(i)(2)	Yes	
63.6(i)(3)	No	For subpart G, §63.151(a)(6) specifies procedures; for subpart H, §63.182(a)(6) specifies procedures.
63.6(i)(4)(i)(A)	Yes	
63.6(i)(4)(i)(B)	No	Dates are specified in §63.151(a)(6)(i) of subpart G and §63.182(a)(6)(i) of subpart H.
63.6(i)(4)(ii)	No	
63.6(i)(5)-(14)	Yes	
63.6(i)(15)	No	
63.6(i)(16)	Yes	
63.6(j)	Yes	
63.7(a)(1)	No	Subparts F, G, and H specify required testing and compliance demonstration procedures.
63.7(a)(2)	No	For subpart G, test results must be submitted in the Notification of Compliance Status due 150 days after compliance date, as specified in §63.152(b); for subpart H, all test results subject to reporting are reported in periodic reports.
63.7(a)(3)	Yes	
63.7(b)	No	
63.7(c)	No	

63.7(d)	Yes	
63.7(e)(1)	Yes	
63.7(e)(2)	Yes	
63.7(e)(3)	No	Subparts F, G, and H specify test methods and procedures.
63.7(e)(4)	Yes	
63.7(f)	No	Subparts F, G, and H specify applicable methods and provide alternatives.
63.7(g)	No	Performance test reporting specified in §63.152(b) of subpart G: Not applicable to subpart H because no performance test required by subpart H.
63.7(h)(1)	Yes	
63.7(h)(2)	Yes	
63.7(h)(3)	No	§63.103(b)(5) of subpart F specifies provisions for requests to waive performance tests.
63.7(h)(4)	No	
63.7(h)(5)	Yes	
63.8(a)(1)	Yes	
63.8(a)(2)	No	
63.8(a)(3)	No	
63.8(a)(4)	Yes	
63.8(b)(1)	Yes	
63.8(b)(2)	No	Subparts G and H specify locations to conduct monitoring.



63.8(b)(3)	Yes	
63.8(c)(1)(i)	Yes	
63.8(c)(1)(ii)	No	For subpart G, submit as part of periodic report required by §63.152(c); for subpart H, retain as required by §63.181(g)(2)(ii).
63.8(c)(1)(iii)	Yes	
63.8(c)(2)	Yes	
63.8(c)(3)	Yes	
63.8(c)(4)	No	Subpart G specifies monitoring frequency by kind of emission point and control technology used (e.g., §63.111, §63.120(d)(2), §63.143, and §63.152(f)); subpart H does not require use of continuous monitoring systems.
63.8 (c)(5)-(c)(8)	No	
63.8(d)	No	
63.8(e)	No	
63.8 (f)(1)-(f)(3)	Yes	
63.8(f)(4)(i)	No	Timeframe for submitting request specified in §63.151(f) or (g) of subpart G; not applicable to subpart H because subpart H specifies acceptable alternative methods.
63.8(f)(4)(ii)	Yes	
63.8(f)(4)(iii)	No	
63.8(f)(5)(i)	Yes	
63.8(f)(5)(ii)	No	
63.8(f)(5)(iii)	Yes	

63.8(f)(6)	No	Subparts G and H do not require continuous emission monitoring.
63.8(g)	No	Data reduction procedures specified in §63.152(f) and (g) of subpart G; not applicable to subpart H.
63.9(a)	Yes	
63.9(b)(1)	No	Specified in §63.151(b)(2) of subpart G; specified in §63.182(b) of subpart H.
63.9(b)(2)	No	Initial Notification provisions are specified in §63.151(b) of subpart G; in §63.182(b) of subpart H.
63.9(b)(3)	No	
63.9(b)(4)	Yes	Except that the notification in §63.9(b)(4)(i) shall be submitted at the time specified in §63.151(b)(2)(ii) of subpart G; in §63.182(b)(2) of subpart H.
63.9(b)(5)	Yes	Except that the notification in §63.9(b)(5) shall be submitted at the time specified in §63.151(b)(2)(ii) of subpart G; in §63.182 (b)(2) of subpart H.
63.9(c)	Yes	
63.9(d)	Yes	
63.9(e)	No	
63.9(f)	No	
63.9(g)	No	
63.9(h)	No	§63.152(b) of subpart G and §63.182 (c) of subpart H specify Notification of Compliance Status requirements.
63.9(i)	Yes	
63.9(j)	No	

63.10(a)	Yes	
63.10(b)(1)	No	§63.103(c) of subpart F specifies record retention requirements.
63.10(b)(2)	No	§63.103(c) of subpart F specifies required records.
63.10(b)(3)	No	
63.10(c)	No	
63.10(d)(1)	No	
63.10(d)(2)	No	§63.152(b) of subpart G specifies performance test reporting; not applicable to subpart H.
63.10(d)(3)	No	
63.10(d)(4)	Yes	
63.10(d)(5)	Yes	Except that reports required by §63.10(d)(5) shall be submitted at the time specified in §63.152(d) of subpart G and in §63.182(d) of subpart H.
63.10(e)	No	
63.10(f)	Yes	
63.11-63.15	Yes	

<sup>a</sup>Wherever subpart A specifies “postmark” dates, submittals may be sent by methods other than the U.S. Mail (e.g., by fax or courier). Submittals shall be sent by the specified dates, but a postmark is not necessarily required.

<sup>b</sup>The plan, and any records or reports of start-up, shutdown, and malfunction do not apply to Group 2 emission points unless they are included in an emissions average.

[62 FR 2737, Jan. 17, 1997, as amended at 71 FR 20456, Apr. 20, 2006]

[↑ Back to Top](#)

**Table 4 to Subpart F of Part 63—Organic Hazardous Air Pollutants Subject to Cooling Tower Monitoring Requirements in §63.104**

<b>Chemical name</b>	<b>CAS Number<sup>a</sup></b>
Acetaldehyde	75070
Acetonitrile	75058
Acetophenone	98862
Acrolein	107028
Acrylonitrile	107131
Allyl chloride	107051
Aniline	62533
Anisidine (o-)	90040
Benzene	71432
Benzyl chloride	100447
Biphenyl	92524
Bromoform	75252
Butadiene (1,3-)	106990
Carbon disulfide	75150
Carbon tetrachloride	56235
Chloroacetophenone (2-)	532274
Chlorobenzene	108907
2-Chloro-1,3-butadiene (Chloroprene)	126998

Chloroform	67663
Cresol and cresylic acid (o-)	95487
Cresol and cresylic acid (m-)	108394
Cresol and cresylic acid (p-)	106445
Cumene	98828
Dichlorobenzene (p-)	106467
Dichlorobenzidine (3,3''-)	91941
Dichloroethane (1,2-) (Ethylene dichloride) (EDC)	107062
Dichloroethyl ether (Bis(2-chloroethyl)ether)	111444
Dichloropropene (1,3-)	542756
Diethylene glycol diethyl ether	112367
Diethylene glycol dimethyl ether	111966
Diethyl sulfate	64675
Dimethylaniline (N,N-)	121697
Dimethylhydrazine (1,1-)	57147
Dimethyl phthalate	131113
Dimethyl sulfate	77781
Dinitrophenol (2,4-)	51285
Dinitrotoluene (2,4-)	121142
Dioxane (1,4-) (1,4-Diethyleneoxide)	123911

Epichlorohydrin (1-Chloro-2,3-epoxypropane)	106898
Ethyl acrylate	140885
Ethylbenzene	100414
Ethyl chloride (Chloroethane)	75003
Ethylene dibromide (Dibromoethane)	106934
Ethylene glycol dimethyl ether	110714
Ethylene glycol monobutyl ether	111762
Ethylene glycol monobutyl ether acetate	112072
Ethylene glycol monoethyl ether acetate	111159
Ethylene glycol monoethyl ether	110805
Ethylene glycol monomethyl ether	109864
Ethylene glycol monomethyl ether acetate	110496
Ethylene glycol monopropyl ether	2807309
Ethylene oxide	75218
Ethylidene dichloride (1,1-Dichloroethane)	75343
Formaldehyde	50000
Hexachlorobenzene	118741
Hexachlorobutadiene	87683
Hexachloroethane	67721
Hexane	110543

Isophorone	78591
Methanol	67561
Methyl bromide (Bromomethane)	74839
Methyl chloride (Chloromethane)	74873
Methyl hydrazine	60344
Methyl isobutyl ketone (Hexone)	108101
Methyl methacrylate	80626
Methyl tert-butyl ether	1634044
Methylene chloride (Dichloromethane)	75092
Methylenedianiline (4,4"-)	101779
Naphthalene	91203
Nitrobenzene	98953
Nitropropane (2-)	79469
Phenol	108952
Phenylenediamine (p-)	106503
Phosgene	75445
Propionaldehyde	123386
Propylene dichloride (1,2-Dichloropropane)	78875
Propylene oxide	75569
Quinone	106514

Styrene	100425
Tetrachloroethane (1,1,2,2-)	79345
Tetrachloroethylene (Perchloroethylene)	127184
Toluene	108883
Toluidine (o-)	95534
Trichlorobenzene (1,2,4-)	120821
Trichloroethane (1,1,1-) (Methyl chloroform)	71556
Trichloroethane (1,1,2-) (Vinyl trichloride)	79005
Trichloroethylene	79016
Trichlorophenol (2,4,5-)	95954
Triethylamine	121448
Trimethylpentane (2,2,4-)	540841
Vinyl acetate	108054
Vinyl chloride (chloroethylene)	75014
Vinylidene chloride (1,1-Dichloroethylene)	75354
Xylene (m-)	108383
Xylene (o-)	95476
Xylene (p-)	106423

<sup>a</sup>CAS Number = Chemical Abstract Service number.

[62 FR 2740, Jan. 17, 1997, as amended at 71 FR 76614, Dec. 21, 2006]

[↑ Back to Top](#)



# **APPENDIX F**

## Electronic Code of Federal Regulations

---

[View past updates to the e-CFR.](#)

[Click here to learn more.](#)

---

**e-CFR data is current as of January 17, 2017**

[Title 40](#) → [Chapter I](#) → [Subchapter C](#) → [Part 63](#) → [Subpart UU](#)

---

[Browse Previous](#) | [Browse Next](#)

Title 40: Protection of Environment

[PART 63—NATIONAL EMISSION STANDARDS FOR HAZARDOUS AIR POLLUTANTS FOR SOURCE CATEGORIES \(CONTINUED\)](#)

---

### **Subpart UU—National Emission Standards for Equipment Leaks—Control Level 2 Standards**

---

#### **Contents**

- [§63.1019](#) Applicability.
- [§63.1020](#) Definitions.
- [§63.1021](#) Alternative means of emission limitation.
- [§63.1022](#) Equipment identification.
- [§63.1023](#) Instrument and sensory monitoring for leaks.
- [§63.1024](#) Leak repair.
- [§63.1025](#) Valves in gas and vapor service and in light liquid service standards.
- [§63.1026](#) Pumps in light liquid service standards.
- [§63.1027](#) Connectors in gas and vapor service and in light liquid service standards.
- [§63.1028](#) Agitators in gas and vapor service and in light liquid service standards.
- [§63.1029](#) Pumps, valves, connectors, and agitators in heavy liquid service; pressure relief devices in liquid service; and instrumentation systems standards.
- [§63.1030](#) Pressure relief devices in gas and vapor service standards.
- [§63.1031](#) Compressors standards.
- [§63.1032](#) Sampling connection systems standards.
- [§63.1033](#) Open-ended valves or lines standards.
- [§63.1034](#) Closed vent systems and control devices; or emissions routed to a fuel gas system or process standards.
- [§63.1035](#) Quality improvement program for pumps.
- [§63.1036](#) Alternative means of emission limitation: Batch processes.
- [§63.1037](#) Alternative means of emission limitation: Enclosed-vented process units or affected facilities.
- [§63.1038](#) Recordkeeping requirements.

§63.1039 Reporting requirements.

Table 1 to Subpart UU of Part 63—Batch Processes Monitoring Frequency For Equipment Other Than Connectors

---

Source: 64 FR 34899, June 29, 1999, unless otherwise noted.

[↑ Back to Top](#)

**§63.1019 Applicability.**

(a) The provisions of this subpart apply to the control of air emissions from equipment leaks for which another subpart references the use of this subpart for such air emission control. These air emission standards for equipment leaks are placed here for administrative convenience and only apply to those owners and operators of facilities subject to a referencing subpart. The provisions of 40 CFR part 63, subpart A (General Provisions) do not apply to this subpart except as noted in the referencing subpart.

(b) *Equipment subject to this subpart.* The provisions of this subpart and the referencing subpart apply to equipment that contains or contacts regulated material. This subpart applies to pumps, compressors, agitators, pressure relief devices, sampling connection systems, open-ended valves or lines, valves, connectors, instrumentation systems, and closed vent systems and control devices used to meet the requirements of this subpart.

(c) *Equipment in vacuum service.* Equipment in vacuum service is excluded from the requirements of this subpart.

(d) *Equipment in service less than 300 hours per calendar year.* Equipment intended to be in regulated material service less than 300 hours per calendar year is excluded from the requirements of §§63.1025 through 63.1034 and §63.1036 if it is identified as required in §63.1022(b)(5).

(e) *Lines and equipment not containing process fluids.* Lines and equipment not containing process fluids are not subject to the provisions of this subpart. Utilities, and other non-process lines, such as heating and cooling systems that do not combine their materials with those in the processes they serve, are not considered to be part of a process unit or affected facility.

(f) *Implementation and enforcement.* This subpart can be implemented and enforced by the U.S. Environmental Protection Agency (EPA), or a delegated authority such as the applicable State, local, or tribal agency. If the EPA Administrator has delegated authority to a State, local, or tribal agency, then that agency has the authority to implement and enforce this subpart. Contact the applicable EPA Regional Office to find out if this subpart is delegated to a State, local, or tribal agency.

(1) In delegating implementation and enforcement authority of this subpart to a State, local, or tribal agency under section 40 CFR part 63, subpart E, the authorities contained in paragraphs (f)(i) through (v) of this section are retained by the EPA Administrator and are not transferred to the State, local, or tribal agency.

(i) Approval of alternatives to the nonopacity emissions standards in §§63.1022 through 62.1034, under §63.6(g), and the standards for quality improvement programs in §63.1035. Where these standards reference another subpart, the cited provisions will be delegated according to the delegation provisions of the referenced subpart.

(ii) [Reserved]

(iii) Approval of major changes to test methods under §63.7(e)(2)(ii) and (f) and as defined in §63.90.

(iv) Approval of major changes to monitoring under §63.8(f) and as defined in §63.90.

(v) Approval of major changes to recordkeeping and reporting under §63.10(f) and as defined in §63.90.

[64 FR 34899, June 29, 1999, as amended at 67 FR 46279, July 12, 2002]

[↑ Back to Top](#)

### **§63.1020 Definitions.**

All terms used in this part shall have the meaning given them in the Act and in this section.

*Batch process* means a process in which the equipment is fed intermittently or discontinuously. Processing then occurs in this equipment after which the equipment is generally emptied. Examples of industries that use batch processes include pharmaceutical production and pesticide production.

*Batch product-process equipment train* means the collection of equipment (e.g., connectors, reactors, valves, pumps, etc.) configured to produce a specific product or intermediate by a batch process.

*Car-seal* means a seal that is placed on a device that is used to change the position of a valve (e.g., from opened to closed) in such a way that the position of the valve cannot be changed without breaking the seal.

*Closed-loop system* means an enclosed system that returns process fluid to the process and is not vented directly to the atmosphere.

*Closed-purge system* means a system or combination of systems and portable containers to capture purged liquids. Containers must be covered or closed when not being filled or emptied.

*Closed-vent system* means a system that is not open to the atmosphere and is composed of piping, ductwork, connections, and, if necessary, flow inducing devices that transport gas or vapor from an emission point to a control device.

*Combustion device* means an individual unit of equipment, such as a flare, incinerator, process heater, or boiler, used for the combustion of organic emissions.

*Connector* means flanged, screwed, or other joined fittings used to connect two pipelines or a pipeline and a piece of equipment. A common connector is a flange. Joined fittings welded completely around the circumference of the interface are not considered connectors for the purpose of this regulation. For the

purpose of reporting and recordkeeping, connector means joined fittings that are not inaccessible, ceramic, or ceramic-lined (e.g., porcelain, glass, or glass-lined) as described in §63.1027(e)(2).

*Continuous parameter monitoring system (CPMS)* means the total equipment that may be required to meet the data acquisition and availability requirements of this part, used to sample, condition (if applicable), analyze, and provide a record of process or control system parameters.

*Control device* means any combustion device, recovery device, recapture device, or any combination of these devices used to comply with this part. Such equipment or devices include, but are not limited to, absorbers, carbon adsorbers, condensers, incinerators, flares, boilers, and process heaters. Primary condensers on steam strippers or fuel gas systems are not considered control devices.

*Distance piece* means an open or enclosed casing through which the piston rod travels, separating the compressor cylinder from the crankcase.

*Double block and bleed system* means two block valves connected in series with a bleed valve or line that can vent the line between the two block valves.

*Equipment* means each pump, compressor, agitator, pressure relief device, sampling connection system, open-ended valve or line, valve, connector, and instrumentation system in regulated material service; and any control devices or systems used to comply with this subpart.

*First attempt at repair*, for the purposes of this subpart, means to take action for the purpose of stopping or reducing leakage of organic material to the atmosphere, followed by monitoring as specified in §§63.1023(b) and (c) of this subpart in to verify whether the leak is repaired, unless the owner or operator determines by other means that the leak is not repaired.

*Fuel gas* means gases that are combusted to derive useful work or heat.

*Fuel gas system* means the offsite and onsite piping and flow and pressure control system that gathers gaseous stream(s) generated by onsite operations, may blend them with other sources of gas, and transports the gaseous stream for use a fuel gas in combustion equipment, such as furnaces and gas turbines, either singly or in combination.

*In food and medical service* means that a piece of equipment in regulated material service contacts a process stream used to manufacture a Food and Drug Administration regulated product where leakage of a barrier fluid into the process stream would cause any of the following:

- (1) A dilution of product quality so that the product would not meet written specifications,
- (2) An exothermic reaction which is a safety hazard,
- (3) The intended reaction to be slowed down or stopped, or
- (4) An undesired side reaction to occur.

*In gas and vapor service* means that a piece of equipment in regulated material service contains a gas or vapor at operating conditions.

*In heavy liquid service* means that a piece of equipment in regulated material service is not in gas and vapor service or in light liquid service.

*In light liquid service* means that a piece of equipment in regulated material service contains a liquid that meets the following conditions:

- (1) The vapor pressure of one or more of the organic compounds is greater than 0.3 kilopascals at 20 °C,
- (2) The total concentration of the pure organic compounds constituents having a vapor pressure greater than 0.3 kilopascals at 20 °C is equal to or greater than 20 percent by weight of the total process stream, and
- (3) The fluid is a liquid at operating conditions.

(Note to definition of “in light liquid service”: Vapor pressures may be determined by standard reference texts or ASTM D-2879.)

*In liquid service* means that a piece of equipment in regulated material service is not in gas and vapor service.

*In organic hazardous air pollutant or in organic HAP service* means that piece of equipment either contains or contracts a fluid (liquid or gas) that is at least 5 percent by weight of total organic HAP's as determined according to the provisions of §63.180(d) of subpart H. The provisions of §63.180(d) of subpart H also specify how to determine that a piece of equipment is not in organic HAP service.

*In regulated material service* means, for the purposes of this subpart, equipment which meets the definition of “in VOC service,” “in VHAP service,” “in organic hazardous air pollutant service,” or “in” other chemicals or groups of chemicals “service” as defined in the referencing subpart.

*In-situ sampling systems* means nonextractive samplers or in-line samplers.

*In vacuum service* means that equipment is operating at an internal pressure which is at least 5 kilopascals below ambient pressure.

*Initial startup* means for new sources, the first time the source begins production. For additions or changes not defined as a new source by this subpart, initial startup means the first time additional or changed equipment is put into operation. Initial startup does not include operation solely for testing of equipment. Initial startup does not include subsequent startup of process units following malfunction or process unit shutdowns. Except for equipment leaks, initial startup also does not include subsequent startups (of process units following changes in product for flexible operation units or following recharging of equipment in batch unit operations).

*Instrumentation system* means a group of equipment components used to condition and convey a sample of the process fluid to analyzers and instruments for the purpose of determining process operating conditions (e.g., composition, pressure, flow, etc.). Valves and connectors are the predominant type of equipment used in instrumentation systems; however, other types of equipment may also be included in these systems. Only valves nominally 1.27 centimeters (0.5 inches) and smaller, and connectors nominally 1.91 centimeters (0.75 inches) and smaller in diameter are considered instrumentation systems

for the purposes of this subpart. Valves greater than nominally 1.27 centimeters (0.5 inches) and connectors greater than nominally 1.91 centimeters (0.75 inches) associated with instrumentation systems are not considered part of instrumentation systems and must be monitored individually.

*Liquids dripping* means any visible leakage from the seal including dripping, spraying, misting, clouding, and ice formation. Indications of liquids dripping include puddling or new stains that are indicative of an existing evaporated drip.

*Nonrepairable* means that it is technically infeasible to repair a piece of equipment from which a leak has been detected without a process unit or affected facility shutdown.

*Open-ended valve or line* means any valve, except relief valves, having one side of the valve seat in contact with process fluid and one side open to atmosphere, either directly or through open piping.

*Organic monitoring device* means a unit of equipment used to indicate the concentration level of organic compounds based on a detection principle such as infra-red, photoionization, or thermal conductivity.

*Polymerizing monomer* means a compound which may form polymer buildup in pump mechanical seals resulting in rapid mechanical seal failure.

*Pressure release* means the emission of materials resulting from the system pressure being greater than the set pressure of the relief device. This release can be one release or a series of releases over a short time period due to a malfunction in the process.

*Pressure relief device or valve* means a safety device used to prevent operating pressures from exceeding the maximum allowable working pressure of the process equipment. A common pressure relief device is a spring-loaded pressure relief valve. Devices that are actuated either by a pressure of less than or equal to 2.5 pounds per square inch gauge or by a vacuum are not pressure relief devices.

*Process unit* means the equipment specified in the definitions of process unit in the applicable referencing subpart. If the referencing subpart does not define process unit, then for the purposes of this part, process unit means the equipment assembled and connected by pipes or ducts to process raw materials and to manufacture an intended product.

*Process unit shutdown* means a work practice or operational procedure that stops production from a process unit, or part of a process unit during which it is technically feasible to clear process material from a process unit, or part of a process unit, consistent with safety constraints and during which repairs can be affected. The following are not considered process unit shutdowns:

(1) An unscheduled work practice or operations procedure that stops production from a process unit, or part of a process unit, for less than 24 hours.

(2) An unscheduled work practice or operations procedure that would stop production from a process unit, or part of a process unit, for a shorter period of time than would be required to clear the process unit, or part of the process unit, of materials and start up the unit, and would result in greater emissions than delay of repair of leaking components until the next scheduled process unit shutdown.

(3) The use of spare equipment and technically feasible bypassing of equipment without stopping production.

*Referencing subpart* means the subpart that refers an owner or operator to this subpart.

*Regulated material*, for purposes of this part, refers to gas from volatile organic liquids (VOL), volatile organic compounds (VOC), hazardous air pollutants (HAP), or other chemicals or groups of chemicals that are regulated by the referencing subpart.

*Regulated source* for the purposes of this part, means the stationary source, the group of stationary sources, or the portion of a stationary source that is regulated by a referencing subpart.

*Relief device or valve* means a valve used only to release an unplanned, nonroutine discharge. A relief valve discharge can result from an operator error, a malfunction such as a power failure or equipment failure, or other unexpected cause that requires immediate venting of gas from process equipment in order to avoid safety hazards or equipment damage.

*Repaired*, for the purposes of this subpart, means that equipment is adjusted, or otherwise altered, to eliminate a leak as defined in the applicable sections of this subpart and unless otherwise specified in applicable provisions of this subpart, is monitored as specified in §§63.1023(b) and (c) to verify that emissions from the equipment are below the applicable leak definition.

*Routed to a process or route to a process* means the emissions are conveyed to any enclosed portion of a process unit where the emissions are predominantly recycled and/or consumed in the same manner as a material that fulfills the same function in the process and/or transformed by chemical reaction into materials that are not regulated materials and/or incorporated into a product; and/or recovered.

*Sampling connection system* means an assembly of equipment within a process unit or affected facility used during periods of representative operation to take samples of the process fluid. Equipment used to take nonroutine grab samples is not considered a sampling connection system.

*Screwed (threaded) connector* means a threaded pipe fitting where the threads are cut on the pipe wall and the fitting requires only two pieces to make the connection (i.e., the pipe and the fitting).

*Sensor* means a device that measures a physical quantity or the change in a physical quantity, such as temperature, pressure, flow rate, pH, or liquid level.

*Set pressure* means for the purposes of this subpart, the pressure at which a properly operating pressure relief device begins to open to relieve atypical process system operating pressure.

*Start-up* means the setting into operation of a piece of equipment or a control device that is subject to this subpart.

[↑ Back to Top](#)

### **§63.1021 Alternative means of emission limitation.**



(a) *Performance standard exemption.* The provisions of paragraph (b) of this section do not apply to the performance standards of §63.1030(b) for pressure relief devices or §63.1031(f) for compressors operating under the alternative compressor standard.

(b) *Requests by owners or operators.* An owner or operator may request a determination of alternative means of emission limitation to the requirements of §§63.1025 through 63.1034 as provided in paragraph (d) of this section. If the Administrator makes a determination that a means of emission limitation is a permissible alternative, the owner or operator shall either comply with the alternative or comply with the requirements of §§63.1025 through 63.1034.

(c) *Requests by manufacturers of equipment.* (1) Manufacturers of equipment used to control equipment leaks of the regulated material may apply to the Administrator for permission for an alternative means of emission limitation that achieves a reduction in emissions of the regulated material achieved by the equipment, design, and operational requirements of this subpart.

(2) The Administrator will grant permission according to the provisions of paragraph (d) of this section.

(d) *Permission to use an alternative means of emission limitation.* Permission to use an alternative means of emission limitation shall be governed by the procedures in paragraphs (d)(1) through (d)(4) of this section.

(1) Where the standard is an equipment, design, or operational requirement, the requirements of paragraphs (d)(1)(i) through (d)(1)(iii) of this section apply.

(i) Each owner or operator applying for permission to use an alternative means of emission limitation shall be responsible for collecting and verifying emission performance test data for an alternative means of emission limitation.

(ii) The Administrator will compare test data for the means of emission limitation to test data for the equipment, design, and operational requirements.

(iii) The Administrator may condition the permission on requirements that may be necessary to ensure operation and maintenance to achieve at least the same emission reduction as the equipment, design, and operational requirements of this subpart.

(2) Where the standard is a work practice, the requirements of paragraphs (d)(2)(i) through (d)(2)(vi) of this section apply.

(i) Each owner or operator applying for permission to use an alternative means of emission limitation shall be responsible for collecting and verifying test data for the alternative.

(ii) For each kind of equipment for which permission is requested, the emission reduction achieved by the required work practices shall be demonstrated for a minimum period of 12 months.

(iii) For each kind of equipment for which permission is requested, the emission reduction achieved by the alternative means of emission limitation shall be demonstrated.

(iv) Each owner or operator applying for such permission shall commit, in writing, for each kind of equipment to work practices that provide for emission reductions equal to or greater than the emission reductions achieved by the required work practices.

(v) The Administrator will compare the demonstrated emission reduction for the alternative means of emission limitation to the demonstrated emission reduction for the required work practices and will consider the commitment in paragraph (d)(2)(iv) of this section.

(vi) The Administrator may condition the permission on requirements that may be necessary to ensure operation and maintenance to achieve the same or greater emission reduction as the required work practices of this subpart.

(3) An owner or operator may offer a unique approach to demonstrate the alternative means of emission limitation.

(4) If, in the judgement of the Administrator, an alternative means of emission limitation will be approved, the Administrator will publish a notice of the determination in the Federal Register using the procedures specified in the referencing subpart.

[↑ Back to Top](#)

### **§63.1022 Equipment identification.**

(a) *General equipment identification.* Equipment subject to this subpart shall be identified. Identification of the equipment does not require physical tagging of the equipment. For example, the equipment may be identified on a plant site plan, in log entries, by designation of process unit or affected facility boundaries by some form of weatherproof identification, or by other appropriate methods.

(b) *Additional equipment identification.* In addition to the general identification required by paragraph (a) of this section, equipment subject to any of the provisions in §§63.1023 through 63.1034 shall be specifically identified as required in paragraphs (b)(1) through (b)(5) of this section, as applicable. This paragraph does not apply to an owner or operator of a batch product process who elects to pressure test the batch product process equipment train pursuant to §63.1036.

(1) *Connectors.* Except for inaccessible, ceramic, or ceramic-lined connectors meeting the provision of §63.1027(e)(2) and instrumentation systems identified pursuant to paragraph (b)(4) of this section, identify the connectors subject to the requirements of this subpart. Connectors need not be individually identified if all connectors in a designated area or length of pipe subject to the provisions of this subpart are identified as a group, and the number of connectors subject is indicated. With respect to connectors, the identification shall be complete no later than the completion of the initial survey required by paragraph (a) of this section.

(2) *Routed to a process or fuel gas system or equipped with a closed vent system and control device.* Identify the equipment that the owner or operator elects to route to a process or fuel gas system or equip with a closed vent system and control device, under the provisions of §63.1026(e)(3) (pumps in light liquid service), §63.1028(e)(3) (agitators), §63.1030(d) (pressure relief devices in gas and vapor service),

§63.1031(e) (compressors), or §63.1037(a) (alternative means of emission limitation for enclosed-vented process units).

(3) *Pressure relief devices.* Identify the pressure relief devices equipped with rupture disks, under the provisions of §63.1030(e).

(4) *Instrumentation systems.* Identify instrumentation systems subject to the provisions of §63.1029 of this subpart. Individual components in an instrumentation system need not be identified.

(5) *Equipment in service less than 300 hours per calendar year.* The identity, either by list, location (area or group), or other method, of equipment in regulated material service less than 300 hours per calendar year within a process unit or affected facilities subject to the provisions of this subpart shall be recorded.

(c) *Special equipment designations: Equipment that is unsafe or difficult-to-monitor—(1) Designation and criteria for unsafe-to-monitor.* Valves meeting the provisions of §63.1025(e)(1), pumps meeting the provisions of §63.1026(e)(6), connectors meeting the provisions of §63.1027(e)(1), and agitators meeting the provisions of §63.1028(e)(7) may be designated unsafe-to-monitor if the owner or operator determines that monitoring personnel would be exposed to an immediate danger as a consequence of complying with the monitoring requirements of this subpart. Examples of unsafe-to-monitor equipment include, but is not limited to, equipment under extreme pressure or heat.

(2) *Designation and criteria for difficult-to-monitor.* Valves meeting the provisions of §63.1025(e)(2) may be designated difficult-to-monitor if the provisions of paragraph (c)(2)(i) apply. Agitators meeting the provisions of §63.1028(e)(5) may be designated difficult-to-monitor if the provisions of paragraph (c)(2)(ii) apply.

(i) *Valves.* (A) The owner or operator of the valve determines that the valve cannot be monitored without elevating the monitoring personnel more than 2 meters (7 feet) above a support surface or it is not accessible in a safe manner when it is in regulated material service; and

(B) The process unit or affected facility within which the valve is located is an existing source, or the owner or operator designates less than 3 percent of the total number of valves in a new source as difficult-to-monitor.

(ii) *Agitators.* The owner or operator determines that the agitator cannot be monitored without elevating the monitoring personnel more than 2 meters (7 feet) above a support surface or it is not accessible in a safe manner when it is in regulated material service.

(3) *Identification of unsafe or difficult-to-monitor equipment.* The owner or operator shall record the identity of equipment designated as unsafe-to-monitor according to the provisions of paragraph (c)(1) of this section and the planned schedule for monitoring this equipment. The owner or operator shall record the identity of equipment designated as difficult-to-monitor according to the provisions of paragraph (c)(2) of this section, the planned schedule for monitoring this equipment, and an explanation why the equipment is unsafe or difficult-to-monitor. This record must be kept at the plant and be available for review by an inspector.

(4) *Written plan requirements.* (i) The owner or operator of equipment designated as unsafe-to-monitor according to the provisions of paragraph (c)(1) of this section shall have a written plan that requires monitoring of the equipment as frequently as practical during safe-to-monitor times, but not more frequently than the periodic monitoring schedule otherwise applicable, and repair of the equipment according to the procedures in §63.1024 if a leak is detected.

(ii) The owner or operator of equipment designated as difficult-to-monitor according to the provisions of paragraph (c)(2) of this section shall have a written plan that requires monitoring of the equipment at least once per calendar year and repair of the equipment according to the procedures in §63.1024 if a leak is detected.

(d) *Special equipment designations: Equipment that is unsafe-to-repair—(1) Designation and criteria.* Connectors subject to the provisions of §63.1024(e) may be designated unsafe-to-repair if the owner or operator determines that repair personnel would be exposed to an immediate danger as a consequence of complying with the repair requirements of this subpart, and if the connector will be repaired before the end of the next process unit or affected facility shutdown as specified in §63.1024(e)(2).

(2) *Identification of equipment.* The identity of connectors designated as unsafe-to-repair and an explanation why the connector is unsafe-to-repair shall be recorded.

(e) *Special equipment designations: Compressors operating with an instrument reading of less than 500 parts per million above background.* Identify the compressors that the owner or operator elects to designate as operating with an instrument reading of less than 500 parts per million above background, under the provisions of §63.1031(f).

(f) *Special equipment designations: Equipment in heavy liquid service.* The owner or operator of equipment in heavy liquid service shall comply with the requirements of either paragraph (f)(1) or (f)(2) of this section, as provided in paragraph (f)(3) of this section.

(1) Retain information, data, and analyses used to determine that a piece of equipment is in heavy liquid service.

(2) When requested by the Administrator, demonstrate that the piece of equipment or process is in heavy liquid service.

(3) A determination or demonstration that a piece of equipment or process is in heavy liquid service shall include an analysis or demonstration that the process fluids do not meet the definition of “in light liquid service.” Examples of information that could document this include, but are not limited to, records of chemicals purchased for the process, analyses of process stream composition, engineering calculations, or process knowledge.

[↑ Back to Top](#)

### **§63.1023 Instrument and sensory monitoring for leaks.**

(a) *Monitoring for leaks.* The owner or operator of a regulated source subject to this subpart shall monitor regulated equipment as specified in paragraph (a)(1) of this section for instrument monitoring and paragraph (a)(2) of this section for sensory monitoring.

(1) *Instrument monitoring for leaks.* (i) Valves in gas and vapor service and in light liquid service shall be monitored pursuant to §63.1025(b).

(ii) Pumps in light liquid service shall be monitored pursuant to §63.1026(b).

(iii) Connectors in gas and vapor service and in light liquid service shall be monitored pursuant to §63.1027(b).

(iv) Agitators in gas and vapor service and in light liquid service shall be monitored pursuant to §63.1028(c).

(v) Pressure relief devices in gas and vapor service shall be monitored pursuant to §63.1030(c).

(vi) Compressors designated to operate with an instrument reading less than 500 parts per million above background, as described in §63.1022(e), shall be monitored pursuant to §63.1031(f).

(2) *Sensory monitoring for leaks.* (i) Pumps in light liquid service shall be observed pursuant to §§63.1026(b)(4) and (e)(1)(v).

(ii) [Reserved]

(iii) Agitators in gas and vapor service and in light liquid service shall be observed pursuant to §63.1028(c)(3) or (e)(1)(iv).

(iv) [Reserved]

(b) *Instrument monitoring methods.* Instrument monitoring, as required under this subpart, shall comply with the requirements specified in paragraphs (b)(1) through (b)(6) of this section.

(1) *Monitoring method.* Monitoring shall comply with Method 21 of 40 CFR part 60, appendix A, except as otherwise provided in this section.

(2) *Detection instrument performance criteria.* (i) Except as provided for in paragraph (b)(2)(ii) of this section, the detection instrument shall meet the performance criteria of Method 21 of 40 CFR part 60, appendix A, except the instrument response factor criteria in section 3.1.2, paragraph (a) of Method 21 shall be for the representative composition of the process fluid not each individual VOC in the stream. For process streams that contain nitrogen, air, water or other inerts that are not HAP or VOC, the representative stream response factor shall be determined on an inert-free basis. The response factor may be determined at any concentration for which monitoring for leaks will be conducted.

(ii) If there is no instrument commercially available that will meet the performance criteria specified in paragraph (b)(2)(i) of this section, the instrument readings may be adjusted by multiplying by the representative response factor of the process fluid, calculated on an inert-free basis as described in paragraph (b)(2)(i) of this section.

(3) *Detection instrument calibration procedure.* The detection instrument shall be calibrated before use on each day of its use by the procedures specified in Method 21 of 40 CFR part 60, appendix A.

(4) *Detection instrument calibration gas.* Calibration gases shall be zero air (less than 10 parts per million of hydrocarbon in air); and the gases specified in paragraph (b)(4)(i) of this section except as provided in paragraph (b)(4)(ii) of this section.

(i) Mixtures of methane in air at a concentration no more than 2,000 parts per million greater than the leak definition concentration of the equipment monitored. If the monitoring instrument's design allows for multiple calibration scales, then the lower scale shall be calibrated with a calibration gas that is no higher than 2,000 parts per million above the concentration specified as a leak, and the highest scale shall be calibrated with a calibration gas that is approximately equal to 10,000 parts per million. If only one scale on an instrument will be used during monitoring, the owner or operator need not calibrate the scales that will not be used during that day's monitoring.

(ii) A calibration gas other than methane in air may be used if the instrument does not respond to methane or if the instrument does not meet the performance criteria specified in paragraph (b)(2)(i) of this section. In such cases, the calibration gas may be a mixture of one or more of the compounds to be measured in air.

(5) *Monitoring performance.* Monitoring shall be performed when the equipment is in regulated material service or is in use with any other detectable material.

(6) *Monitoring data.* Monitoring data obtained prior to the regulated source becoming subject to the referencing subpart that do not meet the criteria specified in paragraphs (b)(1) through (b)(5) of this section may still be used to qualify initially for less frequent monitoring under the provisions in §63.1025(a)(2), (b)(3) or (b)(4) for valves or §63.1027(b)(3) for connectors provided the departures from the criteria or from the specified monitoring frequency of §63.1025(b)(3) or (b)(4) or §63.1027(b)(3) are minor and do not significantly affect the quality of the data. Examples of minor departures are monitoring at a slightly different frequency (such as every 6 weeks instead of monthly or quarterly), following the performance criteria of section 3.1.2, paragraph (a) of Method 21 of appendix A of 40 CFR part 60 instead of paragraph (b)(2) of this section, or monitoring using a different leak definition if the data would indicate the presence or absence of a leak at the concentration specified in this subpart. Failure to use a calibrated instrument is not considered a minor departure.

(c) *Instrument monitoring using background adjustments.* The owner or operator may elect to adjust or not to adjust the instrument readings for background. If an owner or operator elects not to adjust instrument readings for background, the owner or operator shall monitor the equipment according to the procedures specified in paragraphs (b)(1) through (b)(5) of this section. In such cases, all instrument readings shall be compared directly to the applicable leak definition for the monitored equipment to determine whether there is a leak or to determine compliance with §63.1030(b) (pressure relief devices) or §63.1031(f) (alternative compressor standard). If an owner or operator elects to adjust instrument readings for background, the owner or operator shall monitor the equipment according to the procedures specified in paragraphs (c)(1) through (c)(4) of this section.

(1) The requirements of paragraphs (b)(1) through (b)(5) of this section shall apply.

(2) The background level shall be determined, using the procedures in Method 21 of 40 CFR part 60, appendix A.

(3) The instrument probe shall be traversed around all potential leak interfaces as close to the interface as possible as described in Method 21 of 40 CFR part 60, appendix A.

(4) The arithmetic difference between the maximum concentration indicated by the instrument and the background level shall be compared to the applicable leak definition for the monitored equipment to determine whether there is a leak or to determine compliance with §63.1030(b) (pressure relief devices) or §63.1031(f) (alternative compressor standard).

(d) *Sensory monitoring methods.* Sensory monitoring consists of visual, audible, olfactory, or any other detection method used to determine a potential leak to the atmosphere.

(e) *Leaking equipment identification and records.* (1) When each leak is detected pursuant to the monitoring specified in paragraph (a) of this section, a weatherproof and readily visible identification, shall be attached to the leaking equipment.

(2) When each leak is detected, the information specified in §63.1024(f) shall be recorded and kept pursuant to the referencing subpart, except for the information for connectors complying with the 8 year monitoring period allowed under §63.1027(b)(3)(iii) shall be kept 5 years beyond the date of its last use.

[↑ Back to Top](#)

#### **§63.1024 Leak repair.**

(a) *Leak repair schedule.* The owner or operator shall repair each leak detected as soon as practical, but not later than 15 calendar days after it is detected, except as provided in paragraphs (d) and (e) of this section. A first attempt at repair as defined in this subpart shall be made no later than 5 calendar days after the leak is detected. First attempt at repair for pumps includes, but is not limited to, tightening the packing gland nuts and/or ensuring that the seal flush is operating at design pressure and temperature. First attempt at repair for valves includes, but is not limited to, tightening the bonnet bolts, and/or replacing the bonnet bolts, and/or tightening the packing gland nuts, and/or injecting lubricant into the lubricated packing.

(b) [Reserved]

(c) *Leak identification removal—(1) Valves and connectors in gas/vapor and light liquid service.* The leak identification on a valve in gas/vapor or light liquid service may be removed after it has been monitored as specified in §63.1025(d)(2), and no leak has been detected during that monitoring. The leak identification on a connector in gas/vapor or light liquid service may be removed after it has been monitored as specified in §63.1027(b)(3)(iv) and no leak has been detected during that monitoring.

(2) *Other equipment.* The identification that has been placed, pursuant to §63.1023(e)(1), on equipment determined to have a leak, except for a valve or for a connector in gas/vapor or light liquid service that is subject to the provisions of §63.1027(b)(3)(iv), may be removed after it is repaired.

(d) *Delay of repair.* Delay of repair is allowed for any of the conditions specified in paragraphs (d)(1) through (d)(5) of this section. The owner or operator shall maintain a record of the facts that explain any delay of repairs and, where appropriate, why the repair was technically infeasible without a process unit shutdown.

(1) Delay of repair of equipment for which leaks have been detected is allowed if repair within 15 days after a leak is detected is technically infeasible without a process unit or affected facility shutdown. Repair of this equipment shall occur as soon as practical, but no later than the end of the next process unit or affected facility shutdown, except as provided in paragraph (d)(5) of this section.

(2) Delay of repair of equipment for which leaks have been detected is allowed for equipment that is isolated from the process and that does not remain in regulated material service.

(3) Delay of repair for valves, connectors, and agitators is also allowed if the provisions of paragraphs (d)(3)(i) and (d)(3)(ii) of this section are met.

(i) The owner or operator determines that emissions of purged material resulting from immediate repair would be greater than the fugitive emissions likely to result from delay of repair, and

(ii) When repair procedures are effected, the purged material is collected and destroyed, collected and routed to a fuel gas system or process, or recovered in a control device complying with either §63.1034 or §63.1021(b) of this part.

(4) Delay of repair for pumps is also allowed if the provisions of paragraphs (d)(4)(i) and (d)(4)(ii) of this section are met.

(i) Repair requires replacing the existing seal design with a new system that the owner or operator has determined under the provisions of §63.1035(d) will provide better performance or one of the specifications of paragraphs (d)(4)(i)(A) through (d)(4)(i)(C) of this section are met.

(A) A dual mechanical seal system that meets the requirements of §63.1026(e)(1) will be installed;

(B) A pump that meets the requirements of §63.1026(e)(2) will be installed; or

(C) A system that routes emissions to a process or a fuel gas system or a closed vent system and control device that meets the requirements of §63.1026(e)(3) will be installed; and

(ii) Repair is completed as soon as practical, but not later than 6 months after the leak was detected.

(5) Delay of repair beyond a process unit or affected facility shutdown will be allowed for a valve if valve assembly replacement is necessary during the process unit or affected facility shutdown, and valve assembly supplies have been depleted, and valve assembly supplies had been sufficiently stocked before the supplies were depleted. Delay of repair beyond the second process unit or affected facility shutdown will not be allowed unless the third process unit or affected facility shutdown occurs sooner than 6 months after the first process unit or affected facility shutdown.



(e) *Unsafe-to-repair—connectors.* Any connector that is designated, as described in §63.1022(d), as an unsafe-to-repair connector is exempt from the requirements of §63.1027(d), and paragraph (a) of this section.

(f) *Leak repair records.* For each leak detected, the information specified in paragraphs (f)(1) through (f)(5) of this section shall be recorded and maintained pursuant to the referencing subpart.

(1) The date of first attempt to repair the leak.

(2) The date of successful repair of the leak.

(3) Maximum instrument reading measured by Method 21 of 40 CFR part 60, appendix A at the time the leak is successfully repaired or determined to be nonrepairable.

(4) “Repair delayed” and the reason for the delay if a leak is not repaired within 15 calendar days after discovery of the leak as specified in paragraphs (f)(4)(i) and (f)(4)(ii) of this section.

(i) The owner or operator may develop a written procedure that identifies the conditions that justify a delay of repair. The written procedures may be included as part of the startup, shutdown, and malfunction plan, as required by the referencing subpart for the source, or may be part of a separate document that is maintained at the plant site. In such cases, reasons for delay of repair may be documented by citing the relevant sections of the written procedure.

(ii) If delay of repair was caused by depletion of stocked parts, there must be documentation that the spare parts were sufficiently stocked on-site before depletion and the reason for depletion.

(5) Dates of process unit or affected facility shutdowns that occur while the equipment is unrepaired.

[↑ Back to Top](#)

### **§63.1025 Valves in gas and vapor service and in light liquid service standards.**

(a) *Compliance schedule.* (1) The owner or operator shall comply with this section no later than the compliance dates specified in the referencing subpart.

(2) The use of monitoring data generated before the regulated source became subject to the referencing subpart to qualify initially for less frequent monitoring is governed by the provisions of §63.1023(b)(6).

(b) *Leak detection.* Unless otherwise specified in §63.1021(b) or paragraph (e) of this section, or the referencing subpart, the owner or operator shall monitor all valves at the intervals specified in paragraphs (b)(3) and/or (b)(4) of this section and shall comply with all other provisions of this section.

(1) *Monitoring method.* The valves shall be monitored to detect leaks by the method specified in §63.1023(b) and, as applicable, §63.1023(c).

(2) *Instrument reading that defines a leak.* The instrument reading that defines a leak is 500 parts per million or greater.

(3) *Monitoring frequency.* The owner or operator shall monitor valves for leaks at the intervals specified in paragraphs (b)(3)(i) through (b)(3)(v) of this section and shall keep the record specified in paragraph (b)(3)(vi) of this section.

(i) If at least the greater of 2 valves or 2 percent of the valves in a process unit leak, as calculated according to paragraph (c) of this section, the owner or operator shall monitor each valve once per month.

(ii) At process units with less than the greater of 2 leaking valves or 2 percent leaking valves, the owner or operator shall monitor each valve once each quarter, except as provided in paragraphs (b)(3)(iii) through (b)(3)(v) of this section. Monitoring data generated before the regulated source became subject to the referencing subpart and meeting the criteria of either §63.1023(b)(1) through (b)(5), or §63.1023(b)(6), may be used to qualify initially for less frequent monitoring under paragraphs (b)(3)(iii) through (b)(3)(v) of this section.

(iii) At process units with less than 1 percent leaking valves, the owner or operator may elect to monitor each valve once every two quarters

(iv) At process units with less than 0.5 percent leaking valves, the owner or operator may elect to monitor each valve once every four quarters.

(v) At process units with less than 0.25 percent leaking valves, the owner or operator may elect to monitor each valve once every 2 years.

(vi) The owner or operator shall keep a record of the monitoring schedule for each process unit.

(4) *Valve subgrouping.* For a process unit or a group of process units to which this subpart applies, an owner or operator may choose to subdivide the valves in the applicable process unit or group of process units and apply the provisions of paragraph (b)(3) of this section to each subgroup. If the owner or operator elects to subdivide the valves in the applicable process unit or group of process units, then the provisions of paragraphs (b)(4)(i) through (b)(4)(viii) of this section apply.

(i) The overall performance of total valves in the applicable process unit or group of process units to be subdivided shall be less than 2 percent leaking valves, as detected according to paragraphs (b)(1) and (b)(2) of this section and as calculated according to paragraphs (c)(1)(ii) and (c)(2) of this section.

(ii) The initial assignment or subsequent reassignment of valves to subgroups shall be governed by the provisions of paragraphs (b)(4)(ii)(A) through (b)(4)(ii)(C) of this section.

(A) The owner or operator shall determine which valves are assigned to each subgroup. Valves with less than one year of monitoring data or valves not monitored within the last twelve months must be placed initially into the most frequently monitored subgroup until at least one year of monitoring data have been obtained.

(B) Any valve or group of valves can be reassigned from a less frequently monitored subgroup to a more frequently monitored subgroup provided that the valves to be reassigned were monitored during the most recent monitoring period for the less frequently monitored subgroup. The monitoring results must be included with that less frequently monitored subgroup's associated percent leaking valves calculation for that monitoring event.

(C) Any valve or group of valves can be reassigned from a more frequently monitored subgroup to a less frequently monitored subgroup provided that the valves to be reassigned have not leaked for the period of the less frequently monitored subgroup (e.g., for the last 12 months, if the valve or group of valves is to be reassigned to a subgroup being monitored annually). Nonrepairable valves may not be reassigned to a less frequently monitored subgroup.

(iii) The owner or operator shall determine every 6 months if the overall performance of total valves in the applicable process unit or group of process units is less than 2 percent leaking valves and so indicate the performance in the next Periodic Report. If the overall performance of total valves in the applicable process unit or group of process units is 2 percent leaking valves or greater, the owner or operator shall no longer subgroup and shall revert to the program required in paragraphs (b)(1) through (b)(3) of this section for that applicable process unit or group of process units. An owner or operator can again elect to comply with the valve subgrouping procedures of paragraph (b)(4) of this section if future overall performance of total valves in the process unit or group of process units is again less than 2 percent. The overall performance of total valves in the applicable process unit or group of process units shall be calculated as a weighted average of the percent leaking valves of each subgroup according to Equation number 1:

$$\%V_{LO} = \frac{\sum_{i=1}^n (\%V_{Li} \times V_i)}{\sum_{i=1}^n V_i} \quad [\text{Eq. 1}]$$

[View or download PDF](#)

where:

$\%V_{LO}$  = Overall performance of total valves in the applicable process unit or group of process units

$\%V_{Li}$  = Percent leaking valves in subgroup i, most recent value calculated according to the procedures in paragraphs (c)(1)(ii) and (c)(2) of this section.

$V_i$  = Number of valves in subgroup i.

n = Number of subgroups.

(iv) The owner or operator shall maintain records specified in paragraphs (b)(4)(iv)(A) through (b)(4)(iv)(D) of this section.

(A) Which valves are assigned to each subgroup,

(B) Monitoring results and calculations made for each subgroup for each monitoring period,

(C) Which valves are reassigned, the last monitoring result prior to reassignment, and when they were reassigned, and

(D) The results of the semiannual overall performance calculation required in paragraph (b)(4)(iii) of this section.

(v) The owner or operator shall notify the Administrator no later than 30 days prior to the beginning of the next monitoring period of the decision to subgroup valves. The notification shall identify the participating process units and the number of valves assigned to each subgroup, if applicable, and may be included in the next Periodic Report.

(vi) The owner or operator shall submit in the periodic reports the information specified in paragraphs (b)(4)(vi)(A) and (b)(4)(vi)(B).

(A) Total number of valves in each subgroup, and

(B) Results of the semiannual overall performance calculation required by paragraph (b)(4)(iii) of this section.

(vii) To determine the monitoring frequency for each subgroup, the calculation procedures of paragraph (c)(2) of this section shall be used.

(viii) Except for the overall performance calculations required by paragraphs (b)(4)(i) and (iii) of this section, each subgroup shall be treated as if it were a process unit for the purposes of applying the provisions of this section.

(c) *Percent leaking valves calculation—(1) Calculation basis and procedures.* (i) The owner or operator shall decide no later than the compliance date of this part or upon revision of an operating permit whether to calculate percent leaking valves on a process unit or group of process units basis. Once the owner or operator has decided, all subsequent percentage calculations shall be made on the same basis and this shall be the basis used for comparison with the subgrouping criteria specified in paragraph (b)(4)(i) of this section.

(ii) The percent leaking valves for each monitoring period for each process unit or valve subgroup, as provided in paragraph (b)(4) of this section, shall be calculated using the following equation:

$$\%V_L = (V_L/V_T) \times 100 \quad [\text{Eq. 2}]$$

[View or download PDF](#)

where:

$\%V_L$  = Percent leaking valves.

$V_L$  = Number of valves found leaking, excluding nonrepairable valves, as provided in paragraph (c)(3) of this section, and including those valves found leaking pursuant to paragraphs (d)(2)(iii)(A) and (d)(2)(iii)(B) of this section.

$V_T$  = The sum of the total number of valves monitored.

(2) *Calculation for monitoring frequency.* When determining monitoring frequency for each process unit or valve subgroup subject to monthly, quarterly, or semiannual monitoring frequencies, the percent leaking valves shall be the arithmetic average of the percent leaking valves from the last two monitoring periods. When determining monitoring frequency for each process unit or valve subgroup subject to

annual or biennial (once every 2 years) monitoring frequencies, the percent leaking valves shall be the arithmetic average of the percent leaking valves from the last three monitoring periods.

(3) *Nonrepairable valves.* (i) Nonrepairable valves shall be included in the calculation of percent leaking valves the first time the valve is identified as leaking and nonrepairable and as required to comply with paragraph (c)(3)(ii) of this section. Otherwise, a number of nonrepairable valves (identified and included in the percent leaking valves calculation in a previous period) up to a maximum of 1 percent of the total number of valves in regulated material service at a process unit or affected facility may be excluded from calculation of percent leaking valves for subsequent monitoring periods.

(ii) If the number of nonrepairable valves exceeds 1 percent of the total number of valves in regulated material service at a process unit or affected facility, the number of nonrepairable valves exceeding 1 percent of the total number of valves in regulated material service shall be included in the calculation of percent leaking valves.

(d) *Leak repair.* (1) If a leak is determined pursuant to paragraph (b), (e)(1), or (e)(2) of this section, then the leak shall be repaired using the procedures in §63.1024, as applicable.

(2) After a leak has been repaired, the valve shall be monitored at least once within the first 3 months after its repair. The monitoring required by this paragraph is in addition to the monitoring required to satisfy the definition of repaired and first attempt at repair.

(i) The monitoring shall be conducted as specified in §63.1023(b) and (c) of this section, as appropriate, to determine whether the valve has resumed leaking.

(ii) Periodic monitoring required by paragraph (b) of this section may be used to satisfy the requirements of this paragraph, if the timing of the monitoring period coincides with the time specified in this paragraph. Alternatively, other monitoring may be performed to satisfy the requirements of this paragraph, regardless of whether the timing of the monitoring period for periodic monitoring coincides with the time specified in this paragraph.

(iii) If a leak is detected by monitoring that is conducted pursuant to paragraph (d)(2) of this section, the owner or operator shall follow the provisions of paragraphs (d)(2)(iii)(A) and (d)(2)(iii)(B) of this section, to determine whether that valve must be counted as a leaking valve for purposes of paragraph (c)(1)(ii) of this section.

(A) If the owner or operator elected to use periodic monitoring required by paragraph (b) of this section to satisfy the requirements of paragraph (d)(2) of this section, then the valve shall be counted as a leaking valve.

(B) If the owner or operator elected to use other monitoring, prior to the periodic monitoring required by paragraph (b) of this section, to satisfy the requirements of paragraph (d)(2) of this section, then the valve shall be counted as a leaking valve unless it is repaired and shown by periodic monitoring not to be leaking.

(e) *Special provisions for valves—(1) Unsafe-to-monitor valves.* Any valve that is designated, as described in §63.1022(c)(1), as an unsafe-to-monitor valve is exempt from the requirements of paragraphs

(b) and (d)(2) of this section and the owner or operator shall monitor the valve according to the written plan specified in §63.1022(c)(4).

(2) *Difficult-to-monitor valves.* Any valve that is designated, as described in §63.1022(c)(2), as a difficult-to-monitor valve is exempt from the requirements of paragraph (b) of this section and the owner or operator shall monitor the valve according to the written plan specified in §63.1022(c)(4).

(3) *Fewer than 250 valves.* Any equipment located at a plant site with fewer than 250 valves in regulated material service is exempt from the requirements for monthly monitoring specified in paragraph (b)(3)(i) of this section. Instead, the owner or operator shall monitor each valve in regulated material service for leaks once each quarter, as provided in paragraphs (e)(1) and (e)(2) of this section.

[↑ Back to Top](#)

### **§63.1026 Pumps in light liquid service standards.**

(a) *Compliance schedule.* The owner or operator shall comply with this section no later than the compliance dates specified in the referencing subpart.

(b) *Leak detection.* Unless otherwise specified in §63.1021(b), §63.1036, §63.1037, or paragraph (e) of this section, the owner or operator shall monitor each pump to detect leaks and shall comply with all other provisions of this section.

(1) *Monitoring method and frequency.* The pumps shall be monitored monthly to detect leaks by the method specified in §63.1023(b) and, as applicable, §63.1023(c).

(2) *Instrument reading that defines a leak.* The instrument reading that defines a leak is specified in paragraphs (b)(2)(i) through (b)(2)(iii) of this section.

(i) 5,000 parts per million or greater for pumps handling polymerizing monomers;

(ii) 2,000 parts per million or greater for pumps in food/medical service; and

(iii) 1,000 parts per million or greater for all other pumps.

(3) *Leak repair exception.* For pumps to which a 1,000 parts per million leak definition applies, repair is not required unless an instrument reading of 2,000 parts per million or greater is detected.

(4) *Visual inspection.* Each pump shall be checked by visual inspection each calendar week for indications of liquids dripping from the pump seal. The owner or operator shall document that the inspection was conducted and the date of the inspection. If there are indications of liquids dripping from the pump seal at the time of the weekly inspection, the owner or operator shall follow the procedure specified in either paragraph (b)(4)(i) or (b)(4)(ii) of this section.

(i) The owner or operator shall monitor the pump as specified in §63.1023(b) and, as applicable, §63.1023(c). If the instrument reading indicates a leak as specified in paragraph (b)(2) of this section, a leak is detected and it shall be repaired using the procedures in §63.1024, except as specified in paragraph (b)(3) of this section; or

(ii) The owner or operator shall eliminate the visual indications of liquids dripping.

(c) *Percent leaking pumps calculation.* (1) The owner or operator shall decide no later than the compliance date of this part or upon revision of an operating permit whether to calculate percent leaking pumps on a process unit basis or group of process units basis. Once the owner or operator has decided, all subsequent percentage calculations shall be made on the same basis.

(2) If, when calculated on a 6-month rolling average, at least the greater of either 10 percent of the pumps in a process unit or three pumps in a process unit leak, the owner or operator shall implement a quality improvement program for pumps that complies with the requirements of §63.1035.

(3) The number of pumps at a process unit or affected facility shall be the sum of all the pumps in regulated material service, except that pumps found leaking in a continuous process unit or affected facility within 1 month after start-up of the pump shall not count in the percent leaking pumps calculation for that one monitoring period only.

(4) Percent leaking pumps shall be determined by the following equation:

$$\%P_L = \left( \frac{P_L - P_S}{P_T - P_S} \right) \times 100 \quad [Eq. 3]$$

[View or download PDF](#)

Where:

$\%P_L$  = Percent leaking pumps

$P_L$  = Number of pumps found leaking as determined through monthly monitoring as required in paragraph (b)(1) of this section. Do not include results from inspection of unsafe-to-monitor pumps pursuant to paragraph (e)(6) of this section.

$P_S$  = Number of pumps leaking within 1 month of start-up during the current monitoring period.

$P_T$  = Total pumps in regulated material service, including those meeting the criteria in paragraphs (e)(1), (e)(2), (e)(3), and (e)(6) of this section.

(d) *Leak repair.* If a leak is detected pursuant to paragraph (b) of this section, then the leak shall be repaired using the procedures in §63.1024, as applicable, unless otherwise specified in paragraph (b)(5) of this section for leaks identified by visual indications of liquids dripping.

(e) *Special provisions for pumps—(1) Dual mechanical seal pumps.* Each pump equipped with a dual mechanical seal system that includes a barrier fluid system is exempt from the requirements of paragraph (b) of this section, provided the requirements specified in paragraphs (e)(1)(i) through (e)(1)(viii) of this section are met.

(i) The owner or operator determines, based on design considerations and operating experience, criteria applicable to the presence and frequency of drips and to the sensor that indicates failure of the seal system, the barrier fluid system, or both. The owner or operator shall keep records at the plant of the

design criteria and an explanation of the design criteria; and any changes to these criteria and the reasons for the changes. This record must be available for review by an inspector.

(ii) Each dual mechanical seal system shall meet the requirements specified in paragraph (e)(1)(ii)(A), (e)(1)(ii)(B), or (e)(1)(ii)(C) of this section.

(A) Each dual mechanical seal system is operated with the barrier fluid at a pressure that is at all times (except periods of startup, shutdown, or malfunction) greater than the pump stuffing box pressure; or

(B) Equipped with a barrier fluid degassing reservoir that is routed to a process or fuel gas system or connected by a closed-vent system to a control device that complies with the requirements of either §63.1034 or §63.1021(b) of this part; or

(C) Equipped with a closed-loop system that purges the barrier fluid into a process stream.

(iii) The barrier fluid is not in light liquid service.

(iv) Each barrier fluid system is equipped with a sensor that will detect failure of the seal system, the barrier fluid system, or both.

(v) Each pump is checked by visual inspection each calendar week for indications of liquids dripping from the pump seal. The owner or operator shall document that the inspection was conducted and the date of the inspection. If there are indications of liquids dripping from the pump seal at the time of the weekly inspection, the owner or operator shall follow the procedure specified in paragraphs (e)(1)(v)(A) or (e)(1)(v)(B) of this section prior to the next required inspection.

(A) The owner or operator shall monitor the pump as specified in §63.1023(b) and, as applicable, §63.1023 (c), to determine if there is a leak of regulated material in the barrier fluid. If an instrument reading of 1,000 parts per million or greater is measured, a leak is detected and it shall be repaired using the procedures in §63.1024; or

(B) The owner or operator shall eliminate the visual indications of liquids dripping.

(vi) If indications of liquids dripping from the pump seal exceed the criteria established in paragraph (e)(1)(i) of this section, or if based on the criteria established in paragraph (e)(1)(i) of this section the sensor indicates failure of the seal system, the barrier fluid system, or both, a leak is detected.

(vii) Each sensor as described in paragraph (e)(1)(iv) of this section is observed daily or is equipped with an alarm unless the pump is located within the boundary of an unmanned plant site.

(viii) When a leak is detected pursuant to paragraph (e)(1)(vi) of this section, it shall be repaired as specified in §63.1024.

(2) *No external shaft.* Any pump that is designed with no externally actuated shaft penetrating the pump housing is exempt from the requirements of paragraph (b) of this section.

(3) *Routed to a process or fuel gas system or equipped with a closed vent system.* Any pump that is routed to a process or fuel gas system or equipped with a closed vent system capable of capturing and



transporting leakage from the pump to a control device meeting the requirements of §63.1034 of this part or §63.1021(b) is exempt from the requirements of paragraph (b) of this section.

(4) *Unmanned plant site.* Any pump that is located within the boundary of an unmanned plant site is exempt from the weekly visual inspection requirement of paragraphs (b)(4) and (e)(1)(v) of this section, and the daily requirements of paragraph (e)(1)(vii) of this section, provided that each pump is visually inspected as often as practical and at least monthly.

(5) *90 percent exemption.* If more than 90 percent of the pumps at a process unit or affected facility meet the criteria in either paragraph (e)(1) or (e)(2) of this section, the process unit or affected facility is exempt from the percent leaking calculation in paragraph (c) of this section.

(6) *Unsafe-to-monitor pumps.* Any pump that is designated, as described in §63.1022(c)(1), as an unsafe-to-monitor pump is exempt from the requirements of paragraph (b) of this section, the monitoring and inspection requirements of paragraphs (e)(1)(v) through (viii) of this section, and the owner or operator shall monitor and inspect the pump according to the written plan specified in §63.1022(c)(4).

[64 FR 34899, June 29, 1999, as amended at 64 FR 63706, Nov. 22, 1999]

[↑ Back to Top](#)

### **§63.1027 Connectors in gas and vapor service and in light liquid service standards.**

(a) *Compliance schedule.* The owner or operator shall monitor all connectors in each process unit initially for leaks by the later of either 12 months after the compliance date as specified in a referencing subpart or 12 months after initial startup. If all connectors in each process unit have been monitored for leaks prior to the compliance date specified in the referencing subpart, no initial monitoring is required provided either no process changes have been made since the monitoring or the owner or operator can determine that the results of the monitoring, with or without adjustments, reliably demonstrate compliance despite process changes. If required to monitor because of a process change, the owner or operator is required to monitor only those connectors involved in the process change.

(b) *Leak detection.* Except as allowed in §63.1021(b), §63.1036, §63.1037, or as specified in paragraph (e) of this section, the owner or operator shall monitor all connectors in gas and vapor and light liquid service as specified in paragraphs (a) and (b)(3) of this section.

(1) *Monitoring method.* The connectors shall be monitored to detect leaks by the method specified in §63.1023(b) and, as applicable, §63.1023(c).

(2) *Instrument reading that defines a leak.* If an instrument reading greater than or equal to 500 parts per million is measured, a leak is detected.

(3) *Monitoring periods.* The owner or operator shall perform monitoring, subsequent to the initial monitoring required in paragraph (a) of this section, as specified in paragraphs (b)(3)(i) through (b)(3)(iii) of this section, and shall comply with the requirements of paragraphs (b)(3)(iv) and (b)(3)(v) of this section. The required period in which monitoring must be conducted shall be determined from paragraphs

(b)(3)(i) through (b)(3)(iii) of this section using the monitoring results from the preceding monitoring period. The percent leaking connectors shall be calculated as specified in paragraph (c) of this section.

(i) If the percent leaking connectors in the process unit was greater than or equal to 0.5 percent, then monitor within 12 months (1 year).

(ii) If the percent leaking connectors in the process unit was greater than or equal to 0.25 percent but less than 0.5 percent, then monitor within 4 years. An owner or operator may comply with the requirements of this paragraph by monitoring at least 40 percent of the connectors within 2 years of the start of the monitoring period, provided all connectors have been monitored by the end of the 4 year monitoring period.

(iii) If the percent leaking connectors in the process unit was less than 0.25 percent, then monitor as provided in paragraph (b)(3)(iii)(A) of this section and either paragraph (b)(3)(iii)(B) or (b)(3)(iii)(C) of this section, as appropriate.

(A) An owner or operator shall monitor at least 50 percent of the connectors within 4 years of the start of the monitoring period.

(B) If the percent leaking connectors calculated from the monitoring results in paragraph (b)(3)(iii)(A) of this section is greater than or equal to 0.35 percent of the monitored connectors, the owner or operator shall monitor as soon as practical, but within the next 6 months, all connectors that have not yet been monitored during the monitoring period. At the conclusion of monitoring, a new monitoring period shall be started pursuant to paragraph (b)(3) of this section, based on the percent leaking connectors of the total monitored connectors.

(C) If the percent leaking connectors calculated from the monitoring results in paragraph (b)(3)(iii)(A) of this section is less than 0.35 percent of the monitored connectors, the owner or operator shall monitor all connectors that have not yet been monitored within 8 years of the start of the monitoring period.

(iv) If, during the monitoring conducted pursuant to paragraph (b)(3)(i) through (b)(3)(iii) of this section, a connector is found to be leaking, it shall be re-monitored once within 90 days after repair to confirm that it is not leaking.

(v) The owner or operator shall keep a record of the start date and end date of each monitoring period under this section for each process unit.

(c) *Percent leaking connectors calculation.* For use in determining the monitoring frequency, as specified in paragraphs (a) and (b)(3) of this section, the percent leaking connectors as used in paragraphs (a) and (b)(3) of this section shall be calculated by using equation number 4.

$$\%C_L = C_L/C_T \times 100 \quad [\text{Eq. 4}]$$

[View or download PDF](#)

Where:

$\%C_L$  = Percent leaking connectors as determined through periodic monitoring required in paragraphs (a) and (b)(3)(i) through (b)(3)(iii) of this section.

$C_L$  = Number of connectors measured at 500 parts per million or greater, by the method specified in §63.1023(b).

$C_t$  = Total number of monitored connectors in the process unit or affected facility.

(d) *Leak repair.* If a leak is detected pursuant to paragraphs (a) and (b) of this section, then the leak shall be repaired using the procedures in §63.1024, as applicable.

(e) *Special provisions for connectors—*(1) *Unsafe-to-monitor connectors.* Any connector that is designated, as described in §63.1022(c)(1), as an unsafe-to-monitor connector is exempt from the requirements of paragraphs (a) and (b) of this section and the owner or operator shall monitor according to the written plan specified in §63.1022(c)(4).

(2) *Inaccessible, ceramic, or ceramic-lined connectors.* (i) Any connector that is inaccessible or that is ceramic or ceramic-lined (e.g., porcelain, glass, or glass-lined), is exempt from the monitoring requirements of paragraphs (a) and (b) of this section, from the leak repair requirements of paragraph (d) of this section, and from the recordkeeping and reporting requirements of §§63.1038 and 63.1039. An inaccessible connector is one that meets any of the provisions specified in paragraphs (e)(2)(i)(A) through (e)(2)(i)(F) of this section, as applicable.

(A) Buried;

(B) Insulated in a manner that prevents access to the connector by a monitor probe;

(C) Obstructed by equipment or piping that prevents access to the connector by a monitor probe;

(D) Unable to be reached from a wheeled scissor-lift or hydraulic-type scaffold that would allow access to connectors up to 7.6 meters (25 feet) above the ground.

(E) Inaccessible because it would require elevating the monitoring personnel more than 2 meters (7 feet) above a permanent support surface or would require the erection of scaffold;

(F) Not able to be accessed at any time in a safe manner to perform monitoring. Unsafe access includes, but is not limited to, the use of a wheeled scissor-lift on unstable or uneven terrain, the use of a motorized man-lift basket in areas where an ignition potential exists, or access would require near proximity to hazards such as electrical lines, or would risk damage to equipment.

(ii) If any inaccessible, ceramic or ceramic-lined connector is observed by visual, audible, olfactory, or other means to be leaking, the visual, audible, olfactory, or other indications of a leak to the atmosphere shall be eliminated as soon as practical.

[↑ Back to Top](#)

**§63.1028 Agitators in gas and vapor service and in light liquid service standards.**

(a) *Compliance schedule.* The owner or operator shall comply with this section no later than the compliance dates specified in the referencing subpart.

(b) [Reserved]

(c) *Leak detection—(1) Monitoring method.* Each agitator seal shall be monitored monthly to detect leaks by the methods specified in §63.1023(b) and, as applicable, §63.1023(c), except as provided in §63.1021(b), §63.1036, §63.1037, or paragraph (e) of this section.

(2) *Instrument reading that defines a leak.* If an instrument reading equivalent of 10,000 parts per million or greater is measured, a leak is detected.

(3) *Visual inspection.* (i) Each agitator seal shall be checked by visual inspection each calendar week for indications of liquids dripping from the agitator seal. The owner or operator shall document that the inspection was conducted and the date of the inspection.

(ii) If there are indications of liquids dripping from the agitator seal, the owner or operator shall follow the procedures specified in paragraphs (c)(3)(ii)(A) or (c)(3)(ii)(B) of this section prior to the next required inspection.

(A) The owner or operator shall monitor the agitator seal as specified in §63.1023(b) and, as applicable, §63.1023(c), to determine if there is a leak of regulated material. If an instrument reading of 10,000 parts per million or greater is measured, a leak is detected, and it shall be repaired according to paragraph (d) of this section; or

(B) The owner or operator shall eliminate the indications of liquids dripping from the agitator seal.

(d) *Leak repair.* If a leak is detected, then the leak shall be repaired using the procedures in §63.1024.

(e) *Special provisions for agitators—(1) Dual mechanical seal.* Each agitator equipped with a dual mechanical seal system that includes a barrier fluid system is exempt from the requirements of paragraph (c) of this section, provided the requirements specified in paragraphs (e)(1)(i) through (e)(1)(vi) of this section are met.

(i) Each dual mechanical seal system shall meet the applicable requirements specified in paragraphs (e)(1)(i)(A), (e)(1)(i)(B), or (e)(1)(i)(C) of this section.

(A) Operated with the barrier fluid at a pressure that is at all times (except during periods of startup, shutdown, or malfunction) greater than the agitator stuffing box pressure; or

(B) Equipped with a barrier fluid degassing reservoir that is routed to a process or fuel gas system or connected by a closed-vent system to a control device that meets the requirements of either §63.1034 or §63.1021(b); or

(C) Equipped with a closed-loop system that purges the barrier fluid into a process stream.

(ii) The barrier fluid is not in light liquid service.

(iii) Each barrier fluid system is equipped with a sensor that will detect failure of the seal system, the barrier fluid system, or both.

(iv) Each agitator seal is checked by visual inspection each calendar week for indications of liquids dripping from the agitator seal. If there are indications of liquids dripping from the agitator seal at the time of the weekly inspection, the owner or operator shall follow the procedure specified in paragraphs (e)(1)(iv)(A) or (e)(1)(iv)(B) of this section prior to the next required inspection.

(A) The owner or operator shall monitor the agitator seal as specified in §63.1023(b) and, as applicable, §63.1023(c), to determine the presence of regulated material in the barrier fluid. If an instrument reading equivalent to or greater than 10,000 ppm is measured, a leak is detected and it shall be repaired using the procedures in §63.1024, or

(B) The owner or operator shall eliminate the visual indications of liquids dripping.

(v) Each sensor as described in paragraph (e)(1)(iii) of this section is observed daily or is equipped with an alarm unless the agitator seal is located within the boundary of an unmanned plant site.

(vi) The owner or operator of each dual mechanical seal system shall meet the requirements specified in paragraphs (e)(1)(vi)(A) and (e)(1)(vi)(B).

(A) The owner or operator shall determine, based on design considerations and operating experience, criteria that indicates failure of the seal system, the barrier fluid system, or both and applicable to the presence and frequency of drips. If indications of liquids dripping from the agitator seal exceed the criteria, or if, based on the criteria the sensor indicates failure of the seal system, the barrier fluid system, or both, a leak is detected and shall be repaired pursuant to §63.1024, as applicable.

(B) The owner or operator shall keep records of the design criteria and an explanation of the design criteria; and any changes to these criteria and the reasons for the changes.

(2) *No external shaft.* Any agitator that is designed with no externally actuated shaft penetrating the agitator housing is exempt from paragraph (c) of this section.

(3) *Routed to a process or fuel gas system or equipped with a closed vent system.* Any agitator that is routed to a process or fuel gas system that captures and transports leakage from the agitator to a control device meeting the requirements of either §63.1034 or §63.1021(b) is exempt from the requirements of paragraph (c) of this section.

(4) *Unmanned plant site.* Any agitator that is located within the boundary of an unmanned plant site is exempt from the weekly visual inspection requirement of paragraphs (c)(3) and (e)(1)(iv) of this section, and the daily requirements of paragraph (e)(1)(v) of this section, provided that each agitator is visually inspected as often as practical and at least monthly.

(5) *Difficult-to-monitor agitator seals.* Any agitator seal that is designated, as described in §63.1022(c)(2), as a difficult-to-monitor agitator seal is exempt from the requirements of paragraph (c) of this section and the owner or operator shall monitor the agitator seal according to the written plan specified in §63.1022(c)(4).

(6) *Equipment obstructions.* Any agitator seal that is obstructed by equipment or piping that prevents access to the agitator by a monitor probe is exempt from the monitoring requirements of paragraph (c) of this section.

(7) *Unsafe-to-monitor agitator seals.* Any agitator seal that is designated, as described in §63.1022(c)(1), as an unsafe-to-monitor agitator seal is exempt from the requirements of paragraph (c) of this section and the owner or operator of the agitator seal monitors the agitator seal according to the written plan specified in §63.1022(c)(4).

[↑ Back to Top](#)

### **§63.1029 Pumps, valves, connectors, and agitators in heavy liquid service; pressure relief devices in liquid service; and instrumentation systems standards.**

(a) *Compliance schedule.* The owner or operator shall comply with this section no later than the compliance dates specified in the referencing subpart.

(b) *Leak detection—(1) Monitoring method.* Unless otherwise specified in §63.1021(b), §63.1036, or §63.1037, the owner or operator shall comply with paragraphs (b)(1) and (b)(2) of this section. Pumps, valves, connectors, and agitators in heavy liquid service; pressure relief devices in light liquid or heavy liquid service; and instrumentation systems shall be monitored within 5 calendar days by the method specified in §63.1023(b) and, as applicable, §63.1023(c), if evidence of a potential leak to the atmosphere is found by visual, audible, olfactory, or any other detection method, unless the potential leak is repaired as required in paragraph (c) of this section.

(2) *Instrument reading that defines a leak.* If an instrument reading of 10,000 parts per million or greater for agitators, 5,000 parts per million or greater for pumps handling polymerizing monomers, 2,000 parts per million or greater for pumps in food and medical service, or 2,000 parts per million or greater for all other pumps (including pumps in food/medical service), or 500 parts per million or greater for valves, connectors, instrumentation systems, and pressure relief devices is measured pursuant to paragraph (b)(1) of this section, a leak is detected and shall be repaired pursuant to §63.1024, as applicable.

(c) *Leak repair.* For equipment identified in paragraph (b) of this section that is not monitored by the method specified in §63.1023(b) and, as applicable, §63.1023(c), repaired shall mean that the visual, audible, olfactory, or other indications of a leak to the atmosphere have been eliminated; that no bubbles are observed at potential leak sites during a leak check using soap solution; or that the system will hold a test pressure.

[64 FR 34899, June 29, 1999, as amended at 64 FR 63706, Nov. 22, 1999]

[↑ Back to Top](#)

### **§63.1030 Pressure relief devices in gas and vapor service standards.**

(a) *Compliance schedule.* The owner or operator shall comply with this section no later than the compliance dates specified in the referencing subpart.

(b) *Compliance standard.* Except during pressure releases as provided for in paragraph (c) of this section, or as otherwise specified in §§63.1036, 63.1037, or paragraphs (d) and (e) of this section, each pressure relief device in gas and vapor service shall be operated with an instrument reading of less than 500 parts per million as measured by the method specified in §63.1023(b) and, as applicable, §63.1023(c).

(c) *Pressure relief requirements.* (1) After each pressure release, the pressure relief device shall be returned to a condition indicated by an instrument reading of less than 500 parts per million, as soon as practical, but no later than 5 calendar days after each pressure release, except as provided in §63.1024(d).

(2) The pressure relief device shall be monitored no later than five calendar days after the pressure to confirm the condition indicated by an instrument reading of less than 500 parts per million above background, as measured by the method specified in §63.1023(b) and, as applicable, §63.1023(c).

(3) The owner or operator shall record the dates and results of the monitoring required by paragraph (c)(2) of this section following a pressure release including the background level measured and the maximum instrument reading measured during the monitoring.

(d) *Pressure relief devices routed to a process or fuel gas system or equipped with a closed vent system and control device.* Any pressure relief device that is routed to a process or fuel gas system or equipped with a closed vent system capable of capturing and transporting leakage from the pressure relief device to a control device meeting the requirements of §63.1034 is exempt from the requirements of paragraphs (b) and (c) of this section.

(e) *Rupture disk exemption.* Any pressure relief device that is equipped with a rupture disk upstream of the pressure relief device is exempt from the requirements of paragraphs (b) and (c) of this section provided the owner or operator installs a replacement rupture disk upstream of the pressure relief device as soon as practical after each pressure release but no later than 5 calendar days after each pressure release, except as provided in §63.1024(d).

[↑ Back to Top](#)

### **§63.1031 Compressors standards.**

(a) *Compliance schedule.* The owner or operator shall comply with this section no later than the compliance dates specified in the referencing subpart.

(b) *Seal system standard.* Each compressor shall be equipped with a seal system that includes a barrier fluid system and that prevents leakage of process fluid to the atmosphere, except as provided in §§63.1021(b), 63.1036, 63.1037, and paragraphs (e) and (f) of this section. Each compressor seal system shall meet the applicable requirements specified in paragraph (b)(1), (b)(2), or (b)(3) of this section.

(1) Operated with the barrier fluid at a pressure that is greater than the compressor stuffing box pressure at all times (except during periods of startup, shutdown, or malfunction); or

(2) Equipped with a barrier fluid system degassing reservoir that is routed to a process or fuel gas system or connected by a closed-vent system to a control device that meets the requirements of either §63.1034 or §63.1021(b); or

(3) Equipped with a closed-loop system that purges the barrier fluid directly into a process stream.

(c) *Barrier fluid system.* The barrier fluid shall not be in light liquid service. Each barrier fluid system shall be equipped with a sensor that will detect failure of the seal system, barrier fluid system, or both. Each sensor shall be observed daily or shall be equipped with an alarm unless the compressor is located within the boundary of an unmanned plant site.

(d) *Failure criterion and leak detection.* (1) The owner or operator shall determine, based on design considerations and operating experience, a criterion that indicates failure of the seal system, the barrier fluid system, or both. If the sensor indicates failure of the seal system, the barrier fluid system, or both based on the criterion, a leak is detected and shall be repaired pursuant to §63.1024, as applicable.

(2) The owner or operator shall keep records of the design criteria and an explanation of the design criteria; and any changes to these criteria and the reasons for the changes.

(e) *Routed to a process or fuel gas system or equipped with a closed vent system.* A compressor is exempt from the requirements of paragraphs (b) through (d) of this section if it is equipped with a system to capture and transport leakage from the compressor drive shaft seal to a process or a fuel gas system or to a closed vent system that captures and transports leakage from the compressor to a control device meeting the requirements of either §63.1034 or §63.1021(b).

(f) *Alternative compressor standard.* (1) Any compressor that is designated, as described in §63.1022(e), as operating with an instrument reading of less than 500 parts per million above background shall operate at all times with an instrument reading of less than 500 parts per million. A compressor so designated is exempt from the requirements of paragraphs (b) through (d) of this section if the compressor is demonstrated, initially upon designation, annually, and at other times requested by the Administrator to be operating with an instrument reading of less than 500 parts per million above background, as measured by the method specified in §63.1023(b) and, as applicable, §63.1023(c).

(2) The owner or operator shall record the dates and results of each compliance test including the background level measured and the maximum instrument reading measured during each compliance test.

[↑ Back to Top](#)

### **§63.1032 Sampling connection systems standards.**

(a) *Compliance schedule.* The owner or operator shall comply with this section no later than the compliance dates specified in the referencing subpart.

(b) *Equipment requirement.* Each sampling connection system shall be equipped with a closed-purge, closed-loop, or closed vent system, except as provided in §§63.1021(b), 63.1036, 63.1037, or paragraph (d) of this section. Gases displaced during filling of the sample container are not required to be collected or captured.

(c) *Equipment design and operation.* Each closed-purge, closed-loop, or closed vent system as required in paragraph (b) of this section shall meet the applicable requirements specified in paragraphs (c)(1) through (c)(5) of this section.



(1) The system shall return the purged process fluid directly to a process line or to a fuel gas system that meets the requirements of either §63.1034 or §63.1021(b); or

(2) [Reserved]

(3) Be designed and operated to capture and transport all the purged process fluid to a control device that meets the requirements of either §63.1034 or §63.1021(b); or

(4) Collect, store, and transport the purged process fluid to a system or facility identified in paragraph (c)(4)(i), (c)(4)(ii), or (c)(4)(iii) of this section.

(i) A waste management unit as defined in 40 CFR 63.111 or subpart G, if the waste management unit is subject to and operating in compliance with the provisions of 40 CFR part 63, subpart G, applicable to group 1 wastewater streams. If the purged process fluid does not contain any regulated material listed in Table 9 of 40 CFR part 63, subpart G, the waste management unit need not be subject to, and operated in compliance with the requirements of 40 CFR part 63, subpart G, applicable to group 1 wastewater streams provided the facility has a National Pollution Discharge Elimination System (NPDES) permit or sends the wastewater to an NPDES-permitted facility.

(ii) A treatment, storage, or disposal facility subject to regulation under 40 CFR parts 262, 264, 265, or 266; or

(iii) A facility permitted, licensed, or registered by a State to manage municipal or industrial solid waste, if the process fluids are not hazardous waste as defined in 40 CFR part 261.

(5) Containers that are part of a closed purge system must be covered or closed when not being filled or emptied.

(d) *In-situ sampling systems.* In-situ sampling systems and sampling systems without purges are exempt from the requirements of paragraphs (b) and (c) of this section.

[↑ Back to Top](#)

### **§63.1033 Open-ended valves or lines standards.**

(a) *Compliance schedule.* The owner or operator shall comply with this section no later than the compliance date specified in the referencing subpart.

(b) *Equipment and operational requirements.* (1) Each open-ended valve or line shall be equipped with a cap, blind flange, plug, or a second valve, except as provided in §§63.1021(b), 63.1036, 63.1037, and paragraphs (c) and (d) of this section. The cap, blind flange, plug, or second valve shall seal the open end at all times except during operations requiring process fluid flow through the open-ended valve or line, or during maintenance. The operational provisions of paragraphs (b)(2) and (b)(3) of this section also apply.

(2) Each open-ended valve or line equipped with a second valve shall be operated in a manner such that the valve on the process fluid end is closed before the second valve is closed.

(3) When a double block and bleed system is being used, the bleed valve or line may remain open during operations that require venting the line between the block valves but shall comply with paragraph (b)(1) of this section at all other times.

(c) *Emergency shutdown exemption.* Open-ended valves or lines in an emergency shutdown system that are designed to open automatically in the event of a process upset are exempt from the requirements of paragraph (b) of this section.

(d) *Polymerizing materials exemption.* Open-ended valves or lines containing materials that would autocatalytically polymerize or, would present an explosion, serious overpressure, or other safety hazard if capped or equipped with a double block and bleed system as specified in paragraph (b) of this section are exempt from the requirements of paragraph (b) of this section.

[↑ Back to Top](#)

#### **§63.1034 Closed vent systems and control devices; or emissions routed to a fuel gas system or process standards.**

(a) *Compliance schedule.* The owner or operator shall comply with this section no later than the compliance date specified in the referencing subpart.

(b) *Compliance standard.* (1) Owners or operators routing emissions from equipment leaks to a fuel gas system or process shall comply with the provisions of subpart SS of this part, except as provided in §63.1002(b).

(2) Owners or operators of closed vent systems and control devices used to comply with the provisions of this subpart shall comply with the provisions of subpart SS of this part and (b)(2)(i) through (b)(2)(iii) of this section, except as provided in §63.1002(b).

(i) Nonflare control devices shall be designed and operated to reduce emissions of regulated material vented to them with an efficiency of 95 percent or greater, or to an exit concentration of 20 parts per million by volume, whichever is less stringent. The 20 parts per million by volume standard is not applicable to the provisions of §63.1016.

(ii) Enclosed combustion devices shall be designed and operated to reduce emissions of regulated material vented to them with an efficiency of 95 percent or greater, or to an exit concentration of 20 parts per million by volume, on a dry basis, corrected to 3 percent oxygen, whichever is less stringent, or to provide a minimum residence time of 0.50 seconds at a minimum temperature of 760 °C (1400 °F).

(iii) Flares used to comply with the provisions of this subpart shall comply with the requirements of subpart SS of this part.

[↑ Back to Top](#)

#### **§63.1035 Quality improvement program for pumps.**

(a) *Criteria.* If, on a 6-month rolling average, at least the greater of either 10 percent of the pumps in a process unit or affected facility (or plant site) or three pumps in a process unit or affected facility (or plant

site) leak, the owner or operator shall comply with the requirements specified in paragraphs (a)(1) and (a)(2) of this section.

(1) Pumps that are in food and medical service or in polymerizing monomer service shall comply with all requirements except for those specified in paragraph (d)(8) of this section.

(2) Pumps that are not in food and medical or polymerizing monomer service shall comply with all of the requirements of this section.

(b) *Exiting the QIP.* The owner or operator shall comply with the requirements of this section until the number of leaking pumps is less than the greater of either 10 percent of the pumps or three pumps, calculated as a 6-month rolling average, in the process unit or affected facility (or plant site). Once the performance level is achieved, the owner or operator shall comply with the requirements in §63.1026.

(c) *Resumption of QIP.* If, in a subsequent monitoring period, the process unit or affected facility (or plant site) has greater than either 10 percent of the pumps leaking or three pumps leaking (calculated as a 6-month rolling average), the owner or operator shall resume the quality improvement program starting at performance trials.

(d) *QIP requirements.* The quality improvement program shall meet the requirements specified in paragraphs (d)(1) through (d)(8) of this section.

(1) The owner or operator shall comply with the requirements in §63.1026.

(2) *Data collection.* The owner or operator shall collect the data specified in paragraphs (d)(2)(i) through (d)(2)(v) of this section and maintain records for each pump in each process unit or affected facility (or plant site) subject to the quality improvement program. The data may be collected and the records may be maintained on a process unit, affected facility, or plant site basis.

(i) Pump type (e.g., piston, horizontal or vertical centrifugal, gear, bellows); pump manufacturer; seal type and manufacturer; pump design (e.g., external shaft, flanged body); materials of construction; if applicable, barrier fluid or packing material; and year installed.

(ii) Service characteristics of the stream such as discharge pressure, temperature, flow rate, corrosivity, and annual operating hours.

(iii) The maximum instrument readings observed in each monitoring observation before repair, response factor for the stream if appropriate, instrument model number, and date of the observation.

(iv) If a leak is detected, the repair methods used and the instrument readings after repair.

(v) If the data will be analyzed as part of a larger analysis program involving data from other plants or other types of process units or affected facilities, a description of any maintenance or quality assurance programs used in the process unit or affected facility that are intended to improve emission performance.

(3) The owner or operator shall continue to collect data on the pumps as long as the process unit or affected facility (or plant site) remains in the quality improvement program.

(4) *Pump or pump seal inspection.* The owner or operator shall inspect all pumps or pump seals that exhibited frequent seal failures and were removed from the process unit or affected facility due to leaks. The inspection shall determine the probable cause of the pump seal failure or of the pump leak and shall include recommendations, as appropriate, for design changes or changes in specifications to reduce leak potential.

(5)(i) *Data analysis.* The owner or operator shall analyze the data collected to comply with the requirements of paragraph (d)(2) of this section to determine the services, operating or maintenance practices, and pump or pump seal designs or technologies that have poorer than average emission performance and those that have better than average emission performance. The analysis shall determine if specific trouble areas can be identified on the basis of service, operating conditions or maintenance practices, equipment design, or other process-specific factors.

(ii) The analysis shall also be used to determine if there are superior performing pump or pump seal technologies that are applicable to the service(s), operating conditions, or pump or pump seal designs associated with poorer than average emission performance. A superior performing pump or pump seal technology is one with a leak frequency of less than 10 percent for specific applications in the process unit, affected facility, or plant site. A candidate superior performing pump or pump seal technology is one demonstrated or reported in the available literature or through a group study as having low emission performance and as being capable of achieving less than 10 percent leaking pumps in the process unit or affected facility (or plant site).

(iii) The analysis shall include consideration of the information specified in paragraphs (d)(5)(iii)(A) through (d)(5)(iii)(C) of this section.

(A) The data obtained from the inspections of pumps and pump seals removed from the process unit or affected facility due to leaks;

(B) Information from the available literature and from the experience of other plant sites that will identify pump designs or technologies and operating conditions associated with low emission performance for specific services; and

(C) Information on limitations on the service conditions for the pump seal technology operating conditions as well as information on maintenance procedures to ensure continued low emission performance.

(iv) The data analysis may be conducted through an inter- or intra-company program (or through some combination of the two approaches) and may be for a single process unit, a plant site, a company, or a group of process units.

(v) The first analysis of the data shall be completed no later than 18 months after the start of the quality improvement program. The first analysis shall be performed using data collected for a minimum of 6 months. An analysis of the data shall be done each year the process unit or affected facility is in the quality improvement program.

(6) *Trial evaluation program.* A trial evaluation program shall be conducted at each plant site for which the data analysis does not identify use of superior performing pump seal technology or pumps that can be

applied to the areas identified as having poorer than average performance, except as provided in paragraph (d)(6)(v) of this section. The trial program shall be used to evaluate the feasibility of using in the process unit or affected facility (or plant site) the pump designs or seal technologies, and operating and maintenance practices that have been identified by others as having low emission performance.

(i) The trial evaluation program shall include on-line trials of pump seal technologies or pump designs and operating and maintenance practices that have been identified in the available literature or in analysis by others as having the ability to perform with leak rates below 10 percent in similar services, as having low probability of failure, or as having no external actuating mechanism in contact with the process fluid. If any of the candidate superior performing pump seal technologies or pumps is not included in the performance trials, the reasons for rejecting specific technologies from consideration shall be documented as required in paragraph (e)(3)(ii) of this section.

(ii) The number of pump seal technologies or pumps in the trial evaluation program shall be the lesser of 1 percent or two pumps for programs involving single process units or affected facilities and the lesser of 1 percent or five pumps for programs involving a plant site or groups of process units or affected facilities. The minimum number of pumps or pump seal technologies in a trial program shall be one.

(iii) The trial evaluation program shall specify and include documentation of the information specified in paragraphs (d)(6)(iii)(A) through (d)(6)(iii)(D) of this section.

(A) The candidate superior performing pump seal designs or technologies to be evaluated, the stages for evaluating the identified candidate pump designs or pump seal technologies, including the time period necessary to test the applicability;

(B) The frequency of monitoring or inspection of the equipment;

(C) The range of operating conditions over which the component will be evaluated; and

(D) Conclusions regarding the emission performance and the appropriate operating conditions and services for the trial pump seal technologies or pumps.

(iv) The performance trials shall initially be conducted, at least, for a 6-month period beginning not later than 18 months after the start of the quality improvement program. No later than 24 months after the start of the quality improvement program, the owner or operator shall have identified pump seal technologies or pump designs that, combined with appropriate process, operating, and maintenance practices, operate with low emission performance for specific applications in the process unit or affected facility. The owner or operator shall continue to conduct performance trials as long as no superior performing design or technology has been identified, except as provided in paragraph (d)(6)(vi) of this section. The initial list of superior emission performance pump designs or pump seal technologies shall be amended in the future, as appropriate, as additional information and experience are obtained.

(v) Any plant site with fewer than 400 valves and owned by a corporation with fewer than 100 employees shall be exempt from trial evaluations of pump seals or pump designs. Plant sites exempt from the trial evaluations of pumps shall begin the pump seal or pump replacement program at the start of the fourth year of the quality improvement program.

(vi) An owner or operator who has conducted performance trials on all alternative superior emission performance technologies suitable for the required applications in the process unit or affected facility may stop conducting performance trials provided that a superior performing design or technology has been demonstrated or there are no technically feasible alternative superior technologies remaining. The owner or operator shall prepare an engineering evaluation documenting the physical, chemical, or engineering basis for the judgment that the superior emission performance technology is technically infeasible or demonstrating that it would not reduce emissions.

(7) *Quality assurance program.* Each owner or operator shall prepare and implement a pump quality assurance program that details purchasing specifications and maintenance procedures for all pumps and pump seals in the process unit or affected facility. The quality assurance program may establish any number of categories, or classes, of pumps as needed to distinguish among operating conditions and services associated with poorer than average emission performance as well as those associated with better than average emission performance. The quality assurance program shall be developed considering the findings of the data analysis required under paragraph (d)(5) of this section; and, if applicable, the findings of the trial evaluation required in paragraph (d)(6) of this section; and the operating conditions in the process unit or affected facility. The quality assurance program shall be updated each year as long as the process unit or affected facility has the greater of either 10 percent or more leaking pumps or has three leaking pumps.

(i) The quality assurance program shall meet the requirements specified in paragraphs (d)(7)(i)(A) through (d)(7)(i)(D) of this section.

(A) Establish minimum design standards for each category of pumps or pump seal technology. The design standards shall specify known critical parameters such as tolerance, manufacturer, materials of construction, previous usage, or other applicable identified critical parameters;

(B) Require that all equipment orders specify the design standard (or minimum tolerances) for the pump or the pump seal;

(C) Provide for an audit procedure for quality control of purchased equipment to ensure conformance with purchase specifications. The audit program may be conducted by the owner or operator of the plant site or process unit or affected facility, or by a designated representative; and

(D) Detail off-line pump maintenance and repair procedures. These procedures shall include provisions to ensure that rebuilt or refurbished pumps and pump seals will meet the design specifications for the pump category and will operate so that emissions are minimized.

(ii) The quality assurance program shall be established no later than the start of the third year of the quality improvement program for plant sites with 400 or more valves or 100 or more employees; and no later than the start of the fourth year of the quality improvement program for plant sites with less than 400 valves and less than 100 employees.

(8) *Pump or pump seal replacement.* Three years after the start of the quality improvement program for plant sites with 400 or more valves or 100 or more employees and at the start of the fourth year of the quality improvement program for plant sites with less than 400 valves and less than 100 employees, the owner or operator shall replace, as described in paragraphs (d)(8)(i) and (d)(8)(ii) of this section, the

pumps or pump seals that are not superior emission performance technology with pumps or pump seals that have been identified as superior emission performance technology and that comply with the quality assurance standards for the pump category. Superior emission performance technology is that category or design of pumps or pump seals with emission performance that when combined with appropriate process, operating, and maintenance practices, will result in less than 10 percent leaking pumps for specific applications in the process unit, affected facility, or plant site. Superior emission performance technology includes material or design changes to the existing pump, pump seal, seal support system, installation of multiple mechanical seals or equivalent, or pump replacement.

(i) Pumps or pump seals shall be replaced at the rate of 20 percent per year based on the total number of pumps in light liquid service. The calculated value shall be rounded to the nearest nonzero integer value. The minimum number of pumps or pump seals shall be one. Pump replacement shall continue until all pumps subject to the requirements of §63.1026 are pumps determined to be superior performance technology.

(ii) The owner or operator may delay replacement of pump seals or pumps with superior technology until the next planned process unit or affected facility shutdown, provided the number of pump seals and pumps replaced is equivalent to the 20 percent or greater annual replacement rate.

(iii) The pumps shall be maintained as specified in the quality assurance program.

(e) *QIP recordkeeping*. In addition to the records required by paragraph (d)(2) of this section, the owner or operator shall maintain records for the period of the quality improvement program for the process unit or affected facility as specified in paragraphs (e)(1) through (e)(6) of this section.

(1) When using a pump quality improvement program as specified in this section, record the information specified in paragraphs (e)(1)(i) through (e)(1)(iii) of this section.

(i) The rolling average percent leaking pumps.

(ii) Documentation of all inspections conducted under the requirements of paragraph (d)(4) of this section, and any recommendations for design or specification changes to reduce leak frequency.

(iii) The beginning and ending dates while meeting the requirements of paragraph (d) of this section.

(2) If a leak is not repaired within 15 calendar days after discovery of the leak, the reason for the delay and the expected date of successful repair.

(3) Records of all analyses required in paragraph (d) of this section. The records will include the information specified in paragraphs (e)(3)(i) through (e)(3)(iv) of this section.

(i) A list identifying areas associated with poorer than average performance and the associated service characteristics of the stream, the operating conditions and maintenance practices.

(ii) The reasons for rejecting specific candidate superior emission performing pump technology from performance trials.

(iii) The list of candidate superior emission performing valve or pump technologies, and documentation of the performance trial program items required under paragraph (d)(6)(iii) of this section.

(iv) The beginning date and duration of performance trials of each candidate superior emission performing technology.

(4) All records documenting the quality assurance program for pumps as specified in paragraph (d)(7) of this section, including records indicating that all pumps replaced or modified during the period of the quality improvement program are in compliance with the quality assurance.

(5) Records documenting compliance with the 20 percent or greater annual replacement rate for pumps as specified in paragraph (d)(8) of this section.

(6) Information and data to show the corporation has fewer than 100 employees, including employees providing professional and technical contracted services.

[↑ Back to Top](#)

### **§63.1036 Alternative means of emission limitation: Batch processes.**

(a) *General requirement.* As an alternative to complying with the requirements of §§63.1025 through 63.1033 and §63.1035, an owner or operator of a batch process that operates in regulated material service during the calendar year may comply with one of the standards specified in paragraphs (b) and (c) of this section, or the owner or operator may petition for approval of an alternative standard under the provisions of §63.1021(b). The alternative standards of this section provide the options of pressure testing or monitoring the equipment for leaks. The owner or operator may switch among the alternatives provided the change is documented as specified in paragraph (b)(7) of this section.

(b) *Pressure testing of the batch equipment.* The following requirements shall be met if an owner or operator elects to use pressure testing of batch product-process equipment to demonstrate compliance with this subpart.

(1) *Reconfiguration.* Each time equipment is reconfigured for production of a different product or intermediate, the batch product-process equipment train shall be pressure-tested for leaks before regulated material is first fed to the equipment and the equipment is placed in regulated material service.

(i) When the batch product-process equipment train is reconfigured to produce a different product, pressure testing is required only for the new or disturbed equipment.

(ii) Each batch product process that operates in regulated material service during a calendar year shall be pressure-tested at least once during that calendar year.

(iii) Pressure testing is not required for routine seal breaks, such as changing hoses or filters, that are not part of the reconfiguration to produce a different product or intermediate.

(2) *Testing procedures.* The batch product process equipment shall be tested either using the procedures specified in paragraph (b)(5) of this section for pressure vacuum loss or with a liquid using the procedures specified in paragraph (b)(6) of this section.



(3) *Leak detection.* (i) For pressure or vacuum tests using a gas, a leak is detected if the rate of change in pressure is greater than 6.9 kilopascals (1 pound per square inch gauge) in 1 hour or if there is visible, audible, or olfactory evidence of fluid loss.

(ii) For pressure tests using a liquid, a leak is detected if there are indications of liquids dripping or if there is other evidence of fluid loss.

(4) *Leak repair.* (i) If a leak is detected, it shall be repaired and the batch product-process equipment shall be retested before start-up of the process.

(ii) If a batch product-process fails the retest (the second of two consecutive pressure tests), it shall be repaired as soon as practical, but not later than 30 calendar days after the second pressure test except as specified in paragraph (e) of this section.

(5) *Gas pressure test procedure for pressure or vacuum loss.* The procedures specified in paragraphs (b)(5)(i) through (b)(5)(v) of this section shall be used to pressure test batch product-process equipment for pressure or vacuum loss to demonstrate compliance with the requirements of paragraph (b)(3)(i) of this section.

(i) The batch product-process equipment train shall be pressurized with a gas to a pressure less than the set pressure of any safety relief devices or valves or to a pressure slightly above the operating pressure of the equipment, or alternatively the equipment shall be placed under a vacuum.

(ii) Once the test pressure is obtained, the gas source or vacuum source shall be shut off.

(iii) The test shall continue for not less than 15 minutes unless it can be determined in a shorter period of time that the allowable rate of pressure drop or of pressure rise was exceeded. The pressure in the batch product-process equipment shall be measured after the gas or vacuum source is shut off and at the end of the test period. The rate of change in pressure in the batch product-process equipment shall be calculated using the following equation:

$$\Delta(P/t) = \left( |P_f - P_i| \right) / (t_f - t_i) \quad [Eq. 5]$$

[View or download PDF](#)

Where:

$\Delta(P/t)$  = Change in pressure, pounds per square inch gauge per hour.

$P_f$  = Final pressure, pounds per square inch gauge.

$P_i$  = Initial pressure, pounds per square inch gauge.

$t_f - t_i$  = Elapsed time, hours.

(iv) The pressure shall be measured using a pressure measurement device (gauge, manometer, or equivalent) that has a precision of  $\pm 2.5$  millimeter mercury (0.10 inch of mercury) in the range of test pressure and is capable of measuring pressures up to the relief set pressure of the pressure relief device. If

such a pressure measurement device is not reasonably available, the owner or operator shall use a pressure measurement device with a precision of at least  $\pm 10$  percent of the test pressure of the equipment and shall extend the duration of the test for the time necessary to detect a pressure loss or rise that equals a rate of 1 pound per square inch gauge per hour (7 kilopascals per hour).

(v) An alternative procedure may be used for leak testing the equipment if the owner or operator demonstrates the alternative procedure is capable of detecting a pressure loss or rise.

(6) *Pressure test procedure using test liquid.* The procedures specified in paragraphs (b)(6)(i) through (b)(6)(iv) of this section shall be used to pressure-test batch product-process equipment using a liquid to demonstrate compliance with the requirements of paragraph (b)(3)(ii) of this section.

(i) The batch product-process equipment train, or section of the equipment train, shall be filled with the test liquid (e.g., water, alcohol) until normal operating pressure is obtained. Once the equipment is filled, the liquid source shall be shut off.

(ii) The test shall be conducted for a period of at least 60 minutes, unless it can be determined in a shorter period of time that the test is a failure.

(iii) Each seal in the equipment being tested shall be inspected for indications of liquid dripping or other indications of fluid loss. If there are any indications of liquids dripping or of fluid loss, a leak is detected.

(iv) An alternative procedure may be used for leak testing the equipment, if the owner or operator demonstrates the alternative procedure is capable of detecting losses of fluid.

(7) *Pressure testing recordkeeping.* The owner or operator of a batch product process who elects to pressure test the batch product process equipment train to demonstrate compliance with this subpart shall maintain records of the information specified in paragraphs (b)(7)(i) through (b)(7)(v) of this section.

(i) The identification of each product, or product code, produced during the calendar year. It is not necessary to identify individual items of equipment in a batch product process equipment train.

(ii) Physical tagging of the equipment to identify that it is in regulated material service and subject to the provisions of this subpart is not required. Equipment in a batch product process subject to the provisions of this subpart may be identified on a plant site plan, in log entries, or by other appropriate methods.

(iii) The dates of each pressure test required in paragraph (b) of this section, the test pressure, and the pressure drop observed during the test.

(iv) Records of any visible, audible, or olfactory evidence of fluid loss.

(v) When a batch product process equipment train does not pass two consecutive pressure tests, the information specified in paragraphs (b)(7)(v)(A) through (b)(7)(v)(E) of this section shall be recorded in a log and kept for 2 years:

(A) The date of each pressure test and the date of each leak repair attempt.

(B) Repair methods applied in each attempt to repair the leak.

(C) The reason for the delay of repair.

(D) The expected date for delivery of the replacement equipment and the actual date of delivery of the replacement equipment; and

(E) The date of successful repair.

(c) *Equipment monitoring.* The following requirements shall be met if an owner or operator elects to monitor the equipment in a batch process to detect leaks by the method specified in §63.1023(b) and, as applicable, §63.1023(c), to demonstrate compliance with this subpart.

(1) The owner or operator shall comply with the requirements of §§63.1025 through 63.1035 as modified by paragraphs (c)(2) through (c)(4) of this section.

(2) The equipment shall be monitored for leaks by the method specified in §63.1023(b) and, as applicable, §63.1023(c), when the equipment is in regulated material service or is in use with any other detectable material.

(3) The equipment shall be monitored for leaks as specified in paragraphs (c)(3)(i) through (c)(3)(iv) of this section.

(i) Each time the equipment is reconfigured for the production of a new product, the reconfigured equipment shall be monitored for leaks within 30 days of start-up of the process. This initial monitoring of reconfigured equipment shall not be included in determining percent leaking equipment in the process unit or affected facility.

(ii) Connectors shall be monitored in accordance with the requirements in §63.1027.

(iii) Equipment other than connectors shall be monitored at the frequencies specified in table 1 to this subpart. The operating time shall be determined as the proportion of the year the batch product-process that is subject to the provisions of this subpart is operating.

(iv) The monitoring frequencies specified in paragraph (c)(3)(iii) of this section are not requirements for monitoring at specific intervals and can be adjusted to accommodate process operations. An owner or operator may monitor anytime during the specified monitoring period (e.g., month, quarter, year), provided the monitoring is conducted at a reasonable interval after completion of the last monitoring campaign. For example, if the equipment is not operating during the scheduled monitoring period, the monitoring can be done during the next period when the process is operating.

(4) If a leak is detected, it shall be repaired as soon as practical but not later than 15 calendar days after it is detected, except as provided in paragraph (e) of this section.

(d) *Added equipment recordkeeping.* (1) For batch product-process units or affected facilities that the owner or operator elects to monitor as provided under paragraph (c) of this section, the owner or operator shall prepare a list of equipment added to batch product process units or affected facilities since the last monitoring period required in paragraphs (c)(3)(ii) and (c)(3)(iii) of this section.

(2) Maintain records demonstrating the proportion of the time during the calendar year the equipment is in use in a batch process that is subject to the provisions of this subpart. Examples of suitable documentation are records of time in use for individual pieces of equipment or average time in use for the process unit or affected facility. These records are not required if the owner or operator does not adjust monitoring frequency by the time in use, as provided in paragraph (c)(3)(iii) of this section.

(3) Record and keep pursuant to the referencing subpart and this subpart, the date and results of the monitoring required in paragraph (c)(3)(i) of this section for equipment added to a batch product-process unit or affected facility since the last monitoring period required in paragraphs (c)(3)(ii) and (c)(3)(iii) of this section. If no leaking equipment is found during this monitoring, the owner or operator shall record that the inspection was performed. Records of the actual monitoring results are not required.

(e) *Delay of repair.* Delay of repair of equipment for which leaks have been detected is allowed if the replacement equipment is not available providing the conditions specified in paragraphs (e)(1) and (e)(2) of this section are met.

(1) Equipment supplies have been depleted and supplies had been sufficiently stocked before the supplies were depleted.

(2) The repair is made no later than 10 calendar days after delivery of the replacement equipment.

(f) *Periodic report contents.* For owners or operators electing to meet the requirements of paragraph (b) of this section, the Periodic Report to be filed pursuant to §63.1039(b) shall include the information listed in paragraphs (f)(1) through (f)(4) of this section for each process unit.

(1) Batch product process equipment train identification;

(2) The number of pressure tests conducted;

(3) The number of pressure tests where the equipment train failed the pressure test; and

(4) The facts that explain any delay of repairs.

[↑ Back to Top](#)

### **§63.1037 Alternative means of emission limitation: Enclosed-vented process units or affected facilities.**

(a) *Use of closed vent system and control device.* Process units or affected facilities or portions of process units at affected facilities enclosed in such a manner that all emissions from equipment leaks are vented through a closed vent system to a control device or routed to a fuel gas system or process meeting the requirements of §63.1034 are exempt from the requirements of §§63.1025 through 63.1033 and 63.1035. The enclosure shall be maintained under a negative pressure at all times while the process unit or affected facility is in operation to ensure that all emissions are routed to a control device.

(b) *Recordkeeping.* Owners and operators choosing to comply with the requirements of this section shall maintain the records specified in paragraphs (b)(1) through (b)(3) of this section.

- (1) Identification of the process unit(s) or affected facilities and the regulated materials they handle.
- (2) A schematic of the process unit or affected facility, enclosure, and closed vent system.
- (3) A description of the system used to create a negative pressure in the enclosure to ensure that all emissions are routed to the control device.

[↑ Back to Top](#)

### **§63.1038 Recordkeeping requirements.**

(a) *Recordkeeping system.* An owner or operator of more than one regulated source subject to the provisions of this subpart may comply with the recordkeeping requirements for these regulated sources in one recordkeeping system. The recordkeeping system shall identify each record by regulated source and the type of program being implemented (e.g., quarterly monitoring, quality improvement) for each type of equipment. The records required by this subpart are summarized in paragraphs (b) and (c) of this section.

(b) *General equipment leak records.* (1) As specified in §63.1022(a) and (b), the owner or operator shall keep general and specific equipment identification if the equipment is not physically tagged and the owner or operator is electing to identify the equipment subject to this subpart through written documentation such as a log or other designation.

(2) The owner or operator shall keep a written plan as specified in §63.1022(c)(4) for any equipment that is designated as unsafe- or difficult-to-monitor.

(3) The owner or operator shall maintain a record of the identity and an explanation as specified in §63.1022(d)(2) for any equipment that is designated as unsafe-to-repair.

(4) As specified in §63.1022(e), the owner or operator shall maintain the identity of compressors operating with an instrument reading of less than 500 parts per million.

(5) The owner or operator shall keep records associated with the determination that equipment is in heavy liquid service as specified in §63.1022(f).

(6) The owner or operator shall keep records for leaking equipment as specified in §63.1023(e)(2).

(7) The owner or operator shall keep records for leak repair as specified in §63.1024(f) and records for delay of repair as specified in §63.1024(d).

(c) *Specific equipment leak records.* (1) For valves, the owner or operator shall maintain the records specified in paragraphs (c)(1)(i) and (c)(1)(ii) of this section.

(i) The monitoring schedule for each process unit as specified in §63.1025(b)(3)(vi).

(ii) The valve subgrouping records specified in §63.1025(b)(4)(iv), if applicable.

(2) For pumps, the owner or operator shall maintain the records specified in paragraphs (c)(2)(i) through (c)(2)(iii) of this section.

- (i) Documentation of pump visual inspections as specified in §63.1026(b)(4).
  - (ii) Documentation of dual mechanical seal pump visual inspections as specified in §63.1026(e)(1)(v).
  - (iii) For the criteria as to the presence and frequency of drips for dual mechanical seal pumps, records of the design criteria and explanations and any changes and the reason for the changes, as specified in §63.1026(e)(1)(i).
- (3) For connectors, the owner or operator shall maintain the monitoring schedule for each process unit as specified in §63.1027(b)(3)(v).
- (4) For agitators, the owner or operator shall maintain the following records:
- (i) Documentation of agitator seal visual inspections as specified in §63.1028; and
  - (ii) For the criteria as to the presence and frequency of drips for agitators, the owner or operator shall keep records of the design criteria and explanations and any changes and the reason for the changes, as specified in §63.1028(e)(1)(vi).
- (5) For pressure relief devices in gas and vapor or light liquid service, the owner or operator shall keep records of the dates and results of monitoring following a pressure release, as specified in §63.1030(c)(3).
- (6) For compressors, the owner or operator shall maintain the records specified in paragraphs (c)(6)(i) and (c)(6)(ii) of this section.
- (i) For criteria as to failure of the seal system and/or the barrier fluid system, record the design criteria and explanations and any changes and the reason for the changes, as specified in §63.1031(d)(2).
  - (ii) For compressors operating under the alternative compressor standard, record the dates and results of each compliance test as specified in §63.1031(f)(2).
- (7) For a pump QIP program, the owner or operator shall maintain the records specified in paragraphs (c)(7)(i) through (c)(7)(v) of this section.
- (i) Individual pump records as specified in §63.1035(d)(2).
  - (ii) Trial evaluation program documentation as specified in §63.1035(d)(6)(iii).
  - (iii) Engineering evaluation documenting the basis for judgement that superior emission performance technology is not applicable as specified in §63.1035(d)(6)(vi).
  - (iv) Quality assurance program documentation as specified in §63.1035(d)(7).
  - (v) QIP records as specified in §63.1035(e).
- (8) For process units complying with the batch process unit alternative, the owner or operator shall maintain the records specified in paragraphs (c)(8)(i) and (c)(8)(ii) of this section.
- (i) Pressure test records as specified in §63.1036(b)(7).

(ii) Records for equipment added to the process unit as specified in §63.1036(d).

(9) For process units complying with the enclosed-vented process unit alternative, the owner or operator shall maintain the records for enclosed-vented process units as specified in §63.1037(b).

[↑ Back to Top](#)

### **§63.1039 Reporting requirements.**

(a) *Initial Compliance Status Report.* Each owner or operator shall submit an Initial Compliance Status Report according to the procedures in the referencing subpart. The notification shall include the information listed in paragraphs (a)(1) through (a)(3) of this section, as applicable.

(1) The notification shall provide the information listed in paragraphs (a)(1)(i) through (a)(1)(iv) of this section for each process unit or affected facility subject to the requirements of this subpart.

(i) Process unit or affected facility identification.

(ii) Number of each equipment type (e.g., valves, pumps) excluding equipment in vacuum service.

(iii) Method of compliance with the standard (e.g., “monthly leak detection and repair” or “equipped with dual mechanical seals”).

(iv) Planned schedule for requirements in §§63.1025 and 63.1026.

(2) The notification shall provide the information listed in paragraphs (a)(2)(i) and (a)(2)(ii) of this section for each process unit or affected facility subject to the requirements of §63.1036(b).

(i) Batch products or product codes subject to the provisions of this subpart, and

(ii) Planned schedule for pressure testing when equipment is configured for production of products subject to the provisions of this subpart.

(3) The notification shall provide the information listed in paragraphs (a)(3)(i) and (a)(3)(ii) of this section for each process unit or affected facility subject to the requirements in §63.1037.

(i) Process unit or affected facility identification.

(ii) A description of the system used to create a negative pressure in the enclosure and the control device used to comply with the requirements of §63.1034 of this part.

(b) *Periodic Reports.* The owner or operator shall report the information specified in paragraphs (b)(1) through (b)(8) of this section, as applicable, in the Periodic Report specified in the referencing subpart.

(1) For the equipment specified in paragraphs (b)(1)(i) through (b)(1)(v) of this section, report in a summary format by equipment type, the number of components for which leaks were detected and for valves, pumps and connectors show the percent leakers, and the total number of components monitored. Also include the number of leaking components that were not repaired as required by §63.1024, and for

valves and connectors, identify the number of components that are determined by §63.1025(c)(3) to be nonrepairable.

- (i) Valves in gas and vapor service and in light liquid service pursuant to §63.1025(b) and (c).
  - (ii) Pumps in light liquid service pursuant to §63.1026(b) and (c).
  - (iii) Connectors in gas and vapor service and in light liquid service pursuant to §63.1027(b) and (c).
  - (iv) Agitators in gas and vapor service and in light liquid service pursuant to §63.1028(c).
  - (v) Compressors pursuant to §63.1031(d).
- (2) Where any delay of repair is utilized pursuant to §63.1024(d), report that delay of repair has occurred and report the number of instances of delay of repair.
- (3) If applicable, report the valve subgrouping information specified in §63.1025(b)(4)(iv).
- (4) For pressure relief devices in gas and vapor service pursuant to §63.1030(b) and for compressors pursuant to §63.1031(f) that are to be operated at a leak detection instrument reading of less than 500 parts per million, report the results of all monitoring to show compliance conducted within the semiannual reporting period.
- (5) Report, if applicable, the initiation of a monthly monitoring program for valves pursuant to §63.1025(b)(3)(i).
- (6) Report, if applicable, the initiation of a quality improvement program for pumps pursuant to §63.1035.
- (7) Where the alternative means of emissions limitation for batch processes is utilized, report the information listed in §63.1036(f).
- (8) Report the information listed in paragraph (a) of this section for the Initial Compliance Status Report for process units or affected facilities with later compliance dates. Report any revisions to items reported in an earlier Initial Compliance Status Report if the method of compliance has changed since the last report.

[↑ Back to Top](#)

**Table 1 to Subpart UU of Part 63—Batch Processes Monitoring Frequency For Equipment Other Than Connectors**

Operating time (% of year)	Equivalent continuous process monitoring frequency time in use		
	Monthly	Quarterly	Semiannually
0 to <25%	Quarterly	Annually	Annually.



25 to <50%	Quarterly	Semiannually	Annually.
50 to <75%	Bimonthly	Three times	Semiannually.
75 to 100%	Monthly	Quarterly	Semiannually.

[↑ Back to Top](#)

# **APPENDIX F**

## Electronic Code of Federal Regulations

---

[View past updates to the e-CFR.](#)

[Click here to learn more.](#)

---

**e-CFR data is current as of January 17, 2017**

[Title 40](#) → [Chapter I](#) → [Subchapter C](#) → [Part 63](#) → [Subpart YY](#)

---

[Browse Previous](#) | [Browse Next](#)

Title 40: Protection of Environment

[PART 63—NATIONAL EMISSION STANDARDS FOR HAZARDOUS AIR POLLUTANTS FOR SOURCE CATEGORIES \(CONTINUED\)](#)

---

### **Subpart YY—National Emission Standards for Hazardous Air Pollutants for Source Categories: Generic Maximum Achievable Control Technology Standards**

---

#### **Contents**

- [§63.1100 Applicability.](#)
  - [§63.1101 Definitions.](#)
  - [§63.1102 Compliance schedule.](#)
  - [§63.1103 Source category-specific applicability, definitions, and requirements.](#)
  - [§63.1104 Process vents from continuous unit operations: applicability assessment procedures and methods.](#)
  - [§63.1105 Transfer racks.](#)
  - [§63.1106 Wastewater provisions.](#)
  - [§63.1107 Equipment leaks.](#)
  - [§63.1108 Compliance with standards and operation and maintenance requirements.](#)
  - [§63.1109 Recordkeeping requirements.](#)
  - [§63.1110 Reporting requirements.](#)
  - [§63.1111 Startup, shutdown, and malfunction.](#)
  - [§63.1112 Extension of compliance, and performance test, monitoring, recordkeeping and reporting waivers and alternatives.](#)
  - [§63.1113 Procedures for approval of alternative means of emission limitation.](#)
  - [§63.1114 Implementation and enforcement.](#)
- 

Source: 64 FR 34921, June 29, 1999, unless otherwise noted.

[↑ Back to Top](#)

**§63.1100 Applicability.**

(a) *General.* This subpart applies to source categories and affected sources specified in §63.1103(a) through (h). The affected emission points, by source category, are summarized in table 1 of this section. This table also delineates the section and paragraph of the rule that directs an owner or operator of an affected source to source category-specific control, monitoring, recordkeeping, and reporting requirements.

**Table 1 to §63.1100(a)—Source Category MACT<sup>a</sup> Applicability**

Source category	Storage vessels	Process vents	Transfer racks	Equipment leaks	Wastewater streams	Other	Source category MACT requirements
Acetal Resins Production	Yes	Yes	No	Yes	Yes	No	§63.1103(a)
Acrylic and Modacrylic Fibers Production	Yes	Yes	No	Yes	Yes	Yes <sup>b</sup>	§63.1103(b)
Carbon Black Production	No	Yes	No	No	No	No	§63.1103(f).
Cyanide Chemicals Manufacturing	Yes	Yes	Yes	Yes	Yes	No	§63.1103(g).
Ethylene Production	Yes	Yes	Yes	Yes	Yes	Yes <sup>c</sup>	§63.1103(e).
Hydrogen Fluoride Production	Yes	Yes	Yes	Yes	No	No	§63.1103(c)
Polycarbonate Production	Yes	Yes	No	Yes	Yes	No	§63.1103(d)
Spandex Production	Yes	Yes	No	No	No	Yes <sup>d</sup>	§63.1103(h).

<sup>a</sup>Maximum achievable control technology.

<sup>b</sup>Fiber spinning lines using spinning solution or suspension containing acrylonitrile.

<sup>c</sup>Heat exchange systems as defined in §63.1103(e)(2).

<sup>d</sup>Fiber spinning lines.

(b) *Subpart A requirements.* The following provisions of subpart A of this part (General Provisions), §§63.1 through 63.5, and §§63.12 through 63.15, apply to owners or operators of affected sources subject to this subpart.

(c) *Research and development facilities.* The provisions of this subpart do not apply to research and development facilities, consistent with section 112(b)(7) of the Act.

(d) *Primary product determination and applicability.* The primary product of a process unit shall be determined according to the procedures specified in paragraphs (d)(1) and (2) of this section. Paragraphs (d)(3), (4), and (5) of this section discuss compliance for those process units operated as flexible operation units.

(1) If a process unit only manufactures one product, then that product shall represent the primary product of the process unit.

(2) If a process unit is designed and operated as a flexible operation unit, the primary product shall be determined as specified in paragraphs (d)(2)(i) or (ii) of this section based on the anticipated operations for the 5 years following the promulgation date for existing affected sources and for the first 5 years after initial startup for new affected sources.

(i) If the flexible operation unit will manufacture one product for the greatest percentage of operating time over the five-year period, then that product shall represent the primary product of the flexible operation unit.

(ii) If the flexible operation unit will manufacture multiple products equally based on operating time, then the product with the greatest production on a mass basis over the five-year period shall represent the primary product of the flexible operation unit.

(3) Once the primary product of a process unit has been determined to be a product produced by a source category subject to this subpart, the owner or operator of the affected source shall comply with the standards for the primary product production process unit.

(4) The determination of the primary product for a process unit, including the assessment of applicability of this subpart to process units that are designed and operated as flexible operation units, shall be reported in the Notification of Compliance Status report required by §63.1110(a)(4) when the primary product is determined to be a product produced by a source category subject to requirements under this subpart. The Notification of Compliance Status shall include the information specified in either paragraph (d)(4)(i) or (ii) of this section. If the primary product is determined to be something other than a product produced by a source category subject to requirements under this subpart, the owner or operator shall retain information, data, and analyses used to document the basis for the determination that the primary product is not produced by a source category subject to requirements under this subpart.

(i) If the process unit manufactures only one product subject to requirements under this subpart, the identity of that product.

(ii) If the process unit is designed and operated as a flexible operation unit, the information specified in paragraphs (d)(4)(ii)(A) and (B) of this section, as appropriate.

(A) The identity of the primary product.

(B) Information concerning operating time and/or production mass for each product that was used to make the determination of the primary product under paragraph (d)(2)(i) or (ii) of this section.

(5) When a flexible operation unit that is subject to this subpart is producing a product other than a product subject to this subpart, or is producing a product subject to this subpart that is not the primary product, the owner or operator shall comply with either paragraph (d)(5) (i) or (ii) of this section for each emission point.

(i) The owner or operator shall control emissions during the production of all products in accordance with the requirements for the production of the primary product. As appropriate, the owner or operator shall demonstrate that the parameter monitoring level established for the primary product is also appropriate for those periods when products other than the primary product are being produced. Documentation of this demonstration shall be submitted in the Notification of Compliance Status report required by §63.1110(a)(4).

(ii) The owner or operator shall determine, for the production of each product, whether control is required in accordance with the applicable criteria for the primary product in §63.1103. If control is required, the owner or operator shall establish separate parameter monitoring levels, as appropriate, for the production of each product. The parameter monitoring levels developed shall be submitted in the Notification of Compliance Status report required by §63.1110(a)(4).

(e) *Storage vessel ownership determination.* To determine the process unit to which a storage vessel shall belong, the owner or operator shall sequentially follow the procedures specified in paragraphs (e)(1) through (8) of this section, stopping as soon as the determination is made.

(1) If a storage vessel is already subject to another subpart of this part on the date of promulgation for an affected source under the generic MACT, that storage vessel shall belong to the process unit subject to the other subpart.

(2) If a storage vessel is dedicated to a single process unit, the storage vessel shall belong to that process unit.

(3) If a storage vessel is shared among process units, then the storage vessel shall belong to that process unit located on the same plant site as the storage vessel that has the greatest input into or output from the storage vessel (i.e., the process unit has the predominant use of the storage vessel.)

(4) If predominant use cannot be determined for a storage vessel that is shared among process units and if only one of those process units is subject to this subpart, the storage vessel shall belong to that process unit.

(5) If predominant use cannot be determined for a storage vessel that is shared among process units and if more than one of the process units are subject to standards under this subpart that have different primary

products, then the owner or operator shall assign the storage vessel to any one of the process units sharing the storage vessel.

(6) If the predominant use of a storage vessel varies from year to year, then predominant use shall be determined based on the utilization that occurred during the year preceding the date of promulgation of standards for an affected source under this subpart or based on the expected utilization for the 5 years following the promulgation date of standards for an affected source under this subpart for existing affected sources, whichever is more representative of the expected operations for that storage vessel, and based on the expected utilization for the 5 years after initial startup for new affected sources. The determination of predominant use shall be reported in the Notification of Compliance Status Report required by §63.1110(a)(4). If the predominant use changes, the redetermination of predominant use shall be reported in the next Periodic Report.

(7) If the storage vessel begins receiving material from (or sending material to) another process unit; ceases to receive material from (or send material to) a process unit; or if the applicability of this subpart to a storage vessel has been determined according to the provisions of paragraphs (e)(1) through (6) of this section and there is a significant change in the use of the storage vessel that could reasonably change the predominant use, the owner or operator shall reevaluate the applicability of this subpart to the storage vessel.

(8) Where a storage vessel is located at a major source that includes one or more process units that place material into, or receive materials from, the storage vessel, but the storage vessel is located in a tank farm, the applicability of this subpart shall be determined according to the provisions in paragraphs (e)(8)(i) through (iii) of this section.

(i) The storage vessel may only be assigned to a process unit that utilizes the storage vessel and does not have an intervening storage vessel for that product (or raw material, as appropriate). With respect to any process unit, an intervening storage vessel means a storage vessel connected by hard-piping to the process unit and to the storage vessel in the tank farm so that product or raw material entering or leaving the process unit flows into (or from) the intervening storage vessel and does not flow directly into (or from) the storage vessel in the tank farm.

(ii) If there is only one process unit at a major source that meets the criteria of paragraph (e)(8)(i) of this section with respect to a storage vessel, the storage vessel shall be assigned to that process unit.

(iii) If there are two or more process units at the major source that meet the criteria of paragraph (e)(8)(i) of this section with respect to a storage vessel, the storage vessel shall be assigned to one of those process units according to the provisions of paragraph (e)(6) of this section. The predominant use shall be determined among only those process units that meet the criteria of paragraph (e)(8)(i) of this section.

(f) *Recovery operation equipment ownership determination.* To determine the process unit to which recovery equipment shall belong, the owner or operator shall sequentially follow the procedures specified in paragraphs (f)(1) through (7) of this section, stopping as soon as the determination is made.

(1) If recovery operation equipment is already subject to another subpart of this part on the date standards are promulgated for an affected source, that recovery operation equipment shall belong to the process unit subject to the other subpart.

(2) If recovery operation equipment is used exclusively by a single process unit, the recovery operation shall belong to that process unit.

(3) If recovery operation equipment is shared among process units, then the recovery operation equipment shall belong to that process unit that has the greatest input into or output from the recovery operation equipment (i.e., that process unit has the predominant use of the recovery operation equipment).

(4) If predominant use cannot be determined for recovery operation equipment that is shared among process units and if one of those process units is a process unit subject to this subpart, the recovery operation equipment shall belong to the process unit subject to this subpart.

(5) If predominant use cannot be determined for recovery operation equipment that is shared among process units and if more than one of the process units are process units that have different primary products and that are subject to this subpart, then the owner or operator shall assign the recovery operation equipment to any one of those process units.

(6) If the predominant use of recovery operation equipment varies from year to year, then the predominant use shall be determined based on the utilization that occurred during the year preceding the promulgation date of standards for an affected source under this subpart or based on the expected utilization for the 5 years following the promulgation date for standards for an affected source under this subpart for existing affected sources, whichever is the more representative of the expected operations for the recovery operations equipment, and based on the expected utilization for the first 5 years after initial startup for new affected sources. This determination shall be reported in the Notification of Compliance Status Report required by §63.1110(a)(4). If the predominant use changes, the redetermination of predominant use shall be reported in the next Periodic Report.

(7) If there is an unexpected change in the utilization of recovery operation equipment that could reasonably change the predominant use, the owner or operator shall redetermine to which process unit the recovery operation belongs by reperforming the procedures specified in paragraphs (f)(2) through (6) of this section.

(g) *Overlap with other regulations.* Paragraphs (g)(1) through (6) of this section specify the applicability of this subpart YY emission point requirements when other rules may apply. Where subpart YY of this part allows an owner or operator an option to comply with one or another regulation to comply with subpart YY of this part, an owner or operator must report which regulation they choose to comply with in the Notification of Compliance Status report required by §63.1110(a)(4).

(1) *Overlap of subpart YY with other regulations for storage vessels.* (i) After the compliance dates specified in §63.1102, a storage vessel subject to this subpart YY that is also subject to subpart G or CC of this part is required to comply only with the provisions of this subpart YY.

(ii) After the compliance dates specified in §63.1102, a storage vessel that must be controlled according to the requirements of this subpart and subpart Ka or Kb of 40 CFR part 60 is required to comply only with the storage vessel requirements of this subpart.

(2) *Overlap of subpart YY with other regulations for process vents.* (i) After the compliance dates specified in §63.1102, a process vent that must be controlled according to the requirements of this subpart



and subpart G of this part is in compliance with this subpart if it complies with either set of requirements. The owner or operator must specify the rule with which they will comply in the Notification of Compliance Status report required by §63.1110(a)(4).

(ii) After the compliance dates specified in §63.1102, a process vent that must be controlled according to the requirements of this subpart and subpart III, RRR or NNN of 40 CFR part 60 is required to comply only with the process vent requirements of this subpart.

(3) *Overlap of this subpart YY with other regulations for transfer racks.* After the compliance dates specified in §63.1102, a transfer rack that must be controlled according to the requirements of this subpart YY and either subpart G of this part or subpart BB of 40 CFR part 61 is required to comply only with the transfer rack requirements of this subpart YY.

(4) *Overlap of subpart YY with other regulations for equipment leaks.* (i) After the compliance dates specified in §63.1102, equipment that must be controlled according to this subpart and 40 CFR part 60, subpart VV, or 40 CFR part 61, subpart J or subpart V, is required only to comply with the equipment leak requirements of this subpart.

(ii) After the compliance dates specified in §63.1102, equipment that must be controlled according to this subpart and subpart H of this part is in compliance with the equipment leak requirements of this subpart if it complies with either set of requirements. The owner or operator must specify the rule with which they will comply in the Notification of Compliance Status report required by §63.1110(a)(4).

(5) *Overlap of subpart YY with other regulations for wastewater for source categories other than ethylene production.* (i) After the compliance dates specified in §63.1102 for an affected source subject to this subpart, a wastewater stream that is subject to the wastewater requirements of this subpart and the wastewater requirements of subparts F, G, and H of this part (collectively known as the “HON”) shall be deemed to be in compliance with the requirements of this subpart if it complies with either set of requirements. In any instance where a source subject to this subpart is colocated with a Synthetic Organic Chemical Manufacturing Industry (SOCMI) source, and a single wastewater treatment facility treats both Group 1 wastewaters and wastewater residuals from the source subject to this subpart and wastewaters from the SOCMI source, a certification by the treatment facility that they will manage and treat the waste in conformity with the specific control requirements set forth in 40 CFR 63.133 through 63.147 will also be deemed sufficient to satisfy the certification requirements for wastewater treatment under this subpart.

(ii) After the compliance dates specified in §63.1102 for an affected source subject to this subpart, a wastewater stream that is subject to control requirements in the Benzene Waste NESHAP (subpart FF of part 61 of this chapter) and this subpart is required to comply with both rules.

(6) *Overlap of subpart YY with other regulations for waste for the ethylene production source category.*

(i) After the compliance date specified in §63.1102, a waste stream that is conveyed, stored, or treated in a wastewater stream management unit, waste management unit, or wastewater treatment system that receives streams subject to both the control requirements of §63.1103(e)(3) for ethylene production sources and the provisions of §§63.133 through 63.147 shall comply as specified in paragraphs (g)(6)(i)(A) through (C) of this section. Compliance with the provisions of this paragraph (g)(6)(i) shall constitute compliance with the requirements of this subpart for that waste stream.

(A) Comply with the provisions in §§63.133 through 63.137 and 63.140 for all equipment used in the storage and conveyance of the waste stream.

(B) Comply with the provisions in §§63.1103(e), 63.138, and 63.139 for the treatment and control of the waste stream.

(C) Comply with the provisions in §§63.143 through 63.148 for monitoring and inspections of equipment and for recordkeeping and reporting requirements. The owner or operator is not required to comply with the monitoring, recordkeeping, and reporting requirements associated with the treatment and control requirements in §§61.355 through 61.357.

(ii) After the compliance date specified in §63.1102, compliance with §63.1103(e) shall constitute compliance with the Benzene Waste Operations NESHAP (subpart FF of 40 CFR part 61) for waste streams that are subject to both the control requirements of §63.1103(e)(3) for ethylene production sources and the control requirements of 40 CFR part 61, subpart FF.

[64 FR 34921, June 29, 1999, as amended at 64 FR 63698, 63706, Nov. 22, 1999; 67 FR 46279, July 12, 2002; 70 FR 19272, Apr. 13, 2005; 79 FR 60922, Oct. 8, 2014]

[↑ Back to Top](#)

#### **§63.1101 Definitions.**

All terms used in this subpart shall have the meaning given them in the Act, in 40 CFR 63.2 (General Provisions), and in this section. The definitions in this section do not apply to waste requirements for ethylene production sources.

*Annual average concentration*, as used in the wastewater provisions, means the flow-weighted annual average concentration, as determined according to the procedures specified in §63.144(b).

*Annual average flow rate*, as used in the wastewater provisions, means the annual average flow rate, as determined according to the procedures specified in §63.144(c).

*Batch cycle* refers to manufacturing a product from start to finish in a batch unit operation.

*Batch emission episode* means a discrete venting episode that may be associated with a single unit operation. A unit operation may have more than one batch emission episode per batch cycle. For example, a displacement of vapor resulting from the charging of a vessel with organic HAP will result in a discrete emission episode. If the vessel is then heated, there may also be another discrete emission episode resulting from the expulsion of expanded vapor. Both emission episodes may occur during the same batch cycle in the same vessel or unit operation. There are possibly other emission episodes that may occur from the vessel or other process equipment, depending on process operations.

*Batch unit operation* means a unit operation involving intermittent or discontinuous feed into equipment and, in general, involves the emptying of equipment after the batch cycle ceases and prior to beginning a new batch cycle. Mass, temperature, concentration and other properties of the process may vary with time. Addition of raw material and withdrawal of product do not simultaneously occur in a batch unit operation.

*Bottoms receiver* means a tank that collects distillation bottoms before the stream is sent for storage or for further downstream processing.

*By compound* means by individual stream components, not carbon equivalents.

*Capacity* means the volume of liquid that is capable of being stored in a storage vessel, determined by multiplying the vessel's internal cross-sectional area by the internal height of the shell.

*Closed vent system* means a system that is not open to the atmosphere and is composed of piping, ductwork, connections, and, if necessary, flow inducing devices that transport gas or vapor from an emission point to a control device. A closed vent system does not include the vapor collection system that is part of any tank truck or railcar or the loading arm or hose that is used for vapor return. For transfer racks, the closed vent system begins at, and includes, the first block valve on the downstream side of the loading arm or hose used to convey displaced vapors.

*Combined vent stream* means a process vent that is comprised of at least one gas stream from a batch unit operation manifolded with at least one gas stream from a continuous unit operation.

*Compliance equipment* means monitoring equipment used by an owner or operator of an affected source under this subpart to demonstrate compliance with an operation or emission limit standard.

*Continuous parameter monitoring system* or *CPMS* means the total equipment that may be required to meet the data acquisition and availability requirements of this subpart, and that is used to sample, condition (if applicable), analyze, and provide a record of process or control system parameters.

*Continuous unit operation* means a unit operation where the inputs and outputs flow continuously. Continuous unit operations typically approach steady-state conditions. Continuous unit operations typically involve the simultaneous addition of raw material and withdrawal of the product.

*Control device* means, with the exceptions noted below, a combustion device, recovery device, recapture device, or any combination of these devices used to comply with this subpart or a referencing subpart. For process vents from continuous unit operations at affected sources in source categories where the applicability criteria includes a TRE index value, recovery devices are not considered to be control devices. Primary condensers on steam strippers or fuel gas systems are not considered to be control devices.

*Day* means a calendar day.

*Distillate receiver* means overhead receivers, overhead accumulators, reflux drums, and condenser(s) including ejector condenser(s) associated with a distillation unit.

*Distillation unit* means a device or vessel in which one or more feed streams are separated into two or more exit streams, each exit stream having component concentrations different from those in the feed stream(s). The separation is achieved by the redistribution of the components between the liquid and the vapor phases by vaporization and condensation as they approach equilibrium within the distillation unit. Distillation unit includes the distillate receiver, reboiler, and any associated vacuum pump or steam jet.

*Emission point* means an individual process vent, storage vessel, transfer rack, wastewater stream, kiln, fiber spinning line, equipment leak, or other point where a gaseous stream is released.

*Equipment* means each of the following that is subject to control under this subpart: pump, compressor, agitator, pressure relief device, sampling collection system, open-ended valve or line, valve, connector, instrumentation system in organic hazardous air pollutant service as defined in §63.1103 for the applicable process unit, whose primary product is a product produced by a source category subject to this subpart.

*Equivalent method* means any method of sampling and analysis for an air pollutant that has been demonstrated to the Administrator's satisfaction to have a consistent and quantitatively known relationship to the reference method, under specified conditions.

*Excess emissions* means emissions in excess of those that would have occurred if there were no start-up, shutdown, or malfunction and the owner or operator complied with the relevant provisions of this subpart.

*Final recovery device* means the last recovery device on a process vent stream from a continuous unit operation at an affected source in a source category where the applicability criteria includes a TRE index value. The final recovery device usually discharges to a combustion device, recapture device, or directly to the atmosphere.

*Flexible operation unit* means a process unit that manufactures different chemical products periodically by alternating raw materials or operating conditions.

*Fuel gas* means gases that are combusted to derive useful work or heat.

*Fuel gas system* means the offsite and onsite piping and flow and pressure control system that gathers gaseous stream(s) generated by onsite operations, may blend them with other sources of gas, and transports the gaseous stream for use as a fuel gas in combustion devices or in-process combustion equipment, such as furnaces and gas turbines, either singly or in combination.

*Group 1 wastewater stream* means a process wastewater stream at an existing or new source that meets the criteria for Group 1 status in §63.132(c).

*Group 2 wastewater stream* means a process wastewater stream that does not meet the definition of a Group 1 wastewater stream.

*Halogens and hydrogen halides* means hydrogen chloride (HCl), chlorine (Cl<sub>2</sub>), hydrogen bromide (HBr), bromine (Br<sub>2</sub>), and hydrogen fluoride (HF).

*Impurity* means a substance that is produced coincidentally with the primary product, or is present in a raw material. An impurity does not serve a useful purpose in the production or use of the primary product and is not isolated.

*Initial startup* means, for new sources, the first time the source begins production. For additions or changes not defined as a new source by this subpart, initial startup means the first time additional or changed equipment is put into operation. Initial startup does not include operation solely for testing equipment. Initial startup does not include subsequent startup (as defined in this section) of process units

following malfunctions or process unit shutdowns. Except for equipment leaks, initial startup also does not include subsequent startups (as defined in this section) of process units following changes in product for flexible operation units or following recharging of equipment in batch unit operations.

*Low throughput transfer rack* means a transfer rack that transfers less than a total of 11.8 million liters per year of liquid containing regulated HAP.

*Maintenance wastewater* means wastewater generated by the draining of process fluid from components in the process unit, whose primary product is a product produced by a source category subject to this subpart, into an individual drain system prior to or during maintenance activities. Maintenance wastewater can be generated during planned and unplanned shutdowns and during periods not associated with a shutdown. Examples of activities that can generate maintenance wastewaters include descaling of heat exchanger tubing bundles, cleaning of distillation column traps, draining of low legs and high point bleeds, draining of pumps into an individual drain system, and draining of portions of the process unit, whose primary product is a product produced by a source category subject to this subpart, for repair.

*Malfunction* means any sudden, infrequent, and not reasonably preventable failure of air pollution control equipment, process equipment, or a process to operate in a normal or usual manner which causes, or has the potential to cause, the emission limitations in an applicable standard to be exceeded. Failures that are caused in part by poor maintenance or careless operation are not malfunctions.

*Maximum true vapor pressure* means the equilibrium partial pressure exerted by the total organic HAP in the stored or transferred liquid at the temperature equal to the highest calendar-month average of the liquid storage or transfer temperature for liquids stored or transferred above or below the ambient temperature or at the local maximum monthly average temperature as reported by the National Weather Service for liquids stored or transferred at the ambient temperature, as determined:

- (1) In accordance with methods described in American Petroleum Institute Publication 2517, Evaporation Loss From External Floating-Roof Tanks (incorporated by reference as specified in §63.14 of subpart A of this part); or
- (2) As obtained from standard reference texts; or
- (3) As determined by the American Society for Testing and Materials Method D2879-83 (incorporated by reference as specified in §63.14 of subpart A of this part); or
- (4) Any other method approved by the Administrator.

*Oil-water separator* or *organic-water separator* means a waste management unit, generally a tank used to separate oil or organics from water. An oil-water or organic-water separator consists of not only the separation unit but also the forebay and other separator basins, skimmers, weirs, grit chambers, sludge hoppers, and bar screens that are located directly after the individual drain system and prior to additional waste management units such as an air flotation unit, clarifier, or biological treatment unit. Examples of an oil-water or organic-water separator include, but are not limited to, an American Petroleum Institute separator, parallel-plate interceptor, and corrugated-plate interceptor with the associated ancillary equipment.

*On-site* means, with respect to records required to be maintained by this subpart, a location within a plant site that encompasses the affected source. On-site includes, but is not limited to, the affected source to which the records pertain, or central files elsewhere at the plant site.

*Organic hazardous air pollutant* or *organic HAP* means any organic chemicals that are also HAP.

*Permitting authority* means one of the following:

(1) The State air pollution control agency, local agency, other State agency, or other agency authorized by the Administrator to carry out a permit program under part 70 of this chapter; or

(2) The Administrator, in the case of EPA-implemented permit programs under title V of the Act (42 U.S.C. 7661) and part 71 of this chapter.

*Plant site* means all contiguous or adjoining property that is under common control, including properties that are separated only by a road or other public right-of-way. Common control includes properties that are owned, leased, or operated by the same entity, parent entity, subsidiary, or any combination thereof.

*Point of determination* means each point where process wastewater exits the process unit, whose primary product is a product produced by a source category subject to this subpart.

Note to definition for point of determination: The regulation allows determination of the characteristics of a wastewater stream at the point of determination or downstream of the point of determination if corrections are made for changes in flow rate and annual average concentration of Table 9 compounds (as defined under this subpart) as determined in §63.144. Such changes include losses by air emissions, reduction of annual average concentration or changes in flow rate by mixing with other water or wastewater streams, and reduction in flow rate or annual average concentration by treating or otherwise handling the wastewater stream to remove or destroy hazardous air pollutants.

*Pressure release* means the emission of materials resulting from the system pressure being greater than the set pressure of the pressure relief device. This release can be one release or a series of releases over a short time period.

*Pressure relief device or valve* means a safety device used to prevent operating pressures from exceeding the maximum allowable working pressure of the process equipment. A common pressure relief device is a spring-loaded pressure relief valve. Devices that are actuated either by a pressure of less than or equal to 2.5 pounds per square inch gauge or by a vacuum are not pressure relief devices.

*Process condenser* means a condenser whose primary purpose is to recover material as an integral part of a process. The condenser must support a vapor-to-liquid phase change for periods of source equipment operation that are above the boiling or bubble point of substance(s). Examples of process condensers include distillation condensers, reflux condensers, process condensers in line prior to the vacuum source, and process condensers used in stripping or flashing operations.

*Process unit* means the equipment assembled and connected by pipes or ducts to process raw and/or intermediate materials and to manufacture an intended product. A process unit includes more than one unit operation.

*Process unit shutdown* means a work practice or operational procedure that stops production from a process unit, or part of a process unit during which practice or procedure it is technically feasible to clear process material from the process unit, or part of the process unit, consistent with safety constraints and during which repairs can be effected. The following are not considered process unit shutdowns:

- (1) An unscheduled work practice or operational procedure that stops production from a process unit, or part of a process unit, for less than 24 hours.
- (2) An unscheduled work practice or operational procedure that would stop production from a process unit, or part of a process unit, for a shorter period of time than would be required to clear the process unit, or part of the process unit, of materials and start up the unit and result in greater emissions than delay of repair of leaking components until the next scheduled process unit shutdown.
- (3) The use of spare equipment and technically feasible bypassing of equipment without stopping production.

*Process vent* means the point of discharge to the atmosphere (or the point of entry into a control device, if any) of a gas stream from a unit operation within a source category subject to this subpart.

Process vent excludes the following gas stream discharges:

- (1) Relief valve discharges;
- (2) Leaks from equipment subject to this subpart;
- (3) Gas streams exiting a control device complying with this subpart;
- (4) Gas streams transferred to other processes (on-site or off-site) for reaction or other use in another process (i.e., for chemical value as a product, isolated intermediate, byproduct, or co-product for heat value);
- (5) Gas streams transferred for fuel value (i.e., net positive heating value), use, reuse, or sale for fuel value, use, or reuse;
- (6) Gas streams from storage vessels or transfer racks subject to this subpart;
- (7) Gas streams from waste management units subject to this subpart;
- (8) Gas streams from wastewater streams subject to this subpart;
- (9) Gas streams exiting process analyzers; and
- (10) Gas stream discharges that contain less than or equal to 0.005 weight-percent total organic HAP.

*Process wastewater* means wastewater which, during manufacturing or processing, comes into direct contact with or results from the production or use of any raw material, intermediate product, finished product, by-product, or waste product. Examples are product tank drawdown or feed tank drawdown, water formed during a chemical reaction or used as a reactant, water used to wash impurities from organic products or reactants, equipment washes between batches in a batch process, water used to cool or quench

organic vapor streams through direct contact, and condensed steam from jet ejector systems pulling vacuum on vessels containing organics.

*Process wastewater stream* means a stream that contains process wastewater.

*Product* means a compound or chemical which is manufactured as the intended product of the applicable production process unit as defined in §63.1103. By-products, isolated intermediates, impurities, wastes, and trace contaminants are not considered products.

*Recapture device* means an individual unit of equipment capable of and used for the purpose of recovering chemicals, but not normally for use, reuse, or sale. For example, a recapture device may recover chemicals primarily for disposal. Recapture devices include, but are not limited to, absorbers, carbon adsorbers, and condensers. For purposes of the monitoring, recordkeeping, and reporting requirements of this subpart, recapture devices are considered recovery devices.

*Recovery device* means an individual unit of equipment capable of and normally used for the purpose of recovering chemicals for fuel value (i.e., net positive heating value), use, reuse, or for sale for fuel value. Examples of equipment that may be recovery devices include absorbers, carbon adsorbers, condensers, oil-water separators or organic-water separators, or organic removal devices such as decanters, strippers, or thin-film evaporation units. For purposes of the monitoring, recordkeeping, and reporting requirements of this subpart, recapture devices are considered recovery devices.

*Research and development facility* means laboratory and pilot plant operations whose primary purpose is to conduct research and development into new processes and products, where the operations are under the close supervision of technically trained personnel, and is not engaged in the manufacture of products for commercial sale, except in a de minimis manner.

*Shutdown* means the cessation of operation of an affected source or equipment that is used to comply with this subpart, or the emptying and degassing of a storage vessel. For the purposes of this subpart, shutdown includes, but is not limited to, periodic maintenance, replacement of equipment, or repair. Shutdown does not include the routine rinsing or washing of equipment in batch operation between batches. Shutdown includes the decoking of ethylene production unit furnaces.

*Startup* means the setting into operation of a regulated source and/or equipment required or used to comply with this subpart. Startup includes initial startup, operation solely for testing equipment, the recharging of equipment in batch operation, and transitional conditions due to changes in product for flexible operation units.

*Storage vessel or tank*, for the purposes of regulation under the storage vessel provisions of this subpart, means a stationary unit that is constructed primarily of nonearthen materials (such as wood, concrete, steel, fiberglass, or plastic) that provides structural support and is designed to hold an accumulation of liquids or other materials. Storage vessel includes surge control vessels and bottoms receiver vessels. For the purposes of regulation under the storage vessel provisions of this subpart, storage vessel does not include vessels permanently attached to motor vehicles such as trucks, railcars, barges, or ships; pressure vessels designed to operate in excess of 204.9 kilopascals and without emissions to the atmosphere; or wastewater storage vessels. Wastewater storage vessels are covered under the wastewater provisions of §63.1106.



*Subsequent startup* means any setting into operation of a regulated source and/or equipment required or used to comply with this subpart following the initial startup.

*Surge control vessel* means a feed drum, recycle drum, or intermediate vessel. Surge control vessels are used within a process unit (as defined in this subpart) when in-process storage, mixing, or management of flow rates or volumes is needed to assist in production of a product.

*Table 9 compounds* means compounds listed in Table 9 of subpart G of this part.

*Total organic compounds or (TOC)* means the total gaseous organic compounds (minus methane and ethane) in a vent stream, with the concentrations expressed on a carbon basis.

*Total resource effectiveness index value or TRE index value* means a measure of the supplemental total resource requirement per unit reduction of organic HAP associated with a process vent stream, based on vent stream flow rate, emission rate of organic HAP, net heating value, and corrosion properties (whether or not the vent stream contains halogenated compounds), as quantified by the equations given under §63.1104(j).

*Transfer rack* means a single system used to fill bulk cargo tanks mounted on or in a truck or railcar. A transfer rack includes all loading arms, pumps, meters, shutoff valves, relief valves, and other piping and equipment necessary for the transfer operation. Transfer equipment and operations that are physically separate (i.e., do not share common piping, valves, and other equipment) are considered to be separate transfer racks.

*Unit operation* means distinct equipment used in processing, among other things, to prepare reactants, facilitate reactions, separate and purify products, and recycle materials. Equipment used for these purposes includes, but is not limited to, reactors, distillation columns, extraction columns, absorbers, decanters, dryers, condensers, and filtration equipment.

*Vapor balancing system* means a piping system that is designed to collect organic HAP vapors displaced from tank trucks or railcars during loading; and to route the collected organic HAP vapors to the storage vessel from which the liquid being loaded originated, or to compress collected organic HAP vapors and commingle with the raw feed of a production process unit.

*Wastewater* is either a process wastewater or a maintenance wastewater and means water that:

(1) Contains either:

(i) An annual average concentration of Table 9 compounds (as defined under this subpart) of at least 5 parts per million by weight at the point of determination and has an annual average flow rate of 0.02 liter per minute or greater, or

(ii) An annual average concentration of Table 9 compounds (as defined under this subpart) of at least 10,000 parts per million by weight at the point of determination at any flow rate, and that

(2) Is discarded from a process unit, whose primary product is a product produced by a source category subject to this subpart.

*Wastewater stream* means a stream that contains wastewater.

[64 FR 34921, June 29, 1999, as amended at 64 FR 63699, 63706, Nov. 22, 1999; 66 FR 55847, Nov. 2, 2001; 67 FR 39305, June 7, 2002; 67 FR 46280, July 12, 2002; 71 FR 20458, Apr. 20, 2006; 79 FR 60922, Oct. 8, 2014]

[↑ Back to Top](#)

### **§63.1102 Compliance schedule.**

(a) *General requirements.* Affected sources, as defined in §63.1103(a)(1)(i) for acetyl resins production, §63.1103(b)(1)(i) for acrylic and modacrylic fiber production, §63.1103(c)(1)(i) for hydrogen fluoride production, §63.1103(d)(1)(i) for polycarbonate production, §63.1103(e)(1)(i) for ethylene production, §63.1103(f)(1)(i) for carbon black production, §63.1103(g)(1)(i) for cyanide chemicals manufacturing, or §63.1103(h)(1)(i) for spandex production shall comply with the appropriate provisions of this subpart and the subparts referenced by this subpart according to the schedule in paragraphs (a)(1) or (2) of this section, as appropriate, except as provided in paragraph (b) of this section. Proposal and effective dates are specified in Table 1 to this section.

(1) *Compliance dates for new and reconstructed sources.* (i) The owner or operator of a new or reconstructed affected source that commences construction or reconstruction after the proposal date, and that has an initial startup before the effective date of standards for an affected source, shall comply with this subpart no later than the applicable effective date in Table 1 to §63.1102 of this section.

(ii) The owner or operator of a new or reconstructed affected source that has an initial startup after the applicable effective date in Table 1 to §63.1102 of this section shall comply with this subpart upon startup of the source.

(iii) The owner or operator of an affected source that commences construction or reconstruction after the proposal date, but before the effective date in Table 1 to this section, shall comply with this subpart no later than the date 3 years after the effective date if the conditions in paragraphs (a)(1)(iii) (A) and (B) of this section are met.

(A) The promulgated standards are more stringent than the proposed standards.

(B) The owner or operator complies with this subpart as proposed during the 3-year period immediately after the effective date of standards for the affected source.

(2) *Compliance dates for existing sources.* (i) The owner or operator of an existing affected source shall comply with the requirements of this subpart within 3 years after the effective date of standards for the affected source.

(ii) The owner or operator of an area source that increases its emissions of (or its potential to emit) HAP such that the source becomes a major source shall be subject to the relevant standards for existing sources under this subpart. Such sources shall comply with the relevant standards within 3 years of becoming a major source.

(b) All acrylic and modacrylic fiber production affected sources and polycarbonate production affected sources that commenced construction or reconstruction on or before January 9, 2014, shall be in compliance with the pressure relief device monitoring requirements of §63.1107(e)(3) upon initial startup or October 9, 2017, whichever is later, and the equipment leaks requirements of 40 CFR part 63, subpart UU upon initial startup or October 8, 2015, whichever is later. New acrylic and modacrylic fiber production affected sources and polycarbonate production affected sources that commence construction or reconstruction after January 9, 2014, shall be in compliance with the pressure relief device monitoring requirements of §63.1107(e)(3) upon initial startup or by October 8, 2014, whichever is later.

**Table 1 to §63.1102—Source Category Proposal and Effective Dates**

Source category	Proposal date	Effective date
(a) Acetal Resins Production	October 14, 1998	June 29, 1999.
(b) Acrylic and Modacrylic Fibers Production	October 14, 1998	June 29, 1999.
(c) Hydrogen Fluoride Production	October 14, 1998	June 29, 1999.
(d) Polycarbonate Production	October 14, 1998	June 29, 1999.
(e) Ethylene Production	December 6, 2000	July 12, 2002.
(f) Carbon Black Production	December 6, 2000	July 12, 2002.
(g) Cyanide Chemicals Manufacturing	December 6, 2000	July 12, 2002.
(h) Spandex Production	December 6, 2000	July 12, 2002.

[67 FR 46280, July 12, 2002, as amended at 79 FR 60922, Oct. 8, 2014]

[↑ Back to Top](#)

**§63.1103 Source category-specific applicability, definitions, and requirements.**

(a) *Acetal resins production applicability, definitions, and requirements*—(1) *Applicability*—(i) *Affected source*. For the acetal resins production source category (as defined in paragraph (a)(2) of this section), the affected source shall comprise all emission points, in combination, listed in paragraphs (a)(1)(i)(A) through (D) of this section, that are associated with an acetal resins production process unit located at a major source, as defined in section 112(a) of the Clean Air Act (Act).

(A) All storage vessels that store liquids containing organic HAP. For purposes of regulation, surge control vessels and bottoms receivers that are located as part of the process train prior to the polymer reactor are to be regulated under the front-end process vent provisions.

(B) All process vents from continuous unit operations (front end process vents and back end process vents).

(C) All wastewater streams associated with the acetal resins production process unit as defined in (a)(2) of this section.

(D) Equipment (as defined in §63.1101 of this subpart) that contains or contacts organic HAP.

(ii) *Compliance schedule.* The compliance schedule for affected sources as defined in paragraph (a)(1)(i) of this section is specified in §63.1102(a).

(2) *Definitions.*

*Acetal resins production* means the production of homopolymers and/or copolymers of alternating oxymethylene units. Acetal resins are also known as polyoxymethylenes, polyacetals, and aldehyde resins. Acetal resins are generally produced by polymerizing formaldehyde (HCHO) with the methylene functional group (CH<sub>2</sub>) and are characterized by repeating oxymethylene units (CH<sub>2</sub>O) in the polymer backbone.

*Back end process vent* means any process vent from a continuous unit operation that is not a front end process vent up to the final separation of raw materials and by-products from the stabilized polymer.

*Front end process vent* means any process vent from a continuous unit operation involved in the purification of formaldehyde feedstock for use in the acetal homopolymer process. All front end process vents are restricted to those vents that occur prior to the polymer reactor.

(3) *Requirements.* Table 1 of this section specifies the acetal resins production standards applicability for existing and new sources. Applicability assessment procedures and methods are specified in §§63.1104 through 63.1107. An owner or operator of an affected source is not required to perform tests, TRE calculations or other applicability assessment procedures if they opt to comply with the most stringent requirements for an applicable emission point pursuant to this subpart. General compliance, recordkeeping, and reporting requirements are specified in §§63.1108 through 63.1112. Procedures for approval of alternative means of emission limitations are specified in §63.1113. The owner or operator must control organic HAP emissions from each affected source emission point by meeting the applicable requirements specified in table 1 of this section.

**Table 1 to §63.1103(a)—What Are My Requirements If I Own Or Operate An Acetal Resins Production Existing Or New Affected Source?**

<b>If you own or operate. . .</b>	<b>And if. . .</b>	<b>Then you must. . .</b>
1. A storage vessel with: 34 cubic meters <capacity	The maximum true vapor pressure of organic HAP >17.1 kilopascals (for existing sources) or >11.7	a. Reduce emissions of total organic HAP by 95 weight-percent by venting emissions through a closed vent system to any combination of control devices meeting the requirements of subpart SS (national emission

	kilopascals (for new sources)	standards for closed vent systems, control devices, recovery devices, and routing to a fuel gas system or a process), as specified in §63.982(a)(1) (storage vessel requirements) of this part; or
		b. Comply with the requirements of subpart WW (national emission standards for storage vessels (control level 2)) of this part.
2. A front end process vent from continuous unit operations		a. Reduce emissions of total organic HAP by using a flare meeting the requirements of subpart SS of this part; or
		b. Reduce emissions of total organic HAP by 60 weight-percent, or reduce TOC to a concentration of 20 parts per million by volume, whichever is less stringent, by venting emissions through a closed vent system to any combination of control devices meeting the requirements of subpart SS, as specified in §63.982(a)(2) (process vent requirements) of this part.
3. A back end process vent from continuous unit operations	The vent stream has a $TRE^a < 1.0$	a. Reduce emissions of total organic HAP by using a flare meeting the requirements of subpart SS of this part; or
		b. Reduce emissions of total organic HAP by 98 weight-percent, or reduce TOC to a concentration of 20 parts per million by volume, whichever is less stringent, by venting emissions through a closed vent system to any combination of control devices meeting the requirements of subpart SS, as specified in §63.982(a)(2) (process vent requirements) of this part; or
		c. Achieve and maintain a TRE index value greater than 1.0.
4. A back end process vent from continuous unit	$1.0 \leq TRE^a \leq 4.0$	Monitor and keep records of equipment operating parameters specified to be monitored under subpart SS, §§63.990(c)(absorber, condenser, and carbon adsorber

operations		monitoring) or 63.995(c) (other noncombustion systems used as a control device monitoring) of this part.
5. Equipment as defined under §63.1101	The equipment contains or contacts $\geq 10$ weight-percent organic HAP <sup>b</sup> , and operates $\leq 300$ hours per year	Comply with the requirements of subpart TT (national emission standards for equipment leaks (control level 1)) or subpart UU (national emission standards for equipment leaks (control level 2)) of this part.
6. An acetal resins production process unit that generates process wastewater	The process wastewater stream is a Group 1 or Group 2 wastewater stream	Comply with the requirements of §63.1106(a).
7. An acetal resins production process unit that generates maintenance wastewater	The maintenance wastewater contains organic HAP	Comply with the requirements of §63.1106(b).
8. An item of equipment listed in §63.1106(c)(1)	The item of equipment meets the criteria specified in §63.1106(c)(1) through (3) and either (c)(4)(i) or (ii)	Comply with the requirements in Table 35 of subpart G of this part.

<sup>a</sup>The TRE is determined according to the procedures specified in §63.1104(j).

<sup>b</sup>The weight-percent organic HAP is determined for equipment according to procedures specified in §63.1107.

(b) *Acrylic and modacrylic fiber production applicability, definitions, and requirements—(1)*

*Applicability—(i) Affected source.* For the acrylic fibers and modacrylic fibers production (as defined in paragraph (b)(2) of this section) source category, the affected source shall comprise all emission points, in combination, listed in paragraphs (b)(1)(i)(A) through (E) of this section, that are associated with a suspension or solution polymerization process unit that produces acrylic and modacrylic fiber located at a major source as defined in section 112(a) of the Act.

(A) All storage vessels that store liquid containing acrylonitrile or organic HAP.

(B) All process vents from continuous unit operations.

(C) All wastewater streams associated with the acrylic and modacrylic fibers production process unit as defined in (b)(2) of this section.

(D) Equipment (as defined in §63.1101 of this subpart) that contains or contacts acrylonitrile or organic HAP.

(E) All acrylic and modacrylic fiber spinning lines using a spinning solution or suspension having organic acrylonitrile or organic HAP. For the purposes of implementing this paragraph, a spinning line includes the spinning solution filters, spin bath, and the equipment used downstream of the spin bath to wash, dry, or draw the spun fiber.

(ii) *Compliance schedule.* The compliance schedule, for affected sources as defined in paragraph (b)(1)(i) of this section, is specified in §63.1102.

(2) *Definitions.*

*Acrylic fiber* means a manufactured synthetic fiber in which the fiber-forming substance is any long-chain synthetic polymer composed of at least 85 percent by weight of acrylonitrile units.

*Acrylic and modacrylic fibers production* means the production of either of the following synthetic fibers composed of acrylonitrile units:

(i) Acrylic fiber.

(ii) Modacrylic fiber.

*Acrylonitrile solution polymerization* means a process where acrylonitrile and comonomers are dissolved in a solvent to form a polymer solution (typically polyacrylonitrile). The polyacrylonitrile is soluble in the solvent. In contrast to suspension polymerization, the resulting reactor polymer solution (spin dope) is filtered and pumped directly to the fiber spinning process.

*Acrylonitrile suspension polymerization* means a polymerization process where small drops of acrylonitrile and comonomers are suspended in water in the presence of a catalyst where they polymerize under agitation. Solid beads of polymer are formed in this suspension reaction which are subsequently filtered, washed, refiltered, and dried. The beads must be subsequently redissolved in a solvent to create a spin dope prior to introduction to the fiber spinning process.

*Fiber spinning line* means the group of equipment and process vents associated with acrylic or modacrylic fiber spinning operations. The fiber spinning line includes (as applicable to the type of spinning process used) the blending and dissolving tanks, spinning solution filters, wet spinning units, spin bath tanks, and the equipment used downstream of the spin bath to wash, dry, or draw the spun fiber.

*In organic hazardous air pollutant or in organic HAP service* means, for acrylic and modacrylic fiber production affected sources, that a piece of equipment either contains or contracts a fluid (liquid or gas) that is at least 10 percent by weight of total organic HAP as determined according to the provisions of §63.180(d). The provisions of §63.180(d) also specify how to determine that a piece of equipment is not in organic HAP service.

*Modacrylic fiber* means a manufactured synthetic fiber in which the fiber-forming substance is any long-chain synthetic polymer composed of at least 35 percent by weight of acrylonitrile units but less than 85 percent by weight of acrylonitrile units.

*Seal* means, for acrylic and modacrylic fiber production affected sources complying with the requirements of §63.1033(b) or §63.167(a) on or after October 8, 2014, that instrument monitoring of the open-ended valve or line conducted according to the method specified in §63.1023(b) and, as applicable, §63.1023(c), or §63.180(b) and, as applicable, §63.180(c), indicates no readings of 500 parts per million or greater.

*Spin dope* means the liquid mixture of polymer and solvent that is fed to the spinneret to form the acrylic and modacrylic fibers.

(3) *Requirements.* An owner or operator of an affected source must comply with the requirements of paragraph (b)(3)(i) or (ii) of this section.

(i) Table 2 of this section specifies the acrylic and modacrylic fiber production source category control requirement applicability for both existing and new sources. Applicability assessment procedures and methods are specified in §§63.1104 through 63.1107. An owner or operator of an affected source is not required to perform tests, or other applicability assessment procedures if they opt to comply with the most stringent requirements for an applicable emission point pursuant to this subpart. General compliance, recordkeeping, and reporting requirements are specified in §§63.1108 through 63.1112. Procedures for approval of alternative means of emission limitations are specified in §63.1113. The owner or operator must control organic HAP emissions from each affected source emission point by meeting the applicable requirements specified in table 2 of this section.

**Table 2 to §63.1103(b)(3)(i)—What Are My Requirements if I Own or Operate an Acrylic and Modacrylic Fiber Production Existing or New Affected Source and Am Complying With Paragraph (b)(3)(i) of This Section?**

<b>If you own or operate. . .</b>	<b>And if. . .</b>	<b>Then you must. . .</b>
1. A storage vessel	The stored material contains organic HAP	a. Reduce emissions of organic HAP by 98 weight-percent by venting emissions through a closed vent system to any combination of control device meeting the requirements of subpart SS of this part, as specified in §63.982(a)(1) (storage vessel requirements), or 95 weight-percent or greater by venting through a closed vent system to a recovery device meeting the requirements of subpart SS, §63.993 (recovery device requirements); or
		b. Comply with the requirements of subpart WW of this part.
2. A process vent from	The vent steam has a mass	a. Reduce emissions of organic HAP or TOC



<p>continuous unit operations (halogenated)</p>	<p>emission rate of halogen atoms contained in organic compounds <math>\geq 0.45</math> kilograms per hour,<sup>a</sup> and an organic HAP concentration <math>\geq 50</math> parts per million by volume<sup>b</sup> and an average flow rate <math>\geq 0.005</math> cubic meters per minute</p>	<p>as specified for nonhalogenated process vents from continuous unit operations (other than by using a flare) by venting emissions through a closed vent system to a halogen reduction device meeting the requirements of subpart SS of this part, §63.994 (halogen reduction devices requirements) that reduces hydrogen halides and halogens by 99 weight-percent or to less than 0.45 kilograms per year, whichever is less stringent; or</p>
		<p>b. Reduce the process vent halogen atom mass emission rate to less than 0.45 kilograms per hour by venting emissions through a closed vent system to a halogen reduction device meeting the requirements of subpart SS of this part, §63.994 (halogen reduction devices requirements) and then complying with the requirements specified for process vents from continuous unit operations (nonhalogenated).</p>
<p>3. A process vent from continuous unit operations (nonhalogenated)</p>	<p>The vent steam has a mass emission rate of halogen atoms contained in organic compounds <math>&lt; 0.45</math> kilograms per hour,<sup>a</sup> and an organic HAP concentration <math>\geq 50</math> parts per million by volume<sup>b</sup> and an average flow rate <math>\geq 0.005</math> cubic meters per minute</p>	<p>a. Reduce emissions of organic HAP by using a flare meeting the requirements of subpart SS of this part, §63.987 (flare requirements); or  b. Reduce emissions of organic HAP by 98 weight-percent, or reduce TOC to a concentration of 20 parts per million by volume, whichever is less stringent, by venting emissions through a closed vent system to any combination of control devices meeting the requirements of subpart SS of this part, as specified in §63.982(a)(2) (process vent requirements).</p>
<p>4. A fiber spinning line that is a new or reconstructed source</p>	<p>The lines use a spin dope produced from either a suspension polymerization process or solution polymerization process</p>	<p>a. Reduce organic HAP emissions by 85 weight-percent or more. (For example, you may enclose the spinning and washing areas of the spinning line (as specified in paragraph (b)(4) of this section) and vent through a closed vent system and use any combination of control devices meeting the requirements</p>

		of subpart SS of this part, as specified in §63.982(a.); or
		b. Reduce organic HAP emissions from the spinning line to less than or equal to 0.25 kilograms of organic HAP per megagram (0.5 pounds of organic HAP per ton) of acrylic and modacrylic fiber produced; or
		c. Reduce the organic HAP concentration of the spin dope to less than 100 ppmw.
5. A fiber spinning line that is an existing source	The spinning line uses a spin dope produced from a solution polymerization process	Reduce organic HAP emissions from the spinning line to less than or equal to 20 kilograms of organic HAP per megagram (40 pounds of organic HAP per ton) of acrylic and modacrylic fiber produced.
6. A fiber spinning line that is an existing source	The spinning line uses a spin dope produced from a suspension polymerization process	a. Reduce the organic HAP concentration of the spin dope to less than 100 ppmw; <sup>b</sup> or b. Reduce organic HAP emissions from the spinning line to less than or equal to 0.25 kilograms of organic HAP per megagram of acrylic and modacrylic fiber produced.
7. Equipment as defined under §63.1101 (with the differences for pressure relief devices described in item 11 below)	It contains or contacts $\geq 10$ weight-percent organic HAP, <sup>c</sup> and operates $\geq 300$ hours per year	a. Comply with either §63.1008 or §63.1027 for connectors in gas and vapor service and in light liquid service, and comply with the requirements of subpart UU of this part, except §63.1030, for all other applicable equipment; or
		b. Comply with the requirements in subpart H of this part, except §63.165, as provided by the regulatory overlap provisions in §63.1100(g)(4)(ii).
8. An acrylic and modacrylic fiber production process unit that generates process	The process wastewater stream is a Group 1 or Group 2 wastewater stream	Comply with the requirements of §63.1106(a).

wastewater		
9. An acrylic and modacrylic fiber production process unit that generates maintenance wastewater	The maintenance wastewater contains organic HAP	Comply with the requirements of §63.1106(b).
10. An item of equipment listed in §63.1106(c)(1)	The item of equipment meets the criteria specified in §63.1106(c)(1) through (3) and either (c)(4)(i) or (ii)	Comply with the requirements in Table 35 of subpart G of this part.
11. Pressure relief devices	The pressure relief device is in organic HAP service	Comply with §63.1107(e).

<sup>a</sup>The mass emission rate of halogen atoms contained in organic compounds is determined according to the procedures specified in §63.1104(i).

<sup>b</sup>The percent by weight organic HAP is determined according to the procedures specified in §63.1107.

<sup>c</sup>The weight-percent organic HAP is determined for equipment according to procedures specified in §63.1107.

(ii) The owner or operator must control organic HAP emissions from the acrylic and modacrylic fibers production facility by meeting the applicable requirements specified in table 3 of this section. The owner or operator must determine the facility organic HAP emission rate using the procedures specified in paragraph (b)(5) of this section. Applicability assessment procedures and methods are specified in §§63.1104 through 63.1107. An owner or operator of an affected source does not have to perform tests, TRE calculations or other applicability assessment procedures if they opt to comply with the most stringent requirements for an applicable emission point pursuant to this subpart. General compliance, recordkeeping, and reporting requirements are specified in §§63.1108 through 63.1112. Procedures for approval of alternative means of emission limitations are specified in §63.1113.

**Table 3 to §63.1103(b)(3)(ii)—What Are My Requirements If I Own or Operate an Acrylic and Modacrylic Fiber Production Existing or New Affected Source and Am Complying With Paragraph (b)(3)(ii) of This Section?**

<b>If you own or operate . . .</b>	<b>Then you must control total organic HAP emissions from the affected source by . . .</b>
1. An acrylic and modacrylic fibers production affected source and your	Meeting all of following requirements: a. Reduce total organic HAP emissions from all affected storage vessels, process vents, wastewater streams associated with the

facility is an existing source	acrylic and modacrylic fibers production process unit as defined in paragraph (b)(2) of this section, and fiber spinning lines operated in your acrylic and modacrylic fibers production facility to less than or equal to 0.5 kilograms (kg) of organic HAP per megagram (Mg) of fiber produced.
	b. Determine the facility organic HAP emission rate in accordance with the requirements specified in paragraph (b)(5) of this section.
2. An acrylic and modacrylic fibers production affected source and your facility is a new source	Meeting all of following requirements: a. Reduce total organic HAP emissions from all affected storage vessels, process vents, wastewater streams associated with the acrylic and modacrylic fibers production process unit as defined in paragraph (b)(2) of this section, and fiber spinning lines operated in your acrylic and modacrylic fibers production facility to less than or equal to 0.25 kilograms (kg) of organic HAP per megagram (Mg) of fiber produced.
	b. Determine the facility organic HAP emission rate in accordance with the requirements specified in paragraph (b)(5) of this section.
3. Equipment as defined under §63.1101 and it contains or contacts >10 weight-percent organic HAP, <sup>a</sup> and operates >300 hours per year (with the differences for pressure relief devices described in item 4 below)	a. Comply with either §63.1008 or §63.1027 for connectors in gas and vapor service and in light liquid service, and comply with subpart UU of this part, except §63.1030, for all other applicable equipment; or b. Comply with the requirements in subpart H of this part, except §63.165, as provided by the regulatory overlap provisions in §63.1100(g)(4)(ii).
4. A pressure relief device in organic HAP service	Complying with §63.1107(e).

(4) *Fiber spinning line enclosure requirements.* For an owner or operator of a new or modified source electing to comply with paragraph (b)(3)(i) of this section, the fiber spinning line enclosure must be designed and operated to meet the requirements specified in paragraphs (b)(4)(i) through (iv) of this section.

(i) The enclosure must cover the spinning and washing areas of the spinning line.

(ii) The enclosure must be designed and operated in accordance with the criteria for a permanent total enclosure as specified in “Procedure T—Criteria for and Verification of a Permanent or Temporary Total Enclosure” in 40 CFR 52.741, appendix B.

(iii) The enclosure may have permanent or temporary openings to allow worker access; passage of material into or out of the enclosure by conveyor, vehicles, or other mechanical means; entry of permanent mechanical or electrical equipment; or to direct airflow into the enclosure.

(iv) The owner or operator must perform the verification procedure for the enclosure as specified in section 5.0 to “Procedure T—Criteria for and Verification of a Permanent or Temporary Total Enclosure” initially when the enclosure is first installed and, thereafter, annually.

(5) *Facility organic HAP emission rate determination.* For an owner or operator electing to comply with paragraph (b)(3)(ii) of this section, the facility organic HAP emission rate must be determined using the requirements specified in paragraphs (b)(5)(i) through (iii) of this section.

(i) The owner or operator must prepare an initial determination of the facility organic HAP emission rate.

(ii) Whenever changes to the acrylic or modacrylic fiber production operations at the facility could potentially cause the facility organic HAP emission rate to exceed the applicable limit of kilogram of organic HAP per Megagram of fiber produced, the owner or operator must prepare a new determination of the facility organic HAP emission rate.

(iii) For each determination, the owner or operator must prepare and maintain at the facility site sufficient process data, emissions data, and any other documentation necessary to support the facility organic HAP emission rate calculation.

(c) *Hydrogen fluoride production applicability, definitions, and requirements—(1) Applicability—(i) Affected source—*For the hydrogen fluoride production (as defined in paragraph (c)(2) of this section) source category, the affected source shall comprise all emission points, in combination, listed in paragraphs (c)(1)(i)(A) through (D) of this section, that are associated with a hydrogen fluoride production process unit located at a major source as defined in section 112(a) of the Act.

(A) All storage vessels used to accumulate or store hydrogen fluoride.

(B) All process vents from continuous unit operations associated with hydrogen fluoride recovery and refining operations. These process vents include vents on condensers, distillation units, and water scrubbers.

(C) All transfer racks used to load hydrogen fluoride into tank trucks or railcars.

(D) Equipment in hydrogen fluoride service (as defined in paragraph (c)(2) of this section).

(2) *Definitions.*

*Connector* means flanged, screwed, or other joined fittings used to connect two pipelines or a pipeline and a piece of equipment. A common connector is a flange. Joined fittings welded completely around the circumference of the interface are not considered connectors for the purposes of this subpart.

*Equipment* means each pump, compressor, agitator, pressure relief device, sampling connection system, open-ended valve or line, valve, connector, and instrumentation system in hydrogen fluoride service; and any control devices or closed-vent systems used to comply with this subpart.

*Hydrogen fluoride production* means a process engaged in the production and recovery of hydrogen fluoride by reacting calcium fluoride with sulfuric acid. For the purpose of implementing this subpart, hydrogen fluoride production is not a process that produces gaseous hydrogen fluoride for direct reaction with hydrated aluminum to form aluminum fluoride (i.e., the hydrogen fluoride is not recovered as an intermediate or final product prior to reacting with the hydrated aluminum).

*In hydrogen fluoride service* means that a piece of equipment either contains or contacts a hydrogen fluoride process fluid (liquid or gas).

*In vacuum service* means that equipment is operating at an internal pressure which is at least 5 kilopascals below ambient pressure.

*Instrumentation system* means a group of equipment components used to condition and convey a sample of the process fluid to analyzers and instruments for the purpose of determining process operating conditions (e.g., composition, pressure, flow, etc.). Valves and connectors are the predominant type of equipment used in instrumentation systems; however, other types of equipment may also be included in these systems.

*Kiln seal* means the mechanical or hydraulic seals at both ends of the kiln, designed to prevent the infiltration of moisture and air through the interface of the rotating kiln and stationary pipes and equipment attached to the kiln during normal vacuum operation of the kiln (operation at an internal pressure of at least 0.25 kilopascal [one inch of water] below ambient pressure).

*Leakless pump* means a pump whose seals are submerged in liquid, a magnetically-driven pump, a pump equipped with a dual mechanical seal system that includes a barrier fluid system, a canned pump, or other pump that is designed with no externally actuated shaft penetrating the pump housing.

*Open-ended valve or line* means any valve, except relief valves, having one side of the valve seat in contact with process fluid and one side open to the atmosphere, either directly or through open piping.

*Pressure release* means the emission of materials resulting from the system pressure being greater than the set pressure of the relief device. This release can be one release or a series of releases over a short time period due to a malfunction in the process.

*Pressure relief device or valve* means a safety device used to prevent operating pressures from exceeding the maximum allowable working pressure of the process equipment. A common pressure relief device is a spring-loaded pressure relief valve. Devices that are actuated either by a pressure of less than or equal to 2.5 pounds per square inch gauge or by a vacuum are not pressure relief devices.

*Relief device or valve* means a valve used only to release an unplanned, nonroutine discharge. A relief valve discharge can result from an operator error, a malfunction such as a power failure or equipment failure, or other unexpected cause that requires immediate venting of gas from process equipment in order to avoid safety hazards or equipment damage.

*Repaired* for the purpose of this regulation means equipment is adjusted, or otherwise altered, to eliminate a leak identified by sensory monitoring.

*Sampling connection system* means an assembly of equipment within a process unit or affected facility used during periods of representative operation to take samples of the process fluid. Equipment used to take nonroutine grab samples is not considered a sampling connection system.

*Sensory monitoring* means the detection of a potential leak to the atmosphere by walk-through visual, audible, or olfactory monitoring. Comprehensive component-by-component inspection is not required.

*Shift* means the time a shift operator normally works, typically 8 or 12 hours.

(3) *Requirements.* Table 4 of this section specifies the hydrogen fluoride production source category applicability and control requirements for both existing and new sources. The owner or operator must control hydrogen fluoride emissions from each affected source emission point as specified in table 4. General compliance, recordkeeping, and reporting requirements are specified in §§63.1108 through 63.1112. Specific monitoring, recordkeeping, and reporting requirements are specified in table 4. Minimization of emissions from startups, shutdowns, and malfunctions, including those resulting from kiln seals must be addressed in the startup, shutdown, and malfunction plan required by §63.1111; the plan must also establish reporting and recordkeeping of such events. Procedures for approval of alternative means of emission limitations are specified in §63.1113.

**Table 4 to §63.1103(c)—What Are My Requirements If I Own or Operate a Hydrogen Fluoride Production Existing or New Affected Source?**

<b>If you own or operate . . .</b>	<b>And if . . .</b>	<b>Then you must . . .</b>
1. A storage vessel	The stored material is hydrogen fluoride	Reduce emissions of hydrogen fluoride by venting displacement emissions created by normal filling or emptying activities through a closed-vent system to a recovery system or wet scrubber that is designed and operated to achieve a 99 weight-percent removal efficiency. The minimum liquid flow rate to the scrubber that achieves a 99 weight-percent removal efficiency shall be established, and may be done so by design analysis. The liquid flow rate to the scrubber shall be continuously monitored and records maintained according to §§63.996 and 63.998(b), (c), and (d)(3) of 40 CFR subpart SS of this part. The Periodic Report specified in §63.1110(a)(5) of this subpart shall include the information specified in §63.999(c) of 40 CFR subpart SS of this part, as applicable.
2. A process vent from continuous unit operations	The vent stream is from hydrogen fluoride recovery and refining vessels	Reduce emissions of hydrogen fluoride from the process vent by venting emissions through a closed-vent system to a wet scrubber that is designed and operated to achieve a 99 weight-percent removal efficiency. Monitoring, recordkeeping, and reporting of wet scrubber operation shall be in accordance with the requirements stated above for a wet scrubber controlling

		hydrogen fluoride emissions from a storage vessel.
3. A transfer rack	The transfer rack is associated with bulk hydrogen fluoride liquid loading into tank trucks and rail cars	Reduce emissions of hydrogen fluoride by venting emissions through a closed-vent system to a recovery system or wet scrubber that is designed and operated to achieve a 99 weight-percent removal efficiency. Monitoring, recordkeeping, and reporting of wet scrubber operation shall be in accordance with the requirements stated above for a wet scrubber controlling HF emissions from a storage vessel. You also must load hydrogen fluoride into only tank trucks and railcars that have a current certification in accordance with the U.S. DOT pressure test requirements of 49 CFR part 180 for tank trucks and 49 CFR 173.31 for railcars; or have been demonstrated to be vapor-tight (i.e. will sustain a pressure change of not more than 750 Pascals within 5 minutes after it is pressurized to a minimum of 4,500 Pascals) within the preceding 12 months.
4. Equipment	It is in hydrogen fluoride service and operates $\geq 300$ hours per year and is not in vacuum service	Control hydrogen fluoride emissions by using leakless pumps and by implementing a sensory monitoring leak detection program. Equipment that is excluded from sensory monitoring because it operates less than 300 hours per year or is in vacuum service shall be identified by list, location, or other method and the identity shall be recorded. An owner or operator is required to perform sensory monitoring at least once every shift, but no later than within 15 days. When a leak is detected, repair must begin within one hour and be completed as soon as practical. A record shall be kept of each leak detected and repaired including: equipment identification number, date and time the leak was detected and that repair was initiated, and the date of successful repair.

(d) *Polycarbonate production applicability, definitions, and requirements*—(1) *Applicability*—(i) *Affected source*. For the polycarbonate production (as defined in paragraph (d)(2) of this section) source category, the affected source shall comprise all emission points, in combination, listed in paragraphs (d)(1)(i)(A) through (D) of this section, that are part of a polycarbonate production process unit located at a major source as defined in section 112(a) of the Act. For the purposes of this rule, a polycarbonate production process unit is a unit that produces polycarbonate by interfacial polymerization from bisphenols and phosgene. Phosgene production units that are associated with polycarbonate production process units are considered to be part of the polycarbonate production process. A phosgene production unit consists of the reactor in which phosgene is formed and all equipment (listed in paragraphs (d)(1)(i)(A) through (D) of this section) downstream of the reactor that provides phosgene for the production of polycarbonate. Therefore, for the purposes of this rule, such a phosgene production unit is considered to be a polycarbonate production process unit.



- (A) All storage vessels that store liquids containing organic HAP.
  - (B) All process vents from continuous and batch unit operations.
  - (C) All wastewater streams.
  - (D) Equipment (as defined in §63.1101 of this subpart) that contains or contacts organic HAP.
- (ii) *Compliance schedule.* The compliance schedule, for affected sources as defined in paragraph (d)(1)(i) of this section, is specified in §63.1102.

(2) *Definitions.*

*In organic hazardous air pollutant or in organic HAP service* means, for polycarbonate production affected sources, that a piece of equipment either contains or contracts a fluid (liquid or gas) that is at least 5 percent by weight of total organic HAP as determined according to the provisions of §63.180(d). The provisions of §63.180(d) also specify how to determine that a piece of equipment is not in organic HAP service.

*Polycarbonate production* means a process engaged in the production of a special class of polyester formed from any dihydroxy compound and any carbonate diester or by ester exchange. Polycarbonate may be produced by solution or emulsion polymerization, although other methods may be used. A typical method for the manufacture of polycarbonate includes the reaction of bisphenol-A with phosgene in the presence of pyridine or other catalyst to form polycarbonate. Methylene chloride or other solvents are used in this polymerization reaction.

*Seal* means, for polycarbonate production affected sources complying with the requirements of §63.1033(b) or §63.167(a) or after October 8, 2014, that instrument monitoring of the open-ended valve or line conducted according to the method specified in §63.1023(b) and, as applicable, §63.1023(c), or §63.180(b) and, as applicable, §63.180(c), indicates no readings of 500 parts per million or greater.

(3) *Requirements.* Tables 5 and 6 of this section specify the applicability criteria and standards for existing and new sources within the polycarbonate production source category. The owner or operator must control organic HAP emissions from each affected source emission point by meeting the applicable requirements specified in tables 5 and 6. Applicability assessment procedures and methods are specified in §§63.1104 through 63.1107. An owner or operator of an affected source is not required to perform tests, TRE calculations or other applicability assessment procedures if they opt to comply with the most stringent requirements for an applicable emission point pursuant to this subpart. General compliance, recordkeeping, and reporting requirements are specified in §§63.1108 through 63.1112. Procedures for approval of alternative means of emission limitations are specified in §63.1113.

**Table 5 to §63.1103(d)—What Are My Requirements If I Own or Operate A Polycarbonate Production Existing Affected Source?**

<b>If you own or operate...</b>	<b>And if...</b>	<b>Then you must...</b>
1. A storage vessel with:	27.6 kilopascals	Reduce emissions of total organic HAP by 95

75 cubic meters ≤capacity <151 cubic meters	≤maximum true vapor pressure of total organic HAP <76.6 kilopascals	weight-percent by venting emissions through a closed vent system to any combination of control devices meeting the requirements of subpart SS (national emission standards for closed vent systems, control devices, recovery devices, and routing to a fuel gas system or a process), as specified in §63.982(a)(1) (storage vessel requirements) of this part; or comply with the requirements of subpart WW (national emission standards for storage vessels (control level 2)) of this part.
2. A storage vessel with: 151 cubic meters ≤capacity	The maximum true vapor pressure of total organic HAP ≥5.2 kilopascals	Reduce emissions of total organic HAP by 98 weight-percent by venting emissions through a closed vent system to any combination of control devices meeting the requirements of subpart SS, as specified in §63.982(a)(1) (storage vessel requirements) of this part
3. A storage vessel with: 75 cubic meters ≤capacity <151 cubic meters	The maximum true vapor pressure of total organic HAP ≥76.6 kilopascals	Reduce emissions of total organic HAP by 95 weight-percent by venting emissions through a closed vent system to any combination of control devices meeting the requirements of subpart SS, as specified in §63.982(a)(1) (storage vessel requirements) of this part.
4. A process vent from continuous unit operations or a combined vent stream <sup>a</sup> (halogenated)	The vent stream has a TRE <sup>bc</sup> ≤2.7	a. Reduce emissions of total organic HAP by 98 weight-percent, or reduce total organic HAP to a concentration of 20 parts per million by volume, whichever is less stringent, by venting emissions through a closed vent system to any combination of control devices meeting the requirements of subpart SS of this part, as specified in §63.982(c)(2) and (e); and then vent emissions from those control device(s) through a closed vent system to a halogen reduction device meeting the requirements of subpart SS, §63.994, that reduces hydrogen halides and halogens by 99 weight-percent or to less than 0.45 kilograms per hour, <sup>d</sup> whichever is less stringent; or
		b. Reduce the process vent halogen atom mass emission rate to less than 0.45 kilograms per hour by venting emissions through a closed vent system to a halogen reduction device meeting the requirements

		of subpart SS of this part, §63.994; and then vent emissions from those control device(s) through a closed vent system to any combination of control devices meeting the requirements of subpart SS, as specified in §63.982(c)(2) and (e), that reduces emissions of total organic HAP by 98 weight-percent, or reduce total organic HAP or TOC to a concentration of 20 parts per million by volume, whichever is less stringent; or
		c. Achieve and maintain a TRE index value greater than 2.7.
5. A process vent from continuous unit operations or a combined vent stream <sup>a</sup> (nonhalogenated)	The vent stream has a $TRE^{bc} \leq 2.7$	a. Reduce emissions of total organic HAP by 98 weight-percent; or reduce total organic HAP to a concentration of 20 parts per million by volume; whichever is less stringent, by venting emissions through a closed vent system to any combination of control devices meeting the requirements of subpart SS of this part, as specified in §63.982(a)(2) (process vent requirements); or
		b. Achieve and maintain a TRE index value greater than 2.7.
6. A process vent from continuous unit operations or a combined vent stream <sup>a</sup>	$2.7 < TRE^{bc} \leq 4.0$	Monitor and keep records of equipment operating parameters specified to be monitored under subpart SS of this part, §§63.982(e) and 63.993(c) (absorbers, condensers, carbon adsorbers and other recovery devices used as final recovery devices).
7. Equipment as defined under §63.1101 (with the differences for pressure relief devices described in item 11 below)	The equipment contains or contacts $\geq 5$ weight-percent total organic HAP, <sup>e</sup> and operates $\geq 300$ hours per year	a. Comply with either §63.1008 or §63.1027 for connectors in gas and vapor service and in light liquid service, and comply with the requirements of subpart UU of this part, except §63.1030, for all other applicable equipment; or
		b. Comply with the requirements in subpart H of this part, except §63.165, as provided by the regulatory overlap provisions in §63.1100(g)(4)(ii).

8. A polycarbonate production process unit that generates process wastewater	The process wastewater stream is a Group 1 or a Group 2 wastewater stream	Comply with the requirements of §63.1106(a).
9. A polycarbonate production process unit that generates maintenance wastewater	The maintenance wastewater contains organic HAP	Comply with the requirements of §63.1106(b).
10. An item of equipment listed in §63.1106(c)(1)	The item of equipment meets the criteria specified in §63.1106(c)(1) through (3) and either (c)(4)(i) or (ii)	Comply with the requirements in Table 35 of subpart G of this part.
11. Pressure relief devices	The pressure relief device is in organic HAP service	Comply with §63.1107(e).

<sup>a</sup>Combined vent streams shall use the applicability determination procedures and methods for process vents from continuous unit operations (§63.1104).

<sup>b</sup>The TRE equation coefficients for halogenated streams (table 1 of §63.1104(j)(1)) shall be used to calculate the TRE index value.

<sup>c</sup>The TRE is determined according to the procedures specified in §63.1104(j). If a dryer is manifolded with such vents, and the vent is routed to a recovery, recapture, or combustion device, then the TRE index value for the vent must be calculated based on the properties of the vent stream (including the contributions of the dryer). If a dryer is manifolded with other vents and not routed to a recovery, recapture, or combustion device, then the TRE index value must be calculated excluding the contributions of the dryer. The TRE index value for the dryer must be calculated separately in this case.

<sup>d</sup>The mass emission rate of halogen atoms contained in organic compounds is determined according to the procedures specified in §63.1104(i).

<sup>e</sup>The weight-percent organic HAP is determined for equipment according to procedures specified in §63.1107.

**Table 6 to §63.1103(d)—What are My Requirements If I Own or Operate a Polycarbonate Production New Affected Source?**

<b>If you own or operate. . .</b>	<b>And if. . .</b>	<b>Then you must. . .</b>
-----------------------------------	--------------------	---------------------------

1. A storage vessel with: 38 cubic meters $\leq$ capacity <151 cubic meters	13.1 kilopascals $\leq$ maximum true vapor pressure of total organic HAP <76.6 kilopascals	a. Reduce emissions of total organic HAP by 95 weight-percent by venting emissions through a closed vent system to any combination of control devices meeting the requirements of subpart SS (national emission standards for closed vent systems, control devices, recovery devices, and routing to a fuel gas system or a process), as specified in §63.982(a)(1) (storage vessel requirements) of this part; or b. Comply with the requirements of subpart WW (national emission standards for storage vessels (control level 2)) of this part.
2. A storage vessel with: 151 cubic meters $\leq$ capacity	The maximum true vapor pressure of total organic HAP is $\geq$ 5.2 kilopascals	Reduce emissions of total organic HAP by 98 weight-percent by venting emissions through a closed vent system to any combination of control devices meeting the requirements of subpart SS, as specified in §63.982(a)(1) (storage vessel requirements) of this part.
3. A storage vessel with: 38 cubic meters $\leq$ capacity <151 cubic meters	The maximum true vapor pressure of total organic HAP is $\geq$ 76.6 kilopascals	Reduce emissions of total organic HAP by 95 weight-percent by venting emissions through a closed vent system to any combination of control devices meeting the requirements of subpart SS, as specified in §63.982(a)(1) (storage vessel requirements) of this part.
4. A process vent from continuous unit operations or a combined vent stream <sup>a</sup> (halogenated)	The vent stream has a TRE <sup>bc</sup> $\leq$ 9.6	a. Reduce emissions of total organic HAP by 98 weight-percent, or reduce total organic HAP to a concentration of 20 parts per million by volume, whichever is less stringent, by venting emissions through a closed vent system to any combination of control devices meeting the requirements of subpart SS of this part, as specified in §63.982(c)(2) and (e); and then vent emissions from those control device(s) through a closed vent system to a halogen reduction device meeting the requirements of subpart SS, §63.994, that reduces hydrogen halides and halogens by 99 weight-percent or to less than 0.45 kilograms per hour, <sup>d</sup> whichever is less stringent; or
		b. Reduce the process vent halogen atom mass emission rate to less than 0.45 kilograms per hour by venting emissions through a closed vent system to a

		halogen reduction device meeting the requirements of subpart SS of this part, §63.994; and then vent emissions from those control device(s) through a closed vent system to any combination of control devices meeting the requirements of subpart SS, as specified in §63.982(c)(2) and (e), that reduces emissions of total organic HAP by 98 weight-percent, or reduce total organic HAP or TOC to a concentration of 20 parts per million by volume, whichever is less stringent; or
		c. Achieve and maintain a TRE index value greater than 9.6.
5. A process vent from continuous unit operations or a combined vent stream <sup>a</sup> (nonhalogenated)	The vent stream has a TRE <sup>bc</sup> ≤9.6	a. Reduce emissions of total organic HAP by 98 weight-percent; or reduce total organic HAP to a concentration of 20 parts per million by volume; whichever is less stringent, by venting emissions through a closed vent system to any combination of control devices meeting the requirements of subpart SS of this part, as specified in §63.982(a)(2) (process vent requirements); or b. Achieve and maintain a TRE index value greater than 9.6.
6. Equipment as defined under §63.1101 (with the differences for pressure relief devices described in item 6 below)	The equipment contains or contacts ≥5 weight-percent total organic HAP <sup>c</sup> , and operates ≥300 hours per year	a. Comply with either §63.1008 or §63.1027 for connectors in gas and vapor service and in light liquid service, and comply with the requirements of subpart UU of this part, except §63.1030, for all other applicable equipment; or
		b. Comply with the requirements in subpart H of this part, except §63.165, as provided by the regulatory overlap provisions in §63.1100(g)(4)(ii).
7. Pressure relief devices	The pressure relief device is in organic HAP service	Comply with §63.1107(e).

<sup>a</sup>Combined vent streams shall use the applicability determination procedures and methods for process vents from continuous unit operations (§63.1104).

<sup>b</sup>The TRE equation coefficients for halogenated streams (Table 1 of §63.1104(j)(1) of this subpart) shall be used to calculate the TRE index value.

<sup>c</sup>The TRE is determined according to the procedures specified in §63.1104(j). If a dryer is manifolded with such vents, and the vent is routed to a recovery, recapture, or combustion device, then the TRE index value for the vent must be calculated based on the properties of the vent stream (including the contributions of the dryer). If a dryer is manifolded with other vents and not routed to a recovery, recapture, or combustion device, then the TRE index value must be calculated excluding the contributions of the dryer. The TRE index value for the dryer must be calculated separately in this case.

<sup>d</sup>The mass emission rate of halogen atoms contained in organic compounds is determined according to the procedures specified in §63.1104(i).

<sup>e</sup>The weight-percent organic HAP is determined for equipment according to procedures specified in §63.1107.

(e) *Ethylene production applicability, definitions, and requirements*—(1) *Applicability*—(i) *Affected source*. For the ethylene production (as defined in paragraph (e)(2) of this section) source category, the affected source shall comprise all emission points listed in paragraphs (e)(1)(i) (A) through (G) of this section that are associated with an ethylene production unit that is located at a major source, as defined in section 112(a) of the Act.

(A) All storage vessels (as defined in §63.1101) that store liquids containing organic HAP.

(B) All ethylene process vents (as defined in paragraph (e)(2) of this section) from continuous unit operations.

(C) All transfer racks (as defined in paragraph (e)(2) of this section) that load HAP-containing material.

(D) Equipment (as defined in §63.1101) that contains or contacts organic HAP.

(E) All waste streams (as defined in paragraph (e)(2) of this section) associated with an ethylene production unit.

(F) All heat exchange systems (as defined in paragraph (e)(2) of this section) associated with an ethylene production unit.

(G) All ethylene cracking furnaces and associated decoking operations.

(ii) *Exceptions*. The emission points listed in paragraphs (e)(1)(ii) (A) through (L) of this section are in the ethylene production source category but are not subject to the requirements of paragraph (e)(3) of this section.

(A) Equipment that is located within an ethylene production unit that is subject to this subpart but does not contain organic HAP.

(B) Stormwater from segregated sewers.

(C) Water from fire-fighting and deluge systems in segregated sewers.

- (D) Spills.
  - (E) Water from safety showers.
  - (F) Water from testing of fire-fighting and deluge systems.
  - (G) Vessels storing organic liquids that contain organic HAP as impurities.
  - (H) Transfer racks, loading arms, or loading hoses that only transfer liquids containing organic HAP as impurities.
  - (I) Transfer racks, loading arms, or loading hoses that vapor balance during all transfer operations.
  - (J) Air emissions from all ethylene cracking furnaces, including emissions during decoking operations.
  - (K) Pressure vessels designed to operate in excess of 204.9 kilopascals and without emissions to the atmosphere.
  - (L) Vessels permanently attached to motor vehicles such as trucks, railcars, barges, or ships.
- (iii) *Exclusions.* The provisions of this subpart do not apply to process units and emission points subject to subparts F, G, H, I and CC of this part.
- (iv) *Compliance schedule.* The compliance schedule for the ethylene production source category is specified in §63.1102.

(2) *Definitions.* *Ethylene process vent* means a gas stream with a flow rate greater than 0.005 standard cubic meters per minute containing greater than 20 parts per million by volume HAP that is continuously discharged during operation of an ethylene production unit, as defined in this section. Ethylene process vents are gas streams that are discharged to the atmosphere (or the point of entry into a control device, if any) either directly or after passing through one or more recovery devices. Ethylene process vents do not include relief valve discharges; gaseous streams routed to a fuel gas system; leaks from equipment regulated under this subpart; episodic or nonroutine releases such as those associated with startup, shutdown, and malfunction; and in situ sampling systems (online analyzers).

*Ethylene production or production unit* means a chemical manufacturing process unit in which ethylene and/or propylene are produced by separation from petroleum refining process streams or by subjecting hydrocarbons to high temperatures in the presence of steam. The ethylene production unit includes the separation of ethylene and/or propylene from associated streams such as a C<sub>4</sub> product, pyrolysis gasoline, and pyrolysis fuel oil. Ethylene production does not include the manufacture of SOCOMI chemicals such as the production of butadiene from the C<sub>4</sub> stream and aromatics from pyrolysis gasoline.

*Heat exchange system* means any cooling tower system or once-through cooling water system (e.g., river or pond water). A heat exchange system can include an entire recirculating or once-through cooling system.

*Organic HAP* means the compounds listed in Table 1 to subpart XX of this part.



*Transfer rack* means the collection of loading arms and loading hoses at a single loading rack that is used to fill tank trucks and/or railcars with organic HAP. Transfer rack includes the associated pumps, meters, shutoff valves, relief valves, and other piping and valves. Transfer rack does not include racks, arms, or hoses that contain organic HAP only as impurities; or racks, arms, or hoses that vapor balance during all loading operations.

*Waste* means any material resulting from industrial, commercial, mining, or agricultural operations, or from community activities, that is discarded or is being accumulated, stored, or physically, chemically, thermally, or biologically treated prior to being discarded, recycled, or discharged.

*Waste stream* means the waste generated by a particular process unit, product tank, or waste management unit. The characteristics of the waste stream (e.g., flow rate, HAP concentration, water content) are determined at the point of waste generation. Examples of a waste stream include process wastewater, product tank drawdown, sludge and slop oil removed from waste management units, and landfill leachate.

(3) *Requirements.* The owner or operator must control organic HAP emissions from each affected source emission point by meeting the applicable requirements specified in Table 7 to this section. An owner or operator must perform the applicability assessment procedures and methods for process vents specified in §63.1104, except for paragraphs (d), (g), (h), (i), (j), (l)(1), and (n). An owner or operator must perform the applicability assessment procedures and methods for equipment leaks specified in §63.1107. General compliance, recordkeeping, and reporting requirements are specified in §§63.1108 through 63.1112. Minimization of emissions from startup, shutdown, and malfunctions must be addressed in the startup, shutdown, and malfunction plan required by §63.1111; the plan must also establish reporting and recordkeeping of such events. Procedures for approval of alternate means of emission limitations are specified in §63.1113.

**Table 7 to §63.1103(e)—What Are My Requirements if I Own or Operate an Ethylene Production Existing or New Affected Source?**

<b>If you own or operate . . .</b>	<b>And if . . .</b>	<b>Then you must . . .</b>
(a) A storage vessel (as defined in §63.1101) that stores liquid containing organic HAP	(1) The maximum true vapor pressure of total organic HAP is $\geq 3.4$ kilopascals but $< 76.6$ kilopascals; and the capacity of the vessel is $\geq 4$ cubic meters but $\leq 95$ cubic meters	(i) Fill the vessel through a submerged pipe; or (ii) Comply with the requirements for storage vessels with capacities $\geq 95$ cubic meters.
(b) A storage vessel (as defined in §63.1101) that stores liquid containing	(1) The maximum true vapor pressure of total organic HAP is $\geq 3.4$ kilopascals but $< 76.6$ kilopascals; and the capacity of the vessel is $\geq 95$ cubic meters	(i) Comply with the requirements of subpart WW of this part; or (ii) Reduce emissions of total organic HAP by 98 weight-percent by venting emissions through a closed vent system to any combination of control devices and meet

organic HAP		the requirements of §63.982(a)(1).
(c) A storage vessel (as defined in §63.1101) that stores liquid containing organic HAP	(1) The maximum true vapor pressure of total organic HAP is $\geq 76.6$ kilopascals	(i) Reduce emissions of total organic HAP by 98 weight-percent by venting emissions through a closed vent system to any combination of control devices and meet the requirements of §63.982(a)(1).
(d) An ethylene process vent (as defined in paragraph (e)(2) of this section)	(1) The process vent is at an existing source and the vent stream has a flow rate $\geq 0.011$ scmm and a total organic HAP concentration $\geq 50$ parts per million by volume; or the process vent is at a new source and the vent stream has a flow rate $\geq 0.008$ scmm and a total organic HAP concentration $\geq 30$ parts per million by volume	(i) Reduce emissions of organic HAP by 98 weight-percent; or reduce organic HAP or TOC to a concentration of 20 parts per million by volume; whichever is less stringent, by venting emissions through a closed vent system to any combination of control devices and meet the requirements specified in §63.982(b) and (c)(2).
(e) A transfer rack (as defined in paragraph (e)(2) of this section)	(1) Materials loaded have a true vapor pressure of total organic HAP $\geq 3.4$ kilopascals and $\geq 76$ cubic meters per day (averaged over any consecutive 30-day period) of HAP-containing material is loaded	(i) Reduce emissions of organic HAP by 98 weight-percent; or reduce organic HAP or TOC to a concentration of 20 parts per million by volume; whichever is less stringent, by venting emissions through a closed vent system to any combination of control devices as specified in §63.1105; or
		(ii) Install process piping designed to collect the HAP-containing vapors displaced from tank trucks or railcars during loading and to route it to a process, a fuel gas system, or a vapor balance system, as specified in §63.1105.
(f) Equipment (as defined in §63.1101) that contains or contacts organic HAP	(1) The equipment contains or contacts $\geq 5$ weight-percent organic HAP; and the equipment is not in vacuum service	Comply with the requirements of subpart UU of this part.
(g) Processes that	(1) The waste stream contains any of the	(i) Comply with the waste requirements of

generate waste (as defined in paragraph (e)(2) of this section)	following HAP: benzene, cumene, ethyl benzene, hexane, naphthalene, styrene, toluene, o-xylene, m-xylene, p-xylene, or 1,3-butadiene	subpart XX of this part. For ethylene manufacturing process unit waste stream requirements, terms have the meanings specified in subpart XX.
(h) A heat exchange system (as defined in paragraph (e)(2) of this section)		Comply with the heat exchange system requirements of subpart XX of this part.

(f) *Carbon black production applicability, definitions, and requirements*—(1) *Applicability*—(i) *Affected source*. For the carbon black production source category (as defined in paragraph (f)(2) of this section), the affected source shall comprise each carbon black production process unit located at a major source, as defined in section 112(a) of the Act. The affected source for the carbon black production source category includes all waste management units, maintenance wastewater, and equipment components that contain or contact HAP that are associated with the carbon black production process unit.

(ii) *Compliance schedule*. The compliance schedule for the carbon black production and acetylene decomposition carbon black production affected sources, as defined in paragraph (f)(1)(i) of this section, is specified in §63.1102.

(2) *Definitions*. *Carbon black production* means the production of carbon black by either the furnace, thermal, acetylene decomposition, or lampblack processes.

*Carbon black production unit* means the equipment assembled and connected by hard-piping or duct work to process raw materials to manufacture, store, and transport a carbon black product. For the purposes of this subpart, a carbon black production process unit includes reactors and associated operations; associated recovery devices; and any feed, intermediate and product storage vessels, product transfer racks, and connected ducts and piping. A carbon black production process unit includes pumps, compressors, agitators, pressure relief devices, sampling connection systems, open-ended valves or lines, valves, connectors, instrumentation systems, and control devices or systems.

*Dryer* means a rotary-kiln dryer that is heated externally and is used to dry wet pellets in the wet pelletization process.

*Main unit filter* means the filter that separates the carbon black from the tailgas.

*Process filter* means the filter that separates the carbon black from the conveying air.

*Purge filter* means the filter that separates the carbon black from the dryer exhaust.

(3) *Requirements*. (i) Table 8 to this section specifies the carbon black production standards applicability for existing and new sources. Applicability assessment procedures and methods are specified in §63.1104. An owner or operator of an affected source is not required to perform applicability tests or other applicability assessment procedures if they opt to comply with the most stringent requirements for an

applicable emission point pursuant to this subpart. General compliance, recordkeeping, and reporting requirements are specified in §§63.1108 through 63.1112. Procedures for approval of alternative means of emission limitations are specified in §63.1113.

(ii) Pressure relief devices used to protect against overpressure in the case of catastrophic failure of your process filter system are exempt from the closed vent system inspection requirements of §63.983(b) and (c). Exempt pressure relief devices must be designated and identified in your Notification of Compliance Status report.

**Table 8 to §63.1103(f)—What Are My Requirements if I Own or Operate a Carbon Black Production Existing or New Affected Source?**

<b>If you own or operate . . .</b>	<b>And if . . .</b>	<b>Then you must . . .</b>
(a) A carbon black production main unit filter process vent	(1) The HAP concentration of the emission stream is equal to or greater than 260 parts per million by volume <sup>a</sup>	(i) Reduce emissions of HAP by using a flare meeting the requirements of subpart SS of this part; or (ii) Reduce emissions of total HAP by 98 weight-percent or to a concentration of 20 parts per million by volume, whichever is less stringent, by venting emissions through a closed vent system to any combination of control devices meeting the requirements of §63.982(a)(2).

<sup>a</sup>The weight-percent organic HAP is determined according to the procedures specified in §63.1104(e).

(g) *Cyanide chemicals manufacturing applicability, definitions, and requirements*—(1) *Applicability*—(i) *Affected source*. For the cyanide chemicals manufacturing source category, the affected source shall include each cyanide chemicals manufacturing process unit located at a major source, as defined in section 112(a) of the Act. The affected source shall also include all waste management units, maintenance wastewater, and equipment (as defined in §63.1101) that contain or contact cyanide chemicals that are associated with the cyanide chemicals manufacturing process unit.

(ii) *Compliance schedule*. The compliance schedule for the affected source, as defined in paragraph (f)(1)(i) of this section, is specified in §63.1102.

(2) *Definitions*. *Andrussow process unit* means a process unit that produces hydrogen cyanide by reacting methane and ammonia in the presence of oxygen over a platinum/rhodium catalyst. An Andrussow process unit begins at the point at which the raw materials are stored and ends at the point at which refined hydrogen cyanide is reacted as a raw material in a downstream process, burned on-site as fuel in a boiler or industrial furnace, or is shipped offsite. If raw hydrogen cyanide from the reactor is reacted with sodium hydroxide to form sodium cyanide prior to the refining process, the unit operation where sodium cyanide is formed is considered to be part of the Andrussow process unit.

*Blausoure Methane Anlage (BMA) process unit* means a process unit that produces hydrogen cyanide by reacting methane and ammonia over a platinum catalyst. A BMA process unit begins at the point at which raw materials are stored and ends at the point at which refined hydrogen cyanide is reacted as a raw

material in a downstream process, burned on-site as a fuel in a boiler or industrial furnace, or is shipped offsite. If raw hydrogen cyanide from the reactor is reacted with sodium hydroxide to form sodium cyanide prior to the refining process, the unit operation where sodium cyanide is formed is considered to be part of the BMA process unit.

*Byproduct* means a chemical that is produced coincidentally during the production of another chemical.

*Cyanide chemicals manufacturing process unit* or *CCMPU* means the equipment assembled and connected by hard-piping or duct work to process raw materials to manufacture, store, and transport a cyanide chemicals product. A cyanide chemicals manufacturing process unit shall be limited to any one of the following: an Andrussow process unit, a BMA process unit, a sodium cyanide process unit, or a Sohio hydrogen cyanide process unit. For the purpose of this subpart, a cyanide chemicals manufacturing process unit includes reactors and associated unit operations; associated recovery devices; and any feed, intermediate and product storage vessels, product transfer racks, and connected ducts and piping. A cyanide chemicals manufacturing process unit includes pumps, compressors, agitators, pressure relief devices, sampling connection systems, open-ended valves or lines, valves, connectors, instrumentation systems, and control devices or systems.

*Cyanide chemicals product* means either hydrogen cyanide, potassium cyanide, or sodium cyanide which is manufactured as the intended product of a CCMPU or a byproduct of the Sohio process. Other hydrogen cyanide, potassium cyanide, or sodium cyanide byproducts, impurities, wastes, and trace contaminants are not considered to be cyanide chemicals products.

*Dry-end process vent* means a process vent originating from the drum filter or any other unit operation in the dry end of a sodium cyanide manufacturing process unit. For the purposes of this subpart, the dry end of the sodium cyanide process unit begins in the unit operation where water is removed from the sodium cyanide, usually in the drum filter, and ends when the sodium cyanide is used as a raw material in a downstream process, or is shipped offsite.

*Organic HAP* means, for purposes of applicability of the requirements of this subpart, all hydrogen cyanide compounds.

*Raw hydrogen cyanide* means hydrogen cyanide that has not been through the refining process. Raw hydrogen cyanide usually has a hydrogen cyanide concentration less than 10 percent.

*Refined hydrogen cyanide* means hydrogen cyanide that has been through the refining process. Refined hydrogen cyanide usually has a hydrogen cyanide concentration greater than 99 percent.

*Refining process* means the collection of equipment in a cyanide chemicals manufacturing processing unit used to concentrate raw hydrogen cyanide from a concentration around 10 percent or less to refined hydrogen cyanide at a concentration greater than 99 percent.

*Sodium cyanide process unit* means a process unit that produces sodium cyanide by reacting hydrogen cyanide and sodium hydroxide via the neutralization, or wet, process. A sodium cyanide process unit begins at the unit operation where refined hydrogen cyanide is reacted with sodium hydroxide and ends at the point the solid sodium cyanide product is shipped offsite or used as a raw material in a downstream process. If raw hydrogen cyanide is reacted with sodium hydroxide to form sodium cyanide prior to the

hydrogen cyanide refining process, the unit operation where sodium cyanide is formed is not considered to be part of the sodium cyanide process unit. For this type of process, the sodium cyanide process unit begins at the point that the aqueous sodium cyanide stream leaves the unit operation where the sodium cyanide is formed. In situations where potassium hydroxide is substituted for sodium hydroxide to produce potassium cyanide, the process unit is still considered a sodium cyanide process unit.

*Sohio hydrogen cyanide process unit* means a process unit that produces hydrogen cyanide as a byproduct of the acrylonitrile production process when acrylonitrile is manufactured using the Sohio process. A Sohio hydrogen cyanide process unit begins at the point the hydrogen cyanide leaves the unit operation where the hydrogen cyanide is separated from the acrylonitrile (usually referred to as the heads column). The Sohio hydrogen cyanide process unit ends at the point refined hydrogen cyanide is reacted as a raw material in a downstream process, burned on-site as fuel in a boiler or industrial furnace, or is shipped offsite. If raw hydrogen cyanide is reacted with sodium hydroxide to form sodium cyanide prior to the refining process, the unit operation where sodium cyanide is formed is considered to be part of the Sohio hydrogen cyanide process unit.

*Wet-end process vent* means a process vent originating from the reactor, crystallizer, or any other unit operation in the wet end of the sodium cyanide process unit. For the purposes of this subpart, the wet end of the sodium cyanide process unit begins at the point at which the raw materials are stored and ends just prior to the unit operation where water is removed from the sodium cyanide, usually in the drum filter. Wastewater streams containing discarded wastewater from the sodium cyanide production process are not considered to be part of the wet-end sodium cyanide process. Discarded wastewater that is no longer used in the production process is considered to be process and/or maintenance wastewater. Vents from process and maintenance wastewater operations are not wet-end process vents.

(3) *Requirements.* Table 9 to this section specifies the cyanide chemicals manufacturing standards applicable to existing and new sources. Applicability assessment procedures and methods are specified in §63.1104. An owner or operator of an affected source is not required to perform applicability tests or other applicability assessment procedures if they opt to comply with the most stringent requirements for an applicable emission point pursuant to this subpart. General compliance, recordkeeping, and reporting requirements are specified in §§63.1108 through 63.1112. Procedures for approval of alternative means of emission limitations are specified in §63.1113.

(4) *Determination of overall HAP emission reduction for a process unit.* (i) The owner or operator shall determine the overall HAP emission reduction for process vents in a process unit using Equation 1 of this section. The overall organic HAP emission reduction shall be determined for all process vents in the process unit.

$$\text{RED}_{\text{CCMPU}} = \left( \frac{\sum_{i=1}^n (E_{\text{unc},i}) \left( \frac{R_i}{100} \right)}{\sum_{i=1}^n (E_{\text{unc},i}) + \sum_{j=1}^m (E_{\text{unc},j})} \right) * 100 \quad [\text{Equation 1}]$$

[View or download PDF](#)

Where:

$RED_{CCMPU}$  = Overall HAP emission reduction for the group of process vents in the CCMPU, percent.

$E_{unc,i}$  = Uncontrolled HAP emissions from process vent i that is controlled by using a combustion, recovery, or recapture device, kg/yr.

n = Number of process vents in the process unit that are controlled by using a combustion, recovery, or recapture device.

$R_i$  = Control efficiency of the combustion, recovery, or recapture device used to control HAP emissions from vent i, determined in accordance with paragraph (g)(4)(ii) of this section.

$E_{unc,j}$  = Uncontrolled HAP emissions from process vent j that is not controlled by using a combustion, recovery, or recapture device, kg/yr.

m = Number of process vents in the process unit that are not controlled by using a combustion, recovery, or recapture device.

(ii) The control efficiency shall be assigned as specified in paragraph (g)(4)(ii) (A) or (B) of this section.

(A) If the process vent is controlled using a flare in accordance with the provisions of §63.987, or a combustion device in accordance with the provisions of §63.988(b)(2), for which a performance test has not been conducted, the control efficiency shall be assumed to be 98 weight-percent. For hydrogen-fueled flares, an owner or operator may use a control efficiency greater than 98 weight-percent if they can provide engineering calculations and supporting information demonstrating a greater control efficiency.

(B) If the process vent is controlled using a combustion, recovery, or recapture device for which a performance test has been conducted in accordance with the provisions of §63.997, the control efficiency shall be the efficiency determined by the performance test.

(5) *Source category specific modifications to testing procedures.* (i) When identifying equipment subject to any equipment leak requirements, an owner or operator is allowed to designate specific components of such equipment as never being safe to monitor with their Notification of Compliance Status report and periodic compliance reports. In order for an owner or operator to designate such equipment as never being safe to monitor, they must certify that monitoring such equipment at any time the CCMPU is operating is never safe (e.g., monitoring this equipment would present an unreasonable hazard or preclude testing personnel from meeting emergency evacuation requirements). If it is demonstrated to the Administrator's satisfaction that equipment designated by the owner or operator as never safe to monitor is appropriately designated, an owner or operator will not be required to monitor such equipment.

(ii) For process vent hydrogen cyanide emissions that are vented to a control device other than a flare during startup, shutdown, and malfunction, the design evaluation must include documentation that the control device being used achieves the required control efficiency during the reasonably expected maximum flow rate and emission rate during startup, shutdown, and malfunction.

(iii) If a facility controls process vent emissions during startup, shutdown, and malfunction by using a flare, an owner or operator is not required to perform flow rate and heat content testing as specified in

§63.987(b)(3)(ii) and (iii). In lieu of performing flow rate and heat content testing, an owner or operator is required to submit engineering calculations that substantiate that a flare meets the applicable heat content or flow rates, or provide data from a compliance assessment that the flare is in compliance under worst case conditions (e.g., maximum operating conditions).

(iv) If flare velocity and net heating value testing, as specified in §63.11(b)(6)(ii) and (b)(7)(i), would create an unreasonable hazard for testing personnel, an owner or operator is allowed to submit engineering calculations that substantiate vent stream velocity and heat content of a flare in lieu of test data. These calculations are required to be submitted with the facilities' compliance test notification report for approval by the Administrator.

(v) The data from any performance test method used to measure HCN concentrations must be validated using EPA Method 301 (40 CFR part 63, appendix A).

**Table 9 to §63.1103(g)—What Are My Requirements if I Own or Operate a Cyanide Chemicals Manufacturing Existing or New Affected Source?**

If you own or operate . . .	And if . . .	Then you must . . .
(a) A storage vessel	(1) The storage vessel contains refined hydrogen cyanide	(i) Reduce emissions of hydrogen cyanide by using a flare meeting the requirements of §63.982(b); or (ii) Reduce emissions of hydrogen cyanide by 98 weight-percent, or to a concentration of 20 parts per million by volume, by venting emissions through a closed vent system to any combination of control devices meeting the requirements of §63.982(c)(1) or (d).
(b) A process vent from a continuous unit operations in an Andrussow, BMA, or Sohio hydrogen cyanide process unit		(i) Reduce overall annual emissions of total HAP from the collection of process vents from continuous unit operations in the process by 98 weight-percent in accordance with paragraph (g)(4) of this section. Any control device used to reduce emissions from one or more process vents from continuous unit operations in the process unit must meet the applicable requirements specified in §63.982(a)(2); or
		(ii) Reduce emissions of total HAP from each process vent from a continuous unit operation in the process unit by using a flare meeting the requirements specified in §63.982(b); or



		(iii) Reduce emissions of total HAP from each process vent from a continuous unit operation in the process unit by 98 weight-percent or to a concentration of 20 parts per million by volume, by venting emissions through a closed vent system to any combination of control devices meeting the requirements of §63.982(c)(2) or (d).
(c) One or more wet end process vents, as defined in paragraph (g)(2) of this section, in a sodium cyanide process unit		(i) Reduce overall annual emissions of total HAP from the collection of process vents from continuous unit operations in the process unit by 98 weight-percent in accordance with paragraph (g)(4) of this section. Any control device used to reduce emissions from one or more process vents from continuous unit operations in the process unit must meet the applicable requirements of §63.982(a)(2); or
		(ii) Reduce emissions of total HAP from each wet-end process vent in the process unit by using a flare meeting the requirements of §63.982(b); or
		(iii) Reduce emissions of total HAP from each wet-end process vent by 98 weight-percent, or to a concentration of 20 parts per million by volume, by venting emissions through a closed vent system and any combination of control devices meeting the requirements of §63.982(c)(2) or (d).
(d) One or more dry end process vents, as defined in paragraph (g)(2) of this section, in a sodium cyanide process unit		(i) Reduce overall annual emissions of sodium cyanide from the collection of process vents from continuous unit operations in the process unit by 98 weight-percent in accordance with paragraph (g)(4) of this section. Any control device used to reduce emissions from one or more process vents from continuous unit operations in the process unit must meet the applicable requirements of §63.982(a)(2); or
		(ii) Reduce emissions of sodium cyanide from each dry-end process vent in the process unit by 98 weight-percent by venting emissions through a

		closed vent system to any combination of control devices meeting the requirements of §63.982(c)(2) or (d).
(e) A transfer rack	(1) The transfer rack is used to load refined hydrogen cyanide into tank trucks and/or rail cars	(i) Reduce emissions of hydrogen cyanide by using a flare meeting the requirements of §63.982(b); or (ii) Reduce emissions of hydrogen cyanide by 98 weight-percent, or to a concentration of 20 parts per million by volume, whichever is less stringent, by venting emissions through a closed vent system to any combination of control devices meeting the requirements specified in §63.982(c)(1), (c)(2), or (d).
(f) A new cyanide chemicals manufacturing process unit that generates process wastewater	(1) The process wastewater is from HCN purification, ammonia purification, or flare blowdown	(i) Achieve a combined removal and control of HAP from wastewater of 93 weight-percent.
(g) A cyanide chemicals manufacturing process unit that generates maintenance wastewater	(1) The maintenance wastewater contains hydrogen cyanide or acetonitrile	(i) Comply with the requirements of §63.1106(b).
(h) An item of equipment listed in §63.1106(c)(1) that transports or contains wastewater liquid streams from a cyanide chemicals manufacturing process unit	(1) The item of equipment meets the criteria specified in §63.1106(c)(1) through (3) and either (c)(4)(i) or (ii)	(i) Comply with the requirements in Table 35 of subpart G of this part.
(i) Equipment, as defined under §63.1101	(1) The equipment contains or contacts hydrogen cyanide and operates equal to or greater than 300 hours per year	(i) Comply with either subpart TT or UU of this part, and paragraph (g)(5) of this section, with the exception that open-ended lines that contain or contact hydrogen cyanide are exempt from any requirements to install a cap, plug, blind flange, or second valve to be capped.

(h) *Spandex production applicability, definitions, and requirements*—(1) *Applicability*—(i) *Affected source*. For the spandex production (as defined in paragraph (h)(2) of this section) source category, the affected source shall comprise all emission points listed in paragraphs (h)(1)(i)(A) through (C) of this

section that are associated with a spandex production process unit located at a major source, as defined in section 112(a) of the Act.

(A) All process vents (as defined in §63.1101).

(B) All storage vessels (as defined in §63.1101) that store liquids containing organic HAP.

(C) All spandex fiber spinning lines using a spinning solution having organic HAP.

(ii) *Exceptions.* The emission points listed in paragraphs (h)(1)(ii)(A) and (B) of this section are in the spandex production source category but are not subject to the requirements of paragraph (h)(3) of this section.

(A) Equipment that is located within a spandex production process unit that is subject to this subpart but does not contain organic HAP.

(B) Vessels storing organic liquids that contain organic HAP as impurities.

(C) Emission points listed in paragraphs (h)(1)(i)(A) through (C) of this section that are associated with a dry spinning spandex production process unit.

(iii) *Compliance schedule.* The compliance schedule for affected sources, as defined in paragraph (h)(1)(i) of this section, is specified in paragraph (b) of §63.1102.

(2) *Definitions.* *Dry spinning* means a fiber-forming process where prepolymer is reacted with a chain-extender to generate polymer prior to spinning; the polymer is dissolved in a solvent and is extruded into a cell of hot gases for fiber formation.

*Fiber spinning line* means the group of equipment and process vents associated with spandex fiber spinning operations. The fiber spinning line includes the blending and dissolving tanks, spinning solution filters, spinning units, spin bath tanks, and the equipment used downstream of the spin bath to wash, draw, or dry on the wet belt the spun fiber.

*Reaction spinning* means a fiber-forming process where prepolymer is extruded into a spin bath that contains a chain-extender; the chemical reaction to make polymer occurs simultaneously with extrusion/fiber formation.

*Spandex or spandex fiber* means a manufactured synthetic fiber in which the fiber-forming substance is a long-chain polymer comprised of at least 85 percent by mass of a segmented polyurethane.

*Spandex production* means the production of synthetic spandex fibers.

*Spandex production process unit* means a process unit that is specifically used for the production of synthetic spandex fibers.

(3) *Requirements.* Table 10 to this section specifies the spandex production source category requirements for new and existing sources. An owner or operator must perform the applicability assessment procedures and methods for process vents specified in §63.1104, excluding paragraphs (b)(1), (d), (g), (h), (i), (j), (l)(1), and (n). General compliance, recordkeeping, and reporting requirements are specified in §§63.1108

through 63.1112. Minimization of emissions from startup, shutdown, and malfunctions must be addressed in the startup, shutdown, and malfunction plan required by §63.1111; the plan must also establish reporting and recordkeeping of such events. Procedures for approval of alternate means of emission limitations are specified in §63.1113.

**Table 10 to §63.1103(h)—What Are My Requirements if I Own or Operate a Spandex Production Process Unit at a New or Existing Source?**

<b>If you own or operate . . .</b>	<b>And if . . .</b>	<b>Then you must . . .</b>
(a) A storage vessel (as defined in §63.1101) that stores liquid containing organic HAP	(1) The maximum true vapor pressure of the organic HAP is $\geq 3.4$ kilopascals; and the capacity of the vessel is $\geq 47$ cubic meters	(i) Comply with the requirements of subpart WW of this part; or (ii) Reduce emissions of organic HAP by 95 weight-percent by venting emissions in through a closed vent system to any combination of control devices meeting the requirements of subpart SS of this part, as specified in §63.982(a)(1).
(b) A process vent		Reduce emissions of organic HAP by 95 weight-percent, or reduce organic HAP or TOC to a concentration of 20 parts per million by volume, whichever is less stringent, by venting emissions through a closed vent system to any combination of control devices meeting the requirements of §63.982(a)(2).
(c) A fiber spinning line		Operate the fiber spinning line such that emissions are captured and vented through a line closed vent system to a control device that complies with the requirements of §63.982(a)(2). If a control device other than a flare is used, HAP emissions must be reduced by 95 weight-percent, or total organic HAP or TOC must be reduced to a concentration of 20 parts per million by volume, whichever is less stringent.

[64 FR 34921, June 29, 1999, as amended at 64 FR 63699, 63706, Nov. 22, 1999; 64 FR 71852, Dec. 22, 1999; 66 FR 55847, Nov. 2, 2001; 67 FR 39305, June 7, 2002; 67 FR 46281, July 12, 2002; 67 FR 46293, July 12, 2002; 70 FR 19272, Apr. 13, 2005; 79 FR 60922, Oct. 8, 2014]

[↑ Back to Top](#)

**§63.1104 Process vents from continuous unit operations: applicability assessment procedures and methods.**

(a) *General.* The provisions of this section provide calculation and measurement methods for criteria that are required by §63.1103 to be used to determine applicability of the control requirements for process vents from continuous unit operations. The owner or operator of a process vent is not required to determine the criteria specified for a process vent that is being controlled (including control by flare) in accordance with the applicable weight-percent, TOC concentration, or organic HAP concentration requirement in §63.1103.

(b) *Sampling sites.* For purposes of determining process vent applicability criteria, the sampling site shall be located as specified in (b)(1) through (4) of this section, as applicable.

(1) *Sampling site location if TRE determination is required.* If the applicability criteria specified in the applicable table of §63.1103 includes a TRE index value, the sampling site for determining volumetric flow rate, regulated organic HAP concentration, total organic HAP or TOC concentration, heating value, and TRE index value, shall be after the final recovery device (if any recovery devices are present) but prior to the inlet of any control device that is present, and prior to release to the atmosphere.

(2) *Sampling site location if TRE determination is not required.* If the applicability criteria specified in the applicable table of §63.1103 does not include a TRE index value, the sampling site for determining volumetric flow rate, regulated organic HAP concentration, total organic HAP or TOC concentration, and any other specified parameter shall be at the exit from the unit operation before any control device.

(3) *Sampling site selection method.* Method 1 or 1A of 40 CFR part 60, appendix A, as appropriate, shall be used for selection of the sampling site. No traverse site selection method is needed for process vents smaller than 0.10 meter (0.33 foot) in nominal inside diameter.

(4) *Sampling site when a halogen reduction device is used prior to a combustion device.* An owner or operator using a scrubber to reduce the process vent halogen atom mass emission rate to less than 0.45 kilograms per hour (0.99 pound per hour) prior to a combustion control device in compliance with §63.1103 (as appropriate) shall determine the halogen atom mass emission rate prior to the combustion device according to the procedures in paragraph (i) of this section.

(c) *Applicability assessment requirement.* The TOC or organic HAP concentrations, process vent volumetric flow rates, process vent heating values, process vent TOC or organic HAP emission rates, halogenated process vent determinations, process vent TRE index values, and engineering assessments for process vent control applicability assessment requirements are to be determined during maximum representative operating conditions for the process, except as provided in paragraph (d) of this section, or unless the Administrator specifies or approves alternate operating conditions. For acrylic and modacrylic fiber production affected sources and polycarbonate production affected sources, operations during periods of malfunction shall not constitute representative conditions for the purpose of an applicability test. For all other affected sources, operations during periods of startup, shutdown, and malfunction shall not constitute representative conditions for the purpose of an applicability test.

(d) *Exceptions.* For a process vent stream that consists of at least one process vent from a batch unit operation manifolded with at least one process vent from a continuous unit operation, the TRE shall be calculated during periods when one or more batch emission episodes are occurring that result in the highest organic HAP emission rate (in the combined vent stream that is being routed to the recovery

device) that is achievable during the 6-month period that begins 3 months before and ends 3 months after the TRE calculation, without causing any of the situations described in paragraphs (d)(1) through (3) to occur.

(1) Causing damage to equipment;

(2) Necessitating that the owner or operator make product that does not meet an existing specification for sale to a customer; or

(3) Necessitating that the owner or operator make product in excess of demand.

(e) *TOC or Organic HAP concentration.* The TOC or organic HAP concentrations shall be determined based on paragraph (e)(1), (e)(2), or (k) of this section, or any other method or data that have been validated according to the protocol in Method 301 of appendix A of 40 CFR part 63. For concentrations needed for comparison with the appropriate control applicability concentrations specified in §63.1103, TOC or organic HAP concentration shall be determined based on paragraph (e)(1), (e)(2), or (k) of this section or any other method or data that has been validated according to the protocol in method 301 of appendix A of this part. The owner or operator shall record the TOC or organic HAP concentration as specified in paragraph (1)(3) of this section.

(1) *Method 18.* The procedures specified in paragraph (e)(1)(i) and (ii) of this section shall be used to calculate parts per million by volume concentration using method 18 of 40 CFR part 60, appendix A:

(i) The minimum sampling time for each run shall be 1 hour in which either an integrated sample or four grab samples shall be taken. If grab sampling is used, then the samples shall be taken at approximately equal intervals in time, such as 15-minute intervals during the run.

(ii) The concentration of either TOC (minus methane and ethane) or regulated organic HAP emissions shall be calculated according to paragraph (e)(1)(ii)(A) or (B) of this section, as applicable.

(A) The TOC concentration ( $C_{\text{TOC}}$ ) is the sum of the concentrations of the individual components and shall be computed for each run using Equation 1:

$$C_{\text{TOC}} = \frac{\sum_{i=1}^x \left( \sum_{j=1}^n C_{ji} \right)}{x} \quad [\text{Eq. 1}]$$

[View or download PDF](#)

Where:

$C_{\text{TOC}}$  = Concentration of TOC (minus methane and ethane), dry basis, parts per million by volume.

$C_{ji}$  = Concentration of sample component  $j$  of the sample  $i$ , dry basis, parts per million by volume.

$n$  = Number of components in the sample.

$x$  = Number of samples in the sample run.

(B) The regulated organic HAP or total organic HAP concentration ( $C_{\text{HAP}}$ ) shall be computed according to Equation 1 in paragraph (e)(1)(ii)(A) of this section except that only the regulated or total organic HAP species shall be summed, as appropriate.

(2) *Method 25A.* The procedures specified in paragraphs (e)(2)(i) through (vi) of this section shall be used to calculate parts per million by volume concentration using Method 25A of 40 CFR part 60, appendix A.

(i) Method 25A of 40 CFR part 60, appendix A shall be used only if a single organic HAP compound comprises greater than 50 percent of total organic HAP or TOC, by volume, in the process vent.

(ii) The process vent composition may be determined by either process knowledge, test data collected using an appropriate Environmental Protection Agency method or a method or data validated according to the protocol in Method 301 of appendix A of part 63. Examples of information that could constitute process knowledge include calculations based on material balances, process stoichiometry, or previous test results provided the results are still relevant to the current process vent conditions.

(iii) The organic compound used as the calibration gas for Method 25A of 40 CFR part 60, appendix A shall be the single organic HAP compound present at greater than 50 percent of the total organic HAP or TOC by volume.

(iv) The span value for Method 25A of 40 CFR part 60, appendix A shall be equal to the appropriate control applicability concentration value specified in the applicable table(s) presented in §63.1103 of this subpart.

(v) Use of Method 25A of 40 CFR part 60, appendix A is acceptable if the response from the high-level calibration gas is at least 20 times the standard deviation of the response from the zero calibration gas when the instrument is zeroed on the most sensitive scale.

(vi) The owner or operator shall demonstrate that the concentration of TOC including methane and ethane measured by Method 25A of 40 CFR part 60, appendix A is below one-half the appropriate control applicability concentration specified in the applicable table for a subject source category in §63.1103 in order to qualify for a low organic HAP concentration exclusion.

(f) *Volumetric flow rate.* The process vent volumetric flow rate ( $Q_s$ ), in standard cubic meters per minute at 20 °C, shall be determined as specified in paragraph (f)(1) or (2) of this section and shall be recorded as specified in §63.1109(d).

(1) Use Method 2, 2A, 2C, 2D, 2F, or 2G of 40 CFR part 60, appendix A, as appropriate. If the process vent tested passes through a final steam jet ejector and is not condensed, the stream volumetric flow shall be corrected to 2.3 percent moisture; or

(2) The engineering assessment procedures in paragraph (k) of this section can be used for determining volumetric flow rates.

(g) *Heating value.* The net heating value shall be determined as specified in paragraphs (g)(1) and (2) of this section, or by using the engineering assessment procedures in paragraph (k) of this section.

(1) The net heating value of the process vent shall be calculated using Equation 2:

$$H_T = K_1 \left( \sum_{j=1}^n D_j H_j \right) \quad [Eq. 2]$$

[View or download PDF](#)

Where:

$H_T$  = Net heating value of the sample, megaJoule per standard cubic meter, where the net enthalpy per mole of process vent is based on combustion at 25 °C and 760 millimeters of mercury, but the standard temperature for determining the volume corresponding to 1 mole is 20 °C, as in the definition of  $Q_s$  (process vent volumetric flow rate).

$K_1$  = Constant,  $1.740 \times 10^{-7}$  (parts per million)<sup>-1</sup> (gram-mole per standard cubic meter) (megaJoule per kilocalorie), where standard temperature for (gram-mole per standard cubic meter) is 20 °C.

$D_j$  = Concentration on a wet basis of compound j in parts per million, as measured by procedures indicated in paragraph (e)(2) of this section. For process vents that pass through a final steam jet and are not condensed, the moisture is assumed to be 2.3 percent by volume.

$H_j$  = Net heat of combustion of compound j, kilocalorie per gram-mole, based on combustion at 25 °C and 760 millimeters mercury.

(2) The molar composition of the process vent ( $D_j$ ) shall be determined using the methods specified in paragraphs (g)(2)(i) through (iii) of this section:

(i) Method 18 of 40 CFR part 60, appendix A to measure the concentration of each organic compound.

(ii) American Society for Testing and Materials D1946-90 to measure the concentration of carbon monoxide and hydrogen.

(iii) Method 4 of 40 CFR part 60, appendix A to measure the moisture content of the stack gas.

(h) *TOC or Organic HAP emission rate.* The emission rate of TOC (minus methane and ethane) ( $E_{TOC}$ ) and the emission rate of the regulated organic HAP or total organic HAP ( $E_{HAP}$ ) in the process vent, as required by the TRE index value equation specified in paragraph (j) of this section, shall be calculated using Equation 3:

$$E = K_2 \left( \sum_{j=1}^n C_j M_j \right) Q_s \quad [Eq. 3]$$

[View or download PDF](#)

Where:

$E$  = Emission rate of TOC (minus methane and ethane) ( $E_{TOC}$ ) or emission rate of the regulated organic HAP or total organic HAP ( $E_{HAP}$ ) in the sample, kilograms per hour.



$K_2$  = Constant,  $2.494 \times 10^{-6}$  (parts per million)<sup>-1</sup> (gram-mole per standard cubic meter) (kilogram/gram) (minutes/hour), where standard temperature for (gram-mole per standard cubic meter) is 20 °C.

n = Number of components in the sample.

$C_j$  = Concentration on a dry basis of organic compound j in parts per million as measured by method 18 of 40 CFR part 60, appendix A as indicated in paragraph (e) of this section. If the TOC emission rate is being calculated,  $C_j$  includes all organic compounds measured minus methane and ethane; if the total organic HAP emission rate is being calculated, only organic HAP compounds are included; if the regulated organic HAP emission rate is being calculated, only regulated organic HAP compounds are included.

$M_j$  = Molecular weight of organic compound j, gram/gram-mole.

$Q_s$  = Process vent flow rate, dry standard cubic meter per minute, at a temperature of 20 °C.

(i) *Halogenated process vent determination.* In order to determine whether a process vent is halogenated, the mass emission rate of halogen atoms contained in organic compounds shall be calculated according to the procedures specified in paragraphs (i)(1) and (2) of this section. A process vent is considered halogenated if the mass emission rate of halogen atoms contained in the organic compounds is equal to or greater than 0.45 kilograms per hour.

(1) The process vent concentration of each organic compound containing halogen atoms (parts per million by volume, by compound) shall be determined based on one of the procedures specified in paragraphs (i)(1)(i) through (iv) of this section:

(i) Process knowledge that no halogen or hydrogen halides are present in the process vent, or

(ii) Applicable engineering assessment as discussed in paragraph (k) of this section, or

(iii) Concentration of organic compounds containing halogens or hydrogen halides as measured by Method 26 or 26A of 40 CFR part 60, appendix A, or

(iv) Any other method or data that have been validated according to the applicable procedures in method 301 of appendix A of this part.

(2) Equation 4 shall be used to calculate the mass emission rate of halogen atoms:

$$E = K_2 Q \left( \sum_{j=1}^n \sum_{i=1}^m C_j * L_{ji} * M_{ji} \right) \quad [Eq. 4]$$

[View or download PDF](#)

Where:

E = Mass of halogen atoms, dry basis, kilogram per hour,

$K_2$  = Constant,  $2.494 \times 10^{-6}$  (parts per million)<sup>-1</sup> (kilogram-mole per standard cubic meter) (minute per hour), where standard temperature is 20 °C.

Q = Flow rate of gas stream, dry standard cubic meters per minute, determined according to paragraph (f)(1) or (f)(2) of this section.

n = Number of halogenated compounds j in the gas stream.

j = Halogenated compound j in the gas stream.

m = Number of different halogens i in each compound j of the gas stream.

i = Halogen atom i in compound j of the gas stream.

C<sub>j</sub> = Concentration of halogenated compound j in the gas stream, dry basis, parts per million by volume.

L<sub>ji</sub> = Number of atoms of halogen i in compound j of the gas stream.

M<sub>ji</sub> = Molecular weight of halogen atom i in compound j of the gas stream, kilogram per kilogram-mole.

(j) *TRE index value.* The owner or operator shall calculate the TRE index value of the process vent using the equations and procedures in this paragraph, as applicable, and shall maintain records specified in paragraph (l)(1) or (m)(2) of this section, as applicable.

(1) *TRE index value equation.* The equation for calculating the TRE index value is Equation 5:

$$TRE = 1/E_{HAP} * [A + B(Q_S) + C(H_T) + D(E_{TOC})] \quad [Eq. 5]$$

Where:

TRE = TRE index value.

A, B, C, D = Coefficients presented in table 1 of this section.

E<sub>HAP</sub> = Emission rate of total organic HAP, kilograms per hour, as calculated according to paragraph (h) or (k) of this section.

Q<sub>S</sub> = process vent flow rate, standard cubic meters per minute, at a standard temperature of 20 °C, as calculated according to paragraph (f) or (k) of this section.

H<sub>T</sub> = process vent net heating value, megaJoules per standard cubic meter, as calculated according to paragraph (g) or (k) of this section.

E<sub>TOC</sub> = Emission rate of TOC (minus methane and ethane), kilograms per hour, as calculated according to paragraph (h) or (k) of this section.

**Table 1 of §63.1104(j)(1)—Coefficients for Total Resource Effectiveness<sup>a</sup>**

Existing or	Halogenated vent	Control device basis	Values of coefficients
-------------	------------------	----------------------	------------------------

new?	stream?		A	B	C	D
Existing	Yes	Thermal Incinerator and Scrubber	3.995	$5.200 \times 10^{-2}$	$-1.769 \times 10^{-3}$	$9.700 \times 10^{-4}$
	No	Flare	1.935	$3.660 \times 10^{-1}$	$-7.687 \times 10^{-3}$	$-7.333 \times 10^{-4}$
		Thermal Incinerator 0 Percent Recovery	1.492	$6.267 \times 10^{-2}$	$3.177 \times 10^{-2}$	$-1.159 \times 10^{-3}$
		Thermal Incinerator 70 Percent Recovery	2.519	$1.183 \times 10^{-2}$	$1.300 \times 10^{-2}$	$4.790 \times 10^{-2}$
New	Yes	Thermal Incinerator and Scrubber	1.0895	$1.417 \times 10^{-2}$	$-4.822 \times 10^{-4}$	$2.645 \times 10^{-4}$
	No	Flare	$5.276 \times 10^{-1}$	$9.98 \times 10^{-2}$	$-2.096 \times 10^{-3}$	$2.000 \times 10^{-4}$
		Therman Incinerator 0 Percent Recovery	$4.068 \times 10^{-1}$	$1.71 \times 10^{-2}$	$8.664 \times 10^{-3}$	$-3.162 \times 10^{-4}$
		Thermal Incinerator 70 Percent Recovery	$6.868 \times 10^{-1}$	$3.209 \times 10^{-3}$	$3.546 \times 10^{-3}$	$1.306 \times 10^{-2}$

<sup>a</sup>Use according to procedures outlined in this section.

MJ/scm = Mega Joules per standard cubic meter.

scm/min = Standard cubic meters per minute.

(2) *Nonhalogenated process vents.* The owner or operator of a nonhalogenated process vent shall calculate the TRE index value by using the equation and appropriate nonhalogenated process vent parameters in table 1 of this section for process vents at existing and new sources. The lowest TRE index value is to be selected.

(3) *Halogenated process vents.* The owner or operator of a halogenated process vent stream, as determined according to procedures specified in paragraph (i) or (k) of this section, shall calculate the TRE index value using the appropriate halogenated process vent parameters in table 1 of this section for existing and new sources.

(k) *Engineering assessment.* For purposes of TRE index value determinations, engineering assessments may be used to determine process vent flow rate, net heating value, TOC emission rate, and total organic

HAP emission rate for the representative operating condition expected to yield the lowest TRE index value. Engineering assessments shall meet the requirements of paragraphs (k)(1) through (4) of this section. If a process vent flow rate or process vent organic HAP or TOC concentration is being determined for comparison with the applicable flow rate or concentration value presented in the tables in §63.1103 to determine control requirement applicability, engineering assessment may be used to determine the flow rate or concentration for the representative operating conditions expected to yield the highest flow rate or concentration.

(1) If the TRE index value calculated using such engineering assessment and the TRE index value equation in paragraph (j) of this section is greater than 4.0, then the owner or operator is not required to perform the measurements specified in paragraphs (e) through (i) of this section.

(2) If the TRE index value calculated using such engineering assessment and the TRE index value equation in paragraph (j) of this section is less than or equal to 4.0, then the owner or operator is required either to perform the measurements specified in paragraphs (e) through (i) of this section for control applicability assessment or comply with the requirements (or standards) specified in the tables presented in §63.1103 (as applicable).

(3) Engineering assessment includes, but is not limited to, the examples specified in paragraphs (k)(3)(i) through (iv) of this section:

(i) Previous test results, provided the tests are representative of current operating practices at the process unit.

(ii) Bench-scale or pilot-scale test data representative of the process under representative operating conditions.

(iii) Maximum flow rate, TOC emission rate, organic HAP emission rate, organic HAP or TOC concentration, or net heating value limit specified or implied within a permit limit applicable to the process vent.

(iv) Design analysis based on accepted chemical engineering principles, measurable process parameters, or physical or chemical laws or properties. Examples of analytical methods include, but are not limited to those specified in paragraphs (k)(3)(iv)(A) through (k)(3)(iv)(D) of this section:

(A) Use of material balances based on process stoichiometry to estimate maximum TOC or organic HAP concentrations,

(B) Estimation of maximum flow rate based on physical equipment design such as pump or blower capacities,

(C) Estimation of TOC or organic HAP concentrations based on saturation conditions, and

(D) Estimation of maximum expected net heating value based on the stream concentration of each organic compound or, alternatively, as if all TOC in the stream were the compound with the highest heating value.

(4) All data, assumptions, and procedures used in the engineering assessment shall be documented. The owner or operator shall maintain the records specified in paragraphs (l)(1) through (4) of this section, as applicable.

(1) *Applicability assessment recordkeeping requirements—(1) TRE index value records.* The owner or operator shall maintain records of measurements, engineering assessments, and calculations performed to determine the TRE index value of the process vent according to the procedures of paragraph (j) of this section, including those records associated with halogen vent stream determination. Documentation of engineering assessments shall include all data, assumptions, and procedures used for the engineering assessments, as specified in paragraph (k) of this section. As specified in paragraph (m) of this section, the owner or operator shall include this information in the Notification of Compliance Status report required by §63.1110(a)(4).

(2) *Flow rate records.* The owner or operator shall record the flow rate as measured using the sampling site and flow rate determination procedures (if applicable) specified in paragraphs (b) and (f) of this section or determined through engineering assessment as specified in paragraph (k) of this section. As specified in paragraph (m) of this section, the owner or operator shall include this information in the Notification of Compliance Status report required by §63.1110(a)(4).

(3) *Concentration records.* The owner or operator shall record the regulated organic HAP or TOC concentration (if applicable) as measured using the sampling site and regulated organic HAP or TOC concentration determination procedures specified in paragraphs (e)(1) and (2) of this section, or determined through engineering assessment as specified in paragraph (k) of this section. As specified in paragraph (m) of this section, the owner or operator shall include this information in the Notification of Compliance Status report required by §63.1110(a)(4).

(4) *Process change records.* The owner or operator shall keep up-to-date, readily accessible records of any process changes that change the control applicability for a process vent. Records are to include any recalculation or measurement of the flow rate, regulated organic HAP or TOC concentration, and TRE index value.

(m) *Applicability assessment reporting requirements—(1) Notification of Compliance Status.* The owner or operator shall submit, as part of the Notification of Compliance Status report required by §63.1110(a)(4), the information recorded in paragraph (l)(1) through (3) of this section.

(2) *Process change.* (i) Whenever a process vent becomes subject to control requirements under this subpart as a result of a process change, the owner or operator shall submit a report within 60 days after the performance test or applicability assessment, whichever is sooner. The report may be submitted as part of the next Periodic Report required by §63.1110(a)(5). The report shall include the information specified in paragraphs (m)(2)(i)(A) through (C) of this section.

(A) A description of the process change;

(B) The results of the recalculation of the TOC or organic HAP concentration, flow rate, and/or TRE index value required under paragraphs (e), (f), and (j), and recorded under paragraph (l); and

(C) A statement that the owner or operator will comply with the requirements specified in §63.1103 by the schedules specified in that section for the affected source.

(ii) If a performance test is required as a result of a process change, the owner or operator shall specify that the performance test has become necessary due to a process change. This specification shall be made in the performance test notification to the Administrator, as specified in §63.999(a)(1).

(iii) If a process change does not result in additional applicable requirements, then the owner or operator shall include a statement documenting this in the next Periodic Report required by §63.1110(a)(5) after the process change was made.

(n) *Parameter monitoring of certain process vents.* An owner or operator who maintains a TRE index value (if applicable) in the applicable TRE index value monitoring range as specified in an applicable table presented in §63.1103 of this subpart without using a recovery device shall report a description of the parameter(s) to be monitored to ensure the process vent is operated in conformance with its design or process and achieves and maintains the TRE index value above the specified level, and an explanation of the criteria used to select parameter(s). An owner or operator who maintains a TRE index value (if applicable) in the applicable TRE index monitoring range as specified in an applicable table presented in §63.1103 of this subpart by using a recovery device shall comply with the requirements of §63.993(c).

[64 FR 34921, June 29, 1999, as amended at 64 FR 63708, Nov. 22, 1999; 67 FR 39307, June 7, 2002; 67 FR 42688, July 12, 2002; 79 FR 60926, Oct. 8, 2014]

[↑ Back to Top](#)

### **§63.1105 Transfer racks.**

(a) *Design requirements.* The owner or operator shall equip each transfer rack with one of the control options listed in paragraphs (a)(1) through (4) of this section.

(1) A closed vent system designed to collect HAP-containing vapors displaced from tank trucks or railcars during loading and to route the collected vapors to a flare. The owner or operator must meet the requirements of §63.982(a)(3).

(2) A closed vent system designed to collect HAP-containing vapors displaced from tank trucks or railcars during loading and to route the collected vapors to a control device other than a flare. The owner or operator must meet the requirements of §63.982(a)(3).

(3) Process piping designed to collect the HAP vapors displaced from tank trucks or railcars during loading and to route the collected vapors to a process where the HAP vapors shall predominantly meet one of, or a combination of, the ends specified in paragraphs (a)(3)(i) through (iv) of this section or to a fuel gas system. The owner or operator must meet the requirements of §63.982(a)(3).

(i) Recycled and/or consumed in the same manner as a material that fulfills the same function in that process;

(ii) Transformed by chemical reaction into materials that are not HAP;

(iii) Incorporated into a product; and/or

(iv) Recovered.

(4) Process piping designed to collect the HAP vapors displaced from tank trucks or railcars during loading and to route the collected vapors to a vapor balance system. The vapor balance system must be designed to route the collected HAP vapors to the storage vessel from which the liquid being loaded originated, or to another storage vessel connected to a common header, or to compress and route collected HAP vapors to a process.

(b) *Operating requirements.* An owner or operator of a transfer rack shall operate it in such a manner that emissions are routed through the equipment specified in paragraph (a) of this section.

(c) *Control device operation.* Whenever HAP emissions are vented to a control device used to comply with the provisions of this subpart, such control device shall be operating.

(d) *Tank trucks and railcars.* The owner or operator shall load HAP-containing materials only into tank trucks and railcars that meet the requirement in paragraph (d)(1) or (2) of this section and shall maintain the records specified in paragraph (i) of this section.

(1) Have a current certification in accordance with the U.S. Department of Transportation (DOT) pressure test requirements of 49 CFR part 180 for tank trucks and 49 CFR 173.31 for railcars; or

(2) Have been demonstrated to be vapor-tight within the preceding 12 months as determined by the procedures in paragraph (h) of this section. Vapor-tight means that the pressure in a truck or railcar tank will not drop more than 750 pascals within 5 minutes after it is pressurized to a minimum of 4,500 pascals.

(e) *Pressure relief device.* The owner or operator of a transfer rack subject to the provisions of this subpart shall ensure that no pressure relief device in the loading equipment of each tank truck or railcar shall begin to open to the atmosphere during loading. Pressure relief devices needed for safety purposes are not subject to the requirements of this paragraph.

(f) *Compatible system.* The owner or operator of a transfer rack subject to the provisions of this subpart shall load HAP-containing materials only to tank trucks or railcars equipped with a vapor collection system that is compatible with the transfer rack's closed vent system or process piping.

(g) *Loading while systems connected.* The owner or operator of a transfer rack subject to this subpart shall load HAP-containing material only to tank trucks or railcars whose collection systems are connected to the transfer rack's closed vent system or process piping.

(h) *Vapor tightness procedures.* For the purposes of demonstrating vapor tightness to determine compliance with paragraph (d)(2) of this section, the procedures and equipment specified in paragraphs (h)(1) and (2) shall be used.

(1) The pressure test procedures specified in Method 27 of appendix A to 40 CFR part 60.

(2) A pressure measurement device that has a precision of  $\pm 2.5$  millimeters of mercury or better and that is capable of measuring above the pressure at which the tank truck or railcar is to be tested for vapor tightness.

(i) *Recordkeeping.* The owner or operator of a transfer rack shall record that the verification of DOT tank certification or Method 27 of appendix A to 40 CFR part 60 testing required in §63.84(c) has been performed. Various methods for the record of verification can be used, such as a check-off on a log sheet, a list of DOT serial numbers or Method 27 data, or a position description for gate security showing that the security guard will not allow any trucks on-site that do not have the appropriate documentation.

[67 FR 46288, July 12, 2002]

[↑ Back to Top](#)

### **§63.1106 Wastewater provisions.**

(a) *Process wastewater.* Except as specified in paragraphs (a)(1) through (a)(16) and paragraph (d) of this section, the owner or operator of each affected source shall comply with the HON process wastewater requirements in §§63.132 through 63.148.

(1) When terms used in §§63.132 through 63.148 are defined in §63.1101, the definition in §63.1101 shall apply, for the purposes of this subpart. For terms used in §§63.132 through 63.148 that are not defined in §63.1101, the definitions in §§63.101 and 63.111 shall apply.

(2) When the term chemical manufacturing production process unit, or CMPU, is used in §§63.132 through 63.148, the phrase “a process unit whose primary product is a product produced by a source category subject to this subpart” shall apply, for the purposes of this subpart.

(3) Owners and operators of affected sources are not required to comply with §63.132(b)(1) and (d) and §63.138(c). Further, owners and operators are exempt from all requirements in §§63.132 through 63.148 that pertain solely and exclusively to organic HAP listed in Table 8 of subpart G of this part.

(4) When the determination of equivalence criteria in §63.102(b) is referred to in §§63.132, 63.133, and 63.137, the alternative nonopacity emission standard provisions in §63.6(g) shall apply, for the purposes of this subpart.

(5) When the HON storage vessel requirements for internal floating roofs contained in §63.119(b) are referred to in §63.133(a)(2)(ii), the requirements in §63.1063(a)(1)(i), (2), and (b) shall apply, for the purposes of this subpart.

(6) When the HON storage vessel requirements for external floating roofs in §§63.119(c) and 63.120(b)(5) and (6) are referred to in §63.133(a)(2)(iii) and (d), the requirements in §63.1063(a)(1)(ii), (2), and (b) shall apply, for the purposes of this subpart.

(7) For the purposes of this subpart, §63.1063(c)(2)(iv) shall apply instead of §63.133(e).

(8) When §§63.143(c), (d), (e)(3) and 63.146(a) require the submission of a request for approval to monitor alternative parameters according to the procedures specified in §63.151(f) or (g), the owner or



operator requesting to monitor alternative parameters shall follow the procedures specified in §63.1108(c) or as specified in a referenced subpart.

(9) When §63.147(d) requires the owner or operator to keep records of the daily average value of each continuously monitored parameter for each operating day as specified in §63.152(f), the owner or operator shall keep records of each continuously monitored parameter for each operating day as specified in §63.998(b).

(10) When §63.132(a) and (b) refer to the “applicable dates specified in §63.100 of subpart F of this part,” the applicable compliance dates specified in §63.1102 shall apply, for purposes of this subpart.

(11) Where §63.152(b) and/or the Notification of Compliance Status is referred to in §§63.132 through 63.148, the Notification of Compliance Status requirements contained in §63.1110(a)(4) shall apply, for purposes of this subpart.

(12) Where §63.152(c) and/or the Periodic Report requirements are referred to §§63.132 through 63.148, the Periodic Report requirements contained in §63.1110(a)(5) shall apply, for purposes of this subpart.

(13) When Method 18 of Appendix A to part 60 of this chapter is specified in §63.139(c)(1)(ii), §63.145(d)(4), or §63.145(i)(2), either Method 18 or Method 25A may be used. The use of Method 25A of appendix A to part 60 of this chapter shall comply with paragraphs (a)(13)(i) and (a)(13)(ii) of this section.

(i) The organic HAP used as the calibration gas for Method 25A of appendix A of part 60 of this chapter shall be the single organic HAP representing the largest percent by volume of the emissions.

(ii) The use of Method 25A of appendix A of part 60 of this chapter is acceptable if the response from the high-level calibration gas is at least 20 times the standard deviation of the response from the zero calibration gas when the instrument is zeroed on the most sensitive scale.

(14) When the HON recordkeeping requirements for by-pass lines in §63.118(a)(3) is referred to in §63.148(f), the requirements in §63.998(d)(1)(ii)(A) shall apply, for the purposes of this subpart.

(15) When the Initial Notification requirements in §63.182(b) are referred to in §63.148(j), the requirements in §63.1110(c) shall apply, for the purposes of this subpart.

(16) For the purposes of this subpart, §63.148(k) shall not apply.

(b) *Maintenance wastewater.* The owner or operator of each affected source shall comply with the HON maintenance wastewater requirements in §63.105. When terms used in §63.105 are defined in §63.1101, the definition in §63.1101 shall apply, for the purpose of this subpart. For terms used in §63.105 that are not defined in §63.1101, the definitions in §§63.101 and 63.111 shall apply.

(c) *Liquid streams in open systems.* The owner or operator shall comply with the provisions of Table 35 of subpart G of this part for each item of equipment meeting the criteria specified in paragraphs (c)(1) through (3) of this section and either paragraph (c)(4)(i) or (ii) of this section, with the exceptions provided in paragraphs (c)(5) and (6) of this section.

(1) The item of equipment is one of the types of equipment identified in paragraphs (c)(1)(i) through (vii) of this section.

(i) Drain or drain hub;

(ii) Manhole (including sumps and other points of access to a conveyance system);

(iii) Lift station;

(iv) Trench;

(v) Pipe;

(vi) Oil/water separator; and

(vii) Tanks with capacities of 38 m<sup>3</sup> or greater.

(2) The item of equipment is part of an affected source that is subject to this subpart.

(3) The item of equipment is controlled less stringently than in Table 35 of subpart G of this part, and the item of equipment is not otherwise exempt from the provisions of this subpart, or a referenced subpart.

(4) The item of equipment:

(i) Is a drain, drain hub, manhole, lift station, trench, pipe, or oil/water separator that conveys water with a total annual average concentration greater than or equal to 10,000 parts per million by weight of Table 9 compounds (as defined under this subpart) at any flow rate; or a total annual average concentration greater than or equal to 1,000 parts per million by weight of Table 9 compounds (as defined under this subpart) at an annual average flow rate greater than or equal to 10 liters per minute.

(ii) Is a tank that receives one or more streams that contain water with a total annual average concentration greater than or equal to 1,000 parts per million by weight of Table 9 compounds (as defined under this subpart) at an annual average flow rate greater than or equal to 10 liters per minute. The owner or operator shall determine the characteristics of the stream as specified in paragraphs (c)(4)(ii)(A) and (B) of this section.

(A) The characteristics of the stream being received shall be determined at the inlet to the tank.

(B) The characteristics shall be determined according to the procedures in §63.144(b) and (c).

(5) When terms used in Table 35 of subpart G of this part are defined in §63.1101, the definition in §63.1101 shall apply, for the purpose of this subpart. For terms used in Table 35 of subpart G of this part that are not defined in §63.1101, the definitions in §63.101 and §63.111 shall apply.

(6) When Table 35 of subpart G of this part refers to 40 CFR 63.119(e)(1) or (e)(2) in the requirements for tanks, the owner or operator shall reduce emissions of total organic HAP by 95 weight-percent by venting emissions through a closed vent system to any combination of control devices meeting the requirements in §63.982(a)(1), for the purposes of this subpart.

(d) The compliance date for the affected sources subject to the provisions of this section is specified in §63.1102.

[64 FR 63701, Nov. 22, 1999, as amended at 79 FR 60926, Oct. 8, 2014]

[↑ Back to Top](#)

### **§63.1107 Equipment leaks.**

(a) Each piece of equipment within a process unit that can reasonably be expected to contain equipment in organic HAP service is presumed to be in organic HAP service unless an owner or operator demonstrates that the piece of equipment is not in organic HAP service. For a piece of equipment to be considered not in organic HAP service, it must be determined that the percent organic HAP content can be reasonably expected not to exceed the percent by weight control applicability criteria specified in §63.1103 for an affected source on an annual average basis. For purposes of determining the percent organic HAP content of the process fluid that is contained in or contacts equipment, Method 18 of 40 CFR part 60, appendix A shall be used.

(b) An owner or operator may use good engineering judgment rather than the procedures in paragraph (a) of this section to determine that the percent organic HAP content does not exceed the percent by weight control applicability criteria specified in §63.1103 for an affected source. When an owner or operator and the Administrator do not agree on whether a piece of equipment is not in organic HAP service, however, the procedures in paragraph (a) of this section shall be used to resolve the disagreement.

(c) If an owner or operator determines that a piece of equipment is in organic HAP service, the determination can be revised after following the procedures in paragraph (a) of this section, or by documenting that a change in the process or raw materials no longer causes the equipment to be in organic HAP service.

(d) Samples used in determining the percent organic HAP content shall be representative of the process fluid that is contained in or contacts the equipment.

(e) *Requirements for pressure relief devices.* For acrylic and modacrylic fiber production affected sources and polycarbonate production affected sources, except as specified in paragraph (e)(4) of this section, the owner or operator must comply with the requirements specified in paragraphs (e)(1) and (2) of this section for pressure relief devices in organic HAP gas or vapor service. Except as specified in paragraph (e)(4) of this section, the owner or operator of an acrylic and modacrylic fiber production affected source or polycarbonate production affected source must also comply with the requirements specified in paragraph (e)(3) of this section for all pressure relief devices in organic HAP service.

(1) *Operating requirements.* Except during a pressure release event, operate each pressure relief device in organic HAP gas or vapor service with an instrument reading of less than 500 ppm above background as described in Method 21 of 40 CFR part 60, Appendix A.

(2) *Pressure release requirements.* For pressure relief devices in organic HAP gas or vapor service, the owner or operator must comply with either paragraph (e)(2)(i) or (ii) of this section following a pressure release, as applicable.

(i) If the pressure relief device does not consist of or include a rupture disk, conduct instrument monitoring, as described in Method 21 of 40 CFR part 60, Appendix A, no later than 5 calendar days after the pressure relief device returns to organic HAP service following a pressure release to verify that the pressure relief device is operating with an instrument reading of less than 500 ppm above background, except as provided in §63.171 or §63.1024(d), as applicable.

(ii) If the pressure relief device consists of or includes a rupture disk, install a replacement disk as soon as practicable after a pressure release, but no later than 5 calendar days after the pressure release, except as provided in §63.171 or §63.1024(d), as applicable.

(3) *Pressure release management.* Except as specified in paragraph (e)(4) of this section, emissions of organic HAP to the atmosphere from pressure relief devices in organic HAP service are prohibited, and the owner or operator must comply with the requirements specified in paragraphs (e)(3)(i) and (ii) of this section for all pressure relief devices in organic HAP service.

(i) The owner or operator must equip each pressure relief device in organic HAP service with a device(s) or parameter monitoring system that is capable of:

(A) Identifying the pressure release;

(B) Recording the time and duration of each pressure release; and

(C) Notifying operators immediately that a pressure release is occurring. The device or monitoring system may be either specific to the pressure relief device itself or may be associated with the process system or piping, sufficient to indicate a pressure release to the atmosphere. Examples of these types of devices and systems include, but are not limited to, a rupture disk indicator, magnetic sensor, motion detector on the pressure relief valve stem, flow monitor, or pressure monitor.

(ii) If any pressure relief device in organic HAP service releases to atmosphere as a result of a pressure release event, the owner or operator must calculate the quantity of organic HAP released during each pressure release event and report this quantity as required in paragraph (g) of this section. Calculations may be based on data from the pressure relief device monitoring alone or in combination with process parameter monitoring data and process knowledge.

(4) *Pressure relief devices routed to a control device, process, fuel gas system, or drain system.* If a pressure relief device in organic HAP service is designed and operated to route all HAP emissions from pressure releases through a closed vent system to a control device or to a process, fuel gas system, or drain system, the owner or operator is not required to comply with paragraphs (e)(1), (2), or (3) (if applicable) of this section for that pressure relief device. The fuel gas system or closed vent system and control device (if applicable) must meet the requirements of §63.172 or §63.1034, as applicable (except that the term “pressure relief devices” shall apply instead of the term “equipment leaks” in §63.1034). The drain system (if applicable) must meet the requirements of §63.136.

(f) *Recordkeeping requirements.* For acrylic and modacrylic fiber production affected sources and polycarbonate production affected sources, for pressure relief devices in organic HAP service, keep records of the information specified in paragraphs (f)(1) through (5) of this section, as applicable.

(1) A list of identification numbers for pressure relief devices that vent to a fuel gas system, process, drain system, or closed-vent system and control device, under the provisions in paragraph (e)(4) of this section.

(2) A list of identification numbers for pressure relief devices subject to the provisions in paragraph (e)(1) of this section.

(3) A list of identification numbers for pressure relief devices equipped with rupture disks, under the provisions in paragraph (e)(2)(ii) of this section.

(4) The dates and results of the monitoring following a pressure release for each pressure relief device subject to the provisions in paragraphs (e)(1) and (2) of this section. The results shall include:

(i) The background level measured during each compliance test.

(ii) The maximum instrument reading measured at each piece of equipment during each compliance test.

(5) For pressure relief devices in organic HAP service subject to paragraph (e)(3) of this section, keep records of each pressure release to the atmosphere, including the following information:

(i) The source, nature, and cause of the pressure release.

(ii) The date, time, and duration of the pressure release.

(iii) An estimate of the quantity of total HAP emitted during the pressure release and the calculations used for determining this quantity.

(iv) The actions taken to prevent this pressure release.

(v) The measures adopted to prevent future such pressure releases.

(g) *Periodic reports.* For owners or operators of an acrylic and modacrylic fiber production affected source or polycarbonate production affected source subject to paragraph (e) of this section, Periodic Reports must include the information specified in paragraphs (g)(1) through (3) of this section for pressure relief devices in organic HAP service.

(1) For pressure relief devices in organic HAP service subject to paragraph (e) of this section, report confirmation that all monitoring to show compliance was conducted within the reporting period.

(2) For pressure relief devices in organic HAP gas or vapor service subject to paragraph (e)(2) of this section, report any instrument reading of 500 ppm above background or greater, more than 5 days after the relief device returns to organic HAP gas or vapor service after a pressure release.

(3) For pressure relief devices in organic HAP service subject to paragraph (e)(3) of this section, report each pressure release to the atmosphere, including the following information:

(i) The source, nature, and cause of the pressure release.

(ii) The date, time, and duration of the pressure release.

(iii) An estimate of the quantity of total HAP emitted during the pressure release and the method used for determining this quantity.

(iv) The actions taken to prevent this pressure release.

(v) The measures adopted to prevent future such pressure releases.

[64 FR 34921, June 29, 1999, as amended at 79 FR 60926, Oct. 8, 2014]

[↑ Back to Top](#)

### **§63.1108 Compliance with standards and operation and maintenance requirements.**

(a) *Requirements.* The requirements of paragraphs (a)(1), (2), and (5) of this section apply to all affected sources except acrylic and modacrylic fiber production affected sources and polycarbonate production affected sources. The requirements of paragraph (a)(4) of this section apply only to acrylic and modacrylic fiber production affected sources and polycarbonate production affected sources. The requirements of paragraphs (a)(3), (6), and (7) of this section apply to all affected sources.

(1) Except as provided in paragraph (a)(2) of this section, the emission limitations and established parameter ranges of this part shall apply at all times except during periods of startup, shutdown, malfunction, or non-operation of the affected source (or specific portion thereof) resulting in cessation of the emissions to which this subpart applies. However, if a startup, shutdown, malfunction or period of non-operation of one portion of an affected source does not affect the ability of a particular emission point to comply with the specific provisions to which it is subject, then that emission point shall still be required to comply with the applicable provisions of this subpart and any of the subparts that are referenced by this subpart during startup, shutdown, malfunction, or period of non-operation.

(2) If equipment leak requirements are referenced by this subpart for a subject source category, such requirements shall apply at all times except during periods of startup, shutdown, or malfunction, process unit shutdown (as defined in §63.1101), or non-operation of the affected source (or specific portion thereof) in which the lines are drained and depressurized resulting in cessation of the emissions to which the equipment leak requirements apply.

(3) For batch unit operations, shutdown does not include the normal periods between batch cycles; and startup does not include the recharging of batch unit operations, or the transitional conditions due to changes in product.

(4)(i) For acrylic and modacrylic fiber production affected sources and polycarbonate production affected sources, the emission limitations and established parameter ranges of this part shall apply at all times except during periods of non-operation of the affected source (or specific portion thereof) resulting in cessation of the emissions to which this subpart applies. Equipment leak requirements shall apply at all times except during periods of non-operation of the affected source (or specific portion thereof) in which the lines are drained and depressurized resulting in cessation of the emissions to which the equipment leak requirements apply.

(ii) *General duty.* At all times, the owner or operator must operate and maintain any affected source, including associated air pollution control equipment and monitoring equipment, in a manner consistent with safety and good air pollution control practices for minimizing emissions. The general duty to minimize emissions does not require the owner or operator to make any further efforts to reduce emissions if levels required by the applicable standard have been achieved. Determination of whether a source is operating in compliance with operation and maintenance requirements will be based on information available to the Administrator, which may include, but is not limited to, monitoring results, review of operation and maintenance procedures, review of operation and maintenance records, and inspection of the source.

(5) During startups, shutdowns, and malfunctions when the emission standards of this subpart and the subparts referenced by this subpart do not apply pursuant to paragraphs (a)(1) through (3) of this section, the owner or operator shall implement, to the extent reasonably available, measures to prevent or minimize excess emissions. The measures to be taken shall be identified in the startup, shutdown, and malfunction plan (if applicable), and may include, but are not limited to, air pollution control technologies, recovery technologies, work practices, pollution prevention, monitoring, and/or changes in the manner of operation of the affected source. Back-up control devices are not required, but may be used if available. Compliance with an inadequate startup, shutdown, and malfunction plan developed pursuant to §63.1111 is not a shield for failing to comply with good operation and maintenance requirements.

(6) Malfunctions shall be corrected as soon as practical after their occurrence.

(7) Operation and maintenance requirements established pursuant to section 112 of the Act are enforceable, independent of emissions limitations or other requirements in relevant standards.

(b) *Compliance assessment procedures*—(1) *Parameter monitoring: compliance with operating conditions.* Compliance with the required operating conditions for the monitored control devices or recovery devices may be determined by, but is not limited to, the parameter monitoring data for emission points that are required to perform continuous monitoring. For each excursion, except as provided for in paragraphs (b)(1)(i) and (ii) of this section, the owner or operator shall be deemed to have failed to have applied the control in a manner that achieves the required operating conditions.

(i) An excursion that meets the requirements of paragraph (b)(2) of this section is not a violation.

(ii) Excused excursions are not allowed for acrylic and modacrylic fiber production affected sources or polycarbonate production affected sources. For all other affected sources, an excused excursion, as described in §63.998(b)(6)(ii), is not a violation.

(2) *Parameter monitoring: Excursions.* An excursion is not a violation in cases where continuous monitoring is required and the excursion does not count toward the number of excused excursions (as described in §63.998(b)(6)(ii)), if the conditions of paragraphs (b)(2)(i) or (ii) of this section are met, except that the conditions of paragraph (b)(2)(i) of this section do not apply for acrylic and modacrylic fiber production affected sources and polycarbonate production affected sources. Nothing in this paragraph shall be construed to allow or excuse a monitoring parameter excursion caused by any activity that violates other applicable provisions of this subpart or a subpart referenced by this subpart.

(i) During periods of startup, shutdown, or malfunction (and the source is operated during such periods in accordance with §63.1111(a)), or

(ii) During periods of non-operation of the affected source or portion thereof (resulting in cessation of the emissions to which the monitoring applies).

(3) *Operation and maintenance procedures.* Determination of whether acceptable operation and maintenance procedures are being used will be based on information available to the Administrator. This information may include, but is not limited to, monitoring results, review of operation and maintenance procedures (including the startup, shutdown, and malfunction plan under §63.1111), review of operation and maintenance records, and inspection of the affected source, and alternatives approved as specified in §63.1113.

(4) *Applicability and compliance assessment procedures.* Applicability and compliance with standards shall be governed by, in part, but not limited to, the use of data, tests, and requirements according to paragraphs (b)(4)(i) through (iii) of this section. Compliance with design, equipment, work practice, and operating standards, including those for equipment leaks, shall be determined according to paragraph (b)(5) of this section.

(i) *Applicability assessments.* Unless otherwise specified in a relevant test method required to assess control applicability, each test shall consist of three separate runs using the applicable test method. Each run shall be conducted for the time and under the conditions specified in this subpart. The arithmetic mean of the results of the three runs shall apply when assessing applicability. Upon receiving approval from the Administrator, results of a test run may be replaced with results of an additional test run if it meets the criteria specified in paragraphs (a)(4)(i)(A) through (D) of this section.

(A) A sample is accidentally lost after the testing team leaves the site; or

(B) Conditions occur in which one of the three runs must be discontinued because of forced shutdown; or

(C) Extreme meteorological conditions occur;

(D) Other circumstances occur that are beyond the owner or operator's control.

(ii) *Performance test.* (A) The Administrator may determine compliance with emission limitations of this subpart based on, but not limited to, the results of performance tests conducted according to the procedures specified in §63.997, unless otherwise specified in this subpart or a subpart referenced by this subpart.

(B) For acrylic and modacrylic fiber production affected sources and polycarbonate production affected sources, performance tests shall be conducted under such conditions as the Administrator specifies to the owner or operator based on representative performance of the affected source for the period being tested. Representative conditions exclude periods of startup and shutdown unless specified by the Administrator or an applicable subpart. The owner or operator may not conduct performance tests during periods of malfunction. The owner or operator must record the process information that is necessary to document operating conditions during the test and include in such record an explanation to support that such



conditions represent normal operation. Upon request, the owner or operator shall make available to the Administrator such records as may be necessary to determine the conditions of performance tests.

(iii) *Operation and maintenance requirements.* The Administrator may determine compliance with the operation and maintenance standards of this subpart by, but not limited to, evaluation of an owner or operator's conformance with operation and maintenance requirements, including the evaluation of monitoring data, as specified in this subpart or a subpart referenced by this subpart.

(5) *Design, equipment, work practice, or operational standards.* The Administrator may determine compliance with design, equipment, work practice, or operational requirements by, but is not limited to, review of records, inspection of the affected source, and by evaluation of an owner or operator's conformance with operation and maintenance requirements as specified in this subpart, and in the subparts referenced by this subpart.

(c) *Finding of compliance.* The Administrator may make a finding concerning an affected source's compliance with an emission standard or operating and maintenance requirement as specified in, but not limited to, paragraphs (a) and (b) of this section, upon obtaining all of the compliance information required by the relevant standard (including the written reports of performance test results, monitoring results, and other information, if applicable) and any information available to the Administrator to determine whether proper operation and maintenance practices are being used. Standards in this subpart and methods of determining compliance are in metric units followed by the equivalents in English units. The Administrator will make findings of compliance with the numerical standards of this subpart using metric units.

(d) *Compliance time.* All terms that define a period of time for completion of required tasks (e.g., weekly, monthly, quarterly, annually), unless specified otherwise in the section or subsection that imposes the requirement, refer to the standard calendar periods.

(1) Notwithstanding time periods specified for completion of required tasks, time periods may be changed by mutual agreement between the owner or operator and the Administrator, as specified in §63.1110(h). For each time period that is changed by agreement, the revised period shall remain in effect until it is changed. A new request is not necessary for each recurring period.

(2) When the period specified for compliance is a standard calendar period, if the initial compliance date occurs after the beginning of the period, compliance shall be required according to the schedule specified in paragraph (d)(2) (i) or (ii) of this section, as appropriate.

(i) Compliance shall be required before the end of the standard calendar period within which the compliance deadline occurs, if there remain at least 3 days for tasks that must be performed weekly, at least 2 weeks for tasks that must be performed monthly, at least 1 month for tasks that must be performed each quarter, or at least 3 months for tasks that must be performed annually; or

(ii) In all other cases, compliance shall be required before the end of the first full standard calendar period after the period within which the initial compliance deadline occurs.

(3) In all instances where a provision requires completion of a task during each of multiple successive periods, an owner or operator may perform the required task at any time during the specified period,

provided the task is conducted at a reasonable interval after completion of the task during the previous period.

[64 FR 34921, June 29, 1999, as amended at 64 FR 63709, Nov. 22, 1999; 71 FR 20458, Apr. 20, 2006; 79 FR 60927, Oct. 8, 2014]

[↑ Back to Top](#)

### **§63.1109 Recordkeeping requirements.**

(a) *Maintaining notifications, records, and reports.* Except as provided in paragraph (b) of this section, the owner or operator of each affected source subject to this subpart shall keep copies of notifications, reports and records required by this subpart and subparts referenced by this subpart for at least 5 years, unless otherwise specified under this subpart.

(b) *Copies of reports.* If the Administrator has waived the requirement of §63.1110(g)(1) for submittal of copies of reports, the owner or operator is not required to maintain copies of the waived reports. This paragraph applies only to reports and not the underlying records that must be maintained as specified in this subpart and the subparts referenced by this subpart.

(c) *Availability of records.* All records required to be maintained by this subpart or a subpart referenced by this subpart shall be maintained in such a manner that they can be readily accessed and are suitable for inspection. The records of the remaining 3 years, where required, may be retained offsite. Records may be maintained in hard copy or computer-readable form including, but not limited to, on paper, microfilm, computer, computer disk, magnetic tape, or microfiche.

(d) *Control applicability records.* Owners or operators shall maintain records containing information developed and used to assess control applicability under §63.1103 (e.g., combined total annual emissions of regulated organic HAP).

[64 FR 34921, June 29, 1999, as amended at 67 FR 39307, June 7, 2002]

[↑ Back to Top](#)

### **§63.1110 Reporting requirements.**

(a) *Required reports.* Each owner or operator of an affected source subject to this subpart shall submit the reports listed in paragraphs (a)(1) through (8) of this section, as applicable. Each owner or operator of an acrylic and modacrylic fiber production affected source or polycarbonate production affected source subject to this subpart shall also submit the reports listed in paragraph (a)(9) of this section in addition to the reports listed in paragraphs (a)(1) through (8) of this section, as applicable.

(1) A Notification of Initial Startup described in paragraph (b) of this section, as applicable.

(2) An Initial Notification described in paragraph (c) of this section.

(3) [Reserved]

(4) A Notification of Compliance Status report described in paragraph (d) of this section.

(5) Periodic Reports described in paragraph (e) of this section.

(6) Application for approval of construction or reconstruction described in §63.5(d) of subpart A of this part.

(7) Startup, Shutdown, and Malfunction Reports described in §63.1111 (except for acrylic and modacrylic fiber production affected sources and polycarbonate production affected sources).

(8) Other reports. Other reports shall be submitted as specified elsewhere in this subpart and subparts referenced by this subpart.

(9) *Electronic reporting.* Within 60 days after the date of completing each performance test (as defined in §63.2), the owner or operator must submit the results of the performance tests, including any associated fuel analyses, required by this subpart according to the methods specified in paragraphs (a)(9)(i) or (ii) of this section.

(i) For data collected using test methods supported by the EPA-provided software, the owner or operator shall submit the results of the performance test to the EPA by direct computer-to-computer electronic transfer via EPA-provided software, unless otherwise approved by the Administrator. Owners or operators, who claim that some of the information being submitted for performance tests is confidential business information (CBI), must submit a complete file using EPA-provided software that includes information claimed to be CBI on a compact disc, flash drive, or other commonly used electronic storage media to the EPA. The electronic media must be clearly marked as CBI and mailed to U.S. EPA/OAPQS/CORE CBI Office, Attention: WebFIRE Administrator, MD C404-02, 4930 Old Page Rd., Durham, NC 27703. The same file with the CBI omitted must be submitted to the EPA by direct computer-to-computer electronic transfer via EPA-provided software.

(ii) For any performance test conducted using test methods that are not compatible with the EPA-provided software, the owner or operator shall submit the results of the performance test to the Administrator at the appropriate address listed in §60.4.

(b) *Notification of initial startup—(1) Contents.* An owner or operator of an affected source for which a notice of initial startup has not been submitted under §63.5, shall send the Administrator written notification of the actual date of initial startup of an affected source. This paragraph does not apply to an affected source in existence on the effective date of this rule.

(2) *Due date.* The notification of the actual date of initial startup shall be postmarked within 15 days after such date.

(c) *Initial Notification.* Owners or operators of affected sources who are subject to this subpart shall notify the Administrator of the applicability of this subpart by submitting an Initial Notification according to the schedule described in paragraph (c)(1) of this section. The notice shall include the information specified in paragraphs (c)(2) through (7) of this section, as applicable. An application for approval of construction or reconstruction required under §63.5(d) of subpart A of this part may be used to fulfill the initial notification requirements.

(1) The initial notification shall be postmarked within 1 year after the source becomes subject to this subpart.

(2) Identification of the storage vessels subject to this subpart.

(3) Identification of the process vents subject to this subpart.

(4) Identification of the transfer racks subject to this subpart.

(5) For equipment leaks, identification of the process units subject to this subpart.

(6) Identification of other equipment or emission points subject to this subpart.

(7) As an alternative to the requirements specified in paragraphs (c)(1) through (3) and (c)(5) of this section, process units can be identified instead of individual pieces of equipment. For this alternative, the kind of emission point in the process unit that will comply must also be identified.

(d) *Notification of Compliance Status*—(1) *Contents*. The owner or operator shall submit a Notification of Compliance Status for each affected source subject to this subpart containing the information specified in paragraphs (d)(1)(i) and (d)(1)(ii) of this section. For pressure relief devices subject to the requirements of §63.1107(e)(3), the owner or operator of an acrylic and modacrylic fiber production affected source or polycarbonate production affected source shall also submit the information listed in paragraph (d)(1)(iii) of this section in a supplement to the Notification of Compliance Status within 150 days after the first applicable compliance date for pressure relief device monitoring.

(i) The Notification of Compliance Status shall include the information specified in this subpart and the subparts referenced by this subpart. Alternatively, this information can be submitted as part of a title V permit application or amendment.

(ii) The Notification of Compliance Status shall include a statement from the owner or operator identifying which subpart he or she has elected to comply with, where given a choice, as provided for in §63.1100(g).

(iii) For pressure relief devices in organic HAP service, a description of the device or monitoring system to be implemented, including the pressure relief devices and process parameters to be monitored (if applicable), and a description of the alarms or other methods by which operators will be notified of a pressure release.

(2) *Due date*. The owner or operator shall submit the Notification of Compliance Status for each affected source 240 days after the compliance date specified for the affected source under this subpart, or 60 days after completion of the initial performance test or initial compliance assessment, whichever is earlier. Notification of Compliance Status reports may be combined for multiple affected sources as long as the due date requirements for all sources covered in the combined report are met.

(e) *Periodic Reports*. The owner or operator of an affected source subject to monitoring requirements of this subpart, or to other requirements of this subpart or subparts referenced by this subpart, where periodic reporting is specified, shall submit a Periodic Report.

(1) *Contents.* Periodic Reports shall include all information specified in this subpart and subparts referenced by this subpart.

(2) *Due date.* The Periodic Report shall be submitted no later than 60 days after the end of each 6-month period. The first report shall cover the 6-month period after the Notification of Compliance Status report is due. The first report shall be submitted no later than the last day of the month that includes the date 8 months (6 months and 60 days) after the Notification of Compliance Status report is due.

(3) *Overlap with title V reports.* Information required by this subpart, which is submitted with a title V periodic report, need not also be included in a subsequent Periodic Report required by this subpart or subpart referenced by this subpart. The title V report shall be referenced in the Periodic Report required by this subpart.

(f) *General report content.* All reports and notifications submitted pursuant to this subpart, including reports that combine information required under this subpart and a subpart referenced by this subpart, shall include the information specified in paragraphs (f)(1) through (4) of this section.

(1) The name, address and telephone number (fax number may also be provided) of the owner or operator.

(2) The name, address and telephone number of the person to whom inquiries should be addressed, if different than the owner or operator.

(3) The address (physical location) of the reporting facility.

(4) Identification of each affected source covered in the submission and identification of the subparts (this subpart and the subparts referenced in this subpart) that are applicable to that affected source. Summaries and groupings of this information are permitted.

(g) *Report and notification submission—(1) Submission to the Environmental Protection Agency.* All reports and notifications required under this subpart shall be sent to the appropriate EPA Regional Office and to the delegated State authority, except that request for permission to use an alternative means of emission limitation as provided for in §63.1113 shall be submitted to the Director of the EPA Office of Air Quality Planning and Standards, U.S. Environmental Protection Agency, MD-10, Research Triangle Park, North Carolina, 27711. The EPA Regional Office may waive the requirement to submit a copy of any reports or notifications at its discretion.

(2) *Submission of copies.* If any State requires a notice that contains all the information required in a report or notification listed in this subpart, an owner or operator may send the appropriate EPA Regional Office a copy of the report or notification sent to the State to satisfy the requirements of this subpart for that report or notification.

(3) *Method of submission.* Wherever this subpart specifies “postmark” dates, submittals may be sent by methods other than the U.S. Mail (e.g., by fax or courier). Submittals shall be sent on or before the specified date.

(4) *Submission by electronic media.* If acceptable to both the Administrator and the owner or operator of an affected source, reports may be submitted on electronic media.

(h) *Adjustment to timing of submittals and review of required communications*—(1) *Alignment with title V submission.* An owner or operator may submit Periodic Reports required by this subpart on the same schedule as the title V periodic report for the facility. The owner or operator using this option need not obtain prior approval, but must ensure that no reporting gaps occur. The owner or operator shall clearly identify the change in reporting schedule in the first report filed under this paragraph. The requirements of paragraph (f) of this section are not waived when implementing this change.

(2) *Establishment of a common schedule.* An owner or operator may arrange by mutual agreement (which may be a standing agreement) with the Administrator a common schedule on which periodic reports required by this subpart shall be submitted throughout the year as long as the reporting period is not extended. Procedures governing the implementation of this provision are specified in paragraphs (h)(3) through (7) of this section.

(3) *Submission requirements.* Except as allowed by paragraph (h)(1) of this section, until an adjustment of a time period or postmark deadline has been approved by the Administrator under paragraphs (h)(5) and (6) of this section, the owner or operator of an affected source remains strictly subject to the required submittal deadlines specified in this subpart and subparts referenced by this subpart.

(4) *Request for adjustment of reporting schedule.* Except as allowed by paragraph (h)(1) of this section, an owner or operator shall request the adjustment provided for in paragraphs (h)(5) and (6) of this section each time he or she wishes to change an applicable time period or postmark deadline specified in this subpart or subparts referenced by this subpart. A request for a change to the periodic reporting schedule need only be made once for every schedule change and not once for every semiannual report submitted.

(5) *Alteration of time periods or deadlines.* Notwithstanding time periods or postmark deadlines specified in this subpart for the submittal of information to the Administrator by an owner or operator, or the review of such information by the Administrator, such time periods or deadlines may be changed by mutual agreement between the owner or operator and the Administrator. An owner or operator who wishes to request a change in a time period or postmark deadline for a particular requirement shall request the adjustment in writing as soon as practical before the subject activity is required to take place. The owner or operator shall include in the request whatever information he or she considers useful to convince the Administrator that an adjustment is warranted.

(6) *Approval of request for adjustment.* If, in the Administrator's judgment, an owner or operator's request for an adjustment to a particular time period or postmark deadline is warranted, the Administrator will approve the adjustment. The Administrator will notify the owner or operator in writing of approval or disapproval of the request for an adjustment within 15 calendar days of receiving sufficient information to evaluate the request.

(7) *Notification of delay.* If the Administrator is unable to meet a specified deadline, he or she will notify the owner or operator of any significant delay and inform the owner or operator of the amended schedule.

[64 FR 34921, June 29, 1999, as amended at 64 FR 63709, Nov. 22, 1999; 79 FR 60928, Oct. 8, 2014]

[↑ Back to Top](#)

**§63.1111 Startup, shutdown, and malfunction.**

(a) *Startup, shutdown, and malfunction plan.* The requirements of this paragraph (a) apply to all affected sources except for acrylic and modacrylic fiber production affected sources and polycarbonate production affected sources.

(1) *Description and purpose of plan.* The owner or operator of an affected source shall develop a written startup, shutdown, and malfunction plan that describes, in detail, procedures for operating and maintaining the affected source during periods of startup, shutdown, and malfunction. This plan shall also include a program of corrective action for malfunctioning process and air pollution control equipment used to comply with relevant standards under this subpart. The plan shall also address routine or otherwise predictable CPMS malfunctions. This plan shall be developed by the owner or operator by the affected source's compliance date under this subpart. The requirement to develop this plan shall be incorporated into the source's title V permit. This requirement is optional for equipment that must comply with subparts TT or UU under this subpart. It is not optional for equipment equipped with a closed vent system and control device subject to this subpart and subpart SS of this part. The purpose of the startup, shutdown, and malfunction plan is described in paragraphs (a)(1)(i) and (ii) of this section.

(i) To ensure that owners or operators are prepared to correct malfunctions as soon as practical after their occurrence, in order to minimize excess emissions of regulated organic HAP; and

(ii) To reduce the reporting burden associated with periods of startup, shutdown, and malfunction (including corrective action taken to restore malfunctioning process and air pollution control equipment to its normal or usual manner of operation).

(2) *Operation of source.* During periods of startup, shutdown, and malfunction, the owner or operator of an affected source subject to this subpart YY shall operate and maintain such affected source (including associated air pollution control equipment and CPMS) in a manner consistent with safety and good air pollution control practices for minimizing emissions to the extent practical. The general duty to minimize emissions during a period of startup, shutdown, or malfunction does not require the owner or operator to achieve emission levels that would be required by the applicable standard at other times if this is not consistent with safety and good air pollution control practices, nor does it require the owner or operator to make any further efforts to reduce emissions if levels required by the applicable standard have been achieved. Determination of whether such operation and maintenance procedures are being used will be based on information available to the Administrator which may include, but is not limited to, monitoring results, review of operation and maintenance procedures (including the startup, shutdown, and malfunction plan required by this section), review of operation and maintenance records, and inspection of the source.

(3) *Use of additional procedures.* To satisfy the requirements of this section to develop a startup, shutdown, and malfunction plan, the owner or operator of an affected source may use the affected source's standard operating procedures (SOP) manual, or an Occupational Safety and Health Administration (OSHA) or other plan, provided the alternative plans meet all the requirements of this section and are made available for inspection when requested by the Administrator.

(4) *Revisions to the plan.* Based on the results of a determination made under §63.1108(b)(3), the Administrator may require that an owner or operator of an affected source make changes to the startup, shutdown, and malfunction plan for that source. The Administrator may require reasonable revisions to a

startup, shutdown, and malfunction plan if the Administrator finds that the plan is inadequate as specified in paragraphs (a)(4)(i) through (iv) of this section:

- (i) Does not address a startup, shutdown, and malfunction event of the CPMS, the air pollution control equipment, or the affected source that has occurred; or
- (ii) Fails to provide for the operation of the affected source (including associated air pollution control equipment and CPMS) during a startup, shutdown, and malfunction event in a manner consistent with good air pollution control practices for minimizing emissions to the extent practical; or
- (iii) Does not provide adequate procedures for correcting malfunctioning process and air pollution control equipment as quickly as practicable; or
- (iv) Does not provide adequate measures to prevent or minimize excess emissions to the extent practical as specified in §63.1108(a)(5).

(5) *Additional malfunction plan requirements.* If the startup, shutdown, and malfunction plan fails to address or inadequately addresses an event that meets the characteristics of a malfunction but was not included in the startup, shutdown, and malfunction plan at the time the owner or operator developed the plan, the owner or operator shall revise the startup, shutdown, and malfunction plan within 45 days after the event to include detailed procedures for operating and maintaining the affected source during similar malfunction events and a program of corrective action for similar malfunctions of process or air pollution control equipment or CPMS.

(b) *Startup, shutdown, and malfunction reporting requirements.* The requirements of this paragraph (b) apply to all affected sources except for acrylic and modacrylic fiber production affected sources and polycarbonate production affected sources.

(1) *Periodic startup, shutdown, and malfunction reporting requirements.* If actions taken by an owner or operator during a startup, shutdown, and malfunction of an affected source, or of a control device or monitoring system required for compliance (including actions taken to correct a malfunction) are consistent with the procedures specified in the affected source's plan, then the owner or operator shall state such information in a startup, shutdown, and malfunction report. During the reporting period, reports shall only be required for startups, shutdowns, and malfunctions during which excess emissions, as defined in §63.1108(a)(5), occur during the reporting period. A startup, shutdown, and malfunction report can be submitted as part of a Periodic Report required under §63.1110(a)(5), or on a more frequent basis if specified otherwise under this subpart or a subpart referenced by this subpart or as established otherwise by the permitting authority in the affected source's title V permit. The startup, shutdown, and malfunction report shall be delivered or postmarked by the 30th day following the end of each calendar half (or other calendar reporting period, as appropriate), unless the information is submitted with the Periodic Report. The report shall include the information specified in paragraphs (b)(1)(i) through (b)(1)(iv) of this section.

(i) The name, title, and signature of the owner or operator or other responsible official certifying its accuracy.



(ii) The number of startup, shutdown, and malfunction events and the total duration of all periods of startup, shutdown, and malfunction for the reporting period if the total duration amounts to either of the durations in paragraphs (b)(1)(ii)(A) or (B) of this section. Records of the number of CPMS startup, shutdown, and malfunction events and the total duration of all periods of startup, shutdown, and malfunction for the reporting period are required under §63.998(c)(1)(ii)(C) and (D) of this section.

(A) Total duration of periods of malfunctioning of a CPMS equal to or greater than 5 percent of that CPMS operating time for the reporting period; or

(B) Total duration of periods of startup, shutdown, and malfunction for an affected source equal to or greater than 1 percent of that affected source's operating time for the reporting period.

(iii) Records documenting each startup, shutdown and malfunction event as required under §63.998(c)(1)(ii)(F).

(iv) Records documenting the total duration of operating time as required under §63.998(c)(1)(ii)(H).

(2) *Immediate startup, shutdown, and malfunction reports.* Notwithstanding the allowance to reduce the frequency of reporting for startup, shutdown, and malfunction reports under paragraph (b)(1) of this section, any time an action taken by an owner or operator during a startup, shutdown, or malfunction (including actions taken to correct a malfunction) during which excess emissions occur is not consistent with the procedures specified in the affected source's plan, the owner or operator shall report the actions taken for that event within 2 working days after commencing actions inconsistent with the plan, followed by a letter delivered or postmarked within 7 working days after the end of the event. The immediate report required under this paragraph shall contain the name, title, and signature of the owner or operator or other responsible official who is certifying its accuracy, explaining the circumstances of the event, the reasons for not following the startup, shutdown, and malfunction plan, and whether any excess emissions and/or parameter monitoring exceedances are believed to have occurred. Notwithstanding the requirements of the previous sentence, after the effective date of an approved permit program in the State in which an affected source is located, the owner or operator may make alternative reporting arrangements, in advance, with the permitting authority in that State. Procedures governing the arrangement of alternative reporting requirements under this paragraph are specified in §63.1110(h).

(c) *Malfunction recordkeeping and reporting.* The requirements of this paragraph (c) apply only to acrylic and modacrylic fiber production affected sources and polycarbonate production affected sources.

(1) *Records of malfunctions.* The owner or operator shall keep the records specified in paragraphs (c)(1)(i) through (iii) of this section.

(i) In the event that an affected unit fails to meet an applicable standard, record the number of failures. For each failure record the date, time, and duration of each failure.

(ii) For each failure to meet an applicable standard, record and retain a list of the affected sources or equipment, an estimate of the quantity of each regulated pollutant emitted over any emission limit, and a description of the method used to estimate the emissions.

(iii) Record actions taken to minimize emissions in accordance with §63.1108(a)(4)(ii), and any corrective actions taken to return the affected unit to its normal or usual manner of operation.

(2) *Reports of malfunctions.* If a source fails to meet an applicable standard, report such events in the Periodic Report. Report the number of failures to meet an applicable standard. For each instance, report the date, time and duration of each failure. For each failure the report must include a list of the affected sources or equipment, an estimate of the quantity of each regulated pollutant emitted over any emission limit, and a description of the method used to estimate the emissions.

[64 FR 34921, June 29, 1999, as amended at 71 FR 20458, Apr. 20, 2006; 79 FR 60929, Oct. 8, 2014]

[↑ Back to Top](#)

### **§63.1112 Extension of compliance, and performance test, monitoring, recordkeeping and reporting waivers and alternatives.**

(a) *Extension of compliance*—(1) *Extension of compliance with emission standards.* Until an extension of compliance has been granted by the Administrator under this paragraph, the owner or operator of an affected source subject to the requirements of this subpart shall comply with all applicable requirements of this subpart.

(2) *Extension of compliance for early reductions and other reductions.* (i) *Early reductions.* Pursuant to section 112(i)(5) of the Act, if the owner or operator of an existing source demonstrates that the source has achieved a reduction in emissions of hazardous air pollutants in accordance with the provisions of subpart D of this part, the Administrator will grant the owner or operator an extension of compliance with specific requirements of this part, as specified in subpart D of this part.

(ii) *Other reductions.* Pursuant to section 112(i)(6) of the Act, if the owner or operator of an existing source has installed best available control technology (BACT) (as defined in section 169(3) of the Act) or technology required to meet a lowest achievable emission rate (LAER) (as defined in section 171 of the Act) prior to the promulgation of an emission standard in this part applicable to such source and the same pollutant (or stream of pollutants) controlled pursuant to the BACT or LAER installation, the Administrator will grant the owner or operator an extension of compliance with such emission standard that will apply until the date 5 years after the date on which such installation was achieved, as determined by the Administrator.

(3) *Request for extension of compliance.* Paragraphs (a)(4) through (7) of this section concern requests for an extension of compliance with a relevant standard under this part (except requests for an extension of compliance under paragraph (a)(2)(i) of this section will be handled through procedures specified in subpart D of this part).

(4) *Requests for extensions of compliance for section 112 standards.* (i) *Section 112(d) standards.* (A) The owner or operator of an existing source who is unable to comply with a relevant standard established under this part pursuant to section 112(d) of the Act may request that the Administrator grant an extension allowing the source up to 1 additional year to comply with the standard, if such additional period is necessary for the installation of controls. The owner or operator of an affected source who has requested an extension of compliance under this paragraph and who is otherwise required to obtain a title V permit

shall apply for such permit or apply to have the source's title V permit revised to incorporate the conditions of the extension of compliance. The conditions of an extension of compliance granted under this paragraph will be incorporated into the affected source's title V permit according to the provisions of part 70 or Federal title V regulations in this chapter (42 U.S.C. 7661), whichever are applicable.

(B) Any request under this paragraph for an extension of compliance with a relevant standard shall be submitted in writing to the appropriate authority not later than 12 months before the affected source's compliance date (as specified in §63.1102) for sources that are not including emission points in an emissions average, or not later than 18 months before the affected source's compliance date (as specified in §63.1102) for sources that are including emission points in an emissions average. Emission standards established under this part may specify alternative dates for the submittal of requests for an extension of compliance if alternatives are appropriate for the source categories affected by those standards, e.g., a compliance date specified by the standard is less than 12 (or 18) months after the standard's effective date.

(ii) *Section 112(f) standards.* The owner or operator of an existing source unable to comply with a relevant standard established under this part pursuant to section 112(f) of the Act may request that the Administrator grant an extension allowing the source up to 2 years after the standard's effective date to comply with the standard. The Administrator may grant such an extension if he/she finds that such additional period is necessary for the installation of controls and that steps will be taken during the period of the extension to assure that the health of persons will be protected from imminent endangerment. Any request for an extension of compliance with a relevant standard under this paragraph shall be submitted in writing to the Administrator not later than 15 days after the effective date of the relevant standard.

(5) *Requests for extensions of compliance for BACT or LAER.* The owner or operator of an existing source who has installed BACT or technology required to meet LAER (as specified in paragraph (a)(2)(ii) of this section) prior to the promulgation of a relevant emission standard in this part may request that the Administrator grant an extension allowing the source 5 years from the date on which such installation was achieved, as determined by the Administrator, to comply with the standard. Any request for an extension of compliance with a relevant standard under this paragraph shall be submitted in writing to the Administrator not later than 120 days after the promulgation date of the standard. The Administrator may grant such an extension if he or she finds that the installation of BACT or technology to meet LAER controls the same pollutant (or stream of pollutants) that would be controlled at that source by the relevant emission standard.

(6) *Contents of request.* (i) The request for a compliance extension under paragraph (a)(4) of this section shall include the following information:

(A) A description of the controls to be installed to comply with the standard;

(B) A compliance schedule, including the date by which each step toward compliance will be reached. At a minimum, the list of dates shall include:

(1) The date by which contracts for emission control systems or process changes for emission control will be awarded, or the date by which orders will be issued for the purchase of component parts to accomplish emission control or process changes;

(2) The date by which on-site construction, installation of emission control equipment, or a process change is to be initiated;

(3) The date by which on-site construction, installation of emission control equipment, or a process change is to be completed; and

(4) The date by which final compliance is to be achieved.

(C) A description of interim emission control steps, that will be taken during the extension period, including milestones to assure proper operation and maintenance of emission control and process equipment; and

(D) Whether the owner or operator is also requesting an extension of other applicable requirements (e.g., performance testing requirements).

(ii) The request for a compliance extension under paragraph (a)(5) of this section shall include all information needed to demonstrate to the Administrator's satisfaction that the installation of BACT or technology to meet LAER controls the same pollutant (or stream of pollutants) that would be controlled at that source by the relevant emission standard.

(7) *Additional advice.* Advice on requesting an extension of compliance may be obtained from the Administrator.

(8) *Approval of request for extension of compliance.* Paragraphs (a)(9) through (14) of this section concern approval of an extension of compliance requested under paragraphs (a)(4) through (6) of this section.

(9) *General.* Based on the information provided in any request made under paragraphs (a)(4) through (6) of this section, or other information, the Administrator may grant an extension of compliance with an emission standard, as specified in paragraphs (a)(4) and (5) of this section.

(10) *Contents of extension.* The extension will be in writing and will—

(i) Identify each affected source covered by the extension;

(ii) Specify the termination date of the extension;

(iii) Specify the dates by which steps toward compliance are to be taken, if appropriate;

(iv) Specify other applicable requirements to which the compliance extension applies (e.g., performance tests); and

(v)(A) Under paragraph (a)(4) of this section, specify any additional conditions that the Administrator deems necessary to assure installation of the necessary controls and protection of the health of persons during the extension period; or

(B) Under paragraph (a)(5) of this section, specify any additional conditions that the Administrator deems necessary to assure the proper operation and maintenance of the installed controls during the extension period.

(11) *Progress reports.* The owner or operator of an existing source that has been granted an extension of compliance under paragraph (a)(10) of this section may be required to submit to the Administrator progress reports indicating whether the steps toward compliance outlined in the compliance schedule have been reached. The contents of the progress reports and the dates by which they shall be submitted will be specified in the written extension of compliance granted under paragraph (a)(9) of this section.

(12) *Notifications to owners and operators regarding compliance extensions for section 112(d) standards.*

(i) The Administrator will notify the owner or operator in writing of approval or intention to deny approval of a request for an extension of compliance within 30 days after receipt of sufficient information to evaluate a request submitted under paragraph (a)(4)(i) or (a)(5) of this section. The 30-day approval or denial period will begin after the owner or operator has been notified in writing that his/her application is complete. The Administrator will notify the owner or operator in writing of the status of his/her application, that is, whether the application contains sufficient information to make a determination, within 30 days after receipt of the original application and within 30 days after receipt of any supplementary information that is submitted.

(ii) When notifying the owner or operator that his/her application is not complete, the Administrator will specify the information needed to complete the application and provide notice of opportunity for the applicant to present, in writing, within 30 days after he/she is notified of the incomplete application, additional information or arguments to the Administrator to enable further action on the application.

(iii) Before denying any request for an extension of compliance, the Administrator will notify the owner or operator in writing of the Administrator's intention to issue the denial, together with—

(A) Notice of the information and findings on which the intended denial is based; and

(B) Notice of opportunity for the owner or operator to present in writing, within 15 days after he/she is notified of the intended denial, additional information or arguments to the Administrator before further action on the request.

(iv) The Administrator's final determination to deny any request for an extension will be in writing and will set forth the specific grounds on which the denial is based. The final determination will be made within 30 days after presentation of additional information or argument (if the application is complete), or within 30 days after the final date specified for the presentation if no presentation is made.

(13) *Notifications to owners and operators regarding compliance extensions for section 112(f) standards.*

(i) The Administrator will notify the owner or operator in writing of approval or intention to deny approval of a request for an extension of compliance within 30 days after receipt of sufficient information to evaluate a request submitted under paragraph (a)(4)(ii) of this section. The 30-day approval or denial period will begin after the owner or operator has been notified in writing that his/her application is complete. The Administrator will notify the owner or operator in writing of the status of his/her application, that is, whether the application contains sufficient information to make a determination, within 15 days after receipt of the original application and within 15 days after receipt of any supplementary information that is submitted.

(ii) When notifying the owner or operator that his/her application is not complete, the Administrator will specify the information needed to complete the application and provide notice of opportunity for the

applicant to present, in writing, within 15 days after he/she is notified of the incomplete application, additional information or arguments to the Administrator to enable further action on the application.

(iii) Before denying any request for an extension of compliance, the Administrator will notify the owner or operator in writing of the Administrator's intention to issue the denial, together with—

(A) Notice of the information and findings on which the intended denial is based; and

(B) Notice of opportunity for the owner or operator to present in writing, within 15 days after he/she is notified of the intended denial, additional information or arguments to the Administrator before further action on the request.

(iv) A final determination to deny any request for an extension will be in writing and will set forth the specific grounds on which the denial is based. The final determination will be made within 30 days after presentation of additional information or argument (if the application is complete), or within 30 days after the final date specified for the presentation if no presentation is made.

(14) *Termination of extension.* The Administrator may terminate an extension of compliance at an earlier date than specified if any specification under paragraphs (a)(10)(iii) or (iv) of this section is not met.

(15) [Reserved]

(16) *Administrator's authority.* The granting of an extension under this section shall not abrogate the Administrator's authority under section 114 of the Act.

(b) *Waiver of performance tests—(1) Applicability of this section.* Until a waiver of a performance testing requirement has been granted by the Administrator under this paragraph, the owner or operator of an affected source remains subject to the requirements of this section.

(2) *General.* Individual performance tests may be waived upon written application to the Administrator if, in the Administrator's judgment, the source is meeting the relevant standard(s) on a continuous basis, or the source is being operated under an extension of compliance, or the owner or operator has requested an extension of compliance and the Administrator is still considering that request.

(3) *Request to waive a performance test.* (i) If a request is made for an extension of compliance under paragraph (a) of this section, the application for a waiver of an initial performance test shall accompany the information required for the request for an extension of compliance. If no extension of compliance is requested or if the owner or operator has requested an extension of compliance and the Administrator is still considering that request, the application for a waiver of an initial performance test shall be submitted at least 60 days before the performance test if a site-specific test plan is not submitted.

(ii) If an application for a waiver of a subsequent performance test is made, the application may accompany any required compliance progress report, compliance status report, or excess emissions and continuous monitoring system performance report, but it shall be submitted at least 60 days before the performance test if a site-specific test plan is not submitted.

(iii) Any application for a waiver of a performance test shall include information justifying the owner or operator's request for a waiver, such as the technical or economic infeasibility, or the impracticality, of the affected source performing the required test.

(4) *Approval of request to waive performance test.* The Administrator will approve or deny a request for a waiver of a performance test made under paragraph (b)(3) of this section when he/she—

(i) Approves or denies an extension of compliance under paragraph (a) of this section; or

(ii) Approves or disapproves a site-specific test plan; or

(iii) Makes a determination of compliance following the submission of a required compliance status report or excess emissions and continuous monitoring systems performance report; or

(iv) Makes a determination of suitable progress towards compliance following the submission of a compliance progress report, whichever is applicable.

(5) *Administrator's authority.* Approval of any waiver granted under this section shall not abrogate the Administrator's authority under the Act or in any way prohibit the Administrator from later canceling the waiver. The cancellation will be made only after notice is given to the owner or operator of the affected source.

(c) *Use of an alternative monitoring method—(1) General.* Until permission to use an alternative monitoring method has been granted by the Administrator under this paragraph, the owner or operator of an affected source remains subject to the requirements of this section and the relevant standard.

(2) *Alternatives to monitoring methods.* After receipt and consideration of written application, the Administrator may approve alternatives to any monitoring methods or procedures of this part including, but not limited to, the following:

(i) Alternative monitoring requirements when installation of a CMS specified by a relevant standard would not provide accurate measurements due to liquid water or other interferences caused by substances within the effluent gases;

(ii) Alternative monitoring requirements when the affected source is infrequently operated;

(iii) Alternative monitoring requirements to accommodate CEMS that require additional measurements to correct for stack moisture conditions;

(iv) Alternative locations for installing CMS when the owner or operator can demonstrate that installation at alternate locations will enable accurate and representative measurements;

(v) Alternate methods for converting pollutant concentration measurements to units of the relevant standard;

(vi) Alternate procedures for performing daily checks of zero (low-level) and high-level drift that do not involve use of high-level gases or test cells;

(vii) Alternatives to the American Society for Testing and Materials (ASTM) test methods or sampling procedures specified by any relevant standard;

(viii) Alternative CMS that do not meet the design or performance requirements in this part, but adequately demonstrate a definite and consistent relationship between their measurements and the measurements of opacity by a system complying with the requirements as specified in the relevant standard. The Administrator may require that such demonstration be performed for each affected source; or

(ix) Alternative monitoring requirements when the effluent from a single affected source or the combined effluent from two or more affected sources is released to the atmosphere through more than one point.

(3) *Conflicts between alternative and required methods.* If the Administrator finds reasonable grounds to dispute the results obtained by an alternative monitoring method, requirement, or procedure, the Administrator may require the use of a method, requirement, or procedure specified in this section or in the relevant standard. If the results of the specified and alternative method, requirement, or procedure do not agree, the results obtained by the specified method, requirement, or procedure shall prevail.

(4)(i) *Request to use alternative monitoring method.* An owner or operator who wishes to use an alternative monitoring method shall submit an application to the Administrator as described in paragraph (c)(4)(ii) of this section. The application may be submitted at any time provided that the monitoring method is not used to demonstrate compliance with a relevant standard or other requirement. If the alternative monitoring method is to be used to demonstrate compliance with a relevant standard, the application shall be submitted not later than with the site-specific test plan required, or with the site-specific performance evaluation plan (if requested), or at least 60 days before the performance evaluation is scheduled to begin.

(ii) The application shall contain a description of the proposed alternative monitoring system and a performance evaluation test plan, if required. In addition, the application shall include information justifying the owner or operator's request for an alternative monitoring method, such as the technical or economic infeasibility, or the impracticality, of the affected source using the required method.

(iii) The owner or operator may submit the information required in this paragraph well in advance of the submittal dates specified in paragraph (c)(4)(i) of this section to ensure a timely review by the Administrator in order to meet the compliance demonstration date specified in this section or the relevant standard.

(5) *Approval of request to use alternative monitoring method.* (i) The Administrator will notify the owner or operator of approval or intention to deny approval of the request to use an alternative monitoring method within 30 days after receipt of the original request and within 30 days after receipt of any supplementary information that is submitted. Before disapproving any request to use an alternative monitoring method, the Administrator will notify the applicant of the Administrator's intention to disapprove the request together with—

(A) Notice of the information and findings on which the intended disapproval is based; and



(B) Notice of opportunity for the owner or operator to present additional information to the Administrator before final action on the request. At the time the Administrator notifies the applicant of his or her intention to disapprove the request, the Administrator will specify how much time the owner or operator will have after being notified of the intended disapproval to submit the additional information.

(ii) The Administrator may establish general procedures and criteria in a relevant standard to accomplish the requirements of paragraph (c)(5)(i) of this section.

(iii) If the Administrator approves the use of an alternative monitoring method for an affected source under paragraph (c)(5)(i) of this section, the owner or operator of such source shall continue to use the alternative monitoring method until he or she receives approval from the Administrator to use another monitoring method as allowed by this subpart or a subpart referenced by this subpart.

(6) *Alternative to the relative accuracy test.* An alternative to the relative accuracy test for CEMS specified in a relevant standard may be requested as follows:

(i) *Criteria for approval of alternative procedures.* An alternative to the test method for determining relative accuracy is available for affected sources with emission rates demonstrated to be less than 50 percent of the relevant standard. The owner or operator of an affected source may petition the Administrator under paragraph (c)(6)(ii) of this section to substitute the relative accuracy test in section 7 of Performance Specification 2 with the procedures in section 10 if the results of a performance test conducted according to the requirements specified in this subpart or subpart referenced by this subpart demonstrate that the emission rate of the pollutant of interest in the units of the relevant standard is less than 50 percent of the relevant standard. For affected sources subject to emission limitations expressed as control efficiency levels, the owner or operator may petition the Administrator to substitute the relative accuracy test with the procedures in section 10 of Performance Specification 2 if the control device exhaust emission rate is less than 50 percent of the level needed to meet the control efficiency requirement. The alternative procedures do not apply if the CEMS is used continuously to determine compliance with the relevant standard.

(ii) *Petition to use alternative to relative accuracy test.* The petition to use an alternative to the relative accuracy test shall include a detailed description of the procedures to be applied, the location and the procedure for conducting the alternative, the concentration or response levels of the alternative relative accuracy materials, and the other equipment checks included in the alternative procedure(s). The Administrator will review the petition for completeness and applicability. The Administrator's determination to approve an alternative will depend on the intended use of the CEMS data and may require specifications more stringent than in Performance Specification 2.

(iii) *Rescission of approval to use alternative to relative accuracy test.* The Administrator will review the permission to use an alternative to the CEMS relative accuracy test and may rescind such permission if the CEMS data from a successful completion of the alternative relative accuracy procedure indicate that the affected source's emissions are approaching the level of the relevant standard. The criterion for reviewing the permission is that the collection of CEMS data shows that emissions have exceeded 70 percent of the relevant standard for any averaging period, as specified in the relevant standard. For affected sources subject to emission limitations expressed as control efficiency levels, the criterion for reviewing the permission is that the collection of CEMS data shows that exhaust emissions have exceeded

70 percent of the level needed to meet the control efficiency requirement for any averaging period, as specified in the relevant standard. The owner or operator of the affected source shall maintain records and determine the level of emissions relative to the criterion for permission to use an alternative for relative accuracy testing. If this criterion is exceeded, the owner or operator shall notify the Administrator within 10 days of such occurrence and include a description of the nature and cause of the increased emissions. The Administrator will review the notification and may rescind permission to use an alternative and require the owner or operator to conduct a relative accuracy test of the CEMS as specified in section 7 of Performance Specification 2.

(d) *Waiver of recordkeeping or reporting requirements.* (1) Until a waiver of a recordkeeping or reporting requirement has been granted by the Administrator under this paragraph, the owner or operator of an affected source remains subject to the recordkeeping and reporting requirements of this subpart and any subparts referenced by this subpart.

(2) Recordkeeping or reporting requirements may be waived upon written application to the Administrator if, in the Administrator's judgment, the affected source is achieving the relevant standard(s), or the source is operating under an extension of compliance, or the owner or operator has requested an extension of compliance and the Administrator is still considering that request.

(3) If an application for a waiver of recordkeeping or reporting is made, the application shall accompany the request for an extension of compliance under paragraph (a) of this section, any required compliance progress report or compliance status report required under this part or in the source's title V permit, or an excess emissions and continuous monitoring system performance report required under §63.999(c) or another subpart referenced by this subpart, whichever is applicable. The application shall include whatever information the owner or operator considers useful to convince the Administrator that a waiver of recordkeeping or reporting is warranted.

(4) The Administrator will approve or deny a request for a waiver of recordkeeping or reporting requirements under this paragraph when he/she—

(i) Approves or denies an extension of compliance under paragraph (a) of this section; or

(ii) Makes a determination of compliance following the submission of a required Notification of Compliance Status report or excess emissions and continuous monitoring systems performance report; or

(iii) Makes a determination of suitable progress towards compliance following the submission of a compliance progress report, whichever is applicable.

(5) A waiver of any recordkeeping or reporting requirement granted under this paragraph may be conditioned on other recordkeeping or reporting requirements deemed necessary by the Administrator.

(6) Approval of any waiver granted under this section shall not abrogate the Administrator's authority under the Act or in any way prohibit the Administrator from later canceling the waiver. The cancellation will be made only after notice is given to the owner or operator of the affected source.

[↑ Back to Top](#)

### **§63.1113 Procedures for approval of alternative means of emission limitation.**

(a) *Alternative means of emission limitation.* An owner or operator of an affected source may request a determination of alternative means of emission limitation to the requirements of design, equipment, work practice, or operational standards of this subpart or of a subpart referenced by this subpart. If, in the judgment of the Administrator, an alternative means of emission limitation will achieve a reduction in HAP emissions at least equivalent to the reduction in emissions from that source achieved under any design, equipment, work practice, or operational standards (but not performance standards) in this subpart, the Administrator will publish in the Federal Register a notice permitting the use of the alternative means for purposes of compliance with that requirement.

(1) The notice may condition the permission on requirements related to the operation and maintenance of the alternative means.

(2) Any such notice shall be published only after public notice and an opportunity for a hearing.

(b) *Content of submittal.* (1) In order to obtain approval, any person seeking permission to use an alternative means of compliance under this section shall collect, verify, and submit to the Administrator information showing that the alternative means achieves equivalent emission reductions. An owner or operator of an affected source seeking permission to use an alternative means of compliance who has not previously performed testing shall also submit a proposed test plan. If the owner or operator seeks permission to use an alternative means of compliance based on previously performed testing, they shall submit the results of testing, a description of the procedures followed in testing or monitoring, and a description of pertinent conditions during testing or monitoring.

(2) The owner or operator who requests an alternative means of emissions limitation shall submit a description of the proposed testing, monitoring, recordkeeping, and reporting that will be used and the proposed basis for demonstrating compliance.

(3) For storage vessels, the owner or operator shall include the results of actual emissions tests using full-size or scale-model storage vessels that accurately collect and measure all regulated HAP emissions using a given control technique, and that accurately simulate wind and account for other emission variables such as temperature and barometric pressure, or an engineering analysis that the Administrator determines to be an accurate method of determining equivalence.

(4) For proposed alternatives to equipment leak requirements referenced by this subpart, the owner or operator shall also submit the information specified in and meet the requirements for alternate means of emission limitation specified in the referenced subparts.

[↑ Back to Top](#)

### **§63.1114 Implementation and enforcement.**

(a) This subpart can be implemented and enforced by the U.S. Environmental Protection Agency (EPA), or a delegated authority such as the applicable State, local, or tribal agency. If the EPA Administrator has delegated authority to a State, local, or tribal agency, then that agency has the authority to implement and

enforce this subpart. Contact the applicable EPA Regional Office to find out if this subpart is delegated to a State, local, or tribal agency.

(b) In delegating implementation and enforcement authority of this subpart to a State, local, or tribal agency under 40 CFR part 63, subpart E, the authorities contained in paragraphs (b)(1) through (5) of this section are retained by the EPA Administrator and are not transferred to the State, local, or tribal agency.

(1) Approval of alternatives to the nonopacity emissions standards in §63.1103(a)(3), (b)(3) through (5), (c)(3), (d)(3), (e)(3), (f)(3), (g)(3) and (4), and (h)(3) under §63.6(g). Follow the requirements in §63.1113 to request permission to use an alternative means of emission limitation. Where these standards reference another subpart, the cited provisions will be delegated according to the delegation provisions of the referenced subpart.

(2) [Reserved]

(3) Approval of major changes to test methods under §63.7(e)(2)(ii) and (f) and as defined in §63.90.

(4) Approval of major changes to monitoring under §63.8(f) and as defined in §63.90.

(5) Approval of major changes to recordkeeping and reporting under §63.10(f) and as defined in §63.90.

[67 FR 46289, July 12, 2002]

[↑ Back to Top](#)

# **APPENDIX H**

## Electronic Code of Federal Regulations

---

[View past updates to the e-CFR.](#)  
[Click here to learn more.](#)

---

**e-CFR data is current as of January 17, 2017**

[Title 40](#) → [Chapter I](#) → [Subchapter C](#) → [Part 63](#) → [Subpart MMM](#)

---

[Browse Previous](#) | [Browse Next](#)

Title 40: Protection of Environment

[PART 63—NATIONAL EMISSION STANDARDS FOR HAZARDOUS AIR POLLUTANTS FOR SOURCE CATEGORIES \(CONTINUED\)](#)

---

### **Subpart MMM—National Emission Standards for Hazardous Air Pollutants for Pesticide Active Ingredient Production**

---

#### **Contents**

- [§63.1360 Applicability.](#)
  - [§63.1361 Definitions.](#)
  - [§63.1362 Standards.](#)
  - [§63.1363 Standards for equipment leaks.](#)
  - [§63.1364 Compliance dates.](#)
  - [§63.1365 Test methods and initial compliance procedures.](#)
  - [§63.1366 Monitoring and inspection requirements.](#)
  - [§63.1367 Recordkeeping requirements.](#)
  - [§63.1368 Reporting requirements.](#)
  - [§63.1369 Implementation and enforcement.](#)
  - [Table 1 to Subpart MMM of Part 63—General Provisions Applicability to Subpart MMM](#)
  - [Table 2 to Subpart MMM of Part 63—Standards for New and Existing PAI Sources](#)
  - [Table 3 to Subpart MMM of Part 63—Monitoring Requirements for Control Devices](#)
  - [Table 4 to Subpart MMM of Part 63—Control Requirements for Items of Equipment That Meet the Criteria of §63.1362\(k\)](#)
- 

Source: 64 FR 33589, June 23, 1999, unless otherwise noted.

[↑ Back to Top](#)

**§63.1360 Applicability.**

(a) *Definition of affected source.* The affected source subject to this subpart is the facility-wide collection of pesticide active ingredient manufacturing process units (PAI process units) that process, use, or produce HAP, and are located at a plant site that is a major source, as defined in section 112(a) of the CAA. An affected source also includes waste management units, heat exchange systems, and cooling towers that are associated with the PAI process units. Exemptions from an affected source are specified in paragraph (d) of this section.

(b) *New source applicability.* A new affected source subject to this subpart and to which the requirements for new sources apply is defined according to the criteria in paragraph (b)(1) or (2) of this section.

(1) An affected source for which construction or reconstruction commenced after November 10, 1997.

(2) Any dedicated PAI process unit that meets the criteria specified in paragraphs (b)(2)(i) and (ii) of this section.

(i) For which construction, as defined in §63.1361, commenced after November 10, 1997, or reconstruction commenced after September 20, 2002.

(ii) That has the potential to emit 10 tons/yr of any one HAP or 25 tons/yr of combined HAP.

(c) *General provisions.* Table 1 of this subpart specifies the provisions of subpart A of this part that apply to an owner or operator of an affected source subject to this subpart, and clarifies specific provisions in subpart A of this part as necessary for this subpart.

(d) *Exemptions from the requirements of this subpart.* The provisions of this subpart do not apply to:

(1) Research and development facilities;

(2) PAI process units that are subject to subpart F of this part;

(3) Production of ethylene;

(4) Coal tar distillation; and

(5) The following emission points listed:

(i) Storm water from segregated sewers;

(ii) Water from fire-fighting and deluge systems, including testing of such systems;

(iii) Spills;

(iv) Water from safety showers;

(v) Noncontact steam boiler blowdown and condensate;

(vi) Laundry water;

(vii) Vessels storing material that contains no organic HAP or contains organic HAP as impurities only; and

(viii) Equipment, as defined in §63.1363, that is intended to operate in organic HAP service for less than 300 hours during the calendar year.

(e) *Applicability of this subpart.* (1) Each provision set forth in this subpart shall apply at all times except during periods of non-operation of the affected source (or specific portion thereof) resulting in cessation of the emissions to which this subpart applies.

(i) The startup, shutdown, or malfunction precludes the ability of the owner or operator of an affected source to comply with one or more specific emission limitations to which a particular emission point is subject; and

(ii) The owner or operator follows the provisions for periods of startup, shutdown, and malfunction, as specified in §§63.1367(a)(3) and 63.1368(i).

(2) The provisions set forth in §63.1363 shall apply at all times except during periods of nonoperation of the PAI process unit (or specific portion thereof) in which the lines are drained and depressurized resulting in the cessation of the emissions to which §63.1363 applies.

(3) The owner or operator shall not shut down items of equipment that are required or utilized for compliance with the emissions limitations of this subpart during times when emissions (or, where applicable, wastewater streams or residuals) are being routed to such items of equipment, if the shutdown would contravene emissions limitations of this subpart applicable to such items of equipment.

(4) *General duty.* At all times, the owner or operator must operate and maintain any affected source, including associated air pollution control equipment and monitoring equipment, in a manner consistent with safety and good air pollution control practices for minimizing emissions. The general duty to minimize emissions does not require the owner or operator to make any further efforts to reduce emissions if levels required by the applicable standard have been achieved. Determination of whether a source is operating in compliance with operation and maintenance requirements will be based on information available to the Administrator, which may include, but is not limited to, monitoring results, review of operation and maintenance procedures, review of operation and maintenance records, and inspection of the source.

(f) *Storage vessel applicability determination.* An owner or operator shall follow the procedures specified in paragraphs (f)(1) through (5) of this section to determine whether a storage vessel is part of the affected source to which this subpart applies.

(1) If a storage vessel is already subject to another subpart of 40 CFR part 63 on June 23, 1999, the storage vessel shall belong to the process unit subject to the other subpart.

(2) Unless otherwise excluded under paragraph (f)(1) of this section, the storage vessel is part of a PAI process unit if either the input to the vessel from the PAI process unit is greater than or equal to the input from any other PAI or non-PAI process unit, or the output from the vessel to the PAI process unit is greater than or equal to the output to any other PAI or non-PAI process unit. If the greatest input to and/or



output from a shared storage vessel is the same for two or more process units, including one or more PAI process units, the owner or operator must assign the storage vessel to any one of the PAI process units that meet this condition.

(3) Unless otherwise excluded under paragraph (f)(1) of this section, where a storage vessel is located in a tank farm (including a marine tank farm), the applicability of this subpart shall be determined according to the provisions in paragraphs (f)(3)(i) through (iii) of this section.

(i) The storage vessel in the tank farm is not subject to the provisions of this subpart if the greatest input to or output from the storage vessel is for a non-PAI process unit. The input and output shall be determined among only those process units that share the storage vessel and that do not have an intervening storage vessel for that product (or raw material, as appropriate).

(ii) Except for storage vessels in a tank farm excluded in accordance with paragraph (f)(3)(i) of this section, applicability of this subpart shall be determined according to the provisions in paragraphs (f)(3)(ii)(A) through (C) of this section.

(A) Except as specified in paragraph (f)(3)(ii)(C) of this section, this subpart does not apply to the storage vessel in a tank farm if each PAI process unit that receives material from or sends material to the storage vessel has an intervening storage vessel for that material.

(B) Except as specified in paragraph (f)(3)(ii)(C) of this section, a storage vessel in a tank farm shall be assigned to the PAI process unit that receives the greatest amount of material from or sends the greatest amount of material to the storage vessel and does not have an intervening storage vessel. If two or more PAI process units have the same input to or output from the storage vessel in the tank farm, then the storage vessel in the tank farm may be assigned to any one of the PAI process units that meet this condition.

(C) As an alternative to the requirements specified in paragraphs (f)(3)(ii)(A) and (B) of this section, even if an intervening storage vessel is present, an owner or operator may elect to assign a storage vessel in a tank farm to the PAI process unit that sends the most material to or receives the most material from the storage vessel. If two or more PAI process units have the same input to or output from the storage vessel in the tank farm, then the storage vessel in the tank farm may be assigned to any one of the PAI process units that meet this condition.

(iii) With respect to a process unit, an intervening storage vessel means a storage vessel connected by hard-piping to the process unit and to the storage vessel in the tank farm so that the product or raw material entering or leaving the process flows into (or from) the intervening storage vessel and does not flow directly into (or from) the storage vessel in the tank farm.

(4) If use varies from year to year, then use for the purposes of this subpart for existing sources shall be based on the utilization that occurred during the year preceding June 23, 1999, or if the storage vessel was not in operation during that year, the use shall be based on the expected use in the 5 years after startup. This determination shall be reported as part of an operating permit application or as otherwise specified by the permitting authority.

(5) If the storage vessel begins receiving material from (or sending material to) another process unit, or ceasing to receive material from (or send material to) a PAI process unit, or if there is a significant change in the use of the storage vessel, the owner or operator shall reevaluate the ownership determination for the storage vessel.

(g) *Designating production of an intermediate as a PAI process unit.* Except as specified in paragraph (d) of this section, an owner or operator may elect to designate production of any intermediate that does not meet the definition of integral intermediate as a PAI process unit subject to this subpart. Any storage vessel containing the intermediate is assigned to a PAI process unit according to the procedures in paragraph (f) of this section. Any process tank containing the intermediate is part of the process unit used to produce the intermediate.

(h) *Applicability of process units included in a process unit group.* An owner or operator may elect to develop process unit groups in accordance with paragraph (h)(1) of this section. For the PAI process units in these process unit groups, the owner or operator may comply with the provisions in overlapping MACT standards, as specified in paragraphs (h)(2) through (4) of this section, as an alternative means of demonstrating compliance with the provisions of this subpart.

(1) Develop, revise, and document changes in a process unit group in accordance with the procedures specified in paragraphs (h)(1)(i) through (vi) of this section.

(i) Initially identify a non-dedicated PAI process unit that is operating on December 23, 2003 or a date after December 23, 2003, and identify all processing equipment that is part of this PAI process unit, based on descriptions in operating scenarios.

(ii) Add to the group any other non-dedicated PAI and non-dedicated non-PAI process units expected to be operated in the 5 years after the date specified in paragraph (h)(1)(i) of this section, provided they satisfy the criteria specified in paragraphs (h)(1)(ii)(A) through (C) of this section. Also identify all of the processing equipment used for each process unit based on information from operating scenarios and other applicable documentation.

(A) Each PAI process unit that is added to a group must have some processing equipment that is part of one or more PAI process units that are already in the process unit group.

(B) Each non-PAI process unit that is added to a group must have some processing equipment that is also part of one or more of the PAI process units in the group.

(C) No process unit may be part of more than one process unit group.

(iii) The initial process unit group consists of all of the processing equipment for the process units identified in paragraphs (h)(1)(i) and (ii) of this section.

(iv) If compliance is to be demonstrated in accordance with paragraph (h)(3) of this section, determine the primary product of the process unit group according to the procedures specified in paragraphs (h)(1)(iv)(A) through (C) of this section.

(A) The primary product is the type of product (e.g., PAI, pharmaceutical product, thermoplastic resin, etc.) that is expected to be produced for the greatest operating time in the 5-year period specified in paragraph (h)(1)(i) of this section.

(B) If the process unit group produces multiple products equally based on operating time, then the primary product is the product with the greatest production on a mass basis over the 5-year period specified in paragraph (h)(1)(i) of this section.

(C) The primary product of the group must be redetermined if the owner or operator does not intend to make that product in the future or if it has not been made for 5 years. The results of the redetermination must be recorded as specified in §63.1367(b) and reported in a Periodic report no later than the report covering the period for the end of the 5th year as specified in §63.1368(g)(2). If the primary product changes, the owner or operator must either demonstrate compliance with the applicable subpart as specified in paragraph (h)(3) of this section or demonstrate compliance with the provisions of this subpart MMM.

(v) Add process units developed in the future in accordance with the conditions specified in paragraphs (h)(1)(ii)(A) through (C) of this section.

(vi) Maintain records of changes in the process units in each process unit group as specified in §63.1367(b)(9), and maintain reports as specified in §63.1368(f)(9) and (g)(2)(ix).

(2) If any of the products produced in the process unit group are subject to 40 CFR part 63, subpart GGG (Pharmaceuticals MACT), the owner or operator may elect to comply with the requirements of subpart GGG for the PAI process unit(s) within the process unit group, except for the following:

(i) The emission limit standard for process vents in §63.1362(b)(2)(i) shall apply in place of §63.1254(a)(2);

(ii) When the dates of April 2, 1997 and April 2, 2007 are provided in §63.1254(a)(3)(ii), the dates of November 10, 1997 and November 10, 2007, respectively, shall apply for purposes of this subpart MMM; and

(iii) Requirements in §63.1367(a)(5) regarding application for approval of construction or reconstruction shall apply in place of the provisions in §63.1259(a)(5).

(3) If the primary product of a process unit group is determined to be a type of material that is subject to another subpart of 40 CFR part 63 on June 23, 1999 or startup of the first process unit after formation of the process unit group, whichever is later, the owner or operator may elect to comply with the other subpart for any PAI process unit within the process unit group, subject to the requirement in this paragraph (h)(3). Emissions from PAI Group 1 process vents, as defined in §63.1361, must be reduced in accordance with the control requirements for Group 1 vents as specified in the alternative subpart. The criteria in the alternative subpart for determining which process vents must be controlled do not apply for the purposes of this paragraph (h)(3).

(4) The requirements for new and reconstructed sources in the alternative subpart apply to all PAI process units in the process unit group if, and only if, the affected source under the alternative subpart meets the requirements for construction or reconstruction.

(i) *Overlap with other regulations—(1) Compliance with other MACT standards.* (i) After the compliance dates specified in §63.1364, an affected source subject to the provisions of this subpart that is also subject to the provisions of any other subpart of 40 CFR part 63 may elect, to the extent the subparts are consistent, under which subpart to maintain records and report to EPA. The affected source shall identify in the Notification of Compliance Status report required by §63.1368(f) under which authority such records will be maintained.

(ii) After the compliance dates specified in §63.1364, at an offsite reloading or cleaning facility subject to §63.1362(b)(6), compliance with the emission standards and associated initial compliance monitoring, recordkeeping, and reporting provisions of any other subpart of 40 CFR part 63 constitutes compliance with the provisions of §63.1362(b)(6)(vii)(B) or (C). The owner or operator of the affected storage vessel shall identify in the Notification of Compliance Status report required by §63.1368(f) the subpart of 40 CFR part 63 with which the owner or operator of the offsite reloading or cleaning facility complies.

(2) *Overlap with RCRA subparts AA, BB, and/or CC.* After the compliance dates specified in §63.1364, if any affected source subject to this subpart is also subject to monitoring, recordkeeping, and reporting requirements in 40 CFR part 264, subpart AA, BB, or CC, or is subject to monitoring and recordkeeping requirements in 40 CFR part 265, subpart AA, BB, or CC, and the owner or operator complies with the periodic reporting requirements under 40 CFR part 264, subpart AA, BB, or CC that would apply to the device if the facility had final-permitted status, the owner or operator may elect to comply either with the monitoring, recordkeeping, and reporting requirements of this subpart, or with the monitoring, recordkeeping, and reporting requirements in 40 CFR parts 264 and/or 265, as described in this paragraph, which shall constitute compliance with the monitoring, recordkeeping, and reporting requirements of this subpart. If the owner or operator elects to comply with the monitoring, recordkeeping, and reporting requirements in 40 CFR parts 264 and/or 265, the owner or operator shall report all excursions as required by §63.1368(g). The owner or operator shall identify in the Notification of Compliance Status report required by §63.1368(f) the monitoring, recordkeeping, and reporting authority under which the owner or operator will comply.

(3) *Overlap with NSPS subpart Kb.* After the compliance dates specified in §63.1364, a Group 1 or Group 2 storage vessel that is also subject to the provisions of 40 CFR part 60, subpart Kb, is required to comply only with the provisions of this subpart MMM.

(4) *Overlap with subpart I.* After the compliance dates specified in §63.1364, for all equipment within a process unit that contains equipment subject to subpart I of this part, an owner or operator may elect to comply with either the provisions of this subpart MMM or the provisions of subpart H of this part. The owner or operator shall identify in the Notification of Compliance Status report required by §63.1368(f) the provisions with which the owner or operator elects to comply.

(5) *Overlap with RCRA regulations for wastewater.* After the compliance dates specified in §63.1364, the owner or operator of an affected wastewater stream that is also subject to provisions in 40 CFR parts 260 through 272 shall comply with the more stringent control requirements (e.g., waste management units,

numerical treatment standards, etc.) and the more stringent testing, monitoring, recordkeeping, and reporting requirements that overlap between the provisions of this subpart and the provisions of 40 CFR parts 260 through 272. The owner or operator shall keep a record of the information used to determine which requirements were the most stringent and shall submit this information if requested by the Administrator.

(6) *Overlap with NSPS subparts III, NNN, and RRR.* After the compliance dates specified in §63.1364, if an owner or operator of a process vent subject to this subpart MMM that is also subject to the provisions of 40 CFR part 60, subpart III, or subpart NNN, or subpart RRR, elects to reduce organic HAP emissions from the process vent by 98 percent as specified in §63.1362(b)(2)(iii)(A), then the owner or operator is required to comply only with the provisions of this subpart MMM. Otherwise, the owner or operator shall comply with the provisions in both this subpart MMM and the provisions in 40 CFR part 60, subparts III, NNN, and RRR, as applicable.

(j) *Meaning of periods of time.* All terms in this subpart MMM that define a period of time for completion of required tasks (e.g., weekly, monthly, quarterly, annual), unless specified otherwise in the section or subsection that imposes the requirement, refer to the standard calendar periods.

(1) Notwithstanding time periods specified in the subpart MMM for completion of required tasks, such time periods may be changed by mutual agreement between the owner and operator and the Administrator, as specified in subpart A of this part (e.g., a period could begin on the compliance date or another date, rather than on the first day of the standard period). For each time period that is changed by agreement, the revised period shall remain in effect until it is changed. A new request is not necessary for each recurring period.

(2) Where the period specified for compliance is a standard calendar period, if the initial compliance date occurs after the beginning of the period, compliance shall be required according to the schedule specified in paragraph (j)(2)(i) or (ii) of this section, as appropriate.

(i) Compliance shall be required before the end of the standard calendar period within which the compliance deadline occurs, if there remain at least 3 days for tasks that must be performed weekly, at least 2 weeks for tasks that must be performed monthly, at least 1 month for tasks that must be performed each quarter, or at least 3 months for tasks that must be performed annually; or

(ii) In all other cases, compliance shall be required before the end of the first full standard calendar period within which the initial compliance deadline occurs.

(3) In all instances where a provision of this subpart MMM requires completion of a task during each of multiple successive periods, an owner or operator may perform the required task at any time during the specified period, provided the task is conducted at a reasonable interval after completion of the task in the previous period.

(k) *Affirmative defense for violation of emission standards during malfunction.* In response to an action to enforce the standards set forth in this subpart, the owner or operator may assert an affirmative defense to a claim for civil penalties for violations of such standards that are caused by malfunction, as defined at §63.2. Appropriate penalties may be assessed if the owner or operator fails to meet their burden of

proving all of the requirements in the affirmative defense. The affirmative defense shall not be available for claims for injunctive relief.

(1) *Assertion of affirmative defense.* To establish the affirmative defense in any action to enforce such a standard, the owner or operator must timely meet the reporting requirements in paragraph (k)(2) of this section, and must prove by a preponderance of evidence that:

(i) The violation:

(A) Was caused by a sudden, infrequent, and unavoidable failure of air pollution control equipment, process equipment, or a process to operate in a normal or usual manner; and

(B) Could not have been prevented through careful planning, proper design or better operation and maintenance practices; and

(C) Did not stem from any activity or event that could have been foreseen and avoided, or planned for; and

(D) Was not part of a recurring pattern indicative of inadequate design, operation, or maintenance; and

(ii) Repairs were made as expeditiously as possible when a violation occurred; and

(iii) The frequency, amount, and duration of the violation (including any bypass) were minimized to the maximum extent practicable; and

(iv) If the violation resulted from a bypass of control equipment or a process, then the bypass was unavoidable to prevent loss of life, personal injury, or severe property damage; and

(v) All possible steps were taken to minimize the impact of the violation on ambient air quality, the environment, and human health; and

(vi) All emissions monitoring and control systems were kept in operation if at all possible, consistent with safety and good air pollution control practices; and

(vii) All of the actions in response to the violation were documented by properly signed, contemporaneous operating logs; and

(viii) At all times, the affected source was operated in a manner consistent with good practices for minimizing emissions; and

(ix) A written root cause analysis has been prepared, the purpose of which is to determine, correct, and eliminate the primary causes of the malfunction and the violation resulting from the malfunction event at issue. The analysis shall also specify, using best monitoring methods and engineering judgment, the amount of any emissions that were the result of the malfunction.

(2) *Report.* The owner or operator seeking to assert an affirmative defense shall submit a written report to the Administrator, with all necessary supporting documentation, that explains how it has met the requirements set forth in paragraph (k)(1) of this section. This affirmative defense report shall be included in the first periodic compliance report, deviation report, or excess emission report otherwise required after

the initial occurrence of the violation of the relevant standard (which may be the end of any applicable averaging period). If such compliance, deviation report or excess emission report is due less than 45 days after the initial occurrence of the violation, the affirmative defense report may be included in the second compliance, deviation report or excess emission report due after the initial occurrence of the violation of the relevant standard.

[64 FR 33589, June 23, 1999, as amended at 67 FR 59340, Sept. 20, 2002; 79 FR 17371, Mar. 27, 2014]

[↑ Back to Top](#)

### **§63.1361 Definitions.**

Terms used in this subpart are defined in the CAA, in subpart A of this part, or in this section. If the same term is defined in subpart A of this part and in this section, it shall have the meaning given in this section for the purposes of this subpart MMM.

*Affirmative defense* means, in the context of an enforcement proceeding, a response or defense put forward by a defendant, regarding which the defendant has the burden of proof, and the merits of which are independently and objectively evaluated in a judicial or administrative proceeding.

*Air pollution control device or control device* means equipment installed on a process vent, storage vessel, wastewater treatment exhaust stack, or combination thereof that reduces the mass of HAP emitted to the air. The equipment may consist of an individual device or a series of devices. Examples include incinerators, carbon adsorption units, condensers, flares, boilers, process heaters, and gas absorbers. Process condensers are not considered air pollution control devices or control devices.

*Bag dump* means equipment into which bags or other containers containing a powdered, granular, or other solid feedstock material are emptied. A bag dump is part of the process.

*Batch emission episode* means a discrete venting episode that is associated with a single unit operation. A unit operation may have more than one batch emission episode. For example, a batch distillation unit operation may consist of batch emission episodes associated with charging and heating. Charging the vessel with HAP will result in one discrete batch emission episode that will last through the duration of the charge and will have an average flowrate equal to the rate of the charge. Another discrete batch emission episode will result from the expulsion of expanded vapor as the contents of the vessel are heated.

*Batch operation* means a noncontinuous operation involving intermittent or discontinuous feed into PAI or integral intermediate manufacturing equipment, and, in general, involves the emptying of the equipment after the batch operation ceases and prior to beginning a new operation. Addition of raw material and withdrawal of product do not occur simultaneously in a batch operation. A batch process consists of a series of batch operations.

*Bench-scale batch process* means a batch process (other than a research and development facility) that is capable of being located on a laboratory bench top. This bench-scale equipment will typically include reagent feed vessels, a small reactor and associated product separator, recovery and holding equipment. These processes are only capable of producing small quantities of product.

*Block* means a time period equal to, at a maximum, the duration of a single batch.

*Car seal* means a seal that is placed on a device that is used to change the position of a valve (e.g., from opened to closed) in such a way that the position of the valve cannot be changed without breaking the seal.

*Cleaning operation* means routine rinsing, washing, or boil-off of equipment in batch operations between batches.

*Closed-loop system* means an enclosed system that returns process fluid to the process and is not vented to the atmosphere except through a closed-vent system.

*Closed-purge system* means a system or combination of system and portable containers, to capture purged liquids. Containers must be covered or closed when not being filled or emptied.

*Closed-vent system* means a system that is not open to the atmosphere and is composed of piping, ductwork, connections, and, if necessary, flow inducing devices that transport gas or vapor from an emission point to a control device.

*Combustion device* means an individual unit of equipment, such as a flare, incinerator, process heater, or boiler, used for the combustion of organic HAP vapors.

*Connector* means flanged, screwed, or other joined fittings used to connect two pipe lines or a pipe line and a piece of equipment. A common connector is a flange. Joined fittings welded completely around the circumference of the interface are not considered connectors for the purpose of this regulation. For the purpose of reporting and record keeping, connector means joined fittings that are not inaccessible, ceramic, or ceramic-lined as described in §63.1255(b)(1)(vii) and 63.1255(f)(3).

*Construction* means the onsite fabrication, erection, or installation of an affected source or dedicated PAI process unit. Addition of new equipment to an affected source does not constitute construction, provided the new equipment is not a dedicated PAI process unit with the potential to emit 10 tons/yr of any one HAP or 25 tons/yr of combined HAP, but it may constitute reconstruction of the affected source or PAI process unit if it satisfies the definition of reconstruction in this section. At an affected source, changing raw materials processed and reconfiguring non-dedicated equipment to create a non-dedicated PAI process unit do not constitute construction.

*Consumption* means the quantity of all HAP raw materials entering a process in excess of the theoretical amount used as reactant, assuming 100 percent stoichiometric conversion. The raw materials include reactants, solvents, and any other additives. If HAP are generated in the process as well as added as raw material, consumption includes the quantity generated in the process.

*Container*, as used in the wastewater provisions, means any portable waste management unit that has a capacity greater than or equal to 0.1 m<sup>3</sup> in which a material is stored, transported, treated, or otherwise handled. Examples of containers are drums, barrels, tank trucks, barges, dumpsters, tank cars, dump trucks, and ships.

*Continuous process* means a process where the inputs and outputs flow continuously throughout the duration of the process. Continuous processes typically approach steady state.



*Continuous seal* means a seal that forms a continuous closure that completely covers the space between the wall of the storage vessel and the edge of the floating roof. A continuous seal may be a vapor-mounted, liquid-mounted, or metallic shoe seal.

*Controlled HAP emissions* means the quantity of HAP components discharged to the atmosphere from an air pollution control device.

*Cover*, as used in the wastewater provisions, means a device or system which is placed on or over a waste management unit containing wastewater or residuals so that the entire surface area is enclosed to minimize air emissions. A cover may have openings necessary for operation, inspection, and maintenance of the waste management unit such as access hatches, sampling ports, and gauge wells provided that each opening is closed when not in use. Examples of covers include a fixed roof installed on a wastewater tank, a lid installed on a container, and an air-supported enclosure installed over a waste management unit.

*Dedicated PAI process unit* means a PAI process unit constructed from equipment that is fixed in place and designed and operated to produce only a single product or co-products. The equipment is not designed to be reconfigured to create different process units, and it is not operated with different raw materials so as to produce different products.

*Double block and bleed system* means two block valves connected in series with a bleed valve or line that can vent the line between the two block valves.

*Duct work* means a conveyance system such as those commonly used for heating and ventilation systems. It is often made of sheet metal and often has sections connected by screws or crimping. Hard-piping is not ductwork.

*Equipment*, for purposes of §63.1363, means each pump, compressor, agitator, pressure relief device, sampling connection system, open-ended valve or line, valve, connector, and instrumentation system in organic hazardous air pollutant service.

*External floating roof* means a pontoon-type or double-deck type cover that rests on the liquid surface in a storage tank or waste management unit with no fixed roof.

*FIFRA* means the Federal Insecticide, Fungicide, and Rodenticide Act.

*Fill or filling* means the introduction of organic HAP into a storage tank or the introduction of a wastewater stream or residual into a waste management unit, but not necessarily to complete capacity.

*First attempt at repair* means to take action for the purpose of stopping or reducing leakage of organic material to the atmosphere.

*Fixed roof* means a cover that is mounted on a waste management unit or storage tank in a stationary manner and that does not move with fluctuations in liquid level.

*Flame ionization detector (FID)* means a device in which the measured change in conductivity of a standard flame (usually hydrogen) due to the insertion of another gas or vapor is used to detect the gas or vapor.

*Floating roof* means a cover consisting of a double deck, pontoon single deck, internal floating cover or covered floating roof, which rests upon and is supported by the liquid being contained, and is equipped with a continuous seal or seals to close the space between the roof edge and waste management unit or storage vessel wall.

*Flow indicator* means a device that indicates whether gas flow is, or whether the valve position would allow gas flow to be, present in a line.

*Formulation of pesticide products* means the mixing, blending, or diluting of a PAI with one or more other PAI or inert ingredients.

*Group 1 process vent* means any process vent from a process at an existing or new affected source for which the uncontrolled organic HAP emissions from the sum of all process vents are greater than or equal to 0.15 Mg/yr and/or the uncontrolled hydrogen chloride (HCl) and chlorine emissions from the sum of all process vents are greater than or equal to 6.8 Mg/yr.

*Group 1 storage vessel* means a storage vessel at an existing affected source with a capacity equal to or greater than 75 m<sup>3</sup> and storing material with a maximum true vapor pressure greater than or equal to 3.45 kPa, a storage vessel at a new affected source with a capacity equal to or greater than 40 m<sup>3</sup> and storing material with a maximum true vapor pressure greater than or equal to 16.5 kPa, or a storage vessel at a new affected source with a capacity greater than or equal to 75 m<sup>3</sup> and storing material with a maximum true vapor pressure greater than or equal to 3.45 kPa.

*Group 1 wastewater stream* means process wastewater at an existing or new source that meets the criteria for Group 1 status in §63.132(c) for compounds in Table 9 of subpart G of this part or a maintenance wastewater stream that contains 5.3 Mg of compounds in Table 9 of subpart G of this part per discharge event.

*Group 2 process vent* means any process vent that does not meet the definition of a Group 1 process vent.

*Group 2 storage vessel* means a storage vessel that does not meet the definition of a Group 1 storage vessel.

*Group 2 wastewater stream* means any wastewater stream that does not meet the definition of a Group 1 wastewater stream.

*Group of processes* means all of the equipment associated with processes in a building, processing area, or facility-wide. A group of processes may consist of a single process.

*Halogenated compounds* means organic compounds that contain chlorine atoms.

*Halogenated vent stream* means a process, storage vessel, or waste management unit vent stream determined to have a concentration of halogenated compounds of greater than 20 ppmv, as determined through process knowledge, test results using Method 18 of 40 CFR part 60, appendix A, or test results using any other test method that has been validated according to the procedures in Method 301 of appendix A of this part.

*Hard-piping* means piping or tubing that is manufactured and properly installed using good engineering judgment and standards, such as ANSI B31-3.

*Impurity* means a substance that is produced coincidentally with the product(s), or is present in a raw material. An impurity does not serve a useful purpose in the production or use of the product(s) and is not isolated.

*In gas/vapor service* means that a piece of equipment in organic HAP service contains a gas or vapor at operating conditions.

*In heavy liquid service* means that a piece of equipment in organic HAP service is not in gas/vapor service or in light liquid service.

*In light liquid service* means that a piece of equipment in organic HAP service contains a liquid that meets the following conditions:

- (1) The vapor pressure of one or more of the organic compounds is greater than 0.3 kPa at 20 °C;
- (2) The total concentration of the pure organic compounds constituents having a vapor pressure greater than 0.3 kPa at 20 °C is equal to or greater than 20 percent by weight of the total process stream; and
- (3) The fluid is a liquid at operating conditions.

Note: To definition of “In light liquid service: Vapor pressures may be determined by the methods described in 40 CFR 60.485(e)(1).

*In liquid service* means that a piece of equipment in organic HAP service is not in gas/vapor service.

*In organic hazardous air pollutant or in organic HAP service* means that a piece of equipment either contains or contacts a fluid (liquid or gas) that is at least 5 percent by weight of total organic HAP as determined according to the provisions of §63.180(d) of subpart H of this part. The provisions of §63.180(d) of subpart H of this part also specify how to determine that a piece of equipment is not in organic HAP service.

*In vacuum service* means that equipment is operating at an internal pressure which is at least 5 kPa below ambient pressure.

*In-situ sampling systems* means nonextractive samplers or in-line samplers.

*Individual drain system* means the stationary system used to convey wastewater streams or residuals to a waste management unit or to discharge or disposal. The term includes: hard piping; all process drains and junction boxes; and associated sewer lines, other junction boxes, manholes, sumps, and lift stations conveying wastewater streams or residuals. A segregated stormwater sewer system, which is a drain and collection system designed and operated for the sole purpose of collecting rainfall-runoff at a facility, and which is segregated from all other individual drain systems, is excluded from this definition.

*Instrumentation system* means a group of equipment components used to condition and convey a sample of the process fluid to analyzers and instruments for the purpose of determining process operating conditions (e.g., composition, pressure, flow, etc.). Valves and connectors are the predominant type of

equipment used in instrumentation systems; however, other types of equipment may also be included in these systems. Only valves nominally 0.5 inches and smaller and connectors nominally 0.75 inches and smaller in diameter are considered instrumentation systems for the purposes of this subpart. Valves greater than nominally 0.5 inches and connectors greater than nominally 0.75 inches associated with instrumentation systems are not considered part of instrumentation systems and must be monitored individually.

*Integral intermediate* means an intermediate for which 50 percent or more of the annual production is used in on-site production of any PAI(s) and that is not stored before being used in the production of another integral intermediate or the PAI(s). For the purposes of this definition, an intermediate is stored if it is discharged to a storage vessel and at least one of the following conditions is met: the processing equipment that discharges to the storage vessel is shutdown before the processing equipment that withdraws from the storage vessel is started up; during an annual period, the material must be stored in the vessel for at least 30 days before being used to make a PAI; or the processing equipment that discharges to the storage vessel is located in a separate building (or processing area) of the plant than the processing equipment that uses material from the storage vessel as a feedstock, and control equipment is not shared by the two processing areas. Any process unit that produces an intermediate and is subject to subpart F of this part is not an integral intermediate.

*Intermediate* means an organic compound that is manufactured in a process and that is further processed or modified in one or more additional steps to ultimately produce a PAI.

*Internal floating roof* means a cover that rests or floats on the liquid surface (but not necessarily in complete contact with it) inside a storage tank or waste management unit that has a permanently affixed roof.

*Junction box* means a manhole or access point to a wastewater sewer system line or a lift station.

*Large control device* means a control device that controls process vents, and the total HAP emissions into the control device from all sources are greater than or equal to 10 tons/yr.

*Liquid-mounted seal* means a foam- or liquid-filled seal mounted in contact with the liquid between the wall of the storage vessel or waste management unit and the floating roof. The seal is mounted continuously around the tank or unit.

*Liquids dripping* means any visible leakage from the seal including dripping, spraying, misting, clouding, and ice formation. Indications of liquid dripping include puddling or new stains that are indicative of an existing evaporated drip.

*Maintenance wastewater* means wastewater generated by the draining of process fluid from components in the PAI process unit into an individual drain system prior to or during maintenance activities. Maintenance wastewater can be generated through planned or unplanned shutdowns and during periods not associated with a shutdown. Examples of activities that can generate maintenance wastewaters include descaling of heat exchanger tubing bundles, cleaning of distillation column traps, draining of low legs and high point bleeds, draining of pumps into an individual drain system, and draining of portions of the PAI process unit for repair.

*Malfunction* means any sudden, infrequent, and not reasonably preventable failure of air pollution control equipment, emissions monitoring equipment, process equipment, or a process to operate in a normal or usual manner which causes, or has the potential to cause, the emission limitations in an applicable standard to be exceeded. Failures that are caused all or in part by poor maintenance or careless operation are not malfunctions.

*Maximum true vapor pressure* means the equilibrium partial pressure exerted by the total organic HAP in the stored or transferred liquid at the temperature equal to the highest calendar-month average of the liquid storage or transferred temperature for liquids stored or transferred above or below the ambient temperature or at the local maximum monthly average temperature as reported by the National Weather Service for liquids stored or transferred at the ambient temperature, as determined:

- (1) In accordance with methods described in Chapter 19.2 of the American Petroleum Institute's Manual of Petroleum Measurement Standards, Evaporative Loss From Floating-Roof Tanks (incorporated by reference as specified in §63.14 in subpart A of this part); or
- (2) As obtained from standard reference texts; or
- (3) As determined by the American Society for Testing and Materials Method D2879-97, Test Method for Vapor Pressure-Temperature Relationship and Initial Decomposition Temperature of Liquids by Isoteniscope (incorporated by reference as specified in §63.14 of subpart A of this part); or
- (4) Any other method approved by the Administrator.

*Metallic shoe seal or mechanical shoe seal* means metal sheets that are held vertically against the wall of the storage tank by springs, weighted levers, or other mechanisms and connected to the floating roof by braces or other means. A flexible coated fabric (envelope) spans the annular space between the metal sheet and the floating roof.

*Non-dedicated PAI process unit* means a process unit that is not a dedicated PAI process unit.

*Nonrepairable* means that it is technically infeasible to repair a piece of equipment from which a leak has been detected without a process shutdown.

*Open-ended valve or line* means any valve, except pressure relief valves, having one side of the valve seat in contact with process fluid and one side open to atmosphere, either directly or through open piping.

*Operating scenario*, for the purposes of reporting and recordkeeping, means a description of a PAI process unit, including: identification of each wastewater point of determination (POD) and process vent, their associated emissions episodes and durations, and their associated level of control and control devices, as applicable; calculations and engineering analyses required to demonstrate compliance; and a description of operating and/or testing conditions for any associated control device.

*Organic compound*, as used in the definitions of intermediate and PAI, means any compound that contains both carbon and hydrogen with or without other elements.

*Organic HAP* means those HAP listed in section 112(b) of the CAA that are measured according to the procedures of Method 18 or Method 25A, 40 CFR part 60, appendix A.

*Pesticide active ingredient or PAI* means any material that is an active ingredient within the meaning of FIFRA section 2(a); that is used to produce an insecticide, herbicide, or fungicide end use pesticide product; that consists of one or more organic compounds; and that must be labeled in accordance with 40 CFR part 156 for transfer, sale, or distribution. These materials are typically described by North American Industrial Classification System (NAICS) Codes 325199 and 32532 (i.e., previously known as Standard Industrial Classification System Codes 2869 and 2879). These materials are identified by product classification codes 01, 21, 02, 04, 44, 07, 08, and 16 in block 19 on the 1999 version of EPA form 3540-16, the Pesticides Report for Pesticide-Producing Establishments. The materials represented by these codes are: insecticides; insecticide-fungicides; fungicides; herbicides; herbicide-fungicides; plant regulators; defoliants, desiccants; or multi-use active ingredients.

*Pesticide active ingredient manufacturing process unit (PAI process unit)* means a process unit that is used to produce a material that is primarily used as a PAI or integral intermediate. A PAI process unit consists of: the process, as defined in this subpart; associated storage vessels, as determined by the procedures in §63.1360(f); equipment identified in §63.1362(k); connected piping and ducts; and components such as pumps, compressors, agitators, pressure relief devices, sampling connection systems, open-ended valves or lines, valves, connectors, and instrumentation systems. A material is primarily used as a PAI or integral intermediate if more than 50 percent of the projected annual production from a process unit in the 3 years after June 23, 1999 or startup, whichever is later, is used as a PAI or integral intermediate; recordkeeping is required if the material is used as a PAI or integral intermediate, but not as the primary use. If the primary use changes to a PAI or integral intermediate, the process unit becomes a PAI process unit unless it is already subject to the HON. If the primary use changes from a PAI or integral intermediate to another use, the process unit remains a PAI process unit. Any process tank containing an integral intermediate is part of the PAI process unit used to produce the integral intermediate. A process unit that produces an intermediate that is not an integral intermediate may be designated as a PAI process unit according to the procedures of §63.1360(g). Formulation of pesticide products is not considered part of a PAI process unit. Quality assurance and quality control laboratories are not considered part of a PAI process unit.

*Plant site* means all contiguous or adjoining property that is under common control, including properties that are separated only by a road or other public right-of-way. Common control includes properties that are owned, leased, or operated by the same entity, parent entity, subsidiary, or any combination thereof.

*Point of determination (POD)* means each point where a wastewater stream exits the PAI process unit.

Note to definition of “point of determination”: The regulation allows determination of the characteristics of a wastewater stream: at the point of determination; or downstream of the point of determination if corrections are made for changes in flow rate and annual average concentration of Table 9 compounds as determined in §63.144 of subpart G of this part. Such changes include: losses by air emissions, reduction of annual average concentration or changes in flow rate by mixing with other water or wastewater streams, and reduction in flow rate or annual average concentration by treating or otherwise handling the wastewater stream to remove or destroy HAP.

*Pressure release* means the emission of materials resulting from the system pressure being greater than the set pressure of the pressure relief device. This release can be one release or a series of releases over a short time period due to a malfunction in the process.

*Pressure relief device or valve* means a safety device used to prevent operating pressures from exceeding the maximum allowable working pressure of the process equipment. A common pressure relief device is a spring-loaded pressure relief valve. Devices that are actuated either by a pressure of less than or equal to 2.5 pounds per square inch gauge or by a vacuum are not pressure relief devices.

*Process* means a logical grouping of processing equipment which collectively function to produce a product. For the purpose of this subpart, a PAI process includes all, or a combination of, reaction, recovery, separation, purification, treatment, cleaning, and other activities or unit operations which are used to produce a PAI or integral intermediate. Ancillary activities are not considered a PAI process or any part of a PAI process. Ancillary activities include boilers and incinerators (not used to comply with the provisions of §63.1362), chillers or refrigeration systems, and other equipment and activities that are not directly involved (i.e., they operate within a closed system and materials are not combined with process fluids) in the processing of raw materials or the manufacturing of a PAI. A PAI process and all integral intermediate processes for which 100 percent of the annual production is used in the production of the PAI may be linked together and defined as a single PAI process unit.

*Process condenser* means a condenser whose primary purpose is to recover material as an integral part of a unit operation. The condenser must cause a vapor-to-liquid phase change for periods during which the temperature of liquid in the process equipment is at or above its boiling or bubble point. Examples of process condensers include distillation condensers, reflux condensers, and condensers used in stripping or flashing operation. In a series of condensers, all condensers up to and including the first condenser with an exit gas temperature below the boiling or bubble point of the liquid in the process equipment are considered to be process condensers. All condensers in line prior to the vacuum source are included in this definition.

*Process shutdown* means a work practice or operational procedure that stops production from a process or part of a process during which it is technically feasible to clear process material from a process or part of a process consistent with safety constraints and during which repairs can be effected. An unscheduled work practice or operational procedure that stops production from a process or part of a process for less than 24 hours is not a process shutdown. An unscheduled work practice or operational procedure that would stop production from a process or part of a process for a shorter period of time than would be required to clear the process or part of the process of materials and start up the process, and would result in greater emissions than delay of repair of leaking components until the next scheduled process shutdown, is not a process shutdown. The use of spare equipment and technically feasible bypassing of equipment without stopping production are not process shutdowns.

*Process tank* means a tank that is used within a process to collect material discharged from a feedstock storage vessel or equipment within the process before the material is transferred to other equipment within the process or a product storage vessel. In many process tanks, unit operations such as reactions and blending are conducted. Other process tanks, such as surge control vessels and bottom receivers, however, may not involve unit operations.

*Process unit* means the equipment assembled and connected by pipes or ducts to process raw materials and to manufacture an intended product.

*Process unit group* means a group of process units that manufacture PAI and products other than PAI by alternating raw materials or operating conditions, or by reconfiguring process equipment. A process unit group is determined according to the procedures specified in §63.1360(g).

*Process vent* means a point of emission from processing equipment to the atmosphere or a control device. The vent may be the release point for an emission stream associated with an individual unit operation, or it may be the release point for emission streams from multiple unit operations that have been manifolded together into a common header. Examples of process vents include, but are not limited to, vents on condensers used for product recovery, bottom receivers, surge control vessels, reactors, filters, centrifuges, process tanks, and product dryers. A vent is not considered to be a process vent for a given emission episode if the undiluted and uncontrolled emission stream that is released through the vent contains less than 50 ppmv HAP, as determined through process knowledge that no HAP are present in the emission stream; using an engineering assessment as discussed in §63.1365(c)(2)(ii); from test data collected using Method 18 of 40 CFR part 60, appendix A; or from test data collected using any other test method that has been validated according to the procedures in Method 301 of appendix A of this part. Process vents do not include vents on storage vessels regulated under §63.1362(c), vents on wastewater emission sources regulated under §63.1362(d), or pieces of equipment regulated under §63.1363.

*Process wastewater* means wastewater which, during manufacturing or processing, comes into direct contact with, or results from, the production or use of any raw material, intermediate product, finished product, by-product, or waste product. Examples include: product tank drawdown or feed tank drawdown; water formed during a chemical reaction or used as a reactant; water used to wash impurities from organic products or reactants; water used to clean process equipment; water used to cool or quench organic vapor streams through direct contact; and condensed steam from jet ejector systems pulling vacuum on vessels containing organics.

*Product* means the compound(s) or chemical(s) that are produced or manufactured as the intended output of a process unit. Impurities and wastes are not considered products.

*Product dryer* means equipment that is used to remove moisture or other liquid from granular, powdered, or other solid PAI or integral intermediate products prior to storage, formulation, shipment, or other uses. The product dryer is part of the process.

*Product dryer vent* means a process vent from a product dryer through which a gas stream containing gaseous pollutants (i.e., organic HAP, HCl, or chlorine), particulate matter, or both are released to the atmosphere or are routed to a control device.

*Production-indexed HAP consumption factor (HAP factor)* is the result of dividing the annual consumption of total HAP by the annual production rate, per process.

*Production-indexed VOC consumption factor (VOC factor)* is the result of dividing the annual consumption of total VOC by the annual production rate, per process.

*Publicly owned treatment works (POTW)* is defined at 40 CFR part 403.3(0).



*Reactor* means a device or vessel in which one or more chemicals or reactants, other than air, are combined or decomposed in such a way that their molecular structures are altered and one or more new organic compounds are formed.

*Reconfiguration* means disassembly of processing equipment for a particular non-dedicated process unit and reassembly of that processing equipment in a different sequence, or in combination with other equipment, to create a different non-dedicated process unit.

*Reconstruction*, as used in §63.1360(b), shall have the meaning given in §63.2, except that “affected or previously unaffected stationary source” shall mean either “affected facility” or “PAI process unit.”

*Recovery device*, as used in the wastewater provisions, means an individual unit of equipment capable of, and normally used for the purpose of, recovering chemicals for fuel value (i.e., net positive heating value), use, reuse, or for sale for fuel value, use, or reuse. Examples of equipment that may be recovery devices include organic removal devices such as decanters, strippers, or thin-film evaporation units. To be a recovery device, a decanter and any other equipment based on the operating principle of gravity separation must receive only multi-phase liquid streams.

*Repaired* means that equipment is adjusted, or otherwise altered, to eliminate a leak as defined in the applicable paragraphs of §63.1363.

*Research and development facility* means any stationary source whose primary purpose is to conduct research and development, where the operations are under the close supervision of technically trained personnel, and is not engaged in the manufacture of products for commercial sale, except in a de minimis manner.

*Residual* means any liquid or solid material containing Table 9 compounds (as defined in §63.111 of subpart G of this part) that is removed from a wastewater stream by a waste management unit or treatment process that does not destroy organics (nondestructive unit). Examples of residuals from nondestructive wastewater management units include the organic layer and bottom residue removed by a decanter or organic-water separator and the overheads from a steam stripper or air stripper. Examples of materials which are not residuals include: silt; mud; leaves; bottoms from a steam stripper or air stripper; and sludges, ash, or other materials removed from wastewater being treated by destructive devices such as biological treatment units and incinerators.

*Safety device* means a closure device such as a pressure relief valve, frangible disc, fusible plug, or any other type of device which functions exclusively to prevent physical damage or permanent deformation to a unit or its air emission control equipment by venting gases or vapors directly to the atmosphere during unsafe conditions resulting from an unplanned, accidental, or emergency event. For the purposes of this subpart, a safety device is not used for routine venting of gases or vapors from the vapor headspace underneath a cover such as during filling of the unit or to adjust the pressure in this vapor headspace in response to normal daily diurnal ambient temperature fluctuations. A safety device is designed to remain in a closed position during normal operations and open only when the internal pressure, or another relevant parameter, exceeds the device threshold setting applicable to the air emission control equipment as determined by the owner or operator based on manufacturer recommendations, applicable regulations,

fire protection and prevention codes, standard engineering codes and practices, or other requirements for the safe handling of flammable, combustible, explosive, reactive, or hazardous materials.

*Sampling connection system* means an assembly of equipment within a process unit used during periods of representative operation to take samples of the process fluid. Equipment used to take nonroutine grab samples is not considered a sampling connection system.

*Sensor* means a device that measures a physical quantity or the change in a physical quantity, such as temperature, pressure, flow rate, pH, or liquid level.

*Set pressure* means the pressure at which a properly operating pressure relief device begins to open to relieve atypical process system operating pressure.

*Sewer line* means a lateral, trunk line, branch line, or other conduit including, but not limited to, grates, trenches, etc., used to convey wastewater streams or residuals to a downstream waste management unit.

*Shutdown* means the cessation of operation of a continuous PAI process unit for any purpose. Shutdown also means the cessation of a batch PAI process unit or any related individual piece of equipment required or used to comply with this part or for emptying and degassing storage vessels for periodic maintenance, replacement of equipment, repair, or any other purpose not excluded from this definition. Shutdown does not apply to cessation of a batch PAI process unit at the end of a campaign or between batches (e.g., for rinsing or washing equipment), for routine maintenance, or for other routine operations.

*Small control device* means a control device that controls process vents, and the total HAP emissions into the control device from all sources are less than 10 tons of HAP per year.

*Startup* means the setting in operation of a continuous PAI process unit for any purpose, the first time a new or reconstructed batch PAI process unit begins production, or, for new equipment added, including equipment used to comply with this subpart, the first time the equipment is put into operation. For batch process units, startup does not apply to the first time the equipment is put into operation at the start of a campaign to produce a product that has been produced in the past, after a shutdown for maintenance, or when the equipment is put into operation as part of a batch within a campaign. As used in §63.1363, startup means the setting in operation of a piece of equipment or a control device that is subject to this subpart.

*Storage vessel* means a tank or other vessel that is used to store organic liquids that contain one or more HAP and that has been assigned, according to the procedures in §63.1360(f) or (g), to a PAI process unit that is subject to this subpart MMM. The following are not considered storage vessels for the purposes of this subpart:

- (1) Vessels permanently attached to motor vehicles such as trucks, railcars, barges, or ships;
- (2) Pressure vessels designed to operate in excess of 204.9 kilopascals and without emissions to the atmosphere;
- (3) Vessels storing material that contains no organic HAP or contains organic HAP only as impurities;
- (4) Wastewater storage tanks;

(5) Process tanks; and

(6) Nonwastewater waste tanks.

*Supplemental gases* means any nonaffected gaseous streams (streams that are not from process vents, storage vessels, equipment or waste management units) that contain less than 50 ppmv TOC and less than 50 ppmv total HCl and chlorine, as determined through process knowledge, and are combined with an affected vent stream. Supplemental gases are often used to maintain pressures in manifolds or for fire and explosion protection and prevention. Air required to operate combustion device burner(s) is not considered a supplemental gas.

*Surface impoundment* means a waste management unit which is a natural topographic depression, manmade excavation, or diked area formed primarily of earthen materials (although it may be lined with manmade materials), which is designed to hold an accumulation of liquid wastes or waste containing free liquids. A surface impoundment is used for the purpose of treating, storing, or disposing of wastewater or residuals, and is not an injection well. Examples of surface impoundments are equalization, settling, and aeration pits, ponds, and lagoons.

*Total organic compounds (TOC)* means those compounds measured according to the procedures of Method 18 or Method 25A, 40 CFR part 60, appendix A.

*Treatment process* means a specific technique that removes or destroys the organics in a wastewater or residual stream such as a steam stripping unit, thin-film evaporation unit, waste incinerator, biological treatment unit, or any other process applied to wastewater streams or residuals to comply with §63.138 of subpart G of this part. Most treatment processes are conducted in tanks. Treatment processes are a subset of waste management units.

*Uncontrolled HAP emissions* means a gas stream containing HAP which has exited the process (or process condenser, if any), but which has not yet been introduced into an air pollution control device to reduce the mass of HAP in the stream. If the process vent is not routed to an air pollution control device, uncontrolled emissions are those HAP emissions released to the atmosphere.

*Unit operation* means those processing steps that occur within distinct equipment that are used, among other things, to prepare reactants, facilitate reactions, separate and purify products, and recycle materials. Equipment used for these purposes includes, but is not limited to, reactors, distillation units, extraction columns, absorbers, decanters, dryers, condensers, and filtration equipment.

*Vapor-mounted seal* means a continuous seal that completely covers the annular space between the wall of the storage tank or waste management unit and the edge of the floating roof, and is mounted such that there is a vapor space between the stored liquid and the bottom of the seal.

*Volatile organic compounds* are defined in 40 CFR 51.100.

*Waste management unit* means the equipment, structure(s), and/or device(s) used to convey, store, treat, or dispose of wastewater streams or residuals. Examples of waste management units include wastewater tanks, surface impoundments, individual drain systems, and biological wastewater treatment units. Examples of equipment that may be waste management units include containers, air flotation units, oil-

water separators or organic-water separators, or organic removal devices such as decanters, strippers, or thin-film evaporation units. If such equipment is a recovery device, then it is part of a PAI process unit and is not a waste management unit.

*Wastewater* means water that meets either of the conditions described in paragraph (1) or (2) of this definition and is discarded from a PAI process unit that is at an affected source:

(1) Is generated from a PAI process or a scrubber used to control emissions from a PAI process and contains either:

(i) An annual average concentration of compounds in Table 9 of subpart G of this part of at least 5 ppmw and has an average flow rate of 0.02 L/min or greater; or

(ii) An annual average concentration of compounds in Table 9 of subpart G of this part of at least 10,000 ppmw at any flow rate;

(2) Is generated from a PAI process unit as a result of maintenance activities and contains at least 5.3 Mg of compounds listed in Table 9 of subpart G of this part per individual discharge event.

*Wastewater tank* means a stationary waste management unit that is designed to contain an accumulation of wastewater or residuals and is constructed primarily of nonearthen materials (e.g., wood, concrete, steel, plastic) which provide structural support. Wastewater tanks used for flow equalization are included in this definition.

*Water seal controls* means a seal pot, p-leg trap, or other type of trap filled with water (e.g., flooded sewers that maintain water levels adequate to prevent air flow through the system) that creates a water barrier between the sewer line and the atmosphere. The water level of the seal must be maintained in the vertical leg of a drain in order to be considered a water seal.

[64 FR 33589, June 23, 1999, as amended at Nov. 21, 2001; 67 FR 59343, Sept. 20, 2002; 71 FR 20460, Apr. 20, 2006; 79 FR 17372, Mar. 27, 2014]

[↑ Back to Top](#)

### **§63.1362 Standards.**

(a) On and after the compliance dates specified in §63.1364, each owner or operator of an affected source subject to the provisions of this subpart shall control HAP emissions to the levels specified in this section and in §63.1363, as summarized in Table 2 of this subpart.

(b) *Process vents.* (1) The owner or operator of an existing source shall comply with the requirements of paragraphs (b)(2) and (3) of this section. The owner or operator of a new source shall comply with the requirements of paragraphs (b)(4) and (5) of this section. Compliance with paragraphs (b)(2) through (b)(5) of this section shall be demonstrated through the applicable test methods and initial compliance procedures in §63.1365 and the monitoring requirements in §63.1366.

(2) *Organic HAP emissions from existing sources.* The owner or operator of an existing affected source must comply with the requirements in either paragraph (b)(2)(i) of this section or with the requirements in paragraphs (b)(2)(ii) through (iv) of this section.

(i) The uncontrolled organic HAP emission rate shall not exceed 0.15 Mg/yr from the sum of all process vents within a process.

(ii) (A) Except as provided in paragraph (b)(2)(ii)(B) of this section, uncontrolled organic HAP emissions from a process vent shall be reduced by 98 percent by weight or greater if the flow-weighted average flowrate for the vent as calculated using Equation 1 of this subpart is less than or equal to the flowrate calculated using Equation 2 of this subpart.

$$FR_a = \frac{\sum_{i=1}^n (D_i)(FR_i)}{\sum_{i=1}^n D_i} \quad (Eq. 1)$$

[View or download PDF](#)

$$FR = 0.02 * (HL) - 1,000 \quad (Eq. 2)$$

[View or download PDF](#)

Where:

$FR_a$  = flow-weighted average flowrate for the vent, scfm

$D_i$  = duration of each emission event, min

$FR_i$  = flowrate of each emission event, scfm

$n$  = number of emission events

$FR$  = flowrate, scfm

$HL$  = annual uncontrolled organic HAP emissions, lb/yr, as defined in §63.1361

(B) If the owner or operator can demonstrate that a control device, installed on or before November 10, 1997 on a process vent otherwise subject to the requirements of paragraph (b)(2)(ii)(A) of this section, reduces inlet emissions of total organic HAP by greater than or equal to 90 percent by weight but less than 98 percent by weight, then the control device must be operated to reduce inlet emissions of total organic HAP by 90 percent by weight or greater.

(iii) Excluding process vents that are subject to the requirements in paragraph (b)(2)(ii) of this section, uncontrolled organic HAP emissions from the sum of all process vents within a process shall be reduced by 90 percent or greater by weight.

(iv) As an alternative to the requirements in paragraphs (b)(2)(ii) and (iii) of this section, uncontrolled organic HAP emissions from any process vent may be reduced in accordance with any of the provisions in paragraphs (b)(2)(iv)(A) through (D) of this section. All remaining process vents within a process must be controlled in accordance with paragraphs (b)(2)(ii) and (iii) of this section.

(A) To outlet concentrations less than or equal to 20 ppmv; or

(B) By a flare that meets the requirements of §63.11(b); or

(C) By a control device specified in §63.1365(a)(4); or

(D) In accordance with the alternative standard specified in paragraph (b)(6) of this section.

(3) *HCl and Cl<sub>2</sub> emissions from existing sources.* For each process, the owner or operator of an existing source shall comply with the requirements of either paragraph (b)(3)(i) or (ii) of this section.

(i) The uncontrolled HCl and Cl<sub>2</sub> emissions, including HCl generated from the combustion of halogenated process vent emissions, from the sum of all process vents within a process shall not exceed 6.8 Mg/yr.

(ii) HCl and Cl<sub>2</sub> emissions, including HCl generated from combustion of halogenated process vent emissions, from the sum of all process vents within a process shall be reduced by 94 percent or greater or to outlet concentrations less than or equal to 20 ppmv.

(4) *Organic HAP emissions from new sources.* For each process, the owner or operator of a new source shall comply with the requirements of either paragraph (b)(4)(i) or (ii) of this section.

(i) The uncontrolled organic HAP emissions shall not exceed 0.15 Mg/yr from the sum of all process vents within a process.

(ii) The uncontrolled organic HAP emissions from the sum of all process vents within a process at a new affected source that are not controlled according to any of the requirements of paragraphs (b)(4)(ii)(A) through (C) or (b)(6) of this section shall be reduced by 98 weight percent or greater.

(A) To outlet concentrations less than or equal to 20 ppmv; or

(B) By a flare that meets the requirements of §63.11(b); or

(C) By a control device specified in §63.1365(a)(4).

(5) *HCl and Cl<sub>2</sub> emissions from new sources.* For each process, the owner or operator of a new source shall comply with the requirements of either paragraph (b)(5)(i), (ii), or (iii) of this section.

(i) The uncontrolled HCl and Cl<sub>2</sub> emissions, including HCl generated from combustion of halogenated process vent emissions, from the sum of all process vents within a process shall not exceed 6.8 Mg/yr.

(ii) If HCl and Cl<sub>2</sub> emissions, including HCl generated from combustion of halogenated process vent emissions, from the sum of all process vents within a process are greater than 6.8 Mg/yr and less than or

equal to 191 Mg/yr, these HCl and Cl<sub>2</sub> emissions shall be reduced by 94 percent or to an outlet concentration less than or equal to 20 ppmv.

(iii) If HCl and Cl<sub>2</sub> emissions, including HCl generated from combustion of halogenated process vent emissions, from the sum of all process vents within a process are greater than 191 Mg/yr, these HCl and Cl<sub>2</sub> emissions shall be reduced by 99 percent or greater or to an outlet concentration less than or equal to 20 ppmv.

(6) *Alternative standard.* As an alternative to the provisions in paragraphs (b)(2) through (5) of this section, the owner or operator may route emissions from a process vent to a combustion control device achieving an outlet TOC concentration, as calibrated on methane or the predominant HAP, of 20 ppmv or less, and an outlet concentration of HCl and Cl<sub>2</sub> of 20 ppmv or less. If the owner or operator is routing emissions to a non-combustion control device or series of control devices, the control device(s) must achieve an outlet TOC concentration, as calibrated on methane or the predominant HAP, of 50 ppmv or less, and an outlet concentration of HCl and Cl<sub>2</sub> of 50 ppmv or less. Any process vents within a process that are not routed to such a control device or series of control devices must be controlled in accordance with the provisions of paragraph (b)(2)(ii), (iii), (iv), (b)(3)(ii), (b)(4)(ii), (b)(5)(ii) or (iii) of this section, as applicable.

(c) *Storage vessels.* (1) The owner or operator shall either determine the group status of a storage vessel or designate it as a Group 1 storage vessel. If the owner or operator elects to designate the storage vessel as a Group 1 storage vessel, the owner or operator is not required to determine the maximum true vapor pressure of the material stored in the storage vessel.

(2) *Standard for existing sources.* Except as specified in paragraphs (c)(4), (5), and (6) of this section, the owner or operator of a Group 1 storage vessel at an existing affected source, as defined in §63.1361, shall equip the affected storage vessel with one of the following:

- (i) A fixed roof and internal floating roof, or
- (ii) An external floating roof, or
- (iii) An external floating roof converted to an internal floating roof, or
- (iv) A closed vent system meeting the conditions of paragraph (j) of this section and a control device that meets any of the following conditions:
  - (A) Reduces organic HAP emissions by 95 percent by weight or greater; or
  - (B) Reduces organic HAP emissions to outlet concentrations of 20 ppmv or less; or
  - (C) Is a flare that meets the requirements of §63.11(b); or
  - (D) Is a control device specified in §63.1365(a)(4).

(3) *Standard for new sources.* Except as specified in paragraphs (c)(4), (5), and (6) of this section, the owner or operator of a Group 1 storage vessel at a new source, as defined in §63.1361, shall equip the affected storage vessel in accordance with any one of paragraphs (c)(2)(i) through (iv) of this section.

(4) *Alternative standard.* As an alternative to the provisions in paragraphs (c)(2) and (3) of this section, the owner or operator of an existing or new affected source may route emissions from storage vessels to a combustion control device achieving an outlet TOC concentration, as calibrated on methane or the predominant HAP, of 20 ppmv or less, and an outlet concentration of hydrogen chloride and chlorine of 20 ppmv or less. If the owner or operator is routing emissions to a non-combustion control device or series of control devices, the control device(s) must achieve an outlet TOC concentration, as calibrated on methane or the predominant HAP, of 50 ppmv or less, and an outlet concentration of HCl and Cl<sub>2</sub> of 50 ppmv or less.

(5) *Planned routine maintenance.* The owner or operator is exempt from the specifications in paragraphs (c)(2) through (4) of this section during periods of planned routine maintenance of the control device that do not exceed 240 hr/yr. The owner or operator may submit an application to the Administrator requesting an extension of this time limit to a total of 360 hr/yr. The application must explain why the extension is needed, it must indicate that no material will be added to the storage vessel between the time the 240-hr limit is exceeded and the control device is again operational, and it must be submitted at least 60 days before the 240-hr limit will be exceeded.

(6) *Vapor balancing alternative.* As an alternative to the requirements in paragraphs (c)(2) and (3) of this section, the owner or operator of an existing or new affected source may implement vapor balancing in accordance with paragraphs (c)(6)(i) through (vii) of this section.

(i) The vapor balancing system must be designed and operated to route organic HAP vapors displaced from loading of the storage tank to the railcar or tank truck from which the storage tank is filled.

(ii) Tank trucks and railcars must have a current certification in accordance with the U.S. Department of Transportation pressure test requirements of 49 CFR part 180 for tank trucks and 49 CFR 173.31 for railcars.

(iii) Hazardous air pollutants must only be unloaded from tank trucks or railcars when vapor collection systems are connected to the storage tank's vapor collection system.

(iv) No pressure relief device on the storage tank or on the railcar or tank truck shall open during loading or as a result of diurnal temperature changes (breathing losses).

(v) Pressure relief devices on affected storage tanks must be set to no less than 2.5 psig at all times to prevent breathing losses. The owner or operator shall record the setting as specified in §63.1367(b)(8) and comply with the following requirements for each pressure relief valve:

(A) The pressure relief valve shall be monitored quarterly using the method described in §63.180(b).

(B) An instrument reading of 500 ppmv or greater defines a leak.

(C) When a leak is detected, it shall be repaired as soon as practicable, but no later than 5 days after it is detected, and the owner or operator shall comply with the recordkeeping requirements of §63.1363(g)(4)(i) through (iv).

(vi) Railcars or tank trucks that deliver HAP to an affected storage tank must be reloaded or cleaned at a facility that utilizes one of the following control techniques:



(A) The railcar or tank truck must be connected to a closed vent system with a control device that reduces inlet emissions of HAP by 90 percent by weight or greater; or

(B) A vapor balancing system designed and operated to collect organic HAP vapor displaced from the tank truck or railcar during reloading must be used to route the collected HAP vapor to the storage tank from which the liquid being transferred originated.

(vii) The owner or operator of the facility where the railcar or tank truck is reloaded or cleaned must comply with the following requirements:

(A) Submit to the owner or operator of the affected storage tank and to the Administrator a written certification that the reloading or cleaning facility will meet the requirements of this section. The certifying entity may revoke the written certification by sending a written statement to the owner or operator of the affected storage tank giving at least 90 days notice that the certifying entity is rescinding acceptance of responsibility for compliance with the requirements of this paragraph (c)(6)(vii)(A).

(B) If complying with paragraph (c)(6)(vi)(A) of this section, demonstrate initial compliance in accordance with §63.1365(d), demonstrate continuous compliance in accordance with §63.1366, keep records as specified in §63.1367, and prepare reports as specified in §63.1368.

(C) If complying with paragraph (c)(6)(vi)(B) of this section, keep records of:

(1) The equipment to be used and the procedures to be followed when reloading the railcar or tank truck and displacing vapors to the storage tank from which the liquid originates, and

(2) Each time the vapor balancing system is used to comply with paragraph (c)(6)(vi)(B) of this section.

(7) Compliance with the provisions of paragraphs (c)(2) and (3) of this section is demonstrated using the initial compliance procedures in §63.1365(d) and the monitoring requirements in §63.1366. Compliance with the outlet concentrations in paragraph (c)(4) of this section shall be determined by the initial compliance provisions in §63.1365(a)(5) and the continuous emission monitoring requirements of §63.1366(b)(5).

(d) *Wastewater.* The owner or operator of each affected source shall comply with the requirements of §§63.132 through 63.147, with the differences noted in paragraphs (d)(1) through (16) of this section for the purposes of this subpart.

(1) When the determination of equivalence criteria in §63.102(b) is referred to in §§63.132, 63.133, and 63.137 of subpart G of this part, the provisions in §63.6(g) of subpart A of this part shall apply.

(2) When the storage tank requirements contained in §§63.119 through 63.123 are referred to in §§63.132 through 63.147, §§63.119 through 63.123 are applicable, with the exception of the differences noted in paragraphs (d)(2)(i) through (iv) of this section.

(i) When the term “storage vessel” is used in §§63.119 through 63.123 of subpart G of this part, the definition of the term “storage vessel” in §63.1361 shall apply for the purposes of this subpart.

(ii) When December 31, 1992, is referred to in §63.119 of subpart G of this part, November 10, 1997 shall apply for the purposes of this subpart.

(iii) When April 22, 1994 is referred to in §63.119 of subpart G of this part, June 23, 1999 shall apply for the purposes of this subpart.

(iv) When the phrase “the compliance date specified in §63.100 of subpart F of this part” is referred to in §63.120 of subpart G of this part, the phrase “the compliance date specified in §63.1364” shall apply for the purposes of this subpart.

(3) To request approval to monitor alternative parameters, as referred to in §63.146(a) of subpart G of this part, the owner or operator shall comply with the procedures in §63.8(f) of subpart A of this part, as referred to in §63.1366(b)(4), instead of the procedures in §63.151(f) or (g) of subpart G of this part.

(4) When the Notification of Compliance Status report requirements contained in §63.152(b) of subpart G of this part are referred to in §63.146 of subpart G of this part, the Notification of Compliance Status report requirements in §63.1368(f) shall apply for the purposes of this subpart.

(5) When the recordkeeping requirements contained in §63.152(f) of subpart G of this part are referred to in §63.147(d) of subpart G of this part, the recordkeeping requirements in §63.1367 shall apply for the purposes of this subpart.

(6) When the Periodic report requirements contained in §63.152(c) of subpart G of this part are referred to in §§63.146 and 63.147 of subpart G of this part, the Periodic report requirements contained in §63.1368(g) shall apply for the purposes of this subpart.

(7) When the term “process wastewater” is referred to in §§63.132 through 63.147 of subpart G of this part, the term “wastewater” as defined in §63.1361 shall apply for the purposes of this subpart.

(8) When the term “Group 1 wastewater stream” is used in §§63.132 through 63.147 of subpart G of this part, the definition of the term “Group 1 wastewater stream” in §63.1361 shall apply for both new sources and existing sources for the purposes of this subpart.

(9) The requirements in §§63.132 through 63.147 for compounds listed on Table 8 of subpart G of this part shall not apply for the purposes of this subpart.

(10) When the total load of Table 9 compounds in the sum of all process wastewater from PAI process units at a new affected source is 2,100 Mg/yr (2,300 tons/yr) or more, the owner or operator shall reduce, by removal or destruction, the mass flow rate of all compounds in Table 9 of subpart G of this part in all wastewater (process and maintenance wastewater) by 99 percent or more. Alternatively, the owner or operator may treat the wastewater in a unit identified in and complying with §63.138(h) of subpart G of this part. The removal/destruction efficiency shall be determined by the procedures specified in §63.145(c) of subpart G of this part, for noncombustion processes, or §63.145(d) of subpart G of this part, for combustion processes.

(11) The compliance date for the affected source subject to the provisions of this section is specified in §63.1364.

(12) As an alternative to using Method 18 of 40 CFR part 60, as specified in §§63.139(c)(1)(ii) and 63.145(i)(2), the owner or operator may elect to use Method 25 or Method 25A of 40 CFR part 60, as specified in §63.1365(b).

(13) The requirement to correct outlet concentrations from combustion devices to 3 percent oxygen in §63.139(c)(1)(ii) shall apply only if supplemental gases are combined with affected vent streams, and the procedures in §63.1365(a)(7)(i) apply instead of the procedures in §63.145(i)(6) to determine the percent oxygen correction. If emissions are controlled with a vapor recovery system as specified in §63.139(c)(2), the owner or operator must correct for supplemental gases as specified in §63.1365(a)(7)(ii).

(14) As an alternative to the management and treatment options specified in §63.132(g)(2), any Group 1 wastewater stream (or residual removed from a Group 1 wastewater stream) that contains less than 50 ppmw of HAP listed in Table 2 to subpart GGG of this part may be transferred offsite or to an on-site treatment operation not owned or operated by the owner or operator of the source generating the wastewater (or residual) if the transferee manages and treats the wastewater stream or residual in accordance with paragraphs (d)(14)(i) through (iv) of this section.

(i) Treat the wastewater stream or residual in a biological treatment unit in accordance with §§63.138 and 63.145.

(ii) Cover the waste management units up to the activated sludge unit. Alternatively, covers are not required if the owner or operator demonstrates that less than 5 percent of the total HAP listed in Table 3 to subpart GGG of this part is emitted.

(iii) Inspect covers as specified in §63.1366(h).

(iv) The reference in §63.132(g)(2) to “§63.102(b) of subpart F” does not apply for the purposes of this subpart.

(15) When §63.133 refers to Table 10 to subpart G of this part, the maximum true vapor pressures in the table shall be limited to the HAP listed in Table 9 to subpart G of this part.

(16) When the inspection, recordkeeping, and reporting requirements contained in §63.148 are referred to in §§63.132 through 63.147, the inspection requirements in §63.1366(h), the recordkeeping requirements in §63.1367(f), and the reporting requirements in §63.1368(g)(2)(iii) and (xi) shall apply for the purposes of this subpart.

(e) *Bag dumps and product dryers.* (1) The owner or operator shall reduce particulate matter emissions to a concentration not to exceed 0.01 gr/dscf from product dryers that dry a PAI or integral intermediate that is a HAP.

(2) The owner or operator shall reduce particulate matter emissions to a concentration not to exceed 0.01 gr/dscf from bag dumps that introduce to a PAI process unit a feedstock that is a solid material and a HAP, excluding bag dumps where the feedstock contains HAP only as impurities.

(3) Gaseous HAP emissions from product dryers and bag dumps shall be controlled in accordance with the provisions for process vent emissions in paragraph (b) of this section.

(f) *Heat exchange systems.* Unless one or more of the conditions specified in §63.104(a)(1) through (6) of subpart F of this part are met, an owner or operator shall monitor each heat exchange system that is used to cool process equipment in PAI process units that are part of an affected source as defined in §63.1360(a) according to the provisions in either §63.104(b) or (c) of subpart F of this part. When the term “chemical manufacturing process unit” is used in §63.104(c) of subpart F of this part, the term “PAI process unit” shall apply for the purposes of this subpart. Whenever a leak is detected, the owner or operator shall comply with the requirements in §63.104(d) of subpart F of this part. Delay of repair of heat exchange systems for which leaks have been detected is allowed in accordance with the provisions of §63.104(e) of subpart F of this part.

(g) *Pollution prevention alternative.* Except as provided in paragraph (g)(1) of this section, for a process that has an initial startup before November 10, 1997, an owner or operator may choose to meet the pollution prevention alternative requirement specified in either paragraph (g)(2) or (3) of this section for any PAI process unit, in lieu of the requirements specified in paragraphs (b), (c), (d), and (e) of this section and in §63.1363. Compliance with the requirements of paragraphs (g)(2) and (3) of this section shall be demonstrated through the procedures in §§63.1365(g) and 63.1366(f).

(1) A HAP must be controlled according to the requirements of paragraphs (b), (c), (d), and (e) of this section and §63.1363 if it is generated in the PAI process unit or an associated control device and it is not part of the production-indexed HAP consumption factor (HAP factor).

(2) The HAP factor shall be reduced by at least 85 percent from a 3-year average baseline beginning no earlier than the 1987 through 1989 calendar years. Alternatively, for a process that has been operating for less than 3 years but more than 1 year, the baseline factor may be calculated for the time period from startup of the process until the present. For any reduction in the HAP factor achieved by reducing a HAP that is also a VOC, an equivalent reduction in the production-indexed VOC consumption factor (VOC factor) is also required (the equivalence is determined on a mass basis, not a percentage basis). For any reduction in the HAP factor that is achieved by reducing a HAP that is not a VOC, the VOC factor may not be increased.

(3) As an alternative to the provisions in paragraph (g)(2) of this section, the owner or operator may combine pollution prevention with emissions control as specified in paragraphs (g)(3)(i) and (ii) of this section.

(i) The HAP factor shall be reduced as specified in paragraph (g)(2) of this section except that a reduction of at least 50 percent shall apply for the purposes of this paragraph.

(ii) The total annual HAP emissions from the PAI process unit shall be reduced by an amount that, when divided by the annual production rate and added to the reduction of the HAP factor yields a value of at least 85 percent of the baseline HAP factor. The total annual VOC emissions from the process unit must be reduced by an amount equivalent to the reduction in HAP emissions for each HAP that is a VOC (the equivalence is determined on a mass basis). For HAP emissions reductions that are achieved by reducing a HAP that is not a VOC, the total annual VOC emissions may not be increased. The reduction in HAP air emissions must be achieved using one of the following control devices:

(A) Combustion control devices such as incinerators, flares, or process heaters.

(B) Control devices such as condensers and carbon adsorbers whose recovered product is destroyed or shipped offsite for destruction.

(C) Any control device that does not ultimately allow for recycling of material back to the PAI process unit.

(D) Any control device for which the owner or operator can demonstrate that the use of the device in controlling HAP emissions will have no effect on the HAP factor for the PAI process unit.

(h) *Emissions averaging provisions.* Except as provided in paragraphs (h)(1) through (7) of this section, the owner or operator of an existing affected facility may choose to comply with the emission standards in paragraphs (b), (c), and (d) of this section by using emissions averaging procedures specified in §63.1365(h) for organic HAP emissions from any storage vessel, process, or waste management unit that is part of an affected source subject to this subpart.

(1) A State may restrict the owner or operator of an existing source to use only the procedures in paragraphs (b), (c), and (d) of this section to comply with the emission standards where State authorities prohibit averaging of HAP emissions.

(2) Group 1 emission points that are controlled as specified in paragraphs (h)(2)(i) through (iii) of this section may not be used to calculate emissions averaging credits, unless the equipment is approved for use in a different manner from that specified in paragraphs (b) through (d) of this section, and a nominal efficiency has been assigned according to the procedures in §63.150(i). The nominal efficiency must exceed the percent reduction required by paragraphs (b) and (c) of this section for process vents and storage vessels, respectively, exceed the percent reduction required in §63.139(c) for control devices used to control emissions vented from waste management units, and exceed the percent reduction required in §63.138(e) or (f) for wastewater treatment processes.

(i) Storage vessels controlled with an internal floating roof meeting the specifications of §63.119(b), an external floating roof meeting the specifications of §63.119(c), or an external floating roof converted to an internal floating meeting the specifications of §63.119(d).

(ii) Emission points controlled with a flare.

(iii) Wastewater streams that are managed in waste management units that are controlled as specified in §§63.133 through 63.137, treated using a steam stripper meeting the specifications of §63.138(d), and emissions from the steam stripper are controlled in a control device that meets the percent reduction requirements specified in §63.139(c).

(3) Process vents and storage vessels controlled with a control device to an outlet concentration of 20 ppmv or 50 ppmv, as specified in paragraph (b)(2)(iv)(A), (b)(3)(ii), (b)(6), (c)(2)(iv)(B), or (c)(4) of this section, and wastewater streams controlled in a treatment unit to an outlet concentration of 50 ppmw, may not be used in any averaging group.

(4) Maintenance wastewater streams, wastewater streams treated in biological treatment units, and Group 2 wastewater streams that are not managed as specified in §§63.133 through 63.137 may not be included in any averaging group.

(5) Processes which have been permanently shut down and storage vessels permanently taken out of HAP service may not be included in any averaging group.

(6) Emission points already controlled on or before November 15, 1990 may not be used to generate emissions averaging credits, unless the level of control has been increased after November 15, 1990. In these cases, credit will be allowed only for the increase in control after November 15, 1990.

(7) Emission points controlled to comply with a State or Federal rule other than this subpart may not be included in an emissions averaging group, unless the level of control has been increased after November 15, 1990, above what is required by the other State or Federal rule. Only the control above what is required by the other State or Federal rule will be credited. However, if an emission point has been used to generate emissions averaging credit in an approved emissions average, and the point is subsequently made subject to a State or Federal rule other than this subpart, the point can continue to generate emissions averaging credit for the purpose of complying with the previously approved average.

(i) *Opening of a safety device.* The owner or operator that opens a safety device, as defined in §63.1361, is not exempt from applicable standards in order to avoid unsafe conditions. If opening a safety device results in the failure to meet any applicable standard, the owner or operator must still comply with the general duty to minimize emissions. If opening a safety device results in a deviation or excess emissions, such events must be reported as specified in §63.1368(i). If the owner or operator attributes the event to a malfunction and intends to assert an affirmative defense, the owner or operator is subject to §63.1360(k).

(j) *Closed-vent systems.* The owner or operator of a closed-vent system that contains bypass lines that could divert a vent stream away from a control device used to comply with the requirements in paragraphs (b) through (d) of this section shall comply with the requirements of Table 3 of this subpart and paragraph (j)(1) or (2) of this section. Equipment such as low leg drains, high point bleeds, analyzer vents, open-ended valves or lines, rupture disks and pressure relief valves needed for safety purposes are not subject to this paragraph.

(1) Install, calibrate, maintain, and operate a flow indicator that is capable of determining whether vent stream flow is present and taking frequent, periodic readings. Records shall be maintained as specified in §63.1367(f)(1). The flow indicator shall be installed at the entrance to any bypass line that could divert the vent stream away from the control device to the atmosphere; or

(2) Secure the bypass line valve in the closed position with a car-seal or lock-and-key type configuration. Records shall be maintained as specified in §63.1367(f)(2).

(k) *Control requirements for certain liquid streams in open systems within a PAI process unit.* (1) The owner or operator shall comply with the provisions of Table 4 of this subpart, for each item of equipment meeting all the criteria specified in paragraphs (k)(2) through (4) of this section and either paragraph (k)(5)(i) or (ii) of this section.

(2) The item of equipment is of a type identified in Table 4 of this subpart;

(3) The item of equipment is part of a PAI process unit as defined in §63.1361;

(4) The item of equipment is controlled less stringently than in Table 4 of this subpart, and the item of equipment is not otherwise exempt from controls by the provisions of this subpart or subpart A of this part;

(5) The item of equipment:

(i) Is a drain, drain hub, manhole, lift station, trench, pipe, or oil/water separator that conveys water with a total annual average concentration greater than or equal to 10,000 ppm by weight of compounds in Table 9 of subpart G of this part at any flowrate; or a total annual average concentration greater than or equal to 1,000 ppm by weight of compounds in Table 9 of subpart G of this part at an annual average flow rate greater than or equal to 10 liters per minute; or

(ii) Is a tank that receives one or more streams that contain water with a total annual average concentration greater than or equal to 1,000 ppm by weight of compounds in Table 9 of subpart G of this part at an annual average flowrate greater than or equal to 10 liters per minute. The owner or operator of the source shall determine the characteristics of the stream as specified in paragraphs (k)(5)(ii)(A) and (B) of this section.

(A) The characteristics of the stream being received shall be determined at the inlet to the tank.

(B) The characteristics shall be determined according to the procedures in §63.144(b) and (c) of subpart G of this part.

(l) *Exemption for RCRA treatment units.* An owner or operator shall be exempt from the initial compliance demonstrations and monitoring provisions in §§63.1365 and 63.1366 and the associated recordkeeping and reporting requirements in §§63.1367 and 63.1368 for emissions from process vents, storage vessels, and waste management units that are discharged to the following devices:

(1) A boiler or process heater burning hazardous waste for which the owner or operator:

(i) Has been issued a final permit under 40 CFR part 270 and complies with the requirements of 40 CFR part 266, subpart H; or

(ii) Has certified compliance with the interim status requirements of 40 CFR part 266, subpart H.

(2) A hazardous waste incinerator for which the owner or operator has been issued a final permit under 40 CFR part 270 and complies with the requirements of 40 CFR part 264, subpart O, or has certified compliance with the interim status requirements of 40 CFR part 265, subpart O.

[64 FR 33589, June 23, 1999, as amended at 67 FR 59343, Sept. 20, 2002; 68 FR 37358, June 23, 2003; 79 FR 17372, Mar. 27, 2014]

[↑ Back to Top](#)

**§63.1363 Standards for equipment leaks.**

(a) *General equipment leak requirements.* (1) The provisions of this section apply to “equipment” as defined in §63.1361. The provisions of this section also apply to any closed-vent systems and control devices required by this section.

(2) *Consistency with other regulations.* After the compliance date for a process, equipment subject to both this section and either of the following will be required to comply only with the provisions of this subpart:

(i) 40 CFR part 60.

(ii) 40 CFR part 61.

(3) [Reserved]

(4) The provisions in §63.1(a)(3) of subpart A of this part do not alter the provisions in paragraph (a)(2) of this section.

(5) Lines and equipment not containing process fluids are not subject to the provisions of this section. Utilities, and other nonprocess lines, such as heating and cooling systems which do not combine their materials with those in the processes they serve, are not considered to be part of a process.

(6) The provisions of this section do not apply to bench-scale processes, regardless of whether the processes are located at the same plant site as a process subject to the provisions of this subpart MMM.

(7) Each piece of equipment to which this section applies shall be identified such that it can be distinguished readily from equipment that is not subject to this section. Identification of the equipment does not require physical tagging of the equipment. For example, the equipment may be identified on a plant site plan, in log entries, or by designation of process boundaries by some form of weatherproof identification. If changes are made to the affected source subject to the leak detection requirements, equipment identification for each type of component shall be updated, if needed, within 15 calendar days of the end of each monitoring period for that component.

(8) Equipment that is in vacuum service is excluded from the requirements of this section.

(9) Equipment that is in organic HAP service, but is in such service less than 300 hours per calendar year, is excluded from the requirements of this section if it is identified as required in paragraph (g)(9) of this section.

(10) When each leak is detected by visual, audible, or olfactory means, or by monitoring as described in §63.180(b) or (c) of subpart H of this part, the following requirements apply:

(i) A weatherproof and readily visible identification, marked with the equipment identification number, shall be attached to the leaking equipment.

(ii) The identification on a valve in light liquid or gas/vapor service may be removed after it has been monitored as specified in paragraph (e)(7)(iii) of this section, and no leak has been detected during the follow-up monitoring. If an owner or operator elects to comply with §63.174(c)(1)(i), the identification on a connector may be removed after it has been monitored as specified in §63.174(c)(1)(i) and no leak is detected during that monitoring.



(iii) The identification on equipment, except as specified in paragraph (a)(10)(ii) of this section, may be removed after it has been repaired.

(b) *References.* The owner or operator shall comply with the provisions of subpart H of this part as specified in paragraphs (b)(1) through (3) of this section and with paragraph (b)(4) of this section for pressure relief devices. When the term “process unit” is used in subpart H of this part, it shall mean any group of processes for the purposes of this subpart. Groups of processes as used in this subpart may be any individual process or combination of processes.

(1) Sections 63.160, 63.161, 63.162, 63.163, 63.167, 63.168, 63.170, 63.173, 63.175, 63.176, 63.181, and 63.182 of subpart H of this part shall not apply for the purposes of this subpart MMM. The owner or operator shall comply with the provisions specified in paragraphs (b)(1)(i) through (viii) of this section.

(i) Sections 63.160 and 63.162 of subpart H of this part shall not apply, instead the owner or operator shall comply with paragraph (a) of this section;

(ii) Section 63.161 of subpart H of this part shall not apply, instead the owner or operator shall comply with §63.1361;

(iii) Sections 63.163 and 63.173 of subpart H of this part shall not apply, instead the owner or operator shall comply with paragraph (c) of this section;

(iv) Section 63.167 of subpart H of this part shall not apply, instead the owner or operator shall comply with paragraph (d) of this section;

(v) Section 63.168 of subpart H of this part shall not apply, instead the owner or operator shall comply with paragraph (e) of this section;

(vi) Section 63.170 of subpart H of this part shall not apply, instead the owner or operator shall comply with §63.1362(b);

(vii) Section 63.181 of subpart H of this part shall not apply, instead the owner or operator shall comply with paragraph (g) of this section; and

(viii) Section 63.182 of subpart H of this part shall not apply, instead the owner or operator shall comply with paragraph (h) of this section.

(2) The owner or operator shall comply with §§63.164, 63.166, 63.169, 63.177, and 63.179 of subpart H of this part in their entirety, except that when these sections reference other sections of subpart H of this part, the owner or operator shall comply with the revised sections as specified in paragraphs (b)(1), (3), and (4) of this section. Section 63.164 of subpart H of this part applies to compressors. Section 63.166 of subpart H of this part applies to sampling connection systems. Section 63.169 of subpart H of this part applies to: pumps, valves, connectors, and agitators in heavy liquid service; instrumentation systems; and pressure relief devices in liquid service. Section 63.177 of subpart H of this subpart applies to general alternative means of emission limitation. Section 63.179 of subpart H of this part applies to alternative means of emission limitation for enclosed-vented process units.

(3) The owner or operator shall comply with §§63.171, 63.172, 63.174, 63.178, and 63.180 of subpart H of this part with the differences specified in paragraphs (b)(3)(i) through (v) of this section.

(i) Section 63.171, Delay of repair, shall apply except §63.171(a) shall not apply. Delay of repair of equipment for which leaks have been detected is allowed if one of the following conditions exist:

(A) The repair is technically infeasible without a process shutdown. Repair of this equipment shall occur by the end of the next scheduled process shutdown.

(B) The owner or operator determines that repair personnel would be exposed to an immediate danger if attempting to repair without a process shutdown. Repair of this equipment shall occur by the end of the next scheduled process shutdown.

(ii) Section 63.172, Closed-vent systems and control devices, shall apply for closed-vent systems used to comply with this section, and for control devices used to comply with this section only, except:

(A) Section 63.172(k) and (l) shall not apply. The owner or operator shall instead comply with paragraph (f) of this section.

(B) Owners or operators may, instead of complying with the provisions of §63.172(f), design a closed-vent system to operate at a pressure below atmospheric pressure. The system shall be equipped with at least one pressure gauge or other pressure measurement device that can be read from a readily accessible location to verify that negative pressure is being maintained in the closed-vent system when the associated control device is operating.

(iii) Section 63.174, Connectors, shall apply except:

(A) Section 63.174(b), (f), (g), and (h) shall not apply. In place of §63.174(b), the owner or operator shall comply with paragraphs (b)(3)(iii)(C) through (G) of this section. In place of §63.174(f), (g), and (h), the owner or operator shall comply with paragraph (f) of this section.

(B) Days that the connectors are not in organic HAP service shall not be considered part of the 3-month period in §63.174(c).

(C) If the percent leaking connectors in a group of processes was greater than or equal to 0.5 percent during the initial monitoring period, monitoring shall be performed once per year until the percent leaking connectors is less than 0.5 percent.

(D) If the percent leaking connectors in the group of processes was less than 0.5 percent, but equal to or greater than 0.25 percent, during the last required monitoring period, monitoring shall be performed once every 4 years. An owner or operator may comply with the requirements of this paragraph by monitoring at least 40 percent of the connectors in the first 2 years and the remainder of the connectors within the next 2 years. The percent leaking connectors will be calculated for the total of all monitoring performed during the 4-year period.

(E) The owner or operator shall increase the monitoring frequency to once every 2 years for the next monitoring period if leaking connectors comprise at least 0.5 percent but less than 1.0 percent of the connectors monitored within either the 4 years specified in paragraph (b)(3)(iii)(D) of this section, the

first 4 years specified in paragraph (b)(3)(iii)(G) of this section, or the entire 8 years specified in paragraph (b)(3)(iii)(G) of this section. At the end of that 2-year monitoring period, the owner or operator shall monitor once per year while the percent leaking connectors is greater than or equal to 0.5 percent; if the percent leaking connectors is less than 0.5 percent, the owner or operator may again elect to monitor in accordance with paragraph (b)(3)(iii)(D) or (G) of this section, as applicable.

(F) If an owner or operator complying with the requirements of paragraph (b)(3)(iii)(D) or (G) of this section for a group of processes determines that 1 percent or greater of the connectors are leaking, the owner or operator shall increase the monitoring frequency to one time per year. The owner or operator may again elect to use the provisions of paragraph (b)(3)(iii)(D) or (G) of this section after a monitoring period in which less than 0.5 percent of the connectors are determined to be leaking.

(G) Monitoring shall be required once every 8 years, if the percent leaking connectors in the group of process units was less than 0.25 percent during the last required monitoring period. An owner or operator shall monitor at least 50 percent of the connectors in the first 4 years and the remainder of the connectors within the next 4 years. If the percent leaking connectors in the first 4 years is equal to or greater than 0.35 percent, the monitoring program shall revert at that time to the appropriate monitoring frequency specified in paragraph (b)(3)(iii)(D), (E), or (F) of this section.

(iv) Section 63.178, shall apply, except as specified in paragraphs (b)(3)(iv)(A) and (B) of this section.

(A) Section 63.178(b), requirements for pressure testing, shall apply to all processes, not just batch processes.

(B) For pumps, the phrase “at the frequencies specified in Table 1 of this subpart” in §63.178(c)(3)(iii) shall mean “quarterly” for the purposes of this subpart.

(v) Section 63.180 of subpart H of this part, Test methods and procedures, shall apply except §63.180(b)(4)(ii)(A) through (C) of subpart H of this part shall not apply. Calibration gases shall be a mixture of methane and air at a concentration of approximately, but less than, 10,000 parts per million methane for agitators, 2,000 parts per million for pumps, and 500 parts per million for all other equipment, except as provided in §63.180(b)(4)(iii) of subpart H of this part.

(4) *Requirements for pressure relief devices.* Except as specified in paragraph (b)(4)(iv) of this section, the owner or operator must comply with the operating and pressure release requirements specified in paragraphs (b)(4)(i) and (ii) of this section for pressure relief devices in organic HAP gas or vapor service. Except as specified in paragraph (b)(4)(iv) of this section, the owner or operator must also comply with the pressure release management requirements specified in paragraph (b)(4)(iii) of this section for all pressure relief devices in organic HAP service.

(i) *Operating requirements.* Except during a pressure release event, operate each pressure relief device in organic HAP gas or vapor service with an instrument reading of less than 500 ppm above background as detected by Method 21 of 40 CFR part 60, appendix A.

(ii) *Pressure release requirements.* For pressure relief devices in organic HAP gas or vapor service, comply with paragraphs (b)(4)(ii)(A) or (B) of this section, as applicable.

(A) If the pressure relief device does not consist of or include a rupture disk, conduct instrument monitoring, as detected by Method 21 of 40 CFR part 60, appendix A, no later than 5 calendar days after the pressure release to verify that the pressure relief device is operating with an instrument reading of less than 500 ppm above background, except as provided in §63.171.

(B) If the pressure relief device consists of or includes a rupture disk, install a replacement disk as soon as practicable after a pressure release, but no later than 5 calendar days after the pressure release, except as provided in §63.171.

(iii) *Pressure release management.* Except as specified in paragraph (b)(4)(iv) of this section, pressure releases to the atmosphere from pressure relief devices in organic HAP service are prohibited, and the owner or operator must comply with the requirements specified in paragraphs (b)(4)(iii)(A) and (B) of this section for all pressure relief devices in organic HAP service.

(A) For each pressure relief device in organic HAP service, the owner or operator must equip each pressure relief device with a device(s) or use a monitoring system that is capable of:

(1) Identifying the pressure release;

(2) Recording the time and duration of each pressure release; and

(3) Notifying operators immediately that a pressure release is occurring. The device or monitoring system may be either specific to the pressure relief device itself or may be associated with the process system or piping, sufficient to indicate a pressure release to the atmosphere. Examples of these types of devices and systems include, but are not limited to, a rupture disk indicator, magnetic sensor, motion detector on the pressure relief valve stem, flow monitor, or pressure monitor.

(B) If any pressure relief device in organic HAP service releases to atmosphere as a result of a pressure release event, the owner or operator must calculate the quantity of organic HAP released during each pressure release event and report this quantity as required in paragraph (h)(3)(v) of this section. Calculations may be based on data from the pressure relief device monitoring alone or in combination with process parameter monitoring data and process knowledge.

(iv) *Pressure relief devices routed to a control device, process, or drain system.* If a pressure relief device in organic HAP service is designed and operated to route all pressure releases through a closed vent system to a control device, process, or drain system, the owner or operator is not required to comply with paragraphs (b)(4)(i), (ii), or (iii) (if applicable) of this section. Both the closed vent system and control device (if applicable) must meet the requirements of §63.172. The drain system (if applicable) must meet the requirements of §63.136.

(c) *Standards for pumps in light liquid service and agitators in gas/vapor service and in light liquid service.* (1) The provisions of this section apply to each pump that is in light liquid service, and to each agitator in gas/vapor service or in light liquid service.

(2)(i) *Monitoring.* Each pump and agitator subject to this section shall be monitored quarterly to detect leaks by the method specified in §63.180(b), except as provided in §§63.177, 63.178, paragraph (f) of this section, and paragraphs (c)(5) through (9) of this section.

(ii) *Leak definition.* The instrument reading, as determined by the method as specified in §63.180(b) of subpart H of this part, that defines a leak is:

(A) For agitators, an instrument reading of 10,000 parts per million or greater.

(B) For pumps, an instrument reading of 2,000 parts per million or greater.

(iii) *Visual inspections.* Each pump and agitator shall be checked by visual inspection each calendar week for indications of liquids dripping from the pump or agitator seal. If there are indications of liquids dripping from the seal at the time of the weekly inspection, the owner or operator shall follow the procedure specified in either paragraph (c)(2)(iii)(A) or (B) of this section prior to the next weekly inspection.

(A) The owner or operator shall monitor the pump or agitator by the method specified in §63.180(b). If the instrument reading indicates a leak as specified in paragraph (c)(2)(ii) of this section, a leak is detected.

(B) The owner or operator shall eliminate the visual indications of liquids dripping.

(3) *Repair provisions.* (i) When a leak is detected pursuant to paragraph (c)(2)(i), (c)(2)(iii)(A), (c)(5)(iv)(A), or (c)(5)(vi)(B) of this section, it shall be repaired as soon as practicable, but not later than 15 calendar days after it is detected, except as provided in paragraph (b)(3)(i) of this section.

(ii) A first attempt at repair shall be made no later than 5 calendar days after the leak is detected. First attempts at repair include, but are not limited to, the following practices where practicable:

(A) Tightening of packing gland nuts.

(B) Ensuring that the seal flush is operating at design pressure and temperature.

(4) *Calculation of percent leakers.* (i) The owner or operator shall decide no later than the end of the first monitoring period what groups of processes will be developed. Once the owner or operator has decided, all subsequent percent calculations shall be made on the same basis.

(ii) If, calculated on a 1-year rolling average, 10 percent or more of the pumps in a group of processes (or 3 pumps in a group of processes with fewer than 30 pumps) leak, the owner or operator shall monitor each pump once per month, until the calculated 1-year rolling average value drops below 10 percent (or three pumps in a group of processes with fewer than 30 pumps).

(iii) The number of pumps in a group of processes shall be the sum of all the pumps in organic HAP service, except that pumps found leaking in a continuous process within 1 quarter after startup of the pump shall not count in the percent leaking pumps calculation for that one monitoring period only.

(iv) Percent leaking pumps shall be determined using Equation 3 of this subpart:

$$\%P_L = \left[ \frac{(P_L - P_g)}{(P_T - P_g)} \right] \times 100 \quad (\text{Eq. 3})$$

[View or download PDF](#)

Where:

$\%P_L$  = percent leaking pumps

$P_L$  = number of pumps found leaking as determined through quarterly monitoring as required in paragraphs (c)(2)(i) and (ii) of this section.

$P_T$  = total pumps in organic HAP service, including those meeting the criteria in paragraphs (c)(5) and (6) of this section

$P_S$  = number of pumps in a continuous process leaking within 1 quarter of startup during the current monitoring period

(5) *Exemptions.* Each pump or agitator equipped with a dual mechanical seal system that includes a barrier fluid system and meets the requirements specified in paragraphs (c)(5)(i) through (vii) is exempt from the requirements of paragraphs (c)(1) through (c)(4)(iii) of this section, except as specified in paragraphs (c)(5)(iv)(A) and (vii) of this section.

(i) Each dual mechanical seal system is:

(A) Operated with the barrier fluid at a pressure that is at all times greater than the pump/agitator stuffing box pressure; or

(B) Equipped with a barrier fluid degassing reservoir that is connected by a closed-vent system to a control device that complies with the requirements of paragraph (b)(3)(ii) of this section; or

(C) Equipped with a closed-loop system that purges the barrier fluid into a process stream.

(ii) The barrier fluid is not in light liquid service.

(iii) Each barrier fluid system is equipped with a sensor that will detect failure of the seal system, the barrier fluid system, or both.

(iv) Each pump/agitator is checked by visual inspection each calendar week for indications of liquids dripping from the pump/agitator seal. If there are indications of liquids dripping from the pump or agitator seal at the time of the weekly inspection, the owner or operator shall follow the procedures specified in either paragraph (c)(5)(iv)(A) or (B) of this section prior to the next required inspection.

(A) The owner or operator shall monitor the pump or agitator using the method specified in §63.180(b) to determine if there is a leak of organic HAP in the barrier fluid. If the instrument reading indicates a leak, as specified in paragraph (c)(2)(ii) of this section, a leak is detected.

(B) The owner or operator shall eliminate the visual indications of liquids dripping.

(v) Each sensor as described in paragraph (c)(5)(iii) of this section is observed daily or is equipped with an alarm unless the pump is located within the boundary of an unmanned plant site.

(vi)(A) The owner or operator determines, based on design considerations and operating experience, criteria applicable to the presence and frequency of drips and to the sensor that indicate failure of the seal system, the barrier fluid system, or both.

(B) If indications of liquids dripping from the pump/agitator seal exceed the criteria established in paragraph (c)(5)(vi)(A) of this section, or if, based on the criteria established in paragraph (c)(5)(vi)(A) of this section, the sensor indicates failure of the seal system, the barrier fluid system, or both, a leak is detected.

(vii) When a leak is detected pursuant to paragraph (c)(5)(iv)(A) or (vi)(B) of this section, the leak must be repaired as specified in paragraph (c)(3) of this section.

(6) Any pump/agitator that is designed with no externally actuated shaft penetrating the pump/agitator housing is exempt from the requirements of paragraphs (c)(1) through (3) of this section.

(7) Any pump/agitator equipped with a closed-vent system capable of capturing and transporting any leakage from the seal or seals back to the process or to a control device that complies with the requirements of paragraph (b)(3)(ii) of this section is exempt from the requirements of paragraphs (c)(2) through (5) of this section.

(8) Any pump/agitator that is located within the boundary of an unmanned plant site is exempt from the weekly visual inspection requirement of paragraphs (c)(2)(iii) and (c)(5)(iv) of this section, and the daily requirements of paragraph (c)(5)(v) of this section, provided that each pump/agitator is visually inspected as often as practicable and at least monthly.

(9) If more than 90 percent of the pumps in a group of processes meet the criteria in either paragraph (c)(5) or (6) of this section, the group of processes is exempt from the requirements of paragraph (c)(4) of this section.

(d) *Standards: open-ended valves or lines.* (1)(i) Each open-ended valve or line shall be equipped with a cap, blind flange, plug, or a second valve, except as provided in §63.177 of subpart H of this part and paragraphs (d)(4) through (6) of this section.

(ii) The cap, blind flange, plug, or second valve shall seal the open end at all times except during operations requiring process fluid flow through the open-ended valve or line, or during maintenance or repair. The cap, blind flange, plug, or second valve shall be in place within 1 hour of cessation of operations requiring process fluid flow through the open-ended valve or line, or within 1 hour of cessation of maintenance or repair.

(2) Each open-ended valve or line equipped with a second valve shall be operated in a manner such that the valve on the process fluid end is closed before the second valve is closed.

(3) When a double block and bleed system is being used, the bleed valve or line may remain open during operations that require venting the line between the block valves but shall comply with paragraph (d)(1) of this section at all other times.

(4) Open-ended valves or lines in an emergency shutdown system which are designed to open automatically in the event of a process upset are exempt from the requirements of paragraphs (d)(1) through (3) of this section.

(5) Open-ended valves or lines containing materials which would autocatalytically polymerize are exempt from the requirements of paragraphs (d)(1) through (3) of this section.

(6) Open-ended valves or lines containing materials which could cause an explosion, serious overpressure, or other safety hazard if capped or equipped with a double block and bleed system as specified in paragraphs (d)(1) through (3) of this section are exempt from the requirements of paragraphs (d)(1) through (3) of this section.

(e) *Standards: valves in gas/vapor service and in light liquid service.* (1) The provisions of this section apply to valves that are either in gas/vapor service or in light liquid service.

(2) For existing and new affected sources, all valves subject to this section shall be monitored, except as provided in paragraph (f) of this section and in §63.177 of subpart H of this part, by no later than 1 year after the compliance date.

(3) *Monitoring.* The owner or operator of a source subject to this section shall monitor all valves, except as provided in paragraph (f) of this section and in §63.177 of subpart H of this part, at the intervals specified in paragraph (e)(4) of this section and shall comply with all other provisions of this section, except as provided in paragraph (b)(3)(i) of this section and §§63.178 and 63.179 of subpart H of this part.

(i) The valves shall be monitored to detect leaks by the method specified in §63.180(b) of subpart H of this part.

(ii) An instrument reading of 500 parts per million or greater defines a leak.

(4) *Subsequent monitoring frequencies.* After conducting the initial survey required in paragraph (e)(2) of this section, the owner or operator shall monitor valves for leaks at the intervals specified below:

(i) For a group of processes with 2 percent or greater leaking valves, calculated according to paragraph (e)(6) of this section, the owner or operator shall monitor each valve once per month, except as specified in paragraph (e)(9) of this section.

(ii) For a group of processes with less than 2 percent leaking valves, the owner or operator shall monitor each valve once each quarter, except as provided in paragraphs (e)(4)(iii) through (v) of this section.

(iii) For a group of processes with less than 1 percent leaking valves, the owner or operator may elect to monitor each valve once every 2 quarters.

(iv) For a group of processes with less than 0.5 percent leaking valves, the owner or operator may elect to monitor each valve once every 4 quarters.

(v) For a group of processes with less than 0.25 percent leaking valves, the owner or operator may elect to monitor each valve once every 2 years.



(5) *Calculation of percent leakers.* For a group of processes to which this subpart applies, the owner or operator may choose to subdivide the valves in the applicable group of processes and apply the provisions of paragraph (e)(4) of this section to each subgroup. If the owner or operator elects to subdivide the valves in the applicable group of processes, then the provisions of paragraphs (e)(5)(i) through (viii) of this section apply.

(i) The overall performance of total valves in the applicable group of processes must be less than 2 percent leaking valves, as detected according to paragraphs (e)(3)(i) and (ii) of this section and as calculated according to paragraphs (e)(6)(ii) and (iii) of this section.

(ii) The initial assignment or subsequent reassignment of valves to subgroups shall be governed by the provisions of paragraphs (e)(5)(ii) (A) through (C) of this section.

(A) The owner or operator shall determine which valves are assigned to each subgroup. Valves with less than 1 year of monitoring data or valves not monitored within the last 12 months must be placed initially into the most frequently monitored subgroup until at least 1 year of monitoring data have been obtained.

(B) Any valve or group of valves can be reassigned from a less frequently monitored subgroup to a more frequently monitored subgroup provided that the valves to be reassigned were monitored during the most recent monitoring period for the less frequently monitored subgroup. The monitoring results must be included with the less frequently monitored subgroup's monitoring event and associated next percent leaking valves calculation for that group.

(C) Any valve or group of valves can be reassigned from a more frequently monitored subgroup to a less frequently monitored subgroup provided that the valves to be reassigned have not leaked for the period of the less frequently monitored subgroup (e.g., for the last 12 months, if the valve or group of valves is to be reassigned to a subgroup being monitored annually). Nonrepairable valves may not be reassigned to a less frequently monitored subgroup.

(iii) The owner or operator shall determine every 6 months if the overall performance of total valves in the applicable group of processes is less than 2 percent leaking valves and so indicate the performance in the next Periodic report. If the overall performance of total valves in the applicable group of processes is 2 percent leaking valves or greater, the owner or operator shall revert to the program required in paragraphs (e)(2) through (4) of this section. The overall performance of total valves in the applicable group of processes shall be calculated as a weighted average of the percent leaking valves of each subgroup according to Equation 4 of this subpart:

$$\%V_{LO} = \frac{\sum_{i=1}^n (\%V_{Li} \times V_i)}{\sum_{i=1}^n V_i} \quad (\text{Eq. 4})$$

[View or download PDF](#)

Where:

$\%V_{LO}$  = overall performance of total valves in the applicable group of processes

$\%V_{Li}$  = percent leaking valves in subgroup i, most recent value calculated according to the procedures in paragraphs (e)(6)(ii) and (iii) of this section

$V_i$  = number of valves in subgroup i

n = number of subgroups

(iv) *Records.* In addition to records required by paragraph (g) of this section, the owner or operator shall maintain records specified in paragraphs (e)(5)(iv)(A) through (D) of this section.

(A) Which valves are assigned to each subgroup,

(B) Monitoring results and calculations made for each subgroup for each monitoring period,

(C) Which valves are reassigned and when they were reassigned, and

(D) The results of the semiannual overall performance calculation required in paragraph (e)(5)(iii) of this section.

(v) The owner or operator shall notify the Administrator no later than 30 days prior to the beginning of the next monitoring period of the decision to subgroup valves. The notification shall identify the participating processes and the valves assigned to each subgroup.

(vi) *Semiannual reports.* In addition to the information required by paragraph (h)(3) of this section, the owner or operator shall submit in the Periodic reports the information specified in paragraphs (e)(5)(vi)(A) and (B) of this section.

(A) Valve reassignments occurring during the reporting period, and

(B) Results of the semiannual overall performance calculation required by paragraph (e)(5)(iii) of this section.

(vii) To determine the monitoring frequency for each subgroup, the calculation procedures of paragraph (e)(6)(iii) of this section shall be used.

(viii) Except for the overall performance calculations required by paragraphs (e)(5)(i) and (iii) of this section, each subgroup shall be treated as if it were a process for the purposes of applying the provisions of this section.

(6)(i) The owner or operator shall decide no later than the implementation date of this subpart or upon revision of an operating permit how to group the processes. Once the owner or operator has decided, all subsequent percentage calculations shall be made on the same basis.

(ii) Percent leaking valves for each group of processes or subgroup shall be determined using Equation 5 of this subpart:

$$\%V_L = [V_L/V_T] \times 100 \quad (\text{Eq. 5})$$

[View or download PDF](#)

Where:

$\%V_L$  = percent leaking valves

$V_L$  = number of valves found leaking excluding nonrepairables as provided in paragraph (e)(6)(iv)(A) of this section

$V_T$  = total valves monitored, in a monitoring period excluding valves monitored as required by paragraph (e)(7)(iii) of this section

(iii) When determining monitoring frequency for each group of processes or subgroup subject to monthly, quarterly, or semiannual monitoring frequencies, the percent leaking valves shall be the arithmetic average of the percent leaking valves from the last two monitoring periods. When determining monitoring frequency for each group of processes or subgroup subject to annual or biennial (once every 2 years) monitoring frequencies, the percent leaking valves shall be the arithmetic average of the percent leaking valves from the last three monitoring periods.

(iv)(A) Nonrepairable valves shall be included in the calculation of percent leaking valves the first time the valve is identified as leaking and nonrepairable and as required to comply with paragraph (e)(6)(iv)(B) of this section. Otherwise, a number of nonrepairable valves (identified and included in the percent leaking calculation in a previous period) up to a maximum of 1 percent of the total number of valves in organic HAP service at a process may be excluded from calculation of percent leaking valves for subsequent monitoring periods.

(B) If the number of nonrepairable valves exceeds 1 percent of the total number of valves in organic HAP service at a process, the number of nonrepairable valves exceeding 1 percent of the total number of valves in organic HAP service shall be included in the calculation of percent leaking valves.

(7) *Repair provisions.* (i) When a leak is detected, it shall be repaired as soon as practicable, but no later than 15 calendar days after the leak is detected, except as provided in paragraph (b)(3)(i) of this section.

(ii) A first attempt at repair shall be made no later than 5 calendar days after each leak is detected.

(iii) When a leak is repaired, the valve shall be monitored at least once within the first 3 months after its repair. Days that the valve is not in organic HAP service shall not be considered part of this 3-month period. The monitoring required by this paragraph is in addition to the monitoring required to satisfy the definitions of “repaired” and “first attempt at repair.”

(A) The monitoring shall be conducted as specified in §63.180(b) and (c) as appropriate, to determine whether the valve has resumed leaking.

(B) Periodic monitoring required by paragraphs (e)(2) through (4) of this section may be used to satisfy the requirements of paragraph (e)(7)(iii) of this section, if the timing of the monitoring period coincides with the time specified in paragraph (e)(7)(iii) of this section. Alternatively, other monitoring may be performed to satisfy the requirements of paragraph (e)(7)(iii) of this section, regardless of whether the timing of the monitoring period for periodic monitoring coincides with the time specified in paragraph (e)(7)(iii) of this section.

(C) If a leak is detected by monitoring that is conducted pursuant to paragraph (e)(7)(iii) of this section, the owner or operator shall follow the provisions of paragraphs (e)(7)(iii)(C)(1) and (2) of this section to determine whether that valve must be counted as a leaking valve for purposes of paragraph (e)(6) of this section.

(1) If the owner or operator elects to use periodic monitoring required by paragraphs (e)(2) through (4) of this section to satisfy the requirements of paragraph (e)(7)(iii) of this section, then the valve shall be counted as a leaking valve.

(2) If the owner or operator elects to use other monitoring prior to the periodic monitoring required by paragraphs (e)(2) through (4) of this section to satisfy the requirements of paragraph (e)(7)(iii) of this section, then the valve shall be counted as a leaking valve unless it is repaired and shown by periodic monitoring not to be leaking.

(8) First attempts at repair include, but are not limited to, the following practices where practicable:

(i) Tightening of bonnet bolts,

(ii) Replacement of bonnet bolts,

(iii) Tightening of packing gland nuts, and

(iv) Injection of lubricant into lubricated packing.

(9) Any equipment located at a plant site with fewer than 250 valves in organic HAP service in the affected source is exempt from the requirements for monthly monitoring specified in paragraph (e)(4)(i) of this section. Instead, the owner or operator shall monitor each valve in organic HAP service for leaks once each quarter, or comply with paragraph (e)(4)(iii), (iv), or (v) of this section, except as provided in paragraph (f) of this section.

*(f) Unsafe to monitor, difficult-to-monitor, and inaccessible equipment.* (1) Equipment that is designated as unsafe-to-monitor, difficult-to-monitor, or inaccessible is exempt from the requirements as specified in paragraphs (f)(1)(i) through (iv) of this section provided the owner or operator meets the requirements specified in paragraph (f)(2), (3), or (4) of this section, as applicable. All equipment, except connectors that meet the requirements in paragraph (f)(4) of this section, must be assigned to a group of processes. Ceramic or ceramic-lined connectors are subject to the same requirements as inaccessible connectors.

(i) For pumps and agitators, paragraphs (c)(2), (3), and (4) of this section do not apply.

(ii) For valves, paragraphs (e)(2) through (7) of this section do not apply.

(iii) For connectors, §63.174(b) through (e) and paragraphs (b)(3)(iii)(C) through (G) of this section do not apply.

(iv) For closed-vent systems, §63.172(f)(1), (f)(2), and (g) do not apply.

*(2) Equipment that is unsafe-to-monitor.* (i) Valves, connectors, agitators, and any part of closed-vent systems may be designated as unsafe-to-monitor if the owner or operator determines that monitoring personnel would be exposed to an immediate danger as a consequence of complying with the monitoring

requirements identified in paragraphs (f)(1)(i) through (iii) of this section, or the inspection requirements identified in paragraph (f)(1)(iv) of this section.

(ii) The owner or operator of equipment that is designated as unsafe-to-monitor must have a written plan that requires monitoring of the equipment as frequently as practicable during safe-to-monitor times. For valves, connectors, and agitators, monitoring shall not be more frequent than the periodic monitoring schedule otherwise applicable to the group of processes in which the equipment is located. For closed-vent systems, inspections shall not be more frequent than annually.

(3) *Equipment that is difficult-to-monitor.* (i) A valve, agitator, pump, or any part of a closed-vent system may be designated as difficult-to-monitor if the owner or operator determines that the equipment cannot be monitored or inspected without elevating the monitoring personnel more than 2 meters above a support surface or the equipment is not accessible in a safe manner when it is in organic HAP service;

(ii) At a new affected source, an owner or operator may designate no more than 3 percent of valves as difficult-to-monitor.

(iii) The owner or operator of valves, agitators, or pumps designated as difficult-to-monitor must have a written plan that requires monitoring of the equipment at least once per calendar year or on the periodic monitoring schedule otherwise applicable to the group of processes in which the equipment is located, whichever is less frequent. For any part of a closed-vent system designated as difficult-to-monitor, the owner or operator must have a written plan that requires inspection of the closed-vent system at least once every 5 years.

(4) *Inaccessible, ceramic, or ceramic-lined connectors.* (i) A connector may be designated as inaccessible if it is:

(A) Buried;

(B) Insulated in a manner that prevents access to the equipment by a monitor probe;

(C) Obstructed by equipment or piping that prevents access to the equipment by a monitor probe;

(D) Unable to be reached from a wheeled scissor-lift or hydraulic-type scaffold which would allow access to equipment up to 7.6 meters above the ground; or

(E) Not able to be accessed at any time in a safe manner to perform monitoring. Unsafe access includes, but is not limited to, the use of a wheeled scissor-lift on unstable or uneven terrain, the use of a motorized man-lift basket in areas where an ignition potential exists, or access would require near proximity to hazards such as electrical lines, or would risk damage to equipment.

(F) Would require elevating the monitoring personnel more than 2 meters above a permanent support surface or would require the erection of scaffold.

(ii) At a new affected source, an owner or operator may designate no more than 3 percent of connectors as inaccessible.

(iii) If any inaccessible, ceramic, or ceramic-lined connector is observed by visual, audible, olfactory, or other means to be leaking, the leak shall be repaired as soon as practicable, but no later than 15 calendar days after the leak is detected, except as provided in paragraph (b)(3)(i) of this section.

(iv) Any connector that is inaccessible or that is ceramic or ceramic-lined is exempt from the recordkeeping and reporting requirements of paragraphs (g) and (h) of this section.

(g) *Recordkeeping requirements.* (1) An owner or operator of more than one group of processes subject to the provisions of this section may comply with the recordkeeping requirements for the groups of processes in one recordkeeping system if the system identifies with each record the program being implemented (e.g., quarterly monitoring) for each type of equipment. All records and information required by this section shall be maintained in a manner that can be readily accessed at the plant site. This could include physically locating the records at the plant site or accessing the records from a central location by computer at the plant site.

(2) *General recordkeeping.* Except as provided in paragraph (g)(5) of this section, the following information pertaining to all equipment subject to the requirements in this section shall be recorded:

(i)(A) A list of identification numbers for equipment (except instrumentation systems) subject to the requirements of this section. Connectors, except those subject to paragraph (f) of this section, need not be individually identified if all connectors in a designated area or length of pipe subject to the provisions of this section are identified as a group, and the number of subject connectors is indicated. The list for each type of equipment shall be completed no later than the completion of the initial survey required for that component. The list of identification numbers shall be updated, if needed, to incorporate equipment changes within 15 calendar days of the completion of each monitoring survey for the type of equipment component monitored.

(B) A schedule for monitoring connectors subject to the provisions of §63.174(a) of subpart H of this part and valves subject to the provisions of paragraph (e)(4) of this section.

(C) Physical tagging of the equipment is not required to indicate that it is in organic HAP service. Equipment subject to the provisions of this section may be identified on a plant site plan, in log entries, or by other appropriate methods.

(ii)(A) A list of identification numbers for equipment that the owner or operator elects to equip with a closed-vent system and control device, subject to the provisions of paragraphs (b)(4)(iv) or (c)(7) of this section or §63.164(h).

(B) A list of identification numbers for compressors that the owner or operator elects to designate as operating with an instrument reading of less than 500 parts per million above background, under the provisions of §63.164(i) of subpart H of this part.

(iii)(A) A list of identification numbers for pressure relief devices subject to the provisions in paragraph (b)(4)(i) of this section.

(B) A list of identification numbers for pressure relief devices equipped with rupture disks, subject to the provisions of paragraph (b)(4)(ii)(B) of this section.

(iv) Identification of instrumentation systems subject to the provisions of this section. Individual components in an instrumentation system need not be identified.

(v) The following information shall be recorded for each dual mechanical seal system:

(A) Design criteria required by paragraph (c)(5)(vi)(A) of this section and §63.164(e)(2) of subpart H of this part, and an explanation of the design criteria; and

(B) Any changes to these criteria and the reasons for the changes.

(vi) A list of equipment designated as unsafe-to-monitor or difficult-to-monitor under paragraph (f) of this section and a copy of the plan for monitoring this equipment.

(vii) A list of connectors removed from and added to the process, as described in §63.174(i)(1) of subpart H of this part, and documentation of the integrity of the weld for any removed connectors, as required in §63.174(j) of subpart H of this part. This is not required unless the net credits for removed connectors is expected to be used.

(viii) For batch processes that the owner or operator elects to monitor as provided under §63.178(c) of subpart H of this part, a list of equipment added to batch product processes since the last monitoring period required in §63.178(c)(3)(ii) and (iii) of subpart H of this part. This list must be completed for each type of equipment within 15 calendar days of the completion of the each monitoring survey for the type of equipment monitored.

(3) *Records of visual inspections.* For visual inspections of equipment subject to the provisions of paragraphs (c)(2)(iii) and (c)(5)(iv) of this section, the owner or operator shall document that the inspection was conducted and the date of the inspection. The owner or operator shall maintain records as specified in paragraph (g)(4) of this section for leaking equipment identified in this inspection, except as provided in paragraph (g)(5) of this section. These records shall be retained for 5 years.

(4) *Monitoring records.* When each leak is detected as specified in paragraphs (c) and (e) of this section and §§63.164, 63.169, 63.172, and 63.174 of subpart H of this part, the owner or operator shall record the information specified in paragraphs (g)(4)(i) through (ix) of this section. All records shall be retained for 5 years, in accordance with the requirements of §63.10(b)(1) of subpart A of this part.

(i) The instrument and the equipment identification number and the operator name, initials, or identification number.

(ii) The date the leak was detected and the date of first attempt to repair the leak.

(iii) The date of successful repair of the leak.

(iv) If postrepair monitoring is required, maximum instrument reading measured by Method 21 of 40 CFR part 60, appendix A, after it is successfully repaired or determined to be nonrepairable.

(v) “Repair delayed” and the reason for the delay if a leak is not repaired within 15 calendar days after discovery of the leak.

(A) The owner or operator may develop a written procedure that identifies the conditions that justify a delay of repair. The written procedures must be maintained at the plant site. Reasons for delay of repair may be documented by citing the relevant sections of the written procedure.

(B) If delay of repair was caused by depletion of stocked parts, there must be documentation that the spare parts were sufficiently stocked onsite before depletion and the reason for depletion.

(vi) If repairs were delayed, dates of process shutdowns that occur while the equipment is unrepaired.

(vii)(A) If the alternative in §63.174(c)(1)(ii) of subpart H of this part is not in use for the monitoring period, identification, either by list, location (area or grouping), or tagging of connectors disturbed since the last monitoring period required in §63.174(b) of subpart H of this part, as described in §63.174(c)(1) of subpart H of this part.

(B) The date and results of follow-up monitoring as required in §63.174(c) of subpart H of this part. If identification of disturbed connectors is made by location, then all connectors within the designated location shall be monitored.

(viii) The date and results of the monitoring required in §63.178(c)(3)(i) of subpart H of this part for equipment added to a batch process since the last monitoring period required in §63.178(c)(3)(ii) and (iii) of subpart H of this part. If no leaking equipment is found in this monitoring, the owner or operator shall record that the inspection was performed. Records of the actual monitoring results are not required.

(ix) Copies of the periodic reports as specified in paragraph (h)(3) of this section, if records are not maintained on a computerized data base capable of generating summary reports from the records.

(5) *Records of pressure tests.* The owner or operator who elects to pressure test a process equipment train and supply lines between storage and processing areas to demonstrate compliance with this section is exempt from the requirements of paragraphs (g)(2), (3), (4), and (6) of this section. Instead, the owner or operator shall maintain records of the following information:

(i) The identification of each product, or product code, produced during the calendar year. It is not necessary to identify individual items of equipment in the process equipment train.

(ii) Records demonstrating the proportion of the time during the calendar year the equipment is in use in the process that is subject to the provisions of this subpart. Examples of suitable documentation are records of time in use for individual pieces of equipment or average time in use for the process unit. These records are not required if the owner or operator does not adjust monitoring frequency by the time in use, as provided in §63.178(c)(3)(iii) of subpart H of this part.

(iii) Physical tagging of the equipment to identify that it is in organic HAP service and subject to the provisions of this section is not required. Equipment in a process subject to the provisions of this section may be identified on a plant site plan, in log entries, or by other appropriate methods.

(iv) The dates of each pressure test required in §63.178(b) of subpart H of this part, the test pressure, and the pressure drop observed during the test.

(v) Records of any visible, audible, or olfactory evidence of fluid loss.



(vi) When a process equipment train does not pass two consecutive pressure tests, the following information shall be recorded in a log and kept for 2 years:

(A) The date of each pressure test and the date of each leak repair attempt.

(B) Repair methods applied in each attempt to repair the leak.

(C) The reason for the delay of repair.

(D) The expected date for delivery of the replacement equipment and the actual date of delivery of the replacement equipment.

(E) The date of successful repair.

(6) *Records of compressor and pressure relief device compliance tests.* The dates and results of each compliance test required for compressors subject to the provisions in §63.164(i) and the dates and results of the Method 21 of 40 CFR part 60, appendix A, monitoring following a pressure release for each pressure relief device subject to the provisions in paragraphs (b)(4)(i) and (ii) of this section. The results shall include:

(i) The background level measured during each compliance test.

(ii) The maximum instrument reading measured at each piece of equipment during each compliance test.

(7) *Records for closed-vent systems.* The owner or operator shall maintain records of the information specified in paragraphs (g)(7)(i) through (iii) of this section for closed-vent systems and control devices subject to the provisions of paragraph (b)(3)(ii) of this section. The records specified in paragraph (g)(7)(i) of this section shall be retained for the life of the equipment. The records specified in paragraphs (g)(7)(ii) and (iii) of this section shall be retained for 5 years.

(i) The design specifications and performance demonstrations specified in paragraphs (g)(7)(i)(A) through (D) of this section.

(A) Detailed schematics, design specifications of the control device, and piping and instrumentation diagrams.

(B) The dates and descriptions of any changes in the design specifications.

(C) The flare design (i.e., steam assisted, air assisted, or nonassisted) and the results of the compliance demonstration required by §63.11(b) of subpart A of this part.

(D) A description of the parameter or parameters monitored, as required in paragraph (b)(3)(ii) of this section, to ensure that control devices are operated and maintained in conformance with their design and an explanation of why that parameter (or parameters) was selected for the monitoring.

(ii) Records of operation of closed-vent systems and control devices.

(A) Dates and durations when the closed-vent systems and control devices required in paragraph (c) of this section and §§63.164 through 63.166 of subpart H of this part are not operated as designed as

indicated by the monitored parameters, including periods when a flare pilot light system does not have a flame.

(B) Dates and durations during which the monitoring system or monitoring device is inoperative.

(C) Dates and durations of startups and shutdowns of control devices required in paragraph (c) of this section and §§63.164 through 63.166 of subpart H of this part.

(iii) Records of inspections of closed-vent systems subject to the provisions of §63.172 of subpart H of this part.

(A) For each inspection conducted in accordance with the provisions of §63.172(f)(1) or (2) of subpart H of this part during which no leaks were detected, a record that the inspection was performed, the date of the inspection, and a statement that no leaks were detected.

(B) For each inspection conducted in accordance with the provisions of §63.172(f)(1) or (f)(2) of subpart H of this part during which leaks were detected, the information specified in paragraph (g)(4) of this section shall be recorded.

(8) *Records for components in heavy liquid service.* Information, data, and analysis used to determine that a piece of equipment or process is in heavy liquid service shall be recorded. Such a determination shall include an analysis or demonstration that the process fluids do not meet the criteria of “in light liquid or gas/vapor service.” Examples of information that could document this include, but are not limited to, records of chemicals purchased for the process, analyses of process stream composition, engineering calculations, or process knowledge.

(9) *Records of exempt components.* Identification, either by list, location (area or group), or other method of equipment in organic HAP service less than 300 hr/yr subject to the provisions of this section.

(10) *Records of alternative means of compliance determination.* Owners and operators choosing to comply with the requirements of §63.179 of subpart H of this part shall maintain the following records:

(i) Identification of the process(es) and the organic HAP they handle.

(ii) A schematic of the process, enclosure, and closed-vent system.

(iii) A description of the system used to create a negative pressure in the enclosure to ensure that all emissions are routed to the control device.

(11) *Records of pressure releases to the atmosphere from pressure relief devices.* For pressure relief devices in organic HAP service subject to paragraph (b)(4)(iii) of this section, keep records of each pressure release to the atmosphere, including the following information:

(i) The source, nature, and cause of the pressure release.

(ii) The date, time, and duration of the pressure release.

(iii) The quantity of total HAP emitted during the pressure release and the calculations used for determining this quantity.

(iv) The actions taken to prevent this pressure release.

(v) The measures adopted to prevent future such pressure releases.

(h) *Reporting Requirements.* (1) Each owner or operator of a source subject to this section shall submit the reports listed in paragraphs (h)(1)(i) and (ii) of this section.

(i) A Notification of Compliance Status report described in paragraph (h)(2) of this section, and

(ii) Periodic reports described in paragraph (h)(3) of this section.

(2) *Notification of compliance status report.* Each owner or operator of a source subject to this section shall submit the information specified in paragraphs (h)(2)(i) through (iii) of this section in the Notification of Compliance Status report described in §63.1368(f). For pressure relief devices subject to the requirements of paragraph (b)(4)(iii) of this section, the owner or operator shall submit the information listed in paragraph (h)(2)(iv) of this section in the Notification of Compliance Status within 150 days after the first applicable compliance date for pressure relief device monitoring. Section 63.9(j) of subpart A of this part shall not apply to the Notification of Compliance Status report.

(i) The notification shall provide the information listed in paragraphs (h)(2)(i)(A) through (C) of this section for each group of processes subject to the requirements of paragraphs (b) through (g) of this section.

(A) Identification of the group of processes.

(B) Approximate number of each equipment type (e.g., valves, pumps) in organic HAP service, excluding equipment in vacuum service.

(C) Method of compliance with the standard (for example, “monthly leak detection and repair” or “equipped with dual mechanical seals”).

(ii) The notification shall provide the information listed in paragraphs (h)(2)(ii)(A) and (B) of this section for each process subject to the requirements of paragraph (b)(3)(iv) of this section and §63.178(b) of subpart H of this part.

(A) Products or product codes subject to the provisions of this section, and

(B) Planned schedule for pressure testing when equipment is configured for production of products subject to the provisions of this section.

(iii) The notification shall provide the information listed in paragraphs (h)(2)(iii)(A) and (B) of this section for each process subject to the requirements in §63.179 of subpart H of this part.

(A) Process identification.

(B) A description of the system used to create a negative pressure in the enclosure and the control device used to comply with the requirements of paragraph (b)(3)(ii) of this section.

(iv) For pressure relief devices in organic HAP service, a description of the device or monitoring system to be implemented, including the pressure relief devices and process parameters to be monitored (if applicable), a description of the alarms or other methods by which operators will be notified of a pressure release, and a description of how the owner or operator will determine the information to be recorded under paragraphs (g)(11)(ii) and (iii) of this section (i.e., the duration of the pressure release and the methodology and calculations for determining of the quantity of total HAP emitted during the pressure release).

(3) *Periodic reports.* The owner or operator of a source subject to this section shall submit Periodic reports.

(i) A report containing the information in paragraphs (h)(3)(ii) through (v) of this section shall be submitted semiannually. The first Periodic report shall be submitted no later than 240 days after the date the Notification of Compliance Status report is due and shall cover the 6-month period beginning on the date the Notification of Compliance Status report is due. Each subsequent Periodic report shall cover the 6-month period following the preceding period.

(ii) For equipment complying with the provisions of paragraphs (b) through (g) of this section, the Periodic report shall contain the summary information listed in paragraphs (h)(3)(ii)(A) through (L) of this section for each monitoring period during the 6-month period.

(A) The number of valves for which leaks were detected as described in paragraph (e)(2) of this section, the percent leakers, and the total number of valves monitored;

(B) The number of valves for which leaks were not repaired as required in paragraph (e)(7) of this section, identifying the number of those that are determined nonrepairable;

(C) The number of pumps and agitators for which leaks were detected as described in paragraph (c)(2) of this section, the percent leakers, and the total number of pumps and agitators monitored;

(D) The number of pumps and agitators for which leaks were not repaired as required in paragraph (c)(3) of this section;

(E) The number of compressors for which leaks were detected as described in §63.164(f) of subpart H of this part;

(F) The number of compressors for which leaks were not repaired as required in §63.164(g) of subpart H of this part;

(G) The number of connectors for which leaks were detected as described in §63.174(a) of subpart H of this part, the percent of connectors leaking, and the total number of connectors monitored;

(H) The number of connectors for which leaks were not repaired as required in §63.174(d) of subpart H of this part, identifying the number of those that are determined nonrepairable;

(I) The facts that explain any delay of repairs and, where appropriate, why a process shutdown was technically infeasible.

(J) The results of all monitoring to show compliance with §§63.164(i) and 63.172(f) conducted within the semiannual reporting period.

(K) If applicable, the initiation of a monthly monitoring program under either paragraph (c)(4)(ii) or paragraph (e)(4)(i)(A) of this section.

(L) If applicable, notification of a change in connector monitoring alternatives as described in §63.174(c)(1) of subpart H of this part.

(iii) For owners or operators electing to meet the requirements of §63.178(b) of subpart H of this part, the Periodic report shall include the information listed in paragraphs (h)(3)(iii) (A) through (E) of this section for each process.

(A) Product process equipment train identification;

(B) The number of pressure tests conducted;

(C) The number of pressure tests where the equipment train failed either the retest or two consecutive pressure tests;

(D) The facts that explain any delay of repairs; and

(E) The results of all monitoring to determine compliance with §63.172(f) of subpart H of this part.

(iv) Any change in the information submitted under paragraph (h)(2) of this section shall be provided in the next Periodic report.

(v) For pressure relief devices in organic HAP service, Periodic Reports must include the information specified in paragraphs (h)(3)(v)(A) through (C) of this section.

(A) For pressure relief devices in organic HAP service subject to paragraph (b)(4) of this section, report confirmation that all monitoring to show compliance was conducted within the reporting period.

(B) For pressure relief devices in organic HAP gas or vapor service subject to paragraph (b)(4)(ii) of this section, report any instrument reading of 500 ppm above background or greater, more than 5 calendar days after the pressure release.

(C) For pressure relief devices in organic HAP service subject to paragraph (b)(4)(iii) of this section, report each pressure release to the atmosphere, including the following information:

(1) The source, nature, and cause of the pressure release.

(2) The date, time, and duration of the pressure release.

(3) The quantity of total HAP emitted during the pressure release and the method used for determining this quantity.

(4) The actions taken to prevent this pressure release.

(5) The measures adopted to prevent future such pressure releases.

[64 FR 33589, June 23, 1999, as amended at 67 FR 59345, Sept. 20, 2002; 79 FR 17372, Mar. 27, 2014]

[↑ Back to Top](#)

### **§63.1364 Compliance dates.**

(a) *Compliance dates for existing sources.* (1) An owner or operator of an existing affected source must comply with the provisions in this subpart (except §63.1363(b)(4)(iii)) by December 23, 2003.

Compliance with the pressure relief device monitoring provisions of §63.1363(b)(4)(iii) shall occur no later than March 27, 2017.

(2) Pursuant to section 112(i)(3)(B) of the CAA, an owner or operator of an existing source may request an extension of up to 1 additional year to comply with the provisions of this subpart if the additional time is needed for the installation of controls.

(i) For purposes of this subpart, a request for an extension shall be submitted no later than 120 days prior to the compliance date specified in paragraph (a)(1) of this section, except as provided in paragraph (a)(2)(ii) of this section. The dates specified in §63.6(i) of subpart A of this part for submittal of requests for extensions shall not apply to sources subject to this subpart.

(ii) An owner or operator may submit a compliance extension request after the date specified in paragraph (a)(1)(i) of this section provided the need for the compliance extension arose after that date and before the otherwise applicable compliance date, and the need arose due to circumstances beyond reasonable control of the owner or operator. This request shall include the data described in §63.6(i)(8)(A), (B), and (D) of subpart A of this part.

(b) *Compliance dates for new and reconstructed sources.* An owner or operator of a new or reconstructed affected source must comply with the provisions of this subpart (except §63.1363(b)(4)(iii)) on June 23, 1999 or upon startup, whichever is later. New or reconstructed affected sources that commenced construction after November 10, 1997, but on or before January 9, 2012, must be in compliance with the pressure relief device monitoring provisions of §63.1363(b)(4)(iii) no later than March 27, 2017. New or reconstructed sources that commenced construction after January 9, 2012, must be in compliance with the pressure relief device monitoring provisions of §63.1363(b)(4)(iii) upon initial startup or by March 27, 2014, whichever is later.

[64 FR 33589, June 23, 1999, as amended at 67 FR 13511, Mar. 22, 2002; 67 FR 38203, June 3, 2002; 79 FR 17374, Mar. 27, 2014]

[↑ Back to Top](#)

### **§63.1365 Test methods and initial compliance procedures.**

(a) *General.* Except as specified in paragraph (a)(4) of this section, the procedures specified in paragraphs (c), (d), (e), (f), and (g) of this section are required to demonstrate initial compliance with §63.1362(b), (c), (d), (f), and (g), respectively. The provisions in paragraph (a)(1) of this section apply to design evaluations that are used to demonstrate compliance with the standards for process vents and storage vessels. The provisions in paragraph (a)(2) of this section apply to performance tests that are specified in

paragraphs (c), (d), and (e) of this section. The provisions in paragraph (a)(3) of this section describe initial compliance procedures for flares. The provisions in paragraph (a)(5) of this section are used to demonstrate initial compliance with the alternative standards specified in §63.1362(b)(6) and (c)(4). The provisions in paragraph (a)(6) of this section are used to comply with the outlet concentration requirements specified in §63.1362(b)(2)(iv)(A), (b)(3)(ii), (b)(4)(ii)(A), (b)(5)(ii), and (b)(5)(iii).

(1) *Design evaluation.* To demonstrate that a control device meets the required control efficiency, a design evaluation must address the composition and HAP concentration of the vent stream entering the control device. A design evaluation also must address other vent stream characteristics and control device operating parameters as specified in any one of paragraphs (a)(1)(i) through (vii) of this section, depending on the type of control device that is used. If the vent stream is not the only inlet to the control device, the efficiency demonstration also must consider all other vapors, gases, and liquids, other than fuels, received by the control device.

(i) For an enclosed combustion device used to comply with the provisions of §63.1362(b)(2)(iv), (b)(4)(ii), (c)(2)(iv)(B), or (c)(3) with a minimum residence time of 0.5 seconds and a minimum temperature of 760 °C, the design evaluation must document that these conditions exist.

(ii) For a combustion control device that does not satisfy the criteria in paragraph (a)(1)(i) of this section, the design evaluation must document control efficiency and address the following characteristics, depending on the type of control device:

(A) For a thermal vapor incinerator, the design evaluation must consider the autoignition temperature of the organic HAP, must consider the vent stream flow rate, and must establish the design minimum and average temperature in the combustion zone and the combustion zone residence time.

(B) For a catalytic vapor incinerator, the design evaluation must consider the vent stream flow rate and must establish the design minimum and average temperatures across the catalyst bed inlet and outlet.

(C) For a boiler or process heater, the design evaluation must consider the vent stream flow rate, must establish the design minimum and average flame zone temperatures and combustion zone residence time, and must describe the method and location where the vent stream is introduced into the flame zone.

(iii) For a condenser, the design evaluation must consider the vent stream flow rate, relative humidity, and temperature, and must establish the maximum temperature of the condenser exhaust vent stream and the corresponding outlet organic HAP compound concentration level or emission rate for which the required reduction is achieved.

(iv) For a carbon adsorption system that regenerates the carbon bed directly onsite in the control device such as a fixed-bed adsorber, the design evaluation must consider the vent stream flow rate, relative humidity, and temperature, and must establish the design exhaust vent stream organic compound concentration level, adsorption cycle time, number of carbon beds and their capacities, type and working capacity of activated carbon used for the carbon beds, design total regeneration stream mass or volumetric flow over the period of each complete carbon bed regeneration cycle, design carbon bed temperature after regeneration, design carbon bed regeneration time, and design service life of carbon. For vacuum desorption, the pressure drop must be included.

(v) For a carbon adsorption system that does not regenerate the carbon bed directly onsite in the control device such as a carbon canister, the design evaluation must consider the vent stream mass or volumetric flow rate, relative humidity, and temperature, and must establish the design exhaust vent stream organic compound concentration level, capacity of the carbon bed, type and working capacity of activated carbon used for the carbon bed, and design carbon replacement interval based on the total carbon working capacity of the control device and source operating schedule.

(vi) For a scrubber, the design evaluation must consider the vent stream composition, constituent concentrations, liquid-to-vapor ratio, scrubbing liquid flow rate and concentration, temperature, and the reaction kinetics of the constituents with the scrubbing liquid. The design evaluation must establish the design exhaust vent stream organic compound concentration level and must include the additional information in paragraphs (a)(1)(vi)(A) and (B) of this section for trays and a packed column scrubber.

(A) Type and total number of theoretical and actual trays;

(B) Type and total surface area of packing for entire column, and for individual packed sections if column contains more than one packed section.

(vii) For fabric filters, the design evaluation must include the pressure drop through the device and the net gas-to-cloth ratio (i.e., cubic feet of gas per square feet of cloth).

(2) *Calculation of TOC or total organic HAP concentration.* The TOC concentration or total organic HAP concentration is the sum of the concentrations of the individual components. If compliance is being determined based on TOC, the owner or operator shall compute TOC for each run using Equation 6 of this subpart. If compliance is being determined based on total organic HAP, the owner or operator shall compute total organic HAP using Equation 6 of this subpart, except that only organic HAP compounds shall be summed; when determining compliance with the wastewater provisions of §63.1362(d), the organic HAP compounds shall consist of the organic HAP compounds in Table 9 of subpart G of this part.

$$CG_T = \frac{1}{m} \sum_{j=1}^m \left( \sum_{i=1}^n CGS_{i,j} \right) \quad (Eq. 6)$$

[View or download PDF](#)

Where:

$CG_T$  = total concentration of TOC or organic HAP in vented gas stream, average of samples, dry basis, ppmv

$CGS_{i,j}$  = concentration of sample components in vented gas stream for sample j, dry basis, ppmv

n = number of compounds in the sample

m = number of samples in the sample run.

(3) *Initial compliance using flares.* When a flare is used to comply with the standards, the owner or operator shall comply with the provisions in §63.11(b) of subpart A of this part.



(i) The initial compliance determination shall consist of a visible emissions determination using Method 22 of 40 CFR part 60, appendix A, as described in §63.11(b)(4) of subpart A of this part, and a determination of net heating value of gas being combusted and exit velocity to comply with the requirements of §63.11(b)(6) through (8) of subpart A of this part. The net heating value and exit velocity shall be based on the results of performance testing under the conditions described in paragraphs (b)(10) and (11) of this section.

(ii) An owner or operator is not required to conduct a performance test to determine percent emission reduction or outlet organic HAP or TOC concentration when a flare is used.

(4) *Exemptions from compliance demonstrations.* An owner or operator using any control device specified in paragraphs (a)(4)(i) through (ii) of this section is exempt from the initial compliance provisions in paragraphs (c), (d), and (e) of this section.

(i) A boiler or process heater with a design heat input capacity of 44 megawatts or greater.

(ii) A boiler or process heater into which the emission stream is introduced with the primary fuel.

(5) *Initial compliance with alternative standard.* Initial compliance with the alternative standards in §63.1362(b)(6) and (c)(4) for combustion devices is demonstrated when the outlet TOC concentration is 20 ppmv or less, and the outlet HCl and chlorine concentration is 20 ppmv or less. Initial compliance with the alternative standards in §63.1362(b)(6) and (c)(4) for noncombustion devices is demonstrated when the outlet TOC concentration is 50 ppmv or less, and the outlet HCl and chlorine concentration is 50 ppmv or less. To demonstrate initial compliance, the owner or operator shall be in compliance with the monitoring provisions in §63.1366(b)(5) on the initial compliance date. The owner or operator shall use Method 18 to determine the predominant organic HAP in the emission stream if the TOC monitor is calibrated on the predominant HAP.

(6) *Initial compliance with the 20 ppmv outlet limit.* Initial compliance with the 20 ppmv TOC or total organic HAP concentration is demonstrated when the outlet TOC or total organic HAP concentration is 20 ppmv or less. Initial compliance with the 20 ppmv HCl and chlorine concentration is demonstrated when the outlet HCl and chlorine concentration is 20 ppmv or less. To demonstrate initial compliance, the operator shall use applicable test methods described in paragraphs (b)(1) through (9) of this section, and test under conditions described in paragraph (b)(10) or (11) of this section, as applicable. The owner or operator shall comply with the monitoring provisions in §63.1366(b)(1) through (5) on the initial compliance date.

(7) *Outlet concentration correction for supplemental gases.* If supplemental gases are added to a vent stream for which compliance with an outlet concentration standard in §63.1362 or 63.1363 will be demonstrated, the owner or operator must correct the outlet concentration as specified in paragraphs (a)(7)(i) and (ii) of this section.

(i) *Combustion device.* Except as specified in §63.1366(b)(5)(ii)(A), if the vent stream is controlled with a combustion device, the owner or operator must comply with the provisions in paragraphs (a)(7)(i)(A) through (C) of this section.

(A) To comply with a TOC or total organic HAP outlet concentration standard in §63.1362(b)(2)(iv)(A), (b)(4)(ii)(A), (b)(6), (c)(2)(iv)(B), (c)(4), (d)(13), or §63.172, the actual TOC outlet concentration must be corrected to 3 percent oxygen.

(B) If the inlet stream to the combustion device contains any HCl, chlorine, or halogenated compounds, and the owner or operator elects to comply with a total HCl and chlorine outlet concentration standard in §63.1362(b)(3)(ii), (b)(5)(ii), (b)(5)(iii), (b)(6), or (c)(4), the actual total HCl and chlorine outlet concentration must be corrected to 3 percent oxygen.

(C) The integrated sampling and analysis procedures of Method 3B of 40 CFR part 60, appendix A, shall be used to determine the actual oxygen concentration (%O<sub>2d</sub>). The samples shall be taken during the same time that the TOC, total organic HAP, and total HCl and chlorine samples are taken. The concentration corrected to 3 percent oxygen (C<sub>c</sub>) shall be computed using Equation 7 of this subpart:

$$C_c = C_m \left( \frac{17.9}{20.9 - \%O_{2d}} \right) \quad (\text{Eq. 7})$$

[View or download PDF](#)

Where:

C<sub>c</sub> = concentration of TOC, total organic HAP, or total HCl and chlorine corrected to 3 percent oxygen, dry basis, ppmv

C<sub>m</sub> = total concentration of TOC, total organic HAP, or total HCl and chlorine in the vented gas stream, average of samples, dry basis, ppmv

%O<sub>2d</sub> = concentration of oxygen measured in vented gas stream, dry basis, percent by volume.

(ii) *Noncombustion devices.* If a control device other than a combustion device, and not in series with a combustion device, is used to comply with a TOC, total organic HAP, or total HCl and chlorine outlet concentration standard, the owner or operator must correct the actual concentration for supplemental gases using Equation 8 of this subpart.

$$C_a = C_m \left( \frac{V_s + V_a}{V_a} \right) \quad (\text{Eq. 8})$$

[View or download PDF](#)

Where:

C<sub>a</sub> = corrected outlet TOC, total organic HAP, or total HCl and chlorine concentration, dry basis, ppmv

C<sub>m</sub> = actual TOC, total organic HAP, or total HCl and chlorine concentration measured at control device outlet, dry basis, ppmv

V<sub>a</sub> = total volumetric flow rate of affected streams vented to the control device

$V_s$  = total volumetric flow rate of supplemental gases.

(b) *Test methods and conditions.* When testing is conducted to measure emissions from an affected source, the test methods specified in paragraphs (b)(1) through (9) of this section shall be used. Compliance and performance tests shall be performed under such conditions as the Administrator specifies to the owner or operator based on representative performance of the affected source for the period being tested and as specified in paragraphs (b)(10) and (11) of this section. Representative conditions exclude periods of startup and shutdown unless specified by the Administrator or an applicable subpart. The owner or operator may not conduct performance tests during periods of malfunction. The owner or operator must record the process information that is necessary to document operating conditions during the test and include in such record an explanation to support that such conditions represent normal operation. Upon request, the owner or operator shall make available to the Administrator such records as may be necessary to determine the conditions of performance tests.

(1) Method 1 or 1A of appendix A of 40 CFR part 60 shall be used for sample and velocity traverses.

(2) Method 2, 2A, 2C, or 2D of appendix A of 40 CFR part 60 shall be used for velocity and volumetric flow rates.

(3) Method 3 of appendix A of 40 CFR part 60 shall be used for gas analysis.

(4) Method 4 of appendix A of 40 CFR part 60 shall be used for stack gas moisture.

(5) Concentration measurements shall be adjusted to negate the dilution effects of introducing nonaffected gaseous streams into the vent streams prior to control or measurement. The following methods are specified for concentration measurements of organic compounds:

(i) Method 18 of appendix A of 40 CFR part 60 may be used to determine HAP concentration in any control device efficiency determination.

(ii) Method 25 of appendix A of 40 CFR part 60 may be used to determine total gaseous nonmethane organic concentration for control efficiency determinations in combustion devices.

(iii) Method 25A of appendix A of 40 CFR part 60 may be used to determine the HAP or TOC concentration for control device efficiency determinations under the conditions specified in Method 25 of appendix A of 40 CFR part 60 for direct measurement of an effluent with a flame ionization detector, or in demonstrating compliance with the 20 ppmv TOC outlet standard. If Method 25A of appendix A of 40 CFR part 60 is used to determine the concentration of TOC for the 20 ppmv standard, the instrument shall be calibrated on methane or the predominant HAP. If calibrating on the predominant HAP, the use of Method 25A of appendix A of 40 CFR part 60 shall comply with paragraphs (b)(5)(i)(A) through (C) of this section.

(A) The organic HAP used as the calibration gas for Method 25A, 40 CFR part 60, appendix A, shall be the single organic HAP representing the largest percent by volume.

(B) The use of Method 25A, 40 CFR part 60, appendix A, is acceptable if the response from the high level calibration gas is at least 20 times the standard deviation of the response from the zero calibration gas when the instrument is zeroed on the most sensitive scale.

(C) The span value of the analyzer must be less than 100 ppmv.

(6) The methods in either paragraph (b)(6)(i) or (ii) of this section shall be used to determine the concentration, in mg/dscm, of total HCl and chlorine. Concentration measurements shall be adjusted to negate the dilution effects of introducing nonaffected gaseous streams into the vent streams prior to control or measurement.

(i) Method 26 or 26A of 40 CFR part 60, appendix A.

(ii) Any other method if the method or data have been validated according to the applicable procedures of Method 301 of appendix A of this part.

(7) Method 5 of appendix A of 40 CFR part 60 shall be used to determine the concentration of particulate matter in exhaust gas streams from bag dumps and product dryers.

(8) Wastewater analysis shall be conducted in accordance with §63.144(b)(5)(i) through (iii) or as specified in paragraph (b)(8)(i) or (ii) of this section.

(i) As an alternative to the methods specified in §63.144(b)(5)(i), an owner or operator may conduct wastewater analyses using Method 1666 or 1671 of 40 CFR part 136, appendix A, and comply with the sampling protocol requirements specified in §63.144(b)(5)(ii). The validation requirements specified in §63.144(b)(5)(iii) do not apply if an owner or operator uses Method 1666 or 1671 of 40 CFR part 136, appendix A.

(ii) As an alternative to the methods specified in §63.144(b)(5)(i), an owner or operator may use procedures specified in Method 8260 or 8270 in “Test Methods for Evaluating Solid Waste, Physical/Chemical Methods,” EPA Publication No. SW-846, Third Edition, September 1986, as amended by Update I, November 15, 1992. An owner or operator also may use any more recent, updated version of Method 8260 or 8270 approved by EPA. For the purpose of using Method 8260 or 8270 to comply with this subpart, the owner or operator must maintain a formal quality assurance program consistent with either Section 8 of Method 8260 or Method 8270. This program must include the elements related to measuring the concentrations of volatile compounds that are specified in paragraphs (b)(8)(ii)(A) through (C) of this section.

(A) Documentation of site-specific procedures to minimize the loss of compounds due to volatilization, biodegradation, reaction, or sorption during the sample collection, storage, and preparation steps.

(B) Documentation of specific quality assurance procedures followed during sampling, sample preparation, sample introduction, and analysis.

(C) Measurement of the average accuracy and precision of the specific procedures, including field duplicates and field spiking of the material source before or during sampling with compounds having similar chemical characteristics to the target analytes.

(9) Method 22 of appendix A of 40 CFR part 60 shall be used to determine visible emissions from flares.

(10) *Testing conditions for continuous processes.* Testing of process vents on equipment operating as part of a continuous process shall consist of three one-hour runs. Gas stream volumetric flow rates shall be

measured every 15 minutes during each 1-hour run. Organic HAP concentration shall be determined from samples collected in an integrated sample over the duration of each one-hour test run, or from grab samples collected simultaneously with the flow rate measurements (every 15 minutes). If an integrated sample is collected for laboratory analysis, the sampling rate shall be adjusted proportionally to reflect variations in flow rate. For continuous gas streams, the emission rate used to determine compliance shall be the average emission rate of the three test runs.

(11) *Testing conditions for batch processes.* Testing of emissions on equipment where the flow of gaseous emissions is intermittent (batch operations) shall be conducted at absolute peak-case conditions or hypothetical peak-case conditions, as specified in paragraphs (b)(11)(i) and (ii) of this section, respectively. Gas stream volumetric flow rates shall be measured at 15-minute intervals. Organic HAP, TOC, or HCl and chlorine concentration shall be determined from samples collected in an integrated sample over the duration of the test, or from grab samples collected simultaneously with the flow rate measurements (every 15 minutes). If an integrated sample is collected for laboratory analysis, the sampling rate shall be adjusted proportionally to reflect variations in flow rate. In all cases, a site-specific test plan shall be submitted to the Administrator for approval prior to testing in accordance with §63.7(c). The test plan shall include the emissions profile described in paragraph (b)(11)(iii) of this section. The term “HAP mass loading” as used in paragraphs (b)(11)(i) through (iii) of this section refers to the class of HAP, either organic or HCl and chlorine, that the control device is intended to control.

(i) *Absolute peak-case.* If the most challenging conditions for the control device occur under maximum HAP load, the absolute peak-case conditions shall be characterized by the criteria presented in paragraph (b)(11)(i)(A) or (B) of this section. Otherwise, absolute peak-case conditions are defined by the conditions in paragraph (b)(11)(i)(C) of this section.

(A) The period in which the inlet to the control device will contain at least 50 percent of the maximum HAP mass load that may be vented to the control device over any 8-hour period. An emission profile as described in paragraph (b)(11)(iii)(A) of this section shall be used to identify the 8-hour period that includes the maximum projected HAP load.

(B) A 1-hour period of time in which the inlet to the control device will contain the highest hourly HAP mass loading rate that may be vented to the control device. An emission profile as described in paragraph (b)(11)(iii)(A) of this section shall be used to identify the 1-hour period of maximum HAP loading.

(C) The period of time when a condition other than the maximum HAP load is most challenging for the control device. These conditions include, but are not limited to the following:

(1) Periods when the streams contain the highest combined VOC and HAP hourly load, as described by the emission profiles in paragraph (b)(11)(iii) of this section; or

(2) Periods when the streams contain HAP constituents that approach the limits of solubility for scrubbing media; or

(3) Periods when the streams contain HAP constituents that approach the limits of adsorptivity for carbon adsorption systems.

(ii) *Hypothetical peak-case.* Hypothetical peak-case conditions are simulated test conditions that, at a minimum, contain the highest total average hourly HAP load of emissions that would be predicted to be vented to the control device from the emissions profile described in either paragraph (b)(11)(iii)(B) or (C) of this section.

(iii) *Emissions profile.* The owner or operator may choose to perform tests only during those periods of the peak-case episode(s) that the owner or operator selects to control as part of achieving the required emission reduction. Except as specified in paragraph (b)(11)(iii)(D) of this section, the owner or operator shall develop an emission profile for the vent to the control device that describes the characteristics of the vent stream at the inlet to the control device under either absolute or hypothetical peak-case conditions. The emissions profile shall be developed based on the applicable procedures described in paragraphs (b)(11)(iii)(A) through (C) of this section, as required by paragraphs (b)(11)(i) and (ii) of this section.

(A) *Emissions profile by process.* The emissions profile must consider all emission episodes that could contribute to the vent stack for a period of time that is sufficient to include all processes venting to the stack and shall consider production scheduling. The profile shall describe the HAP load to the device that equals the highest sum of emissions from the episodes that can vent to the control device during the period of absolute peak-case conditions specified in paragraph (b)(11)(i)(A), (B), or (C) as appropriate. Emissions per episode shall be calculated using the procedures specified in paragraph (c)(2) of this section. When complying with paragraph (b)(11)(i)(B) of this section, emissions per episode shall be divided by the duration of the episode if the duration of the episode is longer than 1 hour.

(B) *Emission profile by equipment.* The emission profile must consist of emissions that meet or exceed the highest hourly HAP load that would be expected under actual processing conditions. The profile shall describe equipment configurations used to generate the emission events, volatility of materials processed in the equipment, and the rationale used to identify and characterize the emission events. The emissions may be based on using a compound more volatile than compounds actually used in the process(es), and the emissions may be generated from all equipment in the process(es) or only selected equipment.

(C) *Emission profile by capture and control device limitation.* The emission profile shall consider the capture and control system limitations and the highest hourly emissions that can be routed to the control device, based on maximum flow rate and concentrations possible because of limitations on conveyance and control equipment (e.g., fans, LEL alarms and safety bypasses).

(D) *Exemptions.* The owner or operator is not required to develop an emission profile under the circumstances described in paragraph (b)(11)(iii)(D)(1) or (2) of this section.

(1) If all process vents for a process are controlled using a control device or series of control devices that reduce HAP emissions by 98 percent or more, no other emission streams are vented to the control device when it is used to control emissions from the subject process, and the performance test is conducted over the entire batch cycle.

(2) If a control device is used to comply with the outlet concentration limit for process vent emission streams from a single process (but not necessarily all of the process vents from that process), no other emission streams are vented to the control device while it is used to control emissions from the subject process, and the performance test is conducted over the entire batch cycle.

(iv) *Test duration.* Three runs, at a minimum of 1 hour each, are required for performance testing. When complying with a percent reduction standard, each test run may be a maximum of either 24 hours or the duration of the longest batch controlled by the control device, whichever is shorter, and each run must include the same absolute or hypothetical peak-case conditions, as defined in paragraph (b)(11)(i) or (ii) of this section. When complying with an outlet concentration limit, each run must include the same absolute or hypothetical peak-case conditions, as defined in paragraph (b)(11)(i) or (ii) of this section, and the duration of each run may not exceed the duration of the applicable peak-case condition.

(c) *Initial compliance with process vent provisions.* The owner or operator of an affected source shall demonstrate compliance with the process vent standards in §63.1362(b) using the procedures described in paragraphs (c)(1) through (3) of this section.

(1) Compliance with the process vent standards in §63.1362(b) shall be demonstrated in accordance with the provisions specified in paragraphs (c)(1)(i) through (viii) of this section.

(i) Initial compliance with the emission limit cutoffs in §63.1362(b)(2)(i) and (b)(4)(i) is demonstrated when the uncontrolled organic HAP emissions from the sum of all process vents within a process are less than or equal to 0.15 Mg/yr. Uncontrolled HAP emissions shall be determined using the procedures described in paragraph (c)(2) of this section.

(ii) Initial compliance with the emission limit cutoffs in §63.1362(b)(3)(i) and (b)(5)(i) is demonstrated when the uncontrolled HCl and Cl<sub>2</sub> emissions from the sum of all process vents within a process are less than or equal to 6.8 Mg/yr. Initial compliance with the emission limit cutoffs in §63.1362(b)(5)(ii) and (iii) is demonstrated when the uncontrolled HCl and Cl<sub>2</sub> emissions are greater than or equal to 6.8 Mg/yr or greater than or equal to 191 Mg/yr, respectively. Uncontrolled emissions shall be determined using the procedures described in paragraph (c)(2) of this section.

(iii) Initial compliance with the organic HAP percent reduction requirements specified in §63.1362(b)(2)(ii), (iii), and (b)(4)(ii) is demonstrated by determining controlled HAP emissions using the procedures described in paragraph (c)(3) of this section, determining uncontrolled HAP emissions using the procedures described in paragraph (c)(2) of this section, and calculating the applicable percent reduction. As an alternative, if the conditions specified in paragraph (b)(11)(iii)(D)(I) of this section are met, initial compliance may be demonstrated by showing the control device reduces emissions by 98 percent by weight or greater using the procedures specified in paragraph (c)(3) of this section.

(iv) Initial compliance with the HCl and Cl<sub>2</sub> percent reduction requirements specified in §63.1362(b)(3)(ii), (b)(5)(ii), and (b)(5)(iii) is demonstrated by determining controlled emissions of HCl and Cl<sub>2</sub> using the procedures described in paragraph (c)(3) of this section, determining uncontrolled emissions of HCl and Cl<sub>2</sub> using the procedures described in paragraph (c)(2) of this section, and calculating the applicable percent reduction.

(v) Initial compliance with the outlet concentration limits in §63.1362(b)(2)(iv)(A), (b)(3)(ii), (b)(4)(ii)(A), (b)(5)(ii) and (iii) is demonstrated when the outlet TOC or total organic HAP concentration is 20 ppmv or less and the outlet HCl and chlorine concentration is 20 ppmv or less. The owner or operator shall demonstrate compliance by fulfilling the requirements in paragraph (a)(6) of this section. If an owner or operator elects to develop an emissions profile by process as described in paragraph

(b)(11)(iii)(A) of this section, uncontrolled emissions shall be determined using the procedures in paragraph (c)(2) of this section.

(vi) Initial compliance with the alternative standard in §63.1362(b)(6) is demonstrated by fulfilling the requirements in paragraph (a)(5) of this section.

(vii) Initial compliance when using a flare is demonstrated by fulfilling the requirements in paragraph (a)(3) of this section.

(viii) No initial compliance demonstration is required for control devices specified in §63.1362(l).

(2) *Uncontrolled emissions.* The owner or operator referred to from paragraphs (c)(1)(i) through (v) of this section shall calculate uncontrolled emissions according to the procedures described in paragraph (c)(2)(i) or (ii) of this section, as appropriate.

(i) *Emission estimation procedures.* The owner or operator shall determine uncontrolled HAP emissions using emission measurements and/or calculations for each batch emission episode according to the engineering evaluation methodology in paragraphs (c)(2)(i)(A) through (H) of this section.

(A) Individual HAP partial pressures in multicomponent systems shall be determined in accordance with the methods specified in paragraphs (c)(2)(i)(A)(1) through (3) of this section. Chemical property data may be obtained from standard references.

(1) If the components are miscible in one another, use Raoult's law to calculate the partial pressures;

(2) If the solution is a dilute aqueous mixture, use Henry's law constants to calculate partial pressures;

(3) If Raoult's law or Henry's law are not appropriate or available, use any of the methods specified in paragraphs (c)(2)(i)(A) (3)(i) through (iii) of this section.

(i) Use experimentally obtained activity coefficients;

(ii) Use models such as the group-contribution models to predict activity coefficients;

(iii) Assume the components of the system behave independently and use the summation of all vapor pressures from the HAP as the total HAP partial pressure;

(B) *Charging or filling.* Emissions from vapor displacement due to transfer of material to a vessel shall be calculated using Equation 9 of this subpart:

$$E = \frac{(V)}{(R)(T)} \times \sum_{i=1}^n (P_i)(MW_i) \quad (Eq. 9)$$

[View or download PDF](#)

Where:

E = mass of HAP emitted



$P_i$  = partial pressure of the individual HAP

$V$  = volume of gas displaced from the vessel

$R$  = ideal gas law constant

$T$  = temperature of the vessel vapor space; absolute

$MW_i$  = molecular weight of the individual HAP

(C) *Purging*. Emissions from purging shall be calculated using Equation 10 of this subpart, except that for purge flow rates greater than 100 scfm, the mole fraction of HAP will be assumed to be 25 percent of the saturated value.

$$E = \sum_{i=1}^n P_i MW_i \times \left( \frac{(V)(t)}{(R)(T)} \right) \times \frac{P_T}{P_T - \sum_{j=1}^m (P_j)} \quad (\text{Eq. 10})$$

[View or download PDF](#)

Where:

$E$  = mass of HAP emitted

$V$  = purge flow rate at the temperature and pressure of the vessel vapor space

$R$  = ideal gas law constant

$T$  = temperature of the vessel vapor space; absolute

$P_i$  = partial pressure of the individual HAP

$P_j$  = partial pressure of individual condensable compounds (including HAP)

$P_T$  = pressure of the vessel vapor space

$MW_i$  = molecular weight of the individual HAP

$t$  = time of purge

$n$  = number of HAP compounds in the emission stream

$m$  = number of condensable compounds (including HAP) in the emission stream.

(D) *Heating*. Emissions caused by heating the contents of a vessel to a temperature less than the boiling point shall be calculated using the procedures in either paragraph (c)(2)(i)(D)(1), (2), or (4) of this section, as appropriate. If the contents of a vessel are heated to the boiling point, emissions while boiling are assumed to be zero if the owner or operator is complying with the provisions in paragraph (d)(2)(i)(C)(3) of this section.

(J) If the final temperature to which the vessel contents are heated is lower than 50 K below the boiling point of the HAP in the vessel, then emissions shall be calculated using Equations 11 through 14 of this subpart.

(i) The mass of HAP emitted per episode shall be calculated using Equation 11 of this subpart:

$$E = \frac{\sum_{i=1}^n (P_i)_{T1}}{Pa_1} + \frac{\sum_{i=1}^n (P_i)_{T2}}{Pa_2} \times \Delta n \times MW_{HAP} \quad (\text{Eq. 11})$$

[View or download PDF](#)

Where:

E = mass of HAP vapor displaced from the vessel being heated

(P<sub>i</sub>)<sub>Tn</sub> = partial pressure of each HAP in the vessel headspace at initial (n = 1) and final (n = 2) temperatures

Pa<sub>1</sub> = initial noncondensable gas pressure in the vessel, as calculated using Equation 13 of this subpart

Pa<sub>2</sub> = final noncondensable gas pressure in the vessel, as calculated using Equation 13 of this subpart

ΔH = number of moles of noncondensable gas displaced, as calculated using Equation 12 of this subpart

MW<sub>HAP</sub> = The average molecular weight of HAP present in the vessel, as calculated using Equation 14 of this subpart:

n = number of HAP compounds in the displaced vapor

(ii) The moles of noncondensable gas displaced shall be calculated using Equation 12 of this subpart:

$$\Delta n = \frac{V}{R} \left[ \left( \frac{Pa_1}{T_1} \right) - \left( \frac{Pa_2}{T_2} \right) \right] \quad (\text{Eq. 12})$$

[View or download PDF](#)

Where:

ΔH = number of moles of noncondensable gas displaced

V = volume of free space in the vessel

R = ideal gas law constant

Pa<sub>1</sub> = initial noncondensable gas pressure in the vessel, as calculated using Equation 13 of this subpart

Pa<sub>2</sub> = final noncondensable gas pressure in the vessel, as calculated using Equation 13 of this subpart

$T_1$  = initial temperature of vessel contents, absolute

$T_2$  = final temperature of vessel contents, absolute

(iii) The initial and final pressure of the noncondensable gas in the vessel shall be calculated according to Equation 13 of this subpart:

$$Pa_n = Pa_{atm} - \sum_{j=1}^m (P_j)_{Tn} \quad (\text{Eq. 13})$$

[View or download PDF](#)

Where:

$Pa_n$  = partial pressure of noncondensable gas in the vessel headspace at initial ( $n = 1$ ) and final ( $n = 2$ ) temperatures

$P_{atm}$  = atmospheric pressure

$(P_j)_{Tn}$  = partial pressure of each condensable volatile organic compound (including HAP) in the vessel headspace at the initial temperature ( $n = 1$ ) and final ( $n = 2$ ) temperature

(iv) The average molecular weight of HAP in the displaced gas shall be calculated using Equation 14 of this subpart:

$$MW_{HAP} = \frac{\sum_{i=1}^n ((P_i)_{T_1} + (P_i)_{T_2}) MW_i}{\sum_{i=1}^n ((P_i)_{T_1} + (P_i)_{T_2})} \quad (\text{Eq. 14})$$

[View or download PDF](#)

Where:

$MW_{HAP}$  = average molecular weight of HAP in the displaced gas

$(P_i)_{Tn}$  = partial pressure of each HAP in the vessel headspace at the initial ( $T_1$ ) and final ( $T_2$ ) temperatures

$MW_i$  = molecular weight of each HAP

$n$  = number of HAP compounds in the emission stream

(2) If the vessel contents are heated to a temperature greater than 50 K below the boiling point, then emissions from the heating of a vessel shall be calculated as the sum of the emissions calculated in accordance with paragraphs (c)(2)(i)(D)(2)(i) and (ii) of this section.

(i) For the interval from the initial temperature to the temperature 50 K below the boiling point, emissions shall be calculated using Equation 11 of this subpart, where  $T_2$  is the temperature 50 K below the boiling point.

(ii) For the interval from the temperature 50 K below the boiling point to the final temperature, emissions shall be calculated as the summation of emissions for each 5 K increment, where the emission for each increment shall be calculated using Equation 11 of this subpart. If the final temperature of the heatup is lower than 5 K below the boiling point, the final temperature for the last increment shall be the final temperature of the heatup, even if the last increment is less than 5 K. If the final temperature of the heatup is higher than 5 K below the boiling point, the final temperature for the last increment shall be the temperature 5 K below the boiling point, even if the last increment is less than 5 K.

(3) While boiling, the vessel must be operated with a properly operated process condenser. An initial demonstration that a process condenser is properly operated is required for vessels that operate process condensers without secondary condensers that are air pollution control devices. The owner or operator must either measure the condenser exhaust gas temperature and show it is less than the boiling point of the substance(s) in the vessel, or perform a material balance around the vessel and condenser to show that at least 99 percent of the material vaporized while boiling is condensed. Uncontrolled emissions are assumed to be zero under these conditions. The initial demonstration shall be conducted for all appropriate operating scenarios and documented in the Notification of Compliance Status report as specified in §63.1368(f).

(4)(i) As an alternative to the procedures described in paragraphs (c)(2)(i)(D)(1) and (2) of this section, emissions caused by heating a vessel to any temperature less than the boiling point may be calculated using Equation 15 of this subpart.

$$E = MW_{HAP} \times \left( N_{avg} \times \ln \left( \frac{P_T - \sum_{i=1}^m (P_{i,1})}{P_T - \sum_{i=1}^m (P_{i,2})} \right) - (n_{HAP,2} - n_{HAP,1}) \right) \quad (Eq. 15)$$

[View or download PDF](#)

Where:

E = mass of HAP vapor displaced from the vessel being heated

$N_{avg}$  = average gas space molar volume during the heating process, as calculated using Equation 16 of this subpart

$P_T$  = total pressure in the vessel

$P_{i,1}$  = partial pressure of the individual HAP compounds at  $T_1$

$P_{i,2}$  = partial pressure of the individual HAP compounds at  $T_2$

$MW_{HAP}$  = average molecular weight of the HAP compounds, as calculated using Equation 14 of this subpart

$n_{HAP,1}$  = number of moles of total HAP in the vessel headspace at  $T_1$

$n_{HAP,2}$  = number of moles of total HAP in the vessel headspace at  $T_2$

m = number of HAP compounds in the emission stream.

(ii) The average gas space molar volume during the heating process is calculated using Equation 16 of this subpart.

$$N_{avg} = \frac{VP_T}{2R} \left( \frac{1}{T_1} + \frac{1}{T_2} \right) \quad (\text{Eq. 16})$$

[View or download PDF](#)

Where:

$N_{avg}$  = average gas space molar volume during the heating process

V = volume of free space in vessel

$P_T$  = total pressure in the vessel

R = ideal gas law constant

$T_1$  = initial temperature of the vessel contents, absolute

$T_2$  = final temperature of the vessel contents, absolute

(iii) The difference in the number of moles of total HAP in the vessel headspace between the initial and final temperatures is calculated using Equation 17 of this subpart.

$$(n_{HAP,2} - n_{HAP,1}) = \frac{V}{(R)(T_2)} \sum_{i=1}^n P_{i,2} - \frac{V}{(R)(T_1)} \sum_{i=1}^n P_{i,1} \quad (\text{Eq. 17})$$

[View or download PDF](#)

Where:

$n_{HAP,2}$  = number of moles of total HAP in the vessel headspace at  $T_2$

$n_{HAP,1}$  = number of moles of total HAP in the vessel headspace at  $T_1$

V = volume of free space in vessel

R = ideal gas law constant

$T_1$  = initial temperature of the vessel contents, absolute

$T_2$  = final temperature of the vessel contents, absolute

$P_{i,1}$  = partial pressure of the individual HAP compounds at  $T_1$

$P_{i,2}$  = partial pressure of the individual HAP compounds at  $T_2$

n = number of HAP compounds in the emission stream.

(E) *Depressurization*. Emissions from depressurization shall be calculated using the procedures in paragraphs (c)(2)(i)(E)(1) through (5) of this section. Alternatively, the owner or operator may elect to calculate emissions from depressurization using the procedures in paragraph (c)(2)(i)(E)(6) of this section.

(1) The moles of HAP vapor initially in the vessel are calculated using Equation 18 of this subpart:

$$n_{\text{HAP}} = \frac{V}{R T} \times \sum_{i=1}^n (P_i) \quad (\text{Eq. 18})$$

[View or download PDF](#)

Where:

$n_{\text{HAP}}$  = moles of HAP vapor in the vessel

$P_i$  = partial pressure of each HAP in the vessel vapor space

V = free volume in the vessel being depressurized

R = ideal gas law constant

T = absolute temperature in vessel

n = number of HAP compounds in the emission stream

(2) The initial and final moles of noncondensable gas present in the vessel are calculated using Equations 19 and 20 of this subpart:

$$n_1 = \frac{VP_{nc1}}{RT} \quad (\text{Eq. 19})$$

[View or download PDF](#)

$$n_2 = \frac{VP_{nc2}}{RT} \quad (\text{Eq. 20})$$

[View or download PDF](#)

Where:

$n_1$  = initial number of moles of noncondensable gas in the vessel

$n_2$  = final number of moles of noncondensable gas in the vessel

V = free volume in the vessel being depressurized

$P_{nc1}$  = initial partial pressure of the noncondensable gas, as calculated using Equation 21 of this subpart

$P_{nc2}$  = final partial pressure of the noncondensable gas, as calculated using Equation 22 of this subpart

R = ideal gas law constant

T = temperature, absolute

(3) The initial and final partial pressures of the noncondensable gas in the vessel are determined using Equations 21 and 22 of this subpart.

$$P_{nc1} = P_1 - \sum_{j=1}^m (P_j^*) (x_j) \quad (\text{Eq. 21})$$

[View or download PDF](#)

$$P_{nc2} = P_2 - \sum_{j=1}^m (P_j^*) (x_j) \quad (\text{Eq. 22})$$

[View or download PDF](#)

Where:

$P_{nc1}$  = initial partial pressure of the noncondensable gas

$P_{nc2}$  = final partial pressure of the noncondensable gas

$P_1$  = initial vessel pressure

$P_2$  = final vessel pressure

$P_j^*$  = vapor pressure of each condensable compound (including HAP) in the emission stream

$x_j$  = mole fraction of each condensable compound (including HAP) in the liquid phase

m = number of condensable compounds (including HAP) in the emission stream.

(4) The moles of HAP emitted during the depressurization are calculated by taking an approximation of the average ratio of moles of HAP to moles of noncondensable and multiplying by the total moles of noncondensables released during the depressurization, using Equation 23 of this subpart:

$$n_{HAP,e} = \frac{\left( \frac{n_{HAP,1}}{n_1} + \frac{n_{HAP,2}}{n_2} \right)}{2} [n_1 - n_2] \quad (\text{Eq. 23})$$

[View or download PDF](#)

Where:

$n_{\text{HAP}, e}$  = moles of HAP emitted

$n_{\text{HAP}, 1}$  = moles of HAP vapor in vessel at the initial pressure, as calculated using Equation 18 of this subpart

$n_{\text{HAP}, 2}$  = moles of HAP vapor in vessel at the final pressure, as calculated using Equation 18 of this subpart

$n_1$  = initial number of moles of noncondensable gas in the vessel, as calculated using Equation 19 of this subpart

$n_2$  = final number of moles of noncondensable gas in the vessel, as calculated using Equation 19 of this subpart.

(5) Use Equation 24 of this subpart to calculate the mass of HAP emitted:

$$E = n_{\text{HAP}, e} * MW_{\text{HAP}} \quad (\text{Eq. 24})$$

[View or download PDF](#)

Where:

E = mass of HAP emitted

$n_{\text{HAP}, e}$  = moles of HAP emitted, as calculated using Equation 23 of this subpart

$MW_{\text{HAP}}$  = average molecular weight of the HAP as calculated using Equation 14 of this subpart

(6) As an alternative to the procedures in paragraphs (c)(2)(i)(E)(1) through (5) of this section, emissions from depressurization may be calculated using Equation 25 of this subpart:

$$E = \frac{V}{(R)(T)} \times \ln \left( \frac{P_1 - \sum_{j=1}^m (P_j)}{P_2 - \sum_{j=1}^m (P_j)} \right) \times \sum_{i=1}^n (P_i) (MW_i) \quad (\text{Eq. 25})$$

[View or download PDF](#)

Where:

V = free volume in vessel being depressurized

R = ideal gas law constant

T = temperature of the vessel, absolute

$P_1$  = initial pressure in the vessel

$P_2$  = final pressure in the vessel



$P_i$  = partial pressure of the individual HAP compounds

$P_j$  = partial pressure of individual condensable VOC compounds (including HAP)

$MW_i$  = molecular weight of the individual HAP compounds

$n$  = number of HAP compounds in the emission stream

$m$  = number of condensable VOC compounds (including HAP) in the emission stream

(F) *Vacuum systems.* Calculate emissions from vacuum systems using Equation 26 of this subpart:

$$E = \frac{(MW_{HAP})(La)(t)}{MW_{nc}} \left( \frac{\sum_{i=1}^n P_i}{P_T - \sum_{j=1}^m P_j} \right) \quad (Eq. 26)$$

[View or download PDF](#)

Where:

$E$  = mass of HAP emitted

$P_T$  = absolute pressure of receiving vessel or ejector outlet conditions, if there is no receiver

$P_i$  = partial pressure of individual HAP at the receiver temperature or the ejector outlet conditions

$P_j$  = partial pressure of individual condensable compounds (including HAP) at the receiver temperature or the ejector outlet conditions

$La$  = total air leak rate in the system, mass/time

$MW_{nc}$  = molecular weight of noncondensable gas

$t$  = time of vacuum operation

$MW_{HAP}$  = average molecular weight of HAP in the emission stream, as calculated using Equation 14 of this subpart, with HAP partial pressures calculated at the temperature of the receiver or ejector outlet, as appropriate

$n$  = number of HAP components in the emission stream

$m$  = number of condensable compounds (including HAP) in the emission stream.

(G) *Gas evolution.* Emissions from gas evolution shall be calculated using Equation 10 of this subpart with  $V$  calculated using Equation 27 of this subpart:

$$V = \frac{(W_g)(R)(T)}{(P_T)(MW_g)} \quad (\text{Eq. 27})$$

[View or download PDF](#)

Where:

V = volumetric flow rate of gas evolution

$W_g$  = mass flow rate of gas evolution

R = ideal gas law constant

T = temperature at the exit, absolute

$P_T$  = vessel pressure

$MW_g$  = molecular weight of the evolved gas

(H) *Air drying.* Use Equation 28 of this subpart to calculate emissions from air drying:

$$E = B \times \left( \frac{PS_1}{100 - PS_1} - \frac{PS_2}{100 - PS_2} \right) \quad (\text{Eq. 28})$$

[View or download PDF](#)

Where:

E = mass of HAP emitted

B = mass of dry solids

$PS_1$  = HAP in material entering dryer, weight percent

$PS_2$  = HAP in material exiting dryer, weight percent.

(ii) *Engineering assessments.* The owner or operator shall conduct an engineering assessment to determine uncontrolled HAP emissions for each emission episode that is not due to vapor displacement, purging, heating, depressurization, vacuum systems, gas evolution, or air drying. For a given emission episode caused by any of these seven types of activities, the owner or operator also may request approval to determine uncontrolled HAP emissions based on an engineering assessment. Except as specified in paragraph (c)(2)(ii)(A) of this section, all data, assumptions, and procedures used in the engineering assessment shall be documented in the Precompliance plan in accordance with §63.1367(b). An engineering assessment includes, but is not limited to, the information and procedures described in paragraphs (c)(2)(ii)(A) through (D) of this section.

(A) Test results, provided the tests are representative of current operating practices at the process unit. For process vents without variable emission stream characteristics, an engineering assessment based on the

results of a previous test may be submitted in the Notification of Compliance Status report instead of the Precompliance plan. Results from a previous test of process vents with variable emission stream characteristics will be acceptable in place of values estimated using the procedures specified in paragraph (c)(2)(i) of this section if the test data show a greater than 20 percent discrepancy between the test value and the estimated value, and the results of the engineering assessment shall be included in the Notification of Compliance Status report. For other process vents with variable emission stream characteristics, engineering assessments based on the results of a previous test must be submitted in the Precompliance plan. For engineering assessments based on new tests, the owner or operator must comply with the test notification requirements in §63.1368(m), and the results of the engineering assessment may be submitted in the Notification of Compliance Status report rather than the Precompliance plan.

(B) Bench-scale or pilot-scale test data representative of the process under representative operating conditions.

(C) Maximum flow rate, HAP emission rate, concentration, or other relevant parameter specified or implied within a permit limit applicable to the process vent.

(D) Design analysis based on accepted chemical engineering principles, measurable process parameters, or physical or chemical laws or properties. Examples of analytical methods include, but are not limited to:

(1) Use of material balances based on process stoichiometry to estimate maximum organic HAP concentrations;

(2) Estimation of maximum flow rate based on physical equipment design such as pump or blower capacities; and

(3) Estimation of HAP concentrations based on saturation conditions.

(3) *Controlled emissions.* Except for condensers, the owner or operator shall determine controlled emissions using the procedures in either paragraph (c)(3)(i) or (ii) of this section, as applicable. For condensers, controlled emissions shall be calculated using the emission estimation equations described in paragraph (c)(3)(iii) of this section. The owner or operator is not required to calculate controlled emissions from devices described in paragraph (a)(4) of this section or from flares for which compliance is demonstrated in accordance with paragraph (a)(3) of this section. If the owner or operator is complying with an outlet concentration standard and the control device uses supplemental gases, the outlet concentrations shall be corrected in accordance with the procedures described in paragraph (a)(7) of this section.

(i) *Small control devices, except condensers.* Controlled emissions for each process vent that is controlled using a small control device, except for a condenser, shall be determined by using the design evaluation described in paragraph (c)(3)(i)(A) of this section, or by conducting a performance test in accordance with paragraph (c)(3)(ii) of this section.

(A) *Design evaluation.* The design evaluation shall include documentation demonstrating that the control device being used achieves the required control efficiency under absolute or hypothetical peak-case conditions, as determined from the emission profile described in paragraph (b)(11)(iii) of this section. The control efficiency determined from this design evaluation shall be applied to uncontrolled emissions to

estimate controlled emissions. The documentation must be conducted in accordance with the provisions in paragraph (a)(1) of this section. The design evaluation shall also include the value(s) and basis for the parameter(s) monitored under §63.1366.

(B) Whenever a small control device becomes a large control device, the owner or operator must comply with the provisions in paragraph (c)(3)(ii) of this section and submit the test report in the next Periodic report.

(ii) *Large control devices, except condensers.* Controlled emissions for each process vent that is controlled using a large control device, except for a condenser, shall be determined by applying the control efficiency of the large control device to the estimated uncontrolled emissions. The control efficiency shall be determined by conducting a performance test on the control device as described in paragraphs (c)(3)(ii)(A) through (C) of this section, or by using the results of a previous performance test as described in paragraph (c)(3)(ii)(D) of this section. If the control device is intended to control only HCl and chlorine, the owner or operator may assume the control efficiency of organic HAP is 0 percent. If the control device is intended to control only organic HAP, the owner or operator may assume the control efficiency for HCl and chlorine is 0 percent.

(A) Performance test measurements shall be conducted at both the inlet and outlet of the control device for TOC, total organic HAP, and total HCl and chlorine, as applicable, using the test methods and procedures described in paragraph (b) of this section. Concentrations shall be calculated from the data obtained through emission testing according to the procedures in paragraph (a)(2) of this section.

(B) Performance testing shall be conducted under absolute or hypothetical peak-case conditions, as defined in paragraphs (b)(11)(i) and (ii) of this section.

(C) The owner or operator may elect to conduct more than one performance test on the control device for the purpose of establishing more than one operating condition at which the control device achieves the required control efficiency.

(D) The owner or operator is not required to conduct a performance test for any control device for which a previous performance test was conducted, provided the test was conducted using the same procedures specified in paragraphs (b)(1) through (11) of this section over conditions typical of the absolute or hypothetical peak-case, as defined in paragraphs (b)(11)(i) and (ii) of this section. The results of the previous performance test shall be used to demonstrate compliance.

(iii) *Condensers.* The owner or operator using a condenser as a control device shall determine controlled emissions for each batch emission episode according to the engineering methodology in paragraphs (c)(3)(iii)(A) through (G) of this section. The owner or operator must establish the maximum outlet gas temperature and calculate the controlled emissions using this temperature in the applicable equation. Individual HAP partial pressures shall be calculated as specified in paragraph (c)(2)(i) of this section.

(A) Emissions from vapor displacement due to transfer of material to a vessel shall be calculated using Equation 9 of this subpart with T set equal to the temperature of the receiver and the HAP partial pressures determined at the temperature of the receiver.

(B) Emissions from purging shall be calculated using Equation 10 of this subpart with T set equal to the temperature of the receiver and the HAP partial pressures determined at the temperature of the receiver.

(C) Emissions from heating shall be calculated using Equation 29 of this subpart. In Equation 29 of this subpart,  $\Delta\eta$  is equal to the number of moles of noncondensable displaced from the vessel, as calculated using Equation 12 of this subpart. In Equation 29 of this subpart, the HAP average molecular weight shall be calculated using Equation 14 with the HAP partial pressures determined at the temperature of the receiver.

$$E = \Delta\eta \times \frac{\sum_{i=1}^n P_i}{P_T - \sum_{j=1}^m P_j} \times MW_{HAP} \quad (\text{Eq. 29})$$

[View or download PDF](#)

Where:

E = mass of HAP emitted

$\Delta\eta$  = moles of noncondensable gas displaced

$P_T$  = pressure in the receiver

$P_i$  = partial pressure of the individual HAP at the receiver temperature

$P_j$  = partial pressure of the individual condensable VOC (including HAP) at the receiver temperature

n = number of HAP compounds in the emission stream

$MW_{HAP}$  = the average molecular weight of HAP in vapor exiting the receiver, as calculated using Equation 14 of this subpart

m = number of condensable VOC (including HAP) in the emission stream

(D)(1) Emissions from depressurization shall be calculated using Equation 30 of this subpart.

$$E = (V_{n1} - V_{n2}) \times \frac{\sum_{i=1}^n (P_i)}{P_T - \sum_{j=1}^m (P_j)} \times \frac{P_T}{RT} \times MW_{HAP} \quad (\text{Eq. 30})$$

[View or download PDF](#)

Where:

E = mass of HAP vapor emitted

$V_{nc1}$  = initial volume of noncondensable in the vessel, corrected to the final pressure, as calculated using Equation 31 of this subpart

$V_{nc2}$  = final volume of noncondensable in the vessel, as calculated using Equation 32 of this subpart

$P_i$  = partial pressure of each individual HAP at the receiver temperature

$P_j$  = partial pressure of each condensable VOC (including HAP) at the receiver temperature

$P_T$  = receiver pressure

$T$  = temperature of the receiver, absolute

$R$  = ideal gas law constant

$MW_{HAP}$  = the average molecular weight of HAP calculated using Equation 14 of this subpart with partial pressures determined at the receiver temperature

$n$  = number of HAP compounds in the emission stream

$m$  = number of condensable VOC (including HAP) in the emission stream

(2) The initial and final volumes of noncondensable gas present in the vessel, adjusted to the pressure of the receiver, are calculated using Equations 31 and 32 of this subpart.

$$V_{nc1} = \frac{VP_{nc1}}{P_T} \quad (\text{Eq. 31})$$

[View or download PDF](#)

$$V_{nc2} = \frac{VP_{nc2}}{P_T} \quad (\text{Eq. 32})$$

[View or download PDF](#)

Where:

$V_{nc1}$  = initial volume of noncondensable gas in the vessel

$V_{nc2}$  = final volume of noncondensable gas in the vessel

$V$  = free volume in the vessel being depressurized

$P_{nc1}$  = initial partial pressure of the noncondensable gas, as calculated using Equation 33 of this subpart

$P_{nc2}$  = final partial pressure of the noncondensable gas, as calculated using Equation 34 of this subpart

$P_T$  = pressure of the receiver

(3) Initial and final partial pressures of the noncondensable gas in the vessel are determined using Equations 33 and 34 of this subpart.

$$P_{nc1} = P_1 - \sum_{j=1}^m P_j \quad (\text{Eq. 33})$$

[View or download PDF](#)

$$P_{nc2} = P_2 - \sum_{j=1}^m P_j \quad (\text{Eq. 34})$$

[View or download PDF](#)

Where:

$P_{nc1}$  = initial partial pressure of the noncondensable gas in the vessel

$P_{nc2}$  = final partial pressure of the noncondensable gas in the vessel

$P_1$  = initial vessel pressure

$P_2$  = final vessel pressure

$P_j$  = partial pressure of each condensable VOC (including HAP) in the vessel

$m$  = number of condensable VOC (including HAP) in the emission stream

(E) Emissions from vacuum systems shall be calculated using Equation 26 of this subpart.

(F) Emissions from gas evolution shall be calculated using Equation 8 with  $V$  calculated using Equation 27 of this subpart,  $T$  set equal to the receiver temperature, and the HAP partial pressures determined at the receiver temperature. The term for time,  $t$ , in Equation 10 of this subpart is not needed for the purposes of this calculation.

(G) Emissions from air drying shall be calculated using Equation 9 of this subpart with  $V$  equal to the air flow rate and  $P_i$  determined at the receiver temperature.

(d) *Initial compliance with storage vessel provisions.* The owner or operator of an existing or new affected source shall demonstrate initial compliance with the storage vessel standards in §63.1362(c)(2) through (4) by fulfilling the requirements in either paragraph (d)(1), (2), (3), (4), (5), or (6) of this section, as applicable. The owner or operator shall demonstrate initial compliance with the planned routine maintenance provision in §63.1362(c)(5) by fulfilling the requirements in paragraph (d)(7) of this section.

(1) *Percent reduction requirement for control devices.* If the owner or operator equips a Group 1 storage vessel with a closed vent system and control device, the owner or operator shall demonstrate initial compliance with the percent reduction requirement of §63.1362(c)(2)(iv)(A) or (c)(3) either by calculating the efficiency of the control device using performance test data as specified in paragraph

(d)(1)(i) of this section, or by preparing a design evaluation as specified in paragraph (d)(1)(ii) of this section.

(i) *Performance test option.* If the owner or operator elects to demonstrate initial compliance based on performance test data, the efficiency of the control device shall be calculated as specified in paragraphs (d)(1)(i)(A) through (D) of this section.

(A) At the reasonably expected maximum filling rate, Equations 35 and 36 of this subpart shall be used to calculate the mass rate of total organic HAP or TOC at the inlet and outlet of the control device.

$$E_i = K_2 \left( \sum_{j=1}^n C_{ij} M_{ij} \right) Q_i \quad (\text{Eq. 35})$$

[View or download PDF](#)

$$E_o = K_2 \left( \sum_{j=1}^n C_{oj} M_{oj} \right) Q_o \quad (\text{Eq. 36})$$

[View or download PDF](#)

Where:

$C_{ij}$ ,  $C_{oj}$  = concentration of sample component  $j$  of the gas stream at the inlet and outlet of the control device, respectively, dry basis, ppmv

$E_i$ ,  $E_o$  = mass rate of total organic HAP or TOC at the inlet and outlet of the control device, respectively, dry basis, kg/hr

$M_{ij}$ ,  $M_{oj}$  = molecular weight of sample component  $j$  of the gas stream at the inlet and outlet of the control device, respectively, g/gmole

$Q_i$ ,  $Q_o$  = flow rate of gas stream at the inlet and outlet of the control device, respectively, dscmm

$K_2$  = constant,  $2.494 \times 10^{-6}$  (parts per million)<sup>-1</sup> (gram-mole per standard cubic meter) (kilogram/gram) (minute/hour), where standard temperature is 20 °C.

(B) The percent reduction in total organic HAP or TOC shall be calculated using Equation 37 of this subpart:

$$R = \frac{E_i - E_o}{E_i} (100) \quad (\text{Eq. 37})$$

[View or download PDF](#)

Where:

$R$  = control efficiency of control device, percent



$E_i$  = mass rate of total organic HAP or TOC at the inlet to the control device as calculated under paragraph (d)(1)(i)(A) of this section, kilograms organic HAP per hour

$E_o$  = mass rate of total organic HAP or TOC at the outlet of the control device, as calculated under paragraph (d)(1)(i)(A) of this section, kilograms organic HAP per hour.

(C) A performance test is not required to be conducted if the control device used to comply with §63.1362(c) (storage tank provisions) is also used to comply with §63.1362(b) (process vent provisions), provided compliance with §63.1362(b) is demonstrated in accordance with paragraph (c) of this section and the demonstrated percent reduction is equal to or greater than 95 percent.

(D) A performance test is not required for any control device for which a previous test was conducted, provided the test was conducted using the same procedures specified in paragraph (b) of this section.

(ii) *Design evaluation option.* If the owner or operator elects to demonstrate initial compliance by conducting a design evaluation, the owner or operator shall prepare documentation in accordance with the design evaluation provisions in paragraph (a)(1) of this section, as applicable. The design evaluation shall demonstrate that the control device being used achieves the required control efficiency when the storage vessel is filled at the reasonably expected maximum filling rate.

(2) *Outlet concentration requirement for control devices.* If the owner or operator equips a Group 1 storage vessel with a closed vent system and control device, the owner or operator shall demonstrate initial compliance with the outlet concentration requirements of §63.1362(c)(2)(iv)(B) or (c)(3) by fulfilling the requirements of paragraph (a)(6) of this section.

(3) *Floating roof.* If the owner or operator equips a Group 1 storage vessel with a floating roof to comply with the provisions in §63.1362(c)(2) or (c)(3), the owner or operator shall demonstrate initial compliance by complying with the procedures described in paragraphs (d)(3)(i) and (ii) of this section.

(i) Comply with §63.119(b), (c), or (d) of subpart G of this part, as applicable, with the differences specified in §63.1362(d)(2)(i) through (iii).

(ii) Comply with the procedures described in §63.120(a), (b), or (c), as applicable, with the differences specified in paragraphs (d)(3)(ii)(A) through (C) of this section.

(A) When the term “storage vessel” is used in §63.120, the definition of the term “storage vessel” in §63.1361 shall apply for the purposes of this subpart.

(B) When the phrase “the compliance date specified in §63.100 of subpart F of this part” is referred to in §63.120, the phrase “the compliance date specified in §63.1364” shall apply for the purposes of this subpart.

(C) When the phrase “the maximum true vapor pressure of the total organic HAP in the stored liquid falls below the values defining Group 1 storage vessels specified in Table 5 or Table 6 of this subpart” is referred to in §63.120(b)(1)(iv), the phrase “the maximum true vapor pressure of the total organic HAP in the stored liquid falls below the values defining Group 1 storage vessels specified in §63.1361” shall apply for the purposes of this subpart.

(4) *Flares*. If the owner or operator controls the emissions from a Group 1 storage vessel with a flare, initial compliance is demonstrated by fulfilling the requirements in paragraph (a)(3) of this section.

(5) *Exemptions from initial compliance*. No initial compliance demonstration is required for control devices specified in paragraph (a)(4) of this section.

(6) *Initial compliance with alternative standard*. If the owner or operator equips a Group 1 storage vessel with a closed-vent system and control device, the owner or operator shall demonstrate initial compliance with the alternative standard in §63.1362(c)(4) by fulfilling the requirements of paragraph (a)(5) of this section.

(7) *Planned routine maintenance*. The owner or operator shall demonstrate initial compliance with the planned routine maintenance provisions of §63.1362(c)(5) by including the anticipated periods of planned routine maintenance for the first reporting period in the Notification of Compliance Status report as specified in §63.1368(f).

(e) *Initial compliance with wastewater provisions*. The owner or operator shall demonstrate initial compliance with the wastewater requirements by complying with the applicable provisions in §63.145, except that the owner or operator need not comply with the requirement to determine visible emissions that is specified in §63.145(j)(1), and references to compounds in Table 8 of subpart G of this part are not applicable for the purposes of this subpart. When §63.145(i) refers to Method 18 of 40 CFR part 60, appendix A-6, the owner or operator may use any method specified in §63.1362(d)(12) to demonstrate initial compliance with this subpart.

(f) *Initial compliance with the bag dump and product dryer provisions*. Compliance with the particulate matter concentration limits specified in §63.1362(e) is demonstrated when the concentration of particulate matter is less than 0.01 gr/dscf, as measured using the method described in paragraph (b)(7) of this section.

(g) *Initial compliance with the pollution prevention alternative standard*. The owner or operator shall demonstrate initial compliance with §63.1362(g)(2) and (3) for a PAI process unit by preparing the demonstration summary in accordance with paragraph (g)(1) of this section and by calculating baseline and target annual HAP and VOC factors in accordance with paragraphs (g)(2) and (3) of this section. To demonstrate initial compliance with §63.1362(g)(3), the owner or operator must also comply with the procedures for add-on control devices that are specified in paragraph (g)(4) of this section.

(1) *Demonstration summary*. The owner or operator shall prepare a pollution prevention demonstration summary that shall contain, at a minimum, the information in paragraphs (g)(1)(i) through (iii) of this section. The demonstration summary shall be included in the Precompliance report as specified in §63.1368(e)(4).

(i) Descriptions of the methodologies and forms used to measure and record consumption of HAP and VOC compounds.

(ii) Descriptions of the methodologies and forms used to measure and record production of the product(s).

(iii) Supporting documentation for the descriptions provided in accordance with paragraphs (g)(1)(i) and (ii) of this section including, but not limited to, operator log sheets and copies of daily, monthly, and annual inventories of materials and products. The owner or operator must show how this documentation will be used to calculate the annual factors required in §63.1366(f)(1).

(2) *Baseline factors.* The baseline HAP and VOC factors shall be calculated by dividing the consumption of total HAP and total VOC by the production rate, per process, for the first 3-year period in which the process was operational, beginning no earlier than the period consisting of the 1987 through 1989 calendar years. Alternatively, for a process that has been operational for less than 3 years, but more than 1 year, the baseline factors shall be established for the time period from startup of the process until the present.

(3) *Target annual factors.* The owner or operator must calculate target annual factors in accordance with either paragraph (g)(3)(i) or (ii) of this section.

(i) To demonstrate initial compliance with §63.1362(g)(2), the target annual HAP factor must be equal to or less than 15 percent of the baseline HAP factor. For each reduction in a HAP that is also a VOC, the target annual VOC factor must be lower than the baseline VOC factor by an equivalent amount on a mass basis. For each reduction in a HAP that is not a VOC, the target annual factor must be equal to or less than the baseline VOC factor.

(ii) To demonstrate initial compliance with §63.1362(g)(3)(i), the target annual HAP and VOC factors must be calculated as specified in paragraph (g)(3)(i) of this section, except that when “15 percent” is referred to in paragraph (g)(3)(i) of this section, “50 percent” shall apply for the purposes of this paragraph.

(4) *Requirements for add-on control devices.* Initial compliance with the requirements for add-on control devices in §63.1362(g)(3)(ii) is demonstrated when the requirements in paragraphs (g)(4)(i) through (iii) of this section are met.

(i) The yearly reductions associated with add-on controls that meet the criteria of §63.1362(g)(3)(ii)(A) through (D), must be equal to or greater than the amounts calculated using Equations 38 and 39 of this subpart:

$$HAP_{reduced} = (HF_{base})(0.85 - R_{P2})(M_{prod}) \quad (Eq. 38)$$

[View or download PDF](#)

$$VOC_{reduced} = (VF_{base} - VF_{P2} - VF_{annual}) \times M_{prod} \quad (Eq. 39)$$

[View or download PDF](#)

Where:

$HAP_{reduced}$  = the annual HAP emissions reduction required by add-on controls, kg/yr

$HF_{base}$  = the baseline HAP factor, kg HAP consumed/kg product

$R_{P2}$  = the fractional reduction in the annual HAP factor achieved using pollution prevention where  $R_{P2}$  is  $\geq 0.5$

$VOC_{reduced}$  = required VOC emission reduction from add-on controls, kg/yr

$VF_{base}$  = baseline VOC factor, kg VOC emitted/kg production

$VF_{P2}$  = reduction in VOC factor achieved by pollution prevention, kg VOC emitted/kg production

$VF_{annual}$  = target annual VOC factor, kg VOC emitted/kg production

$M_{prod}$  = production rate, kg/yr

(ii) Demonstration that the criteria in §63.1362(g)(3)(ii)(A) through (D) are met shall be accomplished through a description of the control device and of the material streams entering and exiting the control device.

(iii) The annual reduction achieved by the add-on control shall be quantified using the methods described in paragraph (c) of this section.

(h) *Compliance with emissions averaging provisions.* An owner or operator shall demonstrate compliance with the emissions averaging provisions of §63.1362(h) by fulfilling the requirements of paragraphs (h)(1) through (6) of this section.

(1) The owner or operator shall develop and submit for approval an Emissions Averaging Plan containing all the information required in §63.1367(d). The Emissions Averaging Plan shall be submitted no later than 18 months prior to the compliance date of the standard. The Administrator shall determine within 120 calendar days whether the Emissions Averaging Plan submitted by sources using emissions averaging presents sufficient information. The Administrator shall either approve the Emissions Averaging Plan, request changes, or request that the owner or operator submit additional information. Once the Administrator receives sufficient information, the Administrator shall approve, disapprove, or request changes to the plan within 120 days. If the Emissions Averaging Plan is disapproved, the owner or operator must still be in compliance with the standard by the compliance date.

(2) For all points included in an emissions average, the owner or operator shall comply with the procedures that are specified in paragraphs (h)(2)(i) through (v) of this section.

(i) Calculate and record monthly debits for all Group 1 emission points that are controlled to a level less stringent than the standard for those emission points. Equations in paragraph (h)(5) of this section shall be used to calculate debits.

(ii) Calculate and record monthly credits for all Group 1 and Group 2 emission points that are overcontrolled to compensate for the debits. Equations in paragraph (h)(6) of this section shall be used to calculate credits. All process vent, storage vessel, and wastewater emission points except those specified in §63.1362(h)(1) through (6) may be included in the credit calculation.

(iii) Demonstrate that annual credits calculated according to paragraph (h)(6) of this section are greater than or equal to debits calculated according to paragraph (h)(5) of this section for the same annual

compliance period. The initial demonstration in the Emissions Averaging Plan or operating permit application that credit-generating emission points will be capable of generating sufficient credits to offset the debit-generating emission points shall be made under representative operating conditions. After the compliance date, actual operating data shall be used for all debit and credit calculations.

(iv) Demonstrate that debits calculated for a quarterly (3-month) period according to paragraph (h)(5) of this section are not more than 1.30 times the credits for the same period calculated according to paragraph (h)(6) of this section. Compliance for the quarter shall be determined based on the ratio of credits and debits from that quarter, with 30 percent more debits than credits allowed on a quarterly basis.

(v) Record and report quarterly and annual credits and debits as required in §§63.1367(d) and 63.1368(d).

(3) [Reserved]

(4) During periods of monitoring excursions, credits and debits shall be adjusted as specified in paragraphs (h)(4)(i) through (iii) of this section.

(i) No credits shall be assigned to the credit-generating emission point.

(ii) Maximum debits shall be assigned to the debit-generating emission point.

(iii) The owner or operator may demonstrate to the Administrator that full or partial credits or debits should be assigned using the procedures in §63.150(l) of subpart G of this part.

(5) Debits are generated by the difference between the actual emissions from a Group 1 emission point that is uncontrolled or controlled to a level less stringent than the applicable standard and the emissions allowed for the Group 1 emission point. Debits shall be calculated in accordance with the procedures specified in paragraphs (h)(5)(i) through (iv) of this section.

(i) Source-wide debits shall be calculated using Equation 40 of this subpart.

Debits and all terms of Equation 40 of this subpart are in units of Mg/month

$$Debits = \sum_{i=1}^n [EPV_{iA} - (0.10)(EPV_{iU})] + \sum_{i=1}^n [ES_{iA} - (0.05)(ES_{iU})] + \sum_{i=1}^n [EWW_{iA} - (EWW_{iC})] \quad (Eq. 40)$$

[View or download PDF](#)

Where:

$EPV_{iU}$  = uncontrolled emissions from process i calculated according to the procedures specified in paragraph (h)(5)(ii) of this section

$EPV_{iA}$  = actual emissions from each Group 1 process i that is uncontrolled or is controlled to a level less stringent than the applicable standard.  $EPV_{iA}$  is calculated using the procedures in paragraph (h)(5)(ii) of this section

$ES_{iU}$  = uncontrolled emissions from storage vessel i calculated according to the procedures specified in paragraph (h)(5)(iii) of this section

$ES_{iA}$  = actual emissions from each Group 1 storage vessel  $i$  that is uncontrolled or is controlled to a level less stringent than the applicable standard.  $ES_{iA}$  is calculated using the procedures in paragraph (h)(5)(iii) of this section

$EW_{iC}$  = emissions from each Group 1 wastewater stream  $i$  if the standard had been applied to the uncontrolled emissions.  $EW_{iC}$  is calculated using the procedures in paragraph (h)(5)(iv) of this section

$EW_{iA}$  = actual emissions from each Group 1 wastewater stream  $i$  that is uncontrolled or is controlled to a level less stringent than the applicable standard.  $EW_{iA}$  is calculated using the procedures in paragraph (h)(5)(iv) of this section

$n$  = the number of emission points being included in the emissions average; the value of  $n$  is not necessarily the same for process vents, storage tanks, and wastewater

(ii) Emissions from process vents shall be calculated in accordance with the procedures specified in paragraphs (h)(5)(ii)(A) through (C) of this section.

(A) Except as provided in paragraph (h)(5)(ii)(C) of this section, uncontrolled emissions for process vents shall be calculated using the procedures that are specified in paragraph (c)(2) of this section.

(B) Except as provided in paragraph (h)(5)(ii)(C) of this section, actual emissions for process vents shall be calculated using the procedures specified in paragraphs (c)(2) and (c)(3) of this section, as applicable.

(C) As an alternative to the procedures described in paragraphs (h)(5)(ii)(A) and (B) of this section, for continuous processes, uncontrolled and actual emissions may be calculated by the procedures described in §63.150(g)(2) of subpart G of this part. For purposes of complying with this paragraph, a 90 percent reduction shall apply instead of the 98 percent reduction in §63.150(g)(2)(iii) of subpart G of this part, and the term “process condenser” shall apply instead of the term “recovery device” in §63.150(g)(2) for the purposes of this subpart.

(iii) Uncontrolled emissions from storage vessels shall be calculated in accordance with the procedures described in paragraph (d)(1) of this section. Actual emissions from storage vessels shall be calculated using the procedures specified in §63.150(g)(3)(ii), (iii), or (iv) of subpart G of this subpart, as appropriate, except that when §63.150(g)(3)(ii)(B) refers to the procedures in §63.120(d) for determining percent reduction for a control device, §63.1365(d)(2) or (3) shall apply for the purposes of this subpart.

(iv) Emissions from wastewater shall be calculated using the procedures specified in §63.150(g)(5) of subpart G of this part.

(6) Credits are generated by the difference between emissions that are allowed for each Group 1 and Group 2 emission point and the actual emissions from that Group 1 or Group 2 emission point that have been controlled after November 15, 1990 to a level more stringent than what is required in this subpart or any other State or Federal rule or statute. Credits shall be calculated in accordance with the procedures specified in paragraphs (h)(6)(i) through (v) of this section.

(i) Source-wide credits shall be calculated using Equation 41 of this subpart. Credits and all terms in Equation 41 of this subpart are in units of Mg/month, the baseline date is November 15, 1990, the terms consisting of a constant multiplied by the uncontrolled emissions are the emissions from each emission

point subject to the standards in §63.1362(b) and (c) that is controlled to a level more stringent than the standard.

$$Credits = D \sum_{i=1}^n [(0.10)(EPV1_{iU}) - EPV1_{iA}] + D \sum_{i=1}^m (EPV2_{iB} - EPV2_{iA}) + D \sum_{i=1}^n [(0.05)(ES1_{iU}) - ES1_{iA}] + D \sum_{i=1}^m (ES2_{iB} - ES2_{iA}) + D \sum_{i=1}^n (EWW1_{iC} - EWW1_{iA}) + D \sum_{i=1}^m (EWW2_{iB} - EWW2_{iA}) \quad (Eq. 41)$$

[View or download PDF](#)

Where:

EPV1<sub>iU</sub> = uncontrolled emissions from each Group 1 process i calculated according to the procedures in paragraph (h)(6)(iii)(A) of this section

EPV1<sub>iA</sub> = actual emissions from each Group 1 process i that is controlled to a level more stringent than the applicable standard. EPV1<sub>iA</sub> is calculated according to the procedures in paragraph (h)(6)(iii)(B) of this section

EPV2<sub>iB</sub> = emissions from each Group 2 process i at the baseline date. EPV2<sub>iB</sub> is calculated according to the procedures in paragraph (h)(6)(iii)(C) of this section

EPV2<sub>iA</sub> = actual emissions from each Group 2 process i that is controlled. EPV2<sub>iA</sub> is calculated according to the procedures in paragraph (h)(6)(iii)(C) of this section

ES1<sub>iU</sub> = uncontrolled emissions from each Group 1 storage vessel i calculated according to the procedures in paragraph (h)(6)(iv) of this section

ES1<sub>iA</sub> = actual emissions from each Group 1 storage vessel i that is controlled to a level more stringent than the applicable standard. ES1<sub>iA</sub> is calculated according to the procedures in paragraph (h)(6)(iv) of this section

ES2<sub>iB</sub> = emissions from each Group 2 storage vessel i at the baseline date. ES2<sub>iB</sub> is calculated according to the procedures in paragraph (h)(6)(iv) of this section

ES2<sub>iA</sub> = actual emissions from each Group 2 storage vessel i that is controlled. ES2<sub>iA</sub> is calculated according to the procedures in paragraph (h)(6)(iv) of this section

EWW1<sub>iC</sub> = emissions from each Group 1 wastewater stream i if the standard had been applied to the uncontrolled emissions. EWW1<sub>iC</sub> is calculated according to the procedures in paragraph (h)(6)(v) of this section

EWW1<sub>iA</sub> = emissions from each Group 1 wastewater stream i that is controlled to a level more stringent than the applicable standard. EWW1<sub>iA</sub> is calculated according to the procedures in paragraph (h)(6)(v) of this section

EWW2<sub>iB</sub> = emissions from each Group 2 wastewater stream i at the baseline date. EWW2<sub>iB</sub> is calculated according to the procedures in paragraph (h)(6)(v) of this section

$EWV2_{iA}$  = actual emissions from each Group 2 wastewater stream  $i$  that is controlled.  $EWV2_{iA}$  is calculated according to the procedures in paragraph (h)(6)(v) of this section

$n$  = number of Group 1 emission points that are included in the emissions average. The value of  $n$  is not necessarily the same for process vents, storage tanks, and wastewater

$m$  = number of Group 2 emission points included in the emissions average. The value of  $m$  is not necessarily the same for process vents, storage tanks, and wastewater

$D$  = discount factor equal to 0.9 for all credit-generating emission points except those controlled by a pollution prevention measure, which will not be discounted

(ii) For an emission point controlled using a pollution prevention measure, the nominal efficiency for calculating credits shall be as determined as described in §63.150(j) of subpart G of this part.

(iii) Emissions from process vents shall be calculated in accordance with the procedures specified in paragraphs (h)(6)(iii)(A) through (C) of this section.

(A) Uncontrolled emissions from Group 1 process vents shall be calculated according to the procedures in paragraph (h)(5)(ii)(A) or (C) of this section.

(B) Actual emissions from Group 1 process vents with a nominal efficiency greater than the applicable standard or a pollution prevention measure that achieves reductions greater than the applicable standard shall be calculated using Equation 42 of this subpart:

$$EPV1_{iA} = EPV1_{iU} \times \left[ 1 - \frac{N_{eff}}{100} \right] \quad (Eq. 42)$$

[View or download PDF](#)

Where:

$EPV1_{iA}$  = actual emissions from each Group 1 process  $i$  that is controlled to a level more stringent than the applicable standard

$EPV1_{iU}$  = uncontrolled emissions from each Group 1 process  $i$

$N_{eff}$  = nominal efficiency of control device or pollution prevention measure, percent

(C) Baseline and actual emissions from Group 2 process vents shall be calculated according to the procedures in §63.150(h)(2)(iii) and (iv) with the following modifications:

(1) The term “90 percent reduction” shall apply instead of the term “98 percent reduction”; and

(2) When the phrase “paragraph (g)(2)” is referred to in §63.150(h)(2)(iii) and (iv), the provisions in paragraph (h)(5)(ii) of this section shall apply for the purposes of this subpart.

(iv) Uncontrolled emissions from storage vessels shall be calculated according to the procedures described in paragraph (d)(1) of this section. Actual and baseline emissions from storage tanks shall be calculated according to the procedures specified in §63.150(h)(3) of subpart G of this part, except when



§63.150(h)(3) refers to §63.150(g)(3)(i), paragraph (d)(1) of this section shall apply for the purposes of this subpart.

(v) Emissions from wastewater shall be calculated using the procedures in §63.150(h)(5) of subpart G of this part.

[64 FR 33589, June 23, 1999, as amended at 67 FR 59347, Sept. 20, 2002; 79 FR 17374, Mar. 27, 2014]

[↑ Back to Top](#)

### **§63.1366 Monitoring and inspection requirements.**

(a) To provide evidence of continued compliance with the standard, the owner or operator of any existing or new affected source shall install, operate, and maintain monitoring devices as specified in this section. During the initial compliance demonstration, maximum or minimum operating parameter levels, or other design and operating characteristics, as appropriate, shall be established for emission sources that will indicate the source is in compliance. Test data, calculations, or information from the evaluation of the control device design, as applicable, shall be used to establish the operating parameter level or characteristic.

(b) *Monitoring for control devices*—(1) *Parameters to monitor.* Except as specified in paragraph (b)(1)(i) of this section, for each control device, the owner or operator shall install and operate monitoring devices and operate within the established parameter levels to ensure continued compliance with the standard. Monitoring parameters are specified for control scenarios in paragraphs (b)(1)(ii) through (xii) of this section, and are summarized in Table 3 of this subpart.

(i) *Periodic verification.* For control devices that control vent streams containing total HAP emissions less than 0.91 Mg/yr, before control, monitoring shall consist of a periodic verification that the device is operating properly. This verification shall include, but not be limited to, a daily or more frequent demonstration that the unit is working as designed and may include the daily measurements of the parameters described in paragraphs (b)(1)(ii) through (xii) of this section. This demonstration shall be included in the Precompliance plan, to be submitted 6 months prior to the compliance date of the standard.

(ii) *Scrubbers.* For affected sources using liquid scrubbers, the owner or operator shall establish a minimum scrubber liquid flow rate or pressure drop as a site-specific operating parameter which must be measured and recorded at least once every 15 minutes during the period in which the scrubber is controlling HAP from an emission stream as required by the standards in §63.1362. If the scrubber uses a caustic solution to remove acid emissions, the pH of the effluent scrubber liquid shall also be monitored once a day. The minimum scrubber liquid flow rate or pressure drop shall be based on the conditions under which the initial compliance demonstration was conducted. Alternatively, for halogen scrubbers, the owner or operator may comply with the requirements specified in §63.994(c).

(A) The monitoring device used to determine the pressure drop shall be certified by the manufacturer to be accurate to within a gage pressure of  $\pm 10$  percent of the maximum pressure drop measured.

(B) The monitoring device used for measurement of scrubber liquid flowrate shall be certified by the manufacturer to be accurate to within  $\pm 10$  percent of the design scrubber liquid flowrate.

(C) The monitoring device shall be calibrated annually.

(iii) *Condensers*. For each condenser, the owner or operator shall establish the maximum condenser outlet gas temperature as a site-specific operating parameter which must be measured and recorded at least once every 15 minutes during the period in which the condenser is controlling HAP from an emission stream as required by the standards in §63.1362.

(A) The temperature monitoring device must be accurate to within  $\pm 2$  percent of the temperature measured in degrees Celsius or  $\pm 2.5$  °C, whichever is greater.

(B) The temperature monitoring device must be calibrated annually.

(iv) *Regenerative carbon adsorbers*. For each regenerative carbon adsorber, the owner or operator shall comply with the provisions in paragraphs (b)(1)(iv)(A) through (F) of this section.

(A) Establish the regeneration cycle characteristics specified in paragraphs (b)(1)(iv)(A) (1) through (4) of this section under absolute or hypothetical peak-case conditions, as defined in §63.1365(b)(11)(i) or (ii).

(1) Minimum regeneration frequency (i.e., operating time since last regeneration);

(2) Minimum temperature to which the bed is heated during regeneration;

(3) Maximum temperature to which the bed is cooled, measured within 15 minutes of completing the cooling phase; and

(4) Minimum regeneration stream flow.

(B) Monitor and record the regeneration cycle characteristics specified in paragraphs (b)(1)(iv)(B) (1) through (4) of this section for each regeneration cycle.

(1) Regeneration frequency (i.e., operating time since end of last regeneration);

(2) Temperature to which the bed is heated during regeneration;

(3) Temperature to which the bed is cooled, measured within 15 minutes of the completion of the cooling phase; and

(4) Regeneration stream flow.

(C) Use a temperature monitoring device that is accurate to within  $\pm 2$  percent of the temperature measured in degrees Celsius or  $\pm 2.5$  °C, whichever is greater.

(D) Use a regeneration stream flow monitoring device capable of recording the total regeneration stream flow to within  $\pm 10$  percent of the established value (i.e., accurate to within  $\pm 10$  percent of the reading).

(E) Calibrate the temperature and flow monitoring devices annually.

(F) Conduct an annual check for bed poisoning in accordance with manufacturer's specifications.

(v) *Nonregenerative carbon adsorbers.* For each nonregenerative carbon adsorption system such as a carbon canister that does not regenerate the carbon bed directly onsite in the control device, the owner or operator shall replace the existing carbon bed in the control device with fresh carbon on a regular schedule based on one of the following procedures:

(A) Monitor the TOC concentration level in the exhaust vent stream from the carbon adsorption system on a regular schedule, and replace the existing carbon with fresh carbon immediately when carbon breakthrough is indicated. The monitoring frequency shall be daily or at an interval no greater than 20 percent of the time required to consume the total carbon working capacity under absolute or hypothetical peak-case conditions as defined in §63.1365(b)(11)(i) or (ii), whichever is longer.

(B) Establish the maximum time interval between replacement, and replace the existing carbon before this time interval elapses. The time interval shall be established based on the conditions anticipated under absolute or hypothetical peak-case, as defined in §63.1365(b)(11)(i) or (ii).

(vi) *Flares.* For each flare, the presence of the pilot flame shall be monitored at least once every 15 minutes during the period in which the flare is controlling HAP from an emission stream subject to the standards in §63.1362. The monitoring device shall be calibrated annually.

(vii) *Thermal incinerators.* For each thermal incinerator, the owner or operator shall monitor the temperature of the gases exiting the combustion chamber as the site-specific operating parameter which must be measured and recorded at least once every 15 minutes during the period in which the combustion device is controlling HAP from an emission stream subject to the standards in §63.1362.

(A) The temperature monitoring device must be accurate to within  $\pm 0.75$  percent of the temperature measured in degrees Celsius or  $\pm 2.5$  °C, whichever is greater.

(B) The monitoring device must be calibrated annually.

(viii) *Catalytic incinerators.* For each catalytic incinerator, the parameter levels that the owner or operator shall establish are the minimum temperature of the gas stream immediately before the catalyst bed and the minimum temperature difference across the catalyst bed. The owner or operator shall monitor the temperature of the gas stream immediately before and after the catalyst bed, and calculate the temperature difference across the catalyst bed, at least once every 15 minutes during the period in which the catalytic incinerator is controlling HAP from an emission stream subject to the standards in §63.1362.

(A) The temperature monitoring devices must be accurate to within  $\pm 0.75$  percent of the temperature measured in degrees Celsius or  $\pm 2.5$  °C, whichever is greater.

(B) The temperature monitoring devices must be calibrated annually.

(ix) *Process heaters and boilers.* (A) Except as specified in paragraph (b)(1)(ix)(B) of this section, for each boiler or process heater, the owner or operator shall monitor the temperature of the gases exiting the combustion chamber as the site-specific operating parameter which must be monitored and recorded at least every 15 minutes during the period in which the boiler or process heater is controlling HAP from an emission stream subject to the standards in §63.1362.

(1) The temperature monitoring device must be accurate to within  $\pm 0.75$  percent of the temperature measured in degrees Celsius or  $\pm 2.5$  °C, whichever is greater.

(2) The temperature monitoring device must be calibrated annually.

(B) The owner or operator is exempt from the monitoring requirements specified in paragraph (b)(1)(ix)(A) of this section if either:

(1) All vent streams are introduced with primary fuel; or

(2) The design heat input capacity of the boiler or process heater is 44 megawatts or greater.

(x) *Continuous emission monitor.* As an alternative to the parameters specified in paragraphs (b)(1)(ii) through (ix) of this section, an owner or operator may monitor and record the outlet HAP concentration or both the outlet TOC concentration and outlet total HCl and chlorine concentration at least every 15 minutes during the period in which the control device is controlling HAP from an emission stream subject to the standards in §63.1362. The owner or operator need not monitor the total HCl and chlorine concentration if the owner or operator determines that the emission stream does not contain HCl or chlorine. The owner or operator need not monitor the TOC concentration if the owner or operator determines the emission stream does not contain organic compounds. The HAP or TOC monitor must meet the requirements of Performance Specification 8 or 9 of appendix B of part 60 and must be installed, calibrated, and maintained, according to §63.8 of subpart A of this part. As part of the QA/QC Plan, calibration of the device must include, at a minimum, quarterly cylinder gas audits. If supplemental gases are introduced before the control device, the monitored concentration shall be corrected as specified in §63.1365(a)(7).

(xi) *Fabric filters.* For each fabric filter used to control particulate matter emissions from bag dumps and product dryers subject to §63.1362(e), the owner or operator shall install, calibrate, maintain, and continuously operate a bag leak detection system that meets the requirements in paragraphs (b)(1)(xi)(A) through (G) of this section.

(A) The bag leak detection system sensor must provide output of relative particulate matter emissions.

(B) The bag leak detection system must be equipped with an alarm system that will sound when an increase in particulate matter emissions over a preset level is detected.

(C) For positive pressure fabric filters, a bag leak detector must be installed in each fabric filter compartment or cell. If a negative pressure or induced air filter is used, the bag leak detector must be installed downstream of the fabric filter. Where multiple bag leak detectors are required (for either type of fabric filter), the system instrumentation and alarm may be shared among detectors.

(D) The bag leak detection system shall be installed, operated, calibrated and maintained in a manner consistent with available guidance from the U.S. Environmental Protection Agency or, in the absence of such guidance, the manufacturer's written specifications and instructions.

(E) Calibration of the system shall, at a minimum, consist of establishing the relative baseline output level by adjusting the range and the averaging period of the device and establishing the alarm set points and the alarm delay time.

(F) Following initial adjustment, the owner or operator shall not adjust the sensitivity or range, averaging period, alarm set points, or alarm delay time, except as established in an operation and maintenance plan that is to be submitted with the Precompliance plan. In no event shall the sensitivity be increased more than 100 percent or decreased by more than 50 percent over a 365-day period unless such adjustment follows a complete baghouse inspection which demonstrates the baghouse is in good operating condition.

(G) If the alarm on a bag leak detection system is triggered, the owner or operator shall, within 1 hour of an alarm, initiate the procedures to identify the cause of the alarm and take corrective action as specified in the corrective action plan.

(xii) For each waste management unit, treatment process, or control device used to comply with §63.1362(d), the owner or operator shall comply with the procedures specified in §63.143 of subpart G of this part, except that when the procedures to request approval to monitor alternative parameters according to the procedures in §63.151(f) are referred to in §63.143(d)(3), the procedures in paragraph (b)(4) of this section shall apply for the purposes of this subpart.

(xiii) *Closed-vent system visual inspections.* The owner or operator shall comply with the requirements in either paragraph (b)(1)(xiii)(A) or (B) of this section:

(A) Set the flow indicator at the entrance to any bypass line that could divert the stream away from the control device to the atmosphere to take a reading at least once every 15 minutes; or

(B) If the bypass device valve installed at the inlet to the bypass device is secured in the closed position with a car-seal or lock-and-key type configuration, visually inspect the seal or closure mechanism at least once every month to verify that the valve is maintained in the closed position and the vent stream is not diverted through the bypass line.

(2) *Averaging periods.* Averaging periods for parametric monitoring levels shall be established according to paragraphs (b)(2)(i) through (iii) of this section.

(i) Except as provided in paragraph (b)(2)(iii) of this section, a daily (24-hour) or block average shall be calculated as the average of all values for a monitored parameter level set according to the procedures in (b)(3)(iii) of this section recorded during the operating day or block.

(ii) The operating day or block shall be defined in the Notification of Compliance Status report. The operating day may be from midnight to midnight or another continuous 24-hour period. The operating block may be used as an averaging period only for vents from batch operations, and is limited to a period of time that is, at a maximum, equal to the time from the beginning to end of a series of consecutive batch operations.

(iii) Monitoring values taken during periods in which the control devices are not controlling HAP from an emission stream subject to the standards in §63.1362, as indicated by periods of no flow or periods when only streams that are not subject to the standards in §63.1362 are controlled, shall not be considered in the averages. Where flow to the device could be intermittent, the owner or operator shall install, calibrate and operate a flow indicator at the inlet or outlet of the control device to identify periods of no flow.

(3) *Procedures for setting parameter levels for control devices used to control emissions from process vents.* (i) *Small control devices.* Except as provided in paragraph (b)(1)(i) of this section, for devices controlling less than 10 tons/yr of HAP for which a performance test is not required, the parameteric levels shall be set based on the design evaluation required in §63.1365(c)(3)(i)(A). If a performance test is conducted, the monitoring parameter level shall be established according to the procedures in paragraph (b)(3)(ii) of this section.

(ii) *Large control devices.* For devices controlling greater than or equal to 10 tons/yr of HAP for which a performance test is required, the parameter level must be established as follows:

(A) If the operating parameter level to be established is a maximum or minimum, it must be based on the average of the average values from each of the three test runs.

(B) The owner or operator may establish the parametric monitoring level(s) based on the performance test supplemented by engineering assessments and/or manufacturer's recommendations. Performance testing is not required to be conducted over the entire range of expected parameter values. The rationale for the specific level for each parameter, including any data and calculations used to develop the level(s) and a description of why the level indicates proper operation of the control device shall be provided in the Precompliance plan. Determination of the parametric monitoring level using these procedures is subject to review and approval by the Administrator.

(iii) *Parameter levels for control devices controlling batch process vents.* For devices controlling batch process vents alone or in combination with other streams, the level(s) shall be established in accordance with paragraph (b)(3)(iii)(A) or (B) of this section.

(A) A single level for the batch process(es) shall be calculated from the initial compliance demonstration.

(B) The owner or operator may establish separate levels for each batch emission episode or combination of emission episodes selected to be controlled. If separate monitoring levels are established, the owner or operator must provide a record indicating at what point in the daily schedule or log of processes required to be recorded per the requirements of §63.1367(b)(7), the parameter being monitored changes levels and must record at least one reading of the new parameter level, even if the duration of monitoring for the new parameter level is less than 15 minutes.

(4) *Requesting approval to monitor alternative parameters.* The owner or operator may request approval to monitor parameters other than those required by paragraphs (b)(1)(ii) through (xiii) of this section. The request shall be submitted according to the procedures specified in §63.8(f) of subpart A of this part or in the Precompliance report (as specified in §63.1368(e)).

(5) *Monitoring for the alternative standards.* (i) For control devices that are used to comply with the provisions of §63.1362(b)(6) and (c)(4), the owner or operator shall monitor and record the outlet TOC concentration and the outlet total HCl and chlorine concentration at least once every 15 minutes during the period in which the device is controlling HAP from emission streams subject to the standards in §63.1362. A TOC monitor meeting the requirements of Performance Specification 8 or 9 of appendix B of 40 CFR part 60 shall be installed, calibrated, and maintained, according to §63.8. The owner or operator need not monitor the total HCl and chlorine concentration if the owner or operator determines that the emission stream does not contain HCl or chlorine. The owner or operator need not monitor for

TOC concentration if the owner or operator determines that the emission stream does not contain organic compounds.

(ii) If supplemental gases are introduced before the control device, the owner or operator must either correct for supplemental gases as specified in §63.1365(a)(7) or, if using a combustion control device, comply with the requirements of paragraph (b)(5)(ii)(A) of this section. If the owner or operator corrects for supplemental gases as specified in §63.1365(a)(7)(ii) for non-combustion control devices, the flow rates must be evaluated as specified in paragraph (b)(5)(ii)(B) of this section.

(A) *Provisions for combustion devices.* As an alternative to correcting for supplemental gases as specified in §63.1365(a)(7), the owner or operator may monitor residence time and firebox temperature according to the requirements of paragraphs (b)(5)(ii)(A)(1) and (2) of this section. Monitoring of residence time may be accomplished by monitoring flow rate into the combustion chamber.

(1) If complying with the alternative standard instead of achieving a control efficiency of 95 percent or less, the owner or operator must maintain a minimum residence time of 0.5 seconds and a minimum combustion chamber temperature of 760 °C.

(2) If complying with the alternative standard instead of achieving a control efficiency of 98 percent, the owner or operator must maintain a minimum residence time of 0.75 seconds and a minimum combustion chamber temperature of 816 °C.

(B) *Flow rate evaluation for non-combustion devices.* To demonstrate continuous compliance with the requirement to correct for supplemental gases as specified in §63.1365(a)(7)(ii) for non-combustion devices, the owner or operator must evaluate the volumetric flow rate of supplemental gases,  $V_s$ , and the volumetric flow rate of all gases,  $V_a$ , each time a new operating scenario is implemented based on process knowledge and representative operating data. The procedures used to evaluate the flow rates, and the resulting correction factor used in Equation 8 of this subpart, must be included in the Notification of Compliance Status report and in the next Periodic report submitted after an operating scenario change.

(6) *Exceedances of operating parameters.* An exceedance of an operating parameter is defined as one of the following:

(i) If the parameter level, averaged over the operating day or block, is below a minimum value established during the initial compliance demonstration.

(ii) If the parameter level, averaged over the operating day or block, is above the maximum value established during the initial compliance demonstration.

(iii) A loss of all pilot flames for a flare during an operating day or block. Multiple losses of all pilot flames during an operating day constitutes one exceedance.

(iv) Each operating day or block for which the time interval between replacement of a nonregenerative carbon adsorber exceeds the interval established in paragraph (b)(1)(v) of this section.

(v) Each instance in which procedures to initiate the response to a bag leak detector alarm within 1 hour of the alarm as specified in the corrective action plan.

(7) *Excursions.* Excursions are defined by either of the two cases listed in paragraph (b)(7)(i) or (ii) of this section. An excursion also occurs if the periodic verification for a small control device is not conducted as specified in paragraph (b)(1)(i) of this section.

(i) When the period of control device operation is 4 hours or greater in an operating day or block and monitoring data are insufficient to constitute a valid hour of data, as defined in paragraph (b)(7)(iii) of this section, for at least 75 percent of the operating hours.

(ii) When the period of control device operation is less than 4 hours in an operating day or block and more than 1 of the hours during the period of operation does not constitute a valid hour of data due to insufficient monitoring data.

(iii) Monitoring data are insufficient to constitute a valid hour of data, as used in paragraphs (b)(7)(i) and (ii) of this section, if measured values are unavailable for any of the required 15-minute periods within the hour.

(8) *Violations.* Exceedances of parameters monitored according to the provisions of paragraphs (b)(1)(ii), (b)(1)(iv) through (ix), and (b)(5) of this section, or excursions as defined by paragraphs (b)(7)(i) and (ii) of this section, constitute violations of the operating limit according to paragraphs (b)(8)(i) and (ii) of this section. Exceedances of the temperature limit monitored according to the provisions of paragraph (b)(1)(iii) of this section or exceedances of the outlet concentrations monitored according to the provisions of paragraph (b)(1)(x) of this section constitute violations of the emission limit according to paragraphs (b)(8)(i) and (ii) of this section. Exceedances of the outlet concentrations monitored according to the provisions of paragraph (b)(5) of this section constitute violations of the emission limit according to the provisions of paragraph (b)(8)(iii) of this section.

(i) For episodes occurring more than once per day, exceedances of established parameter limits or excursions will result in no more than one violation per operating day for each monitored item of equipment utilized in the process.

(ii) For control devices used for more than one process in the course of an operating day, exceedances or excursions will result in no more than one violation per operating day, per control device, for each process for which the control device is in service.

(iii) Exceedances of the 20 or 50 ppmv TOC outlet emission limit, averaged over the operating day, will result in no more than one violation per day per control device. Exceedances of the 20 or 50 ppmv HCl and chlorine outlet emission limit, averaged over the operating day, will result in no more than one violation per day per control device.

(c) *Monitoring for uncontrolled emission rates.* The owner or operator shall demonstrate continuous compliance with the emission limit in §63.1362 (b)(2)(i) or (b)(4)(i) by calculating daily a 365-day rolling summation of uncontrolled emissions based on the uncontrolled emissions per emission episode, as calculated using the procedures in §63.1365(c)(2), and records of the number of batches produced. Each day that the summation for a process exceeds 0.15 Mg/yr is considered a violation of the emission limit.

(d) *Monitoring for equipment leaks.* The standard for equipment leaks is based on monitoring. All monitoring requirements for equipment leaks are specified in §63.1363.



(e) *Monitoring for heat exchanger systems.* The standard for heat exchanger systems is based on monitoring. All monitoring requirements for heat exchanger systems are specified in §63.1362(f).

(f) *Monitoring for the pollution prevention alternative standard.* The owner or operator of an affected source that chooses to comply with the requirements of §63.1362(g) (2) or (3) shall calculate annual rolling average values of the HAP and VOC factors in accordance with the procedures specified in paragraph (f)(1) of this section. If complying with §63.1362(g)(3), the owner or operator shall also comply with the monitoring requirements specified in paragraph (b) of this section for the applicable add-on air pollution control device.

(1) *Annual factors.* The annual HAP and VOC factors shall be calculated in accordance with the procedures specified in paragraphs (f)(1) (i) through (iii) of this section.

(i) The consumption of both total HAP and total VOC shall be divided by the production rate, per process, for 12-month periods at the frequency specified in either paragraph (f)(1) (ii) or (iii) of this section, as applicable.

(ii) For continuous processes, the annual factors shall be calculated every 30 days for the 12-month period preceding the 30th day (annual rolling average calculated every 30 days). A process with both batch and continuous operations is considered a continuous process for the purposes of this section.

(iii) For batch processes, the annual factors shall be calculated every 10 batches for the 12-month period preceding the 10th batch (annual rolling average calculated every 10 batches). Additional annual factors shall be calculated every 12 months during the period before the 10th batch if more than 12 months elapse before the 10th batch is produced.

(2) *Violations.* Each rolling average that exceeds the target value established in §63.1365(g)(3) is considered a violation of the emission limit.

(g) *Monitoring for emissions averaging.* The owner or operator of an affected source that chooses to comply with the requirements of §63.1362(h) shall meet all monitoring requirements specified in paragraph (b) of this section, as applicable, for all processes, storage tanks, and waste management units included in the emissions average.

(h) *Leak inspection provisions for vapor suppression equipment.* (1) Except as provided in paragraphs (h)(9) and (10) of this section, for each vapor collection system, closed-vent system, fixed roof, cover, or enclosure required to comply with this section, the owner or operator shall comply with the requirements of paragraphs (h)(2) through (8) of this section.

(2) Except as provided in paragraphs (h)(6) and (7) of this section, each vapor collection system and closed-vent system shall be inspected according to the procedures and schedule specified in paragraphs (h)(2)(i) and (ii) of this section and each fixed roof, cover, and enclosure shall be inspected according to the procedures and schedule specified in paragraph (h)(2)(iii) of this section.

(i) If the vapor collection system or closed-vent system is constructed of hard-piping, the owner or operator shall:

(A) Conduct an initial inspection according to the procedures in paragraph (h)(3) of this section, and

(B) Conduct annual visual inspections for visible, audible, or olfactory indications of leaks.

(ii) If the vapor collection system or closed-vent system is constructed of ductwork, the owner or operator shall:

(A) Conduct an initial inspection according to the procedures in paragraph (h)(3) of this section,

(B) Conduct annual inspections according to the procedures in paragraph (h)(3) of this section, and

(C) Conduct annual visual inspections for visible, audible, or olfactory indications of leaks.

(iii) For each fixed roof, cover, and enclosure, the owner or operator shall:

(A) Conduct an initial inspection according to the procedures in paragraph (h)(3) of this section, and

(B) Conduct semiannual visual inspections for visible, audible, or olfactory indications of leaks.

(3) Each vapor collection system, closed-vent system, fixed roof, cover, and enclosure shall be inspected according to the procedures specified in paragraphs (h)(3)(i) through (vi) of this section.

(i) Inspections shall be conducted in accordance with Method 21 of 40 CFR part 60, appendix A.

(ii) *Detection instrument performance criteria.* (A) Except as provided in paragraph (h)(3)(ii)(B) of this section, the detection instrument shall meet the performance criteria of Method 21 of 40 CFR part 60, appendix A, except the instrument response factor criteria in section 3.1.2(a) of Method 21 shall be for the average composition of the process fluid not each individual VOC in the stream. For process streams that contain nitrogen, air, or other inerts which are not organic HAP or VOC, the average stream response factor shall be calculated on an inert-free basis.

(B) If no instrument is available at the plant site that will meet the performance criteria specified in paragraph (h)(3)(ii)(A) of this section, the instrument readings may be adjusted by multiplying by the average response factor of the process fluid, calculated on an inert-free basis as described in paragraph (h)(3)(ii)(A) of this section.

(iii) The detection instrument shall be calibrated before use on each day of its use by the procedures specified in Method 21 of 40 CFR part 60, appendix A.

(iv) Calibration gases shall be as follows:

(A) Zero air (less than 10 parts per million hydrocarbon in air); and

(B) Mixtures of methane in air at a concentration less than 10,000 parts per million. A calibration gas other than methane in air may be used if the instrument does not respond to methane or if the instrument does not meet the performance criteria specified in paragraph (h)(2)(ii)(A) of this section. In such cases, the calibration gas may be a mixture of one or more of the compounds to be measured in air.

(v) An owner or operator may elect to adjust or not adjust instrument readings for background. If an owner or operator elects to not adjust readings for background, all such instrument readings shall be compared directly to the applicable leak definition to determine whether there is a leak. If an owner or

operator elects to adjust instrument readings for background, the owner or operator shall measure background concentration using the procedures in §63.180(b) and (c). The owner or operator shall subtract background reading from the maximum concentration indicated by the instrument.

(vi) The arithmetic difference between the maximum concentration indicated by the instrument and the background level shall be compared with 500 parts per million for determining compliance.

(4) Leaks, as indicated by an instrument reading greater than 500 parts per million above background or by visual inspections, shall be repaired as soon as practicable, except as provided in paragraph (h)(5) of this section.

(i) A first attempt at repair shall be made no later than 5 calendar days after the leak is detected.

(ii) Repair shall be completed no later than 15 calendar days after the leak is detected.

(5) Delay of repair of a vapor collection system, closed-vent system, fixed roof, cover, or enclosure for which leaks have been detected is allowed if the repair is technically infeasible without a shutdown, as defined in §63.1361, or if the owner or operator determines that emissions resulting from immediate repair would be greater than the fugitive emissions likely to result from delay of repair. Repair of such equipment shall be complete by the end of the next shutdown.

(6) Any parts of the vapor collection system, closed-vent system, fixed roof, cover, or enclosure that are designated, as described in §63.1367(f)(1), as unsafe-to-inspect are exempt from the inspection requirements of paragraphs (h)(2)(i), (ii), and (iii) of this section if:

(i) The owner or operator determines that the equipment is unsafe-to-inspect because inspecting personnel would be exposed to an imminent or potential danger as a consequence of complying with paragraph (h)(2)(i), (ii), or (iii) of this section; and

(ii) The owner or operator has a written plan that requires inspection of the equipment as frequently as practicable during safe-to-inspect times. Inspection is not required more than once annually.

(7) Any parts of the vapor collection system, closed-vent system, fixed roof, cover, or enclosure that are designated, as described in §63.1367(f)(2), as difficult-to-inspect are exempt from the inspection requirements of paragraphs (h)(2)(i), (ii), and (iii)(A) of this section if:

(i) The owner or operator determines that the equipment cannot be inspected without elevating the inspecting personnel more than 2 meters above a support surface; and

(ii) The owner or operator has a written plan that requires inspection of the equipment at least once every 5 years.

(8) Records shall be maintained as specified in §63.1367(f).

(9) If a closed-vent system subject to this section is also subject to the equipment leak provisions of §63.1363, the owner or operator shall comply with the provisions of §63.1363 and is exempt from the requirements of this section.

(10) For any closed-vent system that is operated and maintained under negative pressure, the owner or operator is not required to comply with the requirements specified in paragraphs (h)(2) through (8) of this section.

[64 FR 33589, June 23, 1999, as amended at 67 FR 59352, Sept. 20, 2002; 68 FR 37358, June 23, 2003; 71 FR 20460, Apr. 20, 2006; 79 FR 17374, Mar. 27, 2014]

[↑ Back to Top](#)

### **§63.1367 Recordkeeping requirements.**

(a) *Requirements of subpart A of this part.* The owner or operator of an affected source shall comply with the recordkeeping requirements in subpart A of this part as specified in Table 1 of this subpart and in paragraphs (a)(1) through (5) of this section.

(1) *Data retention.* Each owner or operator of an affected source shall keep copies of all records and reports required by this subpart for at least 5 years, as specified in §63.10(b)(1) of subpart A of this part.

(2) *Records of applicability determinations.* The owner or operator of a stationary source that is not subject to this subpart shall keep a record of the applicability determination, as specified in §63.10(b)(3) of subpart A of this part.

(3) *Records of malfunctions.* (i) In the event that an affected unit fails to meet an applicable standard, record the number of failures. For each failure record the date, time, and duration of each failure.

(ii) For each failure to meet an applicable standard, record and retain a list of the affected sources or equipment, an estimate of the quantity of each regulated pollutant emitted over any emission limit, and a description of the method used to estimate the emissions.

(iii) Record actions taken to minimize emissions in accordance with §63.1360(e)(4), and any corrective actions taken to return the affected unit to its normal or usual manner of operation.

(4) *Recordkeeping requirements for sources with continuous monitoring systems.* The owner or operator of an affected source who installs a continuous monitoring system to comply with the alternative standards in §63.1362(b)(6) or (c)(4) shall maintain records specified in §63.10(c)(1) through (14) of subpart A of this part.

(5) *Application for approval of construction or reconstruction.* For new affected sources, each owner or operator shall comply with the provisions regarding construction and reconstruction in §63.5 of subpart A of this part.

(b) *Records of equipment operation.* The owner or operator must keep the records specified in paragraphs (b)(1) through (11) of this section up-to-date and readily accessible.

(1) Each measurement of a control device operating parameter monitored in accordance with §63.1366 and each measurement of a treatment process parameter monitored in accordance with the provisions of §63.1362(d).

(2) For processes subject to §63.1362(g), records of consumption, production, and the rolling average values of the HAP and VOC factors.

(3) For each continuous monitoring system used to comply with the alternative standards in §63.1362(b)(6) and (c)(4), records documenting the completion of calibration checks and maintenance of the continuous monitoring systems.

(4) For processes in compliance with the 0.15 Mg/yr emission limit of §63.1362(b)(2)(i) or (b)(4)(i), daily records of the rolling annual calculations of uncontrolled emissions.

(5) For each bag leak detector used to monitor particulate HAP emissions from a fabric filter, the owner or operator shall maintain records of any bag leak detection alarm, including the date and time, with a brief explanation of the cause of the alarm and the corrective action taken.

(6) The owner or operator of an affected source that complies with the standards for process vents, storage tanks, and wastewater systems shall maintain up-to-date, readily accessible records of the information specified in paragraphs (b)(6)(i) through (vii) of this section to document that HAP emissions or HAP loadings (for wastewater) are below the limits specified in §63.1362:

(i) Except as specified in paragraph (b)(6)(ix) of this section, the initial calculations of uncontrolled and controlled emissions of gaseous organic HAP and HCl per batch for each process.

(ii) The wastewater concentrations and flow rates per POD and process.

(iii) The number of batches per year for each batch process.

(iv) The operating hours per year for continuous processes.

(v) The number of batches and the number of operating hours for processes that contain both batch and continuous operations.

(vi) The number of tank turnovers per year, if used in an emissions average or for determining applicability of a new PAI process unit.

(vii) A description of absolute or hypothetical peak-case operating conditions as determined using the procedures in §63.1365(b)(11).

(viii) Periods of planned routine maintenance as described in §63.1362(c)(5).

(ix) As an alternative to the records in paragraph (b)(6)(i) of this section, a record of the determination that the conditions in §63.1365(b)(11)(iii)(D)(1) or (2) are met.

(7) Daily schedule or log of each operating scenario updated daily or, at a minimum, each time a different operating scenario is put into operation.

(8) If the owner or operator elects to comply with the vapor balancing alternative in §63.1362(c)(6), the owner or operator must keep records of the DOT certification required by §63.1362(c)(6)(ii) and the pressure relief vent setting and leak detection records specified in §63.1362(c)(6)(v).

(9) If the owner or operator elects to develop process unit groups, the owner or operator must keep records of the PAI and non-PAI process units in the process unit group, including records of the operating time for process units used to establish the process unit group. The owner or operator must also keep records of any redetermination of the primary product for the process unit group.

(10) All maintenance performed on the air pollution control equipment.

(11) If the owner or operator elects to comply with §63.1362(c) by installing a floating roof, the owner or operator must keep records of each inspection and seal gap measurement in accordance with §63.123(c) through (e) as applicable.

(c) *Records of equipment leak detection and repair.* The owner or operator of an affected source subject to the equipment leak standards in §63.1363 shall implement the recordkeeping requirements specified in §63.1363(g). All records shall be retained for a period of 5 years, in accordance with the requirements of §63.10(b)(1) of subpart A of this part.

(d) *Records of emissions averaging.* The owner or operator of an affected source that chooses to comply with the requirements of §63.1362(h) shall maintain up-to-date records of the following information:

(1) An Emissions Averaging Plan which shall include in the plan, for all emission points included in each of the emissions averages, the information listed in paragraphs (d)(1)(i) through (v) of this section.

(i) The identification of all emission points in each emissions average.

(ii) The values of all parameters needed for input to the emission debits and credits equations in §63.1365(h).

(iii) The calculations used to obtain the debits and credits.

(iv) The estimated values for all parameters required to be monitored under §63.1366(g) for each emission point included in an average. These parameter values, or as appropriate, limited ranges for parameter values, shall be specified as enforceable operating conditions for the operation of the process, storage vessel, or waste management unit, as appropriate. Changes to the parameters must be reported as required by §63.1368(k).

(v) A statement that the compliance demonstration, monitoring, inspection, recordkeeping and reporting provisions in §63.1365(h), §63.1366(g), and §63.1368(k) that are applicable to each emission point in the emissions average will be implemented beginning on the date of compliance.

(2) The Emissions Averaging Plan shall demonstrate that the emissions from the emission points proposed to be included in the average will not result in greater hazard or, at the option of the operating permit authority, greater risk to human health or the environment than if the emission points were controlled according to the provisions in §63.1362(b) through (d).

(i) This demonstration of hazard or risk equivalency shall be made to the satisfaction of the operating permit authority.

(A) The Administrator may require an owner or operator to use specific methodologies and procedures for making a hazard or risk determination.

(B) The demonstration and approval of hazard or risk equivalency shall be made according to any guidance that the Administrator makes available for use or any other technically sound information or methods.

(ii) An Emissions Averaging Plan that does not demonstrate hazard or risk equivalency to the satisfaction of the Administrator shall not be approved. The Administrator may require such adjustments to the Emissions Averaging Plan as are necessary in order to ensure that the average will not result in greater hazard or risk to human health or the environment than would result if the emission points were controlled according to §63.1362(b) through (d).

(iii) A hazard or risk equivalency demonstration must satisfy the requirements specified in paragraphs (d)(2)(iii) (A) through (C) of this section.

(A) Be a quantitative, comparative chemical hazard or risk assessment;

(B) Account for differences between averaging and nonaveraging options in chemical hazard or risk to human health or the environment; and

(C) Meet any requirements set by the Administrator for such demonstrations.

(3) Records as specified in paragraphs (a) and (b) of this section.

(4) A calculation of the debits and credits as specified in §63.1365(h) for the last quarter and the prior four quarters.

(e) The owner or operator of an affected source subject to the requirements for heat exchanger systems in §63.1362(g) shall retain the records as specified in §63.104(f)(1)(i) through (iv).

(f) *Records of inspections.* The owner or operator shall keep records specified in paragraphs (f)(1) through (6) of this section.

(1) Records identifying all parts of the vapor collection system, closed-vent system, fixed roof, cover, or enclosure that are designated as unsafe to inspect in accordance with §63.1366(h)(6), an explanation of why the equipment is unsafe-to-inspect, and the plan for inspecting the equipment.

(2) Records identifying all parts of the vapor collection system, closed-vent system, fixed roof, cover, or enclosure that are designated as difficult-to-inspect in accordance with §63.1366(h)(7), an explanation of why the equipment is difficult-to-inspect, and the plan for inspecting the equipment.

(3) For each vapor collection system or closed-vent system that contains bypass lines that could divert a vent stream away from the control device and to the atmosphere, the owner or operator shall keep a record of the information specified in either paragraph (f)(3)(i) or (ii) of this section.

(i) Hourly records of whether the flow indicator specified under §63.1362(j)(1) was operating and whether a diversion was detected at any time during the hour, as well as records of the times and

durations of all periods when the vent stream is diverted from the control device or the flow indicator is not operating.

(ii) Where a seal mechanism is used to comply with §63.1362(j)(2), hourly records of flow are not required. In such cases, the owner or operator shall record that the monthly visual inspection of the seals or closure mechanisms has been done and shall record the occurrence of all periods when the seal mechanism is broken, the bypass line valve position has changed, or the key for a lock-and-key type lock has been checked out, and records of any car-seal that has broken.

(4) For each inspection conducted in accordance with §63.1366(h)(2) and (3) during which a leak is detected, a record of the information specified in paragraphs (f)(4)(i) through (ix) of this section.

(i) Identification of the leaking equipment.

(ii) The instrument identification numbers and operator name or initials, if the leak was detected using the procedures described in §63.1366(h)(3); or a record of that the leak was detected by sensory observations.

(iii) The date the leak was detected and the date of the first attempt to repair the leak.

(iv) Maximum instrument reading measured by the method specified in §63.1366(h)(4) after the leak is successfully repaired or determined to be nonrepairable.

(v) “Repair delayed” and the reason for the delay if a leak is not repaired within 15 calendar days after discovery of the leak.

(vi) The name, initials, or other form of identification of the owner or operator (or designee) whose decision it was that repair could not be effected without a shutdown.

(vii) The expected date of successful repair of the leak if a leak is not repaired within 15 calendar days.

(viii) Dates of shutdowns that occur while the equipment is unrepaired.

(ix) The date of successful repair of the leak.

(5) For each inspection conducted in accordance with §63.1366(h)(3) during which no leaks are detected, a record that the inspection was performed, the date of the inspection, and a statement that no leaks were detected.

(6) For each visual inspection conducted in accordance with §63.1366(h)(2)(i)(B) or (iii)(B) of this section during which no leaks are detected, a record that the inspection was performed, the date of the inspection, and a statement that no leaks were detected.

(g) *Records of primary use.* For a PAI process unit that is used to produce a given material for use as a PAI as well as for other purposes, the owner or operator shall keep records of the total production and the production for use as a PAI on a semiannual or more frequent basis if the use as a PAI is not the primary use.

[64 FR 33589, June 23, 1999, as amended at 67 FR 59353, Sept. 20, 2002; 71 FR 20460, Apr. 20, 2006; 79 FR 17374, Mar. 27, 2014]



[↑ Back to Top](#)

### **§63.1368 Reporting requirements.**

(a) The owner or operator of an affected source shall comply with the reporting requirements of paragraphs (b) through (l) of this section. The owner or operator shall also comply with applicable paragraphs of §§63.9 and 63.10 of subpart A of this part, as specified in Table 1 of this subpart.

(b) *Initial notification.* The owner or operator shall submit the applicable initial notification in accordance with §63.9(b) or (d) of subpart A of this part.

(c) *Application for approval of construction or reconstruction.* The owner or operator who is subject to §63.5(b)(3) of subpart A of this part shall submit to the Administrator an application for approval of the construction of a new major source, the reconstruction of a major affected source, or the reconstruction of a major affected source subject to the standards. The application shall be prepared in accordance with §63.5(d) of subpart A of this part.

(d) *Notification of continuous monitoring system performance evaluation.* An owner or operator who is required by the Administrator to conduct a performance evaluation for a continuous monitoring system that is used to comply with the alternative standard in §63.1362(b)(6) or (c)(4) shall notify the Administrator of the date of the performance evaluation as specified in §63.8(e)(2) of subpart A of this part.

(e) *Precompliance plan.* The Precompliance plan shall be submitted at least 3 months prior to the compliance date of the standard. For new sources, the Precompliance plan shall be submitted to the Administrator with the application for approval of construction or reconstruction. The Administrator shall have 90 days to approve or disapprove the Precompliance plan. The Precompliance plan shall be considered approved if the Administrator either approves it in writing, or fails to disapprove it in writing within the 90-day time period. The 90-day period shall begin when the Administrator receives the Precompliance plan. If the Precompliance plan is disapproved, the owner or operator must still be in compliance with the standard by the compliance date. To change any of the information submitted in the Precompliance plan or to submit a Precompliance plan for the first time after the compliance date, the owner or operator shall notify the Administrator at least 90 days before the planned change is to be implemented; the change shall be considered approved if the Administrator either approves the change in writing, or fails to disapprove the change in writing within 90 days of receipt of the change. The Precompliance plan shall include the information specified in paragraphs (e)(1) through (5) of this section.

(1) Requests for approval to use alternative monitoring parameters or requests to set monitoring parameters according to §63.1366(b)(4).

(2) Descriptions of the daily or per batch demonstrations to verify that control devices subject to §63.1366(b)(1)(i) are operating as designed.

(3) Data and rationale used to support the parametric monitoring level(s) that are set according to §63.1366(b)(3)(ii)(B).

(4) For owners and operators complying with the requirements of §63.1362(g), the pollution prevention demonstration summary required in §63.1365(g)(1).

(5) Data and rationale used to support an engineering assessment to calculate uncontrolled emissions from process vents as required in §63.1365(c)(2)(ii).

(6) For fabric filters that are monitored with bag leak detectors, an operation and maintenance plan that describes proper operation and maintenance procedures, and a corrective action plan that describes corrective actions to be taken, and the timing of those actions, when the particulate matter concentration exceeds the setpoint and activates the alarm.

(f) *Notification of compliance status report.* The Notification of Compliance Status report required under §63.9(h) shall be submitted no later than 150 calendar days after the compliance date and shall include the information specified in paragraphs (f)(1) through (7) of this section.

(1) The results of any applicability determinations, emission calculations, or analyses used to identify and quantify HAP emissions from the affected source.

(2) The results of emissions profiles, performance tests, engineering analyses, design evaluations, or calculations used to demonstrate compliance. For performance tests, results should include descriptions of sampling and analysis procedures and quality assurance procedures.

(3) Descriptions of monitoring devices, monitoring frequencies, and the values of monitored parameters established during the initial compliance determinations, including data and calculations to support the levels established.

(4) Operating scenarios.

(5) Descriptions of absolute or hypothetical peak-case operating and/or testing conditions for control devices.

(6) Identification of emission points subject to overlapping requirements described in §63.1360(i) and the authority under which the owner or operator will comply, and identification of emission sources discharging to devices described by §63.1362(l).

(7) Anticipated periods of planned routine maintenance during which the owner or operator would not be in compliance with the provisions in §63.1362(c)(1) through (4).

(8) Percentage of total production from a PAI process unit that is anticipated to be produced for use as a PAI in the 3 years after either June 23, 1999 or startup, whichever is later.

(9) Records of the initial process units used to create each process unit group, if applicable.

(g) *Periodic reports.* The owner or operator shall prepare Periodic reports in accordance with paragraphs (g)(1) and (2) of this section and submit them to the Administrator.

(1) *Submittal schedule.* Except as provided in paragraphs (g)(1)(i) and (ii) of this section, the owner or operator shall submit Periodic reports semiannually. The first report shall be submitted no later than 240 days after the date the Notification of Compliance Status report is due and shall cover the 6-month period

beginning on the date the Notification of Compliance Status report is due. Each subsequent Periodic report shall cover the 6-month period following the preceding period and shall be submitted no later than 60 days after the end of the applicable period.

(i) The Administrator may determine on a case-by-case basis that more frequent reporting is necessary to accurately assess the compliance status of the affected source.

(ii) Quarterly reports shall be submitted when the monitoring data are used to comply with the alternative standards in §63.1362(b)(6) or (c)(4) and the source experiences excess emissions. Once an affected source reports excess emissions, the affected source shall follow a quarterly reporting format until a request to reduce reporting frequency is approved. If an owner or operator submits a request to reduce the frequency of reporting, the provisions in §63.10(e)(3) (ii) and (iii) of subpart A of this part shall apply, except that the term “excess emissions and continuous monitoring system performance report and/or summary report” shall mean “Periodic report” for the purposes of this section.

(2) *Content of periodic report.* The owner or operator shall include the information in paragraphs (g)(2)(i) through (xii) of this section, as applicable.

(i) Each Periodic report must include the information in §63.10(e)(3)(vi)(A) through (M) of subpart A of this part, as applicable.

(ii) If the total duration of excess emissions, parameter exceedances, or excursions for the reporting period is 1 percent or greater of the total operating time for the reporting period, or the total continuous monitoring system downtime for the reporting period is 5 percent or greater of the total operating time for the reporting period, the Periodic report must include the information in paragraphs (g)(2)(ii)(A) through (D) of this section.

(A) Monitoring data, including 15-minute monitoring values as well as daily average values of monitored parameters, for all operating days when the average values were outside the ranges established in the Notification of Compliance Status report or operating permit.

(B) Duration of excursions, as defined in §63.1366(b)(7).

(C) Operating logs and operating scenarios for all operating days when the values are outside the levels established in the Notification of Compliance Status report or operating permit.

(D) When a continuous monitoring system is used, the information required in §63.10(c)(5) through (13) of subpart A of this part.

(iii) For each vapor collection system or closed vent system with a bypass line subject to §63.1362(j)(1), records required under §63.1366(f) of all periods when the vent stream is diverted from the control device through a bypass line. For each vapor collection system or closed vent system with a bypass line subject to §63.1362(j)(2), records required under §63.1366(f) of all periods in which the seal mechanism is broken, the bypass valve position has changed, or the key to unlock the bypass line valve was checked out.

(iv) The information in paragraphs (g)(2)(iv)(A) through (D) of this section shall be stated in the Periodic report, when applicable.

- (A) No excess emissions.
  - (B) No exceedances of a parameter.
  - (C) No excursions.
  - (D) No continuous monitoring system has been inoperative, out of control, repaired, or adjusted.
  - (v) For each storage vessel subject to control requirements:
    - (A) Actual periods of planned routine maintenance during the reporting period in which the control device does not meet the specifications of §63.1362(c)(5); and
    - (B) Anticipated periods of planned routine maintenance for the next reporting period.
  - (vi) For each PAI process unit that does not meet the definition of primary use, the percentage of the production in the reporting period produced for use as a PAI.
  - (viii) Updates to the corrective action plan.
  - (ix) Records of process units added to each process unit group, if applicable.
  - (x) Records of redetermination of the primary product for a process unit group.
  - (xi) For each inspection conducted in accordance with §63.1366(h)(2) or (3) during which a leak is detected, the records specify in §63.1367(h)(4) must be included in the next Periodic report.
  - (xii) If the owner or operator elects to comply with the provisions of §63.1362(c) by installing a floating roof, the owner or operator shall submit the information specified in §63.122(d) through (f) as applicable. References to §63.152 in §63.122 shall not apply for the purposes of this subpart.
- (h) *Notification of process change.* (1) Except as specified in paragraph (h)(2) of this section, whenever a process change is made, or any of the information submitted in the Notification of Compliance Status report changes, the owner or operator shall submit the information specified in paragraphs (h)(1)(i) through (iv) of this section with the next Periodic report required under paragraph (g) of this section. For the purposes of this section, a process change means the startup of a new process, as defined in §63.1361.
- (i) A brief description of the process change;
  - (ii) A description of any modifications to standard procedures or quality assurance procedures;
  - (iii) Revisions to any of the information reported in the original Notification of Compliance Status report under paragraph (f) of this section; and
  - (iv) Information required by the Notification of Compliance Status report under paragraph (f) of this section for changes involving the addition of processes or equipment.
- (2) The owner or operator must submit a report 60 days before the scheduled implementation date of either of the following:

(i) Any change in the activity covered by the Precompliance report.

(ii) A change in the status of a control device from small to large.

(i) *Reports of malfunctions.* If a source fails to meet an applicable standard, report such events in the Periodic Report. Report the number of failures to meet an applicable standard. For each instance, report the date, time, and duration of each failure. For each failure the report must include a list of the affected sources or equipment, an estimate of the quantity of each regulated pollutant emitted over any emission limit, and a description of the method used to estimate the emissions.

(j) *Reports of equipment leaks.* The owner or operator of an affected source subject to the standards in §63.1363, shall implement the reporting requirements specified in §63.1363(h). Copies of all reports shall be retained as records for a period of 5 years, in accordance with the requirements of §63.10(b)(1) of subpart A of this part.

(k) *Reports of emissions averaging.* The owner or operator of an affected source that chooses to comply with the requirements of §63.1362(h) shall submit all information as specified in §63.1367(d) for all emission points included in the emissions average. The owner or operator shall also submit to the Administrator all information specified in paragraph (g) of this section for each emission point included in the emissions average.

(1) The reports shall also include the information listed in paragraphs (k)(1)(i) through (iv) of this section:

(i) Any changes to the processes, storage tanks, or waste management unit included in the average.

(ii) The calculation of the debits and credits for the reporting period.

(iii) Changes to the Emissions Averaging Plan which affect the calculation methodology of uncontrolled or controlled emissions or the hazard or risk equivalency determination.

(iv) Any changes to the parameters monitored according to §63.1366(g).

(2) Every second semiannual or fourth quarterly report, as appropriate, shall include the results according to §63.1367(d)(4) to demonstrate the emissions averaging provisions of §§63.1362(h), 63.1365(h), 63.1366(g), and 63.1367(d) are satisfied.

(l) *Reports of heat exchange systems.* The owner or operator of an affected source subject to the requirements for heat exchange systems in §63.1362(f) shall submit information about any delay of repairs as specified in §63.104(f)(2) of subpart F of this part, except that when the phrase “periodic reports required by §63.152(c) of subpart G of this part” is referred to in §63.104(f)(2) of subpart F of this part, the periodic reports required in paragraph (g) of this section shall apply for the purposes of this subpart.

(m) *Notification of performance test and test Plan.* The owner or operator of an affected source shall notify the Administrator of the planned date of a performance test at least 60 days before the test in accordance with §63.7(b) of subpart A of this part. The owner or operator also must submit the test Plan required by §63.7(c) of subpart A of this part and the emission profile required by §63.1365(b)(11)(iii) with the notification of the performance test.

(n) *Request for extension of compliance.* The owner or operator may submit to the Administrator a request for an extension of compliance in accordance with §63.1364(a)(2).

(o) The owner or operator who submits an operating permit application before the date the Emissions Averaging Plan is due shall submit the information specified in paragraphs (o)(1) through (3) of this section with the operating permit application instead of the Emissions Averaging Plan.

(1) The information specified in §63.1367(d) for emission points included in the emissions average;

(2) The information specified in §63.9(h) of subpart A of this part, as applicable; and

(3) The information specified in paragraph (e) of this section, as applicable.

(p) *Electronic reporting.* Within 60 days after the date of completing each performance test (as defined in §63.2), the owner or operator must submit the results of the performance tests, including any associated fuel analyses, required by this subpart according to the methods specified in paragraphs (p)(1) or (2) of this section.

(1) For data collected using test methods supported by the EPA-provided software, the owner or operator shall submit the results of the performance test to the EPA by direct computer-to-computer electronic transfer via EPA-provided software, unless otherwise approved by the Administrator. Owners or operators, who claim that some of the information being submitted for performance tests is confidential business information (CBI), must submit a complete file using EPA-provided software that includes information claimed to be CBI on a compact disk, flash drive, or other commonly used electronic storage media to the EPA. The electronic media must be clearly marked as CBI and mailed to U.S. EPA/OAPQS/CORE CBI Office, Attention: WebFIRE Administrator, MD C404-02, 4930 Old Page Rd., Durham, NC 27703. The same file with the CBI omitted must be submitted to the EPA by direct computer-to-computer electronic transfer via EPA-provided software.

(2) For any performance test conducted using test methods that are not compatible with the EPA-provided software, the owner or operator shall submit the results of the performance test to the Administrator at the appropriate address listed in §60.4.

[64 FR 33589, June 23, 1999, as amended at 66 FR 58396, Nov. 21, 2001; 67 FR 59354, Sept. 20, 2002; 79 FR 17375, Mar. 27, 2014]

[↑ Back to Top](#)

### **§63.1369 Implementation and enforcement.**

(a) This subpart can be implemented and enforced by the U.S. EPA, or a delegated authority such as the applicable State, local, or Tribal agency. If the U.S. EPA Administrator has delegated authority to a State, local, or Tribal agency, then that agency, in addition to the U.S. EPA, has the authority to implement and enforce this subpart. Contact the applicable U.S. EPA Regional Office to find out if implementation and enforcement of this subpart is delegated to a State, local, or Tribal agency.

(b) In delegating implementation and enforcement authority of this subpart to a State, local, or Tribal agency under subpart E of this part, the authorities contained in paragraph (c) of this section are retained by the Administrator of U.S. EPA and cannot be transferred to the State, local, or Tribal agency.

(c) The authorities that cannot be delegated to State, local, or Tribal agencies are as specified in paragraphs (c)(1) through (4) of this section.

(1) Approval of alternatives to the requirements in §§63.1360 and 63.1362 through 63.1364. Where these standards reference another subpart, the cited provisions will be delegated according to the delegation provisions of the referenced subpart. Where these standards reference another subpart and modify the requirements, the requirements shall be modified as described in this subpart. Delegation of the modified requirements will also occur according to the delegation provisions of the referenced subpart.

(2) Approval of major alternatives to test methods for under §63.7(e)(2)(ii) and (f), as defined in §63.90, and as required in this subpart.

(3) Approval of major alternatives to monitoring under §63.8(f), as defined in §63.90, and as required in this subpart.

(4) Approval of major alternatives to recordkeeping and reporting under §63.10(f), as defined in §63.90, and as required in this subpart.

[68 FR 37358, June 23, 2003]

[↑ Back to Top](#)

**Table 1 to Subpart MMM of Part 63—General Provisions Applicability to Subpart MMM**

<b>Reference to subpart A</b>	<b>Applies to subpart MMM</b>	<b>Explanation</b>
§63.1(a)(1)	Yes	Additional terms are defined in §63.1361.
§63.1(a)(2)-(3)	Yes	
§63.1(a)(4)	Yes	Subpart MMM (this table) specifies applicability of each paragraph in subpart A to subpart MMM.
§63.1(a)(5)	N/A	Reserved.
§63.1(a)(6)-(7)	Yes	
§63.1(a)(8)	No	Discusses State programs.

§63.1(a)(9)	N/A	Reserved.
§63.1(a)(10)-(14)	Yes	
§63.1(b)(1)	No	§63.1360 specifies applicability.
§63.1(b)(2)-(3)	Yes	
§63.1(c)(1)	Yes	Subpart MMM (this table) specifies the applicability of each paragraph in subpart A to sources subject to subpart MMM.
§63.1(c)(2)	No	Area sources are not subject to subpart MMM.
§63.1(c)(3)	N/A	Reserved.
§63.1(c)(4)-(5)	Yes	
§63.1(d)	N/A	Reserved.
§63.1(e)	Yes	
§63.2	Yes	Additional terms are defined in §63.1361; when overlap between subparts A and MMM occurs, subpart MMM takes precedence.
§63.3	Yes	Other units used in subpart MMM are defined in that subpart.
§63.4(a)(1)-(3)	Yes	
§63.4(a)(4)	N/A	Reserved.
§63.4(a)(5)-(c)	Yes	
§63.5(a)	Yes	Except the term “affected source” shall apply instead of the terms “source” and “stationary source” in §63.5(a)(1) of subpart A.
§63.5(b)(1)	Yes	
§63.5(b)(2)	N/A	Reserved.



§63.5(b)(3)-(5)	Yes	
§63.5(b)(6)	No	§63.1360(g) specifies requirements for determining applicability of added PAI equipment.
§63.5(c)	N/A	Reserved.
§63.5(d)-(e)	Yes	
§63.5(f)(1)	Yes	Except “affected source” shall apply instead of “source” in §63.5(f)(1) of subpart A.
§63.5(f)(2)	Yes	
§63.6(a)	Yes	
§63.6(b)(1)-(2)	No	§63.1364 specifies compliance dates.
§63.6(b)(3)-(4)	Yes	
§63.6(b)(5)	Yes	
§63.6(b)(6)	N/A	Reserved.
§63.6(b)(7)	Yes	
§63.6(c)(1)-(2)	Yes	Except “affected source” shall apply instead of “source” in §63.6(c)(1)-(2) of subpart A.
§63.6(c)(3)-(4)	N/A	Reserved.
§63.6(c)(5)	Yes	
§63.6(d)	N/A	Reserved.
§63.6(e)(1)(i)	No	See §63.1360(e)(4) for general duty requirement.
§63.6(e)(1)(ii)	No	

§63.6(e)(1)(iii)	Yes	
§63.6(e)(3)	No	
§63.6(f)(1)	No	
§63.6(f)(2)-(3)	Yes	
§63.6(g)	Yes	An alternative standard has been proposed; however, affected sources will have the opportunity to demonstrate other alternatives to the Administrator.
§63.6(h)	No	Subpart MMM does not contain any opacity or visible emissions standards.
§63.6(i)(1)	Yes	
§63.6(i)(2)	Yes	Except “affected source” shall apply instead of “source” in §63.6(i)(2)(i) and (ii) of subpart A.
§63.6(i)(3)-(14)	Yes	
§63.6(i)(15)	N/A	Reserved.
§63.6(i)(16)	Yes	
§63.6(j)	Yes	
§63.7(a)(1)	Yes	
§63.7(a)(2)(i)-(vi)	Yes	§63.1368 specifies that test results must be submitted in the Notification of Compliance Status due 150 days after the compliance date.
§63.7(a)(2)(vii)-(viii)	N/A	Reserved.
§63.7(a)(2)(ix)-(c)	Yes	
§63.7(d)	Yes	Except “affected source” shall apply instead of “source” in §63.7(d) of subpart A.

§63.7(e)(1)	No	See §63.1365(b).
§63.7(e)(2)	Yes	
§63.7(e)(3)	Yes	Except §63.1365 specifies less than 3 runs for certain tests.
§63.7(e)(4)	Yes.	
§63.7(f)	Yes	
§63.7(g)(1)	Yes	Except §63.1368(a) specifies that the results of the performance test be submitted with the Notification of Compliance Status report
§63.7(g)(2)	N/A	Reserved.
§63.7(g)(3)	Yes	
§63.7(h)	Yes	
§63.8(a)(1)-(2)	Yes	
§63.8(a)(3)	N/A	Reserved.
§63.8(a)(4)	Yes	
§63.8(b)(1)	Yes	
§63.8(b)(2)	No	§63.1366 specifies CMS requirements.
§63.8(b)(3)	Yes	
§63.8(c)(1)(i)	No	
§63.8(c)(1)(ii)	Yes	
§63.8(c)(1)(iii)	No	
§63.8(c)(2)-(3)	Yes	

§63.8(c)(4)	No	§63.1366 specifies monitoring frequencies.
§63.8(c)(5)-(8)	No	
§63.8(d)-(f)(3)	Yes	Except the last sentence of §63.8(d)(3), which shall be replaced with “The program of corrective action should be included in the plan required under §63.8(d)(2).” for the purposes of this subpart.
§63.8(f)(4)	Yes	Except §63.1368(b) specifies that requests may also be included in the Precompliance report.
§63.8(f)(5)	Yes	
§63.8(f)(6)	No	Subpart MMM does not require CEM's.
§63.8(g)	No	§63.1366 specifies data reduction procedures.
§63.9(a)-(d)	Yes	
§63.9(e)	No	
§63.9(f)	No	Subpart MMM does not contain opacity and visible emission standards.
§63.9(g)	No	
§63.9(h)(1)	Yes	
§63.9(h)(2)(i)	Yes	Except §63.1368(a)(1) specifies additional information to include in the Notification of Compliance Status report.
§63.9(h)(2)(ii)	No	§63.1368 specifies the Notification of Compliance Status report is to be submitted within 150 days after the compliance date.
§63.9(h)(3)	Yes	
§63.9(h)(4)	N/A	Reserved.
§63.9(h)(5)-(6)	Yes	

63.9(i)	Yes.	
63.9(j)	No	§63.1368(h) specifies procedures for notification of changes.
§63.10(a)-(b)(1)	Yes	
§63.10(b)(2)	No	§63.1367 specifies recordkeeping requirements.
§63.10(b)(3)	Yes	
§63.10(c)(1)-(14)	Yes	
§63.10(c)(15)	No	
§63.10(d)(1)	Yes	
§63.10(d)(2)	Yes	
§63.10(d)(3)	No	Subpart MMM does not include opacity and visible emission standards.
§63.10(d)(4)	Yes	
§63.10(d)(5)	No	See §63.1368(i) for malfunction reporting requirements.
§63.10(e)(1)-(2)(i)	Yes	
§63.10(e)(2)(ii)	No	Subpart MMM does not include opacity monitoring requirements.
§63.10(e)(3)	Yes	
§63.10(e)(4)	No	Subpart MMM does not include opacity monitoring requirements.
§63.10(f)	Yes	
§63.11-§63.15	Yes	

[64 FR 33589, June 23, 1999, as amended at 67 FR 59355, Sept. 20, 2002; 79 FR 17375, Mar. 27, 2014]

[↑ Back to Top](#)

**Table 2 to Subpart MMM of Part 63—Standards for New and Existing PAI Sources**

<b>Emission source</b>	<b>Applicability</b>	<b>Requirement</b>
Process vents	Existing:	
	Processes having uncontrolled organic HAP emissions $\geq 0.15$ Mg/yr	90% for organic HAP per process or to outlet concentration of $\leq 20$ ppmv TOC.
	Processes having uncontrolled HCl and chlorine emissions $\geq 6.8$ Mg/yr	94% for HCl and chlorine per process or to outlet HCl and chlorine concentration of $\leq 20$ ppmv.
	Individual process vents meeting flow and mass emissions criteria that have gaseous organic HAP emissions controlled to less than 90% on or after November 10, 1997	98% gaseous organic HAP control per vent or $\leq 20$ ppmv TOC outlet limit.
	New:	
	Processes having uncontrolled organic HAP emissions $\geq 0.15$ Mg/yr	98% for organic HAP per process or $\leq 20$ ppmv TOC.
	Processes having uncontrolled HCl and chlorine emissions $\geq 6.8$ Mg/yr and $< 191$ Mg/yr	94% for HCl and chlorine per process or to outlet concentration of $\leq 20$ ppmv HCl and chlorine.
	Processes having uncontrolled HCl and chlorine emissions $\geq 191$ Mg/yr	99% for HCl and chlorine per process or to outlet concentration of $\leq 20$ ppmv HCl and chlorine.
Storage vessels	Existing: $\geq 75$ m <sup>3</sup> capacity and vapor pressure $\geq 3.45$ kPa	Install a floating roof, reduce HAP by 95% per vessel, or to outlet concentration of $\leq 20$ ppmv TOC.
	New: $\geq 38$ m <sup>3</sup> capacity and vapor pressure $\geq 16.5$ kPa	Same as for existing sources.

	$\geq 75 \text{ m}^3$ capacity and vapor pressure $\geq 3.45 \text{ kPa}$	Same as for existing sources.
Wastewater <sup>a</sup>	Existing: Process wastewater with $\geq 10,000$ ppmw Table 9 compounds at any flowrate or $\geq 1,000$ ppmw Table 9 compounds at $\geq 10 \text{ L/min}$ , and maintenance wastewater with HAP load $\geq 5.3 \text{ Mg}$ per discharge event	Reduce concentration of total Table 9 compounds to $< 50$ ppmw (or other options).
	New:	
	Same criteria as for existing sources	Reduce concentration of total Table 9 compounds to $< 50$ ppmw (or other options).
	Total HAP load in wastewater POD streams $\geq 2,100 \text{ Mg/yr}$ .	99% reduction of Table 9 compounds from all streams.
Equipment leaks	Subpart H	Subpart H with minor changes, including monitoring frequencies consistent with the proposed CAR.
Product dryers and bag dumps	Dryers used to dry PAI that is also a HAP, and bag dumps used to introduce feedstock that is a solid and a HAP	Particulate matter concentration not to exceed $0.01 \text{ gr/dscf}$ .
Heat exchange systems	Each heat exchange system used to cool process equipment in PAI manufacturing operations	Monitoring and leak repair program as in HON.

<sup>a</sup>Table 9 is listed in the appendix to subpart G of 40 CFR part 63.

[↑ Back to Top](#)

**Table 3 to Subpart MMM of Part 63—Monitoring Requirements for Control Devices<sup>a</sup>**

Control device	Monitoring equipment required	Parameters to be monitored	Frequency
All control devices	1. Flow indicator installed at all bypass lines to the atmosphere and equipped with continuous recorder or	1. Presence of flow diverted from the control device to the atmosphere or	Hourly records of whether the flow indicator was operating and whether a diversion was detected at any time during each hour.

	2. Valves sealed closed with car-seal or lock-and-key configuration	2. Monthly inspections of sealed valves	Monthly.
Scrubber	Liquid flow rate or pressure drop mounting device. Also a pH monitor if the scrubber is used to control acid emissions.	1. Liquid flow rate into or out of the scrubber or the pressure drop across the scrubber.	1. Every 15 minutes.
		2. pH of effluent scrubber liquid	2. Once a day.
Thermal incinerator	Temperature monitoring device installed in firebox or in ductwork immediately downstream of firebox <sup>b</sup>	Firebox temperature	Every 15 minutes.
Catalytic incinerator	Temperature monitoring device installed in gas stream immediately before and after catalyst bed	Temperature difference across catalyst bed	Every 15 minutes.
Flare	Heat sensing device installed at the pilot light	Presence of a flame at the pilot light	Every 15 minutes.
Boiler or process heater <44 megawatts and vent stream is not mixed with the primary fuel	Temperature monitoring device installed in firebox <sup>b</sup>	Combustion temperature	Every 15 minutes.
Condenser	Temperature monitoring device installed at condenser exit	Condenser exit (product side) temperature	Every 15 minutes.
Carbon adsorber (nonregenerative)	None	Operating time since last replacement	N/A.
Carbon adsorber (regenerative)	Stream flow monitoring device, and	1. Total regeneration stream mass or volumetric flow during	1. For each regeneration cycle, record the total regeneration stream mass



		carbon bed regeneration cycle(s)	or volumetric flow.
	Carbon bed temperature monitoring device	2. Temperature of carbon bed after regeneration	2. For each regeneration cycle, record the maximum carbon bed-temperature.
		3. Temperature of carbon bed within 15 minutes of completing any cooling cycle(s)	3. Within 15 minutes of completing any cooling cycle, record the carbon bed temperature.
		4. Operating time since end of last regeneration	4. Operating time to be based on worst-case conditions.
		5. Check for bed poisoning	5. Yearly.

<sup>a</sup>As an alternative to the monitoring requirements specified in this table, the owner or operator may use a CEM meeting the requirements of Performance Specifications 8 or 9 of appendix B of part 60 to monitor TOC every 15 minutes.

<sup>b</sup>Monitor may be installed in the firebox or in the ductwork immediately downstream of the firebox before any substantial heat exchange is encountered.

[↑ Back to Top](#)

**Table 4 to Subpart MMM of Part 63—Control Requirements for Items of Equipment That Meet the Criteria of §63.1362(k)**

<b>Item of equipment</b>	<b>Control requirement<sup>a</sup></b>
1. Drain or drain hub	(a) Tightly fitting solid cover (TFSC); or (b) TFSC with a vent to either a process, or to a control device meeting the requirements of §63.139(c); or (c) Water seal with submerged discharge or barrier to protect discharge from wind.
2. Manhole <sup>b</sup>	(a) TFSC; or (b) TFSC with a vent to either a process or to a control device meeting the requirements of §63.139(c); or (c) If the item is vented to the atmosphere, use a TFSC with a properly operating water seal

	at the entrance or exit to the item to restrict ventilation in the collection system. The vent pipe shall be at least 90 cm in length and not exceeding 10.2 cm in nominal inside diameter.
3. Lift station	(a) TFSC; or (b) TFSC with a vent to either a process, or to a control device meeting the requirements of §63.139(c); or (c) If the lift station is vented to the atmosphere, use a TFSC with a properly operating water seal at the entrance or exit to the item to restrict ventilation in the collection system. The vent pipe shall be at least 90 cm in length and not exceeding 10.2 cm in nominal inside diameter. The lift station shall be level controlled to minimize changes in the liquid level.
4. Trench	(a) TFSC; or (b) TFSC with a vent to either a process, or to a control device meeting the requirements of §63.139(c); or (c) If the item is vented to the atmosphere, use a TFSC with a properly operating water seal at the entrance or exit to the item to restrict ventilation in the collection system. The vent pipe shall be at least 90 cm in length and not exceeding 10.2 cm in nominal inside diameter.
5. Pipe	Each pipe shall have no visible gaps in joints, seals, or other emission interfaces.
6. Oil/water separator	(a) Equip with a fixed roof and route vapors to a process, or equip with a closed-vent system that routes vapors to a control device meeting the requirements of §63.139(c); or (b) Equip with a floating roof that meets the equipment specifications of §60.693 (a)(1)(i), (a)(1)(ii), (a)(2), (a)(3), and (a)(4).
7. Tank	Maintain a fixed roof and consider vents as process vents. <sup>c</sup>

<sup>a</sup>Where a tightly fitting solid cover is required, it shall be maintained with no visible gaps or openings, except during periods of sampling, inspection, or maintenance.

<sup>b</sup>Manhole includes sumps and other points of access to a conveyance system.

<sup>c</sup>A fixed roof may have openings necessary for proper venting of the tank, such as pressure/vacuum vent, j-pipe vent.

[67 FR 59355, Sept. 20, 2002]

[↑ Back to Top](#)

# **APPENDIX I**

## Electronic Code of Federal Regulations

---

[View past updates to the e-CFR.](#)

[Click here to learn more.](#)

---

**e-CFR data is current as of January 17, 2017**

[Title 40](#) → [Chapter I](#) → [Subchapter C](#) → [Part 63](#) → [Subpart EEEE](#)

---

[Browse Previous](#) | [Browse Next](#)

Title 40: Protection of Environment

[PART 63—NATIONAL EMISSION STANDARDS FOR HAZARDOUS AIR POLLUTANTS FOR SOURCE CATEGORIES \(CONTINUED\)](#)

---

### **Subpart EEEE—National Emission Standards for Hazardous Air Pollutants: Organic Liquids Distribution (Non-Gasoline)**

---

#### **Contents**

##### [What This Subpart Covers](#)

[§63.2330](#) What is the purpose of this subpart?

[§63.2334](#) Am I subject to this subpart?

[§63.2338](#) What parts of my plant does this subpart cover?

[§63.2342](#) When do I have to comply with this subpart?

[§63.2343](#) What are my requirements for emission sources not requiring control?

##### [Emission Limitations, Operating Limits, and Work Practice Standards](#)

[§63.2346](#) What emission limitations, operating limits, and work practice standards must I meet?

##### [General Compliance Requirements](#)

[§63.2350](#) What are my general requirements for complying with this subpart?

##### [Testing and Initial Compliance Requirements](#)

[§63.2354](#) What performance tests, design evaluations, and performance evaluations must I conduct?

[§63.2358](#) By what date must I conduct performance tests and other initial compliance demonstrations?

[§63.2362](#) When must I conduct subsequent performance tests?

[§63.2366](#) What are my monitoring installation, operation, and maintenance requirements?

§63.2370 How do I demonstrate initial compliance with the emission limitations, operating limits, and work practice standards?

#### Continuous Compliance Requirements

§63.2374 When do I monitor and collect data to demonstrate continuous compliance and how do I use the collected data?

§63.2378 How do I demonstrate continuous compliance with the emission limitations, operating limits, and work practice standards?

#### Notifications, Reports, and Records

§63.2382 What notifications must I submit and when and what information should be submitted?

§63.2386 What reports must I submit and when and what information is to be submitted in each?

§63.2390 What records must I keep?

§63.2394 In what form and how long must I keep my records?

#### Other Requirements and Information

§63.2396 What compliance options do I have if part of my plant is subject to both this subpart and another subpart?

§63.2398 What parts of the General Provisions apply to me?

§63.2402 Who implements and enforces this subpart?

§63.2406 What definitions apply to this subpart?

Table 1 to Subpart EEEE of Part 63—Organic Hazardous Air Pollutants

Table 2 to Subpart EEEE of Part 63—Emission Limits

Table 3 to Subpart EEEE of Part 63—Operating Limits—High Throughput Transfer Racks

Table 4 to Subpart EEEE of Part 63—Work Practice Standards

Table 5 to Subpart EEEE of Part 63—Requirements for Performance Tests and Design Evaluations

Table 6 to Subpart EEEE of Part 63—Initial Compliance With Emission Limits

Table 7 to Subpart EEEE of Part 63—Initial Compliance With Work Practice Standards

Table 8 to Subpart EEEE of Part 63—Continuous Compliance With Emission Limits

Table 9 to Subpart EEEE of Part 63—Continuous Compliance With Operating Limits—High Throughput Transfer Racks

Table 10 to Subpart EEEE of Part 63—Continuous Compliance With Work Practice Standards

Table 11 to Subpart EEEE of Part 63—Requirements for Reports

Table 12 to Subpart EEEE of Part 63—Applicability of General Provisions to Subpart EEEE

---

Source: 69 FR 5063, Feb. 3, 2004, unless otherwise noted.

[↑ Back to Top](#)

#### **What This Subpart Covers**

[↑ Back to Top](#)

### **§63.2330 What is the purpose of this subpart?**

This subpart establishes national emission limitations, operating limits, and work practice standards for organic hazardous air pollutants (HAP) emitted from organic liquids distribution (OLD) (non-gasoline) operations at major sources of HAP emissions. This subpart also establishes requirements to demonstrate initial and continuous compliance with the emission limitations, operating limits, and work practice standards.

[↑ Back to Top](#)

### **§63.2334 Am I subject to this subpart?**

(a) Except as provided for in paragraphs (b) and (c) of this section, you are subject to this subpart if you own or operate an OLD operation that is located at, or is part of, a major source of HAP emissions. An OLD operation may occupy an entire plant site or be collocated with other industrial (*e.g.*, manufacturing) operations at the same plant site.

(b) Organic liquid distribution operations located at research and development facilities, consistent with section 112(c)(7) of the Clean Air Act (CAA), are not subject to this subpart.

(c) Organic liquid distribution operations do not include the activities and equipment, including product loading racks, used to process, store, or transfer organic liquids at facilities listed in paragraph (c) (1) and (2) of this section.

(1) Oil and natural gas production field facilities, as the term “facility” is defined in §63.761 of subpart HH.

(2) Natural gas transmission and storage facilities, as the term “facility” is defined in §63.1271 of subpart HHH.

[↑ Back to Top](#)

### **§63.2338 What parts of my plant does this subpart cover?**

(a) This subpart applies to each new, reconstructed, or existing OLD operation affected source.

(b) Except as provided in paragraph (c) of this section, the affected source is the collection of activities and equipment used to distribute organic liquids into, out of, or within a facility that is a major source of HAP. The affected source is composed of:

(1) All storage tanks storing organic liquids.

(2) All transfer racks at which organic liquids are loaded into or unloaded out of transport vehicles and/or containers.

(3) All equipment leak components in organic liquids service that are associated with:

(i) Storage tanks storing organic liquids;

- (ii) Transfer racks loading or unloading organic liquids;
  - (iii) Pipelines that transfer organic liquids directly between two storage tanks that are subject to this subpart;
  - (iv) Pipelines that transfer organic liquids directly between a storage tank subject to this subpart and a transfer rack subject to this subpart; and
  - (v) Pipelines that transfer organic liquids directly between two transfer racks that are subject to this subpart.
- (4) All transport vehicles while they are loading or unloading organic liquids at transfer racks subject to this subpart.
- (5) All containers while they are loading or unloading organic liquids at transfer racks subject to this subpart.
- (c) The equipment listed in paragraphs (c)(1) through (4) of this section and used in the identified operations is excluded from the affected source.
- (1) Storage tanks, transfer racks, transport vehicles, containers, and equipment leak components that are part of an affected source under another 40 CFR part 63 national emission standards for hazardous air pollutants (NESHAP).
  - (2) Non-permanent storage tanks, transfer racks, transport vehicles, containers, and equipment leak components when used in special situation distribution loading and unloading operations (such as maintenance or upset liquids management).
  - (3) Storage tanks, transfer racks, transport vehicles, containers, and equipment leak components when used to conduct maintenance activities, such as stormwater management, liquid removal from tanks for inspections and maintenance, or changeovers to a different liquid stored in a storage tank.
- (d) An affected source is a new affected source if you commenced construction of the affected source after April 2, 2002, and you meet the applicability criteria in §63.2334 at the time you commenced operation.
- (e) An affected source is reconstructed if you meet the criteria for reconstruction as defined in §63.2.
- (f) An affected source is existing if it is not new or reconstructed.

[69 FR 5063, Feb. 3, 2004, as amended at 71 FR 42904, July 28, 2006]

[↑ Back to Top](#)

#### **§63.2342 When do I have to comply with this subpart?**

- (a) If you have a new or reconstructed affected source, you must comply with this subpart according to the schedule identified in paragraph (a)(1), (a)(2), or (a)(3) of this section, as applicable.

(1)(i) Except as provided in paragraph (a)(1)(ii) of this section, if you startup your new affected source on or before February 3, 2004 or if you reconstruct your affected source on or before February 3, 2004, you must comply with the emission limitations, operating limits, and work practice standards for new and reconstructed sources in this subpart no later than February 3, 2004.

(ii) For any emission source listed in paragraph §63.2338(b) at an affected source that commenced construction or reconstruction after April 2, 2002, but before February 3, 2004, that is required to be controlled based on the applicability criteria in this subpart, but:

(A) Would not have been required to be controlled based on the applicability criteria as proposed for this subpart, you must comply with the emission limitations, operating limits, and work practice standards for each such emission source based on the schedule found in paragraph (b) of this section or at startup, whichever is later; or

(B) Would have been subject to a less stringent degree of control requirement as proposed for this subpart, you must comply with the emission limitations, operating limits, and work practice standards in this subpart for each such emission source based on the schedule found in paragraph (b) of this section or at startup, whichever is later, and if you start up your affected new or reconstructed source before February 5, 2007, you must comply with the emission limitations, operating limits, and work practice standards for each such emission source as proposed for this subpart, until you are required to comply with the emission limitations, operating limits, and work practice standards in this subpart for each such emission source based on the schedule found in paragraph (b) of this section.

(2) If you commence construction of or reconstruct your affected source after February 3, 2004, you must comply with the emission limitations, operating limits, and work practice standards for new and reconstructed sources in this subpart upon startup of your affected source.

(3) If, after startup of a new affected source, the total actual annual facility-level organic liquid loading volume at that source exceeds the criteria for control in Table 2 to this subpart, items 9 and 10, the owner or operator must comply with the transfer rack requirements specified in §63.2346(b) immediately; that is, be in compliance the first day of the period following the end of the 3-year period triggering the control criteria.

(b)(1) If you have an existing affected source, you must comply with the emission limitations, operating limits, and work practice standards for existing affected sources no later than February 5, 2007, except as provided in paragraphs (b)(2) and (3) of this section.

(2) Floating roof storage tanks at existing affected sources must be in compliance with the work practice standards in Table 4 to this subpart, item 1, at all times after the next degassing and cleaning activity or within 10 years after February 3, 2004, whichever occurs first. If the first degassing and cleaning activity occurs during the 3 years following February 3, 2004, the compliance date is February 5, 2007.

(3)(i) If an addition or change other than reconstruction as defined in §63.2 is made to an existing affected facility that causes the total actual annual facility-level organic liquid loading volume to exceed the criteria for control in Table 2 to this subpart, items 7 and 8, the owner or operator must comply with the transfer rack requirements specified in §63.2346(b) immediately; that is, be in compliance the first day of the period following the end of the 3-year period triggering the control criteria.



(ii) If the owner or operator believes that compliance with the transfer rack emission limits cannot be achieved immediately, as specified in paragraph (b)(3)(i) of this section, the owner or operator may submit a request for a compliance extension, as specified in paragraphs (b)(3)(ii)(A) through (I) of this section. Subject to paragraph (b)(3)(ii)(B) of this section, until an extension of compliance has been granted by the Administrator (or a State with an approved permit program) under this paragraph (b)(3)(ii), the owner or operator of the transfer rack subject to the requirements of this section shall comply with all applicable requirements of this subpart. Advice on requesting an extension of compliance may be obtained from the Administrator (or the State with an approved permit program).

(A) *Submittal.* The owner or operator shall submit a request for a compliance extension to the Administrator (or a State, when the State has an approved 40 CFR part 70 permit program and the source is required to obtain a 40 CFR part 70 permit under that program, or a State, when the State has been delegated the authority to implement and enforce the emission standard for that source) seeking an extension allowing the source up to 1 additional year to comply with the transfer rack standard, if such additional period is necessary for the installation of controls. The owner or operator of the affected source who has requested an extension of compliance under this paragraph (b)(3)(ii)(A) and who is otherwise required to obtain a title V permit shall apply for such permit, or apply to have the source's title V permit revised to incorporate the conditions of the extension of compliance. The conditions of an extension of compliance granted under this paragraph (b)(3)(ii)(A) will be incorporated into the affected source's title V permit according to the provisions of 40 CFR part 70 or Federal title V regulations in this chapter (42 U.S.C. 7661), whichever are applicable.

(B) *When to submit.* (1) Any request submitted under paragraph (b)(3)(ii)(A) of this section must be submitted in writing to the appropriate authority no later than 120 days prior to the affected source's compliance date (as specified in paragraph (b)(3)(i) of this section), except as provided for in paragraph (b)(3)(ii)(B)(2) of this section. Nonfrivolous requests submitted under this paragraph (b)(3)(ii)(B)(1) will stay the applicability of the rule as to the emission points in question until such time as the request is granted or denied. A denial will be effective as of the date of denial.

(2) An owner or operator may submit a compliance extension request after the date specified in paragraph (b)(3)(ii)(B)(1) of this section provided the need for the compliance extension arose after that date, and before the otherwise applicable compliance date and the need arose due to circumstances beyond reasonable control of the owner or operator. This request must include, in addition to the information required in paragraph (b)(3)(ii)(C) of this section, a statement of the reasons additional time is needed and the date when the owner or operator first learned of the problems. Nonfrivolous requests submitted under this paragraph (b)(3)(ii)(B)(2) will stay the applicability of the rule as to the emission points in question until such time as the request is granted or denied. A denial will be effective as of the original compliance date.

(C) *Information required.* The request for a compliance extension under paragraph (b)(3)(ii)(A) of this section shall include the following information:

(1) The name and address of the owner or operator and the address of the existing source if it differs from the address of the owner or operator;

(2) The name, address, and telephone number of a contact person for further information;

(3) An identification of the organic liquid distribution operation and of the specific equipment for which additional compliance time is required;

(4) A description of the controls to be installed to comply with the standard;

(5) Justification for the length of time being requested; and

(6) A compliance schedule, including the date by which each step toward compliance will be reached. At a minimum, the list of dates shall include:

(i) The date by which on-site construction, installation of emission control equipment, or a process change is planned to be initiated;

(ii) The date by which on-site construction, installation of emission control equipment, or a process change is to be completed; and

(iii) The date by which final compliance is to be achieved.

(D) *Approval of request for extension of compliance.* Based on the information provided in any request made under paragraph (b)(3)(ii)(C) of this section, or other information, the Administrator (or the State with an approved permit program) may grant an extension of compliance with the transfer rack emission standard, as specified in paragraph (b)(3)(ii) of this section. The extension will be in writing and will—

(1) Identify each affected source covered by the extension;

(2) Specify the termination date of the extension;

(3) Specify the dates by which steps toward compliance are to be taken, if appropriate;

(4) Specify other applicable requirements to which the compliance extension applies (e.g., performance tests);

(5) Specify the contents of the progress reports to be submitted and the dates by which such reports are to be submitted, if required pursuant to paragraph (b)(3)(ii)(E) of this section.

(6) Under paragraph (b)(3)(ii) of this section, specify any additional conditions that the Administrator (or the State) deems necessary to assure installation of the necessary controls and protection of the health of persons during the extension period.

(E) *Progress reports.* The owner or operator of an existing source that has been granted an extension of compliance under paragraph (b)(3)(ii)(D) of this section may be required to submit to the Administrator (or the State with an approved permit program) progress reports indicating whether the steps toward compliance outlined in the compliance schedule have been reached.

(F) *Notification of approval or intention to deny.* (1) The Administrator (or the State with an approved permit program) will notify the owner or operator in writing of approval or intention to deny approval of a request for an extension of compliance within 30 calendar days after receipt of sufficient information to evaluate a request submitted under paragraph (b)(3)(ii) of this section. The Administrator (or the State) will notify the owner or operator in writing of the status of his/her application; that is, whether the

application contains sufficient information to make a determination, within 30 calendar days after receipt of the original application and within 30 calendar days after receipt of any supplementary information that is submitted. The 30-day approval or denial period will begin after the owner or operator has been notified in writing that his/her application is complete. Failure by the Administrator to act within 30 calendar days to approve or disapprove a request submitted under paragraph (b)(3)(ii) of this section does not constitute automatic approval of the request.

(2) When notifying the owner or operator that his/her application is not complete, the Administrator will specify the information needed to complete the application and provide notice of opportunity for the applicant to present, in writing, within 30 calendar days after he/she is notified of the incomplete application, additional information or arguments to the Administrator to enable further action on the application.

(3) Before denying any request for an extension of compliance, the Administrator (or the State with an approved permit program) will notify the owner or operator in writing of the Administrator's (or the State's) intention to issue the denial, together with:

(i) Notice of the information and findings on which the intended denial is based; and

(ii) Notice of opportunity for the owner or operator to present in writing, within 15 calendar days after he/she is notified of the intended denial, additional information or arguments to the Administrator (or the State) before further action on the request.

(4) The Administrator's final determination to deny any request for an extension will be in writing and will set forth the specific grounds on which the denial is based. The final determination will be made within 30 calendar days after presentation of additional information or argument (if the application is complete), or within 30 calendar days after the final date specified for the presentation if no presentation is made.

(G) *Termination of extension of compliance.* The Administrator (or the State with an approved permit program) may terminate an extension of compliance at an earlier date than specified if any specification under paragraph (b)(3)(ii)(D)(3) or paragraph (b)(3)(ii)(D)(4) of this section is not met. Upon a determination to terminate, the Administrator will notify, in writing, the owner or operator of the Administrator's determination to terminate, together with:

(1) Notice of the reason for termination; and

(2) Notice of opportunity for the owner or operator to present in writing, within 15 calendar days after he/she is notified of the determination to terminate, additional information or arguments to the Administrator before further action on the termination.

(3) A final determination to terminate an extension of compliance will be in writing and will set forth the specific grounds on which the termination is based. The final determination will be made within 30 calendar days after presentation of additional information or arguments, or within 30 calendar days after the final date specified for the presentation if no presentation is made.

(H) The granting of an extension under this section shall not abrogate the Administrator's authority under section 114 of the CAA.

(I) *Limitation on use of compliance extension.* The owner or operator may request an extension of compliance under the provisions specified in paragraph (b)(3)(ii) of this section only once for each facility.

(c) If you have an area source that does not commence reconstruction but increases its emissions or its potential to emit such that it becomes a major source of HAP emissions and an existing affected source subject to this subpart, you must be in compliance by 3 years after the area source becomes a major source.

(d) You must meet the notification requirements in §§63.2343 and 63.2382(a), as applicable, according to the schedules in §63.2382(a) and (b)(1) through (3) and in subpart A of this part. Some of these notifications must be submitted before the compliance dates for the emission limitations, operating limits, and work practice standards in this subpart.

[69 FR 5063, Feb. 3, 2004, as amended at 71 FR 42905, July 28, 2006]

[↑ Back to Top](#)

### **§63.2343 What are my requirements for emission sources not requiring control?**

This section establishes the notification, recordkeeping, and reporting requirements for emission sources identified in §63.2338 that do not require control under this subpart (i.e., under paragraphs (a) through (e) of §63.2346). Such emission sources are not subject to any other notification, recordkeeping, or reporting sections in this subpart, including §63.2350(c), except as indicated in paragraphs (a) through (d) of this section.

(a) For each storage tank subject to this subpart having a capacity of less than 18.9 cubic meters (5,000 gallons) and for each transfer rack subject to this subpart that only unloads organic liquids (i.e., no organic liquids are loaded at any of the transfer racks), you must keep documentation that verifies that each storage tank and transfer rack identified in paragraph (a) of this section is not required to be controlled. The documentation must be kept up-to-date (i.e., all such emission sources at a facility are identified in the documentation regardless of when the documentation was last compiled) and must be in a form suitable and readily available for expeditious inspection and review according to §63.10(b)(1), including records stored in electronic form in a separate location. The documentation may consist of identification of the tanks and transfer racks identified in paragraph (a) of this section on a plant site plan or process and instrumentation diagram (P&ID).

(b) For each storage tank subject to this subpart having a capacity of 18.9 cubic meters (5,000 gallons) or more that is not subject to control based on the criteria specified in Table 2 to this subpart, items 1 through 6, you must comply with the requirements specified in paragraphs (b)(1) through (3) of this section.

(1)(i) You must submit the information in §63.2386(c)(1), (2), (3), and (10)(i) in either the Notification of Compliance Status, according to the schedule specified in Table 12 to this subpart, or in your first Compliance report, according to the schedule specified in §63.2386(b), whichever occurs first.

(ii)(A) If you submit your first Compliance report before your Notification of Compliance Status, the Notification of Compliance Status must contain the information specified in §63.2386(d)(3) and (4) if any of the changes identified in paragraph (d) of this section have occurred since the filing of the first Compliance report. If none of the changes identified in paragraph (d) of this section have occurred since the filing of the first Compliance report, you do not need to report the information specified in §63.2386(c)(10)(i) when you submit your Notification of Compliance Status.

(B) If you submit your Notification of Compliance Status before your first Compliance report, your first Compliance report must contain the information specified in §63.2386(d)(3) and (4) if any of the changes specified in paragraph (d) of this section have occurred since the filing of the Notification of Compliance Status.

(iii) If you are already submitting a Notification of Compliance Status or a first Compliance report under §63.2386(c), you do not need to submit a separate Notification of Compliance Status or first Compliance report for each storage tank that meets the conditions identified in paragraph (b) of this section (i.e., a single Notification of Compliance Status or first Compliance report should be submitted).

(2)(i) You must submit a subsequent Compliance report according to the schedule in §63.2386(b) whenever any of the events in paragraph (d) of this section occur, as applicable.

(ii) Your subsequent Compliance reports must contain the information in §63.2386(c)(1), (2), (3) and, as applicable, in §63.2386(d)(3) and (4). If you are already submitting a subsequent Compliance report under §63.2386(d), you do not need to submit a separate subsequent Compliance report for each storage tank that meets the conditions identified in paragraph (b) of this section (i.e., a single subsequent Compliance report should be submitted).

(3) For each storage tank that meets the conditions identified in paragraph (b) of this section, you must keep documentation, including a record of the annual average true vapor pressure of the total Table 1 organic HAP in the stored organic liquid, that verifies the storage tank is not required to be controlled under this subpart. The documentation must be kept up-to-date and must be in a form suitable and readily available for expeditious inspection and review according to §63.10(b)(1), including records stored in electronic form in a separate location.

(c) For each transfer rack subject to this subpart that loads organic liquids but is not subject to control based on the criteria specified in Table 2 to this subpart, items 7 through 10, you must comply with the requirements specified in paragraphs (c)(1) through (3) of this section.

(1)(i) You must submit the information in §63.2386(c)(1), (2), (3), and (10)(i) in either the Notification of Compliance Status, according to the schedule specified in Table 12 to this subpart, or a first Compliance report, according to the schedule specified in §63.2386(b), whichever occurs first.

(ii)(A) If you submit your first Compliance report before your Notification of Compliance Status, the Notification of Compliance Status must contain the information specified in §63.2386(d)(3) and (4) if any

of the changes identified in paragraph (d) of this section have occurred since the filing of the first Compliance report. If none of the changes identified in paragraph (d) of this section have occurred since the filing of the first Compliance report, you do not need to report the information specified in §63.2386(c)(10)(i) when you submit your Notification of Compliance Status.

(B) If you submit your Notification of Compliance Status before your first Compliance report, your first Compliance report must contain the information specified in §63.2386(d)(3) and (4) if any of the changes specified in paragraph (d) of this section have occurred since the filing of the Notification of Compliance Status.

(iii) If you are already submitting a Notification of Compliance Status or a first Compliance report under §63.2386(c), you do not need to submit a separate Notification of Compliance Status or first Compliance report for each transfer rack that meets the conditions identified in paragraph (b) of this section (i.e., a single Notification of Compliance Status or first Compliance report should be submitted).

(2)(i) You must submit a subsequent Compliance report according to the schedule in §63.2386(b) whenever any of the events in paragraph (d) of this section occur, as applicable.

(ii) Your subsequent Compliance reports must contain the information in §63.2386(c)(1), (2), (3) and, as applicable, in §63.2386(d)(3) and (4). If you are already submitting a subsequent Compliance report under §63.2386(d), you do not need to submit a separate subsequent Compliance report for each transfer rack that meets the conditions identified in paragraph (c) of this section (i.e., a single subsequent Compliance report should be submitted).

(3) For each transfer rack that meets the conditions identified in paragraph (c) of this section, you must keep documentation, including the records specified in §63.2390(d), that verifies the transfer rack is not required to be controlled under this subpart. The documentation must be kept up-to-date and must be in a form suitable and readily available for expeditious inspection and review according to §63.10(b)(1), including records stored in electronic form in a separate location.

(d) If one or more of the events identified in paragraphs (d)(1) through (4) of this section occur since the filing of the Notification of Compliance Status or the last Compliance report, you must submit a subsequent Compliance report as specified in paragraphs (b)(2) and (c)(2) of this section.

(1) Any storage tank or transfer rack became subject to control under this subpart EEEE; or

(2) Any storage tank equal to or greater than 18.9 cubic meters (5,000 gallons) became part of the affected source but is not subject to any of the emission limitations, operating limits, or work practice standards of this subpart; or

(3) Any transfer rack (except those racks at which only unloading of organic liquids occurs) became part of the affected source; or

(4) Any of the information required in §63.2386(c)(1), §63.2386(c)(2), or §63.2386(c)(3) has changed.

[71 FR 42906, July 28, 2006, as amended at 73 FR 21830, Apr. 23, 2008]

[↑ Back to Top](#)

## Emission Limitations, Operating Limits, and Work Practice Standards

[↑ Back to Top](#)

### §63.2346 What emission limitations, operating limits, and work practice standards must I meet?

(a) *Storage tanks.* For each storage tank storing organic liquids that meets the tank capacity and liquid vapor pressure criteria for control in Table 2 to this subpart, items 1 through 5, you must comply with paragraph (a)(1), (a)(2), (a)(3), or (a)(4) of this section. For each storage tank storing organic liquids that meets the tank capacity and liquid vapor pressure criteria for control in Table 2 to this subpart, item 6, you must comply with paragraph (a)(1), (a)(2), or (a)(4) of this section.

- (1) Meet the emission limits specified in Table 2 to this subpart and comply with the applicable requirements specified in 40 CFR part 63, subpart SS, for meeting emission limits, except substitute the term “storage tank” at each occurrence of the term “storage vessel” in subpart SS.
- (2) Route emissions to fuel gas systems or back into a process as specified in 40 CFR part 63, subpart SS.
- (3) Comply with 40 CFR part 63, subpart WW (control level 2).
- (4) Use a vapor balancing system that complies with the requirements specified in paragraphs (a)(4)(i) through (vii) of this section and with the recordkeeping requirements specified in §63.2390(e).
  - (i) The vapor balancing system must be designed and operated to route organic HAP vapors displaced from loading of the storage tank to the transport vehicle from which the storage tank is filled.
  - (ii) Transport vehicles must have a current certification in accordance with the United States Department of Transportation (U.S. DOT) pressure test requirements of 49 CFR part 180 for cargo tanks and 49 CFR 173.31 for tank cars.
  - (iii) Organic liquids must only be unloaded from cargo tanks or tank cars when vapor collection systems are connected to the storage tank's vapor collection system.
  - (iv) No pressure relief device on the storage tank, or on the cargo tank or tank car, shall open during loading or as a result of diurnal temperature changes (breathing losses).
  - (v) Pressure relief devices must be set to no less than 2.5 pounds per square inch guage (psig) at all times to prevent breathing losses. Pressure relief devices may be set at values less than 2.5 psig if the owner or operator provides rationale in the notification of compliance status report explaining why the alternative value is sufficient to prevent breathing losses at all times. The owner or operator shall comply with paragraphs (a)(4)(v)(A) through (C) of this section for each pressure relief valve.
    - (A) The pressure relief valve shall be monitored quarterly using the method described in §63.180(b).
    - (B) An instrument reading of 500 parts per million by volume (ppmv) or greater defines a leak.
    - (C) When a leak is detected, it shall be repaired as soon as practicable, but no later than 5 days after it is detected, and the owner or operator shall comply with the recordkeeping requirements of §63.181(d)(1) through (4).

(vi) Cargo tanks and tank cars that deliver organic liquids to a storage tank must be reloaded or cleaned at a facility that utilizes the control techniques specified in paragraph (a)(4)(vi)(A) or (a)(4)(vi)(B) of this section.

(A) The cargo tank or tank car must be connected to a closed-vent system with a control device that reduces inlet emissions of total organic HAP by 95 percent by weight or greater or to an exhaust concentration less than or equal to 20 ppmv, on a dry basis corrected to 3 percent oxygen for combustion devices using supplemental combustion air.

(B) A vapor balancing system designed and operated to collect organic HAP vapor displaced from the cargo tank or tank car during reloading must be used to route the collected vapor to the storage tank from which the liquid being transferred originated or to another storage tank connected to a common header.

(vii) The owner or operator of the facility where the cargo tank or tank car is reloaded or cleaned must comply with paragraphs (a)(4)(vii)(A) through (D) of this section.

(A) Submit to the owner or operator of the storage tank and to the Administrator a written certification that the reloading or cleaning facility will meet the requirements of paragraph (a)(4)(vii)(A) through (C) of this section. The certifying entity may revoke the written certification by sending a written statement to the owner or operator of the storage tank giving at least 90 days notice that the certifying entity is rescinding acceptance of responsibility for compliance with the requirements of this paragraph (a)(4)(vii) of this section.

(B) If complying with paragraph (a)(4)(vi)(A) of this section, comply with the requirements for a closed vent system and control device as specified in this subpart EEEE. The notification requirements in §63.2382 and the reporting requirements in §63.2386 do not apply to the owner or operator of the offsite cleaning or reloading facility.

(C) If complying with paragraph (a)(4)(vi)(B) of this section, keep the records specified in §63.2390(e)(3) or equivalent recordkeeping approved by the Administrator.

(D) After the compliance dates specified in §63.2342, at an offsite reloading or cleaning facility subject to §63.2346(a)(4), compliance with the monitoring, recordkeeping, and reporting provisions of any other subpart of this part 63 that has monitoring, recordkeeping, and reporting provisions constitutes compliance with the monitoring, recordkeeping and reporting provisions of §63.2346(a)(4)(vii)(B) or §63.2346(a)(4)(vii)(C). You must identify in your notification of compliance status report required by §63.2382(d) the subpart of this part 63 with which the owner or operator of the offsite reloading or cleaning facility complies.

(b) *Transfer racks.* For each transfer rack that is part of the collection of transfer racks that meets the total actual annual facility-level organic liquid loading volume criterion for control in Table 2 to this subpart, items 7 through 10, you must comply with paragraph (b)(1), (b)(2), or (b)(3) of this section for each arm in the transfer rack loading an organic liquid whose organic HAP content meets the organic HAP criterion for control in Table 2 to this subpart, items 7 through 10. For existing affected sources, you must comply with paragraph (b)(1), (b)(2), or (b)(3)(i) of this section during the loading of organic liquids into transport vehicles. For new affected sources, you must comply with paragraph (b)(1), (b)(2), or (b)(3)(i) and (ii) of this section during the loading of organic liquids into transport vehicles and containers. If the



total actual annual facility-level organic liquid loading volume at any affected source is equal to or greater than the loading volume criteria for control in Table 2 to this subpart, but at a later date is less than the loading volume criteria for control, compliance with paragraph (b)(1), (b)(2), or (b)(3) of this section is no longer required. For new sources and reconstructed sources, as defined in §63.2338(d) and (e), if at a later date, the total actual annual facility-level organic liquid loading volume again becomes equal to or greater than the loading volume criteria for control in Table 2 to this subpart, the owner or operator must comply with paragraph (b)(1), (b)(2), or (b)(3)(i) and (ii) of this section immediately, as specified in §63.2342(a)(3). For existing sources, as defined in §63.2338(f), if at a later date, the total actual annual facility-level organic liquid loading volume again becomes equal to or greater than the loading volume criteria for control in Table 2 to this subpart, the owner or operator must comply with paragraph (b)(1), (b)(2), or (b)(3)(i) of this section immediately, as specified in §63.2342(b)(3)(i), unless an alternative compliance schedule has been approved under §63.2342(b)(3)(ii) and subject to the use limitation specified in §63.2342(b)(3)(ii)(I).

(1) Meet the emission limits specified in Table 2 to this subpart and comply with the applicable requirements for transfer racks specified in 40 CFR part 63, subpart SS, for meeting emission limits.

(2) Route emissions to fuel gas systems or back into a process as specified in 40 CFR part 63, subpart SS.

(3)(i) Use a vapor balancing system that routes organic HAP vapors displaced from the loading of organic liquids into transport vehicles to the storage tank from which the liquid being loaded originated or to another storage tank connected to a common header.

(ii) Use a vapor balancing system that routes the organic HAP vapors displaced from the loading of organic liquids into containers directly (e.g., no intervening tank or containment area such as a room) to the storage tank from which the liquid being loaded originated or to another storage tank connected to a common header.

(c) *Equipment leak components.* For each pump, valve, and sampling connection that operates in organic liquids service for at least 300 hours per year, you must comply with the applicable requirements under 40 CFR part 63, subpart TT (control level 1), subpart UU (control level 2), or subpart H. Pumps, valves, and sampling connectors that are insulated to provide protection against persistent sub-freezing temperatures are subject to the “difficult to monitor” provisions in the applicable subpart selected by the owner or operator. This paragraph only applies if the affected source has at least one storage tank or transfer rack that meets the applicability criteria for control in Table 2 to this subpart.

(d) *Transport vehicles.* For each transport vehicle equipped with vapor collection equipment that is loaded at a transfer rack that is subject to control based on the criteria specified in Table 2 to this subpart, items 7 through 10, you must comply with paragraph (d)(1) of this section. For each transport vehicle without vapor collection equipment that is loaded at a transfer rack that is subject to control based on the criteria specified in Table 2 to this subpart, items 7 through 10, you must comply with paragraph (d)(2) of this section.

(1) Follow the steps in 40 CFR 60.502(e) to ensure that organic liquids are loaded only into vapor-tight transport vehicles and comply with the provisions in 40 CFR 60.502(f) through (i), except substitute the

term “transport vehicle” at each occurrence of the term “tank truck” or “gasoline tank truck” in those paragraphs.

(2) Ensure that organic liquids are loaded only into transport vehicles that have a current certification in accordance with the U.S. Department of Transportation (DOT) pressure test requirements in 49 CFR part 180 for cargo tanks or 49 CFR 173.31 for tank cars.

(e) *Operating limits.* For each high throughput transfer rack, you must meet each operating limit in Table 3 to this subpart for each control device used to comply with the provisions of this subpart whenever emissions from the loading of organic liquids are routed to the control device. For each storage tank and low throughput transfer rack, you must comply with the requirements for monitored parameters as specified in subpart SS of this part for storage vessels and, during the loading of organic liquids, for low throughput transfer racks, respectively. Alternatively, you may comply with the operating limits in Table 3 to this subpart.

(f) For noncombustion devices, if you elect to demonstrate compliance with a percent reduction requirement in Table 2 to this subpart using total organic compounds (TOC) rather than organic HAP, you must first demonstrate, subject to the approval of the Administrator, that TOC is an appropriate surrogate for organic HAP in your case; that is, for your storage tank(s) and/or transfer rack(s), the percent destruction of organic HAP is equal to or higher than the percent destruction of TOC. This demonstration must be conducted prior to or during the initial compliance test.

(g) As provided in §63.6(g), you may request approval from the Administrator to use an alternative to the emission limitations, operating limits, and work practice standards in this section. You must follow the procedures in §63.177(b) through (e) in applying for permission to use such an alternative. If you apply for permission to use an alternative to the emission limitations, operating limits, and work practice standards in this section, you must submit the information described in §63.6(g)(2).

(h) [Reserved]

(i) Opening of a safety device is allowed at any time that it is required to avoid unsafe operating conditions.

(j) If you elect to comply with this subpart by combining emissions from different emission sources subject to this subpart in a single control device, then you must comply with the provisions specified in §63.982(f).

[69 FR 5063, Feb. 3, 2004, as amended at 71 FR 42908, July 28, 2006; 73 FR 40981, July 17, 2008; 73 FR 21830, Apr. 23, 2008]

[↑ Back to Top](#)

## General Compliance Requirements

[↑ Back to Top](#)

**§63.2350 What are my general requirements for complying with this subpart?**

(a) You must be in compliance with the emission limitations, operating limits, and work practice standards in this subpart at all times when the equipment identified in §63.2338(b)(1) through (4) is in OLD operation.

(b) You must always operate and maintain your affected source, including air pollution control and monitoring equipment, according to the provisions in §63.6(e)(1)(i).

(c) Except for emission sources not required to be controlled as specified in §63.2343, you must develop a written startup, shutdown, and malfunction (SSM) plan according to the provisions in §63.6(e)(3).

[69 FR 5063, Feb. 3, 2004, as amended at 71 FR 42909, July 28, 2006]

[↑ Back to Top](#)

## Testing and Initial Compliance Requirements

[↑ Back to Top](#)

### **§63.2354 What performance tests, design evaluations, and performance evaluations must I conduct?**

(a)(1) For each performance test that you conduct, you must use the procedures specified in subpart SS of this part and the provisions specified in paragraph (b) of this section.

(2) For each design evaluation you conduct, you must use the procedures specified in subpart SS of this part.

(3) For each performance evaluation of a continuous emission monitoring system (CEMS) you conduct, you must follow the requirements in §63.8(e).

(b)(1) For nonflare control devices, you must conduct each performance test according to the requirements in §63.7(e)(1), and either §63.988(b), §63.990(b), or §63.995(b), using the procedures specified in §63.997(e).

(2) You must conduct three separate test runs for each performance test on a nonflare control device as specified in §§63.7(e)(3) and 63.997(e)(1)(v). Each test run must last at least 1 hour, except as provided in §63.997(e)(1)(v)(A) and (B).

(3)(i) In addition to EPA Method 25 or 25A of 40 CFR part 60, appendix A, to determine compliance with the organic HAP or TOC emission limit, you may use EPA Method 18 of 40 CFR part 60, appendix A, as specified in paragraph (b)(3)(i) of this section. As an alternative to EPA Method 18, you may use ASTM D6420-99 (Reapproved 2004), Standard Test Method for Determination of Gaseous Organic Compounds by Direct Interface Gas Chromatography-Mass Spectrometry (incorporated by reference, see §63.14), under the conditions specified in paragraph (b)(3)(ii) of this section.

(A) If you use EPA Method 18 to measure compliance with the percentage efficiency limit, you must first determine which organic HAP are present in the inlet gas stream (i.e., uncontrolled emissions) using knowledge of the organic liquids or the screening procedure described in EPA Method 18. In conducting

the performance test, you must analyze samples collected as specified in EPA Method 18, simultaneously at the inlet and outlet of the control device. Quantify the emissions for the same organic HAP identified as present in the inlet gas stream for both the inlet and outlet gas streams of the control device.

(B) If you use EPA Method 18 of 40 CFR part 60, appendix A, to measure compliance with the emission concentration limit, you must first determine which organic HAP are present in the inlet gas stream using knowledge of the organic liquids or the screening procedure described in EPA Method 18. In conducting the performance test, analyze samples collected as specified in EPA Method 18 at the outlet of the control device. Quantify the control device outlet emission concentration for the same organic HAP identified as present in the inlet or uncontrolled gas stream.

(ii) You may use ASTM D6420-99 (Reapproved 2004), Standard Test Method for Determination of Gaseous Organic Compounds by Direct Interface Gas Chromatography-Mass Spectrometry (incorporated by reference, see §63.14), as an alternative to EPA Method 18 if the target concentration is between 150 parts per billion by volume and 100 ppmv and either of the conditions specified in paragraph (b)(2)(ii)(A) or (B) of this section exists. For target compounds not listed in Section 1.1 of ASTM D6420-99 (Reapproved 2004) and not amenable to detection by mass spectrometry, you may not use ASTM D6420-99 (Reapproved 2004).

(A) The target compounds are those listed in Section 1.1 of ASTM D6420-99 (Reapproved 2004), Standard Test Method for Determination of Gaseous Organic Compounds by Direct Interface Gas Chromatography-Mass Spectrometry (incorporated by reference, see §63.14); or

(B) For target compounds not listed in Section 1.1 of ASTM D6420-99 (Reapproved 2004), Standard Test Method for Determination of Gaseous Organic Compounds by Direct Interface Gas Chromatography-Mass Spectrometry (incorporated by reference, see §63.14), but potentially detected by mass spectrometry, the additional system continuing calibration check after each run, as detailed in ASTM D6420-99 (Reapproved 2004), Section 10.5.3, must be followed, met, documented, and submitted with the data report, even if there is no moisture condenser used or the compound is not considered water-soluble.

(4) If a principal component of the uncontrolled or inlet gas stream to the control device is formaldehyde, you may use EPA Method 316 of appendix A of this part instead of EPA Method 18 of 40 CFR part 60, appendix A, for measuring the formaldehyde. If formaldehyde is the predominant organic HAP in the inlet gas stream, you may use EPA Method 316 alone to measure formaldehyde either at the inlet and outlet of the control device using the formaldehyde control efficiency as a surrogate for total organic HAP or TOC efficiency, or at the outlet of a combustion device for determining compliance with the emission concentration limit.

(5) You may not conduct performance tests during periods of SSM, as specified in §63.7(e)(1).

(c) To determine the HAP content of the organic liquid, you may use EPA Method 311 of 40 CFR part 63, appendix A, or other method approved by the Administrator. In addition, you may use other means, such as voluntary consensus standards, material safety data sheets (MSDS), or certified product data sheets, to determine the HAP content of the organic liquid. If the method you select to determine the HAP content provides HAP content ranges, you must use the upper end of each HAP content range in

determining the total HAP content of the organic liquid. The EPA may require you to test the HAP content of an organic liquid using EPA Method 311 or other method approved by the Administrator. If the results of the EPA Method 311 (or any other approved method) are different from the HAP content determined by another means, the EPA Method 311 (or approved method) results will govern.

[69 FR 5063, Feb. 3, 2004, as amended at 71 FR 42909, July 28, 2006]

[↑ Back to Top](#)

### **§63.2358 By what date must I conduct performance tests and other initial compliance demonstrations?**

(a) You must conduct initial performance tests and design evaluations according to the schedule in §63.7(a)(2), or by the compliance date specified in any applicable State or Federal new source review construction permit to which the affected source is already subject, whichever is earlier.

(b)(1) For storage tanks and transfer racks at existing affected sources complying with the emission limitations listed in Table 2 to this subpart, you must demonstrate initial compliance with the emission limitations within 180 days after February 5, 2007, except as provided in paragraphs (b)(1)(i) and (b)(1)(ii) of this section.

(i) For storage tanks with an existing internal or external floating roof, complying with item 1.a.ii. in Table 2 to this subpart and item 1.a. in Table 4 to this subpart, you must conduct your initial compliance demonstration the next time the storage tank is emptied and degassed, but not later than February 3, 2014.

(ii) For storage tanks complying with item 1.a.ii. or 6.a.ii in Table 2 of this subpart and item 1.b., 1.c., or 2. in Table 4 of this subpart, you must comply within 180 days after April 25, 2011.

(2) For storage tanks and transfer racks at reconstructed or new affected sources complying with the emission limitations listed in Table 2 to this subpart, you must conduct your initial compliance demonstration with the emission limitations within 180 days after the initial startup date for the affected source or February 3, 2004, whichever is later.

(c)(1) For storage tanks at existing affected sources complying with the work practice standard in Table 4 to this subpart, you must conduct your initial compliance demonstration as specified in paragraphs (c)(1)(i) and (c)(1)(ii) of this section.

(i) For storage tanks with an existing internal or external floating roof, complying with item 1.a. in Table 4 of this subpart, you must conduct your initial compliance demonstration the next time the storage tank is emptied and degassed, but not later than February 3, 2014.

(ii) For other storage tanks not specified in paragraph (c)(1)(i) of this section, you must comply within 180 days after April 25, 2011.

(2) For transfer racks and equipment leak components at existing affected sources complying with the work practice standards in Table 4 to this subpart, you must conduct your initial compliance demonstration within 180 days after February 5, 2007.

(d) For storage tanks, transfer racks, and equipment leak components at reconstructed or new affected sources complying with the work practice standards in Table 4 to this subpart, you must conduct your initial compliance demonstration within 180 days after the initial startup date for the affected source.

[69 FR 5063, Feb. 3, 2004, as amended at 73 FR 40981, July 17, 2008]

[↑ Back to Top](#)

#### **§63.2362 When must I conduct subsequent performance tests?**

(a) For nonflare control devices, you must conduct subsequent performance testing required in Table 5 to this subpart, item 1, at any time the EPA requests you to in accordance with section 114 of the CAA.

(b)(1) For each transport vehicle that you own that is equipped with vapor collection equipment and that is loaded with organic liquids at a transfer rack that is subject to control based on the criteria specified in Table 2 to this subpart, items 7 through 10, you must perform the vapor tightness testing required in Table 5 to this subpart, item 2, on that transport vehicle at least once per year.

(2) For transport vehicles that you own that do not have vapor collection equipment, you must maintain current certification in accordance with the U.S. DOT pressure test requirements in 49 CFR part 180 for cargo tanks or 49 CFR 173.31 for tank cars.

[69 FR 5063, Feb. 3, 2004, as amended at 71 FR 42910, July 28, 2006]

[↑ Back to Top](#)

#### **§63.2366 What are my monitoring installation, operation, and maintenance requirements?**

(a) You must install, operate, and maintain a CMS on each control device required in order to comply with this subpart. If you use a continuous parameter monitoring system (CPMS) (as defined in §63.981), you must comply with the applicable requirements for CPMS in subpart SS of this part for the control device being used. If you use a continuous emissions monitoring system (CEMS), you must comply with the requirements in §63.8.

(b) For nonflare control devices controlling storage tanks and low throughput transfer racks, you must submit a monitoring plan according to the requirements in subpart SS of this part for monitoring plans.

[↑ Back to Top](#)

#### **§63.2370 How do I demonstrate initial compliance with the emission limitations, operating limits, and work practice standards?**

(a) You must demonstrate initial compliance with each emission limitation and work practice standard that applies to you as specified in tables 6 and 7 to this subpart.

(b) You demonstrate initial compliance with the operating limits requirements specified in §63.2346(e) by establishing the operating limits during the initial performance test or design evaluation.

(c) You must submit the results of the initial compliance determination in the Notification of Compliance Status according to the requirements in §63.2382(d).

[69 FR 5063, Feb. 3, 2004, as amended at 71 FR 42910, July 28, 2006]

[↑ Back to Top](#)

## **Continuous Compliance Requirements**

[↑ Back to Top](#)

### **§63.2374 When do I monitor and collect data to demonstrate continuous compliance and how do I use the collected data?**

(a) You must monitor and collect data according to subpart SS of this part and paragraphs (b) and (c) of this section.

(b) When using a control device to comply with this subpart, you must monitor continuously or collect data at all required intervals at all times that the emission source and control device are in OLD operation, except for CMS malfunctions (including any malfunction preventing the CMS from operating properly), associated repairs, and required quality assurance or control activities (including, as applicable, calibration checks and required zero and span adjustments).

(c) Do not use data recorded during CMS malfunctions, associated repairs, required quality assurance or control activities, or periods when emissions from organic liquids are not routed to the control device in data averages and calculations used to report emission or operating levels. Do not use such data in fulfilling a minimum data availability requirement, if applicable. You must use all of the data collected during all other periods, including periods of SSM, in assessing the operation of the control device.

[↑ Back to Top](#)

### **§63.2378 How do I demonstrate continuous compliance with the emission limitations, operating limits, and work practice standards?**

(a) You must demonstrate continuous compliance with each emission limitation, operating limit, and work practice standard in Tables 2 through 4 to this subpart that applies to you according to the methods specified in subpart SS of this part and in tables 8 through 10 to this subpart, as applicable.

(b) You must follow the requirements in §63.6(e)(1) and (3) during periods of startup, shutdown, malfunction, or nonoperation of the affected source or any part thereof. In addition, the provisions of paragraphs (b)(1) through (3) of this section apply.

(1) The emission limitations in this subpart apply at all times except during periods of nonoperation of the affected source (or specific portion thereof) resulting in cessation of the emissions to which this subpart applies. The emission limitations of this subpart apply during periods of SSM, except as provided in paragraphs (b)(2) and (3) of this section. However, if a SSM, or period of nonoperation of one portion of the affected source does not affect the ability of a particular emission source to comply with the emission

limitations to which it is subject, then that emission source is still required to comply with the applicable emission limitations of this subpart during the startup, shutdown, malfunction, or period of nonoperation.

(2) The owner or operator must not shut down control devices or monitoring systems that are required or utilized for achieving compliance with this subpart during periods of SSM while emissions are being routed to such items of equipment if the shutdown would contravene requirements of this subpart applicable to such items of equipment. This paragraph (b)(2) does not apply if the item of equipment is malfunctioning. This paragraph (b)(2) also does not apply if the owner or operator shuts down the compliance equipment (other than monitoring systems) to avoid damage due to a contemporaneous SSM of the affected source or portion thereof. If the owner or operator has reason to believe that monitoring equipment would be damaged due to a contemporaneous SSM of the affected source or portion thereof, the owner or operator must provide documentation supporting such a claim in the next Compliance report required in table 11 to this subpart, item 1. Once approved by the Administrator, the provision for ceasing to collect, during a SSM, monitoring data that would otherwise be required by the provisions of this subpart must be incorporated into the SSM plan.

(3) During SSM, you must implement, to the extent reasonably available, measures to prevent or minimize excess emissions. For purposes of this paragraph (b)(3), the term “excess emissions” means emissions greater than those allowed by the emission limits that apply during normal operational periods. The measures to be taken must be identified in the SSM plan, and may include, but are not limited to, air pollution control technologies, recovery technologies, work practices, pollution prevention, monitoring, and/or changes in the manner of operation of the affected source. Back-up control devices are not required, but may be used if available.

(c) Periods of planned routine maintenance of a control device used to control storage tanks or transfer racks, during which the control device does not meet the emission limits in table 2 to this subpart, must not exceed 240 hours per year.

(d) If you elect to route emissions from storage tanks or transfer racks to a fuel gas system or to a process, as allowed by §63.982(d), to comply with the emission limits in table 2 to this subpart, the total aggregate amount of time during which the emissions bypass the fuel gas system or process during the calendar year without being routed to a control device, for all reasons (except SSM or product changeovers of flexible operation units and periods when a storage tank has been emptied and degassed), must not exceed 240 hours.

[69 FR 5063, Feb. 3, 2004, as amended at 71 FR 20463, Apr. 20, 2006]

[↑ Back to Top](#)

## **Notifications, Reports, and Records**

[↑ Back to Top](#)

**§63.2382 What notifications must I submit and when and what information should be submitted?**



(a) You must submit each notification in subpart SS of this part, table 12 to this subpart, and paragraphs (b) through (d) of this section that applies to you. You must submit these notifications according to the schedule in table 12 to this subpart and as specified in paragraphs (b) through (d) of this section.

(b)(1) *Initial Notification.* If you startup your affected source before February 3, 2004, you must submit the Initial Notification no later than 120 calendar days after February 3, 2004.

(2) If you startup your new or reconstructed affected source on or after February 3, 2004, you must submit the Initial Notification no later than 120 days after initial startup.

(c) If you are required to conduct a performance test, you must submit the Notification of Intent to conduct the test at least 60 calendar days before it is initially scheduled to begin as required in §63.7(b)(1).

(d)(1) *Notification of Compliance Status.* If you are required to conduct a performance test, design evaluation, or other initial compliance demonstration as specified in table 5, 6, or 7 to this subpart, you must submit a Notification of Compliance Status.

(2) The Notification of Compliance Status must include the information required in §63.999(b) and in paragraphs (d)(2)(i) through (viii) of this section.

(i) The results of any applicability determinations, emission calculations, or analyses used to identify and quantify organic HAP emissions from the affected source.

(ii) The results of emissions profiles, performance tests, engineering analyses, design evaluations, flare compliance assessments, inspections and repairs, and calculations used to demonstrate initial compliance according to tables 6 and 7 to this subpart. For performance tests, results must include descriptions of sampling and analysis procedures and quality assurance procedures.

(iii) Descriptions of monitoring devices, monitoring frequencies, and the operating limits established during the initial compliance demonstrations, including data and calculations to support the levels you establish.

(iv) Descriptions of worst-case operating and/or testing conditions for the control device(s).

(v) Identification of emission sources subject to overlapping requirements described in §63.2396 and the authority under which you will comply.

(vi) The applicable information specified in §63.1039(a)(1) through (3) for all pumps and valves subject to the work practice standards for equipment leak components in table 4 to this subpart, item 4.

(vii) If you are complying with the vapor balancing work practice standard for transfer racks according to table 4 to this subpart, item 3.a, include a statement to that effect and a statement that the pressure vent settings on the affected storage tanks are greater than or equal to 2.5 psig.

(viii) The information specified in §63.2386(c)(10)(i), unless the information has already been submitted with the first Compliance report. If the information specified in §63.2386(c)(10)(i) has already been

submitted with the first Compliance report, the information specified in §63.2386(d)(3) and (4), as applicable, shall be submitted instead.

[69 FR 5063, Feb. 3, 2004, as amended at 71 FR 42910, July 28, 2006]

[↑ Back to Top](#)

**§63.2386 What reports must I submit and when and what information is to be submitted in each?**

(a) You must submit each report in subpart SS of this part, Table 11 to this subpart, table 12 to this subpart, and in paragraphs (c) through (e) of this section that applies to you.

(b) Unless the Administrator has approved a different schedule for submission of reports under §63.10(a), you must submit each report according to table 11 to this subpart and by the dates shown in paragraphs (b)(1) through (3) of this section, by the dates shown in subpart SS of this part, and by the dates shown in table 12 to this subpart, whichever are applicable.

(1)(i) The first Compliance report must cover the period beginning on the compliance date that is specified for your affected source in §63.2342 and ending on June 30 or December 31, whichever date is the first date following the end of the first calendar half after the compliance date that is specified for your affected source in §63.2342.

(ii) The first Compliance report must be postmarked no later than July 31 or January 31, whichever date follows the end of the first calendar half after the compliance date that is specified for your affected source in §63.2342.

(2)(i) Each subsequent Compliance report must cover the semiannual reporting period from January 1 through June 30 or the semiannual reporting period from July 1 through December 31.

(ii) Each subsequent Compliance report must be postmarked no later than July 31 or January 31, whichever date is the first date following the end of the semiannual reporting period.

(3) For each affected source that is subject to permitting regulations pursuant to 40 CFR part 70 or 40 CFR part 71, if the permitting authority has established dates for submitting semiannual reports pursuant to 40 CFR 70.6(a)(3)(iii)(A) or 40 CFR 71.6(a)(3)(iii)(A), you may submit the first and subsequent Compliance reports according to the dates the permitting authority has established instead of according to the dates in paragraphs (b)(1) and (2) of this section.

(c) *First Compliance report.* The first Compliance report must contain the information specified in paragraphs (c)(1) through (10) of this section.

(1) Company name and address.

(2) Statement by a responsible official, including the official's name, title, and signature, certifying that, based on information and belief formed after reasonable inquiry, the statements and information in the report are true, accurate, and complete.

(3) Date of report and beginning and ending dates of the reporting period.

(4) Any changes to the information listed in §63.2382(d)(2) that have occurred since the submittal of the Notification of Compliance Status.

(5) If you had a SSM during the reporting period and you took actions consistent with your SSM plan, the Compliance report must include the information described in §63.10(d)(5)(i).

(6) If there are no deviations from any emission limitation or operating limit that applies to you and there are no deviations from the requirements for work practice standards, a statement that there were no deviations from the emission limitations, operating limits, or work practice standards during the reporting period.

(7) If there were no periods during which the CMS was out of control as specified in §63.8(c)(7), a statement that there were no periods during which the CMS was out of control during the reporting period.

(8) For closed vent systems and control devices used to control emissions, the information specified in paragraphs (c)(8)(i) and (ii) of this section for those planned routine maintenance activities that would require the control device to not meet the applicable emission limit.

(i) A description of the planned routine maintenance that is anticipated to be performed for the control device during the next 6 months. This description must include the type of maintenance necessary, planned frequency of maintenance, and lengths of maintenance periods.

(ii) A description of the planned routine maintenance that was performed for the control device during the previous 6 months. This description must include the type of maintenance performed and the total number of hours during those 6 months that the control device did not meet the applicable emission limit due to planned routine maintenance.

(9) A listing of all transport vehicles into which organic liquids were loaded at transfer racks that are subject to control based on the criteria specified in table 2 to this subpart, items 7 through 10, during the previous 6 months for which vapor tightness documentation as required in §63.2390(c) was not on file at the facility.

(10)(i) A listing of all transfer racks (except those racks at which only unloading of organic liquids occurs) and of tanks greater than or equal to 18.9 cubic meters (5,000 gallons) that are part of the affected source but are not subject to any of the emission limitations, operating limits, or work practice standards of this subpart.

(ii) If the information specified in paragraph (c)(10)(i) of this section has already been submitted with the Notification of Compliance Status, the information specified in paragraphs (d)(3) and (4) of this section, as applicable, shall be submitted instead.

(d) *Subsequent Compliance reports.* Subsequent Compliance reports must contain the information in paragraphs (c)(1) through (9) of this section and, where applicable, the information in paragraphs (d)(1) through (4) of this section.

(1) For each deviation from an emission limitation occurring at an affected source where you are using a CMS to comply with an emission limitation in this subpart, you must include in the Compliance report

the applicable information in paragraphs (d)(1)(i) through (xii) of this section. This includes periods of SSM.

(i) The date and time that each malfunction started and stopped.

(ii) The dates and times that each CMS was inoperative, except for zero (low-level) and high-level checks.

(iii) For each CMS that was out of control, the information in §63.8(c)(8).

(iv) The date and time that each deviation started and stopped, and whether each deviation occurred during a period of SSM, or during another period.

(v) A summary of the total duration of the deviations during the reporting period, and the total duration as a percentage of the total emission source operating time during that reporting period.

(vi) A breakdown of the total duration of the deviations during the reporting period into those that are due to startup, shutdown, control equipment problems, process problems, other known causes, and other unknown causes.

(vii) A summary of the total duration of CMS downtime during the reporting period, and the total duration of CMS downtime as a percentage of the total emission source operating time during that reporting period.

(viii) An identification of each organic HAP that was potentially emitted during each deviation based on the known organic HAP contained in the liquid(s).

(ix) A brief description of the emission source(s) at which the CMS deviation(s) occurred.

(x) A brief description of each CMS that was out of control during the period.

(xi) The date of the latest certification or audit for each CMS.

(xii) A brief description of any changes in CMS, processes, or controls since the last reporting period.

(2) Include in the Compliance report the information in paragraphs (d)(2)(i) through (iii) of this section, as applicable.

(i) For each storage tank and transfer rack subject to control requirements, include periods of planned routine maintenance during which the control device did not comply with the applicable emission limits in table 2 to this subpart.

(ii) For each storage tank controlled with a floating roof, include a copy of the inspection record (required in §63.1065(b)) when inspection failures occur.

(iii) If you elect to use an extension for a floating roof inspection in accordance with §63.1063(c)(2)(iv)(B) or (e)(2), include the documentation required by those paragraphs.

(3)(i) A listing of any storage tank that became subject to controls based on the criteria for control specified in table 2 to this subpart, items 1 through 6, since the filing of the last Compliance report.

(ii) A listing of any transfer rack that became subject to controls based on the criteria for control specified in table 2 to this subpart, items 7 through 10, since the filing of the last Compliance report.

(4)(i) A listing of tanks greater than or equal to 18.9 cubic meters (5,000 gallons) that became part of the affected source but are not subject to any of the emission limitations, operating limits, or work practice standards of this subpart, since the last Compliance report.

(ii) A listing of all transfer racks (except those racks at which only the unloading of organic liquids occurs) that became part of the affected source but are not subject to any of the emission limitations, operating limits, or work practice standards of this subpart, since the last Compliance report.

(e) Each affected source that has obtained a title V operating permit pursuant to 40 CFR part 70 or 40 CFR part 71 must report all deviations as defined in this subpart in the semiannual monitoring report required by 40 CFR 70.6(a)(3)(iii)(A) or 71.6(a)(3)(iii)(A). If an affected source submits a Compliance report pursuant to table 11 to this subpart along with, or as part of, the semiannual monitoring report required by 40 CFR 70.6(a)(3)(iii)(A) or 71.6(a)(3)(iii)(A), and the Compliance report includes all required information concerning deviations from any emission limitation in this subpart, we will consider submission of the Compliance report as satisfying any obligation to report the same deviations in the semiannual monitoring report. However, submission of a Compliance report will not otherwise affect any obligation the affected source may have to report deviations from permit requirements to the applicable title V permitting authority.

[69 FR 5063, Feb. 3, 2004, as amended at 71 FR 42910, July 28, 2006]

[↑ Back to Top](#)

### **§63.2390 What records must I keep?**

(a) For each emission source identified in §63.2338 that does not require control under this subpart, you must keep all records identified in §63.2343.

(b) For each emission source identified in §63.2338 that does require control under this subpart:

(1) You must keep all records identified in subpart SS of this part and in table 12 to this subpart that are applicable, including records related to notifications and reports, SSM, performance tests, CMS, and performance evaluation plans; and

(2) You must keep the records required to show continuous compliance, as required in subpart SS of this part and in tables 8 through 10 to this subpart, with each emission limitation, operating limit, and work practice standard that applies to you.

(c) For each transport vehicle into which organic liquids are loaded at a transfer rack that is subject to control based on the criteria specified in table 2 to this subpart, items 7 through 10, you must keep the applicable records in paragraphs (c)(1) and (2) of this section or alternatively the verification records in paragraph (c)(3) of this section.

- (1) For transport vehicles equipped with vapor collection equipment, the documentation described in 40 CFR 60.505(b), except that the test title is: Transport Vehicle Pressure Test-EPA Reference Method 27.
- (2) For transport vehicles without vapor collection equipment, current certification in accordance with the U.S. DOT pressure test requirements in 49 CFR part 180 for cargo tanks or 49 CFR 173.31 for tank cars.
- (3) In lieu of keeping the records specified in paragraph (c)(1) or (2) of this section, as applicable, the owner or operator shall record that the verification of U.S. DOT tank certification or Method 27 of appendix A to 40 CFR part 60 testing, required in table 5 to this subpart, item 2, has been performed. Various methods for the record of verification can be used, such as: A check-off on a log sheet, a list of U.S. DOT serial numbers or Method 27 data, or a position description for gate security showing that the security guard will not allow any trucks on site that do not have the appropriate documentation.
- (d) You must keep records of the total actual annual facility-level organic liquid loading volume as defined in §63.2406 through transfer racks to document the applicability, or lack thereof, of the emission limitations in table 2 to this subpart, items 7 through 10.
- (e) An owner or operator who elects to comply with §63.2346(a)(4) shall keep the records specified in paragraphs (e)(1) through (3) of this section.
- (1) A record of the U.S. DOT certification required by §63.2346(a)(4)(ii).
- (2) A record of the pressure relief vent setting specified in §63.2346(a)(4)(v).
- (3) If complying with §63.2346(a)(4)(vi)(B), keep the records specified in paragraphs (e)(3)(i) and (ii) of this section.
- (i) A record of the equipment to be used and the procedures to be followed when reloading the cargo tank or tank car and displacing vapors to the storage tank from which the liquid originates.
- (ii) A record of each time the vapor balancing system is used to comply with §63.2346(a)(4)(vi)(B).

[69 FR 5063, Feb. 3, 2004, as amended at 71 FR 42910, July 28, 2006; 73 FR 40982, July 17, 2008]

[↑ Back to Top](#)

### **§63.2394 In what form and how long must I keep my records?**

- (a) Your records must be in a form suitable and readily available for expeditious inspection and review according to §63.10(b)(1), including records stored in electronic form at a separate location.
- (b) As specified in §63.10(b)(1), you must keep your files of all information (including all reports and notifications) for at least 5 years following the date of each occurrence, measurement, maintenance, corrective action, report, or record.
- (c) You must keep each record on site for at least 2 years after the date of each occurrence, measurement, maintenance, corrective action, report, or record, according to §63.10(b)(1). You may keep the records off site for the remaining 3 years.

[69 FR 5063, Feb. 3, 2004, as amended at 71 FR 42911, July 28, 2006]

[↑ Back to Top](#)

## Other Requirements and Information

[↑ Back to Top](#)

### **§63.2396 What compliance options do I have if part of my plant is subject to both this subpart and another subpart?**

(a) *Compliance with other regulations for storage tanks.* (1) After the compliance dates specified in §63.2342, you are in compliance with the provisions of this subpart for any storage tank that is assigned to the OLD affected source and that is both controlled with a floating roof and is in compliance with the provisions of either 40 CFR part 60, subpart Kb, or 40 CFR part 61, subpart Y, except that records shall be kept for 5 years rather than 2 years for storage tanks that are assigned to the OLD affected source.

(2) After the compliance dates specified in §63.2342, you are in compliance with the provisions of this subpart for any storage tank with a fixed roof that is assigned to the OLD affected source and that is both controlled with a closed vent system and control device and is in compliance with either 40 CFR part 60, subpart Kb, or 40 CFR part 61, subpart Y, except that you must comply with the monitoring, recordkeeping, and reporting requirements in this subpart.

(3) As an alternative to paragraphs (a)(1) and (2) of this section, if a storage tank assigned to the OLD affected source is subject to control under 40 CFR part 60, subpart Kb, or 40 CFR part 61, subpart Y, you may elect to comply only with the requirements of this subpart for storage tanks meeting the applicability criteria for control in table 2 to this subpart.

(b) *Compliance with other regulations for transfer racks.* After the compliance dates specified in §63.2342, if you have a transfer rack that is subject to 40 CFR part 61, subpart BB, and that transfer rack is in OLD operation, you must meet all of the requirements of this subpart for that transfer rack when the transfer rack is in OLD operation during the loading of organic liquids.

(c) *Compliance with other regulations for equipment leak components.* (1) After the compliance dates specified in §63.2342, if you have pumps, valves, or sampling connections that are subject to a 40 CFR part 60 subpart, and those pumps, valves, and sampling connections are in OLD operation and in organic liquids service, as defined in this subpart, you must comply with the provisions of each subpart for those equipment leak components.

(2) After the compliance dates specified in §63.2342, if you have pumps, valves, or sampling connections subject to 40 CFR part 63, subpart GGG, and those pumps, valves, and sampling connections are in OLD operation and in organic liquids service, as defined in this subpart, you may elect to comply with the provisions of this subpart for all such equipment leak components. You must identify in the Notification of Compliance Status required by §63.2382(b) the provisions with which you will comply.

(d) [Reserved]

(e) *Overlap with other regulations for monitoring, recordkeeping, and reporting—(1) Control devices.* After the compliance dates specified in §63.2342, if any control device subject to this subpart is also subject to monitoring, recordkeeping, and reporting requirements of another 40 CFR part 63 subpart, the owner or operator must be in compliance with the monitoring, recordkeeping, and reporting requirements of this subpart EEEE. If complying with the monitoring, recordkeeping, and reporting requirements of the other subpart satisfies the monitoring, recordkeeping, and reporting requirements of this subpart, the owner or operator may elect to continue to comply with the monitoring, recordkeeping, and reporting requirements of the other subpart. In such instances, the owner or operator will be deemed to be in compliance with the monitoring, recordkeeping, and reporting requirements of this subpart. The owner or operator must identify the other subpart being complied with in the Notification of Compliance Status required by §63.2382(b).

(2) *Equipment leak components.* After the compliance dates specified in §63.2342, if you are applying the applicable recordkeeping and reporting requirements of another 40 CFR part 63 subpart to the valves, pumps, and sampling connection systems associated with a transfer rack subject to this subpart that only unloads organic liquids directly to or via pipeline to a non-tank process unit component or to a storage tank subject to the other 40 CFR part 63 subpart, the owner or operator must be in compliance with the recordkeeping and reporting requirements of this subpart EEEE. If complying with the recordkeeping and reporting requirements of the other subpart satisfies the recordkeeping and reporting requirements of this subpart, the owner or operator may elect to continue to comply with the recordkeeping and reporting requirements of the other subpart. In such instances, the owner or operator will be deemed to be in compliance with the recordkeeping and reporting requirements of this subpart. The owner or operator must identify the other subpart being complied with in the Notification of Compliance Status required by §63.2382(b).

[69 FR 5063, Feb. 3, 2004, as amended at 71 FR 42911, July 28, 2006]

[↑ Back to Top](#)

### **§63.2398 What parts of the General Provisions apply to me?**

Table 12 to this subpart shows which parts of the General Provisions in §§63.1 through 63.15 apply to you.

[↑ Back to Top](#)

### **§63.2402 Who implements and enforces this subpart?**

(a) This subpart can be implemented and enforced by the U.S. Environmental Protection Agency (U.S. EPA) or a delegated authority such as your State, local, or eligible tribal agency. If the EPA Administrator has delegated authority to your State, local, or eligible tribal agency, then that agency, as well as the EPA, has the authority to implement and enforce this subpart. You should contact your EPA Regional Office (see list in §63.13) to find out if this subpart is delegated to your State, local, or eligible tribal agency.

(b) In delegating implementation and enforcement authority for this subpart to a State, local, or eligible tribal agency under 40 CFR part 63, subpart E, the authorities contained in paragraphs (b)(1) through (4)



of this section are retained by the EPA Administrator and are not delegated to the State, local, or eligible tribal agency.

- (1) Approval of alternatives to the nonopacity emission limitations, operating limits, and work practice standards in §63.2346(a) through (c) under §63.6(g).
- (2) Approval of major changes to test methods under §63.7(e)(2)(ii) and (f) and as defined in §63.90.
- (3) Approval of major changes to monitoring under §63.8(f) and as defined in §63.90.
- (4) Approval of major changes to recordkeeping and reporting under §63.10(f) and as defined in §63.90.

[69 FR 5063, Feb. 3, 2004, as amended at 71 FR 42911, July 28, 2006]

[↑ Back to Top](#)

### **§63.2406 What definitions apply to this subpart?**

Terms used in this subpart are defined in the CAA, in §63.2, 40 CFR part 63, subparts H, PP, SS, TT, UU, and WW, and in this section. If the same term is defined in another subpart and in this section, it will have the meaning given in this section for purposes of this subpart. Notwithstanding the introductory language in §63.921, the terms “container” and “safety device” shall have the meaning found in this subpart and not in §63.921.

*Actual annual average temperature*, for organic liquids, means the temperature determined using the following methods:

- (1) For heated or cooled storage tanks, use the calculated annual average temperature of the stored organic liquid as determined from a design analysis of the storage tank.
- (2) For ambient temperature storage tanks:
  - (i) Use the annual average of the local (nearest) normal daily mean temperatures reported by the National Climatic Data Center; or
  - (ii) Use any other method that the EPA approves.

*Annual average true vapor pressure* means the equilibrium partial pressure exerted by the total table 1 organic HAP in the stored or transferred organic liquid. For the purpose of determining if a liquid meets the definition of an organic liquid, the vapor pressure is determined using standard conditions of 77 degrees F and 29.92 inches of mercury. For the purpose of determining whether an organic liquid meets the applicability criteria in table 2, items 1 through 6, to this subpart, use the actual annual average temperature as defined in this subpart. The vapor pressure value in either of these cases is determined:

- (1) In accordance with methods described in American Petroleum Institute Publication 2517, Evaporative Loss from External Floating-Roof Tanks (incorporated by reference, see §63.14);
- (2) Using standard reference texts;

(3) By the American Society for Testing and Materials Method D2879-83, 96 (incorporated by reference, see §63.14); or

(4) Using any other method that the EPA approves.

*Bottoms receiver* means a tank that collects distillation bottoms before the stream is sent for storage or for further processing downstream.

*Cargo tank* means a liquid-carrying tank permanently attached and forming an integral part of a motor vehicle or truck trailer. This term also refers to the entire cargo tank motor vehicle or trailer. For the purpose of this subpart, vacuum trucks used exclusively for maintenance or spill response are not considered cargo tanks.

*Closed vent system* means a system that is not open to the atmosphere and is composed of piping, ductwork, connections, and, if necessary, flow-inducing devices that transport gas or vapors from an emission point to a control device. This system does not include the vapor collection system that is part of some transport vehicles or the loading arm or hose that is used for vapor return. For transfer racks, the closed vent system begins at, and includes, the first block valve on the downstream side of the loading arm or hose used to convey displaced vapors.

*Combustion device* means an individual unit of equipment, such as a flare, oxidizer, catalytic oxidizer, process heater, or boiler, used for the combustion of organic emissions.

*Container* means a portable unit in which a material can be stored, transported, treated, disposed of, or otherwise handled. Examples of containers include, but are not limited to, drums and portable cargo containers known as “portable tanks” or “totes.”

*Control device* means any combustion device, recovery device, recapture device, or any combination of these devices used to comply with this subpart. Such equipment or devices include, but are not limited to, absorbers, adsorbers, condensers, and combustion devices. Primary condensers, steam strippers, and fuel gas systems are not considered control devices.

*Crude oil* means any of the naturally occurring liquids commonly referred to as crude oil, regardless of specific physical properties. Only those crude oils downstream of the first point of custody transfer after the production field are considered crude oils in this subpart.

*Custody transfer* means the transfer of hydrocarbon liquids after processing and/or treatment in the producing operations, or from storage tanks or automatic transfer facilities to pipelines or any other forms of transportation.

*Design evaluation* means a procedure for evaluating control devices that complies with the requirements in §63.985(b)(1)(i).

*Deviation* means any instance in which an affected source subject to this subpart, or portion thereof, or an owner or operator of such a source:

(1) Fails to meet any requirement or obligation established by this subpart including, but not limited to, any emission limitation (including any operating limit) or work practice standard;

(2) Fails to meet any term or condition that is adopted to implement an applicable requirement in this subpart, and that is included in the operating permit for any affected source required to obtain such a permit; or

(3) Fails to meet any emission limitation (including any operating limit) or work practice standard in this subpart during SSM.

*Emission limitation* means an emission limit, opacity limit, operating limit, or visible emission limit.

*Equipment leak component* means each pump, valve, and sampling connection system used in organic liquids service at an OLD operation. Valve types include control, globe, gate, plug, and ball. Relief and check valves are excluded.

*Gasoline* means any petroleum distillate or petroleum distillate/alcohol blend having a Reid vapor pressure of 27.6 kilopascals (4.0 pounds per square inch absolute (psia)) or greater which is used as a fuel for internal combustion engines. Aviation gasoline is included in this definition.

*High throughput transfer rack* means those transfer racks that transfer into transport vehicles (for existing affected sources) or into transport vehicles and containers (for new affected sources) a total of 11.8 million liters per year or greater of organic liquids.

*In organic liquids service* means that an equipment leak component contains or contacts organic liquids having 5 percent by weight or greater of the organic HAP listed in Table 1 to this subpart.

*Low throughput transfer rack* means those transfer racks that transfer into transport vehicles (for existing affected sources) or into transport vehicles and containers (for new affected sources) less than 11.8 million liters per year of organic liquids.

*On-site* or *on site* means, with respect to records required to be maintained by this subpart or required by another subpart referenced by this subpart, that records are stored at a location within a major source which encompasses the affected source. On-site includes, but is not limited to, storage at the affected source to which the records pertain, storage in central files elsewhere at the major source, or electronically available at the site.

*Organic liquid* means:

(1) Any non-crude oil liquid or liquid mixture that contains 5 percent by weight or greater of the organic HAP listed in Table 1 to this subpart, as determined using the procedures specified in §63.2354(c).

(2) Any crude oils downstream of the first point of custody transfer.

(3) Organic liquids for purposes of this subpart do not include the following liquids:

(i) Gasoline (including aviation gasoline), kerosene (No. 1 distillate oil), diesel (No. 2 distillate oil), asphalt, and heavier distillate oils and fuel oils;

(ii) Any fuel consumed or dispensed on the plant site directly to users (such as fuels for fleet refueling or for refueling marine vessels that support the operation of the plant);

(iii) Hazardous waste;

(iv) Wastewater;

(v) Ballast water: or

(vi) Any non-crude oil liquid with an annual average true vapor pressure less than 0.7 kilopascals (0.1 psia).

*Organic liquids distribution (OLD) operation* means the combination of activities and equipment used to store or transfer organic liquids into, out of, or within a plant site regardless of the specific activity being performed. Activities include, but are not limited to, storage, transfer, blending, compounding, and packaging.

*Permitting authority* means one of the following:

(1) The State Air Pollution Control Agency, local agency, or other agency authorized by the EPA Administrator to carry out a permit program under 40 CFR part 70; or

(2) The EPA Administrator, in the case of EPA-implemented permit programs under title V of the CAA (42 U.S.C. 7661) and 40 CFR part 71.

*Plant site* means all contiguous or adjoining surface property that is under common control, including surface properties that are separated only by a road or other public right-of-way. Common control includes surface properties that are owned, leased, or operated by the same entity, parent entity, subsidiary, or any combination.

*Research and development facility* means laboratory and pilot plant operations whose primary purpose is to conduct research and development into new processes and products, where the operations are under the close supervision of technically trained personnel, and which are not engaged in the manufacture of products for commercial sale, except in a *de minimis* manner.

*Responsible official* means responsible official as defined in 40 CFR 70.2 and 40 CFR 71.2, as applicable.

*Safety device* means a closure device such as a pressure relief valve, frangible disc, fusible plug, or any other type of device that functions exclusively to prevent physical damage or permanent deformation to a unit or its air emission control equipment by venting gases or vapors directly to the atmosphere during unsafe conditions resulting from an unplanned, accidental, or emergency event.

*Shutdown* means the cessation of operation of an OLD affected source, or portion thereof (other than as part of normal operation of a batch-type operation), including equipment required or used to comply with this subpart, or the emptying and degassing of a storage tank. Shutdown as defined here includes, but is not limited to, events that result from periodic maintenance, replacement of equipment, or repair.

*Startup* means the setting in operation of an OLD affected source, or portion thereof (other than as part of normal operation of a batch-type operation), for any purpose. Startup also includes the placing in operation of any individual piece of equipment required or used to comply with this subpart including, but not limited to, control devices and monitors.

*Storage tank* means a stationary unit that is constructed primarily of nonferrous materials (such as wood, concrete, steel, or reinforced plastic) that provide structural support and is designed to hold a bulk quantity of liquid. Storage tanks do not include:

- (1) Units permanently attached to conveyances such as trucks, trailers, rail cars, barges, or ships;
- (2) Pressure vessels designed to operate in excess of 204.9 kilopascals and without emissions to the atmosphere;
- (3) Bottoms receivers;
- (4) Surge control vessels;
- (5) Vessels storing wastewater; or
- (6) Reactor vessels associated with a manufacturing process unit.

*Surge control vessel* means feed drums, recycle drums, and intermediate vessels. Surge control vessels are used within chemical manufacturing processes when in-process storage, mixing, or management of flow rates or volumes is needed to assist in production of a product.

*Tank car* means a car designed to carry liquid freight by rail, and including a permanently attached tank.

*Total actual annual facility-level organic liquid loading volume* means the total facility-level actual volume of organic liquid loaded for transport within or out of the facility through transfer racks that are part of the affected source into transport vehicles (for existing affected sources) or into transport vehicles and containers (for new affected sources) based on a 3-year rolling average, calculated annually.

(1) For existing affected sources, each 3-year rolling average is based on actual facility-level loading volume during each calendar year (January 1 through December 31) in the 3-year period. For calendar year 2004 only (the first year of the initial 3-year rolling average), if an owner or operator of an affected source does not have actual loading volume data for the time period from January 1, 2004, through February 2, 2004 (the time period prior to the effective date of the OLD NESHAP), the owner or operator shall compute a facility-level loading volume for this time period as follows: At the end of the 2004 calendar year, the owner or operator shall calculate a daily average facility-level loading volume (based on the actual loading volume for February 3, 2004, through December 31, 2004) and use that daily average to estimate the facility-level loading volume for the period of time from January 1, 2004, through February 2, 2004. The owner or operator shall then sum the estimated facility-level loading volume from January 1, 2004, through February 2, 2004, and the actual facility-level loading volume from February 3, 2004, through December 31, 2004, to calculate the annual facility-level loading volume for calendar year 2004.

(2)(i) For new affected sources, the 3-year rolling average is calculated as an average of three 12-month periods. An owner or operator must select as the beginning calculation date with which to start the calculations as either the initial startup date of the new affected source or the first day of the calendar month following the month in which startup occurs. Once selected, the date with which the calculations begin cannot be changed.

(ii) The initial 3-year rolling average is based on the projected maximum facility-level annual loading volume for each of the 3 years following the selected beginning calculation date. The second 3-year rolling average is based on actual facility-level loading volume for the first year of operation plus a new projected maximum facility-level annual loading volume for second and third years following the selected beginning calculation date. The third 3-year rolling average is based on actual facility-level loading volume for the first 2 years of operation plus a new projected maximum annual facility-level loading volume for the third year following the beginning calculation date. Subsequent 3-year rolling averages are based on actual facility-level loading volume for each year in the 3-year rolling average.

*Transfer rack* means a single system used to load organic liquids into, or unload organic liquids out of, transport vehicles or containers. It includes all loading and unloading arms, pumps, meters, shutoff valves, relief valves, and other piping and equipment necessary for the transfer operation. Transfer equipment and operations that are physically separate (i.e., do not share common piping, valves, and other equipment) are considered to be separate transfer racks.

*Transport vehicle* means a cargo tank or tank car.

*Vapor balancing system* means:

(1) A piping system that collects organic HAP vapors displaced from transport vehicles or containers during loading and routes the collected vapors to the storage tank from which the liquid being loaded originated or to another storage tank connected to a common header. For containers, the piping system must route the displaced vapors directly to the appropriate storage tank or to another storage tank connected to a common header in order to qualify as a vapor balancing system; or

(2) A piping system that collects organic HAP vapors displaced from the loading of a storage tank and routes the collected vapors to the transport vehicle from which the storage tank is filled.

*Vapor collection system* means any equipment located at the source (i.e., at the OLD operation) that is not open to the atmosphere; that is composed of piping, connections, and, if necessary, flow-inducing devices; and that is used for:

(1) Containing and conveying vapors displaced during the loading of transport vehicles to a control device;

(2) Containing and directly conveying vapors displaced during the loading of containers; or

(3) Vapor balancing. This does not include any of the vapor collection equipment that is installed on the transport vehicle.

*Vapor-tight transport vehicle* means a transport vehicle that has been demonstrated to be vapor-tight. To be considered vapor-tight, a transport vehicle equipped with vapor collection equipment must undergo a pressure change of no more than 250 pascals (1 inch of water) within 5 minutes after it is pressurized to 4,500 pascals (18 inches of water). This capability must be demonstrated annually using the procedures specified in EPA Method 27 of 40 CFR part 60, appendix A. For all other transport vehicles, vapor tightness is demonstrated by performing the U.S. DOT pressure test procedures for tank cars and cargo tanks.

*Work practice standard* means any design, equipment, work practice, or operational standard, or combination thereof, that is promulgated pursuant to section 112(h) of the CAA.

[69 FR 5063, Feb. 3, 2004, as amended at 71 FR 42911, July 28, 2006]

[↑ Back to Top](#)

**Table 1 to Subpart EEEE of Part 63—Organic Hazardous Air Pollutants**

You must use the organic HAP information listed in the following table to determine which of the liquids handled at your facility meet the HAP content criteria in the definition of Organic Liquid in §63.2406.

<b>Compound name</b>	<b>CAS No.<sup>1</sup></b>
2,4-D salts and esters	94-75-7
Acetaldehyde	75-07-0
Acetonitrile	75-05-8
Acetophenone	98-86-2
Acrolein	107-02-8
Acrylamide	79-06-1
Acrylic acid	79-10-7
Acrylonitrile	107-13-1
Allyl chloride	107-05-1
Aniline	62-53-3
Benzene	71-43-2
Biphenyl	92-52-4
Butadiene (1,3-)	106-99-0
Carbon tetrachloride	56-23-5

Chloroacetic acid	79-11-8
Chlorobenzene	108-90-7
2-Chloro-1,3-butadiene (Chloroprene)	126-99-8
Chloroform	67-66-3
m-Cresol	108-39-4
o-Cresol	95-48-7
p-Cresol	106-44-5
Cresols/cresylic acid	1319-77-3
Cumene	98-82-8
Dibenzofurans	132-64-9
Dibutylphthalate	84-74-2
Dichloroethane (1,2-) (Ethylene dichloride) (EDC)	107-06-2
Dichloropropene (1,3-)	542-75-6
Diethanolamine	111-42-2
Diethyl aniline (N,N-)	121-69-7
Diethylene glycol monobutyl ether	112-34-5
Diethylene glycol monomethyl ether	111-77-3
Diethyl sulfate	64-67-5
Dimethyl formamide	68-12-2
Dimethylhydrazine (1,1-)	57-14-7



Dioxane (1,4-) (1,4-Diethyleneoxide)	123-91-1
Epichlorohydrin (1-Chloro-2,3-epoxypropane)	106-89-8
Epoxybutane (1,2-)	106-88-7
Ethyl acrylate	140-88-5
Ethylbenzene	100-41-4
Ethyl chloride (Chloroethane)	75-00-3
Ethylene dibromide (Dibromomethane)	106-93-4
Ethylene glycol	107-21-1
Ethylene glycol dimethyl ether	110-71-4
Ethylene glycol monomethyl ether	109-86-4
Ethylene glycol monomethyl ether acetate	110-49-6
Ethylene glycol monophenyl ether	122-99-6
Ethylene oxide	75-21-8
Ethylidene dichloride (1,1-Dichloroethane)	75-34-3
Formaldehyde	50-00-0
Hexachloroethane	67-72-1
Hexane	110-54-3
Hydroquinone	123-31-9
Isophorone	78-59-1
Maleic anhydride	108-31-6

Methanol	67-56-1
Methyl chloride (Chloromethane)	74-87-3
Methylene chloride (Dichloromethane)	75-09-2
Methylenedianiline (4,4'-)	101-77-9
Methylene diphenyl diisocyanate	101-68-8
Methyl hydrazine	60-34-4
Methyl isobutyl ketone (Hexone) (MIBK)	108-10-1
Methyl methacrylate	80-62-6
Methyl tert-butyl ether (MTBE)	1634-04-4
Naphthalene	91-20-3
Nitrobenzene	98-95-3
Phenol	108-9-52
Phthalic anhydride	85-44-9
Polycyclic organic matter	50-32-8
Propionaldehyde	123-38-6
Propylene dichloride (1,2-Dichloropropane)	78-87-5
Propylene oxide	75-56-9
Quinoline	91-22-5
Styrene	100-42-5
Styrene oxide	96-09-3

Tetrachloroethane (1,1,2,2-)	79-34-5
Tetrachloroethylene (Perchloroethylene)	127-18-4
Toluene	108-88-3
Toluene diisocyanate (2,4-)	584-84-9
o-Toluidine	95-53-4
Trichlorobenzene (1,2,4-)	120-82-1
Trichloroethane (1,1,1-) (Methyl chloroform)	71-55-6
Trichloroethane (1,1,2-) (Vinyl trichloride)	79-00-5
Trichloroethylene	79-01-6
Triethylamine	121-44-8
Trimethylpentane (2,2,4-)	540-84-1
Vinyl acetate	108-05-4
Vinyl chloride (Chloroethylene)	75-01-4
Vinylidene chloride (1,1-Dichloroethylene)	75-35-4
Xylene (m-)	108-38-3
Xylene (o-)	95-47-6
Xylene (p-)	106-42-3
Xylenes (isomers and mixtures)	1330-20-7

<sup>1</sup> CAS numbers refer to the Chemical Abstracts Services registry number assigned to specific compounds, isomers, or mixtures of compounds.

[69 FR 5063, Feb. 3, 2004, as amended at 71 FR 42913, July 28, 2006]

[↑ Back to Top](#)

**Table 2 to Subpart EEEE of Part 63—Emission Limits**

As stated in §63.2346, you must comply with the emission limits for the organic liquids distribution emission sources as follows:

If you own or operate . . .	And if . . .	Then you must . . .
1. A storage tank at an existing affected source with a capacity $\geq 18.9$ cubic meters (5,000 gallons) and $< 189.3$ cubic meters (50,000 gallons).	a. The stored organic liquid is not crude oil and if the annual average true vapor pressure of the total Table 1 organic HAP in the stored organic liquid is $\geq 27.6$ kilopascals (4.0 psia) and $< 76.6$ kilopascals (11.1 psia).	i. Reduce emissions of total organic HAP (or, upon approval, TOC) by at least 95 weight-percent or, as an option, to an exhaust concentration less than or equal to 20 ppmv, on a dry basis corrected to 3 percent oxygen for combustion devices using supplemental combustion air, by venting emissions through a closed vent system to any combination of control devices meeting the applicable requirements of 40 CFR part 63, subpart SS; OR
		ii. Comply with the work practice standards specified in table 4 to this subpart, items 1.a, 1.b, or 1.c for tanks storing liquids described in that table.
	b. The stored organic liquid is crude oil.	i. See the requirement in item 1.a.i or 1.a.ii of this table.
2. A storage tank at an existing affected source with a capacity $\geq 189.3$ cubic meters (50,000 gallons).	a. The stored organic liquid is not crude oil and if the annual average true vapor pressure of the total Table 1 organic HAP in the stored organic liquid is $< 76.6$ kilopascals (11.1 psia).	i. See the requirement in item 1.a.i or 1.a.ii of this table.
	b. The stored organic liquid is crude oil.	i. See the requirement in item 1.a.i or 1.a.ii of this table.
3. A storage tank at a reconstructed or new affected source with a capacity $\geq 18.9$	a. The stored organic liquid is not crude oil and if the annual average true vapor	i. See the requirement in item 1.a.i or 1.a.ii of this table.

cubic meters (5,000 gallons) and <37.9 cubic meters (10,000 gallons).	pressure of the total Table 1 organic HAP in the stored organic liquid is $\geq 27.6$ kilopascals (4.0 psia) and <76.6 kilopascals (11.1 psia).	
	b. The stored organic liquid is crude oil.	i. See the requirement in item 1.a.i or 1.a.ii of this table.
4. A storage tank at a reconstructed or new affected source with a capacity $\geq 37.9$ cubic meters (10,000 gallons) and <189.3 cubic meters (50,000 gallons).	a. The stored organic liquid is not crude oil and if the annual average true vapor pressure of the total Table 1 organic HAP in the stored organic liquid is $\geq 0.7$ kilopascals (0.1 psia) and <76.6 kilopascals (11.1 psia).	i. See the requirement in item 1.a.i or 1.a.ii of this table.
	b. The stored organic liquid is crude oil.	i. See the requirement in item 1.a.i or 1.a.ii of this table.
5. A storage tank at a reconstructed or new affected source with a capacity $\geq 189.3$ cubic meters (50,000 gallons).	a. The stored organic liquid is not crude oil and if the annual average true vapor pressure of the total Table 1 organic HAP in the stored organic liquid is <76.6 kilopascals (11.1 psia).	i. See the requirement in item 1.a.i or 1.a.ii of this table.
	b. The stored organic liquid is crude oil.	i. See the requirement in item 1.a.i or 1.a.ii of this table.
6. A storage tank at an existing, reconstructed, or new affected source meeting the capacity criteria specified in table 2 of this subpart, items 1 through 5.	a. The stored organic liquid is not crude oil and if the annual average true vapor pressure of the total Table 1 organic HAP in the stored organic liquid is $\geq 76.6$ kilopascals (11.1 psia).	i. Reduce emissions of total organic HAP (or, upon approval, TOC) by at least 95 weight-percent or, as an option, to an exhaust concentration less than or equal to 20 ppmv, on a dry basis corrected to 3 percent oxygen for combustion devices using supplemental combustion air, by venting emissions through a closed vent

		system to any combination of control devices meeting the applicable requirements of 40 CFR part 63, subpart SS; OR
		ii. Comply with the work practice standards specified in table 4 to this subpart, item 2.a, for tanks storing the liquids described in that table.
7. A transfer rack at an existing facility where the total actual annual facility-level organic liquid loading volume through transfer racks is equal to or greater than 800,000 gallons and less than 10 million gallons.	a. The total table 1 organic HAP content of the organic liquid being loaded through one or more of the transfer rack's arms is at least 98 percent by weight and is being loaded into a transport vehicle.	i. For all such loading arms at the rack, reduce emissions of total organic HAP (or, upon approval, TOC) from the loading of organic liquids either by venting the emissions that occur during loading through a closed vent system to any combination of control devices meeting the applicable requirements of 40 CFR part 63, subpart SS, achieving at least 98 weight-percent HAP reduction, OR, as an option, to an exhaust concentration less than or equal to 20 ppmv, on a dry basis corrected to 3 percent oxygen for combustion devices using supplemental combustion air; OR
		ii. During the loading of organic liquids, comply with the work practice standards specified in item 3 of table 4 to this subpart.
8. A transfer rack at an existing facility where the total actual annual facility-level organic liquid loading volume through transfer racks is $\geq 10$ million gallons.	a. One or more of the transfer rack's arms is loading an organic liquid into a transport vehicle.	i. See the requirements in items 7.a.i and 7.a.ii of this table.
9. A transfer rack at a new facility where the total actual annual facility-level organic liquid loading volume through transfer racks is less than 800,000 gallons	a. The total Table 1 organic HAP content of the organic liquid being loaded through one or more of the transfer rack's arms is at least 25 percent by weight and is being loaded into a transport	i. See the requirements in items 7.a.i and 7.a.ii of this table.

	vehicle	
	b. One or more of the transfer rack's arms is filling a container with a capacity equal to or greater than 55 gallons	i. For all such loading arms at the rack during the loading of organic liquids, comply with the provisions of §§63.924 through 63.927 of 40 CFR part 63, Subpart PP—National Emission Standards for Containers, Container Level 3 controls; OR ii. During the loading of organic liquids, comply with the work practice standards specified in item 3.a of Table 4 to this subpart.
10. A transfer rack at a new facility where the total actual annual facility-level organic liquid loading volume through transfer racks is equal to or greater than 800,000 gallons.	a. One or more of the transfer rack's arms is loading an organic liquid into a transport vehicle.	i. See the requirements in items 7.a.i and 7.a.ii of this table.
	b. One or more of the transfer rack's arms is filling a container with a capacity equal to or greater than 55 gallons.	i. For all such loading arms at the rack during the loading of organic liquids, comply with the provisions of §§63.924 through 63.927 of 40 CFR part 63, Subpart PP—National Emission Standards for Containers, Container Level 3 controls; OR
		ii. During the loading of organic liquids, comply with the work practice standards specified in item 3.a of table 4 to this subpart.

[69 FR 5063, Feb. 3, 2004, as amended at 71 FR 42913, July 28, 2006; 73 FR 21830, Apr. 23, 2008]

[↑ Back to Top](#)

**Table 3 to Subpart EEEE of Part 63—Operating Limits—High Throughput Transfer Racks**

As stated in §63.2346(e), you must comply with the operating limits for existing, reconstructed, or new affected sources as follows:

<b>For each existing, each reconstructed, and each new</b>	<b>You must . . .</b>
--	-----------------------

affected source using . . .	
1. A thermal oxidizer to comply with an emission limit in table 2 to this subpart	Maintain the daily average fire box or combustion zone temperature greater than or equal to the reference temperature established during the design evaluation or performance test that demonstrated compliance with the emission limit.
2. A catalytic oxidizer to comply with an emission limit in table 2 to this subpart	a. Replace the existing catalyst bed before the age of the bed exceeds the maximum allowable age established during the design evaluation or performance test that demonstrated compliance with the emission limit; AND
	b. Maintain the daily average temperature at the inlet of the catalyst bed greater than or equal to the reference temperature established during the design evaluation or performance test that demonstrated compliance with the emission limit; AND
	c. Maintain the daily average temperature difference across the catalyst bed greater than or equal to the minimum temperature difference established during the design evaluation or performance test that demonstrated compliance with the emission limit.
3. An absorber to comply with an emission limit in table 2 to this subpart	a. Maintain the daily average concentration level of organic compounds in the absorber exhaust less than or equal to the reference concentration established during the design evaluation or performance test that demonstrated compliance with the emission limit; OR
	b. Maintain the daily average scrubbing liquid temperature less than or equal to the reference temperature established during the design evaluation or performance test that demonstrated compliance with the emission limit; AND
	Maintain the difference between the specific gravities of the saturated and fresh scrubbing fluids greater than or equal to the difference established during the design evaluation or performance test that demonstrated compliance with the emission limit.
4. A condenser to comply with an emission limit in table 2 to this subpart	a. Maintain the daily average concentration level of organic compounds at the condenser exit less than or equal to the reference concentration established during the design evaluation or performance test that demonstrated compliance with the emission limit; OR



	b. Maintain the daily average condenser exit temperature less than or equal to the reference temperature established during the design evaluation or performance test that demonstrated compliance with the emission limit.
5. An adsorption system with adsorbent regeneration to comply with an emission limit in table 2 to this subpart	a. Maintain the daily average concentration level of organic compounds in the adsorber exhaust less than or equal to the reference concentration established during the design evaluation or performance test that demonstrated compliance with the emission limit; OR
	b. Maintain the total regeneration stream mass flow during the adsorption bed regeneration cycle greater than or equal to the reference stream mass flow established during the design evaluation or performance test that demonstrated compliance with the emission limit; AND
	Before the adsorption cycle commences, achieve and maintain the temperature of the adsorption bed after regeneration less than or equal to the reference temperature established during the design evaluation or performance test that demonstrated compliance with the emission limit; AND
	Achieve a pressure reduction during each adsorption bed regeneration cycle greater than or equal to the pressure reduction established during the design evaluation or performance test that demonstrated compliance with the emission limit.
6. An adsorption system without adsorbent regeneration to comply with an emission limit in table 2 to this subpart	a. Maintain the daily average concentration level of organic compounds in the adsorber exhaust less than or equal to the reference concentration established during the design evaluation or performance test that demonstrated compliance with the emission limit; OR
	b. Replace the existing adsorbent in each segment of the bed with an adsorbent that meets the replacement specifications established during the design evaluation or performance test before the age of the adsorbent exceeds the maximum allowable age established during the design evaluation or performance test that demonstrated compliance with the emission limit; AND
	Maintain the temperature of the adsorption bed less than or equal to the reference temperature established during the design evaluation or performance test that demonstrated compliance with the emission limit.

7. A flare to comply with an emission limit in table 2 to this subpart	a. Comply with the equipment and operating requirements in §63.987(a); AND b. Conduct an initial flare compliance assessment in accordance with §63.987(b); AND
	c. Install and operate monitoring equipment as specified in §63.987(c).
8. Another type of control device to comply with an emission limit in table 2 to this subpart	Submit a monitoring plan as specified in §§63.995(c) and 63.2366(b), and monitor the control device in accordance with that plan.

[69 FR 5063, Feb. 3, 2004, as amended at 71 FR 42914, July 28, 2006]

[↑ Back to Top](#)

**Table 4 to Subpart EEEE of Part 63—Work Practice Standards**

As stated in §63.2346, you may elect to comply with one of the work practice standards for existing, reconstructed, or new affected sources in the following table. If you elect to do so, . . .

<b>For each . . .</b>	<b>You must . . .</b>
1. Storage tank at an existing, reconstructed, or new affected source meeting any set of tank capacity and organic HAP vapor pressure criteria specified in table 2 to this subpart, items 1 through 5	a. Comply with the requirements of 40 CFR part 63, subpart WW (control level 2), if you elect to meet 40 CFR part 63, subpart WW (control level 2) requirements as an alternative to the emission limit in table 2 to this subpart, items 1 through 5; OR
	b. Comply with the requirements of §63.984 for routing emissions to a fuel gas system or back to a process; OR
	c. Comply with the requirements of §63.2346(a)(4) for vapor balancing emissions to the transport vehicle from which the storage tank is filled.
2. Storage tank at an existing, reconstructed, or new affected source meeting any set of tank capacity and organic HAP vapor pressure criteria specified in table 2 to this subpart, item 6	a. Comply with the requirements of §63.984 for routing emissions to a fuel gas system or back to a process; OR b. Comply with the requirements of §63.2346(a)(4) for vapor balancing emissions to the transport vehicle from which the storage tank is filled.

3. Transfer rack subject to control based on the criteria specified in table 2 to this subpart, items 7 through 10, at an existing, reconstructed, or new affected source	a. If the option of a vapor balancing system is selected, install and, during the loading of organic liquids, operate a system that meets the requirements in table 7 to this subpart, item 3.b.i and item 3.b.ii, as applicable; OR
	b. Comply with the requirements of §63.984 during the loading of organic liquids, for routing emissions to a fuel gas system or back to a process.
4. Pump, valve, and sampling connection that operates in organic liquids service at least 300 hours per year at an existing, reconstructed, or new affected source	Comply with the requirements for pumps, valves, and sampling connections in 40 CFR part 63, subpart TT (control level 1), subpart UU (control level 2), or subpart H.
5. Transport vehicles equipped with vapor collection equipment that are loaded at transfer racks that are subject to control based on the criteria specified in table 2 to this subpart, items 7 through 10	Follow the steps in 40 CFR 60.502(e) to ensure that organic liquids are loaded only into vapor-tight transport vehicles, and comply with the provisions in 40 CFR 60.502(f), (g), (h), and (i), except substitute the term transport vehicle at each occurrence of tank truck or gasoline tank truck in those paragraphs.
6. Transport vehicles equipped without vapor collection equipment that are loaded at transfer racks that are subject to control based on the criteria specified in table 2 to this subpart, items 7 through 10	Ensure that organic liquids are loaded only into transport vehicles that have a current certification in accordance with the U.S. DOT pressure test requirements in 49 CFR 180 (cargo tanks) or 49 CFR 173.31 (tank cars).

[71 FR 42915, July 28, 2006]

[↑ Back to Top](#)

**Table 5 to Subpart EEEE of Part 63—Requirements for Performance Tests and Design Evaluations**

As stated in §§63.2354(a) and 63.2362, you must comply with the requirements for performance tests and design evaluations for existing, reconstructed, or new affected sources as follows:

<b>For . . .</b>	<b>You must conduct . . .</b>	<b>According to . . .</b>	<b>Using . . .</b>	<b>To determine . . .</b>	<b>According to the following requirements . . .</b>
1. Each existing, each reconstructed, and	a. A performance test to determine the	i. §63.985(b)(1)(ii), §63.988(b),	(1) EPA Method 1 or 1A in appendix	(A) Sampling port locations and the	(i) Sampling sites must be located at the inlet and outlet

<p>each new affected source using a nonflare control device to comply with an emission limit in Table 2 to this subpart, items 1 through 10</p>	<p>organic HAP (or, upon approval, TOC) control efficiency of each nonflare control device, OR the exhaust concentration of each combustion device; OR</p>	<p>§63.990(b), or §63.995(b)</p>	<p>A-1 of 40 CFR part 60, as appropriate</p>	<p>required number of traverse points</p>	<p>of each control device if complying with the control efficiency requirement or at the outlet of the control device if complying with the exhaust concentration requirement; AND (ii) the outlet sampling site must be located at each control device prior to any releases to the atmosphere.</p>
			<p>(2) EPA Method 2, 2A, 2C, 2D, or 2F in appendix A-1 of 40 CFR part 60, or EPA Method 2G in appendix A-2 of 40 CFR part 60, as appropriate</p>	<p>(A) Stack gas velocity and volumetric flow rate</p>	<p>See the requirements in items 1.a.i.(1)(A)(i) and (ii) of this table.</p>
			<p>(3) EPA Method 3 or 3B in appendix A-2 of 40 CFR part 60, as appropriate</p>	<p>(A) Concentration of CO<sub>2</sub> and O<sub>2</sub> and dry molecular weight of the stack gas</p>	<p>See the requirements in items 1.a.i.(1)(A)(i) and (ii) of this table.</p>
			<p>(4) EPA Method 4 in appendix A-3 of 40 CFR part</p>	<p>(A) Moisture content of the stack gas</p>	<p>See the requirements in items 1.a.i.(1)(A)(i) and</p>

			60		(ii) of this table.
			(5) EPA Method 18 in appendix A-6 of 40 CFR part 60, or EPA Method 25 or 25A in appendix A-7 of 40 CFR part 60, as appropriate, or EPA Method 316 in appendix A of 40 CFR part 63 for measuring form-aldehyde	(A) Total organic HAP (or, upon approval, TOC), or formaldehyde emissions	(i) The organic HAP used for the calibration gas for EPA Method 25A in appendix A-7 of 40 CFR part 60 must be the single organic HAP representing the largest percent by volume of emissions; AND (ii) During the performance test, you must establish the operating parameter limits within which total organic HAP (or, upon approval, TOC) emissions are reduced by the required weight-percent or, as an option for nonflare combustion devices, to 20 ppmv exhaust concentration.
	b. A design evaluation (for nonflare control devices) to determine the organic HAP (or, upon approval, TOC) control efficiency of each nonflare	§63.985(b)(1)(i)			During a design evaluation, you must establish the operating parameter limits within which total organic HAP, (or, upon approval, TOC) emissions are reduced by at least 95 weight-

	control device, or the exhaust concentration of each combustion control device				percent for storage tanks or 98 weight-percent for transfer racks, or, as an option for nonflare combustion devices, to 20 ppmv exhaust concentration.
2. Each transport vehicle that you own that is equipped with vapor collection equipment and is loaded with organic liquids at a transfer rack that is subject to control based on the criteria specified in table 2 to this subpart, items 7 through 10, at an existing, reconstructed, or new affected source	A performance test to determine the vapor tightness of the tank and then repair as needed until it passes the test.		EPA Method 27 in appendix A of 40 CFR part 60	Vapor tightness	The pressure change in the tank must be no more than 250 pascals (1 inch of water) in 5 minutes after it is pressurized to 4,500 pascals (18 inches of water).

[71 FR 42916, July 28, 2006, as amended at 73 FR 21831, Apr. 23, 2008]

[↑ Back to Top](#)

**Table 6 to Subpart EEEE of Part 63—Initial Compliance With Emission Limits**

As stated in §§63.2370(a) and 63.2382(b), you must show initial compliance with the emission limits for existing, reconstructed, or new affected sources as follows:

<b>For each . . .</b>	<b>For the following emission limit . . .</b>	<b>You have demonstrated initial compliance if . . .</b>
1. Storage tank at an existing,	Reduce total organic HAP (or,	Total organic HAP (or, upon approval,

reconstructed, or new affected source meeting any set of tank capacity and liquid organic HAP vapor pressure criteria specified in Table 2 to this subpart, items 1 through 6	upon approval, TOC) emissions by at least 95 weight-percent, or as an option for nonflare combustion devices to an exhaust concentration of $\leq 20$ ppmv	TOC) emissions, based on the results of the performance testing or design evaluation specified in Table 5 to this subpart, item 1.a or 1.b, respectively, are reduced by at least 95 weight-percent or as an option for nonflare combustion devices to an exhaust concentration $\leq 20$ ppmv.
2. Transfer rack that is subject to control based on the criteria specified in table 2 to this subpart, items 7 through 10, at an existing, reconstructed, or new affected source	Reduce total organic HAP (or, upon approval, TOC) emissions from the loading of organic liquids by at least 98 weight-percent, or as an option for nonflare combustion devices to an exhaust concentration of $\leq 20$ ppmv	Total organic HAP (or, upon approval, TOC) emissions from the loading of organic liquids, based on the results of the performance testing or design evaluation specified in table 5 to this subpart, item 1.a or 1.b, respectively, are reduced by at least 98 weight-percent or as an option for nonflare combustion devices to an exhaust concentration of $\leq 20$ ppmv.

[71 FR 42918, July 28, 2006, as amended at 73 FR 21832, Apr. 23, 2008]

[↑ Back to Top](#)

**Table 7 to Subpart EEEE of Part 63—Initial Compliance With Work Practice Standards**

<b>For each . . .</b>	<b>If you . . .</b>	<b>You have demonstrated initial compliance if . . .</b>
1. Storage tank at an existing affected source meeting either set of tank capacity and liquid organic HAP vapor pressure criteria specified in Table 2 to this subpart, items 1 or 2	a. Install a floating roof or equivalent control that meets the requirements in Table 4 to this subpart, item 1.a	i. After emptying and degassing, you visually inspect each internal floating roof before the refilling of the storage tank and perform seal gap inspections of the primary and secondary rim seals of each external floating roof within 90 days after the refilling of the storage tank.
	b. Route emissions to a fuel gas system or back to a process	i. You meet the requirements in §63.984(b) and submit the statement of connection required by §63.984(c).
	c. Install and, during the filling of the storage tank with organic liquids, operate a vapor balancing system	i. You meet the requirements in §63.2346(a)(4).

<p>2. Storage tank at a reconstructed or new affected source meeting any set of tank capacity and liquid organic HAP vapor pressure criteria specified in Table 2 to this subpart, items 3 through 5</p>	<p>a. Install a floating roof or equivalent control that meets the requirements in Table 4 to this subpart, item 1.a</p>	<p>i. You visually inspect each internal floating roof before the initial filling of the storage tank, and perform seal gap inspections of the primary and secondary rim seals of each external floating roof within 90 days after the initial filling of the storage tank.</p>
	<p>b. Route emissions to a fuel gas system or back to a process</p>	<p>i. See item 1.b.i of this table.</p>
	<p>c. Install and, during the filling of the storage tank with organic liquids, operate a vapor balancing system</p>	<p>i. See item 1.c.i of this table.</p>
<p>3. Transfer rack that is subject to control based on the criteria specified in table 2 to this subpart, items 7 through 10, at an existing, reconstructed, or new affected source</p>	<p>a. Load organic liquids only into transport vehicles having current vapor tightness certification as described in table 4 to this subpart, item 5 and item 6</p>	<p>i. You comply with the provisions specified in table 4 to this subpart, item 5 or item 6, as applicable.</p>
	<p>b. Install and, during the loading of organic liquids, operate a vapor balancing system</p>	<p>i. You design and operate the vapor balancing system to route organic HAP vapors displaced from loading of organic liquids into transport vehicles to the storage tank from which the liquid being loaded originated or to another storage tank connected to a common header. ii. You design and operate the vapor balancing system to route organic HAP vapors displaced from loading of organic liquids into containers directly (e.g., no intervening tank or containment area such as a room) to the storage tank from which the liquid being loaded originated or to another storage tank connected to a common header.</p>
	<p>c. Route emissions to a</p>	<p>i. See item 1.b.i of this table.</p>



	fuel gas system or back to a process	
4. Equipment leak component, as defined in §63.2406, that operates in organic liquids service $\geq$ 300 hours per year at an existing, reconstructed, or new affected source	a. Carry out a leak detection and repair program or equivalent control according to one of the subparts listed in table 4 to this subpart, item 4.a	i. You specify which one of the control programs listed in table 4 to this subpart you have selected, OR ii. Provide written specifications for your equivalent control approach.

[71 FR 42918, July 28, 2006, as amended at 73 FR 21833, Apr. 23, 2008]

[↑ Back to Top](#)

**Table 8 to Subpart EEEE of Part 63—Continuous Compliance With Emission Limits**

As stated in §§63.2378(a) and (b) and 63.2390(b), you must show continuous compliance with the emission limits for existing, reconstructed, or new affected sources according to the following table:

<b>For each . . .</b>	<b>For the following emission limit . . .</b>	<b>You must demonstrate continuous compliance by . . .</b>
1. Storage tank at an existing, reconstructed, or new affected source meeting any set of tank capacity and liquid organic HAP vapor pressure criteria specified in table 2 to this subpart, items 1 through 6	a. Reduce total organic HAP (or, upon approval, TOC) emissions from the closed vent system and control device by 95 weight-percent or greater, or as an option to 20 ppmv or less of total organic HAP (or, upon approval, TOC) in the exhaust of combustion devices	i. Performing CMS monitoring and collecting data according to §§63.2366, 63.2374, and 63.2378; AND ii. Maintaining the operating limits established during the design evaluation or performance test that demonstrated compliance with the emission limit.
2. Transfer rack that is subject to control based on the criteria specified in table 2 to this subpart, items 7 through 10, at an existing, reconstructed, or new affected source	a. Reduce total organic HAP (or, upon approval, TOC) emissions during the loading of organic liquids from the closed vent system and control device by 98 weight-percent or greater, or as an option to 20 ppmv or less of total organic HAP (or, upon approval, TOC) in the exhaust of combustion devices	i. Performing CMS monitoring and collecting data according to §§63.2366, 63.2374, and 63.2378 during the loading of organic liquids; AND ii. Maintaining the operating limits established during the design evaluation or performance test that

		demonstrated compliance with the emission limit during the loading of organic liquids.
--	--	--

[71 FR 42919, July 28, 2006]

[↑ Back to Top](#)

**Table 9 to Subpart EEEE of Part 63—Continuous Compliance With Operating Limits—High Throughput Transfer Racks**

As stated in §§63.2378(a) and (b) and 63.2390(b), you must show continuous compliance with the operating limits for existing, reconstructed, or new affected sources according to the following table:

<b>For each existing, reconstructed, and each new affected source using . . .</b>	<b>For the following operating limit . . .</b>	<b>You must demonstrate continuous compliance by . . .</b>
1. A thermal oxidizer to comply with an emission limit in table 2 to this subpart.	a. Maintain the daily average fire box or combustion zone, as applicable, temperature greater than or equal to the reference temperature established during the design evaluation or performance test that demonstrated compliance with the emission limit.	i. Continuously monitoring and recording fire box or combustion zone, as applicable, temperature every 15 minutes and maintaining the daily average fire box temperature greater than or equal to the reference temperature established during the design evaluation or performance test that demonstrated compliance with the emission limit; AND ii. Keeping the applicable records required in §63.998.
2. A catalytic oxidizer to comply with an emission limit in table 2 to this subpart.	a. Replace the existing catalyst bed before the age of the bed exceeds the maximum allowable age established during the design evaluation or performance test that demonstrated compliance with the emission limit; AND	i. Replacing the existing catalyst bed before the age of the bed exceeds the maximum allowable age established during the design evaluation or performance test that demonstrated compliance with the emission limit; AND ii. Keeping the applicable records required in §63.998.
	b. Maintain the daily average temperature at the inlet of the catalyst bed greater than or equal to the reference temperature established	i. Continuously monitoring and recording the temperature at the inlet of the catalyst bed at least every 15 minutes and maintaining the daily average temperature

	during the design evaluation or performance test that demonstrated compliance with the emission limit; AND	at the inlet of the catalyst bed greater than or equal to the reference temperature established during the design evaluation or performance test that demonstrated compliance with the emission limit; AND ii. Keeping the applicable records required in §63.998.
	c. Maintain the daily average temperature difference across the catalyst bed greater than or equal to the minimum temperature difference established during the design evaluation or performance test that demonstrated compliance with the emission limit.	i. Continuously monitoring and recording the temperature at the outlet of the catalyst bed every 15 minutes and maintaining the daily average temperature difference across the catalyst bed greater than or equal to the minimum temperature difference established during the design evaluation or performance test that demonstrated compliance with the emission limit; AND ii. Keeping the applicable records required in §63.998.
3. An absorber to comply with an emission limit in table 2 to this subpart.	a. Maintain the daily average concentration level of organic compounds in the absorber exhaust less than or equal to the reference concentration established during the design evaluation or performance test that demonstrated compliance with the emission limit; OR	i. Continuously monitoring the organic concentration in the absorber exhaust and maintaining the daily average concentration less than or equal to the reference concentration established during the design evaluation or performance test that demonstrated compliance with the emission limit; AND ii. Keeping the applicable records required in §63.998.
	b. Maintain the daily average scrubbing liquid temperature less than or equal to the reference temperature established during the design evaluation or performance test that demonstrated compliance with the emission limit; AND Maintain the difference between the specific gravities of the saturated and fresh scrubbing fluids greater than or equal to the difference established during the design evaluation or	i. Continuously monitoring the scrubbing liquid temperature and maintaining the daily average temperature less than or equal to the reference temperature established during the design evaluation or performance test that demonstrated compliance with the emission limit; AND ii. Maintaining the difference between the specific gravities greater than or equal to the difference established during the design evaluation or performance test that demonstrated compliance with the

	performance test that demonstrated compliance with the emission limit.	emission limit; AND iii. Keeping the applicable records required in §63.998.
4. A condenser to comply with an emission limit in table 2 to this subpart.	a. Maintain the daily average concentration level of organic compounds at the exit of the condenser less than or equal to the reference concentration established during the design evaluation or performance test that demonstrated compliance with the emission limit; OR	i. Continuously monitoring the organic concentration at the condenser exit and maintaining the daily average concentration less than or equal to the reference concentration established during the design evaluation or performance test that demonstrated compliance with the emission limit; AND ii. Keeping the applicable records required in §63.998.
	b. Maintain the daily average condenser exit temperature less than or equal to the reference temperature established during the design evaluation or performance test that demonstrated compliance with the emission limit.	i. Continuously monitoring and recording the temperature at the exit of the condenser at least every 15 minutes and maintaining the daily average temperature less than or equal to the reference temperature established during the design evaluation or performance test that demonstrated compliance with the emission limit; AND ii. Keeping the applicable records required in §63.998.
5. An adsorption system with adsorbent regeneration to comply with an emission limit in table 2 to this subpart.	a. Maintain the daily average concentration level of organic compounds in the adsorber exhaust less than or equal to the reference concentration established during the design evaluation or performance test that demonstrated compliance with the emission limit; OR	i. Continuously monitoring the daily average organic concentration in the adsorber exhaust and maintaining the concentration less than or equal to the reference concentration established during the design evaluation or performance test that demonstrated compliance with the emission limit; AND ii. Keeping the applicable records required in §63.998.
	b. Maintain the total regeneration stream mass flow during the adsorption bed regeneration cycle greater than or equal to the reference stream mass flow established during the design evaluation or performance	i. Maintaining the total regeneration stream mass flow during the adsorption bed regeneration cycle greater than or equal to the reference stream mass flow established during the design evaluation or performance test that demonstrated

	<p>test that demonstrated compliance with the emission limit; AND          Before the adsorption cycle commences, achieve and maintain the temperature of the adsorption bed after regeneration less than or equal to the reference temperature established during the design evaluation or performance test; AND          Achieve greater than or equal to the pressure reduction during the adsorption bed regeneration cycle established during the design evaluation or performance test that demonstrated compliance with the emission limit.</p>	<p>compliance with the emission limit; AND          ii. Maintaining the temperature of the adsorption bed after regeneration less than or equal to the reference temperature established during the design evaluation or performance test that demonstrated compliance with the emission limit; AND          iii. Achieving greater than or equal to the pressure reduction during the regeneration cycle established during the design evaluation or performance test that demonstrated compliance with the emission limit; AND          iv. Keeping the applicable records required in §63.998.</p>
<p>6. An adsorption system without adsorbent regeneration to comply with an emission limit in table 2 to this subpart.</p>	<p>a. Maintain the daily average concentration level of organic compounds in the adsorber exhaust less than or equal to the reference concentration established during the design evaluation or performance test that demonstrated compliance with the emission limit; OR</p>	<p>i. Continuously monitoring the organic concentration in the adsorber exhaust and maintaining the concentration less than or equal to the reference concentration established during the design evaluation or performance test that demonstrated compliance with the emission limit; AND          ii. Keeping the applicable records required in §63.998.</p>
	<p>b. Replace the existing adsorbent in each segment of the bed before the age of the adsorbent exceeds the maximum allowable age established during the design evaluation or performance test that demonstrated compliance with the emission limit; AND          Maintain the temperature of the adsorption bed less than or equal to the reference temperature established during the design evaluation or performance test that demonstrated compliance with the emission limit.</p>	<p>i. Replacing the existing adsorbent in each segment of the bed with an adsorbent that meets the replacement specifications established during the design evaluation or performance test before the age of the adsorbent exceeds the maximum allowable age established during the design evaluation or performance test that demonstrated compliance with the emission limit; AND          ii. Maintaining the temperature of the adsorption bed less than or equal to the reference temperature established during the design evaluation or performance test that demonstrated compliance with the emission limit; AND</p>

		iii. Keeping the applicable records required in §63.998.
7. A flare to comply with an emission limit in table 2 to this subpart.	a. Maintain a pilot flame in the flare at all times that vapors may be vented to the flare (§63.11(b)(5)); AND	i. Continuously operating a device that detects the presence of the pilot flame; AND ii. Keeping the applicable records required in §63.998.
	b. Maintain a flare flame at all times that vapors are being vented to the flare (§63.11(b)(5)); AND	i. Maintaining a flare flame at all times that vapors are being vented to the flare; AND ii. Keeping the applicable records required in §63.998.
	c. Operate the flare with no visible emissions, except for up to 5 minutes in any 2 consecutive hours (§63.11(b)(4)); AND EITHER	i. Operating the flare with no visible emissions exceeding the amount allowed; AND ii. Keeping the applicable records required in §63.998.
	d.1. Operate the flare with an exit velocity that is within the applicable limits in §63.11(b)(7) and (8) and with a net heating value of the gas being combusted greater than the applicable minimum value in §63.11(b)(6)(ii); OR	i. Operating the flare within the applicable exit velocity limits; AND ii. Operating the flare with the gas heating value greater than the applicable minimum value; AND iii. Keeping the applicable records required in §63.998.
	d.2. Adhere to the requirements in §63.11(b)(6)(i).	i. Operating the flare within the applicable limits in 63.11(b)(6)(i); AND ii. Keeping the applicable records required in §63.998.
8. Another type of control device to comply with an emission limit in table 2 to this subpart.	Submit a monitoring plan as specified in §§63.995(c) and 63.2366(c), and monitor the control device in accordance with that plan.	Submitting a monitoring plan and monitoring the control device according to that plan.

[69 FR 5063, Feb. 3, 2004, as amended at 71 FR 42919, July 28, 2006]

[↑ Back to Top](#)

**Table 10 to Subpart EEEE of Part 63—Continuous Compliance With Work Practice Standards**

As stated in §§63.2378(a) and (b) and 63.2386(c)(6), you must show continuous compliance with the work practice standards for existing, reconstructed, or new affected sources according to the following table:

<b>For each . . .</b>	<b>For the following standard . . .</b>	<b>You must demonstrate continuous compliance by . . .</b>
1. Internal floating roof (IFR) storage tank at an existing, reconstructed, or new affected source meeting any set of tank capacity, and vapor pressure criteria specified in table 2 to this subpart, items 1 through 5.	a. Install a floating roof designed and operated according to the applicable specifications in §63.1063(a) and (b).	i. Visually inspecting the floating roof deck, deck fittings, and rim seals of each IFR once per year (§63.1063(d)(2)); AND ii. Visually inspecting the floating roof deck, deck fittings, and rim seals of each IFR either each time the storage tank is completely emptied and degassed or every 10 years, whichever occurs first (§63.1063(c)(1), (d)(1), and (e)); AND iii. Keeping the tank records required in §63.1065.
2. External floating roof (EFR) storage tank at an existing, reconstructed, or new affected source meeting any set of tank capacity and vapor pressure criteria specified in table 2 to this subpart, items 1 through 5.	a. Install a floating roof designed and operated according to the applicable specifications in §63.1063(a) and (b).	i. Visually inspecting the floating roof deck, deck fittings, and rim seals of each EFR either each time the storage tank is completely emptied and degassed or every 10 years, whichever occurs first (§63.1063(c)(2), (d), and (e)); AND ii. Performing seal gap measurements on the secondary seal of each EFR at least once every year, and on the primary seal of each EFR at least every 5 years (§63.1063(c)(2), (d), and (e)); AND iii. Keeping the tank records required in §63.1065.
3. IFR or EFR tank at an existing, reconstructed, or new affected source meeting any set of tank capacity and vapor pressure criteria specified in table 2 to this subpart, items 1 through 5.	a. Repair the conditions causing storage tank inspection failures (§63.1063(e)).	i. Repairing conditions causing inspection failures: before refilling the storage tank with organic liquid, or within 45 days (or up to 105 days with extensions) for a tank containing organic liquid; AND ii. Keeping the tank records required in §63.1065(b).

<p>4. Transfer rack that is subject to control based on the criteria specified in table 2 to this subpart, items 7 through 10, at an existing, reconstructed, or new affected source.</p>	<p>a. Ensure that organic liquids are loaded into transport vehicles in accordance with the requirements in table 4 to this subpart, items 5 or 6, as applicable.</p>	<p>i. Ensuring that organic liquids are loaded into transport vehicles in accordance with the requirements in table 4 to this subpart, items 5 or 6, as applicable.</p>
	<p>b. Install and, during the loading of organic liquids, operate a vapor balancing system.</p>	<p>i. Monitoring each potential source of vapor leakage in the system quarterly during the loading of a transport vehicle or the filling of a container using the methods and procedures described in the rule requirements selected for the work practice standard for equipment leak components as specified in table 4 to this subpart, item 4. An instrument reading of 500 ppmv defines a leak. Repair of leaks is performed according to the repair requirements specified in your selected equipment leak standards.</p>
	<p>c. Route emissions to a fuel gas system or back to a process.</p>	<p>i. Continuing to meet the requirements specified in §63.984(b).</p>
<p>5. Equipment leak component, as defined in §63.2406, that operates in organic liquids service at least 300 hours per year.</p>	<p>a. Comply with the requirements of 40 CFR part 63, subpart TT, UU, or H.</p>	<p>i. Carrying out a leak detection and repair program in accordance with the subpart selected from the list in item 5.a of this table.</p>
<p>6. Storage tank at an existing, reconstructed, or new affected source meeting any of the tank capacity and vapor pressure criteria specified in table 2 to this subpart, items 1 through 6.</p>	<p>a. Route emissions to a fuel gas system or back to the process.</p>	<p>i. Continuing to meet the requirements specified in §63.984(b).</p>
	<p>b. Install and, during the filling of the storage tank with organic liquids,</p>	<p>i. Except for pressure relief devices, monitoring each potential source of vapor leakage in the system, including, but not limited to pumps,</p>



	operate a vapor balancing system.	valves, and sampling connections, quarterly during the loading of a storage tank using the methods and procedures described in the rule requirements selected for the work practice standard for equipment leak components as specified in Table 4 to this subpart, item 4. An instrument reading of 500 ppmv defines a leak. Repair of leaks is performed according to the repair requirements specified in your selected equipment leak standards. For pressure relief devices, comply with §63.2346(a)(4)(v). If no loading of a storage tank occurs during a quarter, then monitoring of the vapor balancing system is not required.
--	-----------------------------------	--

[69 FR 5063, Feb. 3, 2004, as amended at 71 FR 42922, July 28, 2006; 73 FR 40982, July 17, 2008]

[↑ Back to Top](#)

**Table 11 to Subpart EEEE of Part 63—Requirements for Reports**

As stated in §63.2386(a), (b), and (f), you must submit compliance reports and startup, shutdown, and malfunction reports according to the following table:

<b>You must submit a(n) . . .</b>	<b>The report must contain . . .</b>	<b>You must submit the report . . .</b>
1. Compliance report or Periodic Report	a. The information specified in §63.2386(c), (d), (e). If you had a SSM during the reporting period and you took actions consistent with your SSM plan, the report must also include the information in §63.10(d)(5)(i); AND	Semiannually, and it must be postmarked by January 31 or July 31, in accordance with §63.2386(b).
	b. The information required by 40 CFR part 63, subpart TT, UU, or H, as applicable, for pumps, valves, and sampling connections; AND	See the submission requirement in item 1.a of this table.
	c. The information required by §63.999(c); AND	See the submission requirement in item 1.a of this table.

	d. The information specified in §63.1066(b) including: Notification of inspection, inspection results, requests for alternate devices, and requests for extensions, as applicable.	See the submission requirement in item 1.a. of this table.
2. Immediate SSM report if you had a SSM that resulted in an applicable emission standard in the relevant standard being exceeded, and you took an action that was not consistent with your SSM plan	a. The information required in §63.10(d)(5)(ii)	i. By letter within 7 working days after the end of the event unless you have made alternative arrangements with the permitting authority (§63.10(d)(5)(ii)).

[71 FR 42923, July 28, 2006]

[↑ Back to Top](#)

**Table 12 to Subpart EEEE of Part 63—Applicability of General Provisions to Subpart EEEE**

As stated in §§63.2382 and 63.2398, you must comply with the applicable General Provisions requirements as follows:

<b>Citation</b>	<b>Subject</b>	<b>Brief description</b>	<b>Applies to subpart EEEE</b>
§63.1	Applicability	Initial applicability determination; Applicability after standard established; Permit requirements; Extensions, Notifications	Yes.
§63.2	Definitions	Definitions for part 63 standards	Yes.
§63.3	Units and Abbreviations	Units and abbreviations for part 63 standards	Yes.
§63.4	Prohibited Activities and Circumvention	Prohibited activities; Circumvention, Severability	Yes.
§63.5	Construction/Reconstruction	Applicability; Applications;	Yes.

		Approvals	
§63.6(a)	Compliance with Standards/O&M Applicability	GP apply unless compliance extension; GP apply to area sources that become major	Yes.
§63.6(b)(1)-(4)	Compliance Dates for New and Reconstructed Sources	Standards apply at effective date; 3 years after effective date; upon startup; 10 years after construction or reconstruction commences for section 112(f)	Yes.
§63.6(b)(5)	Notification	Must notify if commenced construction or reconstruction after proposal	Yes.
§63.6(b)(6)	[Reserved].		
§63.6(b)(7)	Compliance Dates for New and Reconstructed Area Sources That Become Major	Area sources that become major must comply with major source standards immediately upon becoming major, regardless of whether required to comply when they were an area source	Yes.
§63.6(c)(1)-(2)	Compliance Dates for Existing Sources	Comply according to date in this subpart, which must be no later than 3 years after effective date; for section 112(f) standards, comply within 90 days of effective date unless compliance extension	Yes.
§63.6(c)(3)-(4)	[Reserved].		
§63.6(c)(5)	Compliance Dates for Existing Area Sources That Become Major	Area sources that become major must comply with major source standards by date indicated in this subpart or by equivalent time period ( <i>e.g.</i> , 3	Yes.

		years)	
§63.6(d)	[Reserved].		
§63.6(e)(1)	Operation & Maintenance	Operate to minimize emissions at all times; correct malfunctions as soon as practicable; and operation and maintenance requirements independently enforceable; information Administrator will use to determine if operation and maintenance requirements were met	Yes.
§63.6(e)(2)	[Reserved].		
§63.6(e)(3)	SSM Plan	Requirement for SSM plan; content of SSM plan; actions during SSM	Yes; however, (1) the 2-day reporting requirement in paragraph §63.6(e)(3)(iv) does not apply and (2) §63.6(e)(3) does not apply to emissions sources not requiring control.
§63.6(f)(1)	Compliance Except During SSM	You must comply with emission standards at all times except during SSM	Yes.
§63.6(f)(2)-(3)	Methods for Determining Compliance	Compliance based on performance test, operation and maintenance plans, records, inspection	Yes.
§63.6(g)(1)-(3)	Alternative Standard	Procedures for getting an alternative standard	Yes.
§63.6(h)	Opacity/Visible Emission Standards	Requirements for compliance with opacity and visible emission standards	No; except as it applies to flares for which Method 22 observations are required as part of a flare

			compliance assessment.
§63.6(i)(1)-(14)	Compliance Extension	Procedures and criteria for Administrator to grant compliance extension	Yes.
§63.6(j)	Presidential Compliance Exemption	President may exempt any source from requirement to comply with this subpart	Yes.
§63.7(a)(2)	Performance Test Dates	Dates for conducting initial performance testing; must conduct 180 days after compliance date	Yes.
§63.7(a)(3)	Section 114 Authority	Adminsitrator may require a performance test under CAA section 114 at any time	Yes.
§63.7(b)(1)	Notification of Performance Test	Must notify Administrator 60 days before the test	Yes.
§63.7(b)(2)	Notification of Rescheduling	If you have to reschedule performance test, must notify Administrator of rescheduled date as soon as practicable and without delay	Yes.
§63.7(c)	Quality Assurance (QA)/Test Plan	Requirement to submit site-specific test plan 60 days before the test or on date Administrator agrees with; test plan approval procedures; performance audit requirements; internal and external QA procedures for testing	Yes.
§63.7(d)	Testing Facilities	Requirements for testing facilities	Yes.

§63.7(e)(1)	Conditions for Conducting Performance Tests	Performance tests must be conducted under representative conditions; cannot conduct performance tests during SSM	Yes.
§63.7(e)(2)	Conditions for Conducting Performance Tests	Must conduct according to this subpart and EPA test methods unless Administrator approves alternative	Yes.
§63.7(e)(3)	Test Run Duration	Must have three test runs of at least 1 hour each; compliance is based on arithmetic mean of three runs; conditions when data from an additional test run can be used	Yes; however, for transfer racks per §§63.987(b)(3)(i)(A)-(B) and 63.997(e)(1)(v)(A)-(B) provide exceptions to the requirement for test runs to be at least 1 hour each.
§63.7(f)	Alternative Test Method	Procedures by which Administrator can grant approval to use an intermediate or major change, or alternative to a test method	Yes.
§63.7(g)	Performance Test Data Analysis	Must include raw data in performance test report; must submit performance test data 60 days after end of test with the Notification of Compliance Status; keep data for 5 years	Yes; however, performance test data is to be submitted with the Notification of Compliance Status according to the schedule specified in §63.9(h)(1)-(6) below.
§63.7(h)	Waiver of Tests	Procedures for Administrator to waive performance test	Yes.
§63.8(a)(1)	Applicability of Monitoring Requirements	Subject to all monitoring requirements in standard	Yes.
§63.8(a)(2)	Performance Specifications	Performance Specifications in appendix B of 40 CFR part 60	Yes.

		apply	
§63.8(a)(3)	[Reserved].		
§63.8(a)(4)	Monitoring of Flares	Monitoring requirements for flares in §63.11	Yes; however, monitoring requirements in §63.987(c) also apply.
§63.8(b)(1)	Monitoring	Must conduct monitoring according to standard unless Administrator approves alternative	Yes.
§63.8(b)(2)-(3)	Multiple Effluents and Multiple Monitoring Systems	Specific requirements for installing monitoring systems; must install on each affected source or after combined with another affected source before it is released to the atmosphere provided the monitoring is sufficient to demonstrate compliance with the standard; if more than one monitoring system on an emission point, must report all monitoring system results, unless one monitoring system is a backup	Yes.
§63.8(c)(1)	Monitoring System Operation and Maintenance	Maintain monitoring system in a manner consistent with good air pollution control practices	Yes.
§63.8(c)(1)(i)-(iii)	Routine and Predictable SSM	Keep parts for routine repairs readily available; reporting requirements for SSM when action is described in SSM plan.	Yes.
§63.8(c)(2)-(3)	Monitoring System Installation	Must install to get representative emission or parameter measurements; must verify operational status before	Yes.

		or at performance test	
§63.8(c)(4)	CMS Requirements	CMS must be operating except during breakdown, out-of-control, repair, maintenance, and high-level calibration drifts; COMS must have a minimum of one cycle of sampling and analysis for each successive 10-second period and one cycle of data recording for each successive 6-minute period; CEMS must have a minimum of one cycle of operation for each successive 15-minute period	Yes; however, COMS are not applicable.
§63.8(c)(5)	COMS Minimum Procedures	COMS minimum procedures	No.
§63.8(c)(6)-(8)	CMS Requirements	Zero and high level calibration check requirements. Out-of-control periods	Yes, but only applies for CEMS. 40 CFR part 63, subpart SS provides requirements for CPMS.
§63.8(d)	CMS Quality Control	Requirements for CMS quality control, including calibration, etc.; must keep quality control plan on record for 5 years; keep old versions for 5 years after revisions	Yes, but only applies for CEMS. 40 CFR part 63, subpart SS provides requirements for CPMS.
§63.8(e)	CMS Performance Evaluation	Notification, performance evaluation test plan, reports	Yes, but only applies for CEMS.
§63.8(f)(1)-(5)	Alternative Monitoring Method	Procedures for Administrator to approve alternative monitoring	Yes, but 40 CFR part 63, subpart SS also provides procedures for approval of CPMS.
§63.8(f)(6)	Alternative to Relative	Procedures for Administrator to approve alternative relative	Yes.



	Accuracy Test	accuracy tests for CEMS	
§63.8(g)	Data Reduction	COMS 6-minute averages calculated over at least 36 evenly spaced data points; CEMS 1 hour averages computed over at least 4 equally spaced data points; data that cannot be used in average	Yes; however, COMS are not applicable.
§63.9(a)	Notification Requirements	Applicability and State delegation	Yes.
§63.9(b)(1)-(2), (4)-(5)	Initial Notifications	Submit notification within 120 days after effective date; notification of intent to construct/reconstruct, notification of commencement of construction/reconstruction, notification of startup; contents of each	Yes.
§63.9(c)	Request for Compliance Extension	Can request if cannot comply by date or if installed best available control technology or lowest achievable emission rate (BACT/LAER)	Yes.
§63.9(d)	Notification of Special Compliance Requirements for New Sources	For sources that commence construction between proposal and promulgation and want to comply 3 years after effective date	Yes.
§63.9(e)	Notification of Performance Test	Notify Administrator 60 days prior	Yes.
§63.9(f)	Notification of VE/Opacity Test	Notify Administrator 30 days prior	No.
§63.9(g)	Additional Notifications	Notification of performance evaluation; notification about	Yes; however, there are

	When Using CMS	use of COMS data; notification that exceeded criterion for relative accuracy alternative	no opacity standards.
§63.9(h)(1)-(6)	Notification of Compliance Status	Contents due 60 days after end of performance test or other compliance demonstration, except for opacity/visible emissions, which are due 30 days after; when to submit to Federal vs. State authority	Yes; however, (1) there are no opacity standards and (2) all initial Notification of Compliance Status, including all performance test data, are to be submitted at the same time, either within 240 days after the compliance date or within 60 days after the last performance test demonstrating compliance has been completed, whichever occurs first.
§63.9(i)	Adjustment of Submittal Deadlines	Procedures for Administrator to approve change in when notifications must be submitted	Yes.
§63.9(j)	Change in Previous Information	Must submit within 15 days after the change	No. These changes will be reported in the first and subsequent compliance reports.
§63.10(a)	Recordkeeping/Reporting	Applies to all, unless compliance extension; when to submit to Federal vs. State authority; procedures for owners of more than one source	Yes.
§63.10(b)(1)	Recordkeeping/Reporting	General requirements; keep all records readily available; keep for 5 years	Yes.
§63.10(b)(2)(i)-(iv)	Records Related to Startup, Shutdown, and Malfunction	Occurrence of each for operations (process equipment);	Yes.

		occurrence of each malfunction of air pollution control equipment; maintenance on air pollution control equipment; actions during SSM	
§63.10(b)(2)(vi)-(xi)	CMS Records	Malfunctions, inoperative, out-of-control periods	Yes.
§63.10(b)(2)(xii)	Records	Records when under waiver	Yes.
§63.10(b)(2)(xiii)	Records	Records when using alternative to relative accuracy test	Yes.
§63.10(b)(2)(xiv)	Records	All documentation supporting initial notification and notification of compliance status	Yes.
§63.10(b)(3)	Records	Applicability determinations	Yes.
§63.10(c)	Records	Additional records for CMS	Yes.
§63.10(d)(1)	General Reporting Requirements	Requirement to report	Yes.
§63.10(d)(2)	Report of Performance Test Results	When to submit to Federal or State authority	Yes.
§63.10(d)(3)	Reporting Opacity or VE Observations	What to report and when	Yes.
§63.10(d)(4)	Progress Reports	Must submit progress reports on schedule if under compliance extension	Yes.
§63.10(d)(5)	SSM Reports	Contents and submission	Yes.
§63.10(e)(1)-(2)	Additional CMS Reports	Must report results for each CEMS on a unit; written copy of CMS performance	Yes; however, COMS are not applicable.

		evaluation; 2-3 copies of COMS performance evaluation	
§63.10(e)(3)(i)-(iii)	Reports	Schedule for reporting excess emissions and parameter monitor exceedance (now defined as deviations)	Yes; however, note that the title of the report is the compliance report; deviations include excess emissions and parameter exceedances.
§63.10(e)(3)(iv)-(v)	Excess Emissions Reports	Requirement to revert to quarterly submission if there is an excess emissions or parameter monitoring exceedance (now defined as deviations); provision to request semiannual reporting after compliance for 1 year; submit report by 30th day following end of quarter or calendar half; if there has not been an exceedance or excess emissions (now defined as deviations), report contents in a statement that there have been no deviations; must submit report containing all of the information in §§63.8(c)(7)-(8) and 63.10(c)(5)-(13)	Yes.
§63.10(e)(3)(vi)-(viii)	Excess Emissions Report and Summary Report	Requirements for reporting excess emissions for CMS (now called deviations); requires all of the information in §§63.10(c)(5)-(13) and 63.8(c)(7)-(8)	Yes.
§63.10(e)(4)	Reporting COMS Data	Must submit COMS data with performance test data	No.
§63.10(f)	Waiver for Recordkeeping/Reporting	Procedures for Administrator to waive	Yes.

§63.11(b)	Flares	Requirements for flares	Yes; §63.987 requirements apply, and the section references §63.11(b).
§63.11(c), (d), and (e)	Control and work practice requirements	Alternative work practice for equipment leaks	Yes.
§63.12	Delegation	State authority to enforce standards	Yes.
§63.13	Addresses	Addresses where reports, notifications, and requests are sent	Yes.
§63.14	Incorporation by Reference	Test methods incorporated by reference	Yes.
§63.15	Availability of Information	Public and confidential information	Yes.

[69 FR 5063, Feb. 3, 2004, as amended at 71 FR 20463, Apr. 20, 2006; 71 FR 42924, July 28, 2006; 73 FR 78215, Dec. 22, 2008]

[↑ Back to Top](#)

# **APPENDIX J**

## Electronic Code of Federal Regulations

---

[View past updates to the e-CFR.](#)

[Click here to learn more.](#)

---

**e-CFR data is current as of January 17, 2017**

[Title 40](#) → [Chapter I](#) → [Subchapter C](#) → [Part 63](#) → [Subpart FFFF](#)

---

[Browse Previous](#) | [Browse Next](#)

Title 40: Protection of Environment

[PART 63—NATIONAL EMISSION STANDARDS FOR HAZARDOUS AIR POLLUTANTS FOR SOURCE CATEGORIES \(CONTINUED\)](#)

---

### **Subpart FFFF—National Emission Standards for Hazardous Air Pollutants: Miscellaneous Organic Chemical Manufacturing**

---

#### **Contents**

##### [What This Subpart Covers](#)

- [§63.2430](#) What is the purpose of this subpart?
- [§63.2435](#) Am I subject to the requirements in this subpart?
- [§63.2440](#) What parts of my plant does this subpart cover?

##### [Compliance Dates](#)

- [§63.2445](#) When do I have to comply with this subpart?

##### [Emission Limits, Work Practice Standards, and Compliance Requirements](#)

- [§63.2450](#) What are my general requirements for complying with this subpart?
- [§63.2455](#) What requirements must I meet for continuous process vents?
- [§63.2460](#) What requirements must I meet for batch process vents?
- [§63.2465](#) What requirements must I meet for process vents that emit hydrogen halide and halogen HAP or HAP metals?
- [§63.2470](#) What requirements must I meet for storage tanks?
- [§63.2475](#) What requirements must I meet for transfer racks?
- [§63.2480](#) What requirements must I meet for equipment leaks?
- [§63.2485](#) What requirements must I meet for wastewater streams and liquid streams in open systems

within an MCPU?

§63.2490 What requirements must I meet for heat exchange systems?

#### Alternative Means of Compliance

§63.2495 How do I comply with the pollution prevention standard?

§63.2500 How do I comply with emissions averaging?

§63.2505 How do I comply with the alternative standard?

#### Notification, Reports, and Records

§63.2515 What notifications must I submit and when?

§63.2520 What reports must I submit and when?

§63.2525 What records must I keep?

#### Other Requirements and Information

§63.2535 What compliance options do I have if part of my plant is subject to both this subpart and another subpart?

§63.2540 What parts of the General Provisions apply to me?

§63.2545 Who implements and enforces this subpart?

§63.2550 What definitions apply to this subpart?

Table 1 to Subpart FFFF of Part 63—Emission Limits and Work Practice Standards for Continuous Process Vents

Table 2 to Subpart FFFF of Part 63—Emission Limits and Work Practice Standards for Batch Process Vents

Table 3 to Subpart FFFF of Part 63—Emission Limits for Hydrogen Halide and Halogen HAP Emissions or HAP Metals Emissions From Process Vents

Table 4 to Subpart FFFF of Part 63—Emission Limits for Storage Tanks

Table 5 to Subpart FFFF of Part 63—Emission Limits and Work Practice Standards for Transfer Racks

Table 6 to Subpart FFFF of Part 63—Requirements for Equipment Leaks

Table 7 to Subpart FFFF of Part 63—Requirements for Wastewater Streams and Liquid Streams in Open Systems Within an MCPU

Table 8 to Subpart FFFF of Part 63—Partially Soluble Hazardous Air Pollutants

Table 9 to Subpart FFFF of Part 63—Soluble Hazardous Air Pollutants

Table 10 to Subpart FFFF of Part 63—Work Practice Standards for Heat Exchange Systems

Table 11 to Subpart FFFF of Part 63—Requirements for Reports

Table 12 to Subpart FFFF of Part 63—Applicability of General Provisions to Subpart FFFF

---

Source: 68 FR 63888, Nov. 10, 2003, unless otherwise noted.

[↑ Back to Top](#)

#### **What This Subpart Covers**



[↑ Back to Top](#)

### **§63.2430 What is the purpose of this subpart?**

This subpart establishes national emission standards for hazardous air pollutants (NESHAP) for miscellaneous organic chemical manufacturing. This subpart also establishes requirements to demonstrate initial and continuous compliance with the emission limits, operating limits, and work practice standards.

[↑ Back to Top](#)

### **§63.2435 Am I subject to the requirements in this subpart?**

(a) You are subject to the requirements in this subpart if you own or operate miscellaneous organic chemical manufacturing process units (MCPU) that are located at, or are part of, a major source of hazardous air pollutants (HAP) emissions as defined in section 112(a) of the Clean Air Act (CAA).

(b) An MCPU includes equipment necessary to operate a miscellaneous organic chemical manufacturing process, as defined in §63.2550, that satisfies all of the conditions specified in paragraphs (b)(1) through (3) of this section. An MCPU also includes any assigned storage tanks and transfer racks; equipment in open systems that is used to convey or store water having the same concentration and flow characteristics as wastewater; and components such as pumps, compressors, agitators, pressure relief devices, sampling connection systems, open-ended valves or lines, valves, connectors, and instrumentation systems that are used to manufacture any material or family of materials described in paragraphs (b)(1)(i) through (v) of this section.

(1) The MCPU produces material or family of materials that is described in paragraph (b)(1)(i), (ii), (iii), (iv), or (v) of this section.

(i) An organic chemical(s) classified using the 1987 version of SIC code 282, 283, 284, 285, 286, 287, 289, or 386, except as provided in paragraph (c)(5) of this section.

(ii) An organic chemical(s) classified using the 1997 version of NAICS code 325, except as provided in paragraph (c)(5) of this section.

(iii) Quaternary ammonium compounds and ammonium sulfate produced with caprolactam.

(iv) Hydrazine.

(v) Organic solvents classified in any of the SIC or NAICS codes listed in paragraph (b)(1)(i) or (ii) of this section that are recovered using nondedicated solvent recovery operations.

(2) The MCPU processes, uses, or generates any of the organic HAP listed in section 112(b) of the CAA or hydrogen halide and halogen HAP, as defined in §63.2550.

(3) The MCPU is not an affected source or part of an affected source under another subpart of this part 63, except for process vents from batch operations within a chemical manufacturing process unit (CMPU), as identified in §63.100(j)(4). For this situation, the MCPU is the same as the CMPU as defined in §63.100, and you are subject only to the requirements for batch process vents in this subpart.

(c) The requirements in this subpart do not apply to the operations specified in paragraphs (c)(1) through (7) of this section.

(1) Research and development facilities, as defined in section 112(c)(7) of the CAA.

(2) The manufacture of ammonium sulfate as a by-product, if the slurry entering the by-product manufacturing process contains 50 parts per million by weight (ppmw) HAP or less or 10 ppmw benzene or less. You must retain information, data, and analysis to document the HAP concentration in the entering slurry in order to claim this exemption.

(3) The affiliated operations located at an affected source under subparts GG (National Emission Standards for Aerospace Manufacturing and Rework Facilities), KK (National Emission Standards for the Printing and Publishing Industry), JJJJ (NESHAP: Paper and Other Web Coating), future MMMM (NESHAP: Surface Coating of Miscellaneous Metal Parts and Products), and SSSS (NESHAP: Surface Coating of Metal Coil) of this part 63. Affiliated operations include, but are not limited to, mixing or dissolving of coating ingredients; coating mixing for viscosity adjustment, color tint or additive blending, or pH adjustment; cleaning of coating lines and coating line parts; handling and storage of coatings and solvent; and conveyance and treatment of wastewater.

(4) Fabricating operations (such as spinning or compressing a solid polymer into its end use); compounding operations (in which blending, melting, and resolidification of a solid polymer product occur for the purpose of incorporating additives, colorants, or stabilizers); and extrusion and drawing operations (converting an already produced solid polymer into a different shape by melting or mixing the polymer and then forcing it or pulling it through an orifice to create an extruded product). An operation is not exempt if it involves processing with HAP solvent or if an intended purpose of the operation is to remove residual HAP monomer.

(5) Production activities described using the 1997 version of NAICS codes 325131, 325181, 325188 (except the requirements do apply to hydrazine), 325314, 325991 (except the requirements do apply to reformulating plastics resins from recycled plastics products), and 325992 (except the requirements do apply to photographic chemicals).

(6) Tall oil recovery systems.

(7) Carbon monoxide production.

(d) If the predominant use of a transfer rack loading arm or storage tank (including storage tanks in series) is associated with a miscellaneous organic chemical manufacturing process, and the loading arm or storage tank is not part of an affected source under a subpart of this part 63, then you must assign the loading arm or storage tank to the MCPU for that miscellaneous organic chemical manufacturing process. If the predominant use cannot be determined, then you may assign the loading arm or storage tank to any MCPU that shares it and is subject to this subpart. If the use varies from year to year, then you must base the determination on the utilization that occurred during the year preceding November 10, 2003 or, if the loading arm or storage tank was not in operation during that year, you must base the use on the expected use for the first 5-year period after startup. You must include the determination in the notification of compliance status report specified in §63.2520(d). You must redetermine the primary use at least once

every 5 years, or any time you implement emissions averaging or pollution prevention after the compliance date.

(e) For nondedicated equipment used to create at least one MCPU, you may elect to develop process unit groups (PUG), determine the primary product of each PUG, and comply with the requirements of the subpart in 40 CFR part 63 that applies to that primary product as specified in §63.2535(1).

[68 FR 63888, Nov. 10, 2003, as amended at 71 FR 40331, July 14, 2006]

[↑ Back to Top](#)

### **§63.2440 What parts of my plant does this subpart cover?**

(a) This subpart applies to each miscellaneous organic chemical manufacturing affected source.

(b) The miscellaneous organic chemical manufacturing affected source is the facilitywide collection of MCPU and heat exchange systems, wastewater, and waste management units that are associated with manufacturing materials described in §63.2435(b)(1).

(c) A new affected source is described by either paragraph (c)(1) or (2) of this section.

(1) Each affected source defined in paragraph (b) of this section for which you commenced construction or reconstruction after April 4, 2002, and you meet the applicability criteria at the time you commenced construction or reconstruction.

(2) Each dedicated MCPU that has the potential to emit 10 tons per year (tpy) of any one HAP or 25 tpy of combined HAP, and you commenced construction or reconstruction of the MCPU after April 4, 2002. For the purposes of this paragraph, an MCPU is an affected source in the definition of the term “reconstruction” in §63.2.

(d) An MCPU that is also a CMPU under §63.100 is reconstructed for the purposes of this subpart if, and only if, the CMPU meets the requirements for reconstruction in §63.100(1)(2).

[↑ Back to Top](#)

### **Compliance Dates**

[↑ Back to Top](#)

### **§63.2445 When do I have to comply with this subpart?**

(a) If you have a new affected source, you must comply with this subpart according to the requirements in paragraphs (a)(1) and (2) of this section.

(1) If you startup your new affected source before November 10, 2003, then you must comply with the requirements for new sources in this subpart no later than November 10, 2003.

(2) If you startup your new affected source after November 10, 2003, then you must comply with the requirements for new sources in this subpart upon startup of your affected source.

(b) If you have an existing source on November 10, 2003, you must comply with the requirements for existing sources in this subpart no later than May 10, 2008.

(c) You must meet the notification requirements in §63.2515 according to the dates specified in that section and in subpart A of this part 63. Some of the notifications must be submitted before you are required to comply with the emission limits, operating limits, and work practice standards in this subpart.

(d) If you have a Group 2 emission point that becomes a Group 1 emission point after the compliance date for your affected source, you must comply with the Group 1 requirements beginning on the date the switch occurs. An initial compliance demonstration as specified in this subpart must be conducted within 150 days after the switch occurs.

(e) If, after the compliance date for your affected source, hydrogen halide and halogen HAP emissions from process vents in a process increase to more than 1,000 lb/yr, or HAP metals emissions from a process at a new affected source increase to more than 150 lb/yr, you must comply with the applicable emission limits specified in Table 3 to this subpart and the associated compliance requirements beginning on the date the emissions exceed the applicable threshold. An initial compliance demonstration as specified in this subpart must be conducted within 150 days after the switch occurs.

(f) If you have a small control device for process vent or transfer rack emissions that becomes a large control device, as defined in §63.2550(i), you must comply with monitoring and associated recordkeeping and reporting requirements for large control devices beginning on the date the switch occurs. An initial compliance demonstration as specified in this subpart must be conducted within 150 days after the switch occurs.

[68 FR 63888, Nov. 10, 2003, as amended at 71 FR 10442, Mar. 1, 2006; 71 FR 40332, July 14, 2006]

[↑ Back to Top](#)

## **Emission Limits, Work Practice Standards, and Compliance Requirements**

[↑ Back to Top](#)

### **§63.2450 What are my general requirements for complying with this subpart?**

(a) You must be in compliance with the emission limits and work practice standards in tables 1 through 7 to this subpart at all times, except during periods of startup, shutdown, and malfunction (SSM), and you must meet the requirements specified in §§63.2455 through 63.2490 (or the alternative means of compliance in §63.2495, §63.2500, or §63.2505), except as specified in paragraphs (b) through (s) of this section. You must meet the notification, reporting, and recordkeeping requirements specified in §§63.2515, 63.2520, and 63.2525.

(b) *Determine halogenated vent streams.* You must determine if an emission stream is a halogenated vent stream, as defined in §63.2550, by calculating the mass emission rate of halogen atoms in accordance with §63.115(d)(2)(v). Alternatively, you may elect to designate the emission stream as halogenated.

(c) *Requirements for combined emission streams.* When organic HAP emissions from different emission types (e.g., continuous process vents, batch process vents, storage tanks, transfer operations, and waste

management units) are combined, you must comply with the requirements of either paragraph (c)(1) or (2) of this section.

(1) Comply with the applicable requirements of this subpart for each kind of organic HAP emissions in the stream (*e.g.*, the requirements of table 1 to this subpart for continuous process vents and the requirements of table 4 to this subpart for emissions from storage tanks).

(2) Determine the applicable requirements based on the hierarchy presented in paragraphs (c)(2)(i) through (vi) of this section. For a combined stream, the applicable requirements are specified in the highest-listed paragraph in the hierarchy that applies to any of the individual streams that make up the combined stream. For example, if a combined stream consists of emissions from Group 1 batch process vents and any other type of emission stream, then you must comply with the requirements in paragraph (c)(2)(i) of this section for the combined stream; compliance with the requirements in paragraph (c)(2)(i) of this section constitutes compliance for the other emission streams in the combined stream. Two exceptions are that you must comply with the requirements in table 3 to this subpart and §63.2465 for all process vents with hydrogen halide and halogen HAP emissions, and recordkeeping requirements for Group 2 applicability or compliance are still required (*e.g.*, the requirement in §63.2525(f) to track the number of batches produced and calculate rolling annual emissions for processes with Group 2 batch process vents).

(i) The requirements of table 2 to this subpart and §63.2460 for Group 1 batch process vents, including applicable monitoring, recordkeeping, and reporting.

(ii) The requirements of table 1 to this subpart and §63.2455 for continuous process vents that are routed to a control device, as defined in §63.981, including applicable monitoring, recordkeeping, and reporting.

(iii) The requirements of table 5 to this subpart and §63.2475 for transfer operations, including applicable monitoring, recordkeeping, and reporting.

(iv) The requirements of table 7 to this subpart and §63.2485 for emissions from waste management units that are used to manage and treat Group 1 wastewater streams and residuals from Group 1 wastewater streams, including applicable monitoring, recordkeeping, and reporting.

(v) The requirements of table 4 to this subpart and §63.2470 for control of emissions from storage tanks, including applicable monitoring, recordkeeping, and reporting.

(vi) The requirements of table 1 to this subpart and §63.2455 for continuous process vents after a recovery device including applicable monitoring, recordkeeping, and reporting.

(d) [Reserved]

(e) *Requirements for control devices.* (1) Except when complying with §63.2485, if you reduce organic HAP emissions by venting emissions through a closed-vent system to any combination of control devices (except a flare) or recovery devices, you must meet the requirements of §63.982(c) and the requirements referenced therein.

(2) Except when complying with §63.2485, if you reduce organic HAP emissions by venting emissions through a closed-vent system to a flare, you must meet the requirements of §63.982(b) and the requirements referenced therein.

(3) If you use a halogen reduction device to reduce hydrogen halide and halogen HAP emissions from halogenated vent streams, you must meet the requirements of §63.994 and the requirements referenced therein. If you use a halogen reduction device before a combustion device, you must determine the halogen atom emission rate prior to the combustion device according to the procedures in §63.115(d)(2)(v).

(f) *Requirements for flare compliance assessments.* (1) As part of a flare compliance assessment required in §63.987(b), you have the option of demonstrating compliance with the requirements of §63.11(b) by complying with the requirements in either §63.11(b)(6)(i) or §63.987(b)(3)(ii).

(2) If you elect to meet the requirements in §63.11(b)(6)(i), you must keep flare compliance assessment records as specified in paragraphs (f)(2)(i) and (ii) of this section.

(i) Keep records as specified in §63.998(a)(1)(i), except that a record of the heat content determination is not required.

(ii) Keep records of the flare diameter, hydrogen content, exit velocity, and maximum permitted velocity. Include these records in the flare compliance report required in §63.999(a)(2).

(g) *Requirements for performance tests.* The requirements specified in paragraphs (g)(1) through (5) of this section apply instead of or in addition to the requirements specified in subpart SS of this part 63.

(1) Conduct gas molecular weight analysis using Method 3, 3A, or 3B in appendix A to part 60 of this chapter.

(2) Measure moisture content of the stack gas using Method 4 in appendix A to part 60 of this chapter.

(3) If the uncontrolled or inlet gas stream to the control device contains carbon disulfide, you must conduct emissions testing according to paragraph (g)(3)(i) or (ii) of this section.

(i) If you elect to comply with the percent reduction emission limits in tables 1 through 7 to this subpart, and carbon disulfide is the principal organic HAP component (*i.e.*, greater than 50 percent of the HAP in the stream by volume), then you must use Method 18, or Method 15 (40 CFR part 60, appendix A) to measure carbon disulfide at the inlet and outlet of the control device. Use the percent reduction in carbon disulfide as a surrogate for the percent reduction in total organic HAP emissions.

(ii) If you elect to comply with the outlet total organic compound (TOC) concentration emission limits in tables 1 through 7 to this subpart, and the uncontrolled or inlet gas stream to the control device contains greater than 10 percent (volume concentration) carbon disulfide, you must use Method 18 or Method 15 to separately determine the carbon disulfide concentration. Calculate the total HAP or TOC emissions by totaling the carbon disulfide emissions measured using Method 18 or 15 and the other HAP emissions measured using Method 18 or 25A.

(4) As an alternative to using Method 18, Method 25/25A, or Method 26/26A of 40 CFR part 60, appendix A, to comply with any of the emission limits specified in tables 1 through 7 to this subpart, you may use Method 320 of 40 CFR part 60, appendix A. When using Method 320, you must follow the analyte spiking procedures of section 13 of Method 320, unless you demonstrate that the complete spiking procedure has been conducted at a similar source.

(5) Section 63.997(c)(1) does not apply. For the purposes of this subpart, results of all initial compliance demonstrations must be included in the notification of compliance status report, which is due 150 days after the compliance date, as specified in §63.2520(d)(1).

(h) *Design evaluation.* To determine the percent reduction of a small control device that is used to comply with an emission limit specified in table 1, 2, 3, or 5 to this subpart, you may elect to conduct a design evaluation as specified in §63.1257(a)(1) instead of a performance test as specified in subpart SS of this part 63. You must establish the value(s) and basis for the operating limits as part of the design evaluation. For continuous process vents, the design evaluation must be conducted at maximum representative operating conditions for the process, unless the Administrator specifies or approves alternate operating conditions. For transfer racks, the design evaluation must demonstrate that the control device achieves the required control efficiency during the reasonably expected maximum transfer loading rate.

(i) *Outlet concentration correction for combustion devices.* When §63.997(e)(2)(iii)(C) requires you to correct the measured concentration at the outlet of a combustion device to 3 percent oxygen if you add supplemental combustion air, the requirements in either paragraph (i)(1) or (2) of this section apply for the purposes of this subpart.

(1) You must correct the concentration in the gas stream at the outlet of the combustion device to 3 percent oxygen if you add supplemental gases, as defined in §63.2550, to the vent stream, or;

(2) You must correct the measured concentration for supplemental gases using Equation 1 of §63.2460; you may use process knowledge and representative operating data to determine the fraction of the total flow due to supplemental gas.

(j) *Continuous emissions monitoring systems.* Each continuous emissions monitoring system (CEMS) must be installed, operated, and maintained according to the requirements in §63.8 and paragraphs (j)(1) through (5) of this section.

(1) Each CEMS must be installed, operated, and maintained according to the applicable Performance Specification of 40 CFR part 60, appendix B, and according to paragraph (j)(2) of this section, except as specified in paragraph (j)(1)(i) of this section. For any CEMS meeting Performance Specification 8, you must also comply with appendix F, procedure 1 of 40 CFR part 60.

(i) If you wish to use a CEMS other than an Fourier Transform Infrared Spectroscopy (FTIR) meeting the requirements of Performance Specification 15 to measure hydrogen halide and halogen HAP before we promulgate a Performance Specification for such CEMS, you must prepare a monitoring plan and submit it for approval in accordance with the procedures specified in §63.8.

(ii) [Reserved]

(2) You must determine the calibration gases and reporting units for TOC CEMS in accordance with paragraph (j)(2)(i), (ii), or (iii) of this section.

(i) For CEMS meeting Performance Specification 9 or 15 requirements, determine the target analyte(s) for calibration using either process knowledge of the control device inlet stream or the screening procedures of Method 18 on the control device inlet stream.

(ii) For CEMS meeting Performance Specification 8 used to monitor performance of a combustion device, calibrate the instrument on the predominant organic HAP and report the results as carbon (C<sub>1</sub>), and use Method 25A or any approved alternative as the reference method for the relative accuracy tests.

(iii) For CEMS meeting Performance Specification 8 used to monitor performance of a noncombustion device, determine the predominant organic HAP using either process knowledge or the screening procedures of Method 18 on the control device inlet stream, calibrate the monitor on the predominant organic HAP, and report the results as C<sub>1</sub>. Use Method 18, ASTM D6420-99, or any approved alternative as the reference method for the relative accuracy tests, and report the results as C<sub>1</sub>.

(3) You must conduct a performance evaluation of each CEMS according to the requirements in 40 CFR 63.8 and according to the applicable Performance Specification of 40 CFR part 60, appendix B, except that the schedule in §63.8(e)(4) does not apply, and the results of the performance evaluation must be included in the notification of compliance status report.

(4) The CEMS data must be reduced to operating day or operating block averages computed using valid data consistent with the data availability requirements specified in §63.999(c)(6)(i)(B) through (D), except monitoring data also are sufficient to constitute a valid hour of data if measured values are available for at least two of the 15-minute periods during an hour when calibration, quality assurance, or maintenance activities are being performed. An operating block is a period of time from the beginning to end of batch operations within a process. Operating block averages may be used only for batch process vent data.

(5) If you add supplemental gases, you must correct the measured concentrations in accordance with paragraph (i) of this section and §63.2460(c)(6).

(k) *Continuous parameter monitoring.* The provisions in paragraphs (k)(1) through (6) of this section apply in addition to the requirements for continuous parameter monitoring system (CPMS) in subpart SS of this part 63.

(1) You must record the results of each calibration check and all maintenance performed on the CPMS as specified in §63.998(c)(1)(ii)(A).

(2) When subpart SS of this part 63 uses the term “a range” or “operating range” of a monitored parameter, it means an “operating limit” for a monitored parameter for the purposes of this subpart.

(3) As an alternative to continuously measuring and recording pH as specified in §§63.994(c)(1)(i) and 63.998(a)(2)(ii)(D), you may elect to continuously monitor and record the caustic strength of the effluent. For halogen scrubbers used to control only batch process vents you may elect to monitor and record either the pH or the caustic strength of the scrubber effluent at least once per day.



(4) As an alternative to the inlet and outlet temperature monitoring requirements for catalytic incinerators as specified in §63.988(c)(2) and the related recordkeeping requirements specified in §63.998(a)(2)(ii)(B)(2) and (c)(2)(ii), you may elect to comply with the requirements specified in paragraphs (k)(4)(i) through (iv) of this section.

(i) Monitor and record the inlet temperature as specified in subpart SS of this part 63.

(ii) Check the activity level of the catalyst at least every 12 months and take any necessary corrective action, such as replacing the catalyst to ensure that the catalyst is performing as designed.

(iii) Maintain records of the annual checks of catalyst activity levels and the subsequent corrective actions.

(iv) Recording the downstream temperature and temperature difference across the catalyst bed as specified in §63.998(a)(2)(ii)(B)(2) and (b)(2)(ii) is not required.

(5) For absorbers that control organic compounds and use water as the scrubbing fluid, you must conduct monitoring and recordkeeping as specified in paragraphs (k)(5)(i) through (iii) of this section instead of the monitoring and recordkeeping requirements specified in §§63.990(c)(1), 63.993(c)(1), and 63.998(a)(2)(ii)(C).

(i) You must use a flow meter capable of providing a continuous record of the absorber influent liquid flow.

(ii) You must determine gas stream flow using one of the procedures specified in §63.994(c)(1)(ii)(A) through (D).

(iii) You must record the absorber liquid-to-gas ratio averaged over the time period of any performance test.

(6) For a control device with total inlet HAP emissions less than 1 tpy, you must establish an operating limit(s) for a parameter(s) that you will measure and record at least once per averaging period (i.e., daily or block) to verify that the control device is operating properly. You may elect to measure the same parameter(s) that is required for control devices that control inlet HAP emissions equal to or greater than 1 tpy. If the parameter will not be measured continuously, you must request approval of your proposed procedure in the precompliance report. You must identify the operating limit(s) and the measurement frequency, and you must provide rationale to support how these measurements demonstrate the control device is operating properly.

(l) *Startup, shutdown, and malfunction.* Sections 63.152(f)(7)(ii) through (iv) and 63.998(b)(2)(iii) and (b)(6)(i)(A), which apply to the exclusion of monitoring data collected during periods of SSM from daily averages, do not apply for the purposes of this subpart.

(m) *Reporting.* (1) When §§63.2455 through 63.2490 reference other subparts in this part 63 that use the term “periodic report,” it means “compliance report” for the purposes of this subpart. The compliance report must include the information specified in §63.2520(e), as well as the information specified in referenced subparts.

(2) When there are conflicts between this subpart and referenced subparts for the due dates of reports required by this subpart, reports must be submitted according to the due dates presented in this subpart.

(3) Excused excursions, as defined in subparts G and SS of this part 63, are not allowed.

(n) [Reserved]

(o) You may not use a flare to control halogenated vent streams or hydrogen halide and halogen HAP emissions.

(p) Opening a safety device, as defined in §63.2550, is allowed at any time conditions require it to avoid unsafe conditions.

(q) If an emission stream contains energetics or organic peroxides that, for safety reasons, cannot meet an applicable emission limit specified in Tables 1 through 7 to this subpart, then you must submit documentation in your precompliance report explaining why an undue safety hazard would be created if the air emission controls were installed, and you must describe the procedures that you will implement to minimize HAP emissions from these vent streams.

(r) *Surge control vessels and bottoms receivers.* For each surge control vessel or bottoms receiver that meets the capacity and vapor pressure thresholds for a Group 1 storage tank, you must meet emission limits and work practice standards specified in Table 4 to this subpart.

(s) For the purposes of determining Group status for continuous process vents, batch process vents, and storage tanks in §§63.2455, 63.2460, and 63.2470, hydrazine is to be considered an organic HAP.

[68 FR 63888, Nov. 10, 2003, as amended at 70 FR 38559, July 1, 2005; 71 FR 40332, July 14, 2006]

[↑ Back to Top](#)

### **§63.2455 What requirements must I meet for continuous process vents?**

(a) You must meet each emission limit in Table 1 to this subpart that applies to your continuous process vents, and you must meet each applicable requirement specified in paragraphs (b) through (c) of this section.

(b) For each continuous process vent, you must either designate the vent as a Group 1 continuous process vent or determine the total resource effectiveness (TRE) index value as specified in §63.115(d), except as specified in paragraphs (b)(1) through (3) of this section.

(1) You are not required to determine the Group status or the TRE index value for any continuous process vent that is combined with Group 1 batch process vents before a control device or recovery device because the requirements of §63.2450(c)(2)(i) apply to the combined stream.

(2) When a TRE index value of 4.0 is referred to in §63.115(d), TRE index values of 5.0 for existing affected sources and 8.0 for new and reconstructed affected sources apply for the purposes of this subpart.

(3) When §63.115(d) refers to “emission reductions specified in §63.113(a),” the reductions specified in Table 1 to this subpart apply for the purposes of this subpart.

(c) If you use a recovery device to maintain the TRE above a specified threshold, you must meet the requirements of §63.982(e) and the requirements referenced therein, except as specified in §63.2450 and paragraph (c)(1) of this section.

(1) When §63.993 uses the phrase “the TRE index value is between the level specified in a referencing subpart and 4.0,” the phrase “the TRE index value is  $>1.9$  but  $\leq 5.0$ ” applies for an existing affected source, and the phrase “the TRE index value is  $>5.0$  but  $\leq 8.0$ ” applies for a new and reconstructed affected source, for the purposes of this subpart.

(2) [Reserved]

[↑ Back to Top](#)

### **§63.2460 What requirements must I meet for batch process vents?**

(a) You must meet each emission limit in Table 2 to this subpart that applies to you, and you must meet each applicable requirement specified in paragraphs (b) and (c) of this section.

(b) *Group status.* If a process has batch process vents, as defined in §63.2550, you must determine the group status of the batch process vents by determining and summing the uncontrolled organic HAP emissions from each of the batch process vents within the process using the procedures specified in §63.1257(d)(2)(i) and (ii), except as specified in paragraphs (b)(1) through (7) of this section.

(1) To calculate emissions caused by the heating of a vessel without a process condenser to a temperature lower than the boiling point, you must use the procedures in §63.1257(d)(2)(i)(C)(3).

(2) To calculate emissions from depressurization of a vessel without a process condenser, you must use the procedures in §63.1257(d)(2)(i)(D)(10).

(3) To calculate emissions from vacuum systems for the purposes of this subpart, the receiving vessel is part of the vacuum system, and terms used in Equation 33 to 40 CFR part 63, subpart GGG, are defined as follows:

$P_{\text{system}}$  = absolute pressure of the receiving vessel;

$P_i$  = partial pressure of the HAP determined at the exit temperature and exit pressure conditions of the condenser or at the conditions of the dedicated receiver;

$P_j$  = partial pressure of condensables (including HAP) determined at the exit temperature and exit pressure conditions of the condenser or at the conditions of the dedicated receiver;

$MW_{\text{HAP}}$  = molecular weight of the HAP determined at the exit temperature and exit pressure conditions of the condenser or at the conditions of the dedicated receiver.

(4) To calculate uncontrolled emissions when a vessel is equipped with a process condenser, you must use the procedures in §63.1257(d)(3)(i)(B), except as specified in paragraphs (b)(4)(i) through (vii) of this section.

(i) You must determine the flowrate of gas (or volume of gas), partial pressures of condensables, temperature (T), and HAP molecular weight ( $MW_{\text{HAP}}$ ) at the exit temperature and exit pressure conditions of the condenser or at the conditions of the dedicated receiver.

(ii) You must assume that all of the components contained in the condenser exit vent stream are in equilibrium with the same components in the exit condensate stream (except for noncondensables).

(iii) You must perform a material balance for each component.

(iv) For the emissions from gas evolution, the term for time, t, must be used in Equation 12 to 40 CFR part 63, subpart GGG.

(v) Emissions from empty vessel purging shall be calculated using Equation 36 to 40 CFR part 63, subpart GGG and the exit temperature and exit pressure conditions of the condenser or the conditions of the dedicated receiver.

(vi) You must conduct an engineering assessment as specified in §63.1257(d)(2)(ii) for each emission episode that is not due to vapor displacement, purging, heating, depressurization, vacuum operations, gas evolution, air drying, or empty vessel purging. The requirements of paragraphs (b)(3) through (4) of this section shall apply.

(vii) You may elect to conduct an engineering assessment if you can demonstrate to the Administrator that the methods in §63.1257(d)(3)(i)(B) are not appropriate.

(5) You may elect to designate the batch process vents within a process as Group 1 and not calculate uncontrolled emissions under either of the situations in paragraph (b)(5)(i), (ii), or (iii) of this section.

(i) If you comply with the alternative standard specified in §63.2505.

(ii) If all Group 1 batch process vents within a process are controlled; you conduct the performance test under hypothetical worst case conditions, as defined in §63.1257(b)(8)(i)(B); and the emission profile is based on capture and control system limitations as specified in §63.1257(b)(8)(ii)(C).

(iii) If you comply with an emission limit using a flare that meets the requirements specified in §63.987.

(6) You may change from Group 2 to Group 1 in accordance with either paragraph (b)(6)(i) or (ii) of this section. You must comply with the requirements of this section and submit the test report in the next Compliance report.

(i) You may switch at any time after operating as Group 2 for at least 1 year so that you can show compliance with the 10,000 pounds per year (lb/yr) threshold for Group 2 batch process vents for at least 365 days before the switch. You may elect to start keeping records of emissions from Group 2 batch process vents before the compliance date. Report a switch based on this provision in your next compliance report in accordance with §63.2520(e)(10)(i).

(ii) If the conditions in paragraph (b)(6)(i) of this section are not applicable, you must provide a 60-day advance notice in accordance with §63.2520(e)(10)(ii) before switching.

(7) As an alternative to determining the uncontrolled organic HAP emissions as specified in §63.1257(d)(2)(i) and (ii), you may elect to demonstrate that non-reactive organic HAP are the only HAP used in the process and non-reactive HAP usage in the process is less than 10,000 lb/yr. You must provide data and supporting rationale in your notification of compliance status report explaining why the non-reactive organic HAP usage will be less than 10,000 lb/yr. You must keep records of the non-reactive organic HAP usage as specified in §63.2525(e)(2) and include information in compliance reports as specified in §63.2520(e)(5)(iv).

(c) Exceptions to the requirements in subparts SS and WW of this part 63 are specified in paragraphs (c)(1) through (9) of this section.

(1) *Process condensers.* Process condensers, as defined in §63.2550(i), are not considered to be control devices for batch process vents. You must determine whether a condenser is a control device for a batch process vent or a process condenser from which the uncontrolled HAP emissions are evaluated as part of the initial compliance demonstration for each MCPU and report the results with supporting rationale in your notification of compliance status report.

(2) *Initial compliance.* (i) To demonstrate initial compliance with a percent reduction emission limit in Table 2 to this subpart FFFF, you must compare the sums of the controlled and uncontrolled emissions for the applicable Group 1 batch process vents within the process, and show that the specified reduction is met. This requirement does not apply if you comply with the emission limits of Table 2 to this subpart FFFF by using a flare that meets the requirements of §63.987.

(ii) When you conduct a performance test or design evaluation for a non-flare control device used to control emissions from batch process vents, you must establish emission profiles and conduct the test under worst-case conditions according to §63.1257(b)(8) instead of under normal operating conditions as specified in §63.7(e)(1). The requirements in §63.997(e)(1)(i) and (iii) also do not apply for performance tests conducted to determine compliance with the emission limits for batch process vents. For purposes of this subpart FFFF, references in §63.997(b)(1) to “methods specified in §63.997(e)” include the methods specified in §63.1257(b)(8).

(iii) As an alternative to conducting a performance test or design evaluation to demonstrate initial compliance with a percent reduction requirement for a condenser, you may determine controlled emissions using the procedures specified in §63.1257(d)(3)(i)(B) and paragraphs (b)(3) through (4) of this section.

(iv) When §63.1257(d)(3)(i)(B)(7) specifies that condenser-controlled emissions from an air dryer must be calculated using Equation 11 of 40 CFR part 63, subpart GGG, with “V equal to the air flow rate,” it means “V equal to the dryer outlet gas flow rate,” for the purposes of this subpart. Alternatively, you may use Equation 12 of 40 CFR part 63, subpart GGG, with V equal to the dryer inlet air flow rate. Account for time as appropriate in either equation.

(v) If a process condenser is used for any boiling operations, you must demonstrate that it is properly operated according to the procedures specified in §63.1257(d)(2)(i)(C)(4)(ii) and (d)(3)(iii)(B), and the demonstration must occur only during the boiling operation. The reference in §63.1257(d)(3)(iii)(B) to the alternative standard in §63.1254(c) means §63.2505 for the purposes of this subpart. As an alternative

to measuring the exhaust gas temperature, as required by §63.1257(d)(3)(iii)(B), you may elect to measure the liquid temperature in the receiver.

(vi) You must conduct a subsequent performance test or compliance demonstration equivalent to an initial compliance demonstration within 180 days of a change in the worst-case conditions.

(3) *Establishing operating limits.* You must establish operating limits under the conditions required for your initial compliance demonstration, except you may elect to establish operating limit(s) for conditions other than those under which a performance test was conducted as specified in paragraph (c)(3)(i) of this section and, if applicable, paragraph (c)(3)(ii) of this section.

(i) The operating limits may be based on the results of the performance test and supplementary information such as engineering assessments and manufacturer's recommendations. These limits may be established for conditions as unique as individual emission episodes for a batch process. You must provide rationale in the precompliance report for the specific level for each operating limit, including any data and calculations used to develop the limit and a description of why the limit indicates proper operation of the control device. The procedures provided in this paragraph (c)(3)(i) have not been approved by the Administrator and determination of the operating limit using these procedures is subject to review and approval by the Administrator.

(ii) If you elect to establish separate monitoring levels for different emission episodes within a batch process, you must maintain records in your daily schedule or log of processes indicating each point at which you change from one operating limit to another, even if the duration of the monitoring for an operating limit is less than 15 minutes. You must maintain a daily schedule or log of processes according to §63.2525(c).

(4) *Averaging periods.* As an alternative to the requirement for daily averages in §63.998(b)(3), you may determine averages for operating blocks. An operating block is a period of time that is equal to the time from the beginning to end of batch process operations within a process.

(5) [Reserved]

(6) *Outlet concentration correction for supplemental gases.* If you use a control device other than a combustion device to comply with a TOC, organic HAP, or hydrogen halide and halogen HAP outlet concentration emission limit for batch process vents, you must correct the actual concentration for supplemental gases using Equation 1 of this section; you may use process knowledge and representative operating data to determine the fraction of the total flow due to supplemental gas.

$$C_a = C_m \left( \frac{Q_s + Q_a}{Q_a} \right) \quad (\text{Eq. 1})$$

[View or download PDF](#)

Where:

$C_a$  = corrected outlet TOC, organic HAP, or hydrogen halide and halogen HAP concentration, dry basis, ppmv;

$C_m$  = actual TOC, organic HAP, or hydrogen halide and halogen HAP concentration measured at control device outlet, dry basis, ppmv;

$Q_a$  = total volumetric flowrate of all gas streams vented to the control device, except supplemental gases;

$Q_s$  = total volumetric flowrate of supplemental gases.

(7) If flow to a control device could be intermittent, you must install, calibrate, and operate a flow indicator at the inlet or outlet of the control device to identify periods of no flow. Periods of no flow may not be used in daily or block averages, and it may not be used in fulfilling a minimum data availability requirement.

(8) *Terminology.* When the term “storage vessel” is used in subpart WW of this part 63, the term “process tank,” as defined in §63.2550(i), applies for the purposes of this section.

(9) *Requirements for a biofilter.* If you use a biofilter to meet either the 95 percent reduction requirement or outlet concentration requirement specified in Table 2 to this subpart, you must meet the requirements specified in paragraphs (c)(9)(i) through (iv) of this section.

(i) *Operational requirements.* The biofilter must be operated at all times when emissions are vented to it.

(ii) *Performance tests.* To demonstrate initial compliance, you must conduct a performance test according to the procedures in §63.997 and paragraphs (c)(9)(ii)(A) through (D) of this section. The design evaluation option for small control devices is not applicable if you use a biofilter.

(A) Keep up-to-date, readily accessible continuous records of either the biofilter bed temperature averaged over the full period of the performance test or the outlet total organic HAP or TOC concentration averaged over the full period of the performance test. Include these data in your notification of compliance status report as required by §63.999(b)(3)(ii).

(B) Record either the percent reduction of total organic HAP achieved by the biofilter determined as specified in §63.997(e)(2)(iv) or the concentration of TOC or total organic HAP determined as specified in §63.997(e)(2)(iii) at the outlet of the biofilter, as applicable.

(C) If you monitor the biofilter bed temperature, you may elect to use multiple thermocouples in representative locations throughout the biofilter bed and calculate the average biofilter bed temperature across these thermocouples prior to reducing the temperature data to 15 minute (or shorter) averages for purposes of establishing operating limits for the biofilter. If you use multiple thermocouples, include your rationale for their site selection in your notification of compliance status report.

(D) Submit a performance test report as specified in §63.999(a)(2)(i) and (ii). Include the records from paragraph (c)(9)(ii)(B) of this section in your performance test report.

(iii) *Monitoring requirements.* Use either a biofilter bed temperature monitoring device (or multiple devices) capable of providing a continuous record or an organic monitoring device capable of providing a continuous record. Keep records of temperature or other parameter monitoring results as specified in §63.998(b) and (c), as applicable. General requirements for monitoring are contained in §63.996. If you monitor temperature, the operating temperature range must be based on only the temperatures measured

during the performance test; these data may not be supplemented by engineering assessments or manufacturer's recommendations as otherwise allowed in §63.999(b)(3)(ii)(A). If you establish the operating range (minimum and maximum temperatures) using data from previous performance tests in accordance with §63.996(c)(6), replacement of the biofilter media with the same type of media is not considered a process change under §63.997(b)(1). You may expand your biofilter bed temperature operating range by conducting a repeat performance test that demonstrates compliance with the 95 percent reduction requirement or outlet concentration limit, as applicable.

(iv) *Repeat performance tests.* You must conduct a repeat performance test using the applicable methods specified in §63.997 within 2 years following the previous performance test and within 150 days after each replacement of any portion of the biofilter bed media with a different type of media or each replacement of more than 50 percent (by volume) of the biofilter bed media with the same type of media.

[68 FR 63888, Nov. 10, 2003, as amended at 70 FR 38559, July 1, 2005; 71 FR 40333, July 14, 2006]

[↑ Back to Top](#)

### **§63.2465 What requirements must I meet for process vents that emit hydrogen halide and halogen HAP or HAP metals?**

(a) You must meet each emission limit in Table 3 to this subpart that applies to you, and you must meet each applicable requirement in paragraphs (b) through (d) of this section.

(b) If any process vents within a process emit hydrogen halide and halogen HAP, you must determine and sum the uncontrolled hydrogen halide and halogen HAP emissions from each of the process vents within the process using the procedures specified in §63.1257(d)(2)(i) and/or (ii), as appropriate. When §63.1257(d)(2)(ii)(E) requires documentation to be submitted in the precompliance report, it means the notification of compliance status report for the purposes of this paragraph.

(c) If collective uncontrolled hydrogen halide and halogen HAP emissions from the process vents within a process are greater than or equal to 1,000 pounds per year (lb/yr), you must comply with §63.994 and the requirements referenced therein, except as specified in paragraphs (c)(1) through (3) of this section.

(1) When §63.994(b)(1) requires a performance test, you may elect to conduct a design evaluation in accordance with §63.1257(a)(1).

(2) When §63.994(b)(1) refers to “a combustion device followed by a halogen scrubber or other halogen reduction device,” it means any combination of control devices used to meet the emission limits specified in Table 3 to this subpart.

(3) Section 63.994(b)(2) does not apply for the purposes of this section.

(d) To demonstrate compliance with the emission limit in Table 3 to this subpart for HAP metals at a new source, you must comply with paragraphs (d)(1) through (3) of this section.

(1) Determine the mass emission rate of HAP metals based on process knowledge, engineering assessment, or test data.



(2) Conduct an initial performance test of each control device that is used to comply with the emission limit for HAP metals specified in Table 3 to this subpart. Conduct the performance test according to the procedures in §63.997. Use Method 29 of appendix A of 40 CFR part 60 to determine the HAP metals at the inlet and outlet of each control device, or use Method 5 of appendix A of 40 CFR part 60 to determine the total particulate matter (PM) at the inlet and outlet of each control device. You have demonstrated initial compliance if the overall reduction of either HAP metals or total PM from the process is greater than or equal to 97 percent by weight.

(3) Comply with the monitoring requirements specified in §63.1366(b)(1)(xi) for each fabric filter used to control HAP metals.

[68 FR 63888, Nov. 10, 2003, as amended at 71 FR 40334, July 14, 2006]

[↑ Back to Top](#)

### **§63.2470 What requirements must I meet for storage tanks?**

(a) You must meet each emission limit in Table 4 to this subpart that applies to your storage tanks, and you must meet each applicable requirement specified in paragraphs (b) through (e) of this section.

(b) [Reserved]

(c) *Exceptions to subparts SS and WW of this part 63.* (1) If you conduct a performance test or design evaluation for a control device used to control emissions only from storage tanks, you must establish operating limits, conduct monitoring, and keep records using the same procedures as required in subpart SS of this part 63 for control devices used to reduce emissions from process vents instead of the procedures specified in §§63.985(c), 63.998(d)(2)(i), and 63.999(b)(2).

(2) When the term “storage vessel” is used in subparts SS and WW of this part 63, the term “storage tank,” as defined in §63.2550 applies for the purposes of this subpart.

(d) *Planned routine maintenance.* The emission limits in Table 4 to this subpart for control devices used to control emissions from storage tanks do not apply during periods of planned routine maintenance. Periods of planned routine maintenance of each control device, during which the control device does not meet the emission limit specified in Table 4 to this subpart, must not exceed 240 hours per year (hr/yr). You may submit an application to the Administrator requesting an extension of this time limit to a total of 360 hr/yr. The application must explain why the extension is needed, it must indicate that no material will be added to the storage tank between the time the 240-hr limit is exceeded and the control device is again operational, and it must be submitted at least 60 days before the 240-hr limit will be exceeded.

(e) *Vapor balancing alternative.* As an alternative to the emission limits specified in Table 4 to this subpart, you may elect to implement vapor balancing in accordance with §63.1253(f), except as specified in paragraphs (e)(1) through (3) of this section.

(1) When §63.1253(f)(6)(i) refers to a 90 percent reduction, 95 percent applies for the purposes of this subpart.

(2) To comply with §63.1253(f)(6)(i), the owner or operator of an offsite cleaning or reloading facility must comply with §§63.2445 through 63.2550 instead of complying with §63.1253(f)(7)(ii), except as specified in paragraph (e)(2)(i) or (ii) of this section.

(i) The reporting requirements in §63.2520 do not apply to the owner or operator of the offsite cleaning or reloading facility.

(ii) As an alternative to complying with the monitoring, recordkeeping, and reporting provisions in §§63.2445 through 63.2550, the owner or operator of an offsite cleaning or reloading facility may comply as specified in §63.2535(a)(2) with any other subpart of this part 63 which has monitoring, recordkeeping, and reporting provisions as specified in §63.2535(a)(2).

(3) You may elect to set a pressure relief device to a value less than the 2.5 pounds per square inch gage pressure (psig) required in §63.1253(f)(5) if you provide rationale in your notification of compliance status report explaining why the alternative value is sufficient to prevent breathing losses at all times.

(4) You may comply with the vapor balancing alternative in §63.1253(f) when your storage tank is filled from a barge. All requirements for tank trucks and railcars specified in §63.1253(f) also apply to barges, except as specified in §63.2470(e)(4)(i).

(i) When §63.1253(f)(2) refers to pressure testing certifications, the requirements in 40 CFR 61.304(f) apply for barges.

(ii) [Reserved]

[68 FR 63888, Nov. 10, 2003, as amended at 70 FR 38559, July 1, 2005; 71 FR 40335, July 14, 2006]

[↑ Back to Top](#)

#### **§63.2475 What requirements must I meet for transfer racks?**

(a) You must comply with each emission limit and work practice standard in table 5 to this subpart that applies to your transfer racks, and you must meet each applicable requirement in paragraphs (b) and (c) of this section.

(b) When the term “high throughput transfer rack” is used in subpart SS of this part 63, the term “Group 1 transfer rack,” as defined in §63.2550, applies for the purposes of this subpart.

[68 FR 63888, Nov. 10, 2003, as amended at 71 FR 40335, July 14, 2006]

[↑ Back to Top](#)

#### **§63.2480 What requirements must I meet for equipment leaks?**

(a) You must meet each requirement in table 6 to this subpart that applies to your equipment leaks, except as specified in paragraphs (b) through (d) of this section.

(b) If you comply with either subpart H or subpart UU of this part 63, you may elect to comply with the provisions in paragraphs (b)(1) through (5) of this section as an alternative to the referenced provisions in subpart H or subpart UU of this part.

(1) The requirements for pressure testing in §63.179(b) or §63.1036(b) may be applied to all processes, not just batch processes.

(2) For the purposes of this subpart, pressure testing for leaks in accordance with §63.179(b) or §63.1036(b) is not required after reconfiguration of an equipment train if flexible hose connections are the only disturbed equipment.

(3) For an existing source, you are not required to develop an initial list of identification numbers for connectors as would otherwise be required under §63.1022(b)(1) or §63.181(b)(1)(i).

(4) For connectors in gas/vapor and light liquid service at an existing source, you may elect to comply with the requirements in §63.169 or §63.1029 for connectors in heavy liquid service, including all associated recordkeeping and reporting requirements, rather than the requirements of §63.174 or §63.1027.

(5) For pumps in light liquid service in an MCPU that has no continuous process vents and is part of an existing source, you may elect to consider the leak definition that defines a leak to be 10,000 parts per million (ppm) or greater as an alternative to the values specified in §63.1026(b)(2)(i) through (iii) or §63.163(b)(2).

(c) If you comply with 40 CFR part 65, subpart F, you may elect to comply with the provisions in paragraphs (c)(1) through (9) of this section as an alternative to the referenced provisions in 40 CFR part 65, subpart F.

(1) The requirements for pressure testing in §65.117(b) may be applied to all processes, not just batch processes.

(2) For the purposes of this subpart, pressure testing for leaks in accordance with §65.117(b) is not required after reconfiguration of an equipment train if flexible hose connections are the only disturbed equipment.

(3) For an existing source, you are not required to develop an initial list of identification numbers for connectors as would otherwise be required under §65.103(b)(1).

(4) You may elect to comply with the monitoring and repair requirements specified in §65.108(e)(3) as an alternative to the requirements specified in §65.108(a) through (d) for any connectors at your affected source.

(5) For pumps in light liquid service in an MCPU that has no continuous process vents and is part of an existing source, you may elect to consider the leak definition that defines a leak to be 10,000 ppm or greater as an alternative to the values specified in §65.107(b)(2)(i) through (iii).

(6) When 40 CFR part 65, subpart F refers to the implementation date specified in §65.1(f), it means the compliance date specified in §63.2445.

(7) When §§65.105(f) and 65.117(d)(3) refer to §65.4, it means §63.2525.

(8) When §65.120(a) refers to §65.5(d), it means §63.2515.

(9) When §65.120(b) refers to §65.5(e), it means §63.2520.

(d) The provisions of this section do not apply to bench-scale processes, regardless of whether the processes are located at the same plant site as a process subject to the provisions of this subpart.

[71 FR 40335, July 14, 2006]

[↑ Back to Top](#)

### **§63.2485 What requirements must I meet for wastewater streams and liquid streams in open systems within an MCPU?**

(a) You must meet each requirement in table 7 to this subpart that applies to your wastewater streams and liquid streams in open systems within an MCPU, except as specified in paragraphs (b) through (o) of this section.

(b) *Wastewater HAP.* Where §63.105 and §§63.132 through 63.148 refer to compounds in table 9 of subpart G of this part 63, the compounds in tables 8 and 9 to this subpart apply for the purposes of this subpart.

(c) *Group 1 wastewater.* Section 63.132(c)(1) (i) and (ii) do not apply. For the purposes of this subpart, a process wastewater stream is Group 1 for compounds in tables 8 and 9 to this subpart if any of the conditions specified in paragraphs (c) (1) through (3) of this section are met.

(1) The total annual average concentration of compounds in table 8 to this subpart is greater than or equal to 10,000 ppmw at any flowrate, and the total annual load of compounds in table 8 to this subpart is greater than or equal to 200 lb/yr.

(2) The total annual average concentration of compounds in table 8 to this subpart is greater than or equal to 1,000 ppmw, and the annual average flowrate is greater than or equal to 1 l/min.

(3) The combined total annual average concentration of compounds in tables 8 and 9 to this subpart is greater than or equal to 30,000 ppmw, and the combined total annual load of compounds in tables 8 and 9 to this subpart is greater than or equal to 1 tpy.

(d) *Wastewater tank requirements.* (1) When §§63.133 and 63.147 reference floating roof requirements in §§63.119 and 63.120, the corresponding requirements in subpart WW of this part 63 may be applied for the purposes of this subpart.

(2) When §63.133(a) refers to table 10 of subpart G of this part 63, the maximum true vapor pressure in the table shall be limited to the HAP listed in tables 8 and 9 of this subpart FFFF.

(3) For the purposes of this subpart, the requirements of §63.133(a)(2) are satisfied by operating and maintaining a fixed roof if you demonstrate that the total soluble and partially soluble HAP emissions

from the wastewater tank are no more than 5 percent higher than the emissions would be if the contents of the wastewater tank were not heated, treated by an exothermic reaction, or sparged.

(4) The emission limits specified in §§63.133(b)(2) and 63.139 for control devices used to control emissions from wastewater tanks do not apply during periods of planned routine maintenance of the control device(s) of no more than 240 hr/yr. You may request an extension to a total of 360 hr/yr in accordance with the procedures specified in §63.2470(d).

(e) *Individual drain systems.* The provisions of §63.136(e)(3) apply except as specified in paragraph (e)(1) of this section.

(1) A sewer line connected to drains that are in compliance with §63.136(e)(1) may be vented to the atmosphere, provided that the sewer line entrance to the first downstream junction box is water sealed and the sewer line vent pipe is designed as specified in §63.136(e)(2)(ii)(A).

(2) [Reserved]

(f) *Closed-vent system requirements.* When §63.148(k) refers to closed vent systems that are subject to the requirements of §63.172, the requirements of either §63.172 or §63.1034 apply for the purposes of this subpart.

(g) *Halogenated vent stream requirements.* For each halogenated vent stream from a Group 1 wastewater stream or residual removed from a Group 1 wastewater stream that is vented through a closed-vent system to a combustion device to reduce organic HAP emissions, you must meet the same emission limits as specified for batch process vents in item 2 of table 2 to this subpart.

(h) *Alternative test methods.* (1) As an alternative to the test methods specified in §63.144(b)(5)(i), you may use Method 8260 or 8270 as specified in §63.1257(b)(10)(iii).

(2) As an alternative to using the methods specified in §63.144(b)(5)(i), you may conduct wastewater analyses using Method 1666 or 1671 of 40 CFR part 136 and comply with the sampling protocol requirements specified in §63.144(b)(5)(ii). The validation requirements specified in §63.144(b)(5)(iii) do not apply if you use Method 1666 or 1671 of 40 CFR part 136.

(3) As an alternative to using Method 18 of 40 CFR part 60, as specified in §§63.139(c)(1)(ii) and 63.145(i)(2), you may elect to use Method 25A of 40 CFR part 60 as specified in §63.997.

(i) *Offsite management and treatment option.* (1) If you ship wastewater to an offsite treatment facility that meets the requirements of §63.138(h), you may elect to document in your notification of compliance status report that the wastewater will be treated as hazardous waste at a facility that meets the requirements of §63.138(h) as an alternative to having the offsite facility submit the certification specified in §63.132(g)(2).

(2) As an alternative to the management and treatment options specified in §63.132(g)(2), any affected wastewater stream (or residual removed from an affected wastewater stream) with a total annual average concentration of compounds in Table 8 to this subpart less than 50 ppmw may be transferred offsite in accordance with paragraphs (i)(2) (i) and (ii) of this section.

(i) The transferee (or you) must demonstrate that less than 5 percent of the HAP in Table 9 to this subpart is emitted from the waste management units up to the activated sludge unit.

(ii) The transferee must treat the wastewater stream or residual in a biological treatment unit in accordance with §§63.138 and 63.145 and the requirements referenced therein.

(j) You must determine the annual average concentration and annual average flowrate for wastewater streams for each MCPU. The procedures for flexible operation units specified in §63.144 (b) and (c) do not apply for the purposes of this subpart.

(k) The requirement to correct outlet concentrations from combustion devices to 3 percent oxygen in §§63.139(c)(1)(ii) and 63.146(i)(6) applies only if supplemental gases are combined with a vent stream from a Group 1 wastewater stream. If emissions are controlled with a vapor recovery system as specified in §63.139(c)(2), you must correct for supplemental gases as specified in §63.2460(c)(6).

(l) *Requirements for liquid streams in open systems.* (1) References in §63.149 to §63.100(b) mean §63.2435(b) for the purposes of this subpart.

(2) When §63.149(e) refers to 40 CFR 63.100(1) (1) or (2), §63.2445(a) applies for the purposes of this subpart.

(3) When §63.149 uses the term “chemical manufacturing process unit,” the term “MCPU” applies for the purposes of this subpart.

(4) When §63.149(e)(1) refers to characteristics of water that contain compounds in Table 9 to 40 CFR part 63, subpart G, the characteristics specified in paragraphs (c) (1) through (3) of this section apply for the purposes of this subpart.

(5) When §63.149(e)(2) refers to characteristics of water that contain compounds in Table 9 to 40 CFR part 63, subpart G, the characteristics specified in paragraph (c)(2) of this section apply for the purposes of this subpart.

(m) When §63.132(f) refers to “a concentration of greater than 10,000 ppmw of table 9 compounds,” the phrase “a concentration of greater than 30,000 ppmw of total partially soluble HAP (PSHAP) and soluble HAP (SHAP) or greater than 10,000 ppmw of PSHAP” shall apply for the purposes of this subpart.

(n) *Alternative requirements for wastewater that is Group 1 for soluble HAP only.* The option specified in this paragraph (n) applies to wastewater that is Group 1 for soluble HAP in accordance with paragraph (c)(3) of this section and is discharged to biological treatment. Except as provided in paragraph (n)(4) of this section, this option does not apply to wastewater that is Group 1 for partially soluble HAP in accordance with paragraph (c)(1), (c)(2), or (c)(4) of this section. For wastewater that is Group 1 for SHAP, you need not comply with §§63.133 through 63.137 for any equalization unit, neutralization unit, and/or clarifier prior to the activated sludge unit, and you need not comply with the venting requirements in §63.136(e)(2)(ii)(A) for lift stations with a volume larger than 10,000 gal, provided you comply with the requirements specified in paragraphs (n)(1) through (3) of this section and all otherwise applicable requirements specified in table 7 to this subpart. For this option, the treatment requirements in §63.138

and the performance testing requirements in §63.145 do not apply to the biological treatment unit, except as specified in paragraphs (n)(2)(i) through (iv) of this section.

(1) Wastewater must be hard-piped between the equalization unit, clarifier, and activated sludge unit. This requirement does not apply to the transfer between any of these types of units that are part of the same structure and one unit overflows into the next.

(2) Calculate the destruction efficiency of the biological treatment unit using Equation 1 of this section in accordance with the procedures described in paragraphs (n)(2)(i) through (vi) of this section. You have demonstrated initial compliance if E is greater than or equal to 90 percent.

$$E = \frac{(QMW_a - QMG_e - QMG_n - QMG_c)(F_{bio})}{QMW_a} \times 100 \quad (\text{Eq. 1})$$

[View or download PDF](#)

Where:

E = destruction efficiency of total PSHAP and SHAP for the biological treatment unit including the equalization unit, neutralization unit, and/or clarifier, percent;

$QMW_a$  = mass flow rate of total PSHAP and SHAP compounds entering the equalization unit (or whichever of the three types of units is first), kilograms per hour (kg/hr);

$QMG_e$  = mass flow rate of total PSHAP and SHAP compounds emitted from the equalization unit, kg/hr;

$QMG_n$  = mass flow rate of total PSHAP and SHAP compounds emitted from the neutralization unit, kg/hr;

$QMG_c$  = mass flow rate of total PSHAP and SHAP compounds emitted from the clarifier, kg/hr

$F_{bio}$  = site-specific fraction of PSHAP and SHAP compounds biodegraded in the biological treatment unit.

(i) Include all PSHAP and SHAP compounds in both Group 1 and Group 2 wastewater streams from all MCPUs, except you may exclude any compounds that meet the criteria specified in §63.145(a)(6)(ii) or (iii).

(ii) Conduct the demonstration under representative process unit and treatment unit operating conditions in accordance with §63.145(a)(3) and (4).

(iii) Determine PSHAP and SHAP concentrations and the total wastewater flow rate at the inlet to the equalization unit in accordance with §63.145(f)(1) and (2). References in §63.145(f)(1) and (2) to required mass removal and actual mass removal do not apply for the purposes of this section.

(iv) Determine  $F_{bio}$  for the activated sludge unit as specified in §63.145(h), except as specified in paragraph (n)(2)(iv)(A) or paragraph (n)(2)(iv)(B) of this section.

(A) If the biological treatment process meets both of the requirements specified in §63.145(h)(1)(i) and (ii), you may elect to replace the  $F_{\text{bio}}$  term in Equation 1 of this section with the numeral “1.”

(B) You may elect to assume  $f_{\text{bio}}$  is zero for any compounds on List 2 of table 36 in subpart G.

(v) Determine  $\text{QMG}_e$ ,  $\text{QMG}_n$ , and  $\text{QMG}_c$  using EPA's WATER9 model or the most recent update to this model, and conduct testing or use other procedures to validate the modeling results.

(vi) Submit the data and results of your demonstration, including both a description of and the results of your WATER9 modeling validation procedures, in your notification of compliance status report as specified in §63.2520(d)(2)(ii).

(3) As an alternative to the venting requirements in §63.136(e)(2)(ii)(A), a lift station with a volume larger than 10,000 gal may have openings necessary for proper venting of the lift station. The size and other design characteristics of these openings may be established based on manufacturer recommendations or engineering judgment for venting under normal operating conditions. You must describe the design of such openings and your supporting calculations and other rationale in your notification of compliance status report.

(4) For any wastewater streams that are Group 1 for both PSHAP and SHAP, you may elect to meet the requirements specified in table 7 to this subpart for the PSHAP and then comply with paragraphs (n)(1) through (3) of this section for the SHAP in the wastewater system. You may determine the SHAP mass removal rate, in kg/hr, in treatment units that are used to meet the requirements for PSHAP and add this amount to both the numerator and denominator in Equation 1 of this section.

(o) *Compliance records.* For each CPMS used to monitor a nonflare control device for wastewater emissions, you must keep records as specified in §63.998(c)(1) in addition to the records required in §63.147(d).

[68 FR 63888, Nov. 10, 2003, as amended at 70 FR 38559, July 1, 2005; 71 FR 40335, July 14, 2006]

[↑ Back to Top](#)

### **§63.2490 What requirements must I meet for heat exchange systems?**

(a) You must comply with each requirement in Table 10 to this subpart that applies to your heat exchange systems, except as specified in paragraphs (b) and (c) of this section.

(b) The phrase “a chemical manufacturing process unit meeting the conditions of §63.100 (b)(1) through (b)(3) of this section” in §63.104(a) means “an MCPU meeting the conditions of §63.2435” for the purposes of this subpart.

(c) The reference to §63.100(c) in §63.104(a) does not apply for the purposes of this subpart.

[↑ Back to Top](#)

### **Alternative Means of Compliance**

[↑ Back to Top](#)



### **§63.2495 How do I comply with the pollution prevention standard?**

(a) You may elect to comply with the pollution prevention alternative requirements specified in paragraphs (a) (1) and (2) of this section in lieu of the emission limitations and work practice standards contained in Tables 1 through 7 to this subpart for any MCPU for which initial startup occurred before April 4, 2002.

(1) You must reduce the production-indexed HAP consumption factor (HAP factor) by at least 65 percent from a 3-year average baseline beginning no earlier than the 1994 through 1996 calendar years. For any reduction in the HAP factor that you achieve by reducing HAP that are also volatile organic compounds (VOC), you must demonstrate an equivalent reduction in the production-indexed VOC consumption factor (VOC factor) on a mass basis. For any reduction in the HAP factor that you achieve by reducing a HAP that is not a VOC, you may not increase the VOC factor.

(2) Any MCPU for which you seek to comply by using the pollution prevention alternative must begin with the same starting material(s) and end with the same product(s). You may not comply by eliminating any steps of a process by transferring the step offsite (to another manufacturing location). You may also not merge a solvent recovery step conducted offsite to onsite and as part of an existing process as a method of reducing consumption.

(3) You may comply with the requirements of paragraph (a)(1) of this section for a series of processes, including situations where multiple processes are merged, if you demonstrate to the satisfaction of the Administrator that the multiple processes were merged after the baseline period into an existing process or processes.

(b) *Exclusions.* (1) You must comply with the emission limitations and work practice standards contained in tables 1 through 7 of this subpart for all HAP that are generated in the MCPU and that are not included in consumption, as defined in §63.2550. If any vent stream routed to the combustion control is a halogenated vent stream, as defined in §63.2550, then hydrogen halides that are generated as a result of combustion control must be controlled according to the requirements of §63.994 and the requirements referenced therein.

(2) You may not merge nondedicated formulation or nondedicated solvent recovery processes with any other processes.

(c) *Initial compliance procedures.* To demonstrate initial compliance with paragraph (a) of this section, you must prepare a demonstration summary in accordance with paragraph (c) (1) of this section and calculate baseline and target annual HAP and VOC factors in accordance with paragraphs (c) (2) and (3) of this section.

(1) *Demonstration plan.* You must prepare a pollution prevention demonstration plan that contains, at a minimum, the information in paragraphs (c)(1) (i) through (iii) of this section for each MCPU for which you comply with paragraph (a) of this section.

(i) Descriptions of the methodologies and forms used to measure and record consumption of HAP and VOC compounds.

(ii) Descriptions of the methodologies and forms used to measure and record production of the product(s).

(iii) Supporting documentation for the descriptions provided in accordance with paragraphs (c)(1) (i) and (ii) of this section including, but not limited to, samples of operator log sheets and daily, monthly, and/or annual inventories of materials and products. You must describe how this documentation will be used to calculate the annual factors required in paragraph (d) of this section.

(2) *Baseline factors.* You must calculate baseline HAP and VOC factors by dividing the consumption of total HAP and total VOC by the production rate, per process, for the first 3-year period in which the process was operational, beginning no earlier than the period consisting of the 1994 through 1996 calendar years.

(3) *Target annual factors.* You must calculate target annual HAP and VOC factors. The target annual HAP factor must be equal to 35 percent of the baseline HAP factor. The target annual VOC factor must be lower than the baseline VOC factor by an amount equivalent to the reduction in any HAP that is also a VOC, on a mass basis. The target annual VOC factor may be the same as the baseline VOC factor if the only HAP you reduce is not a VOC.

(d) *Continuous compliance requirements.* You must calculate annual rolling average values of the HAP and VOC factors (annual factors) in accordance with the procedures specified in paragraphs (d) (1) through (3) of this section. To show continuous compliance, the annual factors must be equal to or less than the target annual factors calculated according to paragraph (c)(3) of this section.

(1) To calculate the annual factors, you must divide the consumption of both total HAP and total VOC by the production rate, per process, for 12-month periods at the frequency specified in either paragraph (d) (2) or (3) of this section, as applicable.

(2) For continuous processes, you must calculate the annual factors every 30 days for the 12-month period preceding the 30th day (i.e., annual rolling average calculated every 30 days). A process with both batch and continuous operations is considered a continuous process for the purposes of this section.

(3) For batch processes, you must calculate the annual factors every 10 batches for the 12-month period preceding the 10th batch (i.e., annual rolling average calculated every 10 batches), except as specified in paragraphs (d)(3) (i) and (ii) of this section.

(i) If you produce more than 10 batches during a month, you must calculate the annual factors at least once during that month.

(ii) If you produce less than 10 batches in a 12-month period, you must calculate the annual factors for the number of batches in the 12-month period since the previous calculations.

(e) *Records.* You must keep records of HAP and VOC consumption, production, and the rolling annual HAP and VOC factors for each MCPU for which you are complying with paragraph (a) of this section.

(f) *Reporting.* (1) You must include the pollution prevention demonstration plan in the precompliance report required by §63.2520(c).

(2) You must identify all days when the annual factors were above the target factors in the compliance reports.

[68 FR 63888, Nov. 10, 2003, as amended at 71 FR 40336, July 14, 2006]

[↑ Back to Top](#)

### **§63.2500 How do I comply with emissions averaging?**

(a) For an existing source, you may elect to comply with the percent reduction emission limitations in Tables 1, 2, 4, 5, and 7 to this subpart by complying with the emissions averaging provisions specified in §63.150, except as specified in paragraphs (b) through (f) of this section.

(b) The batch process vents in an MCPU collectively are considered one individual emission point for the purposes of emissions averaging, except that only individual batch process vents must be excluded to meet the requirements of §63.150(d)(5).

(c) References in §63.150 to §§63.112 through 63.130 mean the corresponding requirements in §§63.2450 through 63.2490, including applicable monitoring, recordkeeping, and reporting.

(d) References to “periodic reports” in §63.150 mean “compliance report” for the purposes of this subpart.

(e) For batch process vents, estimate uncontrolled emissions for a standard batch using the procedures in §63.1257(d)(2)(i) and (ii) instead of the procedures in §63.150(g)(2). Multiply the calculated emissions per batch by the number of batches per month when calculating the monthly emissions for use in calculating debits and credits.

(f) References to “storage vessels” in §63.150 mean “storage tank” as defined in §63.2550 for the purposes of this subpart.

[↑ Back to Top](#)

### **§63.2505 How do I comply with the alternative standard?**

As an alternative to complying with the emission limits and work practice standards for process vents and storage tanks in Tables 1 through 4 to this subpart and the requirements in §§63.2455 through 63.2470, you may comply with the emission limits in paragraph (a) of this section and demonstrate compliance in accordance with the requirements in paragraph (b) of this section.

(a) *Emission limits and work practice standards.* (1) You must route vent streams through a closed-vent system to a control device that reduces HAP emissions as specified in either paragraph (a)(1)(i) or (ii) of this section.

(i) If you use a combustion control device, it must reduce HAP emissions as specified in paragraphs (a)(1)(i)(A), (B), and (C) of this section.

(A) To an outlet TOC concentration of 20 parts per million by volume (ppmv) or less.

(B) To an outlet concentration of hydrogen halide and halogen HAP of 20 ppmv or less.

(C) As an alternative to paragraph (a)(1)(i)(B) of this section, if you control halogenated vent streams emitted from a combustion device followed by a scrubber, reduce the hydrogen halide and halogen HAP generated in the combustion device by greater than or equal to 95 percent by weight in the scrubber.

(ii) If you use a noncombustion control device(s), it must reduce HAP emissions to an outlet total organic HAP concentration of 50 ppmv or less, and an outlet concentration of hydrogen halide and halogen HAP of 50 ppmv or less.

(2) Any Group 1 process vents within a process that are not controlled according to this alternative standard must be controlled according to the emission limits in tables 1 through 3 to this subpart.

(b) *Compliance requirements.* To demonstrate compliance with paragraph (a) of this section, you must meet the requirements of §63.1258(b)(5) beginning no later than the initial compliance date specified in §63.2445, except as specified in paragraphs (b)(1) through (9) of this section.

(1) You must comply with the requirements in §63.983 and the requirements referenced therein for closed-vent systems.

(2) When §63.1258(b)(5)(i) refers to §§63.1253(d) and 63.1254(c), the requirements in paragraph (a) of this section apply for the purposes of this subpart FFFF.

(3) When §63.1258(b)(5)(i)(B) refers to “HCl,” it means “total hydrogen halide and halogen HAP” for the purposes of this subpart FFFF.

(4) When §63.1258(b)(5)(ii) refers to §63.1257(a)(3), it means §63.2450(j)(5) for the purposes of this subpart FFFF.

(5) You must submit the results of any determination of the target analytes of predominant HAP in the notification of compliance status report.

(6) If you elect to comply with the requirement to reduce hydrogen halide and halogen HAP by greater than or equal to 95 percent by weight in paragraph (a)(1)(i)(C) of this section, you must meet the requirements in paragraphs (b)(6)(i) and (ii) of this section.

(i) Demonstrate initial compliance with the 95 percent reduction by conducting a performance test and setting a site-specific operating limit(s) for the scrubber in accordance with §63.994 and the requirements referenced therein. You must submit the results of the initial compliance demonstration in the notification of compliance status report.

(ii) Install, operate, and maintain CPMS for the scrubber as specified in §§63.994(c) and 63.2450(k), instead of as specified in §63.1258(b)(5)(i)(C).

(7) If flow to the scrubber could be intermittent, you must install, calibrate, and operate a flow indicator as specified in §63.2460(c)(7).

(8) Use the operating day as the averaging period for CEMS data and scrubber parameter monitoring data.

(9) The requirements in paragraph (a) of this section do not apply to emissions from storage tanks during periods of planned routine maintenance of the control device that do not exceed 240 hr/yr. You may submit an application to the Administrator requesting an extension of this time limit to a total of 360 hr/yr in accordance with the procedures specified in §63.2470(d). You must comply with the recordkeeping and reporting specified in §§63.998(d)(2)(ii) and 63.999(c)(4) for periods of planned routine maintenance.

[68 FR 63888, Nov. 10, 2003, as amended at 70 FR 38559, July 1, 2005]

[↑ Back to Top](#)

## Notification, Reports, and Records

[↑ Back to Top](#)

### §63.2515 What notifications must I submit and when?

(a) You must submit all of the notifications in §§63.6(h)(4) and (5), 63.7(b) and (c), 63.8(e), (f)(4) and (6), and 63.9(b) through (h) that apply to you by the dates specified.

(b) *Initial notification.* As specified in §63.9(b)(2), if you startup your affected source before November 10, 2003, you must submit an initial notification not later than 120 calendar days after November 10, 2003.

(2) As specified in §63.9(b)(3), if you startup your new affected source on or after November 10, 2003, you must submit an initial notification not later than 120 calendar days after you become subject to this subpart.

(c) *Notification of performance test.* If you are required to conduct a performance test, you must submit a notification of intent to conduct a performance test at least 60 calendar days before the performance test is scheduled to begin as required in §63.7(b)(1). For any performance test required as part of the initial compliance procedures for batch process vents in table 2 to this subpart, you must also submit the test plan required by §63.7(c) and the emission profile with the notification of the performance test.

[↑ Back to Top](#)

### §63.2520 What reports must I submit and when?

(a) You must submit each report in Table 11 to this subpart that applies to you.

(b) Unless the Administrator has approved a different schedule for submission of reports under §63.10(a), you must submit each report by the date in table 11 to this subpart and according to paragraphs (b)(1) through (5) of this section.

(1) The first compliance report must cover the period beginning on the compliance date that is specified for your affected source in §63.2445 and ending on June 30 or December 31, whichever date is the first date following the end of the first 6 months after the compliance date that is specified for your affected source in §63.2445.

(2) The first compliance report must be postmarked or delivered no later than August 31 or February 28, whichever date is the first date following the end of the first reporting period specified in paragraph (b)(1) of this section.

(3) Each subsequent compliance report must cover the semiannual reporting period from January 1 through June 30 or the semiannual reporting period from July 1 through December 31.

(4) Each subsequent compliance report must be postmarked or delivered no later than August 31 or February 28, whichever date is the first date following the end of the semiannual reporting period.

(5) For each affected source that is subject to permitting regulations pursuant to 40 CFR part 70 or 40 CFR part 71, and if the permitting authority has established dates for submitting semiannual reports pursuant to 40 CFR 70.6(a)(3)(iii)(A) or 40 CFR 71.6(a)(3)(iii)(A), you may submit the first and subsequent compliance reports according to the dates the permitting authority has established instead of according to the dates in paragraphs (b)(1) through (4) of this section.

(c) *Precompliance report.* You must submit a precompliance report to request approval for any of the items in paragraphs (c)(1) through (7) of this section. We will either approve or disapprove the report within 90 days after we receive it. If we disapprove the report, you must still be in compliance with the emission limitations and work practice standards in this subpart by the compliance date. To change any of the information submitted in the report, you must notify us 60 days before the planned change is to be implemented.

(1) Requests for approval to set operating limits for parameters other than those specified in §§63.2455 through 63.2485 and referenced therein. Alternatively, you may make these requests according to §63.8(f).

(2) Descriptions of daily or per batch demonstrations to verify that control devices subject to §63.2460(c)(5) are operating as designed.

(3) A description of the test conditions, data, calculations, and other information used to establish operating limits according to §63.2460(c)(3).

(4) Data and rationale used to support an engineering assessment to calculate uncontrolled emissions in accordance with §63.1257(d)(2)(ii). This requirement does not apply to calculations of hydrogen halide and halogen HAP emissions as specified in §63.2465(b), to determinations that the total HAP concentration is less than 50 ppmv, or if you use previous test data to establish the uncontrolled emissions.

(5) The pollution prevention demonstration plan required in §63.2495(c)(1), if you are complying with the pollution prevention alternative.

(6) Documentation of the practices that you will implement to minimize HAP emissions from streams that contain energetics and organic peroxides, and rationale for why meeting the emission limit specified in tables 1 through 7 to this subpart would create an undue safety hazard.

(7) For fabric filters that are monitored with bag leak detectors, an operation and maintenance plan that describes proper operation and maintenance procedures, and a corrective action plan that describes

corrective actions to be taken, and the timing of those actions, when the PM concentration exceeds the set point and activates the alarm.

(d) *Notification of compliance status report.* You must submit a notification of compliance status report according to the schedule in paragraph (d)(1) of this section, and the notification of compliance status report must contain the information specified in paragraph (d)(2) of this section.

(1) You must submit the notification of compliance status report no later than 150 days after the applicable compliance date specified in §63.2445.

(2) The notification of compliance status report must include the information in paragraphs (d)(2)(i) through (ix) of this section.

(i) The results of any applicability determinations, emission calculations, or analyses used to identify and quantify HAP usage or HAP emissions from the affected source.

(ii) The results of emissions profiles, performance tests, engineering analyses, design evaluations, flare compliance assessments, inspections and repairs, and calculations used to demonstrate initial compliance according to §§63.2455 through 63.2485. For performance tests, results must include descriptions of sampling and analysis procedures and quality assurance procedures.

(iii) Descriptions of monitoring devices, monitoring frequencies, and the operating limits established during the initial compliance demonstrations, including data and calculations to support the levels you establish.

(iv) All operating scenarios.

(v) Descriptions of worst-case operating and/or testing conditions for control devices.

(vi) Identification of parts of the affected source subject to overlapping requirements described in §63.2535 and the authority under which you will comply.

(vii) The information specified in §63.1039(a)(1) through (3) for each process subject to the work practice standards for equipment leaks in Table 6 to this subpart.

(viii) Identify storage tanks for which you are complying with the vapor balancing alternative in §63.2470(e).

(ix) Records as specified in §63.2535(l)(1) through (3) of process units used to create a PUG and calculations of the initial primary product of the PUG.

(e) *Compliance report.* The compliance report must contain the information specified in paragraphs (e)(1) through (10) of this section.

(1) Company name and address.

(2) Statement by a responsible official with that official's name, title, and signature, certifying the accuracy of the content of the report.

- (3) Date of report and beginning and ending dates of the reporting period.
- (4) For each SSM during which excess emissions occur, the compliance report must include records that the procedures specified in your startup, shutdown, and malfunction plan (SSMP) were followed or documentation of actions taken that are not consistent with the SSMP, and include a brief description of each malfunction.
- (5) The compliance report must contain the information on deviations, as defined in §63.2550, according to paragraphs (e)(5)(i), (ii), (iii), and (iv) of this section.
- (i) If there are no deviations from any emission limit, operating limit or work practice standard specified in this subpart, include a statement that there were no deviations from the emission limits, operating limits, or work practice standards during the reporting period.
- (ii) For each deviation from an emission limit, operating limit, and work practice standard that occurs at an affected source where you are not using a continuous monitoring system (CMS) to comply with the emission limit or work practice standard in this subpart, you must include the information in paragraphs (e)(5)(ii)(A) through (C) of this section. This includes periods of SSM.
- (A) The total operating time of the affected source during the reporting period.
- (B) Information on the number, duration, and cause of deviations (including unknown cause, if applicable), as applicable, and the corrective action taken.
- (C) Operating logs of processes with batch vents from batch operations for the day(s) during which the deviation occurred, except operating logs are not required for deviations of the work practice standards for equipment leaks.
- (iii) For each deviation from an emission limit or operating limit occurring at an affected source where you are using a CMS to comply with an emission limit in this subpart, you must include the information in paragraphs (e)(5)(iii)(A) through (L) of this section. This includes periods of SSM.
- (A) The date and time that each CMS was inoperative, except for zero (low-level) and high-level checks.
- (B) The date, time, and duration that each CEMS was out-of-control, including the information in §63.8(c)(8).
- (C) The date and time that each deviation started and stopped, and whether each deviation occurred during a period of startup, shutdown, or malfunction or during another period.
- (D) A summary of the total duration of the deviation during the reporting period, and the total duration as a percent of the total operating time of the affected source during that reporting period.
- (E) A breakdown of the total duration of the deviations during the reporting period into those that are due to startup, shutdown, control equipment problems, process problems, other known causes, and other unknown causes.



(F) A summary of the total duration of CMS downtime during the reporting period, and the total duration of CMS downtime as a percent of the total operating time of the affected source during that reporting period.

(G) An identification of each HAP that is known to be in the emission stream.

(H) A brief description of the process units.

(I) A brief description of the CMS.

(J) The date of the latest CMS certification or audit.

(K) Operating logs of processes with batch vents from batch operations for each day(s) during which the deviation occurred.

(L) The operating day or operating block average values of monitored parameters for each day(s) during which the deviation occurred.

(iv) If you documented in your notification of compliance status report that an MCPU has Group 2 batch process vents because the non-reactive HAP is the only HAP and usage is less than 10,000 lb/yr, the total uncontrolled organic HAP emissions from the batch process vents in an MCPU will be less than 1,000 lb/yr for the anticipated number of standard batches, or total uncontrolled hydrogen halide and halogen HAP emissions from all batch process vents and continuous process vents in a process are less than 1,000 lb/yr, include the records associated with each calculation required by §63.2525(e) that exceeds an applicable HAP usage or emissions threshold.

(6) If you use a CEMS, and there were no periods during which it was out-of-control as specified in §63.8(c)(7), include a statement that there were no periods during which the CEMS was out-of-control during the reporting period.

(7) Include each new operating scenario which has been operated since the time period covered by the last compliance report and has not been submitted in the notification of compliance status report or a previous compliance report. For each new operating scenario, you must provide verification that the operating conditions for any associated control or treatment device have not been exceeded and that any required calculations and engineering analyses have been performed. For the purposes of this paragraph, a revised operating scenario for an existing process is considered to be a new operating scenario.

(8) Records of process units added to a PUG as specified in §63.2525(i)(4) and records of primary product redeterminations as specified in §63.2525(i)(5).

(9) Applicable records and information for periodic reports as specified in referenced subparts F, G, H, SS, UU, WW, and GGG of this part and subpart F of 40 CFR part 65.

(10) *Notification of process change.* (i) Except as specified in paragraph (e)(10)(ii) of this section, whenever you make a process change, or change any of the information submitted in the notification of compliance status report or a previous compliance report, that is not within the scope of an existing operating scenario, you must document the change in your compliance report. A process change does not include moving within a range of conditions identified in the standard batch, and a nonstandard batch

does not constitute a process change. The notification must include all of the information in paragraphs (e)(10)(i)(A) through (C) of this section.

(A) A description of the process change.

(B) Revisions to any of the information reported in the original notification of compliance status report under paragraph (d) of this section.

(C) Information required by the notification of compliance status report under paragraph (d) of this section for changes involving the addition of processes or equipment at the affected source.

(ii) You must submit a report 60 days before the scheduled implementation date of any of the changes identified in paragraph (e)(10)(ii)(A), (B), or (C) of this section.

(A) Any change to the information contained in the precompliance report.

(B) A change in the status of a control device from small to large.

(C) A change from Group 2 to Group 1 for any emission point except for batch process vents that meet the conditions specified in §63.2460(b)(6)(i).

[68 FR 63888, Nov. 10, 2003, as amended at 70 FR 38560, July 1, 2005; 71 FR 40336, July 14, 2006]

[↑ Back to Top](#)

### **§63.2525 What records must I keep?**

You must keep the records specified in paragraphs (a) through (k) of this section.

(a) Each applicable record required by subpart A of this part 63 and in referenced subparts F, G, SS, UU, WW, and GGG of this part 63 and in referenced subpart F of 40 CFR part 65.

(b) Records of each operating scenario as specified in paragraphs (b)(1) through (8) of this section.

(1) A description of the process and the type of process equipment used.

(2) An identification of related process vents, including their associated emissions episodes if not complying with the alternative standard in §63.2505; wastewater point of determination (POD); storage tanks; and transfer racks.

(3) The applicable control requirements of this subpart, including the level of required control, and for vents, the level of control for each vent.

(4) The control device or treatment process used, as applicable, including a description of operating and/or testing conditions for any associated control device.

(5) The process vents, wastewater POD, transfer racks, and storage tanks (including those from other processes) that are simultaneously routed to the control device or treatment process(s).

(6) The applicable monitoring requirements of this subpart and any parametric level that assures compliance for all emissions routed to the control device or treatment process.

(7) Calculations and engineering analyses required to demonstrate compliance.

(8) For reporting purposes, a change to any of these elements not previously reported, except for paragraph (b)(5) of this section, constitutes a new operating scenario.

(c) A schedule or log of operating scenarios for processes with batch vents from batch operations updated each time a different operating scenario is put into effect.

(d) The information specified in paragraphs (d)(1) and (2) of this section for Group 1 batch process vents in compliance with a percent reduction emission limit in Table 2 to this subpart if some of the vents are controlled to less the percent reduction requirement.

(1) Records of whether each batch operated was considered a standard batch.

(2) The estimated uncontrolled and controlled emissions for each batch that is considered to be a nonstandard batch.

(e) The information specified in paragraph (e)(2), (3), or (4) of this section, as applicable, for each process with Group 2 batch process vents or uncontrolled hydrogen halide and halogen HAP emissions from the sum of all batch and continuous process vents less than 1,000 lb/yr. No records are required for situations described in paragraph (e)(1) of this section.

(1) No records are required if you documented in your notification of compliance status report that the MCPU meets any of the situations described in paragraph (e)(1)(i), (ii), or (iii) of this section.

(i) The MCPU does not process, use, or generate HAP.

(ii) You control the Group 2 batch process vents using a flare that meets the requirements of §63.987.

(iii) You control the Group 2 batch process vents using a control device for which your determination of worst case for initial compliance includes the contribution of all Group 2 batch process vents.

(2) If you documented in your notification of compliance status report that an MCPU has Group 2 batch process vents because the non-reactive organic HAP is the only HAP and usage is less than 10,000 lb/yr, as specified in §63.2460(b)(7), you must keep records of the amount of HAP material used, and calculate the daily rolling annual sum of the amount used no less frequently than monthly. If a record indicates usage exceeds 10,000 lb/yr, you must estimate emissions for the preceding 12 months based on the number of batches operated and the estimated emissions for a standard batch, and you must begin recordkeeping as specified in paragraph (e)(4) of this section. After 1 year, you may revert to recording only usage if the usage during the year is less than 10,000 lb.

(3) If you documented in your notification of compliance status report that total uncontrolled organic HAP emissions from the batch process vents in an MCPU will be less than 1,000 lb/yr for the anticipated number of standard batches, then you must keep records of the number of batches operated and calculate a daily rolling annual sum of batches operated no less frequently than monthly. If the number of batches

operated results in organic HAP emissions that exceed 1,000 lb/yr, you must estimate emissions for the preceding 12 months based on the number of batches operated and the estimated emissions for a standard batch, and you must begin recordkeeping as specified in paragraph (e)(4) of this section. After 1 year, you may revert to recording only the number of batches if the number of batches operated during the year results in less than 1,000 lb of organic HAP emissions.

(4) If you meet none of the conditions specified in paragraphs (e)(1) through (3) of this section, you must keep records of the information specified in paragraphs (e)(4)(i) through (iv) of this section.

(i) A record of the day each batch was completed and/or the operating hours per day for continuous operations with hydrogen halide and halogen emissions.

(ii) A record of whether each batch operated was considered a standard batch.

(iii) The estimated uncontrolled and controlled emissions for each batch that is considered to be a nonstandard batch.

(iv) Records of the daily 365-day rolling summations of emissions, or alternative records that correlate to the emissions (e.g., number of batches), calculated no less frequently than monthly.

(f) A record of each time a safety device is opened to avoid unsafe conditions in accordance with §63.2450(s).

(g) Records of the results of each CPMS calibration check and the maintenance performed, as specified in §63.2450(k)(1).

(h) For each CEMS, you must keep records of the date and time that each deviation started and stopped, and whether the deviation occurred during a period of startup, shutdown, or malfunction or during another period.

(i) For each PUG, you must keep records specified in paragraphs (i)(1) through (5) of this section.

(1) Descriptions of the MCPU and other process units in the initial PUG required by §63.2535(l)(1)(v).

(2) Rationale for including each MCPU and other process unit in the initial PUG (*i.e.*, identify the overlapping equipment between process units) required by §63.2535(l)(1)(v).

(3) Calculations used to determine the primary product for the initial PUG required by §63.2535(l)(2)(iv).

(4) Descriptions of process units added to the PUG after the creation date and rationale for including the additional process units in the PUG as required by §63.2535(l)(1)(v).

(5) The calculation of each primary product redetermination required by §63.2535(l)(2)(iv).

(j) In the SSMP required by §63.6(e)(3), you are not required to include Group 2 emission points, unless those emission points are used in an emissions average. For equipment leaks, the SSMP requirement is limited to control devices and is optional for other equipment.

(k) For each bag leak detector used to monitor PM HAP emissions from a fabric filter, maintain records of any bag leak detection alarm, including the date and time, with a brief explanation of the cause of the alarm and the corrective action taken.

[68 FR 63888, Nov. 10, 2003, as amended at 70 FR 38560, July 1, 2005; 71 FR 40337, July 14, 2006]

[↑ Back to Top](#)

## Other Requirements and Information

[↑ Back to Top](#)

### **§63.2535 What compliance options do I have if part of my plant is subject to both this subpart and another subpart?**

For any equipment, emission stream, or wastewater stream subject to the provisions of both this subpart and another rule, you may elect to comply only with the provisions as specified in paragraphs (a) through (l) of this section. You also must identify the subject equipment, emission stream, or wastewater stream, and the provisions with which you will comply, in your notification of compliance status report required by §63.2520(d).

(a) *Compliance with other subparts of this part 63.* (1) If you have an MCPU that includes a batch process vent that also is part of a CMPU as defined in subparts F and G of this part 63, you must comply with the emission limits; operating limits; work practice standards; and the compliance, monitoring, reporting, and recordkeeping requirements for batch process vents in this subpart, and you must continue to comply with the requirements in subparts F, G, and H of this part 63 that are applicable to the CMPU and associated equipment.

(2) After the compliance dates specified in §63.2445, at an offsite reloading or cleaning facility subject to §63.1253(f), as referenced from §63.2470(e), compliance with the monitoring, recordkeeping, and reporting provisions of any other subpart of this part 63 constitutes compliance with the monitoring, recordkeeping, and reporting provisions of §63.1253(f)(7)(ii) or §63.1253(f)(7)(iii). You must identify in your notification of compliance status report required by §63.2520(d) the subpart of this part 63 with which the owner or operator of the offsite reloading or cleaning facility complies.

(b) *Compliance with 40 CFR parts 264 and 265, subparts AA, BB, and/or CC.* (1) After the compliance dates specified in §63.2445, if a control device that you use to comply with this subpart is also subject to monitoring, recordkeeping, and reporting requirements in 40 CFR part 264, subpart AA, BB, or CC; or the monitoring and recordkeeping requirements in 40 CFR part 265, subpart AA, BB, or CC; and you comply with the periodic reporting requirements under 40 CFR part 264, subpart AA, BB, or CC that would apply to the device if your facility had final-permitted status, you may elect to comply either with the monitoring, recordkeeping, and reporting requirements of this subpart; or with the monitoring and recordkeeping requirements in 40 CFR part 264 or 265 and the reporting requirements in 40 CFR part 264, as described in this paragraph (b)(1), which constitute compliance with the monitoring, recordkeeping, and reporting requirements of this subpart. If you elect to comply with the monitoring, recordkeeping, and reporting requirements in 40 CFR parts 264 and/or 265, you must report the information described in §63.2520(e).

(2) After the compliance dates specified in §63.2445, if you have an affected source with equipment that is also subject to 40 CFR part 264, subpart BB, or to 40 CFR part 265, subpart BB, then compliance with the recordkeeping and reporting requirements of 40 CFR parts 264 and/or 265 may be used to comply with the recordkeeping and reporting requirements of this subpart, to the extent that the requirements of 40 CFR parts 264 and/or 265 duplicate the requirements of this subpart.

(c) *Compliance with 40 CFR part 60, subpart Kb and 40 CFR part 61, subpart Y.* After the compliance dates specified in §63.2445, you are in compliance with the provisions of this subpart FFFF for any storage tank that is assigned to an MCPU and that is both controlled with a floating roof and in compliance with the provisions of either 40 CFR part 60, subpart Kb, or 40 CFR part 61, subpart Y. You are in compliance with this subpart FFFF if you have a storage tank with a fixed roof, closed-vent system, and control device in compliance with the provisions of either 40 CFR part 60, subpart Kb, or 40 CFR part 61, subpart Y, except that you must comply with the monitoring, recordkeeping, and reporting requirements in this subpart FFFF. Alternatively, if a storage tank assigned to an MCPU is subject to control under 40 CFR part 60, subpart Kb, or 40 CFR part 61, subpart Y, you may elect to comply only with the requirements for Group 1 storage tanks in this subpart FFFF.

(d) *Compliance with subpart I, GGG, or MMM of this part 63.* After the compliance dates specified in §63.2445, if you have an affected source with equipment subject to subpart I, GGG, or MMM of this part 63, you may elect to comply with the provisions of subpart H, GGG, or MMM of this part 63, respectively, for all such equipment.

(e) *Compliance with subpart GGG of this part 63 for wastewater.* After the compliance dates specified in §63.2445, if you have an affected source subject to this subpart and you have an affected source that generates wastewater streams that meet the applicability thresholds specified in §63.1256, you may elect to comply with the provisions of this subpart FFFF for all such wastewater streams.

(f) *Compliance with subpart MMM of this part 63 for wastewater.* After the compliance dates specified in §63.2445, if you have an affected source subject to this subpart, and you have an affected source that generates wastewater streams that meet the applicability thresholds specified in §63.1362(d), you may elect to comply with the provisions of this subpart FFFF for all such wastewater streams (except that the 99 percent reduction requirement for streams subject to §63.1362(d)(10) still applies).

(g) *Compliance with other regulations for wastewater.* After the compliance dates specified in §63.2445, if you have a Group 1 wastewater stream that is also subject to provisions in 40 CFR parts 260 through 272, you may elect to determine whether this subpart or 40 CFR parts 260 through 272 contain the more stringent control requirements (*e.g.*, design, operation, and inspection requirements for waste management units; numerical treatment standards; etc.) and the more stringent testing, monitoring, recordkeeping, and reporting requirements. Compliance with provisions of 40 CFR parts 260 through 272 that are determined to be more stringent than the requirements of this subpart constitute compliance with this subpart. For example, provisions of 40 CFR parts 260 through 272 for treatment units that meet the conditions specified in §63.138(h) constitute compliance with this subpart. You must identify in the notification of compliance status report required by §63.2520(d) the information and procedures that you used to make any stringency determinations.

(h) *Compliance with 40 CFR part 60, subpart DDD, III, NNN, or RRR.* After the compliance dates specified in §63.2445, if you have an MCPU that contains equipment subject to the provisions of this subpart that are also subject to the provisions of 40 CFR part 60, subpart DDD, III, NNN, or RRR, you may elect to apply this subpart to all such equipment in the MCPU. If an MCPU subject to the provisions of this subpart has equipment to which this subpart does not apply but which is subject to a standard in 40 CFR part 60, subpart DDD, III, NNN, or RRR, you may elect to comply with the requirements for Group 1 process vents in this subpart for such equipment. If you elect any of these methods of compliance, you must consider all total organic compounds, minus methane and ethane, in such equipment for purposes of compliance with this subpart, as if they were organic HAP. Compliance with the provisions of this subpart, in the manner described in this paragraph (h), will constitute compliance with 40 CFR part 60, subpart DDD, III, NNN, or RRR, as applicable.

(i) *Compliance with 40 CFR part 61, subpart BB.* (1) After the compliance dates specified in §63.2445, a Group 1 transfer rack, as defined in §63.2550, that is also subject to the provisions of 40 CFR part 61, subpart BB, you are required to comply only with the provisions of this subpart.

(2) After the compliance dates specified in §63.2445, a Group 2 transfer rack, as defined in §63.2550, that is also subject to the provisions of 40 CFR part 61, subpart BB, is required to comply with the provisions of either paragraph (1)(2)(i) or (ii) of this section.

(i) If the transfer rack is subject to the control requirements specified in §61.302 of 40 CFR part 61, subpart BB, then you may elect to comply with either the requirements of 40 CFR part 61, subpart BB, or the requirements for Group 1 transfer racks under this subpart FFFF.

(ii) If the transfer rack is subject only to reporting and recordkeeping requirements under 40 CFR part 61, subpart BB, then you are required to comply only with the reporting and recordkeeping requirements specified in this subpart for Group 2 transfer racks, and you are exempt from the reporting and recordkeeping requirements in 40 CFR part 61, subpart BB.

(j) *Compliance with 40 CFR part 61, subpart FF.* After the compliance date specified in §63.2445, for a Group 1 or Group 2 wastewater stream that is also subject to the provisions of 40 CFR 61.342(c) through (h), and is not exempt under 40 CFR 61.342(c)(2) or (3), you may elect to comply only with the requirements for Group 1 wastewater streams in this subpart FFFF. If a Group 2 wastewater stream is exempted from 40 CFR 61.342(c)(1) under 40 CFR 61.342(c)(2) or (3), then you are required to comply only with the reporting and recordkeeping requirements specified in this subpart for Group 2 wastewater streams, and you are exempt from the requirements in 40 CFR part 61, subpart FF.

(k) *Compliance with 40 CFR part 60, subpart VV, and 40 CFR part 61, subpart V.* After the compliance date specified in §63.2445, if you have an affected source with equipment that is also subject to the requirements of 40 CFR part 60, subpart VV, or 40 CFR part 61, subpart V, you may elect to apply this subpart to all such equipment. After the compliance date specified in §63.2445, if you have an affected source with equipment to which this subpart does not apply, but which is subject to the requirements of 40 CFR part 60, subpart VV, or 40 CFR part 61, subpart V, you may elect to apply this subpart to all such equipment. If you elect either of these methods of compliance, you must consider all total organic compounds, minus methane and ethane, in such equipment for purposes of compliance with this subpart, as if they were organic HAP. Compliance with the provisions of this subpart, in the manner described in

this paragraph (k), will constitute compliance with 40 CFR part 60, subpart VV and 40 CFR part 61, subpart V, as applicable.

(l) *Applicability of process units included in a process unit group.* You may elect to develop and comply with the requirements for PUG in accordance with paragraphs (l)(1) through (3) of this section.

(1) *Procedures to create process unit groups.* Develop and document changes in a PUG in accordance with the procedures specified in paragraphs (l)(1)(i) through (v) of this section.

(i) Initially, identify an MCPU that is created from nondedicated equipment that will operate on or after November 10, 2003 and identify all processing equipment that is part of this MCPU, based on descriptions in operating scenarios.

(ii) Add to the group any other nondedicated MCPU and other nondedicated process units expected to be operated in the 5 years after the date specified in paragraph (l)(1)(i) of this section, provided they satisfy the criteria specified in paragraphs (l)(1)(ii)(A) through (C) of this section. Also identify all of the processing equipment used for each process unit based on information from operating scenarios and other applicable documentation.

(A) Each process unit that is added to a group must have some processing equipment that is also part of one or more process units in the group.

(B) No process unit may be part of more than one PUG.

(C) The processing equipment used to satisfy the requirement of paragraph (l)(1)(ii)(A) of this section may not be a storage tank or control device.

(iii) The initial PUG consists of all of the processing equipment for the process units identified in paragraphs (l)(1)(i) and (ii) of this section. As an alternative to the procedures specified in paragraphs (l)(1)(i) and (ii) of this section, you may use a PUG that was developed in accordance with §63.1360(h) as your initial PUG.

(iv) Add process units developed in the future in accordance with the conditions specified in paragraphs (l)(1)(ii)(A) and (B) of this section.

(v) Maintain records that describe the process units in the initial PUG, the procedure used to create the PUG, and subsequent changes to each PUG as specified in §63.2525(i). Submit the records in reports as specified in §63.2520(d)(2)(ix) and (e)(8).

(2) *Determine primary product.* You must determine the primary product of each PUG created in paragraph (l)(1) of this section according to the procedures specified in paragraphs (l)(2)(i) through (iv) of this section.

(i) The primary product is the type of product (*e.g.*, organic chemicals subject to §63.2435(b)(1), pharmaceutical products subject to §63.1250, or pesticide active ingredients subject to §63.1360) expected to be produced for the greatest operating time in the 5-year period specified in paragraph (l)(1)(ii) of this section.



(ii) If the PUG produces multiple types of products equally based on operating time, then the primary product is the type of product with the greatest production on a mass basis over the 5-year period specified in paragraph (1)(1)(ii) of this section.

(iii) At a minimum, you must redetermine the primary product of the PUG following the procedure specified in paragraphs (1)(2)(i) and (ii) of this section every 5 years.

(iv) You must record the calculation of the initial primary product determination as specified in §63.2525(i)(3) and report the results in the notification of compliance status report as specified in §63.2520(d)(8)(ix). You must record the calculation of each redetermination of the primary product as specified in §63.2525(i)(5) and report the calculation in a compliance report submitted no later than the report covering the period for the end of the 5th year after cessation of production of the previous primary product, as specified in §63.2520(e)(8).

(3) *Compliance requirements.* (i) If the primary product of the PUG is determined according to paragraph (1)(2) of this section to be material described in §63.2435(b)(1), then you must comply with this subpart for each MCPU in the PUG. You may also elect to comply with this subpart for all other process units in the PUG, which constitutes compliance with other part 63 rules.

(ii) If the primary product of the PUG is determined according to paragraph (1)(2) of this section to be material not described in §63.2435(b)(1), then you must comply with paragraph (1)(3)(ii)(A), (B), or (C) of this section, as applicable.

(A) If the primary product is subject to subpart GGG of this part 63, then comply with the requirements of subpart GGG for each MCPU in the PUG.

(B) If the primary product is subject to subpart MMM of this part 63, then comply with the requirements of subpart MMM for each MCPU in the PUG.

(C) If the primary product is subject to any subpart in this part 63 other than subpart GGG or subpart MMM, then comply with the requirements of this subpart for each MCPU in the PUG.

(iii) The requirements for new and reconstructed sources in the alternative subpart apply to all MCPU in the PUG if and only if the affected source under the alternative subpart meets the requirements for construction or reconstruction.

[68 FR 63888, Nov. 10, 2003, as amended at 71 FR 40337, July 14, 2006]

[↑ Back to Top](#)

### **§63.2540 What parts of the General Provisions apply to me?**

Table 12 to this subpart shows which parts of the General Provisions in §§63.1 through 63.15 apply to you.

[↑ Back to Top](#)

### **§63.2545 Who implements and enforces this subpart?**

(a) This subpart can be implemented and enforced by us, the U.S. Environmental Protection Agency (U.S. EPA), or a delegated authority such as your State, local, or tribal agency. If the U.S. EPA Administrator has delegated authority to your State, local, or tribal agency, then that agency also has the authority to implement and enforce this subpart. You should contact your U.S. EPA Regional Office to find out if this subpart is delegated to your State, local, or tribal agency.

(b) In delegating implementation and enforcement authority of this subpart to a State, local, or tribal agency under 40 CFR part 63, subpart E, the authorities contained in paragraphs (b)(1) through (4) of this section are retained by the Administrator of U.S. EPA and are not delegated to the State, local, or tribal agency.

(1) Approval of alternatives to the non-opacity emission limits and work practice standards in §63.2450(a) under §63.6(g).

(2) Approval of major alternatives to test methods under §63.7(e)(2)(ii) and (f) and as defined in §63.90.

(3) Approval of major alternatives to monitoring under §63.8(f) and as defined in §63.90.

(4) Approval of major alternatives to recordkeeping and reporting under §63.10(f) and as defined in §63.90.

[↑ Back to Top](#)

### **§63.2550 What definitions apply to this subpart?**

(a) For an affected source complying with the requirements in subpart SS of this part 63, the terms used in this subpart and in subpart SS of this part 63 have the meaning given them in §63.981, except as specified in §§63.2450(k)(2) and (m), 63.2470(c)(2), 63.2475(b), and paragraph (i) of this section.

(b) For an affected source complying with the requirements in 40 CFR part 65, subpart F, the terms used in this subpart and in 40 CFR part 65, subpart F have the meaning given to them in §65.2.

(c) For an affected source complying with the requirements in subpart UU of this part 63, the terms used in this subpart and in subpart UU of this part 63 have the meaning given them in §63.1020.

(d) For an affected source complying with the requirements in subpart WW of this part 63, the terms used in this subpart and subpart WW of this part 63 have the meaning given them in §63.1061, except as specified in §§63.2450(m), 63.2470(c)(2), and paragraph (i) of this section.

(e) For an affected source complying with the requirements in §§63.132 through 63.149, the terms used in this subpart and §§63.132 through 63.149 have the meaning given them in §§63.101 and 63.111, except as specified in §63.2450(m) and paragraph (i) of this section.

(f) For an affected source complying with the requirements in §§63.104 and 63.105, the terms used in this subpart and in §§63.104 and 63.105 of this subpart have the meaning given them in §63.101, except as specified in §§63.2450(m), 63.2490(b), and paragraph (i) of this section.

(g) For an affected source complying with requirements in §§63.1253, 63.1257, and 63.1258, the terms used in this subpart and in §§63.1253, 63.1257, and 63.1258 have the meaning given them in §63.1251, except as specified in §63.2450(m) and paragraph (i) of this section.

(h) For an affected source complying with the requirements in 40 CFR part 65, subpart F, the terms used in this subpart and in 40 CFR part 65, subpart F, have the meaning given them in 40 CFR 65.2.

(i) All other terms used in this subpart are defined in the Clean Air Act (CAA), in 40 CFR 63.2, and in this paragraph (i). If a term is defined in §63.2, §63.101, §63.111, §63.981, §63.1020, §63.1061, §63.1251, or §65.2 and in this paragraph (i), the definition in this paragraph (i) applies for the purposes of this subpart.

*Ancillary activities* means boilers and incinerators (not used to comply with the emission limits in Tables 1 through 7 to this subpart), chillers and refrigeration systems, and other equipment and activities that are not directly involved (*i.e.*, they operate within a closed system and materials are not combined with process fluids) in the processing of raw materials or the manufacturing of a product or isolated intermediate.

*Batch operation* means a noncontinuous operation involving intermittent or discontinuous feed into equipment, and, in general, involves the emptying of the equipment after the operation ceases and prior to beginning a new operation. Addition of raw material and withdrawal of product do not occur simultaneously in a batch operation.

*Batch process vent* means a vent from a unit operation or vents from multiple unit operations within a process that are manifolded together into a common header, through which a HAP-containing gas stream is, or has the potential to be, released to the atmosphere. Examples of batch process vents include, but are not limited to, vents on condensers used for product recovery, reactors, filters, centrifuges, and process tanks. The following are not batch process vents for the purposes of this subpart:

- (1) Continuous process vents;
- (2) Bottoms receivers;
- (3) Surge control vessels;
- (4) Gaseous streams routed to a fuel gas system(s);
- (5) Vents on storage tanks, wastewater emission sources, or pieces of equipment subject to the emission limits and work practice standards in Tables 4, 6, and 7 to this subpart;
- (6) Drums, pails, and totes;
- (7) Flexible elephant trunk systems that draw ambient air (*i.e.*, the system is not ducted, piped, or otherwise connected to the unit operations) away from operators when vessels are opened; and
- (8) Emission streams from emission episodes that are undiluted and uncontrolled containing less than 50 ppmv HAP are not part of any batch process vent. A vent from a unit operation, or a vent from multiple unit operations that are manifolded together, from which total uncontrolled HAP emissions are less than

200 lb/yr is not a batch process vent; emissions for all emission episodes associated with the unit operation(s) must be included in the determination of the total mass emitted. The HAP concentration or mass emission rate may be determined using any of the following: process knowledge that no HAP are present in the emission stream; an engineering assessment as discussed in §63.1257(d)(2)(ii), except that you do not need to demonstrate that the equations in §63.1257(d)(2)(i) do not apply, and the precompliance reporting requirements specified in §63.1257(d)(2)(ii)(E) do not apply for the purposes of this demonstration; equations specified in §63.1257(d)(2)(i), as applicable; test data using Method 18 of 40 CFR part 60, appendix A; or any other test method that has been validated according to the procedures in Method 301 of appendix A of this part.

*Biofilter* means an enclosed control system such as a tank or series of tanks with a fixed roof that contact emissions with a solid media (such as bark) and use microbiological activity to transform organic pollutants in a process vent stream to innocuous compounds such as carbon dioxide, water, and inorganic salts. Wastewater treatment processes such as aeration lagoons or activated sludge systems are not considered to be biofilters.

*Bottoms receiver* means a tank that collects bottoms from continuous distillation before the stream is sent for storage or for further downstream processing.

*Construction* means the onsite fabrication, erection, or installation of an affected source or MCPU. Addition of new equipment to an MCPU subject to existing source standards does not constitute construction, but it may constitute reconstruction of the affected source or MCPU if it satisfies the definition of reconstruction in §63.2.

*Consumption* means the quantity of all HAP raw materials entering a process in excess of the theoretical amount used as reactant, assuming 100 percent stoichiometric conversion. The raw materials include reactants, solvents, and any other additives. If a HAP is generated in the process as well as added as a raw material, consumption includes the quantity generated in the process.

*Continuous operation* means any operation that is not a batch operation.

*Continuous process vent* means the point of discharge to the atmosphere (or the point of entry into a control device, if any) of a gas stream if the gas stream has the characteristics specified in §63.107(b) through (h), or meets the criteria specified in §63.107(i), except:

(1) The reference in §63.107(e) to a chemical manufacturing process unit that meets the criteria of §63.100(b) means an MCPU that meets the criteria of §63.2435(b);

(2) The reference in §63.107(h)(4) to §63.113 means Table 1 to this subpart;

(3) The references in §63.107(h)(7) to §§63.119 and 63.126 mean tables 4 and 5 to this subpart; and

(4) For the purposes of §63.2455, all references to the characteristics of a process vent (*e.g.*, flowrate, total HAP concentration, or TRE index value) mean the characteristics of the gas stream.

(5) The reference to “total organic HAP” in §63.107(d) means “total HAP” for the purposes of this subpart FFFF.

(6) The references to an “air oxidation reactor, distillation unit, or reactor” in §63.107 mean any continuous operation for the purposes of this subpart.

(7) A separate determination is required for the emissions from each MCPU, even if emission streams from two or more MCPU are combined prior to discharge to the atmosphere or to a control device.

*Dedicated MCPU* means an MCPU that consists of equipment that is used exclusively for one process, except that storage tanks assigned to the process according to the procedures in §63.2435(d) also may be shared by other processes.

*Deviation* means any instance in which an affected source subject to this subpart, or an owner or operator of such a source:

(1) Fails to meet any requirement or obligation established by this subpart including, but not limited to, any emission limit, operating limit, or work practice standard; or

(2) Fails to meet any term or condition that is adopted to implement an applicable requirement in this subpart and that is included in the operating permit for any affected source required to obtain such a permit; or

(3) Fails to meet any emission limit, operating limit, or work practice standard in this subpart during startup, shutdown, or malfunction, regardless of whether or not such failure is permitted by this subpart.

*Emission point* means each continuous process vent, batch process vent, storage tank, transfer rack, and wastewater stream.

*Energetics* means propellants, explosives, and pyrotechnics and include materials listed at 49 CFR 172.101 as Hazard Class I Hazardous Materials, Divisions 1.1 through 1.6.

*Equipment* means each pump, compressor, agitator, pressure relief device, sampling connection system, open-ended valve or line, valve, connector, and instrumentation system in organic HAP service; and any control devices or systems used to comply with Table 6 to this subpart.

*Excess emissions* means emissions greater than those allowed by the emission limit.

*Family of materials* means a grouping of materials with the same basic composition or the same basic end use or functionality produced using the same basic feedstocks with essentially identical HAP emission profiles (primary constituent and relative magnitude on a pound per product basis) and manufacturing equipment configuration. Examples of families of materials include multiple grades of the same product or different variations of a product (*e.g.*, blue, black, and red resins).

*Group 1 batch process vent* means each of the batch process vents in a process for which the collective uncontrolled organic HAP emissions from all of the batch process vents are greater than or equal to 10,000 lb/yr at an existing source or greater than or equal to 3,000 lb/yr at a new source.

*Group 2 batch process vent* means each batch process vent that does not meet the definition of Group 1 batch process vent.

*Group 1 continuous process vent* means a continuous process vent for which the flow rate is greater than or equal to 0.005 standard cubic meter per minute, and the total resource effectiveness index value, calculated according to §63.2455(b), is less than or equal to 1.9 at an existing source and less than or equal to 5.0 at a new source.

*Group 2 continuous process vent* means a continuous process vent that does not meet the definition of a Group 1 continuous process vent.

*Group 1 storage tank* means a storage tank with a capacity greater than or equal to 10,000 gal storing material that has a maximum true vapor pressure of total HAP greater than or equal to 6.9 kilopascals at an existing source or greater than or equal to 0.69 kilopascals at a new source.

*Group 2 storage tank* means a storage tank that does not meet the definition of a Group 1 storage tank.

*Group 1 transfer rack* means a transfer rack that loads more than 0.65 million liters/year of liquids that contain organic HAP with a rack-weighted average partial pressure, as defined in §63.111, greater than or equal to 1.5 pound per square inch absolute.

*Group 2 transfer rack* means a transfer rack that does not meet the definition of a Group 1 transfer rack.

*Group 1 wastewater stream* means a wastewater stream consisting of process wastewater at an existing or new source that meets the criteria for Group 1 status in §63.2485(c) for compounds in Tables 8 and 9 to this subpart and/or a wastewater stream consisting of process wastewater at a new source that meets the criteria for Group 1 status in §63.132(d) for compounds in Table 8 to subpart G of this part 63.

*Group 2 wastewater stream* means any process wastewater stream that does not meet the definition of a Group 1 wastewater stream.

*Halogen atoms* mean chlorine and fluorine.

*Halogenated vent stream* means a vent stream determined to have a mass emission rate of halogen atoms contained in organic compounds of 0.45 kilograms per hour or greater determined by the procedures presented in §63.115(d)(2)(v).

*HAP metals* means the metal portion of antimony compounds, arsenic compounds, beryllium compounds, cadmium compounds, chromium compounds, cobalt compounds, lead compounds, manganese compounds, mercury compounds, nickel compounds, and selenium compounds.

*Hydrogen halide and halogen HAP* means hydrogen chloride, hydrogen fluoride, and chlorine.

*In organic HAP service* means that a piece of equipment either contains or contacts a fluid (liquid or gas) that is at least 5 percent by weight of total organic HAP as determined according to the provisions of §63.180(d). The provisions of §63.180(d) also specify how to determine that a piece of equipment is not in organic HAP service.

*Isolated intermediate* means a product of a process that is stored before subsequent processing. An isolated intermediate is usually a product of a chemical synthesis, fermentation, or biological extraction process. Storage of an isolated intermediate marks the end of a process. Storage occurs at any time the

intermediate is placed in equipment used solely for storage. The storage equipment is part of the MCPU that produces the isolated intermediate and is not assigned as specified in §63.2435(d).

*Large control device* means a control device that controls total HAP emissions of greater than or equal to 10 tpy, before control.

*Maintenance wastewater* means wastewater generated by the draining of process fluid from components in the MCPU into an individual drain system in preparation for or during maintenance activities. Maintenance wastewater can be generated during planned and unplanned shutdowns and during periods not associated with a shutdown. Examples of activities that can generate maintenance wastewater include descaling of heat exchanger tubing bundles, cleaning of distillation column traps, draining of pumps into an individual drain system, and draining of portions of the MCPU for repair. Wastewater from routine cleaning operations occurring as part of batch operations is not considered maintenance wastewater.

*Maximum true vapor pressure* has the meaning given in §63.111, except that it applies to all HAP rather than only organic HAP.

*Miscellaneous organic chemical manufacturing process* means all equipment which collectively function to produce a product or isolated intermediate that are materials described in §63.2435(b). For the purposes of this subpart, process includes any, all or a combination of reaction, recovery, separation, purification, or other activity, operation, manufacture, or treatment which are used to produce a product or isolated intermediate. A process is also defined by the following:

- (1) Routine cleaning operations conducted as part of batch operations are considered part of the process;
- (2) Each nondedicated solvent recovery operation is considered a single process;
- (3) Each nondedicated formulation operation is considered a single process that is used to formulate numerous materials and/or products;
- (4) Quality assurance/quality control laboratories are not considered part of any process; and
- (5) Ancillary activities are not considered a process or part of any process.
- (6) The end of a process that produces a solid material is either up to and including the dryer or extruder, or for a polymer production process without a dryer or extruder, it is up to and including the extruder, die plate, or solid-state reactor, except in two cases. If the dryer, extruder, die plate, or solid-state reactor is followed by an operation that is designed and operated to remove HAP solvent or residual HAP monomer from the solid, then the solvent removal operation is the last step in the process. If the dried solid is diluted or mixed with a HAP-based solvent, then the solvent removal operation is the last step in the process.

*Nondedicated solvent recovery operation* means a distillation unit or other purification equipment that receives used solvent from more than one MCPU.

*Nonstandard batch* means a batch process that is operated outside of the range of operating conditions that are documented in an existing operating scenario but is still a reasonably anticipated event. For example, a nonstandard batch occurs when additional processing or processing at different operating

conditions must be conducted to produce a product that is normally produced under the conditions described by the standard batch. A nonstandard batch may be necessary as a result of a malfunction, but it is not itself a malfunction.

*On-site or on site* means, with respect to records required to be maintained by this subpart or required by another subpart referenced by this subpart, that records are stored at a location within a major source which encompasses the affected source. On-site includes, but is not limited to, storage at the affected source or MCPU to which the records pertain, or storage in central files elsewhere at the major source.

*Operating scenario* means, for the purposes of reporting and recordkeeping, any specific operation of an MCPU as described by records specified in §63.2525(b).

*Organic group* means structures that contain primarily carbon, hydrogen, and oxygen atoms.

*Organic peroxides* means organic compounds containing the bivalent -o-o-structure which may be considered to be a structural derivative of hydrogen peroxide where one or both of the hydrogen atoms has been replaced by an organic radical.

*Point of determination* means each point where process wastewater exits the MCPU or control device.

Note to definition for point of determination: The regulation allows determination of the characteristics of a wastewater stream: At the point of determination; or downstream of the point of determination if corrections are made for changes in flow rate and annual average concentration of soluble HAP and partially soluble HAP compounds as determined according to procedures in §63.144 of subpart G in this part 63. Such changes include losses by air emissions; reduction of annual average concentration or changes in flow rate by mixing with other water or wastewater streams; and reduction in flow rate or annual average concentration by treating or otherwise handling the wastewater stream to remove or destroy HAP.

*Predominant HAP* means as used in calibrating an analyzer, the single organic HAP that constitutes the largest percentage of the total organic HAP in the analyzed gas stream, by volume.

*Process condenser* means a condenser whose primary purpose is to recover material as an integral part of an MCPU. All condensers recovering condensate from an MCPU at or above the boiling point or all condensers in line prior to a vacuum source are considered process condensers. Typically, a primary condenser or condensers in series are considered to be integral to the MCPU if they are capable of and normally used for the purpose of recovering chemicals for fuel value (i.e., net positive heating value), use, reuse or for sale for fuel value, use, or reuse. This definition does not apply to a condenser that is used to remove materials that would hinder performance of a downstream recovery device as follows:

- (1) To remove water vapor that would cause icing in a downstream condenser, or
- (2) To remove water vapor that would negatively affect the adsorption capacity of carbon in a downstream carbon adsorber, or
- (3) To remove high molecular weight organic compounds or other organic compounds that would be difficult to remove during regeneration of a downstream carbon adsorber.



*Process tank* means a tank or vessel that is used within a process to collect material discharged from a feedstock storage tank or equipment within the process before the material is transferred to other equipment within the process or a product storage tank. A process tank has emissions that are related to the characteristics of the batch cycle, and it does not accumulate product over multiple batches. Surge control vessels and bottoms receivers are not process tanks.

*Production-indexed HAP consumption factor (HAP factor)* means the result of dividing the annual consumption of total HAP by the annual production rate, per process.

*Production-indexed VOC consumption factor (VOC factor)* means the result of dividing the annual consumption of total VOC by the annual production rate, per process.

*Quaternary ammonium compounds* means a type of organic nitrogen compound in which the molecular structure includes a central nitrogen atom joined to four organic groups as well as an acid radical of some sort.

*Recovery device* means an individual unit of equipment used for the purpose of recovering chemicals from process vent streams and from wastewater streams for fuel value (i.e., net positive heating value), use, reuse, or for sale for fuel value, use, or reuse. For the purposes of meeting requirements in table 2 to this subpart, the recovery device must not be a process condenser and must recover chemicals to be reused in a process on site. Examples of equipment that may be recovery devices include absorbers, carbon adsorbers, condensers, oil-water separators or organic-water separators, or organic removal devices such as decanters, strippers, or thin-film evaporation units. To be a recovery device for a wastewater stream, a decanter and any other equipment based on the operating principle of gravity separation must receive only multi-phase liquid streams.

*Responsible official* means responsible official as defined in 40 CFR 70.2.

*Safety device* means a closure device such as a pressure relief valve, frangible disc, fusible plug, or any other type of device which functions exclusively to prevent physical damage or permanent deformation to a unit or its air emission control equipment by venting gases or vapors directly to the atmosphere during unsafe conditions resulting from an unplanned, accidental, or emergency event. For the purposes of this subpart, a safety device is not used for routine venting of gases or vapors from the vapor headspace underneath a cover such as during filling of the unit or to adjust the pressure in response to normal daily diurnal ambient temperature fluctuations. A safety device is designed to remain in a closed position during normal operations and open only when the internal pressure, or another relevant parameter, exceeds the device threshold setting applicable to the air emission control equipment as determined by the owner or operator based on manufacturer recommendations, applicable regulations, fire protection and prevention codes and practices, or other requirements for the safe handling of flammable, combustible, explosive, reactive, or hazardous materials.

*Shutdown* means the cessation of operation of a continuous operation for any purpose. Shutdown also means the cessation of a batch operation, or any related individual piece of equipment required or used to comply with this subpart, if the steps taken to cease operation differ from those described in a standard batch or nonstandard batch. Shutdown also applies to emptying and degassing storage vessels. Shutdown

does not apply to cessation of batch operations at the end of a campaign or between batches within a campaign when the steps taken are routine operations.

*Small control device* means a control device that controls total HAP emissions of less than 10 tpy, before control.

*Standard batch* means a batch process operated within a range of operating conditions that are documented in an operating scenario. Emissions from a standard batch are based on the operating conditions that result in highest emissions. The standard batch defines the uncontrolled and controlled emissions for each emission episode defined under the operating scenario.

*Startup* means the setting in operation of a continuous operation for any purpose; the first time a new or reconstructed batch operation begins production; for new equipment added, including equipment required or used to comply with this subpart, the first time the equipment is put into operation; or for the introduction of a new product/process, the first time the product or process is run in equipment. For batch operations, startup applies to the first time the equipment is put into operation at the start of a campaign to produce a product that has been produced in the past if the steps taken to begin production differ from those specified in a standard batch or nonstandard batch. Startup does not apply when the equipment is put into operation as part of a batch within a campaign when the steps taken are routine operations.

*Storage tank* means a tank or other vessel that is used to store liquids that contain organic HAP and/or hydrogen halide and halogen HAP and that has been assigned to an MCPU according to the procedures in §63.2435(d). The following are not considered storage tanks for the purposes of this subpart:

- (1) Vessels permanently attached to motor vehicles such as trucks, railcars, barges, or ships;
- (2) Pressure vessels designed to operate in excess of 204.9 kilopascals and without emissions to the atmosphere;
- (3) Vessels storing organic liquids that contain HAP only as impurities;
- (4) Wastewater storage tanks;
- (5) Bottoms receivers;
- (6) Surge control vessels; and
- (7) Process tanks.

*Supplemental gases* means the air that is added to a vent stream after the vent stream leaves the unit operation. Air that is part of the vent stream as a result of the nature of the unit operation is not considered supplemental gases. Air required to operate combustion device burner(s) is not considered supplemental gases.

*Surge control vessel* means feed drums, recycle drums, and intermediate vessels as part of any continuous operation. Surge control vessels are used within an MCPU when in-process storage, mixing, or management of flowrates or volumes is needed to introduce material into continuous operations.

*Total organic compounds or (TOC)* means the total gaseous organic compounds (minus methane and ethane) in a vent stream.

*Transfer rack* means the collection of loading arms and loading hoses, at a single loading rack, that are assigned to an MCPU according to the procedures specified in §63.2435(d) and are used to fill tank trucks and/or rail cars with organic liquids that contain one or more of the organic HAP listed in section 112(b) of the CAA of this subpart. Transfer rack includes the associated pumps, meters, shutoff valves, relief valves, and other piping and valves.

*Unit operation* means those processing steps that occur within distinct equipment that are used, among other things, to prepare reactants, facilitate reactions, separate and purify products, and recycle materials. Equipment used for these purposes includes, but is not limited to, reactors, distillation columns, extraction columns, absorbers, decanters, dryers, condensers, and filtration equipment.

*Waste management unit* means the equipment, structure(s), and/or device(s) used to convey, store, treat, or dispose of wastewater streams or residuals. Examples of waste management units include wastewater tanks, air flotation units, surface impoundments, containers, oil-water or organic-water separators, individual drain systems, biological wastewater treatment units, waste incinerators, and organic removal devices such as steam and air stripper units, and thin film evaporation units. If such equipment is being operated as a recovery device, then it is part of a miscellaneous organic chemical manufacturing process and is not a waste management unit.

*Wastewater* means water that is discarded from an MCPU or control device through a POD and that contains either: an annual average concentration of compounds in tables 8 and 9 to this subpart of at least 5 ppmw and has an annual average flowrate of 0.02 liters per minute or greater; or an annual average concentration of compounds in tables 8 and 9 to this subpart of at least 10,000 ppmw at any flowrate. Wastewater means process wastewater or maintenance wastewater. The following are not considered wastewater for the purposes of this subpart:

- (1) Stormwater from segregated sewers;
- (2) Water from fire-fighting and deluge systems, including testing of such systems;
- (3) Spills;
- (4) Water from safety showers;
- (5) Samples of a size not greater than reasonably necessary for the method of analysis that is used;
- (6) Equipment leaks;
- (7) Wastewater drips from procedures such as disconnecting hoses after cleaning lines; and
- (8) Noncontact cooling water.

*Wastewater stream* means a stream that contains only wastewater as defined in this paragraph (i).

*Work practice standard* means any design, equipment, work practice, or operational standard, or combination thereof, that is promulgated pursuant to section 112(h) of the CAA.

[68 FR 63888, Nov. 10, 2003, as amended at 70 FR 38560, July 1, 2005; 71 FR 40338, July 14, 2006]

[↑ Back to Top](#)

**Table 1 to Subpart FFFF of Part 63—Emission Limits and Work Practice Standards for Continuous Process Vents**

As required in §63.2455, you must meet each emission limit and work practice standard in the following table that applies to your continuous process vents:

For each . . .	For which . . .	Then you must . . .
1. Group 1 continuous process vent	a. Not applicable	i. Reduce emissions of total organic HAP by $\geq 98$ percent by weight or to an outlet process concentration $\leq 20$ ppmv as organic HAP or TOC by venting emissions through a closed-vent system to any combination of control devices (except a flare); or
		ii. Reduce emissions of total organic HAP by venting emissions through a closed vent system to a flare; or
		iii. Use a recovery device to maintain the TRE above 1.9 for an existing source or above 5.0 for a new source.
2. Halogenated Group 1 continuous process vent stream	a. You use a combustion control device to control organic HAP emissions	i. Use a halogen reduction device after the combustion device to reduce emissions of hydrogen halide and halogen HAP by $\geq 99$ percent by weight, or to $\leq 0.45$ kg/hr, or to $\leq 20$ ppmv; or ii. Use a halogen reduction device before the combustion device to reduce the halogen atom mass emission rate to $\leq 0.45$ kg/hr or to a concentration $\leq 20$ ppmv.
3. Group 2 continuous process vent at an existing source	You use a recovery device to maintain the TRE level $> 1.9$ but $\leq 5.0$	Comply with the requirements in §63.993 and the requirements referenced therein.
4. Group 2 continuous process vent at a new source	You use a recovery device to maintain the TRE level $> 5.0$ but $\leq 8.0$	Comply with the requirements in §63.993 and the requirements referenced therein.

[↑ Back to Top](#)

**Table 2 to Subpart FFFF of Part 63—Emission Limits and Work Practice Standards for Batch Process Vents**

As required in §63.2460, you must meet each emission limit and work practice standard in the following table that applies to your batch process vents:

For each . . .	Then you must . . .	And you must . . .
1. Process with Group 1 batch process vents	a. Reduce collective uncontrolled organic HAP emissions from the sum of all batch process vents within the process by $\geq 98$ percent by weight by venting emissions from a sufficient number of the vents through one or more closed-vent systems to any combination of control devices (except a flare); or	Not applicable.
	b. Reduce collective uncontrolled organic HAP emissions from the sum of all batch process vents within the process by $\geq 95$ percent by weight by venting emissions from a sufficient number of the vents through one or more closed-vent systems to any combination of recovery devices or a biofilter, except you may elect to comply with the requirements of subpart WW of this part for any process tank; or	Not applicable.
	c. Reduce uncontrolled organic HAP emissions from one or more batch process vents within the process by venting through a closed-vent system to a flare or by venting through one or more closed-vent systems to any combination of control devices (excluding a flare) that reduce organic HAP to an outlet concentration $\leq 20$ ppmv as TOC or total organic HAP.	For all other batch process vents within the process, reduce collective organic HAP emissions as specified in item 1.a and/or item 1.b of this table.
2. Halogenated Group 1 batch process vent for which you use a combustion device to control organic HAP emissions	a. Use a halogen reduction device after the combustion control device; or	i. Reduce overall emissions of hydrogen halide and halogen HAP by $\geq 99$ percent; or ii. Reduce overall emissions of hydrogen halide and halogen HAP to $\leq 0.45$ kg/hr; or

		iii. Reduce overall emissions of hydrogen halide and halogen HAP to a concentration $\leq 20$ ppmv.
	b. Use a halogen reduction device before the combustion control device	Reduce the halogen atom mass emission rate to $\leq 0.45$ kg/hr or to a concentration $\leq 20$ ppmv.

[68 FR 63888, Nov. 10, 2003, as amended at 71 FR 40339, July 14, 2006]

[↑ Back to Top](#)

**Table 3 to Subpart FFFF of Part 63—Emission Limits for Hydrogen Halide and Halogen HAP Emissions or HAP Metals Emissions From Process Vents**

As required in §63.2465, you must meet each emission limit in the following table that applies to your process vents that contain hydrogen halide and halogen HAP emissions or PM HAP emissions:

<b>For each . . .</b>	<b>You must . . .</b>
1. Process with uncontrolled hydrogen halide and halogen HAP emissions from process vents $\geq 1,000$ lb/yr	a. Reduce collective hydrogen halide and halogen HAP emissions by $\geq 99$ percent by weight or to an outlet concentration $\leq 20$ ppmv by venting through one or more closed-vent systems to any combination of control devices, or
	b. Reduce the halogen atom mass emission rate from the sum of all batch process vents and each individual continuous process vent to $\leq 0.45$ kg/hr by venting through one or more closed-vent systems to a halogen reduction device.
2. Process at a new source with uncontrolled emissions from process vents $\geq 150$ lb/yr of HAP metals	Reduce overall emissions of HAP metals by $\geq 97$ percent by weight.

[68 FR 63888, Nov. 10, 2003, as amended at 71 FR 40340, July 14, 2006]

[↑ Back to Top](#)

**Table 4 to Subpart FFFF of Part 63—Emission Limits for Storage Tanks**

As required in §63.2470, you must meet each emission limit in the following table that applies to your storage tanks:

<b>For each . . .</b>	<b>For which . . .</b>	<b>Then you must . . .</b>
1. Group 1 storage tank	a. The maximum true vapor pressure of total HAP at the storage temperature is $\geq 76.6$ kilopascals	i. Reduce total HAP emissions by $\geq 95$ percent by weight or to $\leq 20$ ppmv of TOC or organic HAP and $\leq 20$ ppmv of hydrogen halide and halogen HAP by venting emissions through a closed vent system to any combination of control devices (excluding a flare); or
		ii. Reduce total organic HAP emissions by venting emissions through a closed vent system to a flare; or
		iii. Reduce total HAP emissions by venting emissions to a fuel gas system or process in accordance with §63.982(d) and the requirements referenced therein.
	b. The maximum true vapor pressure of total HAP at the storage temperature is $< 76.6$ kilopascals	i. Comply with the requirements of subpart WW of this part, except as specified in §63.2470; or
ii. Reduce total HAP emissions by $\geq 95$ percent by weight or to $\leq 20$ ppmv of TOC or organic HAP and $\leq 20$ ppmv of hydrogen halide and halogen HAP by venting emissions through a closed vent system to any combination of control devices (excluding a flare); or		
iii. Reduce total organic HAP emissions by venting emissions through a closed vent system to a flare; or		
iv. Reduce total HAP emissions by venting emissions to a fuel gas system or process in accordance with §63.982(d) and the requirements referenced therein.		
2. Halogenated vent stream from a Group 1 storage tank	You use a combustion control device to control organic HAP emissions	Meet one of the emission limit options specified in Item 2.a.i or ii. in Table 1 to this subpart.

[68 FR 63888, Nov. 10, 2003, as amended at 71 FR 40340, July 14, 2006]

[↑ Back to Top](#)

**Table 5 to Subpart FFFF of Part 63—Emission Limits and Work Practice Standards for Transfer Racks**

As required in §63.2475, you must meet each emission limit and work practice standard in the following table that applies to your transfer racks:

<b>For each . . .</b>	<b>You must . . .</b>
1. Group 1 transfer rack	a. Reduce emissions of total organic HAP by $\geq 98$ percent by weight or to an outlet concentration $\leq 20$ ppmv as organic HAP or TOC by venting emissions through a closed-vent system to any combination of control devices (except a flare); or
	b. Reduce emissions of total organic HAP by venting emissions through a closed-vent system to a flare; or
	c. Reduce emissions of total organic HAP by venting emissions to a fuel gas system or process in accordance with §63.982(d) and the requirements referenced therein; or
	d. Use a vapor balancing system designed and operated to collect organic HAP vapors displaced from tank trucks and railcars during loading and route the collected HAP vapors to the storage tank from which the liquid being loaded originated or to another storage tank connected by a common header.
2. Halogenated Group 1 transfer rack vent stream for which you use a combustion device to control organic HAP emissions	a. Use a halogen reduction device after the combustion device to reduce emissions of hydrogen halide and halogen HAP by $\geq 99$ percent by weight, to $\leq 0.45$ kg/hr, or to $\leq 20$ ppmv; or b. Use a halogen reduction device before the combustion device to reduce the halogen atom mass emission rate to $\leq 0.45$ kg/hr or to a concentration $\leq 20$ ppmv.

[68 FR 63888, Nov. 10, 2003, as amended at 71 FR 40341, July 14, 2006]

[↑ Back to Top](#)

**Table 6 to Subpart FFFF of Part 63—Requirements for Equipment Leaks**

As required in §63.2480, you must meet each requirement in the following table that applies to your equipment leaks:

<b>For all . . .</b>	<b>And that is part of . . .</b>	<b>You must . . .</b>



1. Equipment that is in organic HAP service	a. Comply with the requirements of subpart UU of this part 63 and the requirements referenced therein, except as specified in §63.2480(b) and (d); or	
	b. Comply with the requirements of subpart H of this part 63 and the requirements referenced therein, except as specified in §63.2480(b) and (d); or	
	c. Comply with the requirements of 40 CFR part 65, subpart F and the requirements referenced therein, except as specified in §63.2480(c) and (d).	
2. Equipment that is in organic HAP service at a new source	a. Any MCPU	i. Comply with the requirements of subpart UU of this part 63 and the requirements referenced therein; or ii. Comply with the requirements of 40 CFR part 65, subpart F.

[68 FR 63888, Nov. 10, 2003, as amended at 71 FR 40341, July 14, 2006]

[↑ Back to Top](#)

**Table 7 to Subpart FFFF of Part 63—Requirements for Wastewater Streams and Liquid Streams in Open Systems Within an MCPU**

As required in §63.2485, you must meet each requirement in the following table that applies to your wastewater streams and liquid streams in open systems within an MCPU:

<b>For each . . .</b>	<b>You must . . .</b>
1. Process wastewater stream	Comply with the requirements in §§63.132 through 63.148 and the requirements referenced therein, except as specified in §63.2485.
2. Maintenance wastewater stream	Comply with the requirements in §63.105 and the requirements referenced therein, except as specified in §63.2485.
3. Liquid streams in an open system within an MCPU	Comply with the requirements in §63.149 and the requirements referenced therein, except as specified in §63.2485.

[↑ Back to Top](#)

**Table 8 to Subpart FFFF of Part 63—Partially Soluble Hazardous Air Pollutants**

As specified in §63.2485, the partially soluble HAP in wastewater that are subject to management and treatment requirements in this subpart FFFF are listed in the following table:

<b>Chemical name . . .</b>	<b>CAS No.</b>
1. 1,1,1-Trichloroethane (methyl chloroform)	71556
2. 1,1,2,2-Tetrachloroethane	79345
3. 1,1,2-Trichloroethane	79005
4. 1,1-Dichloroethylene (vinylidene chloride)	75354
5. 1,2-Dibromoethane	106934
6. 1,2-Dichloroethane (ethylene dichloride)	107062
7. 1,2-Dichloropropane	78875
8. 1,3-Dichloropropene	542756
9. 2,4,5-Trichlorophenol	95954
10. 1,4-Dichlorobenzene	106467
11. 2-Nitropropane	79469
12. 4-Methyl-2-pentanone (MIBK)	108101
13. Acetaldehyde	75070
14. Acrolein	107028
15. Acrylonitrile	107131
16. Allyl chloride	107051
17. Benzene	71432

18. Benzyl chloride	100447
19. Biphenyl	92524
20. Bromoform (tribromomethane)	75252
21. Bromomethane	74839
22. Butadiene	106990
23. Carbon disulfide	75150
24. Chlorobenzene	108907
25. Chloroethane (ethyl chloride)	75003
26. Chloroform	67663
27. Chloromethane	74873
28. Chloroprene	126998
29. Cumene	98828
30. Dichloroethyl ether	111444
31. Dinitrophenol	51285
32. Epichlorohydrin	106898
33. Ethyl acrylate	140885
34. Ethylbenzene	100414
35. Ethylene oxide	75218
36. Ethylidene dichloride	75343
37. Hexachlorobenzene	118741

38. Hexachlorobutadiene	87683
39. Hexachloroethane	67721
40. Methyl methacrylate	80626
41. Methyl-t-butyl ether	1634044
42. Methylene chloride	75092
43. N-hexane	110543
44. N,N-dimethylaniline	121697
45. Naphthalene	91203
46. Phosgene	75445
47. Propionaldehyde	123386
48. Propylene oxide	75569
49. Styrene	100425
50. Tetrachloroethylene (perchloroethylene)	127184
51. Tetrachloromethane (carbon tetrachloride)	56235
52. Toluene	108883
53. Trichlorobenzene (1,2,4-)	120821
54. Trichloroethylene	79016
55. Trimethylpentane	540841
56. Vinyl acetate	108054
57. Vinyl chloride	75014

58. Xylene (m)	108383
59. Xylene (o)	95476
60. Xylene (p)	106423

[68 FR 63888, Nov. 10, 2003, as amended at 70 FR 38560, July 1, 2005; 71 FR 40341, July 14, 2006]

[↑ Back to Top](#)

**Table 9 to Subpart FFFF of Part 63—Soluble Hazardous Air Pollutants**

As specified in §63.2485, the soluble HAP in wastewater that are subject to management and treatment requirements of this subpart FFFF are listed in the following table:

<b>Chemical name . . .</b>	<b>CAS No.</b>
1. Acetonitrile	75058
2. Acetophenone	98862
3. Diethyl sulfate	64675
4. Dimethyl hydrazine (1,1)	57147
5. Dimethyl sulfate	77781
6. Dinitrotoluene (2,4)	121142
7. Dioxane (1,4)	123911
8. Ethylene glycol dimethyl ether	110714
9. Ethylene glycol monobutyl ether acetate	112072
10. Ethylene glycol monomethyl ether acetate	110496
11. Isophorone	78591
12. Methanol	67561

13. Nitrobenzene	98953
14. Tolidine (o-)	95534
15. Triethylamine	121448

[68 FR 63888, Nov. 10, 2003, as amended at 70 FR 38561, July 1, 2005]

[↑ Back to Top](#)

**Table 10 to Subpart FFFF of Part 63—Work Practice Standards for Heat Exchange Systems**

As required in §63.2490, you must meet each requirement in the following table that applies to your heat exchange systems:

<b>For each . . .</b>	<b>You must . . .</b>
Heat exchange system, as defined in §63.101	Comply with the requirements of §63.104 and the requirements referenced therein, except as specified in §63.2490.

[↑ Back to Top](#)

**Table 11 to Subpart FFFF of Part 63—Requirements for Reports**

As required in §63.2520(a) and (b), you must submit each report that applies to you on the schedule shown in the following table:

<b>You must submit a(n)</b>	<b>The report must contain . . .</b>	<b>You must submit the report . . .</b>
1. Precompliance report	The information specified in §63.2520(c)	At least 6 months prior to the compliance date; or for new sources, with the application for approval of construction or reconstruction.
2. Notification of compliance status report	The information specified in §63.2520(d)	No later than 150 days after the compliance date specified in §63.2445.
3. Compliance report	The information specified in §63.2520(e)	Semiannually according to the requirements in §63.2520(b).

[↑ Back to Top](#)

**Table 12 to Subpart FFFF of Part 63—Applicability of General Provisions to Subpart FFFF**

As specified in §63.2540, the parts of the General Provisions that apply to you are shown in the following table:

<b>Citation</b>	<b>Subject</b>	<b>Explanation</b>
§63.1	Applicability	Yes.
§63.2	Definitions	Yes.
§63.3	Units and Abbreviations	Yes.
§63.4	Prohibited Activities	Yes.
§63.5	Construction/Reconstruction	Yes.
§63.6(a)	Applicability	Yes.
§63.6(b)(1)-(4)	Compliance Dates for New and Reconstructed sources	Yes.
§63.6(b)(5)	Notification	Yes.
§63.6(b)(6)	[Reserved]	
§63.6(b)(7)	Compliance Dates for New and Reconstructed Area Sources That Become Major	Yes.
§63.6(c)(1)-(2)	Compliance Dates for Existing Sources	Yes.
§63.6(c)(3)-(4)	[Reserved]	
§63.6(c)(5)	Compliance Dates for Existing Area Sources That Become Major	Yes
§63.6(d)	[Reserved]	

§63.6(e)(1)-(2)	Operation & Maintenance	Yes.
§63.6(e)(3)(i), (ii), and (v) through (viii)	Startup, Shutdown, Malfunction Plan (SSMP)	Yes, except information regarding Group 2 emission points and equipment leaks is not required in the SSMP, as specified in §63.2525(j).
§63.6(e)(3)(iii) and (iv)	Recordkeeping and Reporting During SSM	No, §63.998(d)(3) and 63.998(c)(1)(ii)(D) through (G) specify the recordkeeping requirement for SSM events, and §63.2520(e)(4) specifies reporting requirements.
§63.6(e)(3)(ix)	SSMP incorporation into title V permit	Yes.
§63.6(f)(1)	Compliance Except During SSM	Yes.
§63.6(f)(2)-(3)	Methods for Determining Compliance	Yes.
§63.6(g)(1)-(3)	Alternative Standard	Yes.
§63.6(h)	Opacity/Visible Emission (VE) Standards	Only for flares for which Method 22 observations are required as part of a flare compliance assessment.
§63.6(i)(1)-(14)	Compliance Extension	Yes.
§63.6(j)	Presidential Compliance Exemption	Yes.
§63.7(a)(1)-(2)	Performance Test Dates	Yes, except substitute 150 days for 180 days.
§63.7(a)(3)	Section 114 Authority	Yes, and this paragraph also applies to flare compliance assessments as specified under §63.997(b)(2).
§63.7(b)(1)	Notification of Performance Test	Yes.
§63.7(b)(2)	Notification of Rescheduling	Yes.



§63.7(c)	Quality Assurance/Test Plan	Yes, except the test plan must be submitted with the notification of the performance test if the control device controls batch process vents.
§63.7(d)	Testing Facilities	Yes.
§63.7(e)(1)	Conditions for Conducting Performance Tests	Yes, except that performance tests for batch process vents must be conducted under worst-case conditions as specified in §63.2460.
§63.7(e)(2)	Conditions for Conducting Performance Tests	Yes.
§63.7(e)(3)	Test Run Duration	Yes.
§63.7(f)	Alternative Test Method	Yes.
§63.7(g)	Performance Test Data Analysis	Yes.
§63.7(h)	Waiver of Tests	Yes.
§63.8(a)(1)	Applicability of Monitoring Requirements	Yes.
§63.8(a)(2)	Performance Specifications	Yes.
§63.8(a)(3)	[Reserved]	
§63.8(a)(4)	Monitoring with Flares	Yes.
§63.8(b)(1)	Monitoring	Yes.
§63.8(b)(2)-(3)	Multiple Effluents and Multiple Monitoring Systems	Yes.
§63.8(c)(1)	Monitoring System Operation and Maintenance	Yes.
§63.8(c)(1)(i)	Routine and Predictable SSM	Yes.

§63.8(c)(1)(ii)	SSM not in SSMP	Yes.
§63.8(c)(1)(iii)	Compliance with Operation and Maintenance Requirements	Yes.
§63.8(c)(2)-(3)	Monitoring System Installation	Yes.
§63.8(c)(4)	CMS Requirements	Only for CEMS. Requirements for CPMS are specified in referenced subparts G and SS of part 63. Requirements for COMS do not apply because subpart FFFF does not require continuous opacity monitoring systems (COMS).
§63.8(c)(4)(i)	COMS Measurement and Recording Frequency	No; subpart FFFF does not require COMS.
§63.8(c)(4)(ii)	CEMS Measurement and Recording Frequency	Yes.
§63.8(c)(5)	COMS Minimum Procedures	No. Subpart FFFF does not contain opacity or VE limits.
§63.8(c)(6)	CMS Requirements	Only for CEMS; requirements for CPMS are specified in referenced subparts G and SS of this part 63. Requirements for COMS do not apply because subpart FFFF does not require COMS.
§63.8(c)(7)-(8)	CMS Requirements	Only for CEMS. Requirements for CPMS are specified in referenced subparts G and SS of part 63. Requirements for COMS do not apply because subpart FFFF does not require COMS.
§63.8(d)	CMS Quality Control	Only for CEMS.
§63.8(e)	CMS Performance Evaluation	Only for CEMS. Section 63.8(e)(5)(ii) does not apply because subpart FFFF does not require COMS.
§63.8(f)(1)-(5)	Alternative Monitoring Method	Yes, except you may also request approval using the precompliance report.

§63.8(f)(6)	Alternative to Relative Accuracy Test	Only applicable when using CEMS to demonstrate compliance, including the alternative standard in §63.2505.
§63.8(g)(1)-(4)	Data Reduction	Only when using CEMS, including for the alternative standard in §63.2505, except that the requirements for COMS do not apply because subpart FFFF has no opacity or VE limits, and §63.8(g)(2) does not apply because data reduction requirements for CEMS are specified in §63.2450(j).
§63.8(g)(5)	Data Reduction	No. Requirements for CEMS are specified in §63.2450(j). Requirements for CPMS are specified in referenced subparts G and SS of this part 63.
§63.9(a)	Notification Requirements	Yes.
§63.9(b)(1)-(5)	Initial Notifications	Yes.
§63.9(c)	Request for Compliance Extension	Yes.
§63.9(d)	Notification of Special Compliance Requirements for New Source	Yes.
§63.9(e)	Notification of Performance Test	Yes.
§63.9(f)	Notification of VE/Opacity Test	No. Subpart FFFF does not contain opacity or VE limits.
§63.9(g)	Additional Notifications When Using CMS	Only for CEMS. Section 63.9(g)(2) does not apply because subpart FFFF does not require COMS.
63.9(h)(1)-(6)	Notification of Compliance Status	Yes, except subpart FFFF has no opacity or VE limits, and 63.9(h)(2)(i)(A) through (G) and (ii) do not apply because 63.2520(d) specifies the required contents and due date of the notification of compliance status report.

§63.9(i)	Adjustment of Submittal Deadlines	Yes.
§63.9(j)	Change in Previous Information	No, §63.2520(e) specifies reporting requirements for process changes.
§63.10(a)	Recordkeeping/Reporting	Yes.
§63.10(b)(1)	Recordkeeping/Reporting	Yes.
§63.10(b)(2)(i)-(ii), (iv), (v)	Records related to SSM	No, §§63.998(d)(3) and 63.998(c)(1)(ii)(D) through (G) specify recordkeeping requirements for periods of SSM.
§63.10(b)(2)(iii)	Records related to maintenance of air pollution control equipment	Yes.
§63.10(b)(2)(vi), (x), and (xi)	CMS Records	Only for CEMS; requirements for CPMS are specified in referenced subparts G and SS of this part 63.
§63.10(b)(2)(vii)-(ix)	Records	Yes.
§63.10(b)(2)(xii)	Records	Yes.
§63.10(b)(2)(xiii)	Records	Only for CEMS.
§63.10(b)(2)(xiv)	Records	Yes.
§63.10(b)(3)	Records	Yes.
§63.10(c)(1)-(6),(9)-(15)	Records	Only for CEMS. Recordkeeping requirements for CPMS are specified in referenced subparts G and SS of this part 63.
§63.10(c)(7)-(8)	Records	No. Recordkeeping requirements are specified in §63.2525.
§63.10(d)(1)	General Reporting Requirements	Yes.

§63.10(d)(2)	Report of Performance Test Results	Yes.
§63.10(d)(3)	Reporting Opacity or VE Observations	No. Subpart FFFF does not contain opacity or VE limits.
§63.10(d)(4)	Progress Reports	Yes.
§63.10(d)(5)(i)	Periodic Startup, Shutdown, and Malfunction Reports	No, §63.2520(e)(4) and (5) specify the SSM reporting requirements.
§63.10(d)(5)(ii)	Immediate SSM Reports	No.
§63.10(e)(1)	Additional CEMS Reports	Yes.
§63.10(e)(2)(i)	Additional CMS Reports	Only for CEMS.
§63.10(e)(2)(ii)	Additional COMS Reports	No. Subpart FFFF does not require COMS.
§63.10(e)(3)	Reports	No. Reporting requirements are specified in §63.2520.
§63.10(e)(3)(i)-(iii)	Reports	No. Reporting requirements are specified in §63.2520.
§63.10(e)(3)(iv)-(v)	Excess Emissions Reports	No. Reporting requirements are specified in §63.2520.
§63.10(e)(3)(iv)-(v)	Excess Emissions Reports	No. Reporting requirements are specified in §63.2520.
§63.10(e)(3)(vi)-(viii)	Excess Emissions Report and Summary Report	No. Reporting requirements are specified in §63.2520.
§63.10(e)(4)	Reporting COMS data	No. Subpart FFFF does not contain opacity or VE limits.
§63.10(f)	Waiver for Recordkeeping/Reporting	Yes.

§63.11	Control device requirements for flares and work practice requirements for equipment leaks	Yes.
§63.12	Delegation	Yes.
§63.13	Addresses	Yes.
§63.14	Incorporation by Reference	Yes.
§63.15	Availability of Information	Yes.

[68 FR 63888, Nov. 10, 2003, as amended at 70 FR 38561, July 1, 2005; 71 FR 20463, Apr. 20, 2006; 71 FR 40341, July 14, 2006; 73 FR 72816, Dec. 22, 2008]

[↑ Back to Top](#)

# **APPENDIX K**

## Electronic Code of Federal Regulations

---

[View past updates to the e-CFR.](#)

[Click here to learn more.](#)

---

**e-CFR data is current as of January 17, 2017**

[Title 40](#) → [Chapter I](#) → [Subchapter C](#) → [Part 63](#) → [Subpart ZZZZ](#)

---

[Browse Next](#)

Title 40: Protection of Environment

[PART 63—NATIONAL EMISSION STANDARDS FOR HAZARDOUS AIR POLLUTANTS FOR SOURCE CATEGORIES \(CONTINUED\)](#)

---

### **Subpart ZZZZ—National Emissions Standards for Hazardous Air Pollutants for Stationary Reciprocating Internal Combustion Engines**

---

#### **Contents**

##### [What This Subpart Covers](#)

- [§63.6580](#) What is the purpose of subpart [ZZZZ](#)?
- [§63.6585](#) Am I subject to this subpart?
- [§63.6590](#) What parts of my plant does this subpart cover?
- [§63.6595](#) When do I have to comply with this subpart?

##### [Emission and Operating Limitations](#)

- [§63.6600](#) What emission limitations and operating limitations must I meet if I own or operate a stationary RICE with a site rating of more than 500 brake HP located at a major source of HAP emissions?
- [§63.6601](#) What emission limitations must I meet if I own or operate a new or reconstructed 4SLB stationary RICE with a site rating of greater than or equal to 250 brake HP and less than or equal to 500 brake HP located at a major source of HAP emissions?
- [§63.6602](#) What emission limitations and other requirements must I meet if I own or operate an existing stationary RICE with a site rating of equal to or less than 500 brake HP located at a major source of HAP emissions?
- [§63.6603](#) What emission limitations, operating limitations, and other requirements must I meet if I own or operate an existing stationary RICE located at an area source of HAP emissions?
- [§63.6604](#) What fuel requirements must I meet if I own or operate a stationary CI RICE?



## General Compliance Requirements

§63.6605 What are my general requirements for complying with this subpart?

## Testing and Initial Compliance Requirements

§63.6610 By what date must I conduct the initial performance tests or other initial compliance demonstrations if I own or operate a stationary RICE with a site rating of more than 500 brake HP located at a major source of HAP emissions?

§63.6611 By what date must I conduct the initial performance tests or other initial compliance demonstrations if I own or operate a new or reconstructed 4SLB SI stationary RICE with a site rating of greater than or equal to 250 and less than or equal to 500 brake HP located at a major source of HAP emissions?

§63.6612 By what date must I conduct the initial performance tests or other initial compliance demonstrations if I own or operate an existing stationary RICE with a site rating of less than or equal to 500 brake HP located at a major source of HAP emissions or an existing stationary RICE located at an area source of HAP emissions?

§63.6615 When must I conduct subsequent performance tests?

§63.6620 What performance tests and other procedures must I use?

§63.6625 What are my monitoring, installation, collection, operation, and maintenance requirements?

§63.6630 How do I demonstrate initial compliance with the emission limitations, operating limitations, and other requirements?

## Continuous Compliance Requirements

§63.6635 How do I monitor and collect data to demonstrate continuous compliance?

§63.6640 How do I demonstrate continuous compliance with the emission limitations, operating limitations, and other requirements?

## Notifications, Reports, and Records

§63.6645 What notifications must I submit and when?

§63.6650 What reports must I submit and when?

§63.6655 What records must I keep?

§63.6660 In what form and how long must I keep my records?

## Other Requirements and Information

§63.6665 What parts of the General Provisions apply to me?

§63.6670 Who implements and enforces this subpart?

§63.6675 What definitions apply to this subpart?

Table 1a to Subpart ZZZZ of Part 63—Emission Limitations for Existing, New, and Reconstructed Spark Ignition, 4SRB Stationary RICE >500 HP Located at a Major Source of HAP Emissions

Table 1b to Subpart ZZZZ of Part 63—Operating Limitations for Existing, New, and Reconstructed SI 4SRB Stationary RICE >500 HP Located at a Major Source of HAP Emissions

Table 2a to Subpart ZZZZ of Part 63—Emission Limitations for New and Reconstructed 2SLB and Compression Ignition Stationary RICE >500 HP and New and Reconstructed 4SLB Stationary RICE

≥250 HP Located at a Major Source of HAP Emissions

Table 2b to Subpart ZZZZ of Part 63—Operating Limitations for New and Reconstructed 2SLB and CI Stationary RICE >500 HP Located at a Major Source of HAP Emissions, New and Reconstructed 4SLB Stationary RICE ≥250 HP Located at a Major Source of HAP Emissions, Existing CI Stationary RICE >500 HP

Table 2c to Subpart ZZZZ of Part 63—Requirements for Existing Compression Ignition Stationary RICE Located at a Major Source of HAP Emissions and Existing Spark Ignition Stationary RICE ≤500 HP Located at a Major Source of HAP Emissions

Table 2d to Subpart ZZZZ of Part 63—Requirements for Existing Stationary RICE Located at Area Sources of HAP Emissions

Table 3 to Subpart ZZZZ of Part 63—Subsequent Performance Tests

Table 4 to Subpart ZZZZ of Part 63—Requirements for Performance Tests

Table 5 to Subpart ZZZZ of Part 63—Initial Compliance With Emission Limitations, Operating Limitations, and Other Requirements

Table 6 to Subpart ZZZZ of Part 63—Continuous Compliance With Emission Limitations, and Other Requirements

Table 7 to Subpart ZZZZ of Part 63—Requirements for Reports

Table 8 to Subpart ZZZZ of Part 63—Applicability of General Provisions to Subpart ZZZZ.

Appendix A to Subpart ZZZZ of Part 63—Protocol for Using an Electrochemical Analyzer to Determine Oxygen and Carbon Monoxide Concentrations From Certain Engines

---

Source: 69 FR 33506, June 15, 2004, unless otherwise noted.

[↑ Back to Top](#)

## What This Subpart Covers

[↑ Back to Top](#)

### §63.6580 What is the purpose of subpart ZZZZ?

Subpart ZZZZ establishes national emission limitations and operating limitations for hazardous air pollutants (HAP) emitted from stationary reciprocating internal combustion engines (RICE) located at major and area sources of HAP emissions. This subpart also establishes requirements to demonstrate initial and continuous compliance with the emission limitations and operating limitations.

[73 FR 3603, Jan. 18, 2008]

[↑ Back to Top](#)

### §63.6585 Am I subject to this subpart?

You are subject to this subpart if you own or operate a stationary RICE at a major or area source of HAP emissions, except if the stationary RICE is being tested at a stationary RICE test cell/stand.

(a) A stationary RICE is any internal combustion engine which uses reciprocating motion to convert heat energy into mechanical work and which is not mobile. Stationary RICE differ from mobile RICE in that a stationary RICE is not a non-road engine as defined at 40 CFR 1068.30, and is not used to propel a motor vehicle or a vehicle used solely for competition.

(b) A major source of HAP emissions is a plant site that emits or has the potential to emit any single HAP at a rate of 10 tons (9.07 megagrams) or more per year or any combination of HAP at a rate of 25 tons (22.68 megagrams) or more per year, except that for oil and gas production facilities, a major source of HAP emissions is determined for each surface site.

(c) An area source of HAP emissions is a source that is not a major source.

(d) If you are an owner or operator of an area source subject to this subpart, your status as an entity subject to a standard or other requirements under this subpart does not subject you to the obligation to obtain a permit under 40 CFR part 70 or 71, provided you are not required to obtain a permit under 40 CFR 70.3(a) or 40 CFR 71.3(a) for a reason other than your status as an area source under this subpart. Notwithstanding the previous sentence, you must continue to comply with the provisions of this subpart as applicable.

(e) If you are an owner or operator of a stationary RICE used for national security purposes, you may be eligible to request an exemption from the requirements of this subpart as described in 40 CFR part 1068, subpart C.

(f) The emergency stationary RICE listed in paragraphs (f)(1) through (3) of this section are not subject to this subpart. The stationary RICE must meet the definition of an emergency stationary RICE in §63.6675, which includes operating according to the provisions specified in §63.6640(f).

(1) Existing residential emergency stationary RICE located at an area source of HAP emissions that do not operate or are not contractually obligated to be available for more than 15 hours per calendar year for the purposes specified in §63.6640(f)(2)(ii) and (iii) and that do not operate for the purpose specified in §63.6640(f)(4)(ii).

(2) Existing commercial emergency stationary RICE located at an area source of HAP emissions that do not operate or are not contractually obligated to be available for more than 15 hours per calendar year for the purposes specified in §63.6640(f)(2)(ii) and (iii) and that do not operate for the purpose specified in §63.6640(f)(4)(ii).

(3) Existing institutional emergency stationary RICE located at an area source of HAP emissions that do not operate or are not contractually obligated to be available for more than 15 hours per calendar year for the purposes specified in §63.6640(f)(2)(ii) and (iii) and that do not operate for the purpose specified in §63.6640(f)(4)(ii).

[69 FR 33506, June 15, 2004, as amended at 73 FR 3603, Jan. 18, 2008; 78 FR 6700, Jan. 30, 2013]

[↑ Back to Top](#)

**§63.6590 What parts of my plant does this subpart cover?**

This subpart applies to each affected source.

(a) *Affected source.* An affected source is any existing, new, or reconstructed stationary RICE located at a major or area source of HAP emissions, excluding stationary RICE being tested at a stationary RICE test cell/stand.

(1) *Existing stationary RICE.*

(i) For stationary RICE with a site rating of more than 500 brake horsepower (HP) located at a major source of HAP emissions, a stationary RICE is existing if you commenced construction or reconstruction of the stationary RICE before December 19, 2002.

(ii) For stationary RICE with a site rating of less than or equal to 500 brake HP located at a major source of HAP emissions, a stationary RICE is existing if you commenced construction or reconstruction of the stationary RICE before June 12, 2006.

(iii) For stationary RICE located at an area source of HAP emissions, a stationary RICE is existing if you commenced construction or reconstruction of the stationary RICE before June 12, 2006.

(iv) A change in ownership of an existing stationary RICE does not make that stationary RICE a new or reconstructed stationary RICE.

(2) *New stationary RICE.* (i) A stationary RICE with a site rating of more than 500 brake HP located at a major source of HAP emissions is new if you commenced construction of the stationary RICE on or after December 19, 2002.

(ii) A stationary RICE with a site rating of equal to or less than 500 brake HP located at a major source of HAP emissions is new if you commenced construction of the stationary RICE on or after June 12, 2006.

(iii) A stationary RICE located at an area source of HAP emissions is new if you commenced construction of the stationary RICE on or after June 12, 2006.

(3) *Reconstructed stationary RICE.* (i) A stationary RICE with a site rating of more than 500 brake HP located at a major source of HAP emissions is reconstructed if you meet the definition of reconstruction in §63.2 and reconstruction is commenced on or after December 19, 2002.

(ii) A stationary RICE with a site rating of equal to or less than 500 brake HP located at a major source of HAP emissions is reconstructed if you meet the definition of reconstruction in §63.2 and reconstruction is commenced on or after June 12, 2006.

(iii) A stationary RICE located at an area source of HAP emissions is reconstructed if you meet the definition of reconstruction in §63.2 and reconstruction is commenced on or after June 12, 2006.

(b) *Stationary RICE subject to limited requirements.* (1) An affected source which meets either of the criteria in paragraphs (b)(1)(i) through (ii) of this section does not have to meet the requirements of this subpart and of subpart A of this part except for the initial notification requirements of §63.6645(f).

(i) The stationary RICE is a new or reconstructed emergency stationary RICE with a site rating of more than 500 brake HP located at a major source of HAP emissions that does not operate or is not

contractually obligated to be available for more than 15 hours per calendar year for the purposes specified in §63.6640(f)(2)(ii) and (iii).

(ii) The stationary RICE is a new or reconstructed limited use stationary RICE with a site rating of more than 500 brake HP located at a major source of HAP emissions.

(2) A new or reconstructed stationary RICE with a site rating of more than 500 brake HP located at a major source of HAP emissions which combusts landfill or digester gas equivalent to 10 percent or more of the gross heat input on an annual basis must meet the initial notification requirements of §63.6645(f) and the requirements of §§63.6625(c), 63.6650(g), and 63.6655(c). These stationary RICE do not have to meet the emission limitations and operating limitations of this subpart.

(3) The following stationary RICE do not have to meet the requirements of this subpart and of subpart A of this part, including initial notification requirements:

(i) Existing spark ignition 2 stroke lean burn (2SLB) stationary RICE with a site rating of more than 500 brake HP located at a major source of HAP emissions;

(ii) Existing spark ignition 4 stroke lean burn (4SLB) stationary RICE with a site rating of more than 500 brake HP located at a major source of HAP emissions;

(iii) Existing emergency stationary RICE with a site rating of more than 500 brake HP located at a major source of HAP emissions that does not operate or is not contractually obligated to be available for more than 15 hours per calendar year for the purposes specified in §63.6640(f)(2)(ii) and (iii).

(iv) Existing limited use stationary RICE with a site rating of more than 500 brake HP located at a major source of HAP emissions;

(v) Existing stationary RICE with a site rating of more than 500 brake HP located at a major source of HAP emissions that combusts landfill gas or digester gas equivalent to 10 percent or more of the gross heat input on an annual basis;

(c) *Stationary RICE subject to Regulations under 40 CFR Part 60.* An affected source that meets any of the criteria in paragraphs (c)(1) through (7) of this section must meet the requirements of this part by meeting the requirements of 40 CFR part 60 subpart IIII, for compression ignition engines or 40 CFR part 60 subpart JJJJ, for spark ignition engines. No further requirements apply for such engines under this part.

(1) A new or reconstructed stationary RICE located at an area source;

(2) A new or reconstructed 2SLB stationary RICE with a site rating of less than or equal to 500 brake HP located at a major source of HAP emissions;

(3) A new or reconstructed 4SLB stationary RICE with a site rating of less than 250 brake HP located at a major source of HAP emissions;

(4) A new or reconstructed spark ignition 4 stroke rich burn (4SRB) stationary RICE with a site rating of less than or equal to 500 brake HP located at a major source of HAP emissions;

(5) A new or reconstructed stationary RICE with a site rating of less than or equal to 500 brake HP located at a major source of HAP emissions which combusts landfill or digester gas equivalent to 10 percent or more of the gross heat input on an annual basis;

(6) A new or reconstructed emergency or limited use stationary RICE with a site rating of less than or equal to 500 brake HP located at a major source of HAP emissions;

(7) A new or reconstructed compression ignition (CI) stationary RICE with a site rating of less than or equal to 500 brake HP located at a major source of HAP emissions.

[69 FR 33506, June 15, 2004, as amended at 73 FR 3604, Jan. 18, 2008; 75 FR 9674, Mar. 3, 2010; 75 FR 37733, June 30, 2010; 75 FR 51588, Aug. 20, 2010; 78 FR 6700, Jan. 30, 2013]

[↑ Back to Top](#)

### **§63.6595 When do I have to comply with this subpart?**

(a) *Affected sources.* (1) If you have an existing stationary RICE, excluding existing non-emergency CI stationary RICE, with a site rating of more than 500 brake HP located at a major source of HAP emissions, you must comply with the applicable emission limitations, operating limitations and other requirements no later than June 15, 2007. If you have an existing non-emergency CI stationary RICE with a site rating of more than 500 brake HP located at a major source of HAP emissions, an existing stationary CI RICE with a site rating of less than or equal to 500 brake HP located at a major source of HAP emissions, or an existing stationary CI RICE located at an area source of HAP emissions, you must comply with the applicable emission limitations, operating limitations, and other requirements no later than May 3, 2013. If you have an existing stationary SI RICE with a site rating of less than or equal to 500 brake HP located at a major source of HAP emissions, or an existing stationary SI RICE located at an area source of HAP emissions, you must comply with the applicable emission limitations, operating limitations, and other requirements no later than October 19, 2013.

(2) If you start up your new or reconstructed stationary RICE with a site rating of more than 500 brake HP located at a major source of HAP emissions before August 16, 2004, you must comply with the applicable emission limitations and operating limitations in this subpart no later than August 16, 2004.

(3) If you start up your new or reconstructed stationary RICE with a site rating of more than 500 brake HP located at a major source of HAP emissions after August 16, 2004, you must comply with the applicable emission limitations and operating limitations in this subpart upon startup of your affected source.

(4) If you start up your new or reconstructed stationary RICE with a site rating of less than or equal to 500 brake HP located at a major source of HAP emissions before January 18, 2008, you must comply with the applicable emission limitations and operating limitations in this subpart no later than January 18, 2008.

(5) If you start up your new or reconstructed stationary RICE with a site rating of less than or equal to 500 brake HP located at a major source of HAP emissions after January 18, 2008, you must comply with the applicable emission limitations and operating limitations in this subpart upon startup of your affected source.

(6) If you start up your new or reconstructed stationary RICE located at an area source of HAP emissions before January 18, 2008, you must comply with the applicable emission limitations and operating limitations in this subpart no later than January 18, 2008.

(7) If you start up your new or reconstructed stationary RICE located at an area source of HAP emissions after January 18, 2008, you must comply with the applicable emission limitations and operating limitations in this subpart upon startup of your affected source.

(b) *Area sources that become major sources.* If you have an area source that increases its emissions or its potential to emit such that it becomes a major source of HAP, the compliance dates in paragraphs (b)(1) and (2) of this section apply to you.

(1) Any stationary RICE for which construction or reconstruction is commenced after the date when your area source becomes a major source of HAP must be in compliance with this subpart upon startup of your affected source.

(2) Any stationary RICE for which construction or reconstruction is commenced before your area source becomes a major source of HAP must be in compliance with the provisions of this subpart that are applicable to RICE located at major sources within 3 years after your area source becomes a major source of HAP.

(c) If you own or operate an affected source, you must meet the applicable notification requirements in §63.6645 and in 40 CFR part 63, subpart A.

[69 FR 33506, June 15, 2004, as amended at 73 FR 3604, Jan. 18, 2008; 75 FR 9675, Mar. 3, 2010; 75 FR 51589, Aug. 20, 2010; 78 FR 6701, Jan. 30, 2013]

[↑ Back to Top](#)

## Emission and Operating Limitations

[↑ Back to Top](#)

### **§63.6600 What emission limitations and operating limitations must I meet if I own or operate a stationary RICE with a site rating of more than 500 brake HP located at a major source of HAP emissions?**

Compliance with the numerical emission limitations established in this subpart is based on the results of testing the average of three 1-hour runs using the testing requirements and procedures in §63.6620 and Table 4 to this subpart.

(a) If you own or operate an existing, new, or reconstructed spark ignition 4SRB stationary RICE with a site rating of more than 500 brake HP located at a major source of HAP emissions, you must comply with the emission limitations in Table 1a to this subpart and the operating limitations in Table 1b to this subpart which apply to you.

(b) If you own or operate a new or reconstructed 2SLB stationary RICE with a site rating of more than 500 brake HP located at major source of HAP emissions, a new or reconstructed 4SLB stationary RICE

with a site rating of more than 500 brake HP located at major source of HAP emissions, or a new or reconstructed CI stationary RICE with a site rating of more than 500 brake HP located at a major source of HAP emissions, you must comply with the emission limitations in Table 2a to this subpart and the operating limitations in Table 2b to this subpart which apply to you.

(c) If you own or operate any of the following stationary RICE with a site rating of more than 500 brake HP located at a major source of HAP emissions, you do not need to comply with the emission limitations in Tables 1a, 2a, 2c, and 2d to this subpart or operating limitations in Tables 1b and 2b to this subpart: an existing 2SLB stationary RICE; an existing 4SLB stationary RICE; a stationary RICE that combusts landfill gas or digester gas equivalent to 10 percent or more of the gross heat input on an annual basis; an emergency stationary RICE; or a limited use stationary RICE.

(d) If you own or operate an existing non-emergency stationary CI RICE with a site rating of more than 500 brake HP located at a major source of HAP emissions, you must comply with the emission limitations in Table 2c to this subpart and the operating limitations in Table 2b to this subpart which apply to you.

[73 FR 3605, Jan. 18, 2008, as amended at 75 FR 9675, Mar. 3, 2010]

[↑ Back to Top](#)

**§63.6601 What emission limitations must I meet if I own or operate a new or reconstructed 4SLB stationary RICE with a site rating of greater than or equal to 250 brake HP and less than or equal to 500 brake HP located at a major source of HAP emissions?**

Compliance with the numerical emission limitations established in this subpart is based on the results of testing the average of three 1-hour runs using the testing requirements and procedures in §63.6620 and Table 4 to this subpart. If you own or operate a new or reconstructed 4SLB stationary RICE with a site rating of greater than or equal to 250 and less than or equal to 500 brake HP located at major source of HAP emissions manufactured on or after January 1, 2008, you must comply with the emission limitations in Table 2a to this subpart and the operating limitations in Table 2b to this subpart which apply to you.

[73 FR 3605, Jan. 18, 2008, as amended at 75 FR 9675, Mar. 3, 2010; 75 FR 51589, Aug. 20, 2010]

[↑ Back to Top](#)

**§63.6602 What emission limitations and other requirements must I meet if I own or operate an existing stationary RICE with a site rating of equal to or less than 500 brake HP located at a major source of HAP emissions?**

If you own or operate an existing stationary RICE with a site rating of equal to or less than 500 brake HP located at a major source of HAP emissions, you must comply with the emission limitations and other requirements in Table 2c to this subpart which apply to you. Compliance with the numerical emission limitations established in this subpart is based on the results of testing the average of three 1-hour runs using the testing requirements and procedures in §63.6620 and Table 4 to this subpart.

[78 FR 6701, Jan. 30, 2013]



[↑ Back to Top](#)

**§63.6603 What emission limitations, operating limitations, and other requirements must I meet if I own or operate an existing stationary RICE located at an area source of HAP emissions?**

Compliance with the numerical emission limitations established in this subpart is based on the results of testing the average of three 1-hour runs using the testing requirements and procedures in §63.6620 and Table 4 to this subpart.

(a) If you own or operate an existing stationary RICE located at an area source of HAP emissions, you must comply with the requirements in Table 2d to this subpart and the operating limitations in Table 2b to this subpart that apply to you.

(b) If you own or operate an existing stationary non-emergency CI RICE with a site rating of more than 300 HP located at an area source of HAP that meets either paragraph (b)(1) or (2) of this section, you do not have to meet the numerical CO emission limitations specified in Table 2d of this subpart. Existing stationary non-emergency CI RICE with a site rating of more than 300 HP located at an area source of HAP that meet either paragraph (b)(1) or (2) of this section must meet the management practices that are shown for stationary non-emergency CI RICE with a site rating of less than or equal to 300 HP in Table 2d of this subpart.

(1) The area source is located in an area of Alaska that is not accessible by the Federal Aid Highway System (FAHS).

(2) The stationary RICE is located at an area source that meets paragraphs (b)(2)(i), (ii), and (iii) of this section.

(i) The only connection to the FAHS is through the Alaska Marine Highway System (AMHS), or the stationary RICE operation is within an isolated grid in Alaska that is not connected to the statewide electrical grid referred to as the Alaska Railbelt Grid.

(ii) At least 10 percent of the power generated by the stationary RICE on an annual basis is used for residential purposes.

(iii) The generating capacity of the area source is less than 12 megawatts, or the stationary RICE is used exclusively for backup power for renewable energy.

(c) If you own or operate an existing stationary non-emergency CI RICE with a site rating of more than 300 HP located on an offshore vessel that is an area source of HAP and is a nonroad vehicle that is an Outer Continental Shelf (OCS) source as defined in 40 CFR 55.2, you do not have to meet the numerical CO emission limitations specified in Table 2d of this subpart. You must meet all of the following management practices:

(1) Change oil every 1,000 hours of operation or annually, whichever comes first. Sources have the option to utilize an oil analysis program as described in §63.6625(i) in order to extend the specified oil change requirement.

(2) Inspect and clean air filters every 750 hours of operation or annually, whichever comes first, and replace as necessary.

(3) Inspect fuel filters and belts, if installed, every 750 hours of operation or annually, whichever comes first, and replace as necessary.

(4) Inspect all flexible hoses every 1,000 hours of operation or annually, whichever comes first, and replace as necessary.

(d) If you own or operate an existing non-emergency CI RICE with a site rating of more than 300 HP located at an area source of HAP emissions that is certified to the Tier 1 or Tier 2 emission standards in Table 1 of 40 CFR 89.112 and that is subject to an enforceable state or local standard that requires the engine to be replaced no later than June 1, 2018, you may until January 1, 2015, or 12 years after the installation date of the engine (whichever is later), but not later than June 1, 2018, choose to comply with the management practices that are shown for stationary non-emergency CI RICE with a site rating of less than or equal to 300 HP in Table 2d of this subpart instead of the applicable emission limitations in Table 2d, operating limitations in Table 2b, and crankcase ventilation system requirements in §63.6625(g). You must comply with the emission limitations in Table 2d and operating limitations in Table 2b that apply for non-emergency CI RICE with a site rating of more than 300 HP located at an area source of HAP emissions by January 1, 2015, or 12 years after the installation date of the engine (whichever is later), but not later than June 1, 2018. You must also comply with the crankcase ventilation system requirements in §63.6625(g) by January 1, 2015, or 12 years after the installation date of the engine (whichever is later), but not later than June 1, 2018.

(e) If you own or operate an existing non-emergency CI RICE with a site rating of more than 300 HP located at an area source of HAP emissions that is certified to the Tier 3 (Tier 2 for engines above 560 kilowatt (kW)) emission standards in Table 1 of 40 CFR 89.112, you may comply with the requirements under this part by meeting the requirements for Tier 3 engines (Tier 2 for engines above 560 kW) in 40 CFR part 60 subpart IIII instead of the emission limitations and other requirements that would otherwise apply under this part for existing non-emergency CI RICE with a site rating of more than 300 HP located at an area source of HAP emissions.

(f) An existing non-emergency SI 4SLB and 4SRB stationary RICE with a site rating of more than 500 HP located at area sources of HAP must meet the definition of remote stationary RICE in §63.6675 on the initial compliance date for the engine, October 19, 2013, in order to be considered a remote stationary RICE under this subpart. Owners and operators of existing non-emergency SI 4SLB and 4SRB stationary RICE with a site rating of more than 500 HP located at area sources of HAP that meet the definition of remote stationary RICE in §63.6675 of this subpart as of October 19, 2013 must evaluate the status of their stationary RICE every 12 months. Owners and operators must keep records of the initial and annual evaluation of the status of the engine. If the evaluation indicates that the stationary RICE no longer meets the definition of remote stationary RICE in §63.6675 of this subpart, the owner or operator must comply with all of the requirements for existing non-emergency SI 4SLB and 4SRB stationary RICE with a site rating of more than 500 HP located at area sources of HAP that are not remote stationary RICE within 1 year of the evaluation.

[75 FR 9675, Mar. 3, 2010, as amended at 75 FR 51589, Aug. 20, 2010; 76 FR 12866, Mar. 9, 2011; 78 FR 6701, Jan. 30, 2013]

[↑ Back to Top](#)

#### **§63.6604 What fuel requirements must I meet if I own or operate a stationary CI RICE?**

(a) If you own or operate an existing non-emergency, non-black start CI stationary RICE with a site rating of more than 300 brake HP with a displacement of less than 30 liters per cylinder that uses diesel fuel, you must use diesel fuel that meets the requirements in 40 CFR 80.510(b) for nonroad diesel fuel.

(b) Beginning January 1, 2015, if you own or operate an existing emergency CI stationary RICE with a site rating of more than 100 brake HP and a displacement of less than 30 liters per cylinder that uses diesel fuel and operates or is contractually obligated to be available for more than 15 hours per calendar year for the purposes specified in §63.6640(f)(2)(ii) and (iii) or that operates for the purpose specified in §63.6640(f)(4)(ii), you must use diesel fuel that meets the requirements in 40 CFR 80.510(b) for nonroad diesel fuel, except that any existing diesel fuel purchased (or otherwise obtained) prior to January 1, 2015, may be used until depleted.

(c) Beginning January 1, 2015, if you own or operate a new emergency CI stationary RICE with a site rating of more than 500 brake HP and a displacement of less than 30 liters per cylinder located at a major source of HAP that uses diesel fuel and operates or is contractually obligated to be available for more than 15 hours per calendar year for the purposes specified in §63.6640(f)(2)(ii) and (iii), you must use diesel fuel that meets the requirements in 40 CFR 80.510(b) for nonroad diesel fuel, except that any existing diesel fuel purchased (or otherwise obtained) prior to January 1, 2015, may be used until depleted.

(d) Existing CI stationary RICE located in Guam, American Samoa, the Commonwealth of the Northern Mariana Islands, at area sources in areas of Alaska that meet either §63.6603(b)(1) or §63.6603(b)(2), or are on offshore vessels that meet §63.6603(c) are exempt from the requirements of this section.

[78 FR 6702, Jan. 30, 2013]

[↑ Back to Top](#)

#### **General Compliance Requirements**

[↑ Back to Top](#)

#### **§63.6605 What are my general requirements for complying with this subpart?**

(a) You must be in compliance with the emission limitations, operating limitations, and other requirements in this subpart that apply to you at all times.

(b) At all times you must operate and maintain any affected source, including associated air pollution control equipment and monitoring equipment, in a manner consistent with safety and good air pollution control practices for minimizing emissions. The general duty to minimize emissions does not require you to make any further efforts to reduce emissions if levels required by this standard have been achieved. Determination of whether such operation and maintenance procedures are being used will be based on

information available to the Administrator which may include, but is not limited to, monitoring results, review of operation and maintenance procedures, review of operation and maintenance records, and inspection of the source.

[75 FR 9675, Mar. 3, 2010, as amended at 78 FR 6702, Jan. 30, 2013]

[↑ Back to Top](#)

## Testing and Initial Compliance Requirements

[↑ Back to Top](#)

### **§63.6610 By what date must I conduct the initial performance tests or other initial compliance demonstrations if I own or operate a stationary RICE with a site rating of more than 500 brake HP located at a major source of HAP emissions?**

If you own or operate a stationary RICE with a site rating of more than 500 brake HP located at a major source of HAP emissions you are subject to the requirements of this section.

(a) You must conduct the initial performance test or other initial compliance demonstrations in Table 4 to this subpart that apply to you within 180 days after the compliance date that is specified for your stationary RICE in §63.6595 and according to the provisions in §63.7(a)(2).

(b) If you commenced construction or reconstruction between December 19, 2002 and June 15, 2004 and own or operate stationary RICE with a site rating of more than 500 brake HP located at a major source of HAP emissions, you must demonstrate initial compliance with either the proposed emission limitations or the promulgated emission limitations no later than February 10, 2005 or no later than 180 days after startup of the source, whichever is later, according to §63.7(a)(2)(ix).

(c) If you commenced construction or reconstruction between December 19, 2002 and June 15, 2004 and own or operate stationary RICE with a site rating of more than 500 brake HP located at a major source of HAP emissions, and you chose to comply with the proposed emission limitations when demonstrating initial compliance, you must conduct a second performance test to demonstrate compliance with the promulgated emission limitations by December 13, 2007 or after startup of the source, whichever is later, according to §63.7(a)(2)(ix).

(d) An owner or operator is not required to conduct an initial performance test on units for which a performance test has been previously conducted, but the test must meet all of the conditions described in paragraphs (d)(1) through (5) of this section.

(1) The test must have been conducted using the same methods specified in this subpart, and these methods must have been followed correctly.

(2) The test must not be older than 2 years.

(3) The test must be reviewed and accepted by the Administrator.

(4) Either no process or equipment changes must have been made since the test was performed, or the owner or operator must be able to demonstrate that the results of the performance test, with or without adjustments, reliably demonstrate compliance despite process or equipment changes.

(5) The test must be conducted at any load condition within plus or minus 10 percent of 100 percent load.

[69 FR 33506, June 15, 2004, as amended at 73 FR 3605, Jan. 18, 2008]

[↑ Back to Top](#)

**§63.6611 By what date must I conduct the initial performance tests or other initial compliance demonstrations if I own or operate a new or reconstructed 4SLB SI stationary RICE with a site rating of greater than or equal to 250 and less than or equal to 500 brake HP located at a major source of HAP emissions?**

If you own or operate a new or reconstructed 4SLB stationary RICE with a site rating of greater than or equal to 250 and less than or equal to 500 brake HP located at a major source of HAP emissions, you must conduct an initial performance test within 240 days after the compliance date that is specified for your stationary RICE in §63.6595 and according to the provisions specified in Table 4 to this subpart, as appropriate.

[73 FR 3605, Jan. 18, 2008, as amended at 75 FR 51589, Aug. 20, 2010]

[↑ Back to Top](#)

**§63.6612 By what date must I conduct the initial performance tests or other initial compliance demonstrations if I own or operate an existing stationary RICE with a site rating of less than or equal to 500 brake HP located at a major source of HAP emissions or an existing stationary RICE located at an area source of HAP emissions?**

If you own or operate an existing stationary RICE with a site rating of less than or equal to 500 brake HP located at a major source of HAP emissions or an existing stationary RICE located at an area source of HAP emissions you are subject to the requirements of this section.

(a) You must conduct any initial performance test or other initial compliance demonstration according to Tables 4 and 5 to this subpart that apply to you within 180 days after the compliance date that is specified for your stationary RICE in §63.6595 and according to the provisions in §63.7(a)(2).

(b) An owner or operator is not required to conduct an initial performance test on a unit for which a performance test has been previously conducted, but the test must meet all of the conditions described in paragraphs (b)(1) through (4) of this section.

(1) The test must have been conducted using the same methods specified in this subpart, and these methods must have been followed correctly.

(2) The test must not be older than 2 years.

(3) The test must be reviewed and accepted by the Administrator.

(4) Either no process or equipment changes must have been made since the test was performed, or the owner or operator must be able to demonstrate that the results of the performance test, with or without adjustments, reliably demonstrate compliance despite process or equipment changes.

[75 FR 9676, Mar. 3, 2010, as amended at 75 FR 51589, Aug. 20, 2010]

[↑ Back to Top](#)

#### **§63.6615 When must I conduct subsequent performance tests?**

If you must comply with the emission limitations and operating limitations, you must conduct subsequent performance tests as specified in Table 3 of this subpart.

[↑ Back to Top](#)

#### **§63.6620 What performance tests and other procedures must I use?**

- (a) You must conduct each performance test in Tables 3 and 4 of this subpart that applies to you.
- (b) Each performance test must be conducted according to the requirements that this subpart specifies in Table 4 to this subpart. If you own or operate a non-operational stationary RICE that is subject to performance testing, you do not need to start up the engine solely to conduct the performance test. Owners and operators of a non-operational engine can conduct the performance test when the engine is started up again. The test must be conducted at any load condition within plus or minus 10 percent of 100 percent load for the stationary RICE listed in paragraphs (b)(1) through (4) of this section.
- (1) Non-emergency 4SRB stationary RICE with a site rating of greater than 500 brake HP located at a major source of HAP emissions.
- (2) New non-emergency 4SLB stationary RICE with a site rating of greater than or equal to 250 brake HP located at a major source of HAP emissions.
- (3) New non-emergency 2SLB stationary RICE with a site rating of greater than 500 brake HP located at a major source of HAP emissions.
- (4) New non-emergency CI stationary RICE with a site rating of greater than 500 brake HP located at a major source of HAP emissions.
- (c) [Reserved]
- (d) You must conduct three separate test runs for each performance test required in this section, as specified in §63.7(e)(3). Each test run must last at least 1 hour, unless otherwise specified in this subpart.
- (e)(1) You must use Equation 1 of this section to determine compliance with the percent reduction requirement:

$$\frac{C_i - C_o}{C_i} \times 100 = R \quad (\text{Eq. 1})$$

[View or download PDF](#)

Where:

$C_i$  = concentration of carbon monoxide (CO), total hydrocarbons (THC), or formaldehyde at the control device inlet,

$C_o$  = concentration of CO, THC, or formaldehyde at the control device outlet, and

R = percent reduction of CO, THC, or formaldehyde emissions.

(2) You must normalize the CO, THC, or formaldehyde concentrations at the inlet and outlet of the control device to a dry basis and to 15 percent oxygen, or an equivalent percent carbon dioxide ( $CO_2$ ). If pollutant concentrations are to be corrected to 15 percent oxygen and  $CO_2$  concentration is measured in lieu of oxygen concentration measurement, a  $CO_2$  correction factor is needed. Calculate the  $CO_2$  correction factor as described in paragraphs (e)(2)(i) through (iii) of this section.

(i) Calculate the fuel-specific  $F_o$  value for the fuel burned during the test using values obtained from Method 19, Section 5.2, and the following equation:

$$F_o = \frac{0.209 F_d}{F_c} \quad (\text{Eq. 2})$$

[View or download PDF](#)

Where:

$F_o$  = Fuel factor based on the ratio of oxygen volume to the ultimate  $CO_2$  volume produced by the fuel at zero percent excess air.

0.209 = Fraction of air that is oxygen, percent/100.

$F_d$  = Ratio of the volume of dry effluent gas to the gross calorific value of the fuel from Method 19,  $dsm^3/J$  ( $dscf/10^6$  Btu).

$F_c$  = Ratio of the volume of  $CO_2$  produced to the gross calorific value of the fuel from Method 19,  $dsm^3/J$  ( $dscf/10^6$  Btu)

(ii) Calculate the  $CO_2$  correction factor for correcting measurement data to 15 percent  $O_2$ , as follows:

$$X_{CO_2} = \frac{5.9}{F_o} \quad (\text{Eq. 3})$$

[View or download PDF](#)

Where:

$X_{CO_2}$  =  $CO_2$  correction factor, percent.

5.9 = 20.9 percent  $O_2$ —15 percent  $O_2$ , the defined  $O_2$  correction value, percent.

(iii) Calculate the CO, THC, and formaldehyde gas concentrations adjusted to 15 percent  $O_2$  using  $CO_2$  as follows:

$$C_{adj} = C_d \frac{X_{CO_2}}{\%CO_2} \quad (\text{Eq. 4})$$

[View or download PDF](#)

Where:

$C_{adj}$  = Calculated concentration of CO, THC, or formaldehyde adjusted to 15 percent O<sub>2</sub>.

$C_d$  = Measured concentration of CO, THC, or formaldehyde, uncorrected.

$X_{CO_2}$  = CO<sub>2</sub> correction factor, percent.

$\%CO_2$  = Measured CO<sub>2</sub> concentration measured, dry basis, percent.

(f) If you comply with the emission limitation to reduce CO and you are not using an oxidation catalyst, if you comply with the emission limitation to reduce formaldehyde and you are not using NSCR, or if you comply with the emission limitation to limit the concentration of formaldehyde in the stationary RICE exhaust and you are not using an oxidation catalyst or NSCR, you must petition the Administrator for operating limitations to be established during the initial performance test and continuously monitored thereafter; or for approval of no operating limitations. You must not conduct the initial performance test until after the petition has been approved by the Administrator.

(g) If you petition the Administrator for approval of operating limitations, your petition must include the information described in paragraphs (g)(1) through (5) of this section.

(1) Identification of the specific parameters you propose to use as operating limitations;

(2) A discussion of the relationship between these parameters and HAP emissions, identifying how HAP emissions change with changes in these parameters, and how limitations on these parameters will serve to limit HAP emissions;

(3) A discussion of how you will establish the upper and/or lower values for these parameters which will establish the limits on these parameters in the operating limitations;

(4) A discussion identifying the methods you will use to measure and the instruments you will use to monitor these parameters, as well as the relative accuracy and precision of these methods and instruments; and

(5) A discussion identifying the frequency and methods for recalibrating the instruments you will use for monitoring these parameters.

(h) If you petition the Administrator for approval of no operating limitations, your petition must include the information described in paragraphs (h)(1) through (7) of this section.

(1) Identification of the parameters associated with operation of the stationary RICE and any emission control device which could change intentionally (*e.g.*, operator adjustment, automatic controller adjustment, etc.) or unintentionally (*e.g.*, wear and tear, error, etc.) on a routine basis or over time;



- (2) A discussion of the relationship, if any, between changes in the parameters and changes in HAP emissions;
- (3) For the parameters which could change in such a way as to increase HAP emissions, a discussion of whether establishing limitations on the parameters would serve to limit HAP emissions;
- (4) For the parameters which could change in such a way as to increase HAP emissions, a discussion of how you could establish upper and/or lower values for the parameters which would establish limits on the parameters in operating limitations;
- (5) For the parameters, a discussion identifying the methods you could use to measure them and the instruments you could use to monitor them, as well as the relative accuracy and precision of the methods and instruments;
- (6) For the parameters, a discussion identifying the frequency and methods for recalibrating the instruments you could use to monitor them; and
- (7) A discussion of why, from your point of view, it is infeasible or unreasonable to adopt the parameters as operating limitations.
- (i) The engine percent load during a performance test must be determined by documenting the calculations, assumptions, and measurement devices used to measure or estimate the percent load in a specific application. A written report of the average percent load determination must be included in the notification of compliance status. The following information must be included in the written report: the engine model number, the engine manufacturer, the year of purchase, the manufacturer's site-rated brake horsepower, the ambient temperature, pressure, and humidity during the performance test, and all assumptions that were made to estimate or calculate percent load during the performance test must be clearly explained. If measurement devices such as flow meters, kilowatt meters, beta analyzers, stain gauges, etc. are used, the model number of the measurement device, and an estimate of its accurate in percentage of true value must be provided.

[69 FR 33506, June 15, 2004, as amended at 75 FR 9676, Mar. 3, 2010; 78 FR 6702, Jan. 30, 2013]

[↑ Back to Top](#)

### **§63.6625 What are my monitoring, installation, collection, operation, and maintenance requirements?**

- (a) If you elect to install a CEMS as specified in Table 5 of this subpart, you must install, operate, and maintain a CEMS to monitor CO and either O<sub>2</sub> or CO<sub>2</sub> according to the requirements in paragraphs (a)(1) through (4) of this section. If you are meeting a requirement to reduce CO emissions, the CEMS must be installed at both the inlet and outlet of the control device. If you are meeting a requirement to limit the concentration of CO, the CEMS must be installed at the outlet of the control device.
- (1) Each CEMS must be installed, operated, and maintained according to the applicable performance specifications of 40 CFR part 60, appendix B.

(2) You must conduct an initial performance evaluation and an annual relative accuracy test audit (RATA) of each CEMS according to the requirements in §63.8 and according to the applicable performance specifications of 40 CFR part 60, appendix B as well as daily and periodic data quality checks in accordance with 40 CFR part 60, appendix F, procedure 1.

(3) As specified in §63.8(c)(4)(ii), each CEMS must complete a minimum of one cycle of operation (sampling, analyzing, and data recording) for each successive 15-minute period. You must have at least two data points, with each representing a different 15-minute period, to have a valid hour of data.

(4) The CEMS data must be reduced as specified in §63.8(g)(2) and recorded in parts per million or parts per billion (as appropriate for the applicable limitation) at 15 percent oxygen or the equivalent CO<sub>2</sub> concentration.

(b) If you are required to install a continuous parameter monitoring system (CPMS) as specified in Table 5 of this subpart, you must install, operate, and maintain each CPMS according to the requirements in paragraphs (b)(1) through (6) of this section. For an affected source that is complying with the emission limitations and operating limitations on March 9, 2011, the requirements in paragraph (b) of this section are applicable September 6, 2011.

(1) You must prepare a site-specific monitoring plan that addresses the monitoring system design, data collection, and the quality assurance and quality control elements outlined in paragraphs (b)(1)(i) through (v) of this section and in §63.8(d). As specified in §63.8(f)(4), you may request approval of monitoring system quality assurance and quality control procedures alternative to those specified in paragraphs (b)(1) through (5) of this section in your site-specific monitoring plan.

(i) The performance criteria and design specifications for the monitoring system equipment, including the sample interface, detector signal analyzer, and data acquisition and calculations;

(ii) Sampling interface (*e.g.*, thermocouple) location such that the monitoring system will provide representative measurements;

(iii) Equipment performance evaluations, system accuracy audits, or other audit procedures;

(iv) Ongoing operation and maintenance procedures in accordance with provisions in §63.8(c)(1)(ii) and (c)(3); and

(v) Ongoing reporting and recordkeeping procedures in accordance with provisions in §63.10(c), (e)(1), and (e)(2)(i).

(2) You must install, operate, and maintain each CPMS in continuous operation according to the procedures in your site-specific monitoring plan.

(3) The CPMS must collect data at least once every 15 minutes (see also §63.6635).

(4) For a CPMS for measuring temperature range, the temperature sensor must have a minimum tolerance of 2.8 degrees Celsius (5 degrees Fahrenheit) or 1 percent of the measurement range, whichever is larger.

(5) You must conduct the CPMS equipment performance evaluation, system accuracy audits, or other audit procedures specified in your site-specific monitoring plan at least annually.

(6) You must conduct a performance evaluation of each CPMS in accordance with your site-specific monitoring plan.

(c) If you are operating a new or reconstructed stationary RICE which fires landfill gas or digester gas equivalent to 10 percent or more of the gross heat input on an annual basis, you must monitor and record your fuel usage daily with separate fuel meters to measure the volumetric flow rate of each fuel. In addition, you must operate your stationary RICE in a manner which reasonably minimizes HAP emissions.

(d) If you are operating a new or reconstructed emergency 4SLB stationary RICE with a site rating of greater than or equal to 250 and less than or equal to 500 brake HP located at a major source of HAP emissions, you must install a non-resettable hour meter prior to the startup of the engine.

(e) If you own or operate any of the following stationary RICE, you must operate and maintain the stationary RICE and after-treatment control device (if any) according to the manufacturer's emission-related written instructions or develop your own maintenance plan which must provide to the extent practicable for the maintenance and operation of the engine in a manner consistent with good air pollution control practice for minimizing emissions:

(1) An existing stationary RICE with a site rating of less than 100 HP located at a major source of HAP emissions;

(2) An existing emergency or black start stationary RICE with a site rating of less than or equal to 500 HP located at a major source of HAP emissions;

(3) An existing emergency or black start stationary RICE located at an area source of HAP emissions;

(4) An existing non-emergency, non-black start stationary CI RICE with a site rating less than or equal to 300 HP located at an area source of HAP emissions;

(5) An existing non-emergency, non-black start 2SLB stationary RICE located at an area source of HAP emissions;

(6) An existing non-emergency, non-black start stationary RICE located at an area source of HAP emissions which combusts landfill or digester gas equivalent to 10 percent or more of the gross heat input on an annual basis.

(7) An existing non-emergency, non-black start 4SLB stationary RICE with a site rating less than or equal to 500 HP located at an area source of HAP emissions;

(8) An existing non-emergency, non-black start 4SRB stationary RICE with a site rating less than or equal to 500 HP located at an area source of HAP emissions;

(9) An existing, non-emergency, non-black start 4SLB stationary RICE with a site rating greater than 500 HP located at an area source of HAP emissions that is operated 24 hours or less per calendar year; and

(10) An existing, non-emergency, non-black start 4SRB stationary RICE with a site rating greater than 500 HP located at an area source of HAP emissions that is operated 24 hours or less per calendar year.

(f) If you own or operate an existing emergency stationary RICE with a site rating of less than or equal to 500 brake HP located at a major source of HAP emissions or an existing emergency stationary RICE located at an area source of HAP emissions, you must install a non-resettable hour meter if one is not already installed.

(g) If you own or operate an existing non-emergency, non-black start CI engine greater than or equal to 300 HP that is not equipped with a closed crankcase ventilation system, you must comply with either paragraph (g)(1) or paragraph (2) of this section. Owners and operators must follow the manufacturer's specified maintenance requirements for operating and maintaining the open or closed crankcase ventilation systems and replacing the crankcase filters, or can request the Administrator to approve different maintenance requirements that are as protective as manufacturer requirements. Existing CI engines located at area sources in areas of Alaska that meet either §63.6603(b)(1) or §63.6603(b)(2) do not have to meet the requirements of this paragraph (g). Existing CI engines located on offshore vessels that meet §63.6603(c) do not have to meet the requirements of this paragraph (g).

(1) Install a closed crankcase ventilation system that prevents crankcase emissions from being emitted to the atmosphere, or

(2) Install an open crankcase filtration emission control system that reduces emissions from the crankcase by filtering the exhaust stream to remove oil mist, particulates and metals.

(h) If you operate a new, reconstructed, or existing stationary engine, you must minimize the engine's time spent at idle during startup and minimize the engine's startup time to a period needed for appropriate and safe loading of the engine, not to exceed 30 minutes, after which time the emission standards applicable to all times other than startup in Tables 1a, 2a, 2c, and 2d to this subpart apply.

(i) If you own or operate a stationary CI engine that is subject to the work, operation or management practices in items 1 or 2 of Table 2c to this subpart or in items 1 or 4 of Table 2d to this subpart, you have the option of utilizing an oil analysis program in order to extend the specified oil change requirement in Tables 2c and 2d to this subpart. The oil analysis must be performed at the same frequency specified for changing the oil in Table 2c or 2d to this subpart. The analysis program must at a minimum analyze the following three parameters: Total Base Number, viscosity, and percent water content. The condemning limits for these parameters are as follows: Total Base Number is less than 30 percent of the Total Base Number of the oil when new; viscosity of the oil has changed by more than 20 percent from the viscosity of the oil when new; or percent water content (by volume) is greater than 0.5. If all of these condemning limits are not exceeded, the engine owner or operator is not required to change the oil. If any of the limits are exceeded, the engine owner or operator must change the oil within 2 business days of receiving the results of the analysis; if the engine is not in operation when the results of the analysis are received, the engine owner or operator must change the oil within 2 business days or before commencing operation, whichever is later. The owner or operator must keep records of the parameters that are analyzed as part of the program, the results of the analysis, and the oil changes for the engine. The analysis program must be part of the maintenance plan for the engine.

(j) If you own or operate a stationary SI engine that is subject to the work, operation or management practices in items 6, 7, or 8 of Table 2c to this subpart or in items 5, 6, 7, 9, or 11 of Table 2d to this subpart, you have the option of utilizing an oil analysis program in order to extend the specified oil change requirement in Tables 2c and 2d to this subpart. The oil analysis must be performed at the same frequency specified for changing the oil in Table 2c or 2d to this subpart. The analysis program must at a minimum analyze the following three parameters: Total Acid Number, viscosity, and percent water content. The condemning limits for these parameters are as follows: Total Acid Number increases by more than 3.0 milligrams of potassium hydroxide (KOH) per gram from Total Acid Number of the oil when new; viscosity of the oil has changed by more than 20 percent from the viscosity of the oil when new; or percent water content (by volume) is greater than 0.5. If all of these condemning limits are not exceeded, the engine owner or operator is not required to change the oil. If any of the limits are exceeded, the engine owner or operator must change the oil within 2 business days of receiving the results of the analysis; if the engine is not in operation when the results of the analysis are received, the engine owner or operator must change the oil within 2 business days or before commencing operation, whichever is later. The owner or operator must keep records of the parameters that are analyzed as part of the program, the results of the analysis, and the oil changes for the engine. The analysis program must be part of the maintenance plan for the engine.

[69 FR 33506, June 15, 2004, as amended at 73 FR 3606, Jan. 18, 2008; 75 FR 9676, Mar. 3, 2010; 75 FR 51589, Aug. 20, 2010; 76 FR 12866, Mar. 9, 2011; 78 FR 6703, Jan. 30, 2013]

[↑ Back to Top](#)

### **§63.6630 How do I demonstrate initial compliance with the emission limitations, operating limitations, and other requirements?**

- (a) You must demonstrate initial compliance with each emission limitation, operating limitation, and other requirement that applies to you according to Table 5 of this subpart.
- (b) During the initial performance test, you must establish each operating limitation in Tables 1b and 2b of this subpart that applies to you.
- (c) You must submit the Notification of Compliance Status containing the results of the initial compliance demonstration according to the requirements in §63.6645.
- (d) Non-emergency 4SRB stationary RICE complying with the requirement to reduce formaldehyde emissions by 76 percent or more can demonstrate initial compliance with the formaldehyde emission limit by testing for THC instead of formaldehyde. The testing must be conducted according to the requirements in Table 4 of this subpart. The average reduction of emissions of THC determined from the performance test must be equal to or greater than 30 percent.
- (e) The initial compliance demonstration required for existing non-emergency 4SLB and 4SRB stationary RICE with a site rating of more than 500 HP located at an area source of HAP that are not remote stationary RICE and that are operated more than 24 hours per calendar year must be conducted according to the following requirements:
  - (1) The compliance demonstration must consist of at least three test runs.

(2) Each test run must be of at least 15 minute duration, except that each test conducted using the method in appendix A to this subpart must consist of at least one measurement cycle and include at least 2 minutes of test data phase measurement.

(3) If you are demonstrating compliance with the CO concentration or CO percent reduction requirement, you must measure CO emissions using one of the CO measurement methods specified in Table 4 of this subpart, or using appendix A to this subpart.

(4) If you are demonstrating compliance with the THC percent reduction requirement, you must measure THC emissions using Method 25A, reported as propane, of 40 CFR part 60, appendix A.

(5) You must measure O<sub>2</sub> using one of the O<sub>2</sub> measurement methods specified in Table 4 of this subpart. Measurements to determine O<sub>2</sub> concentration must be made at the same time as the measurements for CO or THC concentration.

(6) If you are demonstrating compliance with the CO or THC percent reduction requirement, you must measure CO or THC emissions and O<sub>2</sub> emissions simultaneously at the inlet and outlet of the control device.

[69 FR 33506, June 15, 2004, as amended at 78 FR 6704, Jan. 30, 2013]

[↑ Back to Top](#)

## **Continuous Compliance Requirements**

[↑ Back to Top](#)

### **§63.6635 How do I monitor and collect data to demonstrate continuous compliance?**

(a) If you must comply with emission and operating limitations, you must monitor and collect data according to this section.

(b) Except for monitor malfunctions, associated repairs, required performance evaluations, and required quality assurance or control activities, you must monitor continuously at all times that the stationary RICE is operating. A monitoring malfunction is any sudden, infrequent, not reasonably preventable failure of the monitoring to provide valid data. Monitoring failures that are caused in part by poor maintenance or careless operation are not malfunctions.

(c) You may not use data recorded during monitoring malfunctions, associated repairs, and required quality assurance or control activities in data averages and calculations used to report emission or operating levels. You must, however, use all the valid data collected during all other periods.

[69 FR 33506, June 15, 2004, as amended at 76 FR 12867, Mar. 9, 2011]

[↑ Back to Top](#)

### **§63.6640 How do I demonstrate continuous compliance with the emission limitations, operating limitations, and other requirements?**

(a) You must demonstrate continuous compliance with each emission limitation, operating limitation, and other requirements in Tables 1a and 1b, Tables 2a and 2b, Table 2c, and Table 2d to this subpart that apply to you according to methods specified in Table 6 to this subpart.

(b) You must report each instance in which you did not meet each emission limitation or operating limitation in Tables 1a and 1b, Tables 2a and 2b, Table 2c, and Table 2d to this subpart that apply to you. These instances are deviations from the emission and operating limitations in this subpart. These deviations must be reported according to the requirements in §63.6650. If you change your catalyst, you must reestablish the values of the operating parameters measured during the initial performance test. When you reestablish the values of your operating parameters, you must also conduct a performance test to demonstrate that you are meeting the required emission limitation applicable to your stationary RICE.

(c) The annual compliance demonstration required for existing non-emergency 4SLB and 4SRB stationary RICE with a site rating of more than 500 HP located at an area source of HAP that are not remote stationary RICE and that are operated more than 24 hours per calendar year must be conducted according to the following requirements:

(1) The compliance demonstration must consist of at least one test run.

(2) Each test run must be of at least 15 minute duration, except that each test conducted using the method in appendix A to this subpart must consist of at least one measurement cycle and include at least 2 minutes of test data phase measurement.

(3) If you are demonstrating compliance with the CO concentration or CO percent reduction requirement, you must measure CO emissions using one of the CO measurement methods specified in Table 4 of this subpart, or using appendix A to this subpart.

(4) If you are demonstrating compliance with the THC percent reduction requirement, you must measure THC emissions using Method 25A, reported as propane, of 40 CFR part 60, appendix A.

(5) You must measure O<sub>2</sub> using one of the O<sub>2</sub> measurement methods specified in Table 4 of this subpart. Measurements to determine O<sub>2</sub> concentration must be made at the same time as the measurements for CO or THC concentration.

(6) If you are demonstrating compliance with the CO or THC percent reduction requirement, you must measure CO or THC emissions and O<sub>2</sub> emissions simultaneously at the inlet and outlet of the control device.

(7) If the results of the annual compliance demonstration show that the emissions exceed the levels specified in Table 6 of this subpart, the stationary RICE must be shut down as soon as safely possible, and appropriate corrective action must be taken (e.g., repairs, catalyst cleaning, catalyst replacement). The stationary RICE must be retested within 7 days of being restarted and the emissions must meet the levels specified in Table 6 of this subpart. If the retest shows that the emissions continue to exceed the specified levels, the stationary RICE must again be shut down as soon as safely possible, and the stationary RICE may not operate, except for purposes of startup and testing, until the owner/operator demonstrates through testing that the emissions do not exceed the levels specified in Table 6 of this subpart.

(d) For new, reconstructed, and rebuilt stationary RICE, deviations from the emission or operating limitations that occur during the first 200 hours of operation from engine startup (engine burn-in period) are not violations. Rebuilt stationary RICE means a stationary RICE that has been rebuilt as that term is defined in 40 CFR 94.11(a).

(e) You must also report each instance in which you did not meet the requirements in Table 8 to this subpart that apply to you. If you own or operate a new or reconstructed stationary RICE with a site rating of less than or equal to 500 brake HP located at a major source of HAP emissions (except new or reconstructed 4SLB engines greater than or equal to 250 and less than or equal to 500 brake HP), a new or reconstructed stationary RICE located at an area source of HAP emissions, or any of the following RICE with a site rating of more than 500 brake HP located at a major source of HAP emissions, you do not need to comply with the requirements in Table 8 to this subpart: An existing 2SLB stationary RICE, an existing 4SLB stationary RICE, an existing emergency stationary RICE, an existing limited use stationary RICE, or an existing stationary RICE which fires landfill gas or digester gas equivalent to 10 percent or more of the gross heat input on an annual basis. If you own or operate any of the following RICE with a site rating of more than 500 brake HP located at a major source of HAP emissions, you do not need to comply with the requirements in Table 8 to this subpart, except for the initial notification requirements: a new or reconstructed stationary RICE that combusts landfill gas or digester gas equivalent to 10 percent or more of the gross heat input on an annual basis, a new or reconstructed emergency stationary RICE, or a new or reconstructed limited use stationary RICE.

(f) If you own or operate an emergency stationary RICE, you must operate the emergency stationary RICE according to the requirements in paragraphs (f)(1) through (4) of this section. In order for the engine to be considered an emergency stationary RICE under this subpart, any operation other than emergency operation, maintenance and testing, emergency demand response, and operation in non-emergency situations for 50 hours per year, as described in paragraphs (f)(1) through (4) of this section, is prohibited. If you do not operate the engine according to the requirements in paragraphs (f)(1) through (4) of this section, the engine will not be considered an emergency engine under this subpart and must meet all requirements for non-emergency engines.

(1) There is no time limit on the use of emergency stationary RICE in emergency situations.

(2) You may operate your emergency stationary RICE for any combination of the purposes specified in paragraphs (f)(2)(i) through (iii) of this section for a maximum of 100 hours per calendar year. Any operation for non-emergency situations as allowed by paragraphs (f)(3) and (4) of this section counts as part of the 100 hours per calendar year allowed by this paragraph (f)(2).

(i) Emergency stationary RICE may be operated for maintenance checks and readiness testing, provided that the tests are recommended by federal, state or local government, the manufacturer, the vendor, the regional transmission organization or equivalent balancing authority and transmission operator, or the insurance company associated with the engine. The owner or operator may petition the Administrator for approval of additional hours to be used for maintenance checks and readiness testing, but a petition is not required if the owner or operator maintains records indicating that federal, state, or local standards require maintenance and testing of emergency RICE beyond 100 hours per calendar year.



(ii) Emergency stationary RICE may be operated for emergency demand response for periods in which the Reliability Coordinator under the North American Electric Reliability Corporation (NERC) Reliability Standard EOP-002-3, Capacity and Energy Emergencies (incorporated by reference, see §63.14), or other authorized entity as determined by the Reliability Coordinator, has declared an Energy Emergency Alert Level 2 as defined in the NERC Reliability Standard EOP-002-3.

(iii) Emergency stationary RICE may be operated for periods where there is a deviation of voltage or frequency of 5 percent or greater below standard voltage or frequency.

(3) Emergency stationary RICE located at major sources of HAP may be operated for up to 50 hours per calendar year in non-emergency situations. The 50 hours of operation in non-emergency situations are counted as part of the 100 hours per calendar year for maintenance and testing and emergency demand response provided in paragraph (f)(2) of this section. The 50 hours per year for non-emergency situations cannot be used for peak shaving or non-emergency demand response, or to generate income for a facility to supply power to an electric grid or otherwise supply power as part of a financial arrangement with another entity.

(4) Emergency stationary RICE located at area sources of HAP may be operated for up to 50 hours per calendar year in non-emergency situations. The 50 hours of operation in non-emergency situations are counted as part of the 100 hours per calendar year for maintenance and testing and emergency demand response provided in paragraph (f)(2) of this section. Except as provided in paragraphs (f)(4)(i) and (ii) of this section, the 50 hours per year for non-emergency situations cannot be used for peak shaving or non-emergency demand response, or to generate income for a facility to an electric grid or otherwise supply power as part of a financial arrangement with another entity.

(i) Prior to May 3, 2014, the 50 hours per year for non-emergency situations can be used for peak shaving or non-emergency demand response to generate income for a facility, or to otherwise supply power as part of a financial arrangement with another entity if the engine is operated as part of a peak shaving (load management program) with the local distribution system operator and the power is provided only to the facility itself or to support the local distribution system.

(ii) The 50 hours per year for non-emergency situations can be used to supply power as part of a financial arrangement with another entity if all of the following conditions are met:

(A) The engine is dispatched by the local balancing authority or local transmission and distribution system operator.

(B) The dispatch is intended to mitigate local transmission and/or distribution limitations so as to avert potential voltage collapse or line overloads that could lead to the interruption of power supply in a local area or region.

(C) The dispatch follows reliability, emergency operation or similar protocols that follow specific NERC, regional, state, public utility commission or local standards or guidelines.

(D) The power is provided only to the facility itself or to support the local transmission and distribution system.

(E) The owner or operator identifies and records the entity that dispatches the engine and the specific NERC, regional, state, public utility commission or local standards or guidelines that are being followed for dispatching the engine. The local balancing authority or local transmission and distribution system operator may keep these records on behalf of the engine owner or operator.

[69 FR 33506, June 15, 2004, as amended at 71 FR 20467, Apr. 20, 2006; 73 FR 3606, Jan. 18, 2008; 75 FR 9676, Mar. 3, 2010; 75 FR 51591, Aug. 20, 2010; 78 FR 6704, Jan. 30, 2013]

[↑ Back to Top](#)

## Notifications, Reports, and Records

[↑ Back to Top](#)

### **§63.6645 What notifications must I submit and when?**

(a) You must submit all of the notifications in §§63.7(b) and (c), 63.8(e), (f)(4) and (f)(6), 63.9(b) through (e), and (g) and (h) that apply to you by the dates specified if you own or operate any of the following:

(1) An existing stationary RICE with a site rating of less than or equal to 500 brake HP located at a major source of HAP emissions.

(2) An existing stationary RICE located at an area source of HAP emissions.

(3) A stationary RICE with a site rating of more than 500 brake HP located at a major source of HAP emissions.

(4) A new or reconstructed 4SLB stationary RICE with a site rating of greater than or equal to 250 HP located at a major source of HAP emissions.

(5) This requirement does not apply if you own or operate an existing stationary RICE less than 100 HP, an existing stationary emergency RICE, or an existing stationary RICE that is not subject to any numerical emission standards.

(b) As specified in §63.9(b)(2), if you start up your stationary RICE with a site rating of more than 500 brake HP located at a major source of HAP emissions before the effective date of this subpart, you must submit an Initial Notification not later than December 13, 2004.

(c) If you start up your new or reconstructed stationary RICE with a site rating of more than 500 brake HP located at a major source of HAP emissions on or after August 16, 2004, you must submit an Initial Notification not later than 120 days after you become subject to this subpart.

(d) As specified in §63.9(b)(2), if you start up your stationary RICE with a site rating of equal to or less than 500 brake HP located at a major source of HAP emissions before the effective date of this subpart and you are required to submit an initial notification, you must submit an Initial Notification not later than July 16, 2008.

(e) If you start up your new or reconstructed stationary RICE with a site rating of equal to or less than 500 brake HP located at a major source of HAP emissions on or after March 18, 2008 and you are required to

submit an initial notification, you must submit an Initial Notification not later than 120 days after you become subject to this subpart.

(f) If you are required to submit an Initial Notification but are otherwise not affected by the requirements of this subpart, in accordance with §63.6590(b), your notification should include the information in §63.9(b)(2)(i) through (v), and a statement that your stationary RICE has no additional requirements and explain the basis of the exclusion (for example, that it operates exclusively as an emergency stationary RICE if it has a site rating of more than 500 brake HP located at a major source of HAP emissions).

(g) If you are required to conduct a performance test, you must submit a Notification of Intent to conduct a performance test at least 60 days before the performance test is scheduled to begin as required in §63.7(b)(1).

(h) If you are required to conduct a performance test or other initial compliance demonstration as specified in Tables 4 and 5 to this subpart, you must submit a Notification of Compliance Status according to §63.9(h)(2)(ii).

(1) For each initial compliance demonstration required in Table 5 to this subpart that does not include a performance test, you must submit the Notification of Compliance Status before the close of business on the 30th day following the completion of the initial compliance demonstration.

(2) For each initial compliance demonstration required in Table 5 to this subpart that includes a performance test conducted according to the requirements in Table 3 to this subpart, you must submit the Notification of Compliance Status, including the performance test results, before the close of business on the 60th day following the completion of the performance test according to §63.10(d)(2).

(i) If you own or operate an existing non-emergency CI RICE with a site rating of more than 300 HP located at an area source of HAP emissions that is certified to the Tier 1 or Tier 2 emission standards in Table 1 of 40 CFR 89.112 and subject to an enforceable state or local standard requiring engine replacement and you intend to meet management practices rather than emission limits, as specified in §63.6603(d), you must submit a notification by March 3, 2013, stating that you intend to use the provision in §63.6603(d) and identifying the state or local regulation that the engine is subject to.

[73 FR 3606, Jan. 18, 2008, as amended at 75 FR 9677, Mar. 3, 2010; 75 FR 51591, Aug. 20, 2010; 78 FR 6705, Jan. 30, 2013]

[↑ Back to Top](#)

### **§63.6650 What reports must I submit and when?**

(a) You must submit each report in Table 7 of this subpart that applies to you.

(b) Unless the Administrator has approved a different schedule for submission of reports under §63.10(a), you must submit each report by the date in Table 7 of this subpart and according to the requirements in paragraphs (b)(1) through (b)(9) of this section.

(1) For semiannual Compliance reports, the first Compliance report must cover the period beginning on the compliance date that is specified for your affected source in §63.6595 and ending on June 30 or

December 31, whichever date is the first date following the end of the first calendar half after the compliance date that is specified for your source in §63.6595.

(2) For semiannual Compliance reports, the first Compliance report must be postmarked or delivered no later than July 31 or January 31, whichever date follows the end of the first calendar half after the compliance date that is specified for your affected source in §63.6595.

(3) For semiannual Compliance reports, each subsequent Compliance report must cover the semiannual reporting period from January 1 through June 30 or the semiannual reporting period from July 1 through December 31.

(4) For semiannual Compliance reports, each subsequent Compliance report must be postmarked or delivered no later than July 31 or January 31, whichever date is the first date following the end of the semiannual reporting period.

(5) For each stationary RICE that is subject to permitting regulations pursuant to 40 CFR part 70 or 71, and if the permitting authority has established dates for submitting semiannual reports pursuant to 40 CFR 70.6(a)(3)(iii)(A) or 40 CFR 71.6 (a)(3)(iii)(A), you may submit the first and subsequent Compliance reports according to the dates the permitting authority has established instead of according to the dates in paragraphs (b)(1) through (b)(4) of this section.

(6) For annual Compliance reports, the first Compliance report must cover the period beginning on the compliance date that is specified for your affected source in §63.6595 and ending on December 31.

(7) For annual Compliance reports, the first Compliance report must be postmarked or delivered no later than January 31 following the end of the first calendar year after the compliance date that is specified for your affected source in §63.6595.

(8) For annual Compliance reports, each subsequent Compliance report must cover the annual reporting period from January 1 through December 31.

(9) For annual Compliance reports, each subsequent Compliance report must be postmarked or delivered no later than January 31.

(c) The Compliance report must contain the information in paragraphs (c)(1) through (6) of this section.

(1) Company name and address.

(2) Statement by a responsible official, with that official's name, title, and signature, certifying the accuracy of the content of the report.

(3) Date of report and beginning and ending dates of the reporting period.

(4) If you had a malfunction during the reporting period, the compliance report must include the number, duration, and a brief description for each type of malfunction which occurred during the reporting period and which caused or may have caused any applicable emission limitation to be exceeded. The report must also include a description of actions taken by an owner or operator during a malfunction of an affected

source to minimize emissions in accordance with §63.6605(b), including actions taken to correct a malfunction.

(5) If there are no deviations from any emission or operating limitations that apply to you, a statement that there were no deviations from the emission or operating limitations during the reporting period.

(6) If there were no periods during which the continuous monitoring system (CMS), including CEMS and CPMS, was out-of-control, as specified in §63.8(c)(7), a statement that there were no periods during which the CMS was out-of-control during the reporting period.

(d) For each deviation from an emission or operating limitation that occurs for a stationary RICE where you are not using a CMS to comply with the emission or operating limitations in this subpart, the Compliance report must contain the information in paragraphs (c)(1) through (4) of this section and the information in paragraphs (d)(1) and (2) of this section.

(1) The total operating time of the stationary RICE at which the deviation occurred during the reporting period.

(2) Information on the number, duration, and cause of deviations (including unknown cause, if applicable), as applicable, and the corrective action taken.

(e) For each deviation from an emission or operating limitation occurring for a stationary RICE where you are using a CMS to comply with the emission and operating limitations in this subpart, you must include information in paragraphs (c)(1) through (4) and (e)(1) through (12) of this section.

(1) The date and time that each malfunction started and stopped.

(2) The date, time, and duration that each CMS was inoperative, except for zero (low-level) and high-level checks.

(3) The date, time, and duration that each CMS was out-of-control, including the information in §63.8(c)(8).

(4) The date and time that each deviation started and stopped, and whether each deviation occurred during a period of malfunction or during another period.

(5) A summary of the total duration of the deviation during the reporting period, and the total duration as a percent of the total source operating time during that reporting period.

(6) A breakdown of the total duration of the deviations during the reporting period into those that are due to control equipment problems, process problems, other known causes, and other unknown causes.

(7) A summary of the total duration of CMS downtime during the reporting period, and the total duration of CMS downtime as a percent of the total operating time of the stationary RICE at which the CMS downtime occurred during that reporting period.

(8) An identification of each parameter and pollutant (CO or formaldehyde) that was monitored at the stationary RICE.

(9) A brief description of the stationary RICE.

(10) A brief description of the CMS.

(11) The date of the latest CMS certification or audit.

(12) A description of any changes in CMS, processes, or controls since the last reporting period.

(f) Each affected source that has obtained a title V operating permit pursuant to 40 CFR part 70 or 71 must report all deviations as defined in this subpart in the semiannual monitoring report required by 40 CFR 70.6 (a)(3)(iii)(A) or 40 CFR 71.6(a)(3)(iii)(A). If an affected source submits a Compliance report pursuant to Table 7 of this subpart along with, or as part of, the semiannual monitoring report required by 40 CFR 70.6(a)(3)(iii)(A) or 40 CFR 71.6(a)(3)(iii)(A), and the Compliance report includes all required information concerning deviations from any emission or operating limitation in this subpart, submission of the Compliance report shall be deemed to satisfy any obligation to report the same deviations in the semiannual monitoring report. However, submission of a Compliance report shall not otherwise affect any obligation the affected source may have to report deviations from permit requirements to the permit authority.

(g) If you are operating as a new or reconstructed stationary RICE which fires landfill gas or digester gas equivalent to 10 percent or more of the gross heat input on an annual basis, you must submit an annual report according to Table 7 of this subpart by the date specified unless the Administrator has approved a different schedule, according to the information described in paragraphs (b)(1) through (b)(5) of this section. You must report the data specified in (g)(1) through (g)(3) of this section.

(1) Fuel flow rate of each fuel and the heating values that were used in your calculations. You must also demonstrate that the percentage of heat input provided by landfill gas or digester gas is equivalent to 10 percent or more of the total fuel consumption on an annual basis.

(2) The operating limits provided in your federally enforceable permit, and any deviations from these limits.

(3) Any problems or errors suspected with the meters.

(h) If you own or operate an emergency stationary RICE with a site rating of more than 100 brake HP that operates or is contractually obligated to be available for more than 15 hours per calendar year for the purposes specified in §63.6640(f)(2)(ii) and (iii) or that operates for the purpose specified in §63.6640(f)(4)(ii), you must submit an annual report according to the requirements in paragraphs (h)(1) through (3) of this section.

(1) The report must contain the following information:

(i) Company name and address where the engine is located.

(ii) Date of the report and beginning and ending dates of the reporting period.

(iii) Engine site rating and model year.

(iv) Latitude and longitude of the engine in decimal degrees reported to the fifth decimal place.

(v) Hours operated for the purposes specified in §63.6640(f)(2)(ii) and (iii), including the date, start time, and end time for engine operation for the purposes specified in §63.6640(f)(2)(ii) and (iii).

(vi) Number of hours the engine is contractually obligated to be available for the purposes specified in §63.6640(f)(2)(ii) and (iii).

(vii) Hours spent for operation for the purpose specified in §63.6640(f)(4)(ii), including the date, start time, and end time for engine operation for the purposes specified in §63.6640(f)(4)(ii). The report must also identify the entity that dispatched the engine and the situation that necessitated the dispatch of the engine.

(viii) If there were no deviations from the fuel requirements in §63.6604 that apply to the engine (if any), a statement that there were no deviations from the fuel requirements during the reporting period.

(ix) If there were deviations from the fuel requirements in §63.6604 that apply to the engine (if any), information on the number, duration, and cause of deviations, and the corrective action taken.

(2) The first annual report must cover the calendar year 2015 and must be submitted no later than March 31, 2016. Subsequent annual reports for each calendar year must be submitted no later than March 31 of the following calendar year.

(3) The annual report must be submitted electronically using the subpart specific reporting form in the Compliance and Emissions Data Reporting Interface (CEDRI) that is accessed through EPA's Central Data Exchange (CDX) ([www.epa.gov/cdx](http://www.epa.gov/cdx)). However, if the reporting form specific to this subpart is not available in CEDRI at the time that the report is due, the written report must be submitted to the Administrator at the appropriate address listed in §63.13.

[69 FR 33506, June 15, 2004, as amended at 75 FR 9677, Mar. 3, 2010; 78 FR 6705, Jan. 30, 2013]

[↑ Back to Top](#)

### **§63.6655 What records must I keep?**

(a) If you must comply with the emission and operating limitations, you must keep the records described in paragraphs (a)(1) through (a)(5), (b)(1) through (b)(3) and (c) of this section.

(1) A copy of each notification and report that you submitted to comply with this subpart, including all documentation supporting any Initial Notification or Notification of Compliance Status that you submitted, according to the requirement in §63.10(b)(2)(xiv).

(2) Records of the occurrence and duration of each malfunction of operation (*i.e.*, process equipment) or the air pollution control and monitoring equipment.

(3) Records of performance tests and performance evaluations as required in §63.10(b)(2)(viii).

(4) Records of all required maintenance performed on the air pollution control and monitoring equipment.

(5) Records of actions taken during periods of malfunction to minimize emissions in accordance with §63.6605(b), including corrective actions to restore malfunctioning process and air pollution control and monitoring equipment to its normal or usual manner of operation.

(b) For each CEMS or CPMS, you must keep the records listed in paragraphs (b)(1) through (3) of this section.

(1) Records described in §63.10(b)(2)(vi) through (xi).

(2) Previous (*i.e.*, superseded) versions of the performance evaluation plan as required in §63.8(d)(3).

(3) Requests for alternatives to the relative accuracy test for CEMS or CPMS as required in §63.8(f)(6)(i), if applicable.

(c) If you are operating a new or reconstructed stationary RICE which fires landfill gas or digester gas equivalent to 10 percent or more of the gross heat input on an annual basis, you must keep the records of your daily fuel usage monitors.

(d) You must keep the records required in Table 6 of this subpart to show continuous compliance with each emission or operating limitation that applies to you.

(e) You must keep records of the maintenance conducted on the stationary RICE in order to demonstrate that you operated and maintained the stationary RICE and after-treatment control device (if any) according to your own maintenance plan if you own or operate any of the following stationary RICE;

(1) An existing stationary RICE with a site rating of less than 100 brake HP located at a major source of HAP emissions.

(2) An existing stationary emergency RICE.

(3) An existing stationary RICE located at an area source of HAP emissions subject to management practices as shown in Table 2d to this subpart.

(f) If you own or operate any of the stationary RICE in paragraphs (f)(1) through (2) of this section, you must keep records of the hours of operation of the engine that is recorded through the non-resettable hour meter. The owner or operator must document how many hours are spent for emergency operation, including what classified the operation as emergency and how many hours are spent for non-emergency operation. If the engine is used for the purposes specified in §63.6640(f)(2)(ii) or (iii) or §63.6640(f)(4)(ii), the owner or operator must keep records of the notification of the emergency situation, and the date, start time, and end time of engine operation for these purposes.

(1) An existing emergency stationary RICE with a site rating of less than or equal to 500 brake HP located at a major source of HAP emissions that does not meet the standards applicable to non-emergency engines.

(2) An existing emergency stationary RICE located at an area source of HAP emissions that does not meet the standards applicable to non-emergency engines.



[69 FR 33506, June 15, 2004, as amended at 75 FR 9678, Mar. 3, 2010; 75 FR 51592, Aug. 20, 2010; 78 FR 6706, Jan. 30, 2013]

[↑ Back to Top](#)

### **§63.6660 In what form and how long must I keep my records?**

(a) Your records must be in a form suitable and readily available for expeditious review according to §63.10(b)(1).

(b) As specified in §63.10(b)(1), you must keep each record for 5 years following the date of each occurrence, measurement, maintenance, corrective action, report, or record.

(c) You must keep each record readily accessible in hard copy or electronic form for at least 5 years after the date of each occurrence, measurement, maintenance, corrective action, report, or record, according to §63.10(b)(1).

[69 FR 33506, June 15, 2004, as amended at 75 FR 9678, Mar. 3, 2010]

[↑ Back to Top](#)

### **Other Requirements and Information**

[↑ Back to Top](#)

### **§63.6665 What parts of the General Provisions apply to me?**

Table 8 to this subpart shows which parts of the General Provisions in §§63.1 through 63.15 apply to you. If you own or operate a new or reconstructed stationary RICE with a site rating of less than or equal to 500 brake HP located at a major source of HAP emissions (except new or reconstructed 4SLB engines greater than or equal to 250 and less than or equal to 500 brake HP), a new or reconstructed stationary RICE located at an area source of HAP emissions, or any of the following RICE with a site rating of more than 500 brake HP located at a major source of HAP emissions, you do not need to comply with any of the requirements of the General Provisions specified in Table 8: An existing 2SLB stationary RICE, an existing 4SLB stationary RICE, an existing stationary RICE that combusts landfill or digester gas equivalent to 10 percent or more of the gross heat input on an annual basis, an existing emergency stationary RICE, or an existing limited use stationary RICE. If you own or operate any of the following RICE with a site rating of more than 500 brake HP located at a major source of HAP emissions, you do not need to comply with the requirements in the General Provisions specified in Table 8 except for the initial notification requirements: A new stationary RICE that combusts landfill gas or digester gas equivalent to 10 percent or more of the gross heat input on an annual basis, a new emergency stationary RICE, or a new limited use stationary RICE.

[75 FR 9678, Mar. 3, 2010]

[↑ Back to Top](#)

### **§63.6670 Who implements and enforces this subpart?**

(a) This subpart is implemented and enforced by the U.S. EPA, or a delegated authority such as your State, local, or tribal agency. If the U.S. EPA Administrator has delegated authority to your State, local, or tribal agency, then that agency (as well as the U.S. EPA) has the authority to implement and enforce this subpart. You should contact your U.S. EPA Regional Office to find out whether this subpart is delegated to your State, local, or tribal agency.

(b) In delegating implementation and enforcement authority of this subpart to a State, local, or tribal agency under 40 CFR part 63, subpart E, the authorities contained in paragraph (c) of this section are retained by the Administrator of the U.S. EPA and are not transferred to the State, local, or tribal agency.

(c) The authorities that will not be delegated to State, local, or tribal agencies are:

(1) Approval of alternatives to the non-opacity emission limitations and operating limitations in §63.6600 under §63.6(g).

(2) Approval of major alternatives to test methods under §63.7(e)(2)(ii) and (f) and as defined in §63.90.

(3) Approval of major alternatives to monitoring under §63.8(f) and as defined in §63.90.

(4) Approval of major alternatives to recordkeeping and reporting under §63.10(f) and as defined in §63.90.

(5) Approval of a performance test which was conducted prior to the effective date of the rule, as specified in §63.6610(b).

[↑ Back to Top](#)

### **§63.6675 What definitions apply to this subpart?**

Terms used in this subpart are defined in the Clean Air Act (CAA); in 40 CFR 63.2, the General Provisions of this part; and in this section as follows:

*Alaska Railbelt Grid* means the service areas of the six regulated public utilities that extend from Fairbanks to Anchorage and the Kenai Peninsula. These utilities are Golden Valley Electric Association; Chugach Electric Association; Matanuska Electric Association; Homer Electric Association; Anchorage Municipal Light & Power; and the City of Seward Electric System.

*Area source* means any stationary source of HAP that is not a major source as defined in part 63.

*Associated equipment* as used in this subpart and as referred to in section 112(n)(4) of the CAA, means equipment associated with an oil or natural gas exploration or production well, and includes all equipment from the well bore to the point of custody transfer, except glycol dehydration units, storage vessels with potential for flash emissions, combustion turbines, and stationary RICE.

*Backup power for renewable energy* means an engine that provides backup power to a facility that generates electricity from renewable energy resources, as that term is defined in Alaska Statute 42.45.045(1)(5) (incorporated by reference, see §63.14).

*Black start engine* means an engine whose only purpose is to start up a combustion turbine.

CAA means the Clean Air Act (42 U.S.C. 7401 *et seq.*, as amended by Public Law 101-549, 104 Stat. 2399).

*Commercial emergency stationary RICE* means an emergency stationary RICE used in commercial establishments such as office buildings, hotels, stores, telecommunications facilities, restaurants, financial institutions such as banks, doctor's offices, and sports and performing arts facilities.

*Compression ignition* means relating to a type of stationary internal combustion engine that is not a spark ignition engine.

*Custody transfer* means the transfer of hydrocarbon liquids or natural gas: After processing and/or treatment in the producing operations, or from storage vessels or automatic transfer facilities or other such equipment, including product loading racks, to pipelines or any other forms of transportation. For the purposes of this subpart, the point at which such liquids or natural gas enters a natural gas processing plant is a point of custody transfer.

*Deviation* means any instance in which an affected source subject to this subpart, or an owner or operator of such a source:

- (1) Fails to meet any requirement or obligation established by this subpart, including but not limited to any emission limitation or operating limitation;
- (2) Fails to meet any term or condition that is adopted to implement an applicable requirement in this subpart and that is included in the operating permit for any affected source required to obtain such a permit; or
- (3) Fails to meet any emission limitation or operating limitation in this subpart during malfunction, regardless of whether or not such failure is permitted by this subpart.
- (4) Fails to satisfy the general duty to minimize emissions established by §63.6(e)(1)(i).

*Diesel engine* means any stationary RICE in which a high boiling point liquid fuel injected into the combustion chamber ignites when the air charge has been compressed to a temperature sufficiently high for auto-ignition. This process is also known as compression ignition.

*Diesel fuel* means any liquid obtained from the distillation of petroleum with a boiling point of approximately 150 to 360 degrees Celsius. One commonly used form is fuel oil number 2. Diesel fuel also includes any non-distillate fuel with comparable physical and chemical properties (*e.g.* biodiesel) that is suitable for use in compression ignition engines.

*Digester gas* means any gaseous by-product of wastewater treatment typically formed through the anaerobic decomposition of organic waste materials and composed principally of methane and CO<sub>2</sub>.

*Dual-fuel engine* means any stationary RICE in which a liquid fuel (typically diesel fuel) is used for compression ignition and gaseous fuel (typically natural gas) is used as the primary fuel.

*Emergency stationary RICE* means any stationary reciprocating internal combustion engine that meets all of the criteria in paragraphs (1) through (3) of this definition. All emergency stationary RICE must

comply with the requirements specified in §63.6640(f) in order to be considered emergency stationary RICE. If the engine does not comply with the requirements specified in §63.6640(f), then it is not considered to be an emergency stationary RICE under this subpart.

(1) The stationary RICE is operated to provide electrical power or mechanical work during an emergency situation. Examples include stationary RICE used to produce power for critical networks or equipment (including power supplied to portions of a facility) when electric power from the local utility (or the normal power source, if the facility runs on its own power production) is interrupted, or stationary RICE used to pump water in the case of fire or flood, etc.

(2) The stationary RICE is operated under limited circumstances for situations not included in paragraph (1) of this definition, as specified in §63.6640(f).

(3) The stationary RICE operates as part of a financial arrangement with another entity in situations not included in paragraph (1) of this definition only as allowed in §63.6640(f)(2)(ii) or (iii) and §63.6640(f)(4)(i) or (ii).

*Engine startup* means the time from initial start until applied load and engine and associated equipment reaches steady state or normal operation. For stationary engine with catalytic controls, engine startup means the time from initial start until applied load and engine and associated equipment, including the catalyst, reaches steady state or normal operation.

*Four-stroke engine* means any type of engine which completes the power cycle in two crankshaft revolutions, with intake and compression strokes in the first revolution and power and exhaust strokes in the second revolution.

*Gaseous fuel* means a material used for combustion which is in the gaseous state at standard atmospheric temperature and pressure conditions.

*Gasoline* means any fuel sold in any State for use in motor vehicles and motor vehicle engines, or nonroad or stationary engines, and commonly or commercially known or sold as gasoline.

*Glycol dehydration unit* means a device in which a liquid glycol (including, but not limited to, ethylene glycol, diethylene glycol, or triethylene glycol) absorbent directly contacts a natural gas stream and absorbs water in a contact tower or absorption column (absorber). The glycol contacts and absorbs water vapor and other gas stream constituents from the natural gas and becomes “rich” glycol. This glycol is then regenerated in the glycol dehydration unit reboiler. The “lean” glycol is then recycled.

*Hazardous air pollutants (HAP)* means any air pollutants listed in or pursuant to section 112(b) of the CAA.

*Institutional emergency stationary RICE* means an emergency stationary RICE used in institutional establishments such as medical centers, nursing homes, research centers, institutions of higher education, correctional facilities, elementary and secondary schools, libraries, religious establishments, police stations, and fire stations.

*ISO standard day conditions* means 288 degrees Kelvin (15 degrees Celsius), 60 percent relative humidity and 101.3 kilopascals pressure.

*Landfill gas* means a gaseous by-product of the land application of municipal refuse typically formed through the anaerobic decomposition of waste materials and composed principally of methane and CO<sub>2</sub>.

*Lean burn engine* means any two-stroke or four-stroke spark ignited engine that does not meet the definition of a rich burn engine.

*Limited use stationary RICE* means any stationary RICE that operates less than 100 hours per year.

*Liquefied petroleum gas* means any liquefied hydrocarbon gas obtained as a by-product in petroleum refining of natural gas production.

*Liquid fuel* means any fuel in liquid form at standard temperature and pressure, including but not limited to diesel, residual/crude oil, kerosene/naphtha (jet fuel), and gasoline.

*Major Source*, as used in this subpart, shall have the same meaning as in §63.2, except that:

(1) Emissions from any oil or gas exploration or production well (with its associated equipment (as defined in this section)) and emissions from any pipeline compressor station or pump station shall not be aggregated with emissions from other similar units, to determine whether such emission points or stations are major sources, even when emission points are in a contiguous area or under common control;

(2) For oil and gas production facilities, emissions from processes, operations, or equipment that are not part of the same oil and gas production facility, as defined in §63.1271 of subpart HHH of this part, shall not be aggregated;

(3) For production field facilities, only HAP emissions from glycol dehydration units, storage vessel with the potential for flash emissions, combustion turbines and reciprocating internal combustion engines shall be aggregated for a major source determination; and

(4) Emissions from processes, operations, and equipment that are not part of the same natural gas transmission and storage facility, as defined in §63.1271 of subpart HHH of this part, shall not be aggregated.

*Malfunction* means any sudden, infrequent, and not reasonably preventable failure of air pollution control equipment, process equipment, or a process to operate in a normal or usual manner which causes, or has the potential to cause, the emission limitations in an applicable standard to be exceeded. Failures that are caused in part by poor maintenance or careless operation are not malfunctions.

*Natural gas* means a naturally occurring mixture of hydrocarbon and non-hydrocarbon gases found in geologic formations beneath the Earth's surface, of which the principal constituent is methane. Natural gas may be field or pipeline quality.

*Non-selective catalytic reduction (NSCR)* means an add-on catalytic nitrogen oxides (NO<sub>x</sub>) control device for rich burn engines that, in a two-step reaction, promotes the conversion of excess oxygen, NO<sub>x</sub>, CO, and volatile organic compounds (VOC) into CO<sub>2</sub>, nitrogen, and water.

*Oil and gas production facility* as used in this subpart means any grouping of equipment where hydrocarbon liquids are processed, upgraded (*i.e.*, remove impurities or other constituents to meet

contract specifications), or stored prior to the point of custody transfer; or where natural gas is processed, upgraded, or stored prior to entering the natural gas transmission and storage source category. For purposes of a major source determination, facility (including a building, structure, or installation) means oil and natural gas production and processing equipment that is located within the boundaries of an individual surface site as defined in this section. Equipment that is part of a facility will typically be located within close proximity to other equipment located at the same facility. Pieces of production equipment or groupings of equipment located on different oil and gas leases, mineral fee tracts, lease tracts, subsurface or surface unit areas, surface fee tracts, surface lease tracts, or separate surface sites, whether or not connected by a road, waterway, power line or pipeline, shall not be considered part of the same facility. Examples of facilities in the oil and natural gas production source category include, but are not limited to, well sites, satellite tank batteries, central tank batteries, a compressor station that transports natural gas to a natural gas processing plant, and natural gas processing plants.

*Oxidation catalyst* means an add-on catalytic control device that controls CO and VOC by oxidation.

*Peaking unit or engine* means any standby engine intended for use during periods of high demand that are not emergencies.

*Percent load* means the fractional power of an engine compared to its maximum manufacturer's design capacity at engine site conditions. Percent load may range between 0 percent to above 100 percent.

*Potential to emit* means the maximum capacity of a stationary source to emit a pollutant under its physical and operational design. Any physical or operational limitation on the capacity of the stationary source to emit a pollutant, including air pollution control equipment and restrictions on hours of operation or on the type or amount of material combusted, stored, or processed, shall be treated as part of its design if the limitation or the effect it would have on emissions is federally enforceable. For oil and natural gas production facilities subject to subpart HH of this part, the potential to emit provisions in §63.760(a) may be used. For natural gas transmission and storage facilities subject to subpart HHH of this part, the maximum annual facility gas throughput for storage facilities may be determined according to §63.1270(a)(1) and the maximum annual throughput for transmission facilities may be determined according to §63.1270(a)(2).

*Production field facility* means those oil and gas production facilities located prior to the point of custody transfer.

*Production well* means any hole drilled in the earth from which crude oil, condensate, or field natural gas is extracted.

*Propane* means a colorless gas derived from petroleum and natural gas, with the molecular structure  $C_3H_8$ .

*Remote stationary RICE* means stationary RICE meeting any of the following criteria:

(1) Stationary RICE located in an offshore area that is beyond the line of ordinary low water along that portion of the coast of the United States that is in direct contact with the open seas and beyond the line marking the seaward limit of inland waters.

(2) Stationary RICE located on a pipeline segment that meets both of the criteria in paragraphs (2)(i) and (ii) of this definition.

(i) A pipeline segment with 10 or fewer buildings intended for human occupancy and no buildings with four or more stories within 220 yards (200 meters) on either side of the centerline of any continuous 1-mile (1.6 kilometers) length of pipeline. Each separate dwelling unit in a multiple dwelling unit building is counted as a separate building intended for human occupancy.

(ii) The pipeline segment does not lie within 100 yards (91 meters) of either a building or a small, well-defined outside area (such as a playground, recreation area, outdoor theater, or other place of public assembly) that is occupied by 20 or more persons on at least 5 days a week for 10 weeks in any 12-month period. The days and weeks need not be consecutive. The building or area is considered occupied for a full day if it is occupied for any portion of the day.

(iii) For purposes of this paragraph (2), the term pipeline segment means all parts of those physical facilities through which gas moves in transportation, including but not limited to pipe, valves, and other appurtenance attached to pipe, compressor units, metering stations, regulator stations, delivery stations, holders, and fabricated assemblies. Stationary RICE located within 50 yards (46 meters) of the pipeline segment providing power for equipment on a pipeline segment are part of the pipeline segment. Transportation of gas means the gathering, transmission, or distribution of gas by pipeline, or the storage of gas. A building is intended for human occupancy if its primary use is for a purpose involving the presence of humans.

(3) Stationary RICE that are not located on gas pipelines and that have 5 or fewer buildings intended for human occupancy and no buildings with four or more stories within a 0.25 mile radius around the engine. A building is intended for human occupancy if its primary use is for a purpose involving the presence of humans.

*Residential emergency stationary RICE* means an emergency stationary RICE used in residential establishments such as homes or apartment buildings.

*Responsible official* means responsible official as defined in 40 CFR 70.2.

*Rich burn engine* means any four-stroke spark ignited engine where the manufacturer's recommended operating air/fuel ratio divided by the stoichiometric air/fuel ratio at full load conditions is less than or equal to 1.1. Engines originally manufactured as rich burn engines, but modified prior to December 19, 2002 with passive emission control technology for NO<sub>x</sub> (such as pre-combustion chambers) will be considered lean burn engines. Also, existing engines where there are no manufacturer's recommendations regarding air/fuel ratio will be considered a rich burn engine if the excess oxygen content of the exhaust at full load conditions is less than or equal to 2 percent.

*Site-rated HP* means the maximum manufacturer's design capacity at engine site conditions.

*Spark ignition* means relating to either: A gasoline-fueled engine; or any other type of engine with a spark plug (or other sparking device) and with operating characteristics significantly similar to the theoretical Otto combustion cycle. Spark ignition engines usually use a throttle to regulate intake air flow to control power during normal operation. Dual-fuel engines in which a liquid fuel (typically diesel fuel) is used for

CI and gaseous fuel (typically natural gas) is used as the primary fuel at an annual average ratio of less than 2 parts diesel fuel to 100 parts total fuel on an energy equivalent basis are spark ignition engines.

*Stationary reciprocating internal combustion engine (RICE)* means any reciprocating internal combustion engine which uses reciprocating motion to convert heat energy into mechanical work and which is not mobile. Stationary RICE differ from mobile RICE in that a stationary RICE is not a non-road engine as defined at 40 CFR 1068.30, and is not used to propel a motor vehicle or a vehicle used solely for competition.

*Stationary RICE test cell/stand* means an engine test cell/stand, as defined in subpart P P P P P of this part, that tests stationary RICE.

*Stoichiometric* means the theoretical air-to-fuel ratio required for complete combustion.

*Storage vessel with the potential for flash emissions* means any storage vessel that contains a hydrocarbon liquid with a stock tank gas-to-oil ratio equal to or greater than 0.31 cubic meters per liter and an American Petroleum Institute gravity equal to or greater than 40 degrees and an actual annual average hydrocarbon liquid throughput equal to or greater than 79,500 liters per day. Flash emissions occur when dissolved hydrocarbons in the fluid evolve from solution when the fluid pressure is reduced.

*Subpart* means 40 CFR part 63, subpart Z Z Z Z.

*Surface site* means any combination of one or more graded pad sites, gravel pad sites, foundations, platforms, or the immediate physical location upon which equipment is physically affixed.

*Two-stroke engine* means a type of engine which completes the power cycle in single crankshaft revolution by combining the intake and compression operations into one stroke and the power and exhaust operations into a second stroke. This system requires auxiliary scavenging and inherently runs lean of stoichiometric.

[69 FR 33506, June 15, 2004, as amended at 71 FR 20467, Apr. 20, 2006; 73 FR 3607, Jan. 18, 2008; 75 FR 9679, Mar. 3, 2010; 75 FR 51592, Aug. 20, 2010; 76 FR 12867, Mar. 9, 2011; 78 FR 6706, Jan. 30, 2013]

[↑ Back to Top](#)

**Table 1a to Subpart Z Z Z Z of Part 63—Emission Limitations for Existing, New, and Reconstructed Spark Ignition, 4SRB Stationary RICE >500 HP Located at a Major Source of HAP Emissions**

As stated in §§63.6600 and 63.6640, you must comply with the following emission limitations at 100 percent load plus or minus 10 percent for existing, new and reconstructed 4SRB stationary RICE >500 HP located at a major source of HAP emissions:

<b>For each</b> ...	<b>You must meet the following emission limitation, except during periods of startup</b> ...	<b>During periods of startup you must . . .</b>
------------------------	---	---



1. 4SRB stationary RICE	a. Reduce formaldehyde emissions by 76 percent or more. If you commenced construction or reconstruction between December 19, 2002 and June 15, 2004, you may reduce formaldehyde emissions by 75 percent or more until June 15, 2007 or	Minimize the engine's time spent at idle and minimize the engine's startup time at startup to a period needed for appropriate and safe loading of the engine, not to exceed 30 minutes, after which time the non-startup emission limitations apply. <sup>1</sup>
	b. Limit the concentration of formaldehyde in the stationary RICE exhaust to 350 ppbvd or less at 15 percent O <sub>2</sub>	

<sup>1</sup> Sources can petition the Administrator pursuant to the requirements of 40 CFR 63.6(g) for alternative work practices.

[75 FR 9679, Mar. 3, 2010, as amended at 75 FR 51592, Aug. 20, 2010]

[↑ Back to Top](#)

**Table 1b to Subpart ZZZZ of Part 63—Operating Limitations for Existing, New, and Reconstructed SI 4SRB Stationary RICE >500 HP Located at a Major Source of HAP Emissions**

As stated in §§63.6600, 63.6603, 63.6630 and 63.6640, you must comply with the following operating limitations for existing, new and reconstructed 4SRB stationary RICE >500 HP located at a major source of HAP emissions:

<b>For each . . .</b>	<b>You must meet the following operating limitation, except during periods of startup . . .</b>
1. existing, new and reconstructed 4SRB stationary RICE >500 HP located at a major source of HAP emissions complying with the requirement to reduce formaldehyde emissions by 76 percent or more (or by 75 percent or more, if applicable) and using NSCR; or existing, new and reconstructed 4SRB stationary RICE >500 HP located at a major source of HAP emissions complying with the requirement to limit the concentration of formaldehyde in the stationary RICE exhaust to 350 ppbvd or less at 15 percent O <sub>2</sub> and using NSCR;	a. maintain your catalyst so that the pressure drop across the catalyst does not change by more than 2 inches of water at 100 percent load plus or minus 10 percent from the pressure drop across the catalyst measured during the initial performance test; and b. maintain the temperature of your stationary RICE exhaust so that the catalyst inlet temperature is greater than or equal to 750 °F and less than or equal to 1250 °F. <sup>1</sup>
2. existing, new and reconstructed 4SRB stationary RICE >500 HP located at a major source of HAP emissions complying with the requirement to reduce formaldehyde emissions by 76 percent or more (or by	Comply with any operating limitations approved by the Administrator.

75 percent or more, if applicable) and not using NSCR; or	
existing, new and reconstructed 4SRB stationary RICE >500 HP located at a major source of HAP emissions complying with the requirement to limit the concentration of formaldehyde in the stationary RICE exhaust to 350 ppbvd or less at 15 percent O <sub>2</sub> and not using NSCR.	

<sup>1</sup>Sources can petition the Administrator pursuant to the requirements of 40 CFR 63.8(f) for a different temperature range.

[78 FR 6706, Jan. 30, 2013]

[↑ Back to Top](#)

**Table 2a to Subpart ZZZZ of Part 63—Emission Limitations for New and Reconstructed 2SLB and Compression Ignition Stationary RICE >500 HP and New and Reconstructed 4SLB Stationary RICE ≥250 HP Located at a Major Source of HAP Emissions**

As stated in §§63.6600 and 63.6640, you must comply with the following emission limitations for new and reconstructed lean burn and new and reconstructed compression ignition stationary RICE at 100 percent load plus or minus 10 percent:

For each . . .	You must meet the following emission limitation, except during periods of startup . . .	During periods of startup you must . . .
1. 2SLB stationary RICE	a. Reduce CO emissions by 58 percent or more; or b. Limit concentration of formaldehyde in the stationary RICE exhaust to 12 ppmvd or less at 15 percent O <sub>2</sub> . If you commenced construction or reconstruction between December 19, 2002 and June 15, 2004, you may limit concentration of formaldehyde to 17 ppmvd or less at 15 percent O <sub>2</sub> until June 15, 2007	Minimize the engine's time spent at idle and minimize the engine's startup time at startup to a period needed for appropriate and safe loading of the engine, not to exceed 30 minutes, after which time the non-startup emission limitations apply. <sup>1</sup>
2. 4SLB stationary RICE	a. Reduce CO emissions by 93 percent or more; or	
	b. Limit concentration of formaldehyde in the stationary RICE exhaust to 14 ppmvd or less at 15	

	percent O <sub>2</sub>	
3. CI stationary RICE	a. Reduce CO emissions by 70 percent or more; or	
	b. Limit concentration of formaldehyde in the stationary RICE exhaust to 580 ppbvd or less at 15 percent O <sub>2</sub>	

<sup>1</sup>Sources can petition the Administrator pursuant to the requirements of 40 CFR 63.6(g) for alternative work practices.

[75 FR 9680, Mar. 3, 2010]

[↑ Back to Top](#)

**Table 2b to Subpart ZZZZ of Part 63—Operating Limitations for New and Reconstructed 2SLB and CI Stationary RICE >500 HP Located at a Major Source of HAP Emissions, New and Reconstructed 4SLB Stationary RICE ≥250 HP Located at a Major Source of HAP Emissions, Existing CI Stationary RICE >500 HP**

As stated in §§63.6600, 63.6601, 63.6603, 63.6630, and 63.6640, you must comply with the following operating limitations for new and reconstructed 2SLB and CI stationary RICE >500 HP located at a major source of HAP emissions; new and reconstructed 4SLB stationary RICE ≥250 HP located at a major source of HAP emissions; and existing CI stationary RICE >500 HP:

<b>For each . . .</b>	<b>You must meet the following operating limitation, except during periods of startup . . .</b>
1. New and reconstructed 2SLB and CI stationary RICE >500 HP located at a major source of HAP emissions and new and reconstructed 4SLB stationary RICE ≥250 HP located at a major source of HAP emissions complying with the requirement to reduce CO emissions and using an oxidation catalyst; and New and reconstructed 2SLB and CI stationary RICE >500 HP located at a major source of HAP emissions and new and reconstructed 4SLB stationary RICE ≥250 HP located at a major source of HAP emissions complying with the requirement to limit the concentration of formaldehyde in the stationary RICE exhaust and using an	a. maintain your catalyst so that the pressure drop across the catalyst does not change by more than 2 inches of water at 100 percent load plus or minus 10 percent from the pressure drop across the catalyst that was measured during the initial performance test; and b. maintain the temperature of your stationary RICE exhaust so that the catalyst inlet temperature is greater than or equal to 450 °F and less than or equal to 1350 °F. <sup>1</sup>

oxidation catalyst.	
2. Existing CI stationary RICE >500 HP complying with the requirement to limit or reduce the concentration of CO in the stationary RICE exhaust and using an oxidation catalyst	a. maintain your catalyst so that the pressure drop across the catalyst does not change by more than 2 inches of water from the pressure drop across the catalyst that was measured during the initial performance test; and
	b. maintain the temperature of your stationary RICE exhaust so that the catalyst inlet temperature is greater than or equal to 450 °F and less than or equal to 1350 °F. <sup>1</sup>
3. New and reconstructed 2SLB and CI stationary RICE >500 HP located at a major source of HAP emissions and new and reconstructed 4SLB stationary RICE ≥250 HP located at a major source of HAP emissions complying with the requirement to reduce CO emissions and not using an oxidation catalyst; and	Comply with any operating limitations approved by the Administrator.
New and reconstructed 2SLB and CI stationary RICE >500 HP located at a major source of HAP emissions and new and reconstructed 4SLB stationary RICE ≥250 HP located at a major source of HAP emissions complying with the requirement to limit the concentration of formaldehyde in the stationary RICE exhaust and not using an oxidation catalyst; and	
existing CI stationary RICE >500 HP complying with the requirement to limit or reduce the concentration of CO in the stationary RICE exhaust and not using an oxidation catalyst.	

<sup>1</sup>Sources can petition the Administrator pursuant to the requirements of 40 CFR 63.8(f) for a different temperature range.

[78 FR 6707, Jan. 30, 2013]

[↑ Back to Top](#)

**Table 2c to Subpart ZZZZ of Part 63—Requirements for Existing Compression Ignition Stationary RICE Located at a Major Source of HAP Emissions and Existing Spark Ignition Stationary RICE ≤500 HP Located at a Major Source of HAP Emissions**

As stated in §§63.6600, 63.6602, and 63.6640, you must comply with the following requirements for existing compression ignition stationary RICE located at a major source of HAP emissions and existing spark ignition stationary RICE  $\leq 500$  HP located at a major source of HAP emissions:

For each . . .	You must meet the following requirement, except during periods of startup . . .	During periods of startup you must . . .
1. Emergency stationary CI RICE and black start stationary CI RICE <sup>1</sup>	a. Change oil and filter every 500 hours of operation or annually, whichever comes first. <sup>2</sup> b. Inspect air cleaner every 1,000 hours of operation or annually, whichever comes first, and replace as necessary; c. Inspect all hoses and belts every 500 hours of operation or annually, whichever comes first, and replace as necessary. <sup>3</sup>	Minimize the engine's time spent at idle and minimize the engine's startup time at startup to a period needed for appropriate and safe loading of the engine, not to exceed 30 minutes, after which time the non-startup emission limitations apply. <sup>3</sup>
2. Non-Emergency, non-black start stationary CI RICE <100 HP	a. Change oil and filter every 1,000 hours of operation or annually, whichever comes first. <sup>2</sup> b. Inspect air cleaner every 1,000 hours of operation or annually, whichever comes first, and replace as necessary; c. Inspect all hoses and belts every 500 hours of operation or annually, whichever comes first, and replace as necessary. <sup>3</sup>	
3. Non-Emergency, non-black start CI stationary RICE $100 \leq \text{HP} \leq 300$ HP	Limit concentration of CO in the stationary RICE exhaust to 230 ppmvd or	

	less at 15 percent O <sub>2</sub> .	
4. Non-Emergency, non-black start CI stationary RICE 300<HP≤500	a. Limit concentration of CO in the stationary RICE exhaust to 49 ppmvd or less at 15 percent O <sub>2</sub> ; or b. Reduce CO emissions by 70 percent or more.	
5. Non-Emergency, non-black start stationary CI RICE >500 HP	a. Limit concentration of CO in the stationary RICE exhaust to 23 ppmvd or less at 15 percent O <sub>2</sub> ; or b. Reduce CO emissions by 70 percent or more.	
6. Emergency stationary SI RICE and black start stationary SI RICE. <sup>1</sup>	a. Change oil and filter every 500 hours of operation or annually, whichever comes first; <sup>2</sup> b. Inspect spark plugs every 1,000 hours of operation or annually, whichever comes first, and replace as necessary; c. Inspect all hoses and belts every 500 hours of operation or annually, whichever comes first, and replace as necessary. <sup>3</sup>	
7. Non-Emergency, non-black start stationary SI RICE <100 HP that are not 2SLB stationary RICE	a. Change oil and filter every 1,440 hours of operation or annually, whichever comes first; <sup>2</sup> b. Inspect spark plugs every 1,440 hours of operation or annually, whichever comes first, and replace as necessary;	
	c. Inspect all hoses and	

	belts every 1,440 hours of operation or annually, whichever comes first, and replace as necessary. <sup>3</sup>	
8. Non-Emergency, non-black start 2SLB stationary SI RICE <100 HP	a. Change oil and filter every 4,320 hours of operation or annually, whichever comes first; <sup>2</sup> b. Inspect spark plugs every 4,320 hours of operation or annually, whichever comes first, and replace as necessary;	
	c. Inspect all hoses and belts every 4,320 hours of operation or annually, whichever comes first, and replace as necessary. <sup>3</sup>	
9. Non-emergency, non-black start 2SLB stationary RICE 100≤HP≤500	Limit concentration of CO in the stationary RICE exhaust to 225 ppmvd or less at 15 percent O <sub>2</sub> .	
10. Non-emergency, non-black start 4SLB stationary RICE 100≤HP≤500	Limit concentration of CO in the stationary RICE exhaust to 47 ppmvd or less at 15 percent O <sub>2</sub> .	
11. Non-emergency, non-black start 4SRB stationary RICE 100≤HP≤500	Limit concentration of formaldehyde in the stationary RICE exhaust to 10.3 ppmvd or less at 15 percent O <sub>2</sub> .	
12. Non-emergency, non-black start stationary RICE 100≤HP≤500 which combusts landfill or digester gas equivalent to 10 percent or more of the gross heat input on an	Limit concentration of CO in the stationary RICE exhaust to 177 ppmvd or less at 15 percent O <sub>2</sub> .	

annual basis		
--------------	--	--

<sup>1</sup>If an emergency engine is operating during an emergency and it is not possible to shut down the engine in order to perform the work practice requirements on the schedule required in Table 2c of this subpart, or if performing the work practice on the required schedule would otherwise pose an unacceptable risk under federal, state, or local law, the work practice can be delayed until the emergency is over or the unacceptable risk under federal, state, or local law has abated. The work practice should be performed as soon as practicable after the emergency has ended or the unacceptable risk under federal, state, or local law has abated. Sources must report any failure to perform the work practice on the schedule required and the federal, state or local law under which the risk was deemed unacceptable.

<sup>2</sup>Sources have the option to utilize an oil analysis program as described in §63.6625(i) or (j) in order to extend the specified oil change requirement in Table 2c of this subpart.

<sup>3</sup>Sources can petition the Administrator pursuant to the requirements of 40 CFR 63.6(g) for alternative work practices.

[78 FR 6708, Jan. 30, 2013, as amended at 78 FR 14457, Mar. 6, 2013]

[↑ Back to Top](#)

**Table 2d to Subpart ZZZZ of Part 63—Requirements for Existing Stationary RICE Located at Area Sources of HAP Emissions**

As stated in §§63.6603 and 63.6640, you must comply with the following requirements for existing stationary RICE located at area sources of HAP emissions:

<b>For each . . .</b>	<b>You must meet the following requirement, except during periods of startup . . .</b>	<b>During periods of startup you must . . .</b>
1. Non-Emergency, non-black start CI stationary RICE ≤300 HP	a. Change oil and filter every 1,000 hours of operation or annually, whichever comes first; <sup>1</sup> b. Inspect air cleaner every 1,000 hours of operation or annually, whichever comes first, and replace as necessary; c. Inspect all hoses and belts every 500 hours of operation or annually, whichever comes first,	Minimize the engine's time spent at idle and minimize the engine's startup time at startup to a period needed for appropriate and safe loading of the engine, not to exceed 30 minutes, after which time the non-startup emission limitations apply.



	and replace as necessary.	
2. Non-Emergency, non-black start CI stationary RICE 300<HP≤500	a. Limit concentration of CO in the stationary RICE exhaust to 49 ppmvd at 15 percent O <sub>2</sub> ; or	
	b. Reduce CO emissions by 70 percent or more.	
3. Non-Emergency, non-black start CI stationary RICE >500 HP	a. Limit concentration of CO in the stationary RICE exhaust to 23 ppmvd at 15 percent O <sub>2</sub> ; or	
	b. Reduce CO emissions by 70 percent or more.	
4. Emergency stationary CI RICE and black start stationary CI RICE. <sup>2</sup>	a. Change oil and filter every 500 hours of operation or annually, whichever comes first; <sup>1</sup>	
	b. Inspect air cleaner every 1,000 hours of operation or annually, whichever comes first, and replace as necessary; and	
	c. Inspect all hoses and belts every 500 hours of operation or annually, whichever comes first, and replace as necessary.	
5. Emergency stationary SI RICE; black start stationary SI RICE; non-emergency, non-black start 4SLB stationary RICE >500 HP that operate 24 hours or less per	a. Change oil and filter every 500 hours of operation or annually, whichever comes first; <sup>1</sup> ;	

<p>calendar year; non-emergency, non-black start 4SRB stationary RICE &gt;500 HP that operate 24 hours or less per calendar year.<sup>2</sup></p>	<p>b. Inspect spark plugs every 1,000 hours of operation or annually, whichever comes first, and replace as necessary; and c. Inspect all hoses and belts every 500 hours of operation or annually, whichever comes first, and replace as necessary.</p>	
<p>6. Non-emergency, non-black start 2SLB stationary RICE</p>	<p>a. Change oil and filter every 4,320 hours of operation or annually, whichever comes first;<sup>1</sup></p>	
	<p>b. Inspect spark plugs every 4,320 hours of operation or annually, whichever comes first, and replace as necessary; and</p>	
	<p>c. Inspect all hoses and belts every 4,320 hours of operation or annually, whichever comes first, and replace as necessary.</p>	
<p>7. Non-emergency, non-black start 4SLB stationary RICE ≤500 HP</p>	<p>a. Change oil and filter every 1,440 hours of operation or annually, whichever comes first;<sup>1</sup></p>	
	<p>b. Inspect spark plugs every 1,440 hours of operation or annually, whichever comes first, and replace as necessary; and</p>	

	c. Inspect all hoses and belts every 1,440 hours of operation or annually, whichever comes first, and replace as necessary.	
8. Non-emergency, non-black start 4SLB remote stationary RICE >500 HP	a. Change oil and filter every 2,160 hours of operation or annually, whichever comes first; <sup>1</sup>	
	b. Inspect spark plugs every 2,160 hours of operation or annually, whichever comes first, and replace as necessary; and	
	c. Inspect all hoses and belts every 2,160 hours of operation or annually, whichever comes first, and replace as necessary.	
9. Non-emergency, non-black start 4SLB stationary RICE >500 HP that are not remote stationary RICE and that operate more than 24 hours per calendar year	Install an oxidation catalyst to reduce HAP emissions from the stationary RICE.	
10. Non-emergency, non-black start 4SRB stationary RICE ≤500 HP	a. Change oil and filter every 1,440 hours of operation or annually, whichever comes first; <sup>1</sup>	
	b. Inspect spark plugs every 1,440 hours of operation or annually, whichever comes first, and replace as necessary; and	

	c. Inspect all hoses and belts every 1,440 hours of operation or annually, whichever comes first, and replace as necessary.	
11. Non-emergency, non-black start 4SRB remote stationary RICE >500 HP	a. Change oil and filter every 2,160 hours of operation or annually, whichever comes first; <sup>1</sup>	
	b. Inspect spark plugs every 2,160 hours of operation or annually, whichever comes first, and replace as necessary; and	
	c. Inspect all hoses and belts every 2,160 hours of operation or annually, whichever comes first, and replace as necessary.	
12. Non-emergency, non-black start 4SRB stationary RICE >500 HP that are not remote stationary RICE and that operate more than 24 hours per calendar year	Install NSCR to reduce HAP emissions from the stationary RICE.	
13. Non-emergency, non-black start stationary RICE which combusts landfill or digester gas equivalent to 10 percent or more of the gross heat input on an annual basis	a. Change oil and filter every 1,440 hours of operation or annually, whichever comes first; <sup>1</sup> b. Inspect spark plugs every 1,440 hours of operation or annually, whichever comes first, and replace as necessary; and	
	c. Inspect all hoses and belts every 1,440 hours	

	of operation or annually, whichever comes first, and replace as necessary.	
--	--	--

<sup>1</sup>Sources have the option to utilize an oil analysis program as described in §63.6625(i) or (j) in order to extend the specified oil change requirement in Table 2d of this subpart.

<sup>2</sup>If an emergency engine is operating during an emergency and it is not possible to shut down the engine in order to perform the management practice requirements on the schedule required in Table 2d of this subpart, or if performing the management practice on the required schedule would otherwise pose an unacceptable risk under federal, state, or local law, the management practice can be delayed until the emergency is over or the unacceptable risk under federal, state, or local law has abated. The management practice should be performed as soon as practicable after the emergency has ended or the unacceptable risk under federal, state, or local law has abated. Sources must report any failure to perform the management practice on the schedule required and the federal, state or local law under which the risk was deemed unacceptable.

[78 FR 6709, Jan. 30, 2013]

[↑ Back to Top](#)

**Table 3 to Subpart ZZZZ of Part 63—Subsequent Performance Tests**

As stated in §§63.6615 and 63.6620, you must comply with the following subsequent performance test requirements:

<b>For each . . .</b>	<b>Complying with the requirement to . . .</b>	<b>You must . . .</b>
1. New or reconstructed 2SLB stationary RICE >500 HP located at major sources; new or reconstructed 4SLB stationary RICE ≥250 HP located at major sources; and new or reconstructed CI stationary RICE >500 HP located at major sources	Reduce CO emissions and not using a CEMS	Conduct subsequent performance tests semiannually. <sup>1</sup>
2. 4SRB stationary RICE ≥5,000 HP located at major sources	Reduce formaldehyde emissions	Conduct subsequent performance tests semiannually. <sup>1</sup>
3. Stationary RICE >500 HP located at major sources and new or reconstructed 4SLB stationary RICE 250≤HP≤500 located at major sources	Limit the concentration of formaldehyde in the stationary RICE exhaust	Conduct subsequent performance tests semiannually. <sup>1</sup>

4. Existing non-emergency, non-black start CI stationary RICE >500 HP that are not limited use stationary RICE	Limit or reduce CO emissions and not using a CEMS	Conduct subsequent performance tests every 8,760 hours or 3 years, whichever comes first.
5. Existing non-emergency, non-black start CI stationary RICE >500 HP that are limited use stationary RICE	Limit or reduce CO emissions and not using a CEMS	Conduct subsequent performance tests every 8,760 hours or 5 years, whichever comes first.

<sup>1</sup>After you have demonstrated compliance for two consecutive tests, you may reduce the frequency of subsequent performance tests to annually. If the results of any subsequent annual performance test indicate the stationary RICE is not in compliance with the CO or formaldehyde emission limitation, or you deviate from any of your operating limitations, you must resume semiannual performance tests.

[78 FR 6711, Jan. 30, 2013]

[↑ Back to Top](#)

**Table 4 to Subpart ZZZZ of Part 63—Requirements for Performance Tests**

As stated in §§63.6610, 63.6611, 63.6620, and 63.6640, you must comply with the following requirements for performance tests for stationary RICE:

<b>For each . . .</b>	<b>Complying with the requirement to . . .</b>	<b>You must . . .</b>	<b>Using . . .</b>	<b>According to the following requirements . . .</b>
1. 2SLB, 4SLB, and CI stationary RICE	a. reduce CO emissions	i. Select the sampling port location and the number/location of traverse points at the inlet and outlet of the control device; and		(a) For CO and O <sub>2</sub> measurement, ducts ≤6 inches in diameter may be sampled at a single point located at the duct centroid and ducts >6 and ≤12 inches in diameter may be sampled at 3 traverse points located at 16.7, 50.0, and 83.3% of the measurement line ('3-point long line'). If the duct is >12 inches in diameter <i>and</i> the sampling port location meets the two and half-diameter criterion of Section 11.1.1 of

				Method 1 of 40 CFR part 60, appendix A-1, the duct may be sampled at '3-point long line'; otherwise, conduct the stratification testing and select sampling points according to Section 8.1.2 of Method 7E of 40 CFR part 60, appendix A-4.
		ii. Measure the O <sub>2</sub> at the inlet and outlet of the control device; and	(1) Method 3 or 3A or 3B of 40 CFR part 60, appendix A-2, or ASTM Method D6522-00 (Reapproved 2005) <sup>ac</sup> (heated probe not necessary)	(b) Measurements to determine O <sub>2</sub> must be made at the same time as the measurements for CO concentration.
		iii. Measure the CO at the inlet and the outlet of the control device	(1) ASTM D6522-00 (Reapproved 2005) <sup>abc</sup> (heated probe not necessary) or Method 10 of 40 CFR part 60, appendix A-4	(c) The CO concentration must be at 15 percent O <sub>2</sub> , dry basis.
2. 4SRB stationary RICE	a. reduce formaldehyde emissions	i. Select the sampling port location and the number/location of traverse points at the inlet and outlet of the control device; and		(a) For formaldehyde, O <sub>2</sub> , and moisture measurement, ducts ≤6 inches in diameter may be sampled at a single point located at the duct centroid and ducts >6 and ≤12 inches in diameter may be sampled at 3 traverse points located at 16.7, 50.0, and 83.3% of the measurement line ('3-point long line'). If the duct is >12 inches in diameter <i>and</i> the sampling port location meets the two and half-diameter criterion of Section 11.1.1 of Method 1 of 40 CFR part 60, appendix A, the duct may be

				sampled at '3-point long line'; otherwise, conduct the stratification testing and select sampling points according to Section 8.1.2 of Method 7E of 40 CFR part 60, appendix A.
		ii. Measure O <sub>2</sub> at the inlet and outlet of the control device; and	(1) Method 3 or 3A or 3B of 40 CFR part 60, appendix A-2, or ASTM Method D6522-00 (Reapproved 2005) <sup>a</sup> (heated probe not necessary)	(a) Measurements to determine O <sub>2</sub> concentration must be made at the same time as the measurements for formaldehyde or THC concentration.
		iii. Measure moisture content at the inlet and outlet of the control device; and	(1) Method 4 of 40 CFR part 60, appendix A-3, or Method 320 of 40 CFR part 63, appendix A, or ASTM D 6348-03 <sup>a</sup>	(a) Measurements to determine moisture content must be made at the same time and location as the measurements for formaldehyde or THC concentration.
		iv. If demonstrating compliance with the formaldehyde percent reduction requirement, measure formaldehyde at the inlet and the outlet of the control device	(1) Method 320 or 323 of 40 CFR part 63, appendix A; or ASTM D6348-03 <sup>a</sup> , provided in ASTM D6348-03 Annex A5 (Analyte Spiking Technique), the percent R must be greater than or equal to 70 and less than or equal to 130	(a) Formaldehyde concentration must be at 15 percent O <sub>2</sub> , dry basis. Results of this test consist of the average of the three 1-hour or longer runs.
		v. If demonstrating compliance with the THC percent reduction requirement, measure THC at the inlet and the outlet of	(1) Method 25A, reported as propane, of 40 CFR part 60, appendix A-7	(a) THC concentration must be at 15 percent O <sub>2</sub> , dry basis. Results of this test consist of the average of the three 1-hour or longer runs.



		the control device		
3. Stationary RICE	a. limit the concentration of formaldehyde or CO in the stationary RICE exhaust	i. Select the sampling port location and the number/location of traverse points at the exhaust of the stationary RICE; and		(a) For formaldehyde, CO, O <sub>2</sub> , and moisture measurement, ducts ≤6 inches in diameter may be sampled at a single point located at the duct centroid and ducts >6 and ≤12 inches in diameter may be sampled at 3 traverse points located at 16.7, 50.0, and 83.3% of the measurement line ('3-point long line'). If the duct is >12 inches in diameter <i>and</i> the sampling port location meets the two and half-diameter criterion of Section 11.1.1 of Method 1 of 40 CFR part 60, appendix A, the duct may be sampled at '3-point long line'; otherwise, conduct the stratification testing and select sampling points according to Section 8.1.2 of Method 7E of 40 CFR part 60, appendix A. If using a control device, the sampling site must be located at the outlet of the control device.
		ii. Determine the O <sub>2</sub> concentration of the stationary RICE exhaust at the sampling port location; and	(1) Method 3 or 3A or 3B of 40 CFR part 60, appendix A-2, or ASTM Method D6522-00 (Reapproved 2005) <sup>a</sup> (heated probe not necessary)	(a) Measurements to determine O <sub>2</sub> concentration must be made at the same time and location as the measurements for formaldehyde or CO concentration.
		iii. Measure moisture content of the stationary RICE exhaust at	(1) Method 4 of 40 CFR part 60, appendix A-3, or Method 320 of	(a) Measurements to determine moisture content must be made at the same

		the sampling port location; and	40 CFR part 63, appendix A, or ASTM D 6348-03 <sup>a</sup>	time and location as the measurements for formaldehyde or CO concentration.
		iv. Measure formaldehyde at the exhaust of the station-ary RICE; or	(1) Method 320 or 323 of 40 CFR part 63, appendix A; or ASTM D6348-03 <sup>a</sup> , provided in ASTM D6348-03 Annex A5 (Analyte Spiking Technique), the percent R must be greater than or equal to 70 and less than or equal to 130	(a) Formaldehyde concentration must be at 15 percent O <sub>2</sub> , dry basis. Results of this test consist of the average of the three 1-hour or longer runs.
		v. measure CO at the exhaust of the station-ary RICE	(1) Method 10 of 40 CFR part 60, appendix A-4, ASTM Method D6522-00 (2005) <sup>ac</sup> , Method 320 of 40 CFR part 63, appendix A, or ASTM D6348-03 <sup>a</sup>	(a) CO concentration must be at 15 percent O <sub>2</sub> , dry basis. Results of this test consist of the average of the three 1-hour or longer runs.

<sup>a</sup>You may also use Methods 3A and 10 as options to ASTM-D6522-00 (2005). You may obtain a copy of ASTM-D6522-00 (2005) from at least one of the following addresses: American Society for Testing and Materials, 100 Barr Harbor Drive, West Conshohocken, PA 19428-2959, or University Microfilms International, 300 North Zeeb Road, Ann Arbor, MI 48106.

<sup>b</sup>You may obtain a copy of ASTM-D6348-03 from at least one of the following addresses: American Society for Testing and Materials, 100 Barr Harbor Drive, West Conshohocken, PA 19428-2959, or University Microfilms International, 300 North Zeeb Road, Ann Arbor, MI 48106.

[79 FR 11290, Feb. 27, 2014]

[↑ Back to Top](#)

**Table 5 to Subpart ZZZZ of Part 63—Initial Compliance With Emission Limitations, Operating Limitations, and Other Requirements**

As stated in §§63.6612, 63.6625 and 63.6630, you must initially comply with the emission and operating limitations as required by the following:

<b>For each . . .</b>	<b>Complying with the requirement to . . .</b>	<b>You have demonstrated initial compliance if . . .</b>
<p>1. New or reconstructed non-emergency 2SLB stationary RICE &gt;500 HP located at a major source of HAP, new or reconstructed non-emergency 4SLB stationary RICE <math>\geq</math>250 HP located at a major source of HAP, non-emergency stationary CI RICE &gt;500 HP located at a major source of HAP, and existing non-emergency stationary CI RICE &gt;500 HP located at an area source of HAP</p>	<p>a. Reduce CO emissions and using oxidation catalyst, and using a CPMS</p>	<p>i. The average reduction of emissions of CO determined from the initial performance test achieves the required CO percent reduction; and  ii. You have installed a CPMS to continuously monitor catalyst inlet temperature according to the requirements in §63.6625(b); and  iii. You have recorded the catalyst pressure drop and catalyst inlet temperature during the initial performance test.</p>
<p>2. Non-emergency stationary CI RICE &gt;500 HP located at a major source of HAP, and existing non-emergency stationary CI RICE &gt;500 HP located at an area source of HAP</p>	<p>a. Limit the concentration of CO, using oxidation catalyst, and using a CPMS</p>	<p>i. The average CO concentration determined from the initial performance test is less than or equal to the CO emission limitation; and</p>
		<p>ii. You have installed a CPMS to continuously monitor catalyst inlet temperature according to the requirements in §63.6625(b); and</p>
		<p>iii. You have recorded the catalyst pressure drop and catalyst inlet temperature during the initial performance test.</p>
<p>3. New or reconstructed non-emergency 2SLB stationary RICE &gt;500 HP located at a major source of HAP, new or reconstructed non-emergency 4SLB stationary RICE <math>\geq</math>250 HP located at a major source of HAP, non-emergency stationary CI RICE &gt;500 HP located at a major source of HAP, and existing non-emergency stationary CI RICE &gt;500 HP located at an area source of HAP</p>	<p>a. Reduce CO emissions and not using oxidation catalyst</p>	<p>i. The average reduction of emissions of CO determined from the initial performance test achieves the required CO percent reduction; and  ii. You have installed a CPMS to continuously monitor operating parameters approved by the Administrator (if any) according to the requirements in §63.6625(b); and  iii. You have recorded the approved</p>

		operating parameters (if any) during the initial performance test.
4. Non-emergency stationary CI RICE >500 HP located at a major source of HAP, and existing non-emergency stationary CI RICE >500 HP located at an area source of HAP	a. Limit the concentration of CO, and not using oxidation catalyst	i. The average CO concentration determined from the initial performance test is less than or equal to the CO emission limitation; and ii. You have installed a CPMS to continuously monitor operating parameters approved by the Administrator (if any) according to the requirements in §63.6625(b); and
		iii. You have recorded the approved operating parameters (if any) during the initial performance test.
5. New or reconstructed non-emergency 2SLB stationary RICE >500 HP located at a major source of HAP, new or reconstructed non-emergency 4SLB stationary RICE ≥250 HP located at a major source of HAP, non-emergency stationary CI RICE >500 HP located at a major source of HAP, and existing non-emergency stationary CI RICE >500 HP located at an area source of HAP	a. Reduce CO emissions, and using a CEMS	i. You have installed a CEMS to continuously monitor CO and either O <sub>2</sub> or CO <sub>2</sub> at both the inlet and outlet of the oxidation catalyst according to the requirements in §63.6625(a); and ii. You have conducted a performance evaluation of your CEMS using PS 3 and 4A of 40 CFR part 60, appendix B; and
		iii. The average reduction of CO calculated using §63.6620 equals or exceeds the required percent reduction. The initial test comprises the first 4-hour period after successful validation of the CEMS. Compliance is based on the average percent reduction achieved during the 4-hour period.
6. Non-emergency stationary CI RICE >500 HP located at a major source of HAP, and existing non-emergency stationary CI RICE >500 HP located at an area source of HAP	a. Limit the concentration of CO, and using a CEMS	i. You have installed a CEMS to continuously monitor CO and either O <sub>2</sub> or CO <sub>2</sub> at the outlet of the oxidation catalyst according to the requirements in §63.6625(a); and

		ii. You have conducted a performance evaluation of your CEMS using PS 3 and 4A of 40 CFR part 60, appendix B; and
		iii. The average concentration of CO calculated using §63.6620 is less than or equal to the CO emission limitation. The initial test comprises the first 4-hour period after successful validation of the CEMS. Compliance is based on the average concentration measured during the 4-hour period.
7. Non-emergency 4SRB stationary RICE >500 HP located at a major source of HAP	a. Reduce formaldehyde emissions and using NSCR	i. The average reduction of emissions of formaldehyde determined from the initial performance test is equal to or greater than the required formaldehyde percent reduction, or the average reduction of emissions of THC determined from the initial performance test is equal to or greater than 30 percent; and
		ii. You have installed a CPMS to continuously monitor catalyst inlet temperature according to the requirements in §63.6625(b); and
		iii. You have recorded the catalyst pressure drop and catalyst inlet temperature during the initial performance test.
8. Non-emergency 4SRB stationary RICE >500 HP located at a major source of HAP	a. Reduce formaldehyde emissions and not using NSCR	i. The average reduction of emissions of formaldehyde determined from the initial performance test is equal to or greater than the required formaldehyde percent reduction or the average reduction of emissions of THC determined from the initial performance test is equal to or greater than 30

		percent; and
		ii. You have installed a CPMS to continuously monitor operating parameters approved by the Administrator (if any) according to the requirements in §63.6625(b); and
		iii. You have recorded the approved operating parameters (if any) during the initial performance test.
9. New or reconstructed non-emergency stationary RICE >500 HP located at a major source of HAP, new or reconstructed non-emergency 4SLB stationary RICE $250 \leq \text{HP} \leq 500$ located at a major source of HAP, and existing non-emergency 4SRB stationary RICE >500 HP located at a major source of HAP	a. Limit the concentration of formaldehyde in the stationary RICE exhaust and using oxidation catalyst or NSCR	i. The average formaldehyde concentration, corrected to 15 percent O <sub>2</sub> , dry basis, from the three test runs is less than or equal to the formaldehyde emission limitation; and ii. You have installed a CPMS to continuously monitor catalyst inlet temperature according to the requirements in §63.6625(b); and
		iii. You have recorded the catalyst pressure drop and catalyst inlet temperature during the initial performance test.
10. New or reconstructed non-emergency stationary RICE >500 HP located at a major source of HAP, new or reconstructed non-emergency 4SLB stationary RICE $250 \leq \text{HP} \leq 500$ located at a major source of HAP, and existing non-emergency 4SRB stationary RICE >500 HP located at a major source of HAP	a. Limit the concentration of formaldehyde in the stationary RICE exhaust and not using oxidation catalyst or NSCR	i. The average formaldehyde concentration, corrected to 15 percent O <sub>2</sub> , dry basis, from the three test runs is less than or equal to the formaldehyde emission limitation; and ii. You have installed a CPMS to continuously monitor operating parameters approved by the Administrator (if any) according to the requirements in §63.6625(b); and
		iii. You have recorded the approved operating parameters (if any) during the initial performance test.

<p>11. Existing non-emergency stationary RICE <math>100 \leq \text{HP} \leq 500</math> located at a major source of HAP, and existing non-emergency stationary CI RICE <math>300 &lt; \text{HP} \leq 500</math> located at an area source of HAP</p>	<p>a. Reduce CO emissions</p>	<p>i. The average reduction of emissions of CO or formaldehyde, as applicable determined from the initial performance test is equal to or greater than the required CO or formaldehyde, as applicable, percent reduction.</p>
<p>12. Existing non-emergency stationary RICE <math>100 \leq \text{HP} \leq 500</math> located at a major source of HAP, and existing non-emergency stationary CI RICE <math>300 &lt; \text{HP} \leq 500</math> located at an area source of HAP</p>	<p>a. Limit the concentration of formaldehyde or CO in the stationary RICE exhaust</p>	<p>i. The average formaldehyde or CO concentration, as applicable, corrected to 15 percent O<sub>2</sub>, dry basis, from the three test runs is less than or equal to the formaldehyde or CO emission limitation, as applicable.</p>
<p>13. Existing non-emergency 4SLB stationary RICE <math>&gt;500</math> HP located at an area source of HAP that are not remote stationary RICE and that are operated more than 24 hours per calendar year</p>	<p>a. Install an oxidation catalyst</p>	<p>i. You have conducted an initial compliance demonstration as specified in §63.6630(e) to show that the average reduction of emissions of CO is 93 percent or more, or the average CO concentration is less than or equal to 47 ppmvd at 15 percent O<sub>2</sub>;</p>
		<p>ii. You have installed a CPMS to continuously monitor catalyst inlet temperature according to the requirements in §63.6625(b), or you have installed equipment to automatically shut down the engine if the catalyst inlet temperature exceeds 1350 °F.</p>
<p>14. Existing non-emergency 4SRB stationary RICE <math>&gt;500</math> HP located at an area source of HAP that are not remote stationary RICE and that are operated more than 24 hours per calendar year</p>	<p>a. Install NSCR</p>	<p>i. You have conducted an initial compliance demonstration as specified in §63.6630(e) to show that the average reduction of emissions of CO is 75 percent or more, the average CO concentration is less than or equal to 270 ppmvd at 15 percent O<sub>2</sub>, or the average reduction of emissions of THC is 30 percent or more;</p>
		<p>ii. You have installed a CPMS to</p>

		continuously monitor catalyst inlet temperature according to the requirements in §63.6625(b), or you have installed equipment to automatically shut down the engine if the catalyst inlet temperature exceeds 1250 °F.
--	--	--

[78 FR 6712, Jan. 30, 2013]

[↑ Back to Top](#)

**Table 6 to Subpart ZZZZ of Part 63—Continuous Compliance With Emission Limitations, and Other Requirements**

As stated in §63.6640, you must continuously comply with the emissions and operating limitations and work or management practices as required by the following:

<b>For each . . .</b>	<b>Complying with the requirement to . . .</b>	<b>You must demonstrate continuous compliance by . . .</b>
1. New or reconstructed non-emergency 2SLB stationary RICE >500 HP located at a major source of HAP, new or reconstructed non-emergency 4SLB stationary RICE ≥250 HP located at a major source of HAP, and new or reconstructed non-emergency CI stationary RICE >500 HP located at a major source of HAP	a. Reduce CO emissions and using an oxidation catalyst, and using a CPMS	i. Conducting semiannual performance tests for CO to demonstrate that the required CO percent reduction is achieved <sup>a</sup> ; and
		ii. Collecting the catalyst inlet temperature data according to §63.6625(b); and
		iii. Reducing these data to 4-hour rolling averages; and
		iv. Maintaining the 4-hour rolling averages within the operating limitations for the catalyst inlet temperature; and
		v. Measuring the pressure drop across the catalyst once per month and demonstrating that the pressure drop across the catalyst is within the operating limitation established during the performance test.
2. New or reconstructed non-emergency	a. Reduce CO	i. Conducting semiannual performance



<p>2SLB stationary RICE &gt;500 HP located at a major source of HAP, new or reconstructed non-emergency 4SLB stationary RICE <math>\geq</math>250 HP located at a major source of HAP, and new or reconstructed non-emergency CI stationary RICE &gt;500 HP located at a major source of HAP</p>	<p>emissions and not using an oxidation catalyst, and using a CPMS</p>	<p>tests for CO to demonstrate that the required CO percent reduction is achieved<sup>a</sup>; and  ii. Collecting the approved operating parameter (if any) data according to §63.6625(b); and  iii. Reducing these data to 4-hour rolling averages; and</p>
		<p>iv. Maintaining the 4-hour rolling averages within the operating limitations for the operating parameters established during the performance test.</p>
<p>3. New or reconstructed non-emergency 2SLB stationary RICE &gt;500 HP located at a major source of HAP, new or reconstructed non-emergency 4SLB stationary RICE <math>\geq</math>250 HP located at a major source of HAP, new or reconstructed non-emergency stationary CI RICE &gt;500 HP located at a major source of HAP, and existing non-emergency stationary CI RICE &gt;500 HP</p>	<p>a. Reduce CO emissions or limit the concentration of CO in the stationary RICE exhaust, and using a CEMS</p>	<p>i. Collecting the monitoring data according to §63.6625(a), reducing the measurements to 1-hour averages, calculating the percent reduction or concentration of CO emissions according to §63.6620; and  ii. Demonstrating that the catalyst achieves the required percent reduction of CO emissions over the 4-hour averaging period, or that the emission remain at or below the CO concentration limit; and</p>
		<p>iii. Conducting an annual RATA of your CEMS using PS 3 and 4A of 40 CFR part 60, appendix B, as well as daily and periodic data quality checks in accordance with 40 CFR part 60, appendix F, procedure 1.</p>
<p>4. Non-emergency 4SRB stationary RICE &gt;500 HP located at a major source of HAP</p>	<p>a. Reduce formaldehyde emissions and using NSCR</p>	<p>i. Collecting the catalyst inlet temperature data according to §63.6625(b); and</p>
		<p>ii. Reducing these data to 4-hour rolling averages; and</p>

		iii. Maintaining the 4-hour rolling averages within the operating limitations for the catalyst inlet temperature; and
		iv. Measuring the pressure drop across the catalyst once per month and demonstrating that the pressure drop across the catalyst is within the operating limitation established during the performance test.
5. Non-emergency 4SRB stationary RICE >500 HP located at a major source of HAP	a. Reduce formaldehyde emissions and not using NSCR	i. Collecting the approved operating parameter (if any) data according to §63.6625(b); and
		ii. Reducing these data to 4-hour rolling averages; and
		iii. Maintaining the 4-hour rolling averages within the operating limitations for the operating parameters established during the performance test.
6. Non-emergency 4SRB stationary RICE with a brake HP $\geq 5,000$ located at a major source of HAP	a. Reduce formaldehyde emissions	Conducting semiannual performance tests for formaldehyde to demonstrate that the required formaldehyde percent reduction is achieved, or to demonstrate that the average reduction of emissions of THC determined from the performance test is equal to or greater than 30 percent. <sup>a</sup>
7. New or reconstructed non-emergency stationary RICE >500 HP located at a major source of HAP and new or reconstructed non-emergency 4SLB stationary RICE $250 \leq \text{HP} \leq 500$ located at a major source of HAP	a. Limit the concentration of formaldehyde in the stationary RICE exhaust and using oxidation catalyst or NSCR	i. Conducting semiannual performance tests for formaldehyde to demonstrate that your emissions remain at or below the formaldehyde concentration limit <sup>a</sup> ; and ii. Collecting the catalyst inlet temperature data according to §63.6625(b); and

		iii. Reducing these data to 4-hour rolling averages; and
		iv. Maintaining the 4-hour rolling averages within the operating limitations for the catalyst inlet temperature; and
		v. Measuring the pressure drop across the catalyst once per month and demonstrating that the pressure drop across the catalyst is within the operating limitation established during the performance test.
8. New or reconstructed non-emergency stationary RICE >500 HP located at a major source of HAP and new or reconstructed non-emergency 4SLB stationary RICE $250 \leq \text{HP} \leq 500$ located at a major source of HAP	a. Limit the concentration of formaldehyde in the stationary RICE exhaust and not using oxidation catalyst or NSCR	i. Conducting semiannual performance tests for formaldehyde to demonstrate that your emissions remain at or below the formaldehyde concentration limit <sup>a</sup> ; and ii. Collecting the approved operating parameter (if any) data according to §63.6625(b); and
		iii. Reducing these data to 4-hour rolling averages; and
		iv. Maintaining the 4-hour rolling averages within the operating limitations for the operating parameters established during the performance test.
9. Existing emergency and black start stationary RICE $\leq 500$ HP located at a major source of HAP, existing non-emergency stationary RICE <100 HP located at a major source of HAP, existing emergency and black start stationary RICE located at an area source of HAP, existing non-emergency stationary CI RICE $\leq 300$ HP located at an area source of HAP, existing non-	a. Work or Management practices	i. Operating and maintaining the stationary RICE according to the manufacturer's emission-related operation and maintenance instructions; or ii. Develop and follow your own maintenance plan which must provide to the extent practicable for the maintenance and operation of the engine in a manner consistent with

<p>emergency 2SLB stationary RICE located at an area source of HAP, existing non-emergency stationary SI RICE located at an area source of HAP which combusts landfill or digester gas equivalent to 10 percent or more of the gross heat input on an annual basis, existing non-emergency 4SLB and 4SRB stationary RICE ≤500 HP located at an area source of HAP, existing non-emergency 4SLB and 4SRB stationary RICE &gt;500 HP located at an area source of HAP that operate 24 hours or less per calendar year, and existing non-emergency 4SLB and 4SRB stationary RICE &gt;500 HP located at an area source of HAP that are remote stationary RICE</p>		<p>good air pollution control practice for minimizing emissions.</p>
<p>10. Existing stationary CI RICE &gt;500 HP that are not limited use stationary RICE</p>	<p>a. Reduce CO emissions, or limit the concentration of CO in the stationary RICE exhaust, and using oxidation catalyst</p>	<p>i. Conducting performance tests every 8,760 hours or 3 years, whichever comes first, for CO or formaldehyde, as appropriate, to demonstrate that the required CO or formaldehyde, as appropriate, percent reduction is achieved or that your emissions remain at or below the CO or formaldehyde concentration limit; and</p>
		<p>ii. Collecting the catalyst inlet temperature data according to §63.6625(b); and</p>
		<p>iii. Reducing these data to 4-hour rolling averages; and</p>
		<p>iv. Maintaining the 4-hour rolling averages within the operating limitations for the catalyst inlet temperature; and</p>
		<p>v. Measuring the pressure drop across the catalyst once per month and</p>

		demonstrating that the pressure drop across the catalyst is within the operating limitation established during the performance test.
11. Existing stationary CI RICE >500 HP that are not limited use stationary RICE	a. Reduce CO emissions, or limit the concentration of CO in the stationary RICE exhaust, and not using oxidation catalyst	i. Conducting performance tests every 8,760 hours or 3 years, whichever comes first, for CO or formaldehyde, as appropriate, to demonstrate that the required CO or formaldehyde, as appropriate, percent reduction is achieved or that your emissions remain at or below the CO or formaldehyde concentration limit; and
		ii. Collecting the approved operating parameter (if any) data according to §63.6625(b); and
		iii. Reducing these data to 4-hour rolling averages; and
		iv. Maintaining the 4-hour rolling averages within the operating limitations for the operating parameters established during the performance test.
12. Existing limited use CI stationary RICE >500 HP	a. Reduce CO emissions or limit the concentration of CO in the stationary RICE exhaust, and using an oxidation catalyst	i. Conducting performance tests every 8,760 hours or 5 years, whichever comes first, for CO or formaldehyde, as appropriate, to demonstrate that the required CO or formaldehyde, as appropriate, percent reduction is achieved or that your emissions remain at or below the CO or formaldehyde concentration limit; and
		ii. Collecting the catalyst inlet temperature data according to §63.6625(b); and

		iii. Reducing these data to 4-hour rolling averages; and
		iv. Maintaining the 4-hour rolling averages within the operating limitations for the catalyst inlet temperature; and
		v. Measuring the pressure drop across the catalyst once per month and demonstrating that the pressure drop across the catalyst is within the operating limitation established during the performance test.
13. Existing limited use CI stationary RICE >500 HP	a. Reduce CO emissions or limit the concentration of CO in the stationary RICE exhaust, and not using an oxidation catalyst	i. Conducting performance tests every 8,760 hours or 5 years, whichever comes first, for CO or formaldehyde, as appropriate, to demonstrate that the required CO or formaldehyde, as appropriate, percent reduction is achieved or that your emissions remain at or below the CO or formaldehyde concentration limit; and
		ii. Collecting the approved operating parameter (if any) data according to §63.6625(b); and
		iii. Reducing these data to 4-hour rolling averages; and
		iv. Maintaining the 4-hour rolling averages within the operating limitations for the operating parameters established during the performance test.
14. Existing non-emergency 4SLB stationary RICE >500 HP located at an area source of HAP that are not remote stationary RICE and that are operated	a. Install an oxidation catalyst	i. Conducting annual compliance demonstrations as specified in §63.6640(c) to show that the average reduction of emissions of CO is 93 percent or more, or the average CO

<p>more than 24 hours per calendar year</p>		<p>concentration is less than or equal to 47 ppmvd at 15 percent O<sub>2</sub>; and either  ii. Collecting the catalyst inlet temperature data according to §63.6625(b), reducing these data to 4-hour rolling averages; and maintaining the 4-hour rolling averages within the limitation of greater than 450 °F and less than or equal to 1350 °F for the catalyst inlet temperature; or  iii. Immediately shutting down the engine if the catalyst inlet temperature exceeds 1350 °F.</p>
<p>15. Existing non-emergency 4SRB stationary RICE &gt;500 HP located at an area source of HAP that are not remote stationary RICE and that are operated more than 24 hours per calendar year</p>	<p>a. Install NSCR</p>	<p>i. Conducting annual compliance demonstrations as specified in §63.6640(c) to show that the average reduction of emissions of CO is 75 percent or more, the average CO concentration is less than or equal to 270 ppmvd at 15 percent O<sub>2</sub>, or the average reduction of emissions of THC is 30 percent or more; and either  ii. Collecting the catalyst inlet temperature data according to §63.6625(b), reducing these data to 4-hour rolling averages; and maintaining the 4-hour rolling averages within the limitation of greater than or equal to 750 °F and less than or equal to 1250 °F for the catalyst inlet temperature; or  iii. Immediately shutting down the engine if the catalyst inlet temperature exceeds 1250 °F.</p>

<sup>a</sup>After you have demonstrated compliance for two consecutive tests, you may reduce the frequency of subsequent performance tests to annually. If the results of any subsequent annual performance test indicate the stationary RICE is not in compliance with the CO or formaldehyde emission limitation, or you deviate from any of your operating limitations, you must resume semiannual performance tests.

[78 FR 6715, Jan. 30, 2013]

[↑ Back to Top](#)

**Table 7 to Subpart ZZZZ of Part 63—Requirements for Reports**

As stated in §63.6650, you must comply with the following requirements for reports:

<b>For each . . .</b>	<b>You must submit a . . .</b>	<b>The report must contain . . .</b>	<b>You must submit the report . . .</b>
<p>1. Existing non-emergency, non-black start stationary RICE <math>100 \leq \text{HP} \leq 500</math> located at a major source of HAP; existing non-emergency, non-black start stationary CI RICE <math>&gt;500</math> HP located at a major source of HAP; existing non-emergency 4SRB stationary RICE <math>&gt;500</math> HP located at a major source of HAP; existing non-emergency, non-black start stationary CI RICE <math>&gt;300</math> HP located at an area source of HAP; new or reconstructed non-emergency stationary RICE <math>&gt;500</math> HP located at a major source of HAP; and new or reconstructed non-emergency 4SLB stationary RICE <math>250 \leq \text{HP} \leq 500</math> located at a major source of HAP</p>	<p>Compliance report</p>	<p>a. If there are no deviations from any emission limitations or operating limitations that apply to you, a statement that there were no deviations from the emission limitations or operating limitations during the reporting period. If there were no periods during which the CMS, including CEMS and CPMS, was out-of-control, as specified in §63.8(c)(7), a statement that there were not periods during which the CMS was out-of-control during the reporting period; or</p>	<p>i. Semiannually according to the requirements in §63.6650(b)(1)-(5) for engines that are not limited use stationary RICE subject to numerical emission limitations; and ii. Annually according to the requirements in §63.6650(b)(6)-(9) for engines that are limited use stationary RICE subject to numerical emission limitations.</p>
		<p>b. If you had a deviation from any emission limitation or operating limitation during the reporting period, the information in §63.6650(d). If there were periods during which the CMS, including CEMS and CPMS, was out-of-control, as specified in §63.8(c)(7), the information in §63.6650(e); or</p>	<p>i. Semiannually according to the requirements in §63.6650(b).</p>
		<p>c. If you had a malfunction during the reporting period, the information in §63.6650(c)(4).</p>	<p>i. Semiannually according to the requirements in §63.6650(b).</p>



2. New or reconstructed non-emergency stationary RICE that combusts landfill gas or digester gas equivalent to 10 percent or more of the gross heat input on an annual basis	Report	a. The fuel flow rate of each fuel and the heating values that were used in your calculations, and you must demonstrate that the percentage of heat input provided by landfill gas or digester gas, is equivalent to 10 percent or more of the gross heat input on an annual basis; and	i. Annually, according to the requirements in §63.6650.
		b. The operating limits provided in your federally enforceable permit, and any deviations from these limits; and	i. See item 2.a.i.
		c. Any problems or errors suspected with the meters.	i. See item 2.a.i.
3. Existing non-emergency, non-black start 4SLB and 4SRB stationary RICE >500 HP located at an area source of HAP that are not remote stationary RICE and that operate more than 24 hours per calendar year	Compliance report	a. The results of the annual compliance demonstration, if conducted during the reporting period.	i. Semiannually according to the requirements in §63.6650(b)(1)-(5).
4. Emergency stationary RICE that operate or are contractually obligated to be available for more than 15 hours per year for the purposes specified in §63.6640(f)(2)(ii) and (iii) or that operate for the purposes specified in §63.6640(f)(4)(ii)	Report	a. The information in §63.6650(h)(1)	i. annually according to the requirements in §63.6650(h)(2)-(3).

[78 FR 6719, Jan. 30, 2013]

[↑ Back to Top](#)

**Table 8 to Subpart ZZZZ of Part 63—Applicability of General Provisions to Subpart ZZZZ.**

As stated in §63.6665, you must comply with the following applicable general provisions.

<b>General provisions citation</b>	<b>Subject of citation</b>	<b>Applies to subpart</b>	<b>Explanation</b>
§63.1	General applicability of the General Provisions	Yes.	
§63.2	Definitions	Yes	Additional terms defined in §63.6675.
§63.3	Units and abbreviations	Yes.	
§63.4	Prohibited activities and circumvention	Yes.	
§63.5	Construction and reconstruction	Yes.	
§63.6(a)	Applicability	Yes.	
§63.6(b)(1)-(4)	Compliance dates for new and reconstructed sources	Yes.	
§63.6(b)(5)	Notification	Yes.	
§63.6(b)(6)	[Reserved]		
§63.6(b)(7)	Compliance dates for new and reconstructed area sources that become major sources	Yes.	
§63.6(c)(1)-(2)	Compliance dates for existing sources	Yes.	
§63.6(c)(3)-(4)	[Reserved]		
§63.6(c)(5)	Compliance dates for existing area sources that become major sources	Yes.	
§63.6(d)	[Reserved]		

§63.6(e)	Operation and maintenance	No.	
§63.6(f)(1)	Applicability of standards	No.	
§63.6(f)(2)	Methods for determining compliance	Yes.	
§63.6(f)(3)	Finding of compliance	Yes.	
§63.6(g)(1)-(3)	Use of alternate standard	Yes.	
§63.6(h)	Opacity and visible emission standards	No	Subpart ZZZZ does not contain opacity or visible emission standards.
§63.6(i)	Compliance extension procedures and criteria	Yes.	
§63.6(j)	Presidential compliance exemption	Yes.	
§63.7(a)(1)-(2)	Performance test dates	Yes	Subpart ZZZZ contains performance test dates at §§63.6610, 63.6611, and 63.6612.
§63.7(a)(3)	CAA section 114 authority	Yes.	
§63.7(b)(1)	Notification of performance test	Yes	Except that §63.7(b)(1) only applies as specified in §63.6645.
§63.7(b)(2)	Notification of rescheduling	Yes	Except that §63.7(b)(2) only applies as specified in §63.6645.
§63.7(c)	Quality assurance/test plan	Yes	Except that §63.7(c) only applies as specified in §63.6645.
§63.7(d)	Testing facilities	Yes.	
§63.7(e)(1)	Conditions for conducting performance tests	No.	Subpart ZZZZ specifies conditions for conducting

			performance tests at §63.6620.
§63.7(e)(2)	Conduct of performance tests and reduction of data	Yes	Subpart ZZZZ specifies test methods at §63.6620.
§63.7(e)(3)	Test run duration	Yes.	
§63.7(e)(4)	Administrator may require other testing under section 114 of the CAA	Yes.	
§63.7(f)	Alternative test method provisions	Yes.	
§63.7(g)	Performance test data analysis, recordkeeping, and reporting	Yes.	
§63.7(h)	Waiver of tests	Yes.	
§63.8(a)(1)	Applicability of monitoring requirements	Yes	Subpart ZZZZ contains specific requirements for monitoring at §63.6625.
§63.8(a)(2)	Performance specifications	Yes.	
§63.8(a)(3)	[Reserved]		
§63.8(a)(4)	Monitoring for control devices	No.	
§63.8(b)(1)	Monitoring	Yes.	
§63.8(b)(2)-(3)	Multiple effluents and multiple monitoring systems	Yes.	
§63.8(c)(1)	Monitoring system operation and maintenance	Yes.	
§63.8(c)(1)(i)	Routine and predictable SSM	No	
§63.8(c)(1)(ii)	SSM not in Startup Shutdown	Yes.	

	Malfunction Plan		
§63.8(c)(1)(iii)	Compliance with operation and maintenance requirements	No	
§63.8(c)(2)-(3)	Monitoring system installation	Yes.	
§63.8(c)(4)	Continuous monitoring system (CMS) requirements	Yes	Except that subpart ZZZZ does not require Continuous Opacity Monitoring System (COMS).
§63.8(c)(5)	COMS minimum procedures	No	Subpart ZZZZ does not require COMS.
§63.8(c)(6)-(8)	CMS requirements	Yes	Except that subpart ZZZZ does not require COMS.
§63.8(d)	CMS quality control	Yes.	
§63.8(e)	CMS performance evaluation	Yes	Except for §63.8(e)(5)(ii), which applies to COMS.
		Except that §63.8(e) only applies as specified in §63.6645.	
§63.8(f)(1)-(5)	Alternative monitoring method	Yes	Except that §63.8(f)(4) only applies as specified in §63.6645.
§63.8(f)(6)	Alternative to relative accuracy test	Yes	Except that §63.8(f)(6) only applies as specified in §63.6645.
§63.8(g)	Data reduction	Yes	Except that provisions for COMS are not applicable. Averaging periods for demonstrating compliance are specified at §§63.6635 and 63.6640.

§63.9(a)	Applicability and State delegation of notification requirements	Yes.	
§63.9(b)(1)-(5)	Initial notifications	Yes	Except that §63.9(b)(3) is reserved.
		Except that §63.9(b) only applies as specified in §63.6645.	
§63.9(c)	Request for compliance extension	Yes	Except that §63.9(c) only applies as specified in §63.6645.
§63.9(d)	Notification of special compliance requirements for new sources	Yes	Except that §63.9(d) only applies as specified in §63.6645.
§63.9(e)	Notification of performance test	Yes	Except that §63.9(e) only applies as specified in §63.6645.
§63.9(f)	Notification of visible emission (VE)/opacity test	No	Subpart ZZZZ does not contain opacity or VE standards.
§63.9(g)(1)	Notification of performance evaluation	Yes	Except that §63.9(g) only applies as specified in §63.6645.
§63.9(g)(2)	Notification of use of COMS data	No	Subpart ZZZZ does not contain opacity or VE standards.
§63.9(g)(3)	Notification that criterion for alternative to RATA is exceeded	Yes	If alternative is in use.
		Except that §63.9(g) only applies as specified in §63.6645.	

§63.9(h)(1)-(6)	Notification of compliance status	Yes	Except that notifications for sources using a CEMS are due 30 days after completion of performance evaluations. §63.9(h)(4) is reserved.
			Except that §63.9(h) only applies as specified in §63.6645.
§63.9(i)	Adjustment of submittal deadlines	Yes.	
§63.9(j)	Change in previous information	Yes.	
§63.10(a)	Administrative provisions for recordkeeping/reporting	Yes.	
§63.10(b)(1)	Record retention	Yes	Except that the most recent 2 years of data do not have to be retained on site.
§63.10(b)(2)(i)-(v)	Records related to SSM	No.	
§63.10(b)(2)(vi)-(xi)	Records	Yes.	
§63.10(b)(2)(xii)	Record when under waiver	Yes.	
§63.10(b)(2)(xiii)	Records when using alternative to RATA	Yes	For CO standard if using RATA alternative.
§63.10(b)(2)(xiv)	Records of supporting documentation	Yes.	
§63.10(b)(3)	Records of applicability determination	Yes.	
§63.10(c)	Additional records for sources using CEMS	Yes	Except that §63.10(c)(2)-(4) and (9) are reserved.

§63.10(d)(1)	General reporting requirements	Yes.	
§63.10(d)(2)	Report of performance test results	Yes.	
§63.10(d)(3)	Reporting opacity or VE observations	No	Subpart ZZZZ does not contain opacity or VE standards.
§63.10(d)(4)	Progress reports	Yes.	
§63.10(d)(5)	Startup, shutdown, and malfunction reports	No.	
§63.10(e)(1) and (2)(i)	Additional CMS Reports	Yes.	
§63.10(e)(2)(ii)	COMS-related report	No	Subpart ZZZZ does not require COMS.
§63.10(e)(3)	Excess emission and parameter exceedances reports	Yes.	Except that §63.10(e)(3)(i) (C) is reserved.
§63.10(e)(4)	Reporting COMS data	No	Subpart ZZZZ does not require COMS.
§63.10(f)	Waiver for recordkeeping/reporting	Yes.	
§63.11	Flares	No.	
§63.12	State authority and delegations	Yes.	
§63.13	Addresses	Yes.	
§63.14	Incorporation by reference	Yes.	
§63.15	Availability of information	Yes.	

[75 FR 9688, Mar. 3, 2010, as amended at 78 FR 6720, Jan. 30, 2013]

[↑ Back to Top](#)



## Appendix A to Subpart ZZZZ of Part 63—Protocol for Using an Electrochemical Analyzer to Determine Oxygen and Carbon Monoxide Concentrations From Certain Engines

### 1.0 Scope and Application. What is this Protocol?

This protocol is a procedure for using portable electrochemical (EC) cells for measuring carbon monoxide (CO) and oxygen (O<sub>2</sub>) concentrations in controlled and uncontrolled emissions from existing stationary 4-stroke lean burn and 4-stroke rich burn reciprocating internal combustion engines as specified in the applicable rule.

#### 1.1 Analytes. What does this protocol determine?

This protocol measures the engine exhaust gas concentrations of carbon monoxide (CO) and oxygen (O<sub>2</sub>).

Analyte	CAS No.	Sensitivity
Carbon monoxide (CO)	630-08-0	Minimum detectable limit should be 2 percent of the nominal range or 1 ppm, whichever is less restrictive.
Oxygen (O <sub>2</sub> )	7782-44-7	

#### 1.2 Applicability. When is this protocol acceptable?

This protocol is applicable to 40 CFR part 63, subpart ZZZZ. Because of inherent cross sensitivities of EC cells, you must not apply this protocol to other emissions sources without specific instruction to that effect.

#### 1.3 Data Quality Objectives. How good must my collected data be?

Refer to Section 13 to verify and document acceptable analyzer performance.

#### 1.4 Range. What is the targeted analytical range for this protocol?

The measurement system and EC cell design(s) conforming to this protocol will determine the analytical range for each gas component. The nominal ranges are defined by choosing up-scale calibration gas concentrations near the maximum anticipated flue gas concentrations for CO and O<sub>2</sub>, or no more than twice the permitted CO level.

#### 1.5 Sensitivity. What minimum detectable limit will this protocol yield for a particular gas component?

The minimum detectable limit depends on the nominal range and resolution of the specific EC cell used, and the signal to noise ratio of the measurement system. The minimum detectable limit should be 2 percent of the nominal range or 1 ppm, whichever is less restrictive.

### 2.0 Summary of Protocol

In this protocol, a gas sample is extracted from an engine exhaust system and then conveyed to a portable EC analyzer for measurement of CO and O<sub>2</sub> gas concentrations. This method provides measurement system performance specifications and sampling protocols to ensure reliable data. You may use additions to, or modifications of vendor supplied measurement systems (e.g., heated or unheated sample lines, thermocouples, flow meters, selective gas scrubbers, etc.) to meet the design specifications of this protocol. Do not make changes to the measurement system from the as-verified configuration (Section 3.12).

### 3.0 Definitions

*3.1 Measurement System.* The total equipment required for the measurement of CO and O<sub>2</sub> concentrations. The measurement system consists of the following major subsystems:

*3.1.1 Data Recorder.* A strip chart recorder, computer or digital recorder for logging measurement data from the analyzer output. You may record measurement data from the digital data display manually or electronically.

*3.1.2 Electrochemical (EC) Cell.* A device, similar to a fuel cell, used to sense the presence of a specific analyte and generate an electrical current output proportional to the analyte concentration.

*3.1.3 Interference Gas Scrubber.* A device used to remove or neutralize chemical compounds that may interfere with the selective operation of an EC cell.

*3.1.4 Moisture Removal System.* Any device used to reduce the concentration of moisture in the sample stream so as to protect the EC cells from the damaging effects of condensation and to minimize errors in measurements caused by the scrubbing of soluble gases.

*3.1.5 Sample Interface.* The portion of the system used for one or more of the following: sample acquisition; sample transport; sample conditioning or protection of the EC cell from any degrading effects of the engine exhaust effluent; removal of particulate matter and condensed moisture.

*3.2 Nominal Range.* The range of analyte concentrations over which each EC cell is operated (normally 25 percent to 150 percent of up-scale calibration gas value). Several nominal ranges can be used for any given cell so long as the calibration and repeatability checks for that range remain within specifications.

*3.3 Calibration Gas.* A vendor certified concentration of a specific analyte in an appropriate balance gas.

*3.4 Zero Calibration Error.* The analyte concentration output exhibited by the EC cell in response to zero-level calibration gas.

*3.5 Up-Scale Calibration Error.* The mean of the difference between the analyte concentration exhibited by the EC cell and the certified concentration of the up-scale calibration gas.

*3.6 Interference Check.* A procedure for quantifying analytical interference from components in the engine exhaust gas other than the targeted analytes.

*3.7 Repeatability Check.* A protocol for demonstrating that an EC cell operated over a given nominal analyte concentration range provides a stable and consistent response and is not significantly affected by repeated exposure to that gas.

*3.8 Sample Flow Rate.* The flow rate of the gas sample as it passes through the EC cell. In some situations, EC cells can experience drift with changes in flow rate. The flow rate must be monitored and documented during all phases of a sampling run.

*3.9 Sampling Run.* A timed three-phase event whereby an EC cell's response rises and plateaus in a sample conditioning phase, remains relatively constant during a measurement data phase, then declines during a refresh phase. The sample conditioning phase exposes the EC cell to the gas sample for a length of time sufficient to reach a constant response. The measurement data phase is the time interval during which gas sample measurements can be made that meet the acceptance criteria of this protocol. The refresh phase then purges the EC cells with CO-free air. The refresh phase replenishes requisite O<sub>2</sub> and moisture in the electrolyte reserve and provides a mechanism to de-gas or desorb any interference gas scrubbers or filters so as to enable a stable CO EC cell response. There are four primary types of sampling runs: pre-sampling calibrations; stack gas sampling; post-sampling calibration checks; and measurement system repeatability checks. Stack gas sampling runs can be chained together for extended evaluations, providing all other procedural specifications are met.

*3.10 Sampling Day.* A time not to exceed twelve hours from the time of the pre-sampling calibration to the post-sampling calibration check. During this time, stack gas sampling runs can be repeated without repeated recalibrations, providing all other sampling specifications have been met.

*3.11 Pre-Sampling Calibration/Post-Sampling Calibration Check.* The protocols executed at the beginning and end of each sampling day to bracket measurement readings with controlled performance checks.

*3.12 Performance-Established Configuration.* The EC cell and sampling system configuration that existed at the time that it initially met the performance requirements of this protocol.

#### 4.0 Interferences.

When present in sufficient concentrations, NO and NO<sub>2</sub> are two gas species that have been reported to interfere with CO concentration measurements. In the likelihood of this occurrence, it is the protocol user's responsibility to employ and properly maintain an appropriate CO EC cell filter or scrubber for removal of these gases, as described in Section 6.2.12.

#### 5.0 Safety. [Reserved]

#### 6.0 Equipment and Supplies.

##### *6.1 What equipment do I need for the measurement system?*

The system must maintain the gas sample at conditions that will prevent moisture condensation in the sample transport lines, both before and as the sample gas contacts the EC cells. The essential components of the measurement system are described below.

## 6.2 Measurement System Components.

6.2.1 *Sample Probe.* A single extraction-point probe constructed of glass, stainless steel or other non-reactive material, and of length sufficient to reach any designated sampling point. The sample probe must be designed to prevent plugging due to condensation or particulate matter.

6.2.2 *Sample Line.* Non-reactive tubing to transport the effluent from the sample probe to the EC cell.

6.2.3 *Calibration Assembly (optional).* A three-way valve assembly or equivalent to introduce calibration gases at ambient pressure at the exit end of the sample probe during calibration checks. The assembly must be designed such that only stack gas or calibration gas flows in the sample line and all gases flow through any gas path filters.

6.2.4 *Particulate Filter (optional).* Filters before the inlet of the EC cell to prevent accumulation of particulate material in the measurement system and extend the useful life of the components. All filters must be fabricated of materials that are non-reactive to the gas mixtures being sampled.

6.2.5 *Sample Pump.* A leak-free pump to provide undiluted sample gas to the system at a flow rate sufficient to minimize the response time of the measurement system. If located upstream of the EC cells, the pump must be constructed of a material that is non-reactive to the gas mixtures being sampled.

6.2.8 *Sample Flow Rate Monitoring.* An adjustable rotameter or equivalent device used to adjust and maintain the sample flow rate through the analyzer as prescribed.

6.2.9 *Sample Gas Manifold (optional).* A manifold to divert a portion of the sample gas stream to the analyzer and the remainder to a by-pass discharge vent. The sample gas manifold may also include provisions for introducing calibration gases directly to the analyzer. The manifold must be constructed of a material that is non-reactive to the gas mixtures being sampled.

6.2.10 *EC cell.* A device containing one or more EC cells to determine the CO and O<sub>2</sub> concentrations in the sample gas stream. The EC cell(s) must meet the applicable performance specifications of Section 13 of this protocol.

6.2.11 *Data Recorder.* A strip chart recorder, computer or digital recorder to make a record of analyzer output data. The data recorder resolution (i.e., readability) must be no greater than 1 ppm for CO; 0.1 percent for O<sub>2</sub>; and one degree (either °C or °F) for temperature. Alternatively, you may use a digital or analog meter having the same resolution to observe and manually record the analyzer responses.

6.2.12 *Interference Gas Filter or Scrubber.* A device to remove interfering compounds upstream of the CO EC cell. Specific interference gas filters or scrubbers used in the performance-established configuration of the analyzer must continue to be used. Such a filter or scrubber must have a means to determine when the removal agent is exhausted. Periodically replace or replenish it in accordance with the manufacturer's recommendations.

7.0 Reagents and Standards. What calibration gases are needed?

7.1 *Calibration Gases.* CO calibration gases for the EC cell must be CO in nitrogen or CO in a mixture of nitrogen and O<sub>2</sub>. Use CO calibration gases with labeled concentration values certified by the

manufacturer to be within  $\pm 5$  percent of the label value. Dry ambient air (20.9 percent O<sub>2</sub>) is acceptable for calibration of the O<sub>2</sub> cell. If needed, any lower percentage O<sub>2</sub> calibration gas must be a mixture of O<sub>2</sub> in nitrogen.

*7.1.1 Up-Scale CO Calibration Gas Concentration.* Choose one or more up-scale gas concentrations such that the average of the stack gas measurements for each stack gas sampling run are between 25 and 150 percent of those concentrations. Alternatively, choose an up-scale gas that does not exceed twice the concentration of the applicable outlet standard. If a measured gas value exceeds 150 percent of the up-scale CO calibration gas value at any time during the stack gas sampling run, the run must be discarded and repeated.

*7.1.2 Up-Scale O<sub>2</sub> Calibration Gas Concentration.*

Select an O<sub>2</sub> gas concentration such that the difference between the gas concentration and the average stack gas measurement or reading for each sample run is less than 15 percent O<sub>2</sub>. When the average exhaust gas O<sub>2</sub> readings are above 6 percent, you may use dry ambient air (20.9 percent O<sub>2</sub>) for the up-scale O<sub>2</sub> calibration gas.

*7.1.3 Zero Gas.* Use an inert gas that contains less than 0.25 percent of the up-scale CO calibration gas concentration. You may use dry air that is free from ambient CO and other combustion gas products (e.g., CO<sub>2</sub>).

## 8.0 Sample Collection and Analysis

*8.1 Selection of Sampling Sites.*

*8.1.1 Control Device Inlet.* Select a sampling site sufficiently downstream of the engine so that the combustion gases should be well mixed. Use a single sampling extraction point near the center of the duct (e.g., within the 10 percent centroidal area), unless instructed otherwise.

*8.1.2 Exhaust Gas Outlet.* Select a sampling site located at least two stack diameters downstream of any disturbance (e.g., turbocharger exhaust, crossover junction or recirculation take-off) and at least one-half stack diameter upstream of the gas discharge to the atmosphere. Use a single sampling extraction point near the center of the duct (e.g., within the 10 percent centroidal area), unless instructed otherwise.

*8.2 Stack Gas Collection and Analysis.* Prior to the first stack gas sampling run, conduct that the pre-sampling calibration in accordance with Section 10.1. Use Figure 1 to record all data. Zero the analyzer with zero gas. Confirm and record that the scrubber media color is correct and not exhausted. Then position the probe at the sampling point and begin the sampling run at the same flow rate used during the up-scale calibration. Record the start time. Record all EC cell output responses and the flow rate during the “sample conditioning phase” once per minute until constant readings are obtained. Then begin the “measurement data phase” and record readings every 15 seconds for at least two minutes (or eight readings), or as otherwise required to achieve two continuous minutes of data that meet the specification given in Section 13.1. Finally, perform the “refresh phase” by introducing dry air, free from CO and other combustion gases, until several minute-to-minute readings of consistent value have been obtained. For each run use the “measurement data phase” readings to calculate the average stack gas CO and O<sub>2</sub> concentrations.

*8.3 EC Cell Rate.* Maintain the EC cell sample flow rate so that it does not vary by more than  $\pm 10$  percent throughout the pre-sampling calibration, stack gas sampling and post-sampling calibration check. Alternatively, the EC cell sample flow rate can be maintained within a tolerance range that does not affect the gas concentration readings by more than  $\pm 3$  percent, as instructed by the EC cell manufacturer.

## 9.0 Quality Control (Reserved)

## 10.0 Calibration and Standardization

*10.1 Pre-Sampling Calibration.* Conduct the following protocol once for each nominal range to be used on each EC cell before performing a stack gas sampling run on each field sampling day. Repeat the calibration if you replace an EC cell before completing all of the sampling runs. There is no prescribed order for calibration of the EC cells; however, each cell must complete the measurement data phase during calibration. Assemble the measurement system by following the manufacturer's recommended protocols including for preparing and preconditioning the EC cell. Assure the measurement system has no leaks and verify the gas scrubbing agent is not depleted. Use Figure 1 to record all data.

*10.1.1 Zero Calibration.* For both the O<sub>2</sub> and CO cells, introduce zero gas to the measurement system (e.g., at the calibration assembly) and record the concentration reading every minute until readings are constant for at least two consecutive minutes. Include the time and sample flow rate. Repeat the steps in this section at least once to verify the zero calibration for each component gas.

*10.1.2 Zero Calibration Tolerance.* For each zero gas introduction, the zero level output must be less than or equal to  $\pm 3$  percent of the up-scale gas value or  $\pm 1$  ppm, whichever is less restrictive, for the CO channel and less than or equal to  $\pm 0.3$  percent O<sub>2</sub> for the O<sub>2</sub> channel.

*10.1.3 Up-Scale Calibration.* Individually introduce each calibration gas to the measurement system (e.g., at the calibration assembly) and record the start time. Record all EC cell output responses and the flow rate during this "sample conditioning phase" once per minute until readings are constant for at least two minutes. Then begin the "measurement data phase" and record readings every 15 seconds for a total of two minutes, or as otherwise required. Finally, perform the "refresh phase" by introducing dry air, free from CO and other combustion gases, until readings are constant for at least two consecutive minutes. Then repeat the steps in this section at least once to verify the calibration for each component gas. Introduce all gases to flow through the entire sample handling system (i.e., at the exit end of the sampling probe or the calibration assembly).

*10.1.4 Up-Scale Calibration Error.* The mean of the difference of the "measurement data phase" readings from the reported standard gas value must be less than or equal to  $\pm 5$  percent or  $\pm 1$  ppm for CO or  $\pm 0.5$  percent O<sub>2</sub>, whichever is less restrictive, respectively. The maximum allowable deviation from the mean measured value of any single "measurement data phase" reading must be less than or equal to  $\pm 2$  percent or  $\pm 1$  ppm for CO or  $\pm 0.5$  percent O<sub>2</sub>, whichever is less restrictive, respectively.

*10.2 Post-Sampling Calibration Check.* Conduct a stack gas post-sampling calibration check after the stack gas sampling run or set of runs and within 12 hours of the initial calibration. Conduct up-scale and zero calibration checks using the protocol in Section 10.1. Make no changes to the sampling system or EC cell calibration until all post-sampling calibration checks have been recorded. If either the zero or up-scale calibration error exceeds the respective specification in Sections 10.1.2 and 10.1.4 then all measurement

data collected since the previous successful calibrations are invalid and re-calibration and re-sampling are required. If the sampling system is disassembled or the EC cell calibration is adjusted, repeat the calibration check before conducting the next analyzer sampling run.

## 11.0 Analytical Procedure

The analytical procedure is fully discussed in Section 8.

## 12.0 Calculations and Data Analysis

Determine the CO and O<sub>2</sub> concentrations for each stack gas sampling run by calculating the mean gas concentrations of the data recorded during the “measurement data phase”.

## 13.0 Protocol Performance

Use the following protocols to verify consistent analyzer performance during each field sampling day.

*13.1 Measurement Data Phase Performance Check.* Calculate the mean of the readings from the “measurement data phase”. The maximum allowable deviation from the mean for each of the individual readings is  $\pm 2$  percent, or  $\pm 1$  ppm, whichever is less restrictive. Record the mean value and maximum deviation for each gas monitored. Data must conform to Section 10.1.4. The EC cell flow rate must conform to the specification in Section 8.3.

*Example:* A measurement data phase is invalid if the maximum deviation of any single reading comprising that mean is greater than  $\pm 2$  percent *or*  $\pm 1$  ppm (the default criteria). For example, if the mean = 30 ppm, single readings of below 29 ppm and above 31 ppm are disallowed).

*13.2 Interference Check.* Before the initial use of the EC cell and interference gas scrubber in the field, and semi-annually thereafter, challenge the interference gas scrubber with NO and NO<sub>2</sub> gas standards that are generally recognized as representative of diesel-fueled engine NO and NO<sub>2</sub> emission values. Record the responses displayed by the CO EC cell and other pertinent data on Figure 1 or a similar form.

*13.2.1 Interference Response.* The combined NO and NO<sub>2</sub> interference response should be less than or equal to  $\pm 5$  percent of the up-scale CO calibration gas concentration.

*13.3 Repeatability Check.* Conduct the following check once for each nominal range that is to be used on the CO EC cell within 5 days prior to each field sampling program. If a field sampling program lasts longer than 5 days, repeat this check every 5 days. Immediately repeat the check if the EC cell is replaced or if the EC cell is exposed to gas concentrations greater than 150 percent of the highest up-scale gas concentration.

*13.3.1 Repeatability Check Procedure.* Perform a complete EC cell sampling run (all three phases) by introducing the CO calibration gas to the measurement system and record the response. Follow Section 10.1.3. Use Figure 1 to record all data. Repeat the run three times for a total of four complete runs. During the four repeatability check runs, do not adjust the system except where necessary to achieve the correct calibration gas flow rate at the analyzer.









# **APPENDIX L**

## Electronic Code of Federal Regulations

---

[View past updates to the e-CFR.](#)  
[Click here to learn more.](#)

---

**e-CFR data is current as of January 17, 2017**

[Title 40](#) → [Chapter I](#) → [Subchapter C](#) → [Part 63](#) → [Subpart DDDDD](#)

---

[Browse Previous](#) | [Browse Next](#)

Title 40: Protection of Environment

[PART 63—NATIONAL EMISSION STANDARDS FOR HAZARDOUS AIR POLLUTANTS FOR SOURCE CATEGORIES \(CONTINUED\)](#)

---

**Subpart DDDDD—National Emission Standards for Hazardous Air Pollutants for Major Sources: Industrial, Commercial, and Institutional Boilers and Process Heaters**

---

### Contents

#### [What This Subpart Covers](#)

- [§63.7480](#) What is the purpose of this subpart?
- [§63.7485](#) Am I subject to this subpart?
- [§63.7490](#) What is the affected source of this subpart?
- [§63.7491](#) Are any boilers or process heaters not subject to this subpart?
- [§63.7495](#) When do I have to comply with this subpart?

#### [Emission Limitations and Work Practice Standards](#)

- [§63.7499](#) What are the subcategories of boilers and process heaters?
- [§63.7500](#) What emission limitations, work practice standards, and operating limits must I meet?
- [§63.7501](#) [Reserved]

#### [General Compliance Requirements](#)

- [§63.7505](#) What are my general requirements for complying with this subpart?

#### [Testing, Fuel Analyses, and Initial Compliance Requirements](#)

- [§63.7510](#) What are my initial compliance requirements and by what date must I conduct them?
- [§63.7515](#) When must I conduct subsequent performance tests, fuel analyses, or tune-ups?

- §63.7520 What stack tests and procedures must I use?
- §63.7521 What fuel analyses, fuel specification, and procedures must I use?
- §63.7522 Can I use emissions averaging to comply with this subpart?
- §63.7525 What are my monitoring, installation, operation, and maintenance requirements?
- §63.7530 How do I demonstrate initial compliance with the emission limitations, fuel specifications and work practice standards?
- §63.7533 Can I use efficiency credits earned from implementation of energy conservation measures to comply with this subpart?

#### Continuous Compliance Requirements

- §63.7535 Is there a minimum amount of monitoring data I must obtain?
- §63.7540 How do I demonstrate continuous compliance with the emission limitations, fuel specifications and work practice standards?
- §63.7541 How do I demonstrate continuous compliance under the emissions averaging provision?

#### Notification, Reports, and Records

- §63.7545 What notifications must I submit and when?
- §63.7550 What reports must I submit and when?
- §63.7555 What records must I keep?
- §63.7560 In what form and how long must I keep my records?

#### Other Requirements and Information

- §63.7565 What parts of the General Provisions apply to me?
- §63.7570 Who implements and enforces this subpart?
- §63.7575 What definitions apply to this subpart?
- Table 1 to Subpart DDDDD of Part 63—Emission Limits for New or Reconstructed Boilers and Process Heaters
- Table 2 to Subpart DDDDD of Part 63—Emission Limits for Existing Boilers and Process Heaters
- Table 3 to Subpart DDDDD of Part 63—Work Practice Standards
- Table 4 to Subpart DDDDD of Part 63—Operating Limits for Boilers and Process Heaters
- Table 5 to Subpart DDDDD of Part 63—Performance Testing Requirements
- Table 6 to Subpart DDDDD of Part 63—Fuel Analysis Requirements
- Table 7 to Subpart DDDDD of Part 63—Establishing Operating Limits<sup>ab</sup>
- Table 8 to Subpart DDDDD of Part 63—Demonstrating Continuous Compliance
- Table 9 to Subpart DDDDD of Part 63—Reporting Requirements
- Table 10 to Subpart DDDDD of Part 63—Applicability of General Provisions to Subpart DDDDD
- Table 11 to Subpart DDDDD of Part 63—Alternative Emission Limits for New or Reconstructed Boilers and Process Heaters That Commenced Construction or Reconstruction After June 4, 2010, and Before May 20, 2011
- Table 12 to Subpart DDDDD of Part 63—Alternative Emission Limits for New or Reconstructed Boilers and Process Heaters That Commenced Construction or Reconstruction After May 20, 2011, and Before December 23, 2011
- Table 13 to Subpart DDDDD of Part 63—Alternative Emission Limits for New or Reconstructed Boilers

## and Process Heaters That Commenced Construction or Reconstruction After December 23, 2011, and Before April 1, 2013

---

Source: 76 FR 15664, Mar. 21, 2011, unless otherwise noted.

[↑ Back to Top](#)

### What This Subpart Covers

[↑ Back to Top](#)

#### **§63.7480 What is the purpose of this subpart?**

This subpart establishes national emission limitations and work practice standards for hazardous air pollutants (HAP) emitted from industrial, commercial, and institutional boilers and process heaters located at major sources of HAP. This subpart also establishes requirements to demonstrate initial and continuous compliance with the emission limitations and work practice standards.

[↑ Back to Top](#)

#### **§63.7485 Am I subject to this subpart?**

You are subject to this subpart if you own or operate an industrial, commercial, or institutional boiler or process heater as defined in §63.7575 that is located at, or is part of, a major source of HAP, except as specified in §63.7491. For purposes of this subpart, a major source of HAP is as defined in §63.2, except that for oil and natural gas production facilities, a major source of HAP is as defined in §63.7575.

[78 FR 7162, Jan. 31, 2013]

[↑ Back to Top](#)

#### **§63.7490 What is the affected source of this subpart?**

(a) This subpart applies to new, reconstructed, and existing affected sources as described in paragraphs (a)(1) and (2) of this section.

(1) The affected source of this subpart is the collection at a major source of all existing industrial, commercial, and institutional boilers and process heaters within a subcategory as defined in §63.7575.

(2) The affected source of this subpart is each new or reconstructed industrial, commercial, or institutional boiler or process heater, as defined in §63.7575, located at a major source.

(b) A boiler or process heater is new if you commence construction of the boiler or process heater after June 4, 2010, and you meet the applicability criteria at the time you commence construction.

(c) A boiler or process heater is reconstructed if you meet the reconstruction criteria as defined in §63.2, you commence reconstruction after June 4, 2010, and you meet the applicability criteria at the time you commence reconstruction.

(d) A boiler or process heater is existing if it is not new or reconstructed.

(e) An existing electric utility steam generating unit (EGU) that meets the applicability requirements of this subpart after the effective date of this final rule due to a change (e.g., fuel switch) is considered to be an existing source under this subpart.

[76 FR 15664, Mar. 21, 2011, as amended at 78 FR 7162, Jan. 31, 2013]

[↑ Back to Top](#)

### **§63.7491 Are any boilers or process heaters not subject to this subpart?**

The types of boilers and process heaters listed in paragraphs (a) through (n) of this section are not subject to this subpart.

(a) An electric utility steam generating unit (EGU) covered by subpart UUUUU of this part or a natural gas-fired EGU as defined in subpart UUUUU of this part firing at least 85 percent natural gas on an annual heat input basis.

(b) A recovery boiler or furnace covered by subpart MM of this part.

(c) A boiler or process heater that is used specifically for research and development, including test steam boilers used to provide steam for testing the propulsion systems on military vessels. This does not include units that provide heat or steam to a process at a research and development facility.

(d) A hot water heater as defined in this subpart.

(e) A refining kettle covered by subpart X of this part.

(f) An ethylene cracking furnace covered by subpart YY of this part.

(g) Blast furnace stoves as described in EPA-453/R-01-005 (incorporated by reference, see §63.14).

(h) Any boiler or process heater that is part of the affected source subject to another subpart of this part, such as boilers and process heaters used as control devices to comply with subparts JJJ, OOO, PPP, and U of this part.

(i) Any boiler or process heater that is used as a control device to comply with another subpart of this part, or part 60, part 61, or part 65 of this chapter provided that at least 50 percent of the average annual heat input during any 3 consecutive calendar years to the boiler or process heater is provided by regulated gas streams that are subject to another standard.

(j) Temporary boilers and process heaters as defined in this subpart.

(k) Blast furnace gas fuel-fired boilers and process heaters as defined in this subpart.

(l) Any boiler or process heater specifically listed as an affected source in any standard(s) established under section 129 of the Clean Air Act.

(m) A unit that burns hazardous waste covered by Subpart EEE of this part. A unit that is exempt from Subpart EEE as specified in §63.1200(b) is not covered by Subpart EEE.

(n) Residential boilers as defined in this subpart.

[76 FR 15664, Mar. 21, 2011, as amended at 78 FR 7162, Jan. 31, 2013; 80 FR 72806, Nov. 20, 2015]

[↑ Back to Top](#)

### **§63.7495 When do I have to comply with this subpart?**

(a) If you have a new or reconstructed boiler or process heater, you must comply with this subpart by April 1, 2013, or upon startup of your boiler or process heater, whichever is later.

(b) If you have an existing boiler or process heater, you must comply with this subpart no later than January 31, 2016, except as provided in §63.6(i).

(c) If you have an area source that increases its emissions or its potential to emit such that it becomes a major source of HAP, paragraphs (c)(1) and (2) of this section apply to you.

(1) Any new or reconstructed boiler or process heater at the existing source must be in compliance with this subpart upon startup.

(2) Any existing boiler or process heater at the existing source must be in compliance with this subpart within 3 years after the source becomes a major source.

(d) You must meet the notification requirements in §63.7545 according to the schedule in §63.7545 and in subpart A of this part. Some of the notifications must be submitted before you are required to comply with the emission limits and work practice standards in this subpart.

(e) If you own or operate an industrial, commercial, or institutional boiler or process heater and would be subject to this subpart except for the exemption in §63.7491(l) for commercial and industrial solid waste incineration units covered by part 60, subpart CCCC or subpart DDDD, and you cease combusting solid waste, you must be in compliance with this subpart and are no longer subject to part 60, subparts CCCC or DDDD beginning on the effective date of the switch as identified under the provisions of §60.2145(a)(2) and (3) or §60.2710(a)(2) and (3).

(f) If you own or operate an existing EGU that becomes subject to this subpart after January 31, 2016, you must be in compliance with the applicable existing source provisions of this subpart on the effective date such unit becomes subject to this subpart.

(g) If you own or operate an existing industrial, commercial, or institutional boiler or process heater and would be subject to this subpart except for an exemption in §63.7491(i) that becomes subject to this subpart after January 31, 2013, you must be in compliance with the applicable existing source provisions of this subpart within 3 years after such unit becomes subject to this subpart.



(h) If you own or operate an existing industrial, commercial, or institutional boiler or process heater and have switched fuels or made a physical change to the boiler or process heater that resulted in the applicability of a different subcategory after the compliance date of this subpart, you must be in compliance with the applicable existing source provisions of this subpart on the effective date of the fuel switch or physical change.

(i) If you own or operate a new industrial, commercial, or institutional boiler or process heater and have switched fuels or made a physical change to the boiler or process heater that resulted in the applicability of a different subcategory, you must be in compliance with the applicable new source provisions of this subpart on the effective date of the fuel switch or physical change.

[76 FR 15664, Mar. 21, 2011, as amended at 78 FR 7162, Jan. 31, 2013; 80 FR 72807, Nov. 20, 2015]

[↑ Back to Top](#)

## **Emission Limitations and Work Practice Standards**

[↑ Back to Top](#)

### **§63.7499 What are the subcategories of boilers and process heaters?**

The subcategories of boilers and process heaters, as defined in §63.7575 are:

- (a) Pulverized coal/solid fossil fuel units.
- (b) Stokers designed to burn coal/solid fossil fuel.
- (c) Fluidized bed units designed to burn coal/solid fossil fuel.
- (d) Stokers/sloped grate/other units designed to burn kiln dried biomass/bio-based solid.
- (e) Fluidized bed units designed to burn biomass/bio-based solid.
- (f) Suspension burners designed to burn biomass/bio-based solid.
- (g) Fuel cells designed to burn biomass/bio-based solid.
- (h) Hybrid suspension/grate burners designed to burn wet biomass/bio-based solid.
- (i) Stokers/sloped grate/other units designed to burn wet biomass/bio-based solid.
- (j) Dutch ovens/pile burners designed to burn biomass/bio-based solid.
- (k) Units designed to burn liquid fuel that are non-continental units.
- (l) Units designed to burn gas 1 fuels.
- (m) Units designed to burn gas 2 (other) gases.
- (n) Metal process furnaces.

- (o) Limited-use boilers and process heaters.
- (p) Units designed to burn solid fuel.
- (q) Units designed to burn liquid fuel.
- (r) Units designed to burn coal/solid fossil fuel.
- (s) Fluidized bed units with an integrated fluidized bed heat exchanger designed to burn coal/solid fossil fuel.
- (t) Units designed to burn heavy liquid fuel.
- (u) Units designed to burn light liquid fuel.

[76 FR 15664, Mar. 21, 2011, as amended at 78 FR 7163, Jan. 31, 2013]

[↑ Back to Top](#)

**§63.7500 What emission limitations, work practice standards, and operating limits must I meet?**

(a) You must meet the requirements in paragraphs (a)(1) through (3) of this section, except as provided in paragraphs (b), through (e) of this section. You must meet these requirements at all times the affected unit is operating, except as provided in paragraph (f) of this section.

(1) You must meet each emission limit and work practice standard in Tables 1 through 3, and 11 through 13 to this subpart that applies to your boiler or process heater, for each boiler or process heater at your source, except as provided under §63.7522. The output-based emission limits, in units of pounds per million Btu of steam output, in Tables 1 or 2 to this subpart are an alternative applicable only to boilers and process heaters that generate either steam, cogenerate steam with electricity, or both. The output-based emission limits, in units of pounds per megawatt-hour, in Tables 1 or 2 to this subpart are an alternative applicable only to boilers that generate only electricity. Boilers that perform multiple functions (cogeneration and electricity generation) or supply steam to common headers would calculate a total steam energy output using equation 21 of §63.7575 to demonstrate compliance with the output-based emission limits, in units of pounds per million Btu of steam output, in Tables 1 or 2 to this subpart. If you operate a new boiler or process heater, you can choose to comply with alternative limits as discussed in paragraphs (a)(1)(i) through (iii) of this section, but on or after January 31, 2016, you must comply with the emission limits in Table 1 to this subpart.

(i) If your boiler or process heater commenced construction or reconstruction after June 4, 2010 and before May 20, 2011, you may comply with the emission limits in Table 1 or 11 to this subpart until January 31, 2016.

(ii) If your boiler or process heater commenced construction or reconstruction on or after May 20, 2011 and before December 23, 2011, you may comply with the emission limits in Table 1 or 12 to this subpart until January 31, 2016.

(iii) If your boiler or process heater commenced construction or reconstruction on or after December 23, 2011 and before April 1, 2013, you may comply with the emission limits in Table 1 or 13 to this subpart until January 31, 2016.

(2) You must meet each operating limit in Table 4 to this subpart that applies to your boiler or process heater. If you use a control device or combination of control devices not covered in Table 4 to this subpart, or you wish to establish and monitor an alternative operating limit or an alternative monitoring parameter, you must apply to the EPA Administrator for approval of alternative monitoring under §63.8(f).

(3) At all times, you must operate and maintain any affected source (as defined in §63.7490), including associated air pollution control equipment and monitoring equipment, in a manner consistent with safety and good air pollution control practices for minimizing emissions. Determination of whether such operation and maintenance procedures are being used will be based on information available to the Administrator that may include, but is not limited to, monitoring results, review of operation and maintenance procedures, review of operation and maintenance records, and inspection of the source.

(b) As provided in §63.6(g), EPA may approve use of an alternative to the work practice standards in this section.

(c) Limited-use boilers and process heaters must complete a tune-up every 5 years as specified in §63.7540. They are not subject to the emission limits in Tables 1 and 2 or 11 through 13 to this subpart, the annual tune-up, or the energy assessment requirements in Table 3 to this subpart, or the operating limits in Table 4 to this subpart.

(d) Boilers and process heaters with a heat input capacity of less than or equal to 5 million Btu per hour in the units designed to burn gas 2 (other) fuels subcategory or units designed to burn light liquid fuels subcategory must complete a tune-up every 5 years as specified in §63.7540.

(e) Boilers and process heaters in the units designed to burn gas 1 fuels subcategory with a heat input capacity of less than or equal to 5 million Btu per hour must complete a tune-up every 5 years as specified in §63.7540. Boilers and process heaters in the units designed to burn gas 1 fuels subcategory with a heat input capacity greater than 5 million Btu per hour and less than 10 million Btu per hour must complete a tune-up every 2 years as specified in §63.7540. Boilers and process heaters in the units designed to burn gas 1 fuels subcategory are not subject to the emission limits in Tables 1 and 2 or 11 through 13 to this subpart, or the operating limits in Table 4 to this subpart.

(f) These standards apply at all times the affected unit is operating, except during periods of startup and shutdown during which time you must comply only with items 5 and 6 of Table 3 to this subpart.

[76 FR 15664, Mar. 21, 2011, as amended at 78 FR 7163, Jan. 31, 2013; 80 FR 72807, Nov. 20, 2015]

[↑ Back to Top](#)

**§63.7501 [Reserved]**

[↑ Back to Top](#)

## General Compliance Requirements

[↑ Back to Top](#)

### §63.7505 What are my general requirements for complying with this subpart?

(a) You must be in compliance with the emission limits, work practice standards, and operating limits in this subpart. These emission and operating limits apply to you at all times the affected unit is operating except for the periods noted in §63.7500(f).

(b) [Reserved]

(c) You must demonstrate compliance with all applicable emission limits using performance stack testing, fuel analysis, or continuous monitoring systems (CMS), including a continuous emission monitoring system (CEMS), or particulate matter continuous parameter monitoring system (PM CPMS), where applicable. You may demonstrate compliance with the applicable emission limit for hydrogen chloride (HCl), mercury, or total selected metals (TSM) using fuel analysis if the emission rate calculated according to §63.7530(c) is less than the applicable emission limit. (For gaseous fuels, you may not use fuel analyses to comply with the TSM alternative standard or the HCl standard.) Otherwise, you must demonstrate compliance for HCl, mercury, or TSM using performance stack testing, if subject to an applicable emission limit listed in Tables 1, 2, or 11 through 13 to this subpart.

(d) If you demonstrate compliance with any applicable emission limit through performance testing and subsequent compliance with operating limits through the use of CPMS, or with a CEMS or COMS, you must develop a site-specific monitoring plan according to the requirements in paragraphs (d)(1) through (4) of this section for the use of any CEMS, COMS, or CPMS. This requirement also applies to you if you petition the EPA Administrator for alternative monitoring parameters under §63.8(f).

(1) For each CMS required in this section (including CEMS, COMS, or CPMS), you must develop, and submit to the Administrator for approval upon request, a site-specific monitoring plan that addresses design, data collection, and the quality assurance and quality control elements outlined in §63.8(d) and the elements described in paragraphs (d)(1)(i) through (iii) of this section. You must submit this site-specific monitoring plan, if requested, at least 60 days before your initial performance evaluation of your CMS. This requirement to develop and submit a site specific monitoring plan does not apply to affected sources with existing CEMS or COMS operated according to the performance specifications under appendix B to part 60 of this chapter and that meet the requirements of §63.7525. Using the process described in §63.8(f)(4), you may request approval of alternative monitoring system quality assurance and quality control procedures in place of those specified in this paragraph and, if approved, include the alternatives in your site-specific monitoring plan.

(i) Installation of the CMS sampling probe or other interface at a measurement location relative to each affected process unit such that the measurement is representative of control of the exhaust emissions (e.g., on or downstream of the last control device);

(ii) Performance and equipment specifications for the sample interface, the pollutant concentration or parametric signal analyzer, and the data collection and reduction systems; and

(iii) Performance evaluation procedures and acceptance criteria (e.g., calibrations, accuracy audits, analytical drift).

(2) In your site-specific monitoring plan, you must also address paragraphs (d)(2)(i) through (iii) of this section.

(i) Ongoing operation and maintenance procedures in accordance with the general requirements of §63.8(c)(1)(ii), (c)(3), and (c)(4)(ii);

(ii) Ongoing data quality assurance procedures in accordance with the general requirements of §63.8(d); and

(iii) Ongoing recordkeeping and reporting procedures in accordance with the general requirements of §63.10(c) (as applicable in Table 10 to this subpart), (e)(1), and (e)(2)(i).

(3) You must conduct a performance evaluation of each CMS in accordance with your site-specific monitoring plan.

(4) You must operate and maintain the CMS in continuous operation according to the site-specific monitoring plan.

(e) If you have an applicable emission limit, and you choose to comply using definition (2) of “startup” in §63.7575, you must develop and implement a written startup and shutdown plan (SSP) according to the requirements in Table 3 to this subpart. The SSP must be maintained onsite and available upon request for public inspection.

[76 FR 15664, Mar. 21, 2011, as amended at 78 FR 7164, Jan. 31, 2013; 80 FR 72807, Nov. 20, 2015]

[↑ Back to Top](#)

## **Testing, Fuel Analyses, and Initial Compliance Requirements**

[↑ Back to Top](#)

### **§63.7510 What are my initial compliance requirements and by what date must I conduct them?**

(a) For each boiler or process heater that is required or that you elect to demonstrate compliance with any of the applicable emission limits in Tables 1 or 2 or 11 through 13 of this subpart through performance (stack) testing, your initial compliance requirements include all the following:

(1) Conduct performance tests according to §63.7520 and Table 5 to this subpart.

(2) Conduct a fuel analysis for each type of fuel burned in your boiler or process heater according to §63.7521 and Table 6 to this subpart, except as specified in paragraphs (a)(2)(i) through (iii) of this section.

(i) For each boiler or process heater that burns a single type of fuel, you are not required to conduct a fuel analysis for each type of fuel burned in your boiler or process heater according to §63.7521 and Table 6 to this subpart. For purposes of this subpart, units that use a supplemental fuel only for startup, unit

shutdown, and transient flame stability purposes still qualify as units that burn a single type of fuel, and the supplemental fuel is not subject to the fuel analysis requirements under §63.7521 and Table 6 to this subpart.

(ii) When natural gas, refinery gas, or other gas 1 fuels are co-fired with other fuels, you are not required to conduct a fuel analysis of those Gas 1 fuels according to §63.7521 and Table 6 to this subpart. If gaseous fuels other than natural gas, refinery gas, or other gas 1 fuels are co-fired with other fuels and those non-Gas 1 gaseous fuels are subject to another subpart of this part, part 60, part 61, or part 65, you are not required to conduct a fuel analysis of those non-Gas 1 fuels according to §63.7521 and Table 6 to this subpart.

(iii) You are not required to conduct a chlorine fuel analysis for any gaseous fuels. You must conduct a fuel analysis for mercury on gaseous fuels unless the fuel is exempted in paragraphs (a)(2)(i) and (ii) of this section.

(3) Establish operating limits according to §63.7530 and Table 7 to this subpart.

(4) Conduct CMS performance evaluations according to §63.7525.

(b) For each boiler or process heater that you elect to demonstrate compliance with the applicable emission limits in Tables 1 or 2 or 11 through 13 to this subpart for HCl, mercury, or TSM through fuel analysis, your initial compliance requirement is to conduct a fuel analysis for each type of fuel burned in your boiler or process heater according to §63.7521 and Table 6 to this subpart and establish operating limits according to §63.7530 and Table 8 to this subpart. The fuels described in paragraph (a)(2)(i) and (ii) of this section are exempt from these fuel analysis and operating limit requirements. The fuels described in paragraph (a)(2)(ii) of this section are exempt from the chloride fuel analysis and operating limit requirements. Boilers and process heaters that use a CEMS for mercury or HCl are exempt from the performance testing and operating limit requirements specified in paragraph (a) of this section for the HAP for which CEMS are used.

(c) If your boiler or process heater is subject to a carbon monoxide (CO) limit, your initial compliance demonstration for CO is to conduct a performance test for CO according to Table 5 to this subpart or conduct a performance evaluation of your continuous CO monitor, if applicable, according to §63.7525(a). Boilers and process heaters that use a CO CEMS to comply with the applicable alternative CO CEMS emission standard listed in Tables 1, 2, or 11 through 13 to this subpart, as specified in §63.7525(a), are exempt from the initial CO performance testing and oxygen concentration operating limit requirements specified in paragraph (a) of this section.

(d) If your boiler or process heater is subject to a PM limit, your initial compliance demonstration for PM is to conduct a performance test in accordance with §63.7520 and Table 5 to this subpart.

(e) For existing affected sources (as defined in §63.7490), you must complete the initial compliance demonstrations, as specified in paragraphs (a) through (d) of this section, no later than 180 days after the compliance date that is specified for your source in §63.7495 and according to the applicable provisions in §63.7(a)(2) as cited in Table 10 to this subpart, except as specified in paragraph (j) of this section. You must complete an initial tune-up by following the procedures described in §63.7540(a)(10)(i) through (vi) no later than the compliance date specified in §63.7495, except as specified in paragraph (j) of this

section. You must complete the one-time energy assessment specified in Table 3 to this subpart no later than the compliance date specified in §63.7495.

(f) For new or reconstructed affected sources (as defined in §63.7490), you must complete the initial compliance demonstration with the emission limits no later than July 30, 2013 or within 180 days after startup of the source, whichever is later. If you are demonstrating compliance with an emission limit in Tables 11 through 13 to this subpart that is less stringent (that is, higher) than the applicable emission limit in Table 1 to this subpart, you must demonstrate compliance with the applicable emission limit in Table 1 no later than July 29, 2016.

(g) For new or reconstructed affected sources (as defined in §63.7490), you must demonstrate initial compliance with the applicable work practice standards in Table 3 to this subpart within the applicable annual, biennial, or 5-year schedule as specified in §63.7515(d) following the initial compliance date specified in §63.7495(a). Thereafter, you are required to complete the applicable annual, biennial, or 5-year tune-up as specified in §63.7515(d).

(h) For affected sources (as defined in §63.7490) that ceased burning solid waste consistent with §63.7495(e) and for which the initial compliance date has passed, you must demonstrate compliance within 60 days of the effective date of the waste-to-fuel switch. If you have not conducted your compliance demonstration for this subpart within the previous 12 months, you must complete all compliance demonstrations for this subpart before you commence or recommence combustion of solid waste.

(i) For an existing EGU that becomes subject after January 31, 2016, you must demonstrate compliance within 180 days after becoming an affected source.

(j) For existing affected sources (as defined in §63.7490) that have not operated between the effective date of the rule and the compliance date that is specified for your source in §63.7495, you must complete the initial compliance demonstration, if subject to the emission limits in Table 2 to this subpart, as specified in paragraphs (a) through (d) of this section, no later than 180 days after the re-start of the affected source and according to the applicable provisions in §63.7(a)(2) as cited in Table 10 to this subpart. You must complete an initial tune-up by following the procedures described in §63.7540(a)(10)(i) through (vi) no later than 30 days after the re-start of the affected source and, if applicable, complete the one-time energy assessment specified in Table 3 to this subpart, no later than the compliance date specified in §63.7495.

(k) For affected sources, as defined in §63.7490, that switch subcategories consistent with §63.7545(h) after the initial compliance date, you must demonstrate compliance within 60 days of the effective date of the switch, unless you had previously conducted your compliance demonstration for this subcategory within the previous 12 months.

[78 FR 7164, Jan. 31, 2013, as amended at 80 FR 72808, Nov. 20, 2015]

[↑ Back to Top](#)

**§63.7515 When must I conduct subsequent performance tests, fuel analyses, or tune-ups?**

(a) You must conduct all applicable performance tests according to §63.7520 on an annual basis, except as specified in paragraphs (b) through (e), (g), and (h) of this section. Annual performance tests must be completed no more than 13 months after the previous performance test, except as specified in paragraphs (b) through (e), (g), and (h) of this section.

(b) If your performance tests for a given pollutant for at least 2 consecutive years show that your emissions are at or below 75 percent of the emission limit (or, in limited instances as specified in Tables 1 and 2 or 11 through 13 to this subpart, at or below the emission limit) for the pollutant, and if there are no changes in the operation of the individual boiler or process heater or air pollution control equipment that could increase emissions, you may choose to conduct performance tests for the pollutant every third year. Each such performance test must be conducted no more than 37 months after the previous performance test. If you elect to demonstrate compliance using emission averaging under §63.7522, you must continue to conduct performance tests annually. The requirement to test at maximum chloride input level is waived unless the stack test is conducted for HCl. The requirement to test at maximum mercury input level is waived unless the stack test is conducted for mercury. The requirement to test at maximum TSM input level is waived unless the stack test is conducted for TSM.

(c) If a performance test shows emissions exceeded the emission limit or 75 percent of the emission limit (as specified in Tables 1 and 2 or 11 through 13 to this subpart) for a pollutant, you must conduct annual performance tests for that pollutant until all performance tests over a consecutive 2-year period meet the required level (at or below 75 percent of the emission limit, as specified in Tables 1 and 2 or 11 through 13 to this subpart).

(d) If you are required to meet an applicable tune-up work practice standard, you must conduct an annual, biennial, or 5-year performance tune-up according to §63.7540(a)(10), (11), or (12), respectively. Each annual tune-up specified in §63.7540(a)(10) must be no more than 13 months after the previous tune-up. Each biennial tune-up specified in §63.7540(a)(11) must be conducted no more than 25 months after the previous tune-up. Each 5-year tune-up specified in §63.7540(a)(12) must be conducted no more than 61 months after the previous tune-up. For a new or reconstructed affected source (as defined in §63.7490), the first annual, biennial, or 5-year tune-up must be no later than 13 months, 25 months, or 61 months, respectively, after April 1, 2013 or the initial startup of the new or reconstructed affected source, whichever is later.

(e) If you demonstrate compliance with the mercury, HCl, or TSM based on fuel analysis, you must conduct a monthly fuel analysis according to §63.7521 for each type of fuel burned that is subject to an emission limit in Tables 1, 2, or 11 through 13 to this subpart. You may comply with this monthly requirement by completing the fuel analysis any time within the calendar month as long as the analysis is separated from the previous analysis by at least 14 calendar days. If you burn a new type of fuel, you must conduct a fuel analysis before burning the new type of fuel in your boiler or process heater. You must still meet all applicable continuous compliance requirements in §63.7540. If each of 12 consecutive monthly fuel analyses demonstrates 75 percent or less of the compliance level, you may decrease the fuel analysis frequency to quarterly for that fuel. If any quarterly sample exceeds 75 percent of the compliance level or you begin burning a new type of fuel, you must return to monthly monitoring for that fuel, until 12 months of fuel analyses are again less than 75 percent of the compliance level. If sampling is conducted



on one day per month, samples should be no less than 14 days apart, but if multiple samples are taken per month, the 14-day restriction does not apply.

(f) You must report the results of performance tests and the associated fuel analyses within 60 days after the completion of the performance tests. This report must also verify that the operating limits for each boiler or process heater have not changed or provide documentation of revised operating limits established according to §63.7530 and Table 7 to this subpart, as applicable. The reports for all subsequent performance tests must include all applicable information required in §63.7550.

(g) For affected sources (as defined in §63.7490) that have not operated since the previous compliance demonstration and more than one year has passed since the previous compliance demonstration, you must complete the subsequent compliance demonstration, if subject to the emission limits in Tables 1, 2, or 11 through 13 to this subpart, no later than 180 days after the re-start of the affected source and according to the applicable provisions in §63.7(a)(2) as cited in Table 10 to this subpart. You must complete a subsequent tune-up by following the procedures described in §63.7540(a)(10)(i) through (vi) and the schedule described in §63.7540(a)(13) for units that are not operating at the time of their scheduled tune-up.

(h) If your affected boiler or process heater is in the unit designed to burn light liquid subcategory and you combust ultra-low sulfur liquid fuel, you do not need to conduct further performance tests (stack tests or fuel analyses) if the pollutants measured during the initial compliance performance tests meet the emission limits in Tables 1 or 2 of this subpart providing you demonstrate ongoing compliance with the emissions limits by monitoring and recording the type of fuel combusted on a monthly basis. If you intend to use a fuel other than ultra-low sulfur liquid fuel, natural gas, refinery gas, or other gas 1 fuel, you must conduct new performance tests within 60 days of burning the new fuel type.

(i) If you operate a CO CEMS that meets the Performance Specifications outlined in §63.7525(a)(3) of this subpart to demonstrate compliance with the applicable alternative CO CEMS emission standard listed in Tables 1, 2, or 11 through 13 to this subpart, you are not required to conduct CO performance tests and are not subject to the oxygen concentration operating limit requirement specified in §63.7510(a).

[78 FR 7165, Jan. 31, 2013, as amended at 80 FR 72808, Nov. 20, 2015]

[↑ Back to Top](#)

### **§63.7520 What stack tests and procedures must I use?**

(a) You must conduct all performance tests according to §63.7(c), (d), (f), and (h). You must also develop a site-specific stack test plan according to the requirements in §63.7(c). You shall conduct all performance tests under such conditions as the Administrator specifies to you based on the representative performance of each boiler or process heater for the period being tested. Upon request, you shall make available to the Administrator such records as may be necessary to determine the conditions of the performance tests.

(b) You must conduct each performance test according to the requirements in Table 5 to this subpart.

(c) You must conduct each performance test under the specific conditions listed in Tables 5 and 7 to this subpart. You must conduct performance tests at representative operating load conditions while burning the type of fuel or mixture of fuels that has the highest content of chlorine and mercury, and TSM if you are opting to comply with the TSM alternative standard and you must demonstrate initial compliance and establish your operating limits based on these performance tests. These requirements could result in the need to conduct more than one performance test. Following each performance test and until the next performance test, you must comply with the operating limit for operating load conditions specified in Table 4 to this subpart.

(d) You must conduct a minimum of three separate test runs for each performance test required in this section, as specified in §63.7(e)(3). Each test run must comply with the minimum applicable sampling times or volumes specified in Tables 1 and 2 or 11 through 13 to this subpart.

(e) To determine compliance with the emission limits, you must use the F-Factor methodology and equations in sections 12.2 and 12.3 of EPA Method 19 at 40 CFR part 60, appendix A-7 of this chapter to convert the measured particulate matter (PM) concentrations, the measured HCl concentrations, the measured mercury concentrations, and the measured TSM concentrations that result from the performance test to pounds per million Btu heat input emission rates.

(f) Except for a 30-day rolling average based on CEMS (or sorbent trap monitoring system) data, if measurement results for any pollutant are reported as below the method detection level (e.g., laboratory analytical results for one or more sample components are below the method defined analytical detection level), you must use the method detection level as the measured emissions level for that pollutant in calculating compliance. The measured result for a multiple component analysis (e.g., analytical values for multiple Method 29 fractions both for individual HAP metals and for total HAP metals) may include a combination of method detection level data and analytical data reported above the method detection level.

[76 FR 15664, Mar. 21, 2011, as amended at 78 FR 7166, Jan. 31, 2013]

[↑ Back to Top](#)

### **§63.7521 What fuel analyses, fuel specification, and procedures must I use?**

(a) For solid and liquid fuels, you must conduct fuel analyses for chloride and mercury according to the procedures in paragraphs (b) through (e) of this section and Table 6 to this subpart, as applicable. For solid fuels and liquid fuels, you must also conduct fuel analyses for TSM if you are opting to comply with the TSM alternative standard. For gas 2 (other) fuels, you must conduct fuel analyses for mercury according to the procedures in paragraphs (b) through (e) of this section and Table 6 to this subpart, as applicable. (For gaseous fuels, you may not use fuel analyses to comply with the TSM alternative standard or the HCl standard.) For purposes of complying with this section, a fuel gas system that consists of multiple gaseous fuels collected and mixed with each other is considered a single fuel type and sampling and analysis is only required on the combined fuel gas system that will feed the boiler or process heater. Sampling and analysis of the individual gaseous streams prior to combining is not required. You are not required to conduct fuel analyses for fuels used for only startup, unit shutdown, and transient flame stability purposes. You are required to conduct fuel analyses only for fuels and units that are subject to emission limits for mercury, HCl, or TSM in Tables 1 and 2 or 11 through 13 to this

subpart. Gaseous and liquid fuels are exempt from the sampling requirements in paragraphs (c) and (d) of this section.

(b) You must develop a site-specific fuel monitoring plan according to the following procedures and requirements in paragraphs (b)(1) and (2) of this section, if you are required to conduct fuel analyses as specified in §63.7510.

(1) If you intend to use an alternative analytical method other than those required by Table 6 to this subpart, you must submit the fuel analysis plan to the Administrator for review and approval no later than 60 days before the date that you intend to conduct the initial compliance demonstration described in §63.7510.

(2) You must include the information contained in paragraphs (b)(2)(i) through (vi) of this section in your fuel analysis plan.

(i) The identification of all fuel types anticipated to be burned in each boiler or process heater.

(ii) For each anticipated fuel type, the notification of whether you or a fuel supplier will be conducting the fuel analysis.

(iii) For each anticipated fuel type, a detailed description of the sample location and specific procedures to be used for collecting and preparing the composite samples if your procedures are different from paragraph (c) or (d) of this section. Samples should be collected at a location that most accurately represents the fuel type, where possible, at a point prior to mixing with other dissimilar fuel types.

(iv) For each anticipated fuel type, the analytical methods from Table 6, with the expected minimum detection levels, to be used for the measurement of chlorine or mercury.

(v) If you request to use an alternative analytical method other than those required by Table 6 to this subpart, you must also include a detailed description of the methods and procedures that you are proposing to use. Methods in Table 6 shall be used until the requested alternative is approved.

(vi) If you will be using fuel analysis from a fuel supplier in lieu of site-specific sampling and analysis, the fuel supplier must use the analytical methods required by Table 6 to this subpart.

(c) You must obtain composite fuel samples for each fuel type according to the procedures in paragraph (c)(1) or (2) of this section, or the methods listed in Table 6 to this subpart, or use an automated sampling mechanism that provides representative composite fuel samples for each fuel type that includes both coarse and fine material. At a minimum, for demonstrating initial compliance by fuel analysis, you must obtain three composite samples. For monthly fuel analyses, at a minimum, you must obtain a single composite sample. For fuel analyses as part of a performance stack test, as specified in §63.7510(a), you must obtain a composite fuel sample during each performance test run.

(1) If sampling from a belt (or screw) feeder, collect fuel samples according to paragraphs (c)(1)(i) and (ii) of this section.

- (i) Stop the belt and withdraw a 6-inch wide sample from the full cross-section of the stopped belt to obtain a minimum two pounds of sample. You must collect all the material (fines and coarse) in the full cross-section. You must transfer the sample to a clean plastic bag.
- (ii) Each composite sample will consist of a minimum of three samples collected at approximately equal one-hour intervals during the testing period for sampling during performance stack testing.
- (2) If sampling from a fuel pile or truck, you must collect fuel samples according to paragraphs (c)(2)(i) through (iii) of this section.
- (i) For each composite sample, you must select a minimum of five sampling locations uniformly spaced over the surface of the pile.
- (ii) At each sampling site, you must dig into the pile to a uniform depth of approximately 18 inches. You must insert a clean shovel into the hole and withdraw a sample, making sure that large pieces do not fall off during sampling; use the same shovel to collect all samples.
- (iii) You must transfer all samples to a clean plastic bag for further processing.
- (d) You must prepare each composite sample according to the procedures in paragraphs (d)(1) through (7) of this section.
- (1) You must thoroughly mix and pour the entire composite sample over a clean plastic sheet.
- (2) You must break large sample pieces (e.g., larger than 3 inches) into smaller sizes.
- (3) You must make a pie shape with the entire composite sample and subdivide it into four equal parts.
- (4) You must separate one of the quarter samples as the first subset.
- (5) If this subset is too large for grinding, you must repeat the procedure in paragraph (d)(3) of this section with the quarter sample and obtain a one-quarter subset from this sample.
- (6) You must grind the sample in a mill.
- (7) You must use the procedure in paragraph (d)(3) of this section to obtain a one-quarter subsample for analysis. If the quarter sample is too large, subdivide it further using the same procedure.
- (e) You must determine the concentration of pollutants in the fuel (mercury and/or chlorine and/or TSM) in units of pounds per million Btu of each composite sample for each fuel type according to the procedures in Table 6 to this subpart, for use in Equations 7, 8, and 9 of this subpart.
- (f) To demonstrate that a gaseous fuel other than natural gas or refinery gas qualifies as an other gas 1 fuel, as defined in §63.7575, you must conduct a fuel specification analyses for mercury according to the procedures in paragraphs (g) through (i) of this section and Table 6 to this subpart, as applicable, except as specified in paragraph (f)(1) through (4) of this section, or as an alternative where fuel specification analysis is not practical, you must measure mercury concentration in the exhaust gas when firing only the gaseous fuel to be demonstrated as an other gas 1 fuel in the boiler or process heater according to the procedures in Table 6 to this subpart.

(1) You are not required to conduct the fuel specification analyses in paragraphs (g) through (i) of this section for natural gas or refinery gas.

(2) You are not required to conduct the fuel specification analyses in paragraphs (g) through (i) of this section for gaseous fuels that are subject to another subpart of this part, part 60, part 61, or part 65.

(3) You are not required to conduct the fuel specification analyses in paragraphs (g) through (i) of this section on gaseous fuels for units that are complying with the limits for units designed to burn gas 2 (other) fuels.

(4) You are not required to conduct the fuel specification analyses in paragraphs (g) through (i) of this section for gas streams directly derived from natural gas at natural gas production sites or natural gas plants.

(g) You must develop a site-specific fuel analysis plan for other gas 1 fuels according to the following procedures and requirements in paragraphs (g)(1) and (2) of this section.

(1) If you intend to use an alternative analytical method other than those required by Table 6 to this subpart, you must submit the fuel analysis plan to the Administrator for review and approval no later than 60 days before the date that you intend to conduct the initial compliance demonstration described in §63.7510.

(2) You must include the information contained in paragraphs (g)(2)(i) through (vi) of this section in your fuel analysis plan.

(i) The identification of all gaseous fuel types other than those exempted from fuel specification analysis under (f)(1) through (3) of this section anticipated to be burned in each boiler or process heater.

(ii) For each anticipated fuel type, the identification of whether you or a fuel supplier will be conducting the fuel specification analysis.

(iii) For each anticipated fuel type, a detailed description of the sample location and specific procedures to be used for collecting and preparing the samples if your procedures are different from the sampling methods contained in Table 6 to this subpart. Samples should be collected at a location that most accurately represents the fuel type, where possible, at a point prior to mixing with other dissimilar fuel types. If multiple boilers or process heaters are fueled by a common fuel stream it is permissible to conduct a single gas specification at the common point of gas distribution.

(iv) For each anticipated fuel type, the analytical methods from Table 6 to this subpart, with the expected minimum detection levels, to be used for the measurement of mercury.

(v) If you request to use an alternative analytical method other than those required by Table 6 to this subpart, you must also include a detailed description of the methods and procedures that you are proposing to use. Methods in Table 6 to this subpart shall be used until the requested alternative is approved.

(vi) If you will be using fuel analysis from a fuel supplier in lieu of site-specific sampling and analysis, the fuel supplier must use the analytical methods required by Table 6 to this subpart. When using a fuel

supplier's fuel analysis, the owner or operator is not required to submit the information in §63.7521(g)(2)(iii).

(h) You must obtain a single fuel sample for each fuel type for fuel specification of gaseous fuels.

(i) You must determine the concentration in the fuel of mercury, in units of microgram per cubic meter, dry basis, of each sample for each other gas 1 fuel type according to the procedures in Table 6 to this subpart.

[78 FR 7167, Jan. 31, 2013, as amended at 80 FR 72808, Nov. 20, 2015]

[↑ Back to Top](#)

### **§63.7522 Can I use emissions averaging to comply with this subpart?**

(a) As an alternative to meeting the requirements of §63.7500 for PM (or TSM), HCl, or mercury on a boiler or process heater-specific basis, if you have more than one existing boiler or process heater in any subcategories located at your facility, you may demonstrate compliance by emissions averaging, if your averaged emissions are not more than 90 percent of the applicable emission limit, according to the procedures in this section. You may not include new boilers or process heaters in an emissions average.

(b) For a group of two or more existing boilers or process heaters in the same subcategory that each vent to a separate stack, you may average PM (or TSM), HCl, or mercury emissions among existing units to demonstrate compliance with the limits in Table 2 to this subpart as specified in paragraph (b)(1) through (3) of this section, if you satisfy the requirements in paragraphs (c) through (g) of this section.

(1) You may average units using a CEMS or PM CPMS for demonstrating compliance.

(2) For mercury and HCl, averaging is allowed as follows:

(i) You may average among units in any of the solid fuel subcategories.

(ii) You may average among units in any of the liquid fuel subcategories.

(iii) You may average among units in a subcategory of units designed to burn gas 2 (other) fuels.

(iv) You may not average across the units designed to burn liquid, units designed to burn solid fuel, and units designed to burn gas 2 (other) subcategories.

(3) For PM (or TSM), averaging is only allowed between units within each of the following subcategories and you may not average across subcategories:

(i) Units designed to burn coal/solid fossil fuel.

(ii) Stokers/sloped grate/other units designed to burn kiln dried biomass/bio-based solids.

(iii) Stokers/sloped grate/other units designed to burn wet biomass/bio-based solids.

(iv) Fluidized bed units designed to burn biomass/bio-based solid.

- (v) Suspension burners designed to burn biomass/bio-based solid.
  - (vi) Dutch ovens/pile burners designed to burn biomass/bio-based solid.
  - (vii) Fuel Cells designed to burn biomass/bio-based solid.
  - (viii) Hybrid suspension/grate burners designed to burn wet biomass/bio-based solid.
  - (ix) Units designed to burn heavy liquid fuel.
  - (x) Units designed to burn light liquid fuel.
  - (xi) Units designed to burn liquid fuel that are non-continental units.
  - (xii) Units designed to burn gas 2 (other) gases.
- (c) For each existing boiler or process heater in the averaging group, the emission rate achieved during the initial compliance test for the HAP being averaged must not exceed the emission level that was being achieved on April 1, 2013 or the control technology employed during the initial compliance test must not be less effective for the HAP being averaged than the control technology employed on April 1, 2013.
- (d) The averaged emissions rate from the existing boilers and process heaters participating in the emissions averaging option must not exceed 90 percent of the limits in Table 2 to this subpart at all times the affected units are subject to numeric emission limits following the compliance date specified in §63.7495.
- (e) You must demonstrate initial compliance according to paragraph (e)(1) or (2) of this section using the maximum rated heat input capacity or maximum steam generation capacity of each unit and the results of the initial performance tests or fuel analysis.
- (1) You must use Equation 1a or 1b or 1c of this section to demonstrate that the PM (or TSM), HCl, or mercury emissions from all existing units participating in the emissions averaging option for that pollutant do not exceed the emission limits in Table 2 to this subpart. Use Equation 1a if you are complying with the emission limits on a heat input basis, use Equation 1b if you are complying with the emission limits on a steam generation (output) basis, and use Equation 1c if you are complying with the emission limits on a electric generation (output) basis.

$$AveWeightedEmissions = 1.1 \times \frac{\sum_{i=1}^n (Er \times Hm)}{\sum_{i=1}^n Hm} \quad (\text{Eq. 1a})$$

[View or download PDF](#)

Where:

AveWeightedEmissions = Average weighted emissions for PM (or TSM), HCl, or mercury, in units of pounds per million Btu of heat input.

Er = Emission rate (as determined during the initial compliance demonstration) of PM (or TSM), HCl, or mercury from unit, i, in units of pounds per million Btu of heat input. Determine the emission rate for PM

(or TSM), HCl, or mercury by performance testing according to Table 5 to this subpart, or by fuel analysis for HCl or mercury or TSM using the applicable equation in §63.7530(c).

Hm = Maximum rated heat input capacity of unit, i, in units of million Btu per hour.

n = Number of units participating in the emissions averaging option.

1.1 = Required discount factor.

$$AveWeightedEmissions = 1.1 \times \sum_{i=1}^n (Er \times So) \div \sum_{i=1}^n So \quad (\text{Eq. 1b})$$

[View or download PDF](#)

Where:

AveWeightedEmissions = Average weighted emissions for PM (or TSM), HCl, or mercury, in units of pounds per million Btu of steam output.

Er = Emission rate (as determined during the initial compliance demonstration) of PM (or TSM), HCl, or mercury from unit, i, in units of pounds per million Btu of steam output. Determine the emission rate for PM (or TSM), HCl, or mercury by performance testing according to Table 5 to this subpart, or by fuel analysis for HCl or mercury or TSM using the applicable equation in §63.7530(c). If you are taking credit for energy conservation measures from a unit according to §63.7533, use the adjusted emission level for that unit, Eadj, determined according to §63.7533 for that unit.

So = Maximum steam output capacity of unit, i, in units of million Btu per hour, as defined in §63.7575.

n = Number of units participating in the emissions averaging option.

1.1 = Required discount factor.

$$AveWeightedEmissions = 1.1 \times \sum_{i=1}^n (Er \times Eo) \div \sum_{i=1}^n Eo \quad (\text{Eq. 1c})$$

[View or download PDF](#)

Where:

AveWeightedEmissions = Average weighted emissions for PM (or TSM), HCl, or mercury, in units of pounds per megawatt hour.

Er = Emission rate (as determined during the initial compliance demonstration) of PM (or TSM), HCl, or mercury from unit, i, in units of pounds per megawatt hour. Determine the emission rate for PM (or TSM), HCl, or mercury by performance testing according to Table 5 to this subpart, or by fuel analysis for HCl or mercury or TSM using the applicable equation in §63.7530(c). If you are taking credit for energy conservation measures from a unit according to §63.7533, use the adjusted emission level for that unit, Eadj, determined according to §63.7533 for that unit.



$E_o$  = Maximum electric generating output capacity of unit,  $i$ , in units of megawatt hour, as defined in §63.7575.

$n$  = Number of units participating in the emissions averaging option.

1.1 = Required discount factor.

(2) If you are not capable of determining the maximum rated heat input capacity of one or more boilers that generate steam, you may use Equation 2 of this section as an alternative to using Equation 1a of this section to demonstrate that the PM (or TSM), HCl, or mercury emissions from all existing units participating in the emissions averaging option do not exceed the emission limits for that pollutant in Table 2 to this subpart that are in pounds per million Btu of heat input.

$$\text{AveWeightedEmissions} = 1.1 \times \sum_{i=1}^n (E_r \times S_m \times C_{fi}) \div \sum_{i=1}^n (S_m \times C_{fi}) \quad (\text{Eq. 2})$$

[View or download PDF](#)

Where:

$\text{AveWeightedEmissions}$  = Average weighted emission level for PM (or TSM), HCl, or mercury, in units of pounds per million Btu of heat input.

$E_r$  = Emission rate (as determined during the most recent compliance demonstration) of PM (or TSM), HCl, or mercury from unit,  $i$ , in units of pounds per million Btu of heat input. Determine the emission rate for PM (or TSM), HCl, or mercury by performance testing according to Table 5 to this subpart, or by fuel analysis for HCl or mercury or TSM using the applicable equation in §63.7530(c).

$S_m$  = Maximum steam generation capacity by unit,  $i$ , in units of pounds per hour.

$C_{fi}$  = Conversion factor, calculated from the most recent compliance test, in units of million Btu of heat input per pounds of steam generated for unit,  $i$ .

1.1 = Required discount factor.

(f) After the initial compliance demonstration described in paragraph (e) of this section, you must demonstrate compliance on a monthly basis determined at the end of every month (12 times per year) according to paragraphs (f)(1) through (3) of this section. The first monthly period begins on the compliance date specified in §63.7495. If the affected source elects to collect monthly data for up to the 11 months preceding the first monthly period, these additional data points can be used to compute the 12-month rolling average in paragraph (f)(3) of this section.

(1) For each calendar month, you must use Equation 3a or 3b or 3c of this section to calculate the average weighted emission rate for that month. Use Equation 3a and the actual heat input for the month for each existing unit participating in the emissions averaging option if you are complying with emission limits on a heat input basis. Use Equation 3b and the actual steam generation for the month if you are complying with the emission limits on a steam generation (output) basis. Use Equation 3c and the actual electrical generation for the month if you are complying with the emission limits on an electrical generation (output) basis.

$$AveWeightedEmissions = 1.1 \times \frac{\sum_{i=1}^n (Er \times Hb)}{\sum_{i=1}^n Hb} \quad (\text{Eq. 3a})$$

[View or download PDF](#)

Where:

AveWeightedEmissions = Average weighted emission level for PM (or TSM), HCl, or mercury, in units of pounds per million Btu of heat input, for that calendar month.

Er = Emission rate (as determined during the most recent compliance demonstration) of PM (or TSM), HCl, or mercury from unit, i, in units of pounds per million Btu of heat input. Determine the emission rate for PM (or TSM), HCl, or mercury by performance testing according to Table 5 to this subpart, or by fuel analysis for HCl or mercury or TSM according to Table 6 to this subpart.

Hb = The heat input for that calendar month to unit, i, in units of million Btu.

n = Number of units participating in the emissions averaging option.

1.1 = Required discount factor.

$$AveWeightedEmissions = 1.1 \times \frac{\sum_{i=1}^n (Er \times So)}{\sum_{i=1}^n So} \quad (\text{Eq. 3b})$$

[View or download PDF](#)

Where:

AveWeightedEmissions = Average weighted emission level for PM (or TSM), HCl, or mercury, in units of pounds per million Btu of steam output, for that calendar month.

Er = Emission rate (as determined during the most recent compliance demonstration) of PM (or TSM), HCl, or mercury from unit, i, in units of pounds per million Btu of steam output. Determine the emission rate for PM (or TSM), HCl, or mercury by performance testing according to Table 5 to this subpart, or by fuel analysis for HCl or mercury or TSM according to Table 6 to this subpart. If you are taking credit for energy conservation measures from a unit according to §63.7533, use the adjusted emission level for that unit,  $E_{adj}$ , determined according to §63.7533 for that unit.

So = The steam output for that calendar month from unit, i, in units of million Btu, as defined in §63.7575.

n = Number of units participating in the emissions averaging option.

1.1 = Required discount factor.

$$AveWeightedEmissions = 1.1 \times \frac{\sum_{i=1}^n (Er \times Eo)}{\sum_{i=1}^n Eo} \quad (\text{Eq. 3c})$$

[View or download PDF](#)

Where:

AveWeightedEmissions = Average weighted emission level for PM (or TSM), HCl, or mercury, in units of pounds per megawatt hour, for that calendar month.

Er = Emission rate (as determined during the most recent compliance demonstration) of PM (or TSM), HCl, or mercury from unit, i, in units of pounds per megawatt hour. Determine the emission rate for PM (or TSM), HCl, or mercury by performance testing according to Table 5 to this subpart, or by fuel analysis for HCl or mercury or TSM according to Table 6 to this subpart. If you are taking credit for energy conservation measures from a unit according to §63.7533, use the adjusted emission level for that unit, E<sub>adj</sub>, determined according to §63.7533 for that unit.

Eo = The electric generating output for that calendar month from unit, i, in units of megawatt hour, as defined in §63.7575.

n = Number of units participating in the emissions averaging option.

1.1 = Required discount factor.

(2) If you are not capable of monitoring heat input, you may use Equation 4 of this section as an alternative to using Equation 3a of this section to calculate the average weighted emission rate using the actual steam generation from the boilers participating in the emissions averaging option.

$$AveWeightedEmissions = 1.1 \times \frac{\sum_{i=1}^n (Er \times Sa \times Cfi)}{\sum_{i=1}^n (Sa \times Cfi)} \quad (\text{Eq. 4})$$

[View or download PDF](#)

Where:

AveWeightedEmissions = average weighted emission level for PM (or TSM), HCl, or mercury, in units of pounds per million Btu of heat input for that calendar month.

Er = Emission rate (as determined during the most recent compliance demonstration of PM (or TSM), HCl, or mercury from unit, i, in units of pounds per million Btu of heat input. Determine the emission rate for PM (or TSM), HCl, or mercury by performance testing according to Table 5 to this subpart, or by fuel analysis for HCl or mercury or TSM according to Table 6 to this subpart.

Sa = Actual steam generation for that calendar month by boiler, i, in units of pounds.

Cfi = Conversion factor, as calculated during the most recent compliance test, in units of million Btu of heat input per pounds of steam generated for boiler, i.

1.1 = Required discount factor.

(3) Until 12 monthly weighted average emission rates have been accumulated, calculate and report only the average weighted emission rate determined under paragraph (f)(1) or (2) of this section for each calendar month. After 12 monthly weighted average emission rates have been accumulated, for each subsequent calendar month, use Equation 5 of this section to calculate the 12-month rolling average of the monthly weighted average emission rates for the current calendar month and the previous 11 calendar months.

$$E_{avg} = \sum_{i=1}^{12} E_{Ri} + 12 \quad (\text{Eq. 5})$$

[View or download PDF](#)

Where:

$E_{avg}$  = 12-month rolling average emission rate, (pounds per million Btu heat input)

$E_{Ri}$  = Monthly weighted average, for calendar month “i” (pounds per million Btu heat input), as calculated by paragraph (f)(1) or (2) of this section.

(g) You must develop, and submit upon request to the applicable Administrator for review and approval, an implementation plan for emission averaging according to the following procedures and requirements in paragraphs (g)(1) through (4) of this section.

(1) If requested, you must submit the implementation plan no later than 180 days before the date that the facility intends to demonstrate compliance using the emission averaging option.

(2) You must include the information contained in paragraphs (g)(2)(i) through (vii) of this section in your implementation plan for all emission sources included in an emissions average:

(i) The identification of all existing boilers and process heaters in the averaging group, including for each either the applicable HAP emission level or the control technology installed as of January 31, 2013 and the date on which you are requesting emission averaging to commence;

(ii) The process parameter (heat input or steam generated) that will be monitored for each averaging group;

(iii) The specific control technology or pollution prevention measure to be used for each emission boiler or process heater in the averaging group and the date of its installation or application. If the pollution prevention measure reduces or eliminates emissions from multiple boilers or process heaters, the owner or operator must identify each boiler or process heater;

(iv) The test plan for the measurement of PM (or TSM), HCl, or mercury emissions in accordance with the requirements in §63.7520;

(v) The operating parameters to be monitored for each control system or device consistent with §63.7500 and Table 4, and a description of how the operating limits will be determined;

(vi) If you request to monitor an alternative operating parameter pursuant to §63.7525, you must also include:

(A) A description of the parameter(s) to be monitored and an explanation of the criteria used to select the parameter(s); and

(B) A description of the methods and procedures that will be used to demonstrate that the parameter indicates proper operation of the control device; the frequency and content of monitoring, reporting, and

recordkeeping requirements; and a demonstration, to the satisfaction of the Administrator, that the proposed monitoring frequency is sufficient to represent control device operating conditions; and

(vii) A demonstration that compliance with each of the applicable emission limit(s) will be achieved under representative operating load conditions. Following each compliance demonstration and until the next compliance demonstration, you must comply with the operating limit for operating load conditions specified in Table 4 to this subpart.

(3) If submitted upon request, the Administrator shall review and approve or disapprove the plan according to the following criteria:

(i) Whether the content of the plan includes all of the information specified in paragraph (g)(2) of this section; and

(ii) Whether the plan presents sufficient information to determine that compliance will be achieved and maintained.

(4) The applicable Administrator shall not approve an emission averaging implementation plan containing any of the following provisions:

(i) Any averaging between emissions of differing pollutants or between differing sources; or

(ii) The inclusion of any emission source other than an existing unit in the same subcategories.

(h) For a group of two or more existing affected units, each of which vents through a single common stack, you may average PM (or TSM), HCl, or mercury emissions to demonstrate compliance with the limits for that pollutant in Table 2 to this subpart if you satisfy the requirements in paragraph (i) or (j) of this section.

(i) For a group of two or more existing units in the same subcategory, each of which vents through a common emissions control system to a common stack, that does not receive emissions from units in other subcategories or categories, you may treat such averaging group as a single existing unit for purposes of this subpart and comply with the requirements of this subpart as if the group were a single unit.

(j) For all other groups of units subject to the common stack requirements of paragraph (h) of this section, including situations where the exhaust of affected units are each individually controlled and then sent to a common stack, the owner or operator may elect to:

(1) Conduct performance tests according to procedures specified in §63.7520 in the common stack if affected units from other subcategories vent to the common stack. The emission limits that the group must comply with are determined by the use of Equation 6 of this section.

$$E_n = \sum_{i=1}^n (EL_i \times H_i) + \sum_{i=1}^n H_i \quad (\text{Eq. 6})$$

[View or download PDF](#)

Where:

$E_n$  = HAP emission limit, pounds per million British thermal units (lb/MMBtu) or parts per million (ppm).

$E_{li}$  = Appropriate emission limit from Table 2 to this subpart for unit  $i$ , in units of lb/MMBtu or ppm.

$H_i$  = Heat input from unit  $i$ , MMBtu.

(2) Conduct performance tests according to procedures specified in §63.7520 in the common stack. If affected units and non-affected units vent to the common stack, the non-affected units must be shut down or vented to a different stack during the performance test unless the facility determines to demonstrate compliance with the non-affected units venting to the stack; and

(3) Meet the applicable operating limit specified in §63.7540 and Table 8 to this subpart for each emissions control system (except that, if each unit venting to the common stack has an applicable opacity operating limit, then a single continuous opacity monitoring system may be located in the common stack instead of in each duct to the common stack).

(k) The common stack of a group of two or more existing boilers or process heaters in the same subcategories subject to paragraph (h) of this section may be treated as a separate stack for purposes of paragraph (b) of this section and included in an emissions averaging group subject to paragraph (b) of this section.

[76 FR 15664, Mar. 21, 2011, as amended at 78 FR 7168, Jan. 31, 2013; 80 FR 72809, Nov. 20, 2015]

[↑ Back to Top](#)

### **§63.7525 What are my monitoring, installation, operation, and maintenance requirements?**

(a) If your boiler or process heater is subject to a CO emission limit in Tables 1, 2, or 11 through 13 to this subpart, you must install, operate, and maintain an oxygen analyzer system, as defined in §63.7575, or install, certify, operate and maintain continuous emission monitoring systems for CO and oxygen (or carbon dioxide (CO<sub>2</sub>)) according to the procedures in paragraphs (a)(1) through (6) of this section.

(1) Install the CO CEMS and oxygen (or CO<sub>2</sub>) analyzer by the compliance date specified in §63.7495. The CO and oxygen (or CO<sub>2</sub>) levels shall be monitored at the same location at the outlet of the boiler or process heater. An owner or operator may request an alternative test method under §63.7 of this chapter, in order that compliance with the CO emissions limit be determined using CO<sub>2</sub> as a diluent correction in place of oxygen at 3 percent. EPA Method 19 F-factors and EPA Method 19 equations must be used to generate the appropriate CO<sub>2</sub> correction percentage for the fuel type burned in the unit, and must also take into account that the 3 percent oxygen correction is to be done on a dry basis. The alternative test method request must account for any CO<sub>2</sub> being added to, or removed from, the emissions gas stream as a result of limestone injection, scrubber media, etc.

(2) To demonstrate compliance with the applicable alternative CO CEMS emission standard listed in Tables 1, 2, or 11 through 13 to this subpart, you must install, certify, operate, and maintain a CO CEMS and an oxygen analyzer according to the applicable procedures under Performance Specification 4, 4A, or 4B at 40 CFR part 60, appendix B; part 75 of this chapter (if an CO<sub>2</sub> analyzer is used); the site-specific

monitoring plan developed according to §63.7505(d); and the requirements in §63.7540(a)(8) and paragraph (a) of this section. Any boiler or process heater that has a CO CEMS that is compliant with Performance Specification 4, 4A, or 4B at 40 CFR part 60, appendix B, a site-specific monitoring plan developed according to §63.7505(d), and the requirements in §63.7540(a)(8) and paragraph (a) of this section must use the CO CEMS to comply with the applicable alternative CO CEMS emission standard listed in Tables 1, 2, or 11 through 13 to this subpart.

- (i) You must conduct a performance evaluation of each CO CEMS according to the requirements in §63.8(e) and according to Performance Specification 4, 4A, or 4B at 40 CFR part 60, appendix B.
  - (ii) During each relative accuracy test run of the CO CEMS, you must collect emission data for CO concurrently (or within a 30- to 60-minute period) by both the CO CEMS and by Method 10, 10A, or 10B at 40 CFR part 60, appendix A-4. The relative accuracy testing must be at representative operating conditions.
  - (iii) You must follow the quality assurance procedures (e.g., quarterly accuracy determinations and daily calibration drift tests) of Procedure 1 of appendix F to part 60. The measurement span value of the CO CEMS must be two times the applicable CO emission limit, expressed as a concentration.
  - (iv) Any CO CEMS that does not comply with §63.7525(a) cannot be used to meet any requirement in this subpart to demonstrate compliance with a CO emission limit listed in Tables 1, 2, or 11 through 13 to this subpart.
  - (v) For a new unit, complete the initial performance evaluation no later than July 30, 2013, or 180 days after the date of initial startup, whichever is later. For an existing unit, complete the initial performance evaluation no later than July 29, 2016.
  - (vi) When CO<sub>2</sub> is used to correct CO emissions and CO<sub>2</sub> is measured on a wet basis, correct for moisture as follows: Install, operate, maintain, and quality assure a continuous moisture monitoring system for measuring and recording the moisture content of the flue gases, in order to correct the measured hourly volumetric flow rates for moisture when calculating CO concentrations. The following continuous moisture monitoring systems are acceptable: A continuous moisture sensor; an oxygen analyzer (or analyzers) capable of measuring O<sub>2</sub> both on a wet basis and on a dry basis; or a stack temperature sensor and a moisture look-up table, *i.e.*, a psychrometric chart (for saturated gas streams following wet scrubbers or other demonstrably saturated gas streams, only). The moisture monitoring system shall include as a component the automated data acquisition and handling system (DAHS) for recording and reporting both the raw data (*e.g.*, hourly average wet-and dry basis O<sub>2</sub> values) and the hourly average values of the stack gas moisture content derived from those data. When a moisture look-up table is used, the moisture monitoring system shall be represented as a single component, the certified DAHS, in the monitoring plan for the unit or common stack.
- (3) Complete a minimum of one cycle of CO and oxygen (or CO<sub>2</sub>) CEMS operation (sampling, analyzing, and data recording) for each successive 15-minute period. Collect CO and oxygen (or CO<sub>2</sub>) data concurrently. Collect at least four CO and oxygen (or CO<sub>2</sub>) CEMS data values representing the four 15-minute periods in an hour, or at least two 15-minute data values during an hour when CEMS calibration, quality assurance, or maintenance activities are being performed.

(4) Reduce the CO CEMS data as specified in §63.8(g)(2).

(5) Calculate one-hour arithmetic averages, corrected to 3 percent oxygen (or corrected to an CO<sub>2</sub> percentage determined to be equivalent to 3 percent oxygen) from each hour of CO CEMS data in parts per million CO concentration. The one-hour arithmetic averages required shall be used to calculate the 30-day or 10-day rolling average emissions. Use Equation 19-19 in section 12.4.1 of Method 19 of 40 CFR part 60, appendix A-7 for calculating the average CO concentration from the hourly values.

(6) For purposes of collecting CO data, operate the CO CEMS as specified in §63.7535(b). You must use all the data collected during all periods in calculating data averages and assessing compliance, except that you must exclude certain data as specified in §63.7535(c). Periods when CO data are unavailable may constitute monitoring deviations as specified in §63.7535(d).

(7) Operate an oxygen trim system with the oxygen level set no lower than the lowest hourly average oxygen concentration measured during the most recent CO performance test as the operating limit for oxygen according to Table 7 to this subpart.

(b) If your boiler or process heater is in the unit designed to burn coal/solid fossil fuel subcategory or the unit designed to burn heavy liquid subcategory and has an average annual heat input rate greater than 250 MMBtu per hour from solid fossil fuel and/or heavy liquid, and you demonstrate compliance with the PM limit instead of the alternative TSM limit, you must install, maintain, and operate a PM CPMS monitoring emissions discharged to the atmosphere and record the output of the system as specified in paragraphs (b)(1) through (4) of this section. As an alternative to use of a PM CPMS to demonstrate compliance with the PM limit, you may choose to use a PM CEMS. If you choose to use a PM CEMS to demonstrate compliance with the PM limit instead of the alternative TSM limit, you must install, certify, maintain, and operate a PM CEMS monitoring emissions discharged to the atmosphere and record the output of the system as specified in paragraph (b)(5) through (8) of this section. For other boilers or process heaters, you may elect to use a PM CPMS or PM CEMS operated in accordance with this section in lieu of using other CMS for monitoring PM compliance (*e.g.*, bag leak detectors, ESP secondary power, and PM scrubber pressure). Owners of boilers and process heaters who elect to comply with the alternative TSM limit are not required to install a PM CPMS.

(1) Install, operate, and maintain your PM CPMS according to the procedures in your approved site-specific monitoring plan developed in accordance with §63.7505(d), the requirements in §63.7540(a)(9), and paragraphs (b)(1)(i) through (iii) of this section.

(i) The operating principle of the PM CPMS must be based on in-stack or extractive light scatter, light scintillation, beta attenuation, or mass accumulation detection of PM in the exhaust gas or representative exhaust gas sample. The reportable measurement output from the PM CPMS must be expressed as milliamps.

(ii) The PM CPMS must have a cycle time (*i.e.*, period required to complete sampling, measurement, and reporting for each measurement) no longer than 60 minutes.

(iii) The PM CPMS must have a documented detection limit of 0.5 milligram per actual cubic meter, or less.



(2) For a new unit, complete the initial performance evaluation no later than July 30, 2013, or 180 days after the date of initial startup, whichever is later. For an existing unit, complete the initial performance evaluation no later than July 29, 2016.

(3) Collect PM CPMS hourly average output data for all boiler or process heater operating hours except as indicated in §63.7535(a) through (d). Express the PM CPMS output as milliamps.

(4) Calculate the arithmetic 30-day rolling average of all of the hourly average PM CPMS output data collected during all boiler or process heater operating hours (milliamps).

(5) Install, certify, operate, and maintain your PM CEMS according to the procedures in your approved site-specific monitoring plan developed in accordance with §63.7505(d), the requirements in §63.7540(a)(9), and paragraphs (b)(5)(i) through (iv) of this section.

(i) You shall conduct a performance evaluation of the PM CEMS according to the applicable requirements of §60.8(e), and Performance Specification 11 at 40 CFR part 60, appendix B of this chapter.

(ii) During each PM correlation testing run of the CEMS required by Performance Specification 11 at 40 CFR part 60, appendix B of this chapter, you shall collect PM and oxygen (or carbon dioxide) data concurrently (or within a 30-to 60-minute period) by both the CEMS and conducting performance tests using Method 5 at 40 CFR part 60, appendix A-3 or Method 17 at 40 CFR part 60, appendix A-6 of this chapter.

(iii) You shall perform quarterly accuracy determinations and daily calibration drift tests in accordance with Procedure 2 at 40 CFR part 60, appendix F of this chapter. You must perform Relative Response Audits annually and perform Response Correlation Audits every 3 years.

(iv) Within 60 days after the date of completing each CEMS relative accuracy test audit or performance test conducted to demonstrate compliance with this subpart, you must submit the relative accuracy test audit data and performance test data to the EPA by successfully submitting the data electronically into the EPA's Central Data Exchange by using the Electronic Reporting Tool (see <http://www.epa.gov/ttn/chief/ert/erttool.html>).

(6) For a new unit, complete the initial performance evaluation no later than July 30, 2013, or 180 days after the date of initial startup, whichever is later. For an existing unit, complete the initial performance evaluation no later than July 29, 2016.

(7) Collect PM CEMS hourly average output data for all boiler or process heater operating hours except as indicated in §63.7535(a) through (d).

(8) Calculate the arithmetic 30-day rolling average of all of the hourly average PM CEMS output data collected during all boiler or process heater operating hours.

(c) If you have an applicable opacity operating limit in this rule, and are not otherwise required or elect to install and operate a PM CPMS, PM CEMS, or a bag leak detection system, you must install, operate, certify and maintain each COMS according to the procedures in paragraphs (c)(1) through (7) of this section by the compliance date specified in §63.7495.

(1) Each COMS must be installed, operated, and maintained according to Performance Specification 1 at appendix B to part 60 of this chapter.

(2) You must conduct a performance evaluation of each COMS according to the requirements in §63.8(e) and according to Performance Specification 1 at appendix B to part 60 of this chapter.

(3) As specified in §63.8(c)(4)(i), each COMS must complete a minimum of one cycle of sampling and analyzing for each successive 10-second period and one cycle of data recording for each successive 6-minute period.

(4) The COMS data must be reduced as specified in §63.8(g)(2).

(5) You must include in your site-specific monitoring plan procedures and acceptance criteria for operating and maintaining each COMS according to the requirements in §63.8(d). At a minimum, the monitoring plan must include a daily calibration drift assessment, a quarterly performance audit, and an annual zero alignment audit of each COMS.

(6) You must operate and maintain each COMS according to the requirements in the monitoring plan and the requirements of §63.8(e). You must identify periods the COMS is out of control including any periods that the COMS fails to pass a daily calibration drift assessment, a quarterly performance audit, or an annual zero alignment audit. Any 6-minute period for which the monitoring system is out of control and data are not available for a required calculation constitutes a deviation from the monitoring requirements.

(7) You must determine and record all the 6-minute averages (and daily block averages as applicable) collected for periods during which the COMS is not out of control.

(d) If you have an operating limit that requires the use of a CMS other than a PM CPMS or COMS, you must install, operate, and maintain each CMS according to the procedures in paragraphs (d)(1) through (5) of this section by the compliance date specified in §63.7495.

(1) The CPMS must complete a minimum of one cycle of operation every 15-minutes. You must have a minimum of four successive cycles of operation, one representing each of the four 15-minute periods in an hour, to have a valid hour of data.

(2) You must operate the monitoring system as specified in §63.7535(b), and comply with the data calculation requirements specified in §63.7535(c).

(3) Any 15-minute period for which the monitoring system is out-of-control and data are not available for a required calculation constitutes a deviation from the monitoring requirements. Other situations that constitute a monitoring deviation are specified in §63.7535(d).

(4) You must determine the 30-day rolling average of all recorded readings, except as provided in §63.7535(c).

(5) You must record the results of each inspection, calibration, and validation check.

(e) If you have an operating limit that requires the use of a flow monitoring system, you must meet the requirements in paragraphs (d) and (e)(1) through (4) of this section.

- (1) You must install the flow sensor and other necessary equipment in a position that provides a representative flow.
  - (2) You must use a flow sensor with a measurement sensitivity of no greater than 2 percent of the design flow rate.
  - (3) You must minimize, consistent with good engineering practices, the effects of swirling flow or abnormal velocity distributions due to upstream and downstream disturbances.
  - (4) You must conduct a flow monitoring system performance evaluation in accordance with your monitoring plan at the time of each performance test but no less frequently than annually.
- (f) If you have an operating limit that requires the use of a pressure monitoring system, you must meet the requirements in paragraphs (d) and (f)(1) through (6) of this section.
- (1) Install the pressure sensor(s) in a position that provides a representative measurement of the pressure (*e.g.*, PM scrubber pressure drop).
  - (2) Minimize or eliminate pulsating pressure, vibration, and internal and external corrosion consistent with good engineering practices.
  - (3) Use a pressure sensor with a minimum tolerance of 1.27 centimeters of water or a minimum tolerance of 1 percent of the pressure monitoring system operating range, whichever is less.
  - (4) Perform checks at least once each process operating day to ensure pressure measurements are not obstructed (*e.g.*, check for pressure tap pluggage daily).
  - (5) Conduct a performance evaluation of the pressure monitoring system in accordance with your monitoring plan at the time of each performance test but no less frequently than annually.
  - (6) If at any time the measured pressure exceeds the manufacturer's specified maximum operating pressure range, conduct a performance evaluation of the pressure monitoring system in accordance with your monitoring plan and confirm that the pressure monitoring system continues to meet the performance requirements in your monitoring plan. Alternatively, install and verify the operation of a new pressure sensor.
- (g) If you have an operating limit that requires a pH monitoring system, you must meet the requirements in paragraphs (d) and (g)(1) through (4) of this section.
- (1) Install the pH sensor in a position that provides a representative measurement of scrubber effluent pH.
  - (2) Ensure the sample is properly mixed and representative of the fluid to be measured.
  - (3) Calibrate the pH monitoring system in accordance with your monitoring plan and according to the manufacturer's instructions. Clean the pH probe at least once each process operating day. Maintain on-site documentation that your calibration frequency is sufficient to maintain the specified accuracy of your device.

(4) Conduct a performance evaluation (including a two-point calibration with one of the two buffer solutions having a pH within 1 of the pH of the operating limit) of the pH monitoring system in accordance with your monitoring plan at the time of each performance test but no less frequently than annually.

(h) If you have an operating limit that requires a secondary electric power monitoring system for an electrostatic precipitator (ESP) operated with a wet scrubber, you must meet the requirements in paragraphs (h)(1) and (2) of this section.

(1) Install sensors to measure (secondary) voltage and current to the precipitator collection plates.

(2) Conduct a performance evaluation of the electric power monitoring system in accordance with your monitoring plan at the time of each performance test but no less frequently than annually.

(i) If you have an operating limit that requires the use of a monitoring system to measure sorbent injection rate (e.g., weigh belt, weigh hopper, or hopper flow measurement device), you must meet the requirements in paragraphs (d) and (i)(1) through (2) of this section.

(1) Install the system in a position(s) that provides a representative measurement of the total sorbent injection rate.

(2) Conduct a performance evaluation of the sorbent injection rate monitoring system in accordance with your monitoring plan at the time of each performance test but no less frequently than annually.

(j) If you are not required to use a PM CPMS and elect to use a fabric filter bag leak detection system to comply with the requirements of this subpart, you must install, calibrate, maintain, and continuously operate the bag leak detection system as specified in paragraphs (j)(1) through (6) of this section.

(1) You must install a bag leak detection sensor(s) in a position(s) that will be representative of the relative or absolute PM loadings for each exhaust stack, roof vent, or compartment (e.g., for a positive pressure fabric filter) of the fabric filter.

(2) Conduct a performance evaluation of the bag leak detection system in accordance with your monitoring plan and consistent with the guidance provided in EPA-454/R-98-015 (incorporated by reference, see §63.14).

(3) Use a bag leak detection system certified by the manufacturer to be capable of detecting PM emissions at concentrations of 10 milligrams per actual cubic meter or less.

(4) Use a bag leak detection system equipped with a device to record continuously the output signal from the sensor.

(5) Use a bag leak detection system equipped with a system that will alert plant operating personnel when an increase in relative PM emissions over a preset level is detected. The alert must easily recognizable (e.g., heard or seen) by plant operating personnel.

(6) Where multiple bag leak detectors are required, the system's instrumentation and alert may be shared among detectors.

(k) For each unit that meets the definition of limited-use boiler or process heater, you must keep fuel use records for the days the boiler or process heater was operating.

(l) For each unit for which you decide to demonstrate compliance with the mercury or HCl emissions limits in Tables 1 or 2 or 11 through 13 of this subpart by use of a CEMS for mercury or HCl, you must install, certify, maintain, and operate a CEMS measuring emissions discharged to the atmosphere and record the output of the system as specified in paragraphs (1)(1) through (8) of this section. For HCl, this option for an affected unit takes effect on the date a final performance specification for a HCl CEMS is published in the Federal Register or the date of approval of a site-specific monitoring plan.

(1) Notify the Administrator one month before starting use of the CEMS, and notify the Administrator one month before stopping use of the CEMS.

(2) Each CEMS shall be installed, certified, operated, and maintained according to the requirements in §63.7540(a)(14) for a mercury CEMS and §63.7540(a)(15) for a HCl CEMS.

(3) For a new unit, you must complete the initial performance evaluation of the CEMS by the latest of the dates specified in paragraph (1)(3)(i) through (iii) of this section.

(i) No later than July 30, 2013.

(ii) No later 180 days after the date of initial startup.

(iii) No later 180 days after notifying the Administrator before starting to use the CEMS in place of performance testing or fuel analysis to demonstrate compliance.

(4) For an existing unit, you must complete the initial performance evaluation by the latter of the two dates specified in paragraph (1)(4)(i) and (ii) of this section.

(i) No later than July 29, 2016.

(ii) No later 180 days after notifying the Administrator before starting to use the CEMS in place of performance testing or fuel analysis to demonstrate compliance.

(5) Compliance with the applicable emissions limit shall be determined based on the 30-day rolling average of the hourly arithmetic average emissions rates using the continuous monitoring system outlet data. The 30-day rolling arithmetic average emission rate (lb/MMBtu) shall be calculated using the equations in EPA Reference Method 19 at 40 CFR part 60, appendix A-7, but substituting the mercury or HCl concentration for the pollutant concentrations normally used in Method 19.

(6) Collect CEMS hourly averages for all operating hours on a 30-day rolling average basis. Collect at least four CMS data values representing the four 15-minute periods in an hour, or at least two 15-minute data values during an hour when CMS calibration, quality assurance, or maintenance activities are being performed.

(7) The one-hour arithmetic averages required shall be expressed in lb/MMBtu and shall be used to calculate the boiler 30-day and 10-day rolling average emissions.

(8) You are allowed to substitute the use of the PM, mercury or HCl CEMS for the applicable fuel analysis, annual performance test, and operating limits specified in Table 4 to this subpart to demonstrate compliance with the PM, mercury or HCl emissions limit, and if you are using an acid gas wet scrubber or dry sorbent injection control technology to comply with the HCl emission limit, you are allowed to substitute the use of a sulfur dioxide (SO<sub>2</sub>) CEMS for the applicable fuel analysis, annual performance test, and operating limits specified in Table 4 to this subpart to demonstrate compliance with HCl emissions limit.

(m) If your unit is subject to a HCl emission limit in Tables 1, 2, or 11 through 13 of this subpart and you have an acid gas wet scrubber or dry sorbent injection control technology and you elect to use an SO<sub>2</sub> CEMS to demonstrate continuous compliance with the HCl emission limit, you must install the monitor at the outlet of the boiler or process heater, downstream of all emission control devices, and you must install, certify, operate, and maintain the CEMS according to either part 60 or part 75 of this chapter.

(1) The SO<sub>2</sub> CEMS must be installed by the compliance date specified in §63.7495.

(2) For on-going quality assurance (QA), the SO<sub>2</sub> CEMS must meet either the applicable daily and quarterly requirements in Procedure 1 of appendix F of part 60 or the applicable daily, quarterly, and semiannual or annual requirements in sections 2.1 through 2.3 of appendix B to part 75 of this chapter, with the following addition: You must perform the linearity checks required in section 2.2 of appendix B to part 75 of this chapter if the SO<sub>2</sub> CEMS has a span value of 30 ppm or less.

(3) For a new unit, the initial performance evaluation shall be completed no later than July 30, 2013, or 180 days after the date of initial startup, whichever is later. For an existing unit, the initial performance evaluation shall be completed no later than July 29, 2016.

(4) For purposes of collecting SO<sub>2</sub> data, you must operate the SO<sub>2</sub> CEMS as specified in §63.7535(b). You must use all the data collected during all periods in calculating data averages and assessing compliance, except that you must exclude certain data as specified in §63.7535(c). Periods when SO<sub>2</sub> data are unavailable may constitute monitoring deviations as specified in §63.7535(d).

(5) Collect CEMS hourly averages for all operating hours on a 30-day rolling average basis.

(6) Use only unadjusted, quality-assured SO<sub>2</sub> concentration values in the emissions calculations; do not apply bias adjustment factors to the part 75 SO<sub>2</sub> data and do not use part 75 substitute data values.

[76 FR 15664, Mar. 21, 2011, as amended at 78 FR 7171, Jan. 31, 2013; 80 FR 72810, Nov. 20, 2015]

[↑ Back to Top](#)

### **§63.7530 How do I demonstrate initial compliance with the emission limitations, fuel specifications and work practice standards?**

(a) You must demonstrate initial compliance with each emission limit that applies to you by conducting initial performance tests and fuel analyses and establishing operating limits, as applicable, according to §63.7520, paragraphs (b) and (c) of this section, and Tables 5 and 7 to this subpart. The requirement to conduct a fuel analysis is not applicable for units that burn a single type of fuel, as specified by

§63.7510(a)(2). If applicable, you must also install, operate, and maintain all applicable CMS (including CEMS, COMS, and CPMS) according to §63.7525.

(b) If you demonstrate compliance through performance stack testing, you must establish each site-specific operating limit in Table 4 to this subpart that applies to you according to the requirements in §63.7520, Table 7 to this subpart, and paragraph (b)(4) of this section, as applicable. You must also conduct fuel analyses according to §63.7521 and establish maximum fuel pollutant input levels according to paragraphs (b)(1) through (3) of this section, as applicable, and as specified in §63.7510(a)(2). (Note that §63.7510(a)(2) exempts certain fuels from the fuel analysis requirements.) However, if you switch fuel(s) and cannot show that the new fuel(s) does (do) not increase the chlorine, mercury, or TSM input into the unit through the results of fuel analysis, then you must repeat the performance test to demonstrate compliance while burning the new fuel(s).

(1) You must establish the maximum chlorine fuel input ( $Cl_{input}$ ) during the initial fuel analysis according to the procedures in paragraphs (b)(1)(i) through (iii) of this section.

(i) You must determine the fuel type or fuel mixture that you could burn in your boiler or process heater that has the highest content of chlorine.

(ii) During the fuel analysis for hydrogen chloride, you must determine the fraction of the total heat input for each fuel type burned ( $Q_i$ ) based on the fuel mixture that has the highest content of chlorine, and the average chlorine concentration of each fuel type burned ( $C_i$ ).

(iii) You must establish a maximum chlorine input level using Equation 7 of this section.

$$Cl_{input} = \sum_{i=1}^n (C_i \times Q_i) \quad (\text{Eq. 7})$$

[View or download PDF](#)

Where:

$Cl_{input}$  = Maximum amount of chlorine entering the boiler or process heater through fuels burned in units of pounds per million Btu.

$C_i$  = Arithmetic average concentration of chlorine in fuel type,  $i$ , analyzed according to §63.7521, in units of pounds per million Btu.

$Q_i$  = Fraction of total heat input from fuel type,  $i$ , based on the fuel mixture that has the highest content of chlorine during the initial compliance test. If you do not burn multiple fuel types during the performance testing, it is not necessary to determine the value of this term. Insert a value of “1” for  $Q_i$ . For continuous compliance demonstration, the actual fraction of the fuel burned during the month should be used.

$n$  = Number of different fuel types burned in your boiler or process heater for the mixture that has the highest content of chlorine.

(2) You must establish the maximum mercury fuel input level ( $Mercury_{input}$ ) during the initial fuel analysis using the procedures in paragraphs (b)(2)(i) through (iii) of this section.

- (i) You must determine the fuel type or fuel mixture that you could burn in your boiler or process heater that has the highest content of mercury.
- (ii) During the compliance demonstration for mercury, you must determine the fraction of total heat input for each fuel burned ( $Q_i$ ) based on the fuel mixture that has the highest content of mercury, and the average mercury concentration of each fuel type burned ( $HG_i$ ).
- (iii) You must establish a maximum mercury input level using Equation 8 of this section.

$$\text{Mercuryinput} = \sum_{i=1}^n (HG_i \times Q_i) \quad (\text{Eq. 8})$$

[View or download PDF](#)

Where:

Mercuryinput = Maximum amount of mercury entering the boiler or process heater through fuels burned in units of pounds per million Btu.

$HG_i$  = Arithmetic average concentration of mercury in fuel type,  $i$ , analyzed according to §63.7521, in units of pounds per million Btu.

$Q_i$  = Fraction of total heat input from fuel type,  $i$ , based on the fuel mixture that has the highest mercury content during the initial compliance test. If you do not burn multiple fuel types during the performance test, it is not necessary to determine the value of this term. Insert a value of “1” for  $Q_i$ . For continuous compliance demonstration, the actual fraction of the fuel burned during the month should be used.

$n$  = Number of different fuel types burned in your boiler or process heater for the mixture that has the highest content of mercury.

(3) If you opt to comply with the alternative TSM limit, you must establish the maximum TSM fuel input (TSMinput) for solid or liquid fuels during the initial fuel analysis according to the procedures in paragraphs (b)(3)(i) through (iii) of this section.

- (i) You must determine the fuel type or fuel mixture that you could burn in your boiler or process heater that has the highest content of TSM.
- (ii) During the fuel analysis for TSM, you must determine the fraction of the total heat input for each fuel type burned ( $Q_i$ ) based on the fuel mixture that has the highest content of TSM, and the average TSM concentration of each fuel type burned ( $TSM_i$ ).
- (iii) You must establish a maximum TSM input level using Equation 9 of this section.

$$\text{TSMinput} = \sum_{i=1}^n (TSM_i \times Q_i) \quad (\text{Eq. 9})$$

[View or download PDF](#)

Where:



TSM<sub>input</sub> = Maximum amount of TSM entering the boiler or process heater through fuels burned in units of pounds per million Btu.

TSM<sub>i</sub> = Arithmetic average concentration of TSM in fuel type, i, analyzed according to §63.7521, in units of pounds per million Btu.

Q<sub>i</sub> = Fraction of total heat input from fuel type, i, based on the fuel mixture that has the highest content of TSM during the initial compliance test. If you do not burn multiple fuel types during the performance testing, it is not necessary to determine the value of this term. Insert a value of “1” for Q<sub>i</sub>. For continuous compliance demonstration, the actual fraction of the fuel burned during the month should be used.

n = Number of different fuel types burned in your boiler or process heater for the mixture that has the highest content of TSM.

(4) You must establish parameter operating limits according to paragraphs (b)(4)(i) through (ix) of this section. As indicated in Table 4 to this subpart, you are not required to establish and comply with the operating parameter limits when you are using a CEMS to monitor and demonstrate compliance with the applicable emission limit for that control device parameter.

(i) For a wet acid gas scrubber, you must establish the minimum scrubber effluent pH and liquid flow rate as defined in §63.7575, as your operating limits during the performance test during which you demonstrate compliance with your applicable limit. If you use a wet scrubber and you conduct separate performance tests for HCl and mercury emissions, you must establish one set of minimum scrubber effluent pH, liquid flow rate, and pressure drop operating limits. The minimum scrubber effluent pH operating limit must be established during the HCl performance test. If you conduct multiple performance tests, you must set the minimum liquid flow rate operating limit at the higher of the minimum values established during the performance tests.

(ii) For any particulate control device (e.g., ESP, particulate wet scrubber, fabric filter) for which you use a PM CPMS, you must establish your PM CPMS operating limit and determine compliance with it according to paragraphs (b)(4)(ii)(A) through (F) of this section.

(A) Determine your operating limit as the average PM CPMS output value recorded during the most recent performance test run demonstrating compliance with the filterable PM emission limit or at the PM CPMS output value corresponding to 75 percent of the emission limit if your PM performance test demonstrates compliance below 75 percent of the emission limit. You must verify an existing or establish a new operating limit after each repeated performance test. You must repeat the performance test annually and reassess and adjust the site-specific operating limit in accordance with the results of the performance test.

(1) Your PM CPMS must provide a 4-20 milliamp output and the establishment of its relationship to manual reference method measurements must be determined in units of milliamps.

(2) Your PM CPMS operating range must be capable of reading PM concentrations from zero to a level equivalent to at least two times your allowable emission limit. If your PM CPMS is an auto-ranging instrument capable of multiple scales, the primary range of the instrument must be capable of reading PM concentration from zero to a level equivalent to two times your allowable emission limit.

(3) During the initial performance test or any such subsequent performance test that demonstrates compliance with the PM limit, record and average all milliamp output values from the PM CPMS for the periods corresponding to the compliance test runs (e.g., average all your PM CPMS output values for three corresponding 2-hour Method 5I test runs).

(B) If the average of your three PM performance test runs are below 75 percent of your PM emission limit, you must calculate an operating limit by establishing a relationship of PM CPMS signal to PM concentration using the PM CPMS instrument zero, the average PM CPMS values corresponding to the three compliance test runs, and the average PM concentration from the Method 5 or performance test with the procedures in paragraphs (b)(4)(ii)(B)(1) through (4) of this section.

(1) Determine your instrument zero output with one of the following procedures:

(i) Zero point data for *in-situ* instruments should be obtained by removing the instrument from the stack and monitoring ambient air on a test bench.

(ii) Zero point data for *extractive* instruments should be obtained by removing the extractive probe from the stack and drawing in clean ambient air.

(iii) The zero point may also be established by performing manual reference method measurements when the flue gas is free of PM emissions or contains very low PM concentrations (e.g., when your process is not operating, but the fans are operating or your source is combusting only natural gas) and plotting these with the compliance data to find the zero intercept.

(iv) If none of the steps in paragraphs (b)(4)(ii)(B)(1)(i) through (iii) of this section are possible, you must use a zero output value provided by the manufacturer.

(2) Determine your PM CPMS instrument average in milliamps, and the average of your corresponding three PM compliance test runs, using equation 10.

$$\bar{X} = \frac{1}{n} \sum_{i=1}^n X_i, \bar{Y} = \frac{1}{n} \sum_{i=1}^n Y_i \quad (\text{Eq. 10})$$

[View or download PDF](#)

Where:

$X_i$  = the PM CPMS data points for the three runs constituting the performance test,

$Y_i$  = the PM concentration value for the three runs constituting the performance test, and

$n$  = the number of data points.

(3) With your instrument zero expressed in milliamps, your three run average PM CPMS milliamp value, and your three run average PM concentration from your three compliance tests, determine a relationship of lb/MMBtu per milliamp with equation 11.

$$R = \frac{Y_i}{(X_i - z)} \quad (\text{Eq. 11})$$

[View or download PDF](#)

Where:

R = the relative lb/MMBtu per milliamp for your PM CPMS,

$Y_1$  = the three run average lb/MMBtu PM concentration,

$X_1$  = the three run average milliamp output from your PM CPMS, and

z = the milliamp equivalent of your instrument zero determined from (B)(i).

(4) Determine your source specific 30-day rolling average operating limit using the lb/MMBtu per milliamp value from Equation 11 in equation 12, below. This sets your operating limit at the PM CPMS output value corresponding to 75 percent of your emission limit.

$$O_1 = z + \frac{0.75(L)}{R} \quad (\text{Eq. 12})$$

[View or download PDF](#)

Where:

$O_1$  = the operating limit for your PM CPMS on a 30-day rolling average, in milliamps.

L = your source emission limit expressed in lb/MMBtu,

z = your instrument zero in milliamps, determined from (B)(i), and

R = the relative lb/MMBtu per milliamp for your PM CPMS, from Equation 11.

(C) If the average of your three PM compliance test runs is at or above 75 percent of your PM emission limit you must determine your 30-day rolling average operating limit by averaging the PM CPMS milliamp output corresponding to your three PM performance test runs that demonstrate compliance with the emission limit using equation 13 and you must submit all compliance test and PM CPMS data according to the reporting requirements in paragraph (b)(4)(ii)(F) of this section.

$$O_h = \frac{1}{n} \sum_{i=1}^n X_i \quad (\text{Eq. 13})$$

[View or download PDF](#)

Where:

$X_i$  = the PM CPMS data points for all runs i,

n = the number of data points, and

$O_h$  = your site specific operating limit, in milliamps.

(D) To determine continuous compliance, you must record the PM CPMS output data for all periods when the process is operating and the PM CPMS is not out-of-control. You must demonstrate continuous compliance by using all quality-assured hourly average data collected by the PM CPMS for all operating hours to calculate the arithmetic average operating parameter in units of the operating limit (milliamps) on a 30-day rolling average basis, updated at the end of each new operating hour. Use Equation 14 to determine the 30-day rolling average.

$$30\text{-day} = \frac{\sum_{i=1}^n H_{pvi}}{n} \quad (\text{Eq. 14})$$

[View or download PDF](#)

Where:

30-day = 30-day average.

$H_{pvi}$  = is the hourly parameter value for hour  $i$

$n$  = is the number of valid hourly parameter values collected over the previous 30 operating days.

(E) Use EPA Method 5 of appendix A to part 60 of this chapter to determine PM emissions. For each performance test, conduct three separate runs under the conditions that exist when the affected source is operating at the highest load or capacity level reasonably expected to occur. Conduct each test run to collect a minimum sample volume specified in Tables 1, 2, or 11 through 13 to this subpart, as applicable, for determining compliance with a new source limit or an existing source limit. Calculate the average of the results from three runs to determine compliance. You need not determine the PM collected in the impingers (“back half”) of the Method 5 particulate sampling train to demonstrate compliance with the PM standards of this subpart. This shall not preclude the permitting authority from requiring a determination of the “back half” for other purposes.

(F) For PM performance test reports used to set a PM CPMS operating limit, the electronic submission of the test report must also include the make and model of the PM CPMS instrument, serial number of the instrument, analytical principle of the instrument (*e.g.* beta attenuation), span of the instruments primary analytical range, milliamp value equivalent to the instrument zero output, technique by which this zero value was determined, and the average milliamp signals corresponding to each PM compliance test run.

(iii) For a particulate wet scrubber, you must establish the minimum pressure drop and liquid flow rate as defined in §63.7575, as your operating limits during the three-run performance test during which you demonstrate compliance with your applicable limit. If you use a wet scrubber and you conduct separate performance tests for PM and TSM emissions, you must establish one set of minimum scrubber liquid flow rate and pressure drop operating limits. The minimum scrubber effluent pH operating limit must be established during the HCl performance test. If you conduct multiple performance tests, you must set the minimum liquid flow rate and pressure drop operating limits at the higher of the minimum values established during the performance tests.

(iv) For an electrostatic precipitator (ESP) operated with a wet scrubber, you must establish the minimum total secondary electric power input, as defined in §63.7575, as your operating limit during the three-run performance test during which you demonstrate compliance with your applicable limit. (These operating limits do not apply to ESP that are operated as dry controls without a wet scrubber.)

(v) For a dry scrubber, you must establish the minimum sorbent injection rate for each sorbent, as defined in §63.7575, as your operating limit during the three-run performance test during which you demonstrate compliance with your applicable limit.

(vi) For activated carbon injection, you must establish the minimum activated carbon injection rate, as defined in §63.7575, as your operating limit during the three-run performance test during which you demonstrate compliance with your applicable limit.

(vii) The operating limit for boilers or process heaters with fabric filters that demonstrate continuous compliance through bag leak detection systems is that a bag leak detection system be installed according to the requirements in §63.7525, and that each fabric filter must be operated such that the bag leak detection system alert is not activated more than 5 percent of the operating time during a 6-month period.

(viii) For a minimum oxygen level, if you conduct multiple performance tests, you must set the minimum oxygen level at the lower of the minimum values established during the performance tests.

(ix) The operating limit for boilers or process heaters that demonstrate continuous compliance with the HCl emission limit using a SO<sub>2</sub> CEMS is to install and operate the SO<sub>2</sub> according to the requirements in §63.7525(m) establish a maximum SO<sub>2</sub> emission rate equal to the highest hourly average SO<sub>2</sub> measurement during the most recent three-run performance test for HCl.

(c) If you elect to demonstrate compliance with an applicable emission limit through fuel analysis, you must conduct fuel analyses according to §63.7521 and follow the procedures in paragraphs (c)(1) through (5) of this section.

(1) If you burn more than one fuel type, you must determine the fuel mixture you could burn in your boiler or process heater that would result in the maximum emission rates of the pollutants that you elect to demonstrate compliance through fuel analysis.

(2) You must determine the 90th percentile confidence level fuel pollutant concentration of the composite samples analyzed for each fuel type using the one-sided t-statistic test described in Equation 15 of this section.

$$P90 = \text{mean} + (SD \times t) \quad (\text{Eq. 15})$$

[View or download PDF](#)

Where:

P90 = 90th percentile confidence level pollutant concentration, in pounds per million Btu.

Mean = Arithmetic average of the fuel pollutant concentration in the fuel samples analyzed according to §63.7521, in units of pounds per million Btu.

SD = Standard deviation of the mean of pollutant concentration in the fuel samples analyzed according to §63.7521, in units of pounds per million Btu. SD is calculated as the sample standard deviation divided by the square root of the number of samples.

t = t distribution critical value for 90th percentile ( $t_{0.1}$ ) probability for the appropriate degrees of freedom (number of samples minus one) as obtained from a t-Distribution Critical Value Table.

(3) To demonstrate compliance with the applicable emission limit for HCl, the HCl emission rate that you calculate for your boiler or process heater using Equation 16 of this section must not exceed the applicable emission limit for HCl.

$$HCl = \sum_{i=1}^n (Ci90 \times Qi \times 1.028) \quad (\text{Eq. 16})$$

[View or download PDF](#)

Where:

HCl = HCl emission rate from the boiler or process heater in units of pounds per million Btu.

Ci90 = 90th percentile confidence level concentration of chlorine in fuel type, i, in units of pounds per million Btu as calculated according to Equation 15 of this section.

Qi = Fraction of total heat input from fuel type, i, based on the fuel mixture that has the highest content of chlorine. If you do not burn multiple fuel types, it is not necessary to determine the value of this term. Insert a value of “1” for Qi. For continuous compliance demonstration, the actual fraction of the fuel burned during the month should be used.

n = Number of different fuel types burned in your boiler or process heater for the mixture that has the highest content of chlorine.

1.028 = Molecular weight ratio of HCl to chlorine.

(4) To demonstrate compliance with the applicable emission limit for mercury, the mercury emission rate that you calculate for your boiler or process heater using Equation 17 of this section must not exceed the applicable emission limit for mercury.

$$\text{Mercury} = \sum_{i=1}^n (Hgi90 \times Qi) \quad (\text{Eq. 17})$$

[View or download PDF](#)

Where:

Mercury = Mercury emission rate from the boiler or process heater in units of pounds per million Btu.

Hgi90 = 90th percentile confidence level concentration of mercury in fuel, i, in units of pounds per million Btu as calculated according to Equation 15 of this section.

$Q_i$  = Fraction of total heat input from fuel type,  $i$ , based on the fuel mixture that has the highest mercury content. If you do not burn multiple fuel types, it is not necessary to determine the value of this term. Insert a value of “1” for  $Q_i$ . For continuous compliance demonstration, the actual fraction of the fuel burned during the month should be used.

$n$  = Number of different fuel types burned in your boiler or process heater for the mixture that has the highest mercury content.

(5) To demonstrate compliance with the applicable emission limit for TSM for solid or liquid fuels, the TSM emission rate that you calculate for your boiler or process heater from solid fuels using Equation 18 of this section must not exceed the applicable emission limit for TSM.

$$\text{Metals} = \sum_{i=1}^n (TSM_{90i} \times Q_i) \quad (\text{Eq. 18})$$

[View or download PDF](#)

Where:

Metals = TSM emission rate from the boiler or process heater in units of pounds per million Btu.

$TSM_{i90}$  = 90th percentile confidence level concentration of TSM in fuel,  $i$ , in units of pounds per million Btu as calculated according to Equation 15 of this section.

$Q_i$  = Fraction of total heat input from fuel type,  $i$ , based on the fuel mixture that has the highest TSM content. If you do not burn multiple fuel types, it is not necessary to determine the value of this term. Insert a value of “1” for  $Q_i$ . For continuous compliance demonstration, the actual fraction of the fuel burned during the month should be used.

$n$  = Number of different fuel types burned in your boiler or process heater for the mixture that has the highest TSM content.

(d)[Reserved]

(e) You must include with the Notification of Compliance Status a signed certification that either the energy assessment was completed according to Table 3 to this subpart, and that the assessment is an accurate depiction of your facility at the time of the assessment, or that the maximum number of on-site technical hours specified in the definition of energy assessment applicable to the facility has been expended.

(f) You must submit the Notification of Compliance Status containing the results of the initial compliance demonstration according to the requirements in §63.7545(e).

(g) If you elect to demonstrate that a gaseous fuel meets the specifications of another gas 1 fuel as defined in §63.7575, you must conduct an initial fuel specification analyses according to §63.7521(f) through (i) and according to the frequency listed in §63.7540(c) and maintain records of the results of the testing as outlined in §63.7555(g). For samples where the initial mercury specification has not been exceeded, you

will include a signed certification with the Notification of Compliance Status that the initial fuel specification test meets the gas specification outlined in the definition of other gas 1 fuels.

(h) If you own or operate a unit subject to emission limits in Tables 1 or 2 or 11 through 13 to this subpart, you must meet the work practice standard according to Table 3 of this subpart. During startup and shutdown, you must only follow the work practice standards according to items 5 and 6 of Table 3 of this subpart.

(i) If you opt to comply with the alternative SO<sub>2</sub> CEMS operating limit in Tables 4 and 8 to this subpart, you may do so only if your affected boiler or process heater:

(1) Has a system using wet scrubber or dry sorbent injection and SO<sub>2</sub> CEMS installed on the unit; and

(2) At all times, you operate the wet scrubber or dry sorbent injection for acid gas control on the unit consistent with §63.7500(a)(3); and

(3) You establish a unit-specific maximum SO<sub>2</sub> operating limit by collecting the maximum hourly SO<sub>2</sub> emission rate on the SO<sub>2</sub> CEMS during the paired 3-run test for HCl. The maximum SO<sub>2</sub> operating limit is equal to the highest hourly average SO<sub>2</sub> concentration measured during the HCl performance test.

[76 FR 15664, Mar. 21, 2011, as amended at 78 FR 7174, Jan. 31, 2013; 80 FR 72811, Nov. 20, 2015]

[↑ Back to Top](#)

### **§63.7533 Can I use efficiency credits earned from implementation of energy conservation measures to comply with this subpart?**

(a) If you elect to comply with the alternative equivalent output-based emission limits, instead of the heat input-based limits listed in Table 2 to this subpart, and you want to take credit for implementing energy conservation measures identified in an energy assessment, you may demonstrate compliance using efficiency credits according to the procedures in this section. You may use this compliance approach for an existing affected boiler for demonstrating initial compliance according to §63.7522(e) and for demonstrating monthly compliance according to §63.7522(f). Owners or operators using this compliance approach must establish an emissions benchmark, calculate and document the efficiency credits, develop an Implementation Plan, comply with the general reporting requirements, and apply the efficiency credit according to the procedures in paragraphs (b) through (f) of this section. You cannot use this compliance approach for a new or reconstructed affected boiler. Additional guidance from the Department of Energy on efficiency credits is available at: <http://www.epa.gov/ttn/atw/boiler/boilerpg.html>.

(b) For each existing affected boiler for which you intend to apply emissions credits, establish a benchmark from which emission reduction credits may be generated by determining the actual annual fuel heat input to the affected boiler before initiation of an energy conservation activity to reduce energy demand (*i.e.*, fuel usage) according to paragraphs (b)(1) through (4) of this section. The benchmark shall be expressed in trillion Btu per year heat input.

(1) The benchmark from which efficiency credits may be generated shall be determined by using the most representative, accurate, and reliable process available for the source. The benchmark shall be established



for a one-year period before the date that an energy demand reduction occurs, unless it can be demonstrated that a different time period is more representative of historical operations.

(2) Determine the starting point from which to measure progress. Inventory all fuel purchased and generated on-site (off-gases, residues) in physical units (MMBtu, million cubic feet, etc.).

(3) Document all uses of energy from the affected boiler. Use the most recent data available.

(4) Collect non-energy related facility and operational data to normalize, if necessary, the benchmark to current operations, such as building size, operating hours, etc. If possible, use actual data that are current and timely rather than estimated data.

(c) Efficiency credits can be generated if the energy conservation measures were implemented after January 1, 2008 and if sufficient information is available to determine the appropriate value of credits.

(1) The following emission points cannot be used to generate efficiency credits:

(i) Energy conservation measures implemented on or before January 1, 2008, unless the level of energy demand reduction is increased after January 1, 2008, in which case credit will be allowed only for change in demand reduction achieved after January 1, 2008.

(ii) Efficiency credits on shut-down boilers. Boilers that are shut down cannot be used to generate credits unless the facility provides documentation linking the permanent shutdown to energy conservation measures identified in the energy assessment. In this case, the bench established for the affected boiler to which the credits from the shutdown will be applied must be revised to include the benchmark established for the shutdown boiler.

(2) For all points included in calculating emissions credits, the owner or operator shall:

(i) Calculate annual credits for all energy demand points. Use Equation 19 to calculate credits. Energy conservation measures that meet the criteria of paragraph (c)(1) of this section shall not be included, except as specified in paragraph (c)(1)(i) of this section.

(3) Credits are generated by the difference between the benchmark that is established for each affected boiler, and the actual energy demand reductions from energy conservation measures implemented after January 1, 2008. Credits shall be calculated using Equation 19 of this section as follows:

(i) The overall equation for calculating credits is:

$$ECredits = \left( \sum_{i=1}^n EIS_{actual} \right) + EI_{baseline} \quad (\text{Eq. 19})$$

[View or download PDF](#)

Where:

ECredits = Energy Input Savings for all energy conservation measures implemented for an affected boiler, expressed as a decimal fraction of the baseline energy input.

$EIS_{\text{actual}}$  = Energy Input Savings for each energy conservation measure, i, implemented for an affected boiler, million Btu per year.

$EI_{\text{baseline}}$  = Energy Input baseline for the affected boiler, million Btu per year.

n = Number of energy conservation measures included in the efficiency credit for the affected boiler.

(ii) [Reserved]

(d) The owner or operator shall develop, and submit for approval upon request by the Administrator, an Implementation Plan containing all of the information required in this paragraph for all boilers to be included in an efficiency credit approach. The Implementation Plan shall identify all existing affected boilers to be included in applying the efficiency credits. The Implementation Plan shall include a description of the energy conservation measures implemented and the energy savings generated from each measure and an explanation of the criteria used for determining that savings. If requested, you must submit the implementation plan for efficiency credits to the Administrator for review and approval no later than 180 days before the date on which the facility intends to demonstrate compliance using the efficiency credit approach.

(e) The emissions rate as calculated using Equation 20 of this section from each existing boiler participating in the efficiency credit option must be in compliance with the limits in Table 2 to this subpart at all times the affected unit is subject to numeric emission limits, following the compliance date specified in §63.7495.

(f) You must use Equation 20 of this section to demonstrate initial compliance by demonstrating that the emissions from the affected boiler participating in the efficiency credit compliance approach do not exceed the emission limits in Table 2 to this subpart.

$$E_{\text{adj}} = E_m \times (1 - ECredits) \quad (\text{Eq. 20})$$

[View or download PDF](#)

Where:

$E_{\text{adj}}$  = Emission level adjusted by applying the efficiency credits earned, lb per million Btu steam output (or lb per MWh) for the affected boiler.

$E_m$  = Emissions measured during the performance test, lb per million Btu steam output (or lb per MWh) for the affected boiler.

ECredits = Efficiency credits from Equation 19 for the affected boiler.

(g) As part of each compliance report submitted as required under §63.7550, you must include documentation that the energy conservation measures implemented continue to generate the credit for use in demonstrating compliance with the emission limits.

[76 FR 15664, Mar. 21, 2011, as amended at 78 FR 7178, Jan. 31, 2013; 80 FR 72812, Nov. 20, 2015]

[↑ Back to Top](#)

## Continuous Compliance Requirements

[↑ Back to Top](#)

### **§63.7535 Is there a minimum amount of monitoring data I must obtain?**

(a) You must monitor and collect data according to this section and the site-specific monitoring plan required by §63.7505(d).

(b) You must operate the monitoring system and collect data at all required intervals at all times that each boiler or process heater is operating and compliance is required, except for periods of monitoring system malfunctions or out of control periods (see §63.8(c)(7) of this part), and required monitoring system quality assurance or control activities, including, as applicable, calibration checks, required zero and span adjustments, and scheduled CMS maintenance as defined in your site-specific monitoring plan. A monitoring system malfunction is any sudden, infrequent, not reasonably preventable failure of the monitoring system to provide valid data. Monitoring system failures that are caused in part by poor maintenance or careless operation are not malfunctions. You are required to complete monitoring system repairs in response to monitoring system malfunctions or out-of-control periods and to return the monitoring system to operation as expeditiously as practicable.

(c) You may not use data recorded during periods of startup and shutdown, monitoring system malfunctions or out-of-control periods, repairs associated with monitoring system malfunctions or out-of-control periods, or required monitoring system quality assurance or control activities in data averages and calculations used to report emissions or operating levels. You must record and make available upon request results of CMS performance audits and dates and duration of periods when the CMS is out of control to completion of the corrective actions necessary to return the CMS to operation consistent with your site-specific monitoring plan. You must use all the data collected during all other periods in assessing compliance and the operation of the control device and associated control system.

(d) Except for periods of monitoring system malfunctions, repairs associated with monitoring system malfunctions, and required monitoring system quality assurance or quality control activities (including, as applicable, system accuracy audits, calibration checks, and required zero and span adjustments), failure to collect required data is a deviation of the monitoring requirements. In calculating monitoring results, do not use any data collected during periods of startup and shutdown, when the monitoring system is out of control as specified in your site-specific monitoring plan, while conducting repairs associated with periods when the monitoring system is out of control, or while conducting required monitoring system quality assurance or quality control activities. You must calculate monitoring results using all other monitoring data collected while the process is operating. You must report all periods when the monitoring system is out of control in your semi-annual report.

[76 FR 15664, Mar. 21, 2011, as amended at 78 FR 7179, Jan. 31, 2013; 80 FR 72812, Nov. 20, 2015]

[↑ Back to Top](#)

### **§63.7540 How do I demonstrate continuous compliance with the emission limitations, fuel specifications and work practice standards?**

(a) You must demonstrate continuous compliance with each emission limit in Tables 1 and 2 or 11 through 13 to this subpart, the work practice standards in Table 3 to this subpart, and the operating limits in Table 4 to this subpart that applies to you according to the methods specified in Table 8 to this subpart and paragraphs (a)(1) through (19) of this section.

(1) Following the date on which the initial compliance demonstration is completed or is required to be completed under §§63.7 and 63.7510, whichever date comes first, operation above the established maximum or below the established minimum operating limits shall constitute a deviation of established operating limits listed in Table 4 of this subpart except during performance tests conducted to determine compliance with the emission limits or to establish new operating limits. Operating limits must be confirmed or reestablished during performance tests.

(2) As specified in §63.7555(d), you must keep records of the type and amount of all fuels burned in each boiler or process heater during the reporting period to demonstrate that all fuel types and mixtures of fuels burned would result in either of the following:

(i) Equal to or lower emissions of HCl, mercury, and TSM than the applicable emission limit for each pollutant, if you demonstrate compliance through fuel analysis.

(ii) Equal to or lower fuel input of chlorine, mercury, and TSM than the maximum values calculated during the last performance test, if you demonstrate compliance through performance testing.

(3) If you demonstrate compliance with an applicable HCl emission limit through fuel analysis for a solid or liquid fuel and you plan to burn a new type of solid or liquid fuel, you must recalculate the HCl emission rate using Equation 16 of §63.7530 according to paragraphs (a)(3)(i) through (iii) of this section. You are not required to conduct fuel analyses for the fuels described in §63.7510(a)(2)(i) through (iii). You may exclude the fuels described in §63.7510(a)(2)(i) through (iii) when recalculating the HCl emission rate.

(i) You must determine the chlorine concentration for any new fuel type in units of pounds per million Btu, based on supplier data or your own fuel analysis, according to the provisions in your site-specific fuel analysis plan developed according to §63.7521(b).

(ii) You must determine the new mixture of fuels that will have the highest content of chlorine.

(iii) Recalculate the HCl emission rate from your boiler or process heater under these new conditions using Equation 16 of §63.7530. The recalculated HCl emission rate must be less than the applicable emission limit.

(4) If you demonstrate compliance with an applicable HCl emission limit through performance testing and you plan to burn a new type of fuel or a new mixture of fuels, you must recalculate the maximum chlorine input using Equation 7 of §63.7530. If the results of recalculating the maximum chlorine input using Equation 7 of §63.7530 are greater than the maximum chlorine input level established during the previous performance test, then you must conduct a new performance test within 60 days of burning the new fuel type or fuel mixture according to the procedures in §63.7520 to demonstrate that the HCl emissions do not exceed the emission limit. You must also establish new operating limits based on this performance test according to the procedures in §63.7530(b). In recalculating the maximum chlorine input and

establishing the new operating limits, you are not required to conduct fuel analyses for and include the fuels described in §63.7510(a)(2)(i) through (iii).

(5) If you demonstrate compliance with an applicable mercury emission limit through fuel analysis, and you plan to burn a new type of fuel, you must recalculate the mercury emission rate using Equation 17 of §63.7530 according to the procedures specified in paragraphs (a)(5)(i) through (iii) of this section. You are not required to conduct fuel analyses for the fuels described in §63.7510(a)(2)(i) through (iii). You may exclude the fuels described in §63.7510(a)(2)(i) through (iii) when recalculating the mercury emission rate.

(i) You must determine the mercury concentration for any new fuel type in units of pounds per million Btu, based on supplier data or your own fuel analysis, according to the provisions in your site-specific fuel analysis plan developed according to §63.7521(b).

(ii) You must determine the new mixture of fuels that will have the highest content of mercury.

(iii) Recalculate the mercury emission rate from your boiler or process heater under these new conditions using Equation 17 of §63.7530. The recalculated mercury emission rate must be less than the applicable emission limit.

(6) If you demonstrate compliance with an applicable mercury emission limit through performance testing, and you plan to burn a new type of fuel or a new mixture of fuels, you must recalculate the maximum mercury input using Equation 8 of §63.7530. If the results of recalculating the maximum mercury input using Equation 8 of §63.7530 are higher than the maximum mercury input level established during the previous performance test, then you must conduct a new performance test within 60 days of burning the new fuel type or fuel mixture according to the procedures in §63.7520 to demonstrate that the mercury emissions do not exceed the emission limit. You must also establish new operating limits based on this performance test according to the procedures in §63.7530(b). You are not required to conduct fuel analyses for the fuels described in §63.7510(a)(2)(i) through (iii). You may exclude the fuels described in §63.7510(a)(2)(i) through (iii) when recalculating the mercury emission rate.

(7) If your unit is controlled with a fabric filter, and you demonstrate continuous compliance using a bag leak detection system, you must initiate corrective action within 1 hour of a bag leak detection system alert and complete corrective actions as soon as practical, and operate and maintain the fabric filter system such that the periods which would cause an alert are no more than 5 percent of the operating time during a 6-month period. You must also keep records of the date, time, and duration of each alert, the time corrective action was initiated and completed, and a brief description of the cause of the alert and the corrective action taken. You must also record the percent of the operating time during each 6-month period that the conditions exist for an alert. In calculating this operating time percentage, if inspection of the fabric filter demonstrates that no corrective action is required, no alert time is counted. If corrective action is required, each alert shall be counted as a minimum of 1 hour. If you take longer than 1 hour to initiate corrective action, the alert time shall be counted as the actual amount of time taken to initiate corrective action.

(8) To demonstrate compliance with the applicable alternative CO CEMS emission limit listed in Tables 1, 2, or 11 through 13 to this subpart, you must meet the requirements in paragraphs (a)(8)(i) through (iv) of this section.

(i) Continuously monitor CO according to §§63.7525(a) and 63.7535.

(ii) Maintain a CO emission level below or at your applicable alternative CO CEMS-based standard in Tables 1 or 2 or 11 through 13 to this subpart at all times the affected unit is subject to numeric emission limits.

(iii) Keep records of CO levels according to §63.7555(b).

(iv) You must record and make available upon request results of CO CEMS performance audits, dates and duration of periods when the CO CEMS is out of control to completion of the corrective actions necessary to return the CO CEMS to operation consistent with your site-specific monitoring plan.

(9) The owner or operator of a boiler or process heater using a PM CPMS or a PM CEMS to meet requirements of this subpart shall install, certify, operate, and maintain the PM CPMS or PM CEMS in accordance with your site-specific monitoring plan as required in §63.7505(d).

(10) If your boiler or process heater has a heat input capacity of 10 million Btu per hour or greater, you must conduct an annual tune-up of the boiler or process heater to demonstrate continuous compliance as specified in paragraphs (a)(10)(i) through (vi) of this section. You must conduct the tune-up while burning the type of fuel (or fuels in case of units that routinely burn a mixture) that provided the majority of the heat input to the boiler or process heater over the 12 months prior to the tune-up. This frequency does not apply to limited-use boilers and process heaters, as defined in §63.7575, or units with continuous oxygen trim systems that maintain an optimum air to fuel ratio.

(i) As applicable, inspect the burner, and clean or replace any components of the burner as necessary (you may perform the burner inspection any time prior to the tune-up or delay the burner inspection until the next scheduled unit shutdown). Units that produce electricity for sale may delay the burner inspection until the first outage, not to exceed 36 months from the previous inspection. At units where entry into a piece of process equipment or into a storage vessel is required to complete the tune-up inspections, inspections are required only during planned entries into the storage vessel or process equipment;

(ii) Inspect the flame pattern, as applicable, and adjust the burner as necessary to optimize the flame pattern. The adjustment should be consistent with the manufacturer's specifications, if available;

(iii) Inspect the system controlling the air-to-fuel ratio, as applicable, and ensure that it is correctly calibrated and functioning properly (you may delay the inspection until the next scheduled unit shutdown). Units that produce electricity for sale may delay the inspection until the first outage, not to exceed 36 months from the previous inspection;

(iv) Optimize total emissions of CO. This optimization should be consistent with the manufacturer's specifications, if available, and with any NO<sub>x</sub> requirement to which the unit is subject;

(v) Measure the concentrations in the effluent stream of CO in parts per million, by volume, and oxygen in volume percent, before and after the adjustments are made (measurements may be either on a dry or

wet basis, as long as it is the same basis before and after the adjustments are made). Measurements may be taken using a portable CO analyzer; and

(vi) Maintain on-site and submit, if requested by the Administrator, a report containing the information in paragraphs (a)(10)(vi)(A) through (C) of this section,

(A) The concentrations of CO in the effluent stream in parts per million by volume, and oxygen in volume percent, measured at high fire or typical operating load, before and after the tune-up of the boiler or process heater;

(B) A description of any corrective actions taken as a part of the tune-up; and

(C) The type and amount of fuel used over the 12 months prior to the tune-up, but only if the unit was physically and legally capable of using more than one type of fuel during that period. Units sharing a fuel meter may estimate the fuel used by each unit.

(11) If your boiler or process heater has a heat input capacity of less than 10 million Btu per hour (except as specified in paragraph (a)(12) of this section), you must conduct a biennial tune-up of the boiler or process heater as specified in paragraphs (a)(10)(i) through (vi) of this section to demonstrate continuous compliance.

(12) If your boiler or process heater has a continuous oxygen trim system that maintains an optimum air to fuel ratio, or a heat input capacity of less than or equal to 5 million Btu per hour and the unit is in the units designed to burn gas 1; units designed to burn gas 2 (other); or units designed to burn light liquid subcategories, or meets the definition of limited-use boiler or process heater in §63.7575, you must conduct a tune-up of the boiler or process heater every 5 years as specified in paragraphs (a)(10)(i) through (vi) of this section to demonstrate continuous compliance. You may delay the burner inspection specified in paragraph (a)(10)(i) of this section until the next scheduled or unscheduled unit shutdown, but you must inspect each burner at least once every 72 months. If an oxygen trim system is utilized on a unit without emission standards to reduce the tune-up frequency to once every 5 years, set the oxygen level no lower than the oxygen concentration measured during the most recent tune-up.

(13) If the unit is not operating on the required date for a tune-up, the tune-up must be conducted within 30 calendar days of startup.

(14) If you are using a CEMS measuring mercury emissions to meet requirements of this subpart you must install, certify, operate, and maintain the mercury CEMS as specified in paragraphs (a)(14)(i) and (ii) of this section.

(i) Operate the mercury CEMS in accordance with performance specification 12A of 40 CFR part 60, appendix B or operate a sorbent trap based integrated monitor in accordance with performance specification 12B of 40 CFR part 60, appendix B. The duration of the performance test must be 30 operating days if you specified a 30 operating day basis in §63.7545(e)(2)(iii) for mercury CEMS or it must be 720 hours if you specified a 720 hour basis in §63.7545(e)(2)(iii) for mercury CEMS. For each day in which the unit operates, you must obtain hourly mercury concentration data, and stack gas volumetric flow rate data.

(ii) If you are using a mercury CEMS, you must install, operate, calibrate, and maintain an instrument for continuously measuring and recording the mercury mass emissions rate to the atmosphere according to the requirements of performance specifications 6 and 12A of 40 CFR part 60, appendix B, and quality assurance procedure 6 of 40 CFR part 60, appendix F.

(15) If you are using a CEMS to measure HCl emissions to meet requirements of this subpart, you must install, certify, operate, and maintain the HCl CEMS as specified in paragraphs (a)(15)(i) and (ii) of this section. This option for an affected unit takes effect on the date a final performance specification for an HCl CEMS is published in the Federal Register or the date of approval of a site-specific monitoring plan.

(i) Operate the continuous emissions monitoring system in accordance with the applicable performance specification in 40 CFR part 60, appendix B. The duration of the performance test must be 30 operating days if you specified a 30 operating day basis in §63.7545(e)(2)(iii) for HCl CEMS or it must be 720 hours if you specified a 720 hour basis in §63.7545(e)(2)(iii) for HCl CEMS. For each day in which the unit operates, you must obtain hourly HCl concentration data, and stack gas volumetric flow rate data.

(ii) If you are using a HCl CEMS, you must install, operate, calibrate, and maintain an instrument for continuously measuring and recording the HCl mass emissions rate to the atmosphere according to the requirements of the applicable performance specification of 40 CFR part 60, appendix B, and the quality assurance procedures of 40 CFR part 60, appendix F.

(16) If you demonstrate compliance with an applicable TSM emission limit through performance testing, and you plan to burn a new type of fuel or a new mixture of fuels, you must recalculate the maximum TSM input using Equation 9 of §63.7530. If the results of recalculating the maximum TSM input using Equation 9 of §63.7530 are higher than the maximum total selected input level established during the previous performance test, then you must conduct a new performance test within 60 days of burning the new fuel type or fuel mixture according to the procedures in §63.7520 to demonstrate that the TSM emissions do not exceed the emission limit. You must also establish new operating limits based on this performance test according to the procedures in §63.7530(b). You are not required to conduct fuel analyses for the fuels described in §63.7510(a)(2)(i) through (iii). You may exclude the fuels described in §63.7510(a)(2)(i) through (iii) when recalculating the TSM emission rate.

(17) If you demonstrate compliance with an applicable TSM emission limit through fuel analysis for solid or liquid fuels, and you plan to burn a new type of fuel, you must recalculate the TSM emission rate using Equation 18 of §63.7530 according to the procedures specified in paragraphs (a)(5)(i) through (iii) of this section. You are not required to conduct fuel analyses for the fuels described in §63.7510(a)(2)(i) through (iii). You may exclude the fuels described in §63.7510(a)(2)(i) through (iii) when recalculating the TSM emission rate.

(i) You must determine the TSM concentration for any new fuel type in units of pounds per million Btu, based on supplier data or your own fuel analysis, according to the provisions in your site-specific fuel analysis plan developed according to §63.7521(b).

(ii) You must determine the new mixture of fuels that will have the highest content of TSM.



(iii) Recalculate the TSM emission rate from your boiler or process heater under these new conditions using Equation 18 of §63.7530. The recalculated TSM emission rate must be less than the applicable emission limit.

(18) If you demonstrate continuous PM emissions compliance with a PM CPMS you will use a PM CPMS to establish a site-specific operating limit corresponding to the results of the performance test demonstrating compliance with the PM limit. You will conduct your performance test using the test method criteria in Table 5 of this subpart. You will use the PM CPMS to demonstrate continuous compliance with this operating limit. You must repeat the performance test annually and reassess and adjust the site-specific operating limit in accordance with the results of the performance test.

(i) To determine continuous compliance, you must record the PM CPMS output data for all periods when the process is operating and the PM CPMS is not out-of-control. You must demonstrate continuous compliance by using all quality-assured hourly average data collected by the PM CPMS for all operating hours to calculate the arithmetic average operating parameter in units of the operating limit (milliamperes) on a 30-day rolling average basis.

(ii) For any deviation of the 30-day rolling PM CPMS average value from the established operating parameter limit, you must:

(A) Within 48 hours of the deviation, visually inspect the air pollution control device (APCD);

(B) If inspection of the APCD identifies the cause of the deviation, take corrective action as soon as possible and return the PM CPMS measurement to within the established value; and

(C) Within 30 days of the deviation or at the time of the annual compliance test, whichever comes first, conduct a PM emissions compliance test to determine compliance with the PM emissions limit and to verify or re-establish the CPMS operating limit. You are not required to conduct additional testing for any deviations that occur between the time of the original deviation and the PM emissions compliance test required under this paragraph.

(iii) PM CPMS deviations from the operating limit leading to more than four required performance tests in a 12-month operating period constitute a separate violation of this subpart.

(19) If you choose to comply with the PM filterable emissions limit by using PM CEMS you must install, certify, operate, and maintain a PM CEMS and record the output of the PM CEMS as specified in paragraphs (a)(19)(i) through (vii) of this section. The compliance limit will be expressed as a 30-day rolling average of the numerical emissions limit value applicable for your unit in Tables 1 or 2 or 11 through 13 of this subpart.

(i) Install and certify your PM CEMS according to the procedures and requirements in Performance Specification 11—Specifications and Test Procedures for Particulate Matter Continuous Emission Monitoring Systems at Stationary Sources in Appendix B to part 60 of this chapter, using test criteria outlined in Table V of this rule. The reportable measurement output from the PM CEMS must be expressed in units of the applicable emissions limit (e.g., lb/MMBtu, lb/MWh).

(ii) Operate and maintain your PM CEMS according to the procedures and requirements in Procedure 2—Quality Assurance Requirements for Particulate Matter Continuous Emission Monitoring Systems at Stationary Sources in Appendix F to part 60 of this chapter.

(A) You must conduct the relative response audit (RRA) for your PM CEMS at least once annually.

(B) You must conduct the relative correlation audit (RCA) for your PM CEMS at least once every 3 years.

(iii) Collect PM CEMS hourly average output data for all boiler operating hours except as indicated in paragraph (v) of this section.

(iv) Calculate the arithmetic 30-day rolling average of all of the hourly average PM CEMS output data collected during all nonexempt boiler or process heater operating hours.

(v) You must collect data using the PM CEMS at all times the unit is operating and at the intervals specified this paragraph (a), except for periods of monitoring system malfunctions, repairs associated with monitoring system malfunctions, and required monitoring system quality assurance or quality control activities.

(vi) You must use all the data collected during all boiler or process heater operating hours in assessing the compliance with your operating limit except:

(A) Any data collected during monitoring system malfunctions, repairs associated with monitoring system malfunctions, or required monitoring system quality assurance or control activities conducted during monitoring system malfunctions in calculations and report any such periods in your annual deviation report;

(B) Any data collected during periods when the monitoring system is out of control as specified in your site-specific monitoring plan, repairs associated with periods when the monitoring system is out of control, or required monitoring system quality assurance or control activities conducted during out of control periods in calculations used to report emissions or operating levels and report any such periods in your annual deviation report;

(C) Any data recorded during periods of startup or shutdown.

(vii) You must record and make available upon request results of PM CEMS system performance audits, dates and duration of periods when the PM CEMS is out of control to completion of the corrective actions necessary to return the PM CEMS to operation consistent with your site-specific monitoring plan.

(b) You must report each instance in which you did not meet each emission limit and operating limit in Tables 1 through 4 or 11 through 13 to this subpart that apply to you. These instances are deviations from the emission limits or operating limits, respectively, in this subpart. These deviations must be reported according to the requirements in §63.7550.

(c) If you elected to demonstrate that the unit meets the specification for mercury for the unit designed to burn gas 1 subcategory, you must follow the sampling frequency specified in paragraphs (c)(1) through (4) of this section and conduct this sampling according to the procedures in §63.7521(f) through (i).

(1) If the initial mercury constituents in the gaseous fuels are measured to be equal to or less than half of the mercury specification as defined in §63.7575, you do not need to conduct further sampling.

(2) If the initial mercury constituents are greater than half but equal to or less than 75 percent of the mercury specification as defined in §63.7575, you will conduct semi-annual sampling. If 6 consecutive semi-annual fuel analyses demonstrate 50 percent or less of the mercury specification, you do not need to conduct further sampling. If any semi-annual sample exceeds 75 percent of the mercury specification, you must return to monthly sampling for that fuel, until 12 months of fuel analyses again are less than 75 percent of the compliance level.

(3) If the initial mercury constituents are greater than 75 percent of the mercury specification as defined in §63.7575, you will conduct monthly sampling. If 12 consecutive monthly fuel analyses demonstrate 75 percent or less of the mercury specification, you may decrease the fuel analysis frequency to semi-annual for that fuel.

(4) If the initial sample exceeds the mercury specification as defined in §63.7575, each affected boiler or process heater combusting this fuel is not part of the unit designed to burn gas 1 subcategory and must be in compliance with the emission and operating limits for the appropriate subcategory. You may elect to conduct additional monthly sampling while complying with these emissions and operating limits to demonstrate that the fuel qualifies as another gas 1 fuel. If 12 consecutive monthly fuel analyses samples are at or below the mercury specification as defined in §63.7575, each affected boiler or process heater combusting the fuel can elect to switch back into the unit designed to burn gas 1 subcategory until the mercury specification is exceeded.

(d) For startup and shutdown, you must meet the work practice standards according to items 5 and 6 of Table 3 of this subpart.

[78 FR 7179, Jan. 31, 2013, as amended at 80 FR 72813, Nov. 20, 2015]

[↑ Back to Top](#)

#### **§63.7541 How do I demonstrate continuous compliance under the emissions averaging provision?**

(a) Following the compliance date, the owner or operator must demonstrate compliance with this subpart on a continuous basis by meeting the requirements of paragraphs (a)(1) through (5) of this section.

(1) For each calendar month, demonstrate compliance with the average weighted emissions limit for the existing units participating in the emissions averaging option as determined in §63.7522(f) and (g).

(2) You must maintain the applicable opacity limit according to paragraphs (a)(2)(i) and (ii) of this section.

(i) For each existing unit participating in the emissions averaging option that is equipped with a dry control system and not vented to a common stack, maintain opacity at or below the applicable limit.

(ii) For each group of units participating in the emissions averaging option where each unit in the group is equipped with a dry control system and vented to a common stack that does not receive emissions from non-affected units, maintain opacity at or below the applicable limit at the common stack.

(3) For each existing unit participating in the emissions averaging option that is equipped with a wet scrubber, maintain the 30-day rolling average parameter values at or above the operating limits established during the most recent performance test.

(4) For each existing unit participating in the emissions averaging option that has an approved alternative operating parameter, maintain the 30-day rolling average parameter values consistent with the approved monitoring plan.

(5) For each existing unit participating in the emissions averaging option venting to a common stack configuration containing affected units from other subcategories, maintain the appropriate operating limit for each unit as specified in Table 4 to this subpart that applies.

(b) Any instance where the owner or operator fails to comply with the continuous monitoring requirements in paragraphs (a)(1) through (5) of this section is a deviation.

[76 FR 15664, Mar. 21, 2011, as amended at 78 FR 7182, Jan. 31, 2013]

[↑ Back to Top](#)

## **Notification, Reports, and Records**

[↑ Back to Top](#)

### **§63.7545 What notifications must I submit and when?**

(a) You must submit to the Administrator all of the notifications in §§63.7(b) and (c), 63.8(e), (f)(4) and (6), and 63.9(b) through (h) that apply to you by the dates specified.

(b) As specified in §63.9(b)(2), if you startup your affected source before January 31, 2013, you must submit an Initial Notification not later than 120 days after January 31, 2013.

(c) As specified in §63.9(b)(4) and (5), if you startup your new or reconstructed affected source on or after January 31, 2013, you must submit an Initial Notification not later than 15 days after the actual date of startup of the affected source.

(d) If you are required to conduct a performance test you must submit a Notification of Intent to conduct a performance test at least 60 days before the performance test is scheduled to begin.

(e) If you are required to conduct an initial compliance demonstration as specified in §63.7530, you must submit a Notification of Compliance Status according to §63.9(h)(2)(ii). For the initial compliance demonstration for each boiler or process heater, you must submit the Notification of Compliance Status, including all performance test results and fuel analyses, before the close of business on the 60th day following the completion of all performance test and/or other initial compliance demonstrations for all boiler or process heaters at the facility according to §63.10(d)(2). The Notification of Compliance Status report must contain all the information specified in paragraphs (e)(1) through (8) of this section, as applicable. If you are not required to conduct an initial compliance demonstration as specified in §63.7530(a), the Notification of Compliance Status must only contain the information specified in

paragraphs (e)(1) and (8) of this section and must be submitted within 60 days of the compliance date specified at §63.7495(b).

(1) A description of the affected unit(s) including identification of which subcategories the unit is in, the design heat input capacity of the unit, a description of the add-on controls used on the unit to comply with this subpart, description of the fuel(s) burned, including whether the fuel(s) were a secondary material determined by you or the EPA through a petition process to be a non-waste under §241.3 of this chapter, whether the fuel(s) were a secondary material processed from discarded non-hazardous secondary materials within the meaning of §241.3 of this chapter, and justification for the selection of fuel(s) burned during the compliance demonstration.

(2) Summary of the results of all performance tests and fuel analyses, and calculations conducted to demonstrate initial compliance including all established operating limits, and including:

(i) Identification of whether you are complying with the PM emission limit or the alternative TSM emission limit.

(ii) Identification of whether you are complying with the output-based emission limits or the heat input-based (i.e., lb/MMBtu or ppm) emission limits,

(iii) Identification of whether you are complying the arithmetic mean of all valid hours of data from the previous 30 operating days or of the previous 720 hours. This identification shall be specified separately for each operating parameter.

(3) A summary of the maximum CO emission levels recorded during the performance test to show that you have met any applicable emission standard in Tables 1, 2, or 11 through 13 to this subpart, if you are not using a CO CEMS to demonstrate compliance.

(4) Identification of whether you plan to demonstrate compliance with each applicable emission limit through performance testing, a CEMS, or fuel analysis.

(5) Identification of whether you plan to demonstrate compliance by emissions averaging and identification of whether you plan to demonstrate compliance by using efficiency credits through energy conservation:

(i) If you plan to demonstrate compliance by emission averaging, report the emission level that was being achieved or the control technology employed on January 31, 2013.

(ii) [Reserved]

(6) A signed certification that you have met all applicable emission limits and work practice standards.

(7) If you had a deviation from any emission limit, work practice standard, or operating limit, you must also submit a description of the deviation, the duration of the deviation, and the corrective action taken in the Notification of Compliance Status report.

(8) In addition to the information required in §63.9(h)(2), your notification of compliance status must include the following certification(s) of compliance, as applicable, and signed by a responsible official:

(i) “This facility completed the required initial tune-up for all of the boilers and process heaters covered by 40 CFR part 63 subpart DDDDD at this site according to the procedures in §63.7540(a)(10)(i) through (vi).”

(ii) “This facility has had an energy assessment performed according to §63.7530(e).”

(iii) Except for units that burn only natural gas, refinery gas, or other gas 1 fuel, or units that qualify for a statutory exemption as provided in section 129(g)(1) of the Clean Air Act, include the following: “No secondary materials that are solid waste were combusted in any affected unit.”

(f) If you operate a unit designed to burn natural gas, refinery gas, or other gas 1 fuels that is subject to this subpart, and you intend to use a fuel other than natural gas, refinery gas, gaseous fuel subject to another subpart of this part, part 60, 61, or 65, or other gas 1 fuel to fire the affected unit during a period of natural gas curtailment or supply interruption, as defined in §63.7575, you must submit a notification of alternative fuel use within 48 hours of the declaration of each period of natural gas curtailment or supply interruption, as defined in §63.7575. The notification must include the information specified in paragraphs (f)(1) through (5) of this section.

(1) Company name and address.

(2) Identification of the affected unit.

(3) Reason you are unable to use natural gas or equivalent fuel, including the date when the natural gas curtailment was declared or the natural gas supply interruption began.

(4) Type of alternative fuel that you intend to use.

(5) Dates when the alternative fuel use is expected to begin and end.

(g) If you intend to commence or recommence combustion of solid waste, you must provide 30 days prior notice of the date upon which you will commence or recommence combustion of solid waste. The notification must identify:

(1) The name of the owner or operator of the affected source, as defined in §63.7490, the location of the source, the boiler(s) or process heater(s) that will commence burning solid waste, and the date of the notice.

(2) The currently applicable subcategories under this subpart.

(3) The date on which you became subject to the currently applicable emission limits.

(4) The date upon which you will commence combusting solid waste.

(h) If you have switched fuels or made a physical change to the boiler or process heater and the fuel switch or physical change resulted in the applicability of a different subcategory, you must provide notice of the date upon which you switched fuels or made the physical change within 30 days of the switch/change. The notification must identify:

(1) The name of the owner or operator of the affected source, as defined in §63.7490, the location of the source, the boiler(s) and process heater(s) that have switched fuels, were physically changed, and the date of the notice.

(2) The currently applicable subcategory under this subpart.

(3) The date upon which the fuel switch or physical change occurred.

[76 FR 15664, Mar. 21, 2011, as amended at 78 FR 7183, Jan. 31, 2013; 80 FR 72814, Nov. 20, 2015]

[↑ Back to Top](#)

### **§63.7550 What reports must I submit and when?**

(a) You must submit each report in Table 9 to this subpart that applies to you.

(b) Unless the EPA Administrator has approved a different schedule for submission of reports under §63.10(a), you must submit each report, according to paragraph (h) of this section, by the date in Table 9 to this subpart and according to the requirements in paragraphs (b)(1) through (4) of this section. For units that are subject only to a requirement to conduct subsequent annual, biennial, or 5-year tune-up according to §63.7540(a)(10), (11), or (12), respectively, and not subject to emission limits or Table 4 operating limits, you may submit only an annual, biennial, or 5-year compliance report, as applicable, as specified in paragraphs (b)(1) through (4) of this section, instead of a semi-annual compliance report.

(1) The first semi-annual compliance report must cover the period beginning on the compliance date that is specified for each boiler or process heater in §63.7495 and ending on June 30 or December 31, whichever date is the first date that occurs at least 180 days after the compliance date that is specified for your source in §63.7495. If submitting an annual, biennial, or 5-year compliance report, the first compliance report must cover the period beginning on the compliance date that is specified for each boiler or process heater in §63.7495 and ending on December 31 within 1, 2, or 5 years, as applicable, after the compliance date that is specified for your source in §63.7495.

(2) The first semi-annual compliance report must be postmarked or submitted no later than July 31 or January 31, whichever date is the first date following the end of the first calendar half after the compliance date that is specified for each boiler or process heater in §63.7495. The first annual, biennial, or 5-year compliance report must be postmarked or submitted no later than January 31.

(3) Each subsequent semi-annual compliance report must cover the semiannual reporting period from January 1 through June 30 or the semiannual reporting period from July 1 through December 31. Annual, biennial, and 5-year compliance reports must cover the applicable 1-, 2-, or 5-year periods from January 1 to December 31.

(4) Each subsequent semi-annual compliance report must be postmarked or submitted no later than July 31 or January 31, whichever date is the first date following the end of the semiannual reporting period. Annual, biennial, and 5-year compliance reports must be postmarked or submitted no later than January 31.

(5) For each affected source that is subject to permitting regulations pursuant to part 70 or part 71 of this chapter, and if the permitting authority has established dates for submitting semiannual reports pursuant to 70.6(a)(3)(iii)(A) or 71.6(a)(3)(iii)(A), you may submit the first and subsequent compliance reports according to the dates the permitting authority has established in the permit instead of according to the dates in paragraphs (b)(1) through (4) of this section.

(c) A compliance report must contain the following information depending on how the facility chooses to comply with the limits set in this rule.

(1) If the facility is subject to the requirements of a tune up you must submit a compliance report with the information in paragraphs (c)(5)(i) through (iii) of this section, (xiv) and (xvii) of this section, and paragraph (c)(5)(iv) of this section for limited-use boiler or process heater.

(2) If you are complying with the fuel analysis you must submit a compliance report with the information in paragraphs (c)(5)(i) through (iii), (vi), (x), (xi), (xiii), (xv), (xvii), (xviii) and paragraph (d) of this section.

(3) If you are complying with the applicable emissions limit with performance testing you must submit a compliance report with the information in (c)(5)(i) through (iii), (vi), (vii), (viii), (ix), (xi), (xiii), (xv), (xvii), (xviii) and paragraph (d) of this section.

(4) If you are complying with an emissions limit using a CMS the compliance report must contain the information required in paragraphs (c)(5)(i) through (iii), (v), (vi), (xi) through (xiii), (xv) through (xviii), and paragraph (e) of this section.

(5)(i) Company and Facility name and address.

(ii) Process unit information, emissions limitations, and operating parameter limitations.

(iii) Date of report and beginning and ending dates of the reporting period.

(iv) The total operating time during the reporting period.

(v) If you use a CMS, including CEMS, COMS, or CPMS, you must include the monitoring equipment manufacturer(s) and model numbers and the date of the last CMS certification or audit.

(vi) The total fuel use by each individual boiler or process heater subject to an emission limit within the reporting period, including, but not limited to, a description of the fuel, whether the fuel has received a non-waste determination by the EPA or your basis for concluding that the fuel is not a waste, and the total fuel usage amount with units of measure.

(vii) If you are conducting performance tests once every 3 years consistent with §63.7515(b) or (c), the date of the last 2 performance tests and a statement as to whether there have been any operational changes since the last performance test that could increase emissions.

(viii) A statement indicating that you burned no new types of fuel in an individual boiler or process heater subject to an emission limit. Or, if you did burn a new type of fuel and are subject to a HCl emission limit, you must submit the calculation of chlorine input, using Equation 7 of §63.7530, that demonstrates



that your source is still within its maximum chlorine input level established during the previous performance testing (for sources that demonstrate compliance through performance testing) or you must submit the calculation of HCl emission rate using Equation 16 of §63.7530 that demonstrates that your source is still meeting the emission limit for HCl emissions (for boilers or process heaters that demonstrate compliance through fuel analysis). If you burned a new type of fuel and are subject to a mercury emission limit, you must submit the calculation of mercury input, using Equation 8 of §63.7530, that demonstrates that your source is still within its maximum mercury input level established during the previous performance testing (for sources that demonstrate compliance through performance testing), or you must submit the calculation of mercury emission rate using Equation 17 of §63.7530 that demonstrates that your source is still meeting the emission limit for mercury emissions (for boilers or process heaters that demonstrate compliance through fuel analysis). If you burned a new type of fuel and are subject to a TSM emission limit, you must submit the calculation of TSM input, using Equation 9 of §63.7530, that demonstrates that your source is still within its maximum TSM input level established during the previous performance testing (for sources that demonstrate compliance through performance testing), or you must submit the calculation of TSM emission rate, using Equation 18 of §63.7530, that demonstrates that your source is still meeting the emission limit for TSM emissions (for boilers or process heaters that demonstrate compliance through fuel analysis).

(ix) If you wish to burn a new type of fuel in an individual boiler or process heater subject to an emission limit and you cannot demonstrate compliance with the maximum chlorine input operating limit using Equation 7 of §63.7530 or the maximum mercury input operating limit using Equation 8 of §63.7530, or the maximum TSM input operating limit using Equation 9 of §63.7530 you must include in the compliance report a statement indicating the intent to conduct a new performance test within 60 days of starting to burn the new fuel.

(x) A summary of any monthly fuel analyses conducted to demonstrate compliance according to §§63.7521 and 63.7530 for individual boilers or process heaters subject to emission limits, and any fuel specification analyses conducted according to §§63.7521(f) and 63.7530(g).

(xi) If there are no deviations from any emission limits or operating limits in this subpart that apply to you, a statement that there were no deviations from the emission limits or operating limits during the reporting period.

(xii) If there were no deviations from the monitoring requirements including no periods during which the CMSs, including CEMS, COMS, and CPMS, were out of control as specified in §63.8(c)(7), a statement that there were no deviations and no periods during which the CMS were out of control during the reporting period.

(xiii) If a malfunction occurred during the reporting period, the report must include the number, duration, and a brief description for each type of malfunction which occurred during the reporting period and which caused or may have caused any applicable emission limitation to be exceeded. The report must also include a description of actions taken by you during a malfunction of a boiler, process heater, or associated air pollution control device or CMS to minimize emissions in accordance with §63.7500(a)(3), including actions taken to correct the malfunction.

(xiv) Include the date of the most recent tune-up for each unit subject to only the requirement to conduct an annual, biennial, or 5-year tune-up according to §63.7540(a)(10), (11), or (12) respectively. Include the date of the most recent burner inspection if it was not done annually, biennially, or on a 5-year period and was delayed until the next scheduled or unscheduled unit shutdown.

(xv) If you plan to demonstrate compliance by emission averaging, certify the emission level achieved or the control technology employed is no less stringent than the level or control technology contained in the notification of compliance status in §63.7545(e)(5)(i).

(xvi) For each reporting period, the compliance reports must include all of the calculated 30 day rolling average values for CEMS (CO, HCl, SO<sub>2</sub>, and mercury), 10 day rolling average values for CO CEMS when the limit is expressed as a 10 day instead of 30 day rolling average, and the PM CPMS data.

(xvii) Statement by a responsible official with that official's name, title, and signature, certifying the truth, accuracy, and completeness of the content of the report.

(xviii) For each instance of startup or shutdown include the information required to be monitored, collected, or recorded according to the requirements of §63.7555(d).

(d) For each deviation from an emission limit or operating limit in this subpart that occurs at an individual boiler or process heater where you are not using a CMS to comply with that emission limit or operating limit, or from the work practice standards for periods of startup and shutdown, the compliance report must additionally contain the information required in paragraphs (d)(1) through (3) of this section.

(1) A description of the deviation and which emission limit, operating limit, or work practice standard from which you deviated.

(2) Information on the number, duration, and cause of deviations (including unknown cause), as applicable, and the corrective action taken.

(3) If the deviation occurred during an annual performance test, provide the date the annual performance test was completed.

(e) For each deviation from an emission limit, operating limit, and monitoring requirement in this subpart occurring at an individual boiler or process heater where you are using a CMS to comply with that emission limit or operating limit, the compliance report must additionally contain the information required in paragraphs (e)(1) through (9) of this section. This includes any deviations from your site-specific monitoring plan as required in §63.7505(d).

(1) The date and time that each deviation started and stopped and description of the nature of the deviation (i.e., what you deviated from).

(2) The date and time that each CMS was inoperative, except for zero (low-level) and high-level checks.

(3) The date, time, and duration that each CMS was out of control, including the information in §63.8(c)(8).

(4) The date and time that each deviation started and stopped.

(5) A summary of the total duration of the deviation during the reporting period and the total duration as a percent of the total source operating time during that reporting period.

(6) A characterization of the total duration of the deviations during the reporting period into those that are due to control equipment problems, process problems, other known causes, and other unknown causes.

(7) A summary of the total duration of CMS's downtime during the reporting period and the total duration of CMS downtime as a percent of the total source operating time during that reporting period.

(8) A brief description of the source for which there was a deviation.

(9) A description of any changes in CMSs, processes, or controls since the last reporting period for the source for which there was a deviation.

(f)-(g) [Reserved]

(h) You must submit the reports according to the procedures specified in paragraphs (h)(1) through (3) of this section.

(1) Within 60 days after the date of completing each performance test (as defined in §63.2) required by this subpart, you must submit the results of the performance tests, including any fuel analyses, following the procedure specified in either paragraph (h)(1)(i) or (ii) of this section.

(i) For data collected using test methods supported by the EPA's Electronic Reporting Tool (ERT) as listed on the EPA's ERT Web site (<http://www.epa.gov/ttn/chief/ert/index.html>), you must submit the results of the performance test to the EPA via the Compliance and Emissions Data Reporting Interface (CEDRI). (CEDRI can be accessed through the EPA's Central Data Exchange (CDX) (<https://cdx.epa.gov/>.) Performance test data must be submitted in a file format generated through use of the EPA's ERT or an electronic file format consistent with the extensible markup language (XML) schema listed on the EPA's ERT Web site. If you claim that some of the performance test information being submitted is confidential business information (CBI), you must submit a complete file generated through the use of the EPA's ERT or an alternate electronic file consistent with the XML schema listed on the EPA's ERT Web site, including information claimed to be CBI, on a compact disc, flash drive, or other commonly used electronic storage media to the EPA. The electronic media must be clearly marked as CBI and mailed to U.S. EPA/OAPQS/CORE CBI Office, Attention: Group Leader, Measurement Policy Group, MD C404-02, 4930 Old Page Rd., Durham, NC 27703. The same ERT or alternate file with the CBI omitted must be submitted to the EPA via the EPA's CDX as described earlier in this paragraph.

(ii) For data collected using test methods that are not supported by the EPA's ERT as listed on the EPA's ERT Web site at the time of the test, you must submit the results of the performance test to the Administrator at the appropriate address listed in §63.13.

(2) Within 60 days after the date of completing each CEMS performance evaluation (as defined in 63.2), you must submit the results of the performance evaluation following the procedure specified in either paragraph (h)(2)(i) or (ii) of this section.

(i) For performance evaluations of continuous monitoring systems measuring relative accuracy test audit (RATA) pollutants that are supported by the EPA's ERT as listed on the EPA's ERT Web site at the time of the evaluation, you must submit the results of the performance evaluation to the EPA via the CEDRI. (CEDRI can be accessed through the EPA's CDX.) Performance evaluation data must be submitted in a file format generated through the use of the EPA's ERT or an alternate file format consistent with the XML schema listed on the EPA's ERT Web site. If you claim that some of the performance evaluation information being transmitted is CBI, you must submit a complete file generated through the use of the EPA's ERT or an alternate electronic file consistent with the XML schema listed on the EPA's ERT Web site, including information claimed to be CBI, on a compact disc, flash drive, or other commonly used electronic storage media to the EPA. The electronic media must be clearly marked as CBI and mailed to U.S. EPA/OAPQS/CORE CBI Office, Attention: Group Leader, Measurement Policy Group, MD C404-02, 4930 Old Page Rd., Durham, NC 27703. The same ERT or alternate file with the CBI omitted must be submitted to the EPA via the EPA's CDX as described earlier in this paragraph.

(ii) For any performance evaluations of continuous monitoring systems measuring RATA pollutants that are not supported by the EPA's ERT as listed on the ERT Web site at the time of the evaluation, you must submit the results of the performance evaluation to the Administrator at the appropriate address listed in §63.13.

(3) You must submit all reports required by Table 9 of this subpart electronically to the EPA via the CEDRI. (CEDRI can be accessed through the EPA's CDX.) You must use the appropriate electronic report in CEDRI for this subpart. Instead of using the electronic report in CEDRI for this subpart, you may submit an alternate electronic file consistent with the XML schema listed on the CEDRI Web site (<http://www.epa.gov/ttn/chief/cedri/index.html>), once the XML schema is available. If the reporting form specific to this subpart is not available in CEDRI at the time that the report is due, you must submit the report to the Administrator at the appropriate address listed in §63.13. You must begin submitting reports via CEDRI no later than 90 days after the form becomes available in CEDRI.

[78 FR 7183, Jan. 31, 2013, as amended at 80 FR 72814, Nov. 20, 2015]

[↑ Back to Top](#)

### **§63.7555 What records must I keep?**

(a) You must keep records according to paragraphs (a)(1) and (2) of this section.

(1) A copy of each notification and report that you submitted to comply with this subpart, including all documentation supporting any Initial Notification or Notification of Compliance Status or semiannual compliance report that you submitted, according to the requirements in §63.10(b)(2)(xiv).

(2) Records of performance tests, fuel analyses, or other compliance demonstrations and performance evaluations as required in §63.10(b)(2)(viii).

(3) For units in the limited use subcategory, you must keep a copy of the federally enforceable permit that limits the annual capacity factor to less than or equal to 10 percent and fuel use records for the days the boiler or process heater was operating.

(b) For each CEMS, COMS, and continuous monitoring system you must keep records according to paragraphs (b)(1) through (5) of this section.

(1) Records described in §63.10(b)(2)(vii) through (xi).

(2) Monitoring data for continuous opacity monitoring system during a performance evaluation as required in §63.6(h)(7)(i) and (ii).

(3) Previous (*i.e.*, superseded) versions of the performance evaluation plan as required in §63.8(d)(3).

(4) Request for alternatives to relative accuracy test for CEMS as required in §63.8(f)(6)(i).

(5) Records of the date and time that each deviation started and stopped.

(c) You must keep the records required in Table 8 to this subpart including records of all monitoring data and calculated averages for applicable operating limits, such as opacity, pressure drop, pH, and operating load, to show continuous compliance with each emission limit and operating limit that applies to you.

(d) For each boiler or process heater subject to an emission limit in Tables 1, 2, or 11 through 13 to this subpart, you must also keep the applicable records in paragraphs (d)(1) through (11) of this section.

(1) You must keep records of monthly fuel use by each boiler or process heater, including the type(s) of fuel and amount(s) used.

(2) If you combust non-hazardous secondary materials that have been determined not to be solid waste pursuant to §241.3(b)(1) and (2) of this chapter, you must keep a record that documents how the secondary material meets each of the legitimacy criteria under §241.3(d)(1) of this chapter. If you combust a fuel that has been processed from a discarded non-hazardous secondary material pursuant to §241.3(b)(4) of this chapter, you must keep records as to how the operations that produced the fuel satisfy the definition of processing in §241.2 of this chapter. If the fuel received a non-waste determination pursuant to the petition process submitted under §241.3(c) of this chapter, you must keep a record that documents how the fuel satisfies the requirements of the petition process. For operating units that combust non-hazardous secondary materials as fuel per §241.4 of this chapter, you must keep records documenting that the material is listed as a non-waste under §241.4(a) of this chapter. Units exempt from the incinerator standards under section 129(g)(1) of the Clean Air Act because they are qualifying facilities burning a homogeneous waste stream do not need to maintain the records described in this paragraph (d)(2).

(3) A copy of all calculations and supporting documentation of maximum chlorine fuel input, using Equation 7 of §63.7530, that were done to demonstrate continuous compliance with the HCl emission limit, for sources that demonstrate compliance through performance testing. For sources that demonstrate compliance through fuel analysis, a copy of all calculations and supporting documentation of HCl emission rates, using Equation 16 of §63.7530, that were done to demonstrate compliance with the HCl emission limit. Supporting documentation should include results of any fuel analyses and basis for the estimates of maximum chlorine fuel input or HCl emission rates. You can use the results from one fuel analysis for multiple boilers and process heaters provided they are all burning the same fuel type. However, you must calculate chlorine fuel input, or HCl emission rate, for each boiler and process heater.

(4) A copy of all calculations and supporting documentation of maximum mercury fuel input, using Equation 8 of §63.7530, that were done to demonstrate continuous compliance with the mercury emission limit for sources that demonstrate compliance through performance testing. For sources that demonstrate compliance through fuel analysis, a copy of all calculations and supporting documentation of mercury emission rates, using Equation 17 of §63.7530, that were done to demonstrate compliance with the mercury emission limit. Supporting documentation should include results of any fuel analyses and basis for the estimates of maximum mercury fuel input or mercury emission rates. You can use the results from one fuel analysis for multiple boilers and process heaters provided they are all burning the same fuel type. However, you must calculate mercury fuel input, or mercury emission rates, for each boiler and process heater.

(5) If, consistent with §63.7515(b), you choose to stack test less frequently than annually, you must keep a record that documents that your emissions in the previous stack test(s) were less than 75 percent of the applicable emission limit (or, in specific instances noted in Tables 1 and 2 or 11 through 13 to this subpart, less than the applicable emission limit), and document that there was no change in source operations including fuel composition and operation of air pollution control equipment that would cause emissions of the relevant pollutant to increase within the past year.

(6) Records of the occurrence and duration of each malfunction of the boiler or process heater, or of the associated air pollution control and monitoring equipment.

(7) Records of actions taken during periods of malfunction to minimize emissions in accordance with the general duty to minimize emissions in §63.7500(a)(3), including corrective actions to restore the malfunctioning boiler or process heater, air pollution control, or monitoring equipment to its normal or usual manner of operation.

(8) A copy of all calculations and supporting documentation of maximum TSM fuel input, using Equation 9 of §63.7530, that were done to demonstrate continuous compliance with the TSM emission limit for sources that demonstrate compliance through performance testing. For sources that demonstrate compliance through fuel analysis, a copy of all calculations and supporting documentation of TSM emission rates, using Equation 18 of §63.7530, that were done to demonstrate compliance with the TSM emission limit. Supporting documentation should include results of any fuel analyses and basis for the estimates of maximum TSM fuel input or TSM emission rates. You can use the results from one fuel analysis for multiple boilers and process heaters provided they are all burning the same fuel type. However, you must calculate TSM fuel input, or TSM emission rates, for each boiler and process heater.

(9) You must maintain records of the calendar date, time, occurrence and duration of each startup and shutdown.

(10) You must maintain records of the type(s) and amount(s) of fuels used during each startup and shutdown.

(11) For each startup period, for units selecting paragraph (2) of the definition of “startup” in §63.7575 you must maintain records of the time that clean fuel combustion begins; the time when you start feeding fuels that are not clean fuels; the time when useful thermal energy is first supplied; and the time when the PM controls are engaged.

(12) If you choose to rely on paragraph (2) of the definition of “startup” in §63.7575, for each startup period, you must maintain records of the hourly steam temperature, hourly steam pressure, hourly steam flow, hourly flue gas temperature, and all hourly average CMS data (*e.g.*, CEMS, PM CPMS, COMS, ESP total secondary electric power input, scrubber pressure drop, scrubber liquid flow rate) collected during each startup period to confirm that the control devices are engaged. In addition, if compliance with the PM emission limit is demonstrated using a PM control device, you must maintain records as specified in paragraphs (d)(12)(i) through (iii) of this section.

(i) For a boiler or process heater with an electrostatic precipitator, record the number of fields in service, as well as each field's secondary voltage and secondary current during each hour of startup.

(ii) For a boiler or process heater with a fabric filter, record the number of compartments in service, as well as the differential pressure across the baghouse during each hour of startup.

(iii) For a boiler or process heater with a wet scrubber needed for filterable PM control, record the scrubber's liquid flow rate and the pressure drop during each hour of startup.

(13) If you choose to use paragraph (2) of the definition of “startup” in §63.7575 and you find that you are unable to safely engage and operate your PM control(s) within 1 hour of first firing of non-clean fuels, you may choose to rely on paragraph (1) of definition of “startup” in §63.7575 or you may submit to the delegated permitting authority a request for a variance with the PM controls requirement, as described below.

(i) The request shall provide evidence of a documented manufacturer-identified safety issue.

(ii) The request shall provide information to document that the PM control device is adequately designed and sized to meet the applicable PM emission limit.

(iii) In addition, the request shall contain documentation that:

(A) The unit is using clean fuels to the maximum extent possible to bring the unit and PM control device up to the temperature necessary to alleviate or prevent the identified safety issues prior to the combustion of primary fuel;

(B) The unit has explicitly followed the manufacturer's procedures to alleviate or prevent the identified safety issue; and

(C) Identifies with specificity the details of the manufacturer's statement of concern.

(iv) You must comply with all other work practice requirements, including but not limited to data collection, recordkeeping, and reporting requirements.

(e) If you elect to average emissions consistent with §63.7522, you must additionally keep a copy of the emission averaging implementation plan required in §63.7522(g), all calculations required under §63.7522, including monthly records of heat input or steam generation, as applicable, and monitoring records consistent with §63.7541.

(f) If you elect to use efficiency credits from energy conservation measures to demonstrate compliance according to §63.7533, you must keep a copy of the Implementation Plan required in §63.7533(d) and copies of all data and calculations used to establish credits according to §63.7533(b), (c), and (f).

(g) If you elected to demonstrate that the unit meets the specification for mercury for the unit designed to burn gas 1 subcategory, you must maintain monthly records (or at the frequency required by §63.7540(c)) of the calculations and results of the fuel specification for mercury in Table 6.

(h) If you operate a unit in the unit designed to burn gas 1 subcategory that is subject to this subpart, and you use an alternative fuel other than natural gas, refinery gas, gaseous fuel subject to another subpart under this part, other gas 1 fuel, or gaseous fuel subject to another subpart of this part or part 60, 61, or 65, you must keep records of the total hours per calendar year that alternative fuel is burned and the total hours per calendar year that the unit operated during periods of gas curtailment or gas supply emergencies.

[76 FR 15664, Mar. 21, 2011, as amended at 78 FR 7185, Jan. 31, 2013; 80 FR 72816, Nov. 20, 2015]

[↑ Back to Top](#)

#### **§63.7560 In what form and how long must I keep my records?**

(a) Your records must be in a form suitable and readily available for expeditious review, according to §63.10(b)(1).

(b) As specified in §63.10(b)(1), you must keep each record for 5 years following the date of each occurrence, measurement, maintenance, corrective action, report, or record.

(c) You must keep each record on site, or they must be accessible from on site (for example, through a computer network), for at least 2 years after the date of each occurrence, measurement, maintenance, corrective action, report, or record, according to §63.10(b)(1). You can keep the records off site for the remaining 3 years.

[↑ Back to Top](#)

#### **Other Requirements and Information**

[↑ Back to Top](#)

#### **§63.7565 What parts of the General Provisions apply to me?**

Table 10 to this subpart shows which parts of the General Provisions in §§63.1 through 63.15 apply to you.

[↑ Back to Top](#)

#### **§63.7570 Who implements and enforces this subpart?**

(a) This subpart can be implemented and enforced by the EPA, or an Administrator such as your state, local, or tribal agency. If the EPA Administrator has delegated authority to your state, local, or tribal



agency, then that agency (as well as the EPA) has the authority to implement and enforce this subpart. You should contact your EPA Regional Office to find out if this subpart is delegated to your state, local, or tribal agency.

(b) In delegating implementation and enforcement authority of this subpart to a state, local, or tribal agency under 40 CFR part 63, subpart E, the authorities listed in paragraphs (b)(1) through (4) of this section are retained by the EPA Administrator and are not transferred to the state, local, or tribal agency, however, the EPA retains oversight of this subpart and can take enforcement actions, as appropriate.

(1) Approval of alternatives to the emission limits and work practice standards in §63.7500(a) and (b) under §63.6(g), except as specified in §63.7555(d)(13).

(2) Approval of major change to test methods in Table 5 to this subpart under §63.7(e)(2)(ii) and (f) and as defined in §63.90, and alternative analytical methods requested under §63.7521(b)(2).

(3) Approval of major change to monitoring under §63.8(f) and as defined in §63.90, and approval of alternative operating parameters under §§63.7500(a)(2) and 63.7522(g)(2).

(4) Approval of major change to recordkeeping and reporting under §63.10(e) and as defined in §63.90.

[76 FR 15664, Mar. 21, 2011, as amended at 78 FR 7186, Jan. 31, 2013; 80 FR 72817, Nov. 20, 2015]

[↑ Back to Top](#)

### **§63.7575 What definitions apply to this subpart?**

Terms used in this subpart are defined in the Clean Air Act, in §63.2 (the General Provisions), and in this section as follows:

*10-day rolling average* means the arithmetic mean of the previous 240 hours of valid operating data. Valid data excludes hours during startup and shutdown, data collected during periods when the monitoring system is out of control as specified in your site-specific monitoring plan, while conducting repairs associated with periods when the monitoring system is out of control, or while conducting required monitoring system quality assurance or quality control activities, and periods when this unit is not operating. The 240 hours should be consecutive, but not necessarily continuous if operations were intermittent.

*30-day rolling average* means the arithmetic mean of the previous 720 hours of valid CO CEMS data. The 720 hours should be consecutive, but not necessarily continuous if operations were intermittent. For parameters other than CO, 30-day rolling average means either the arithmetic mean of all valid hours of data from 30 successive operating days or the arithmetic mean of the previous 720 hours of valid operating data. Valid data excludes hours during startup and shutdown, data collected during periods when the monitoring system is out of control as specified in your site-specific monitoring plan, while conducting repairs associated with periods when the monitoring system is out of control, or while conducting required monitoring system quality assurance or quality control activities, and periods when this unit is not operating.

*Annual capacity factor* means the ratio between the actual heat input to a boiler or process heater from the fuels burned during a calendar year and the potential heat input to the boiler or process heater had it been operated for 8,760 hours during a year at the maximum steady state design heat input capacity.

*Annual heat input* means the heat input for the 12 months preceding the compliance demonstration.

*Average annual heat input rate* means total heat input divided by the hours of operation for the 12 months preceding the compliance demonstration.

*Bag leak detection system* means a group of instruments that are capable of monitoring particulate matter loadings in the exhaust of a fabric filter (*i.e.*, baghouse) in order to detect bag failures. A bag leak detection system includes, but is not limited to, an instrument that operates on electrodynamic, triboelectric, light scattering, light transmittance, or other principle to monitor relative particulate matter loadings.

*Benchmark* means the fuel heat input for a boiler or process heater for the one-year period before the date that an energy demand reduction occurs, unless it can be demonstrated that a different time period is more representative of historical operations.

*Biodiesel* means a mono-alkyl ester derived from biomass and conforming to ASTM D6751-11b, Standard Specification for Biodiesel Fuel Blend Stock (B100) for Middle Distillate Fuels (incorporated by reference, see §63.14).

*Biomass or bio-based solid fuel* means any biomass-based solid fuel that is not a solid waste. This includes, but is not limited to, wood residue; wood products (*e.g.*, trees, tree stumps, tree limbs, bark, lumber, sawdust, sander dust, chips, scraps, slabs, millings, and shavings); animal manure, including litter and other bedding materials; vegetative agricultural and silvicultural materials, such as logging residues (slash), nut and grain hulls and chaff (*e.g.*, almond, walnut, peanut, rice, and wheat), bagasse, orchard prunings, corn stalks, coffee bean hulls and grounds. This definition of biomass is not intended to suggest that these materials are or are not solid waste.

*Blast furnace gas fuel-fired boiler or process heater* means an industrial/commercial/institutional boiler or process heater that receives 90 percent or more of its total annual gas volume from blast furnace gas.

*Boiler* means an enclosed device using controlled flame combustion and having the primary purpose of recovering thermal energy in the form of steam or hot water. Controlled flame combustion refers to a steady-state, or near steady-state, process wherein fuel and/or oxidizer feed rates are controlled. A device combusting solid waste, as defined in §241.3 of this chapter, is not a boiler unless the device is exempt from the definition of a solid waste incineration unit as provided in section 129(g)(1) of the Clean Air Act. Waste heat boilers are excluded from this definition.

*Boiler system* means the boiler and associated components, such as, the feed water system, the combustion air system, the fuel system (including burners), blowdown system, combustion control systems, steam systems, and condensate return systems.

*Calendar year* means the period between January 1 and December 31, inclusive, for a given year.

*Clean dry biomass* means any biomass-based solid fuel that have not been painted, pigment-stained, or pressure treated, does not contain contaminants at concentrations not normally associated with virgin biomass materials and has a moisture content of less than 20 percent and is not a solid waste.

*Coal* means all solid fuels classifiable as anthracite, bituminous, sub-bituminous, or lignite by ASTM D388 (incorporated by reference, see §63.14), coal refuse, and petroleum coke. For the purposes of this subpart, this definition of “coal” includes synthetic fuels derived from coal, including but not limited to, solvent-refined coal, coal-oil mixtures, and coal-water mixtures. Coal derived gases are excluded from this definition.

*Coal refuse* means any by-product of coal mining or coal cleaning operations with an ash content greater than 50 percent (by weight) and a heating value less than 13,900 kilojoules per kilogram (6,000 Btu per pound) on a dry basis.

*Commercial/institutional boiler* means a boiler used in commercial establishments or institutional establishments such as medical centers, nursing homes, research centers, institutions of higher education, elementary and secondary schools, libraries, religious establishments, governmental buildings, hotels, restaurants, and laundries to provide electricity, steam, and/or hot water.

*Common stack* means the exhaust of emissions from two or more affected units through a single flue. Affected units with a common stack may each have separate air pollution control systems located before the common stack, or may have a single air pollution control system located after the exhausts come together in a single flue.

*Cost-effective energy conservation measure* means a measure that is implemented to improve the energy efficiency of the boiler or facility that has a payback (return of investment) period of 2 years or less.

*Daily block average* means the arithmetic mean of all valid emission concentrations or parameter levels recorded when a unit is operating measured over the 24-hour period from 12 a.m. (midnight) to 12 a.m. (midnight), except for periods of startup and shutdown or downtime.

*Deviation.* (1) *Deviation* means any instance in which an affected source subject to this subpart, or an owner or operator of such a source:

(i) Fails to meet any applicable requirement or obligation established by this subpart including, but not limited to, any emission limit, operating limit, or work practice standard; or

(ii) Fails to meet any term or condition that is adopted to implement an applicable requirement in this subpart and that is included in the operating permit for any affected source required to obtain such a permit.

(2) A deviation is not always a violation.

*Dioxins/furans* means tetra- through octa-chlorinated dibenzo-p-dioxins and dibenzofurans.

*Distillate oil* means fuel oils that contain 0.05 weight percent nitrogen or less and comply with the specifications for fuel oil numbers 1 and 2, as defined by the American Society of Testing and Materials in ASTM D396 (incorporated by reference, see §63.14) or diesel fuel oil numbers 1 and 2, as defined by

the American Society for Testing and Materials in ASTM D975 (incorporated by reference, see §63.14), kerosene, and biodiesel as defined by the American Society of Testing and Materials in ASTM D6751-11b (incorporated by reference, see §60.14).

*Dry scrubber* means an add-on air pollution control system that injects dry alkaline sorbent (dry injection) or sprays an alkaline sorbent (spray dryer) to react with and neutralize acid gas in the exhaust stream forming a dry powder material. Sorbent injection systems used as control devices in fluidized bed boilers and process heaters are included in this definition. A dry scrubber is a dry control system.

*Dutch oven* means a unit having a refractory-walled cell connected to a conventional boiler setting. Fuel materials are introduced through an opening in the roof of the dutch oven and burn in a pile on its floor. Fluidized bed boilers are not part of the dutch oven design category.

*Efficiency credit* means emission reductions above those required by this subpart. Efficiency credits generated may be used to comply with the emissions limits. Credits may come from pollution prevention projects that result in reduced fuel use by affected units. Boilers that are shut down cannot be used to generate credits unless the facility provides documentation linking the permanent shutdown to implementation of the energy conservation measures identified in the energy assessment.

*Electric utility steam generating unit (EGU)* means a fossil fuel-fired combustion unit of more than 25 megawatts electric (MWe) that serves a generator that produces electricity for sale. A fossil fuel-fired unit that cogenerates steam and electricity and supplies more than one-third of its potential electric output capacity and more than 25 MWe output to any utility power distribution system for sale is considered an electric utility steam generating unit. To be “capable of combusting” fossil fuels, an EGU would need to have these fuels allowed in their operating permits and have the appropriate fuel handling facilities on-site or otherwise available (e.g., coal handling equipment, including coal storage area, belts and conveyers, pulverizers, etc.; oil storage facilities). In addition, fossil fuel-fired EGU means any EGU that fired fossil fuel for more than 10.0 percent of the average annual heat input in any 3 consecutive calendar years or for more than 15.0 percent of the annual heat input during any one calendar year after April 16, 2012.

*Electrostatic precipitator (ESP)* means an add-on air pollution control device used to capture particulate matter by charging the particles using an electrostatic field, collecting the particles using a grounded collecting surface, and transporting the particles into a hopper. An electrostatic precipitator is usually a dry control system.

*Energy assessment* means the following for the emission units covered by this subpart:

(1) The energy assessment for facilities with affected boilers and process heaters with a combined heat input capacity of less than 0.3 trillion Btu (TBtu) per year will be 8 on-site technical labor hours in length maximum, but may be longer at the discretion of the owner or operator of the affected source. The boiler system(s), process heater(s), and any on-site energy use system(s) accounting for at least 50 percent of the affected boiler(s) energy (e.g., steam, hot water, process heat, or electricity) production, as applicable, will be evaluated to identify energy savings opportunities, within the limit of performing an 8-hour on-site energy assessment.

(2) The energy assessment for facilities with affected boilers and process heaters with a combined heat input capacity of 0.3 to 1.0 TBtu/year will be 24 on-site technical labor hours in length maximum, but

may be longer at the discretion of the owner or operator of the affected source. The boiler system(s), process heater(s), and any on-site energy use system(s) accounting for at least 33 percent of the energy (e.g., steam, hot water, process heat, or electricity) production, as applicable, will be evaluated to identify energy savings opportunities, within the limit of performing a 24-hour on-site energy assessment.

(3) The energy assessment for facilities with affected boilers and process heaters with a combined heat input capacity greater than 1.0 TBtu/year will be up to 24 on-site technical labor hours in length for the first TBtu/yr plus 8 on-site technical labor hours for every additional 1.0 TBtu/yr not to exceed 160 on-site technical hours, but may be longer at the discretion of the owner or operator of the affected source. The boiler system(s), process heater(s), and any on-site energy use system(s) accounting for at least 20 percent of the energy (e.g., steam, process heat, hot water, or electricity) production, as applicable, will be evaluated to identify energy savings opportunities.

(4) The on-site energy use systems serving as the basis for the percent of affected boiler(s) and process heater(s) energy production in paragraphs (1), (2), and (3) of this definition may be segmented by production area or energy use area as most logical and applicable to the specific facility being assessed (e.g., product X manufacturing area; product Y drying area; Building Z).

*Energy management practices* means the set of practices and procedures designed to manage energy use that are demonstrated by the facility's energy policies, a facility energy manager and other staffing responsibilities, energy performance measurement and tracking methods, an energy saving goal, action plans, operating procedures, internal reporting requirements, and periodic review intervals used at the facility.

*Energy management program* means a program that includes a set of practices and procedures designed to manage energy use that are demonstrated by the facility's energy policies, a facility energy manager and other staffing responsibilities, energy performance measurement and tracking methods, an energy saving goal, action plans, operating procedures, internal reporting requirements, and periodic review intervals used at the facility. Facilities may establish their program through energy management systems compatible with ISO 50001.

*Energy use system* includes the following systems located on-site that use energy (steam, hot water, or electricity) provided by the affected boiler or process heater: process heating; compressed air systems; machine drive (motors, pumps, fans); process cooling; facility heating, ventilation, and air-conditioning systems; hot water systems; building envelop; and lighting; or other systems that use steam, hot water, process heat, or electricity provided by the affected boiler or process heater. Energy use systems are only those systems using energy clearly produced by affected boilers and process heaters.

*Equivalent* means the following only as this term is used in Table 6 to this subpart:

(1) An equivalent sample collection procedure means a published voluntary consensus standard or practice (VCS) or EPA method that includes collection of a minimum of three composite fuel samples, with each composite consisting of a minimum of three increments collected at approximately equal intervals over the test period.

(2) An equivalent sample compositing procedure means a published VCS or EPA method to systematically mix and obtain a representative subsample (part) of the composite sample.

(3) An equivalent sample preparation procedure means a published VCS or EPA method that: Clearly states that the standard, practice or method is appropriate for the pollutant and the fuel matrix; or is cited as an appropriate sample preparation standard, practice or method for the pollutant in the chosen VCS or EPA determinative or analytical method.

(4) An equivalent procedure for determining heat content means a published VCS or EPA method to obtain gross calorific (or higher heating) value.

(5) An equivalent procedure for determining fuel moisture content means a published VCS or EPA method to obtain moisture content. If the sample analysis plan calls for determining metals (especially the mercury, selenium, or arsenic) using an aliquot of the dried sample, then the drying temperature must be modified to prevent vaporizing these metals. On the other hand, if metals analysis is done on an “as received” basis, a separate aliquot can be dried to determine moisture content and the metals concentration mathematically adjusted to a dry basis.

(6) An equivalent pollutant (mercury, HCl) determinative or analytical procedure means a published VCS or EPA method that clearly states that the standard, practice, or method is appropriate for the pollutant and the fuel matrix and has a published detection limit equal or lower than the methods listed in Table 6 to this subpart for the same purpose.

*Fabric filter* means an add-on air pollution control device used to capture particulate matter by filtering gas streams through filter media, also known as a baghouse. A fabric filter is a dry control system.

*Federally enforceable* means all limitations and conditions that are enforceable by the EPA Administrator, including, but not limited to, the requirements of 40 CFR parts 60, 61, 63, and 65, requirements within any applicable state implementation plan, and any permit requirements established under 40 CFR 52.21 or under 40 CFR 51.18 and 40 CFR 51.24.

*Fluidized bed boiler* means a boiler utilizing a fluidized bed combustion process that is not a pulverized coal boiler.

*Fluidized bed boiler with an integrated fluidized bed heat exchanger* means a boiler utilizing a fluidized bed combustion where the entire tube surface area is located outside of the furnace section at the exit of the cyclone section and exposed to the flue gas stream for conductive heat transfer. This design applies only to boilers in the unit designed to burn coal/solid fossil fuel subcategory that fire coal refuse.

*Fluidized bed combustion* means a process where a fuel is burned in a bed of granulated particles, which are maintained in a mobile suspension by the forward flow of air and combustion products.

*Fossil fuel* means natural gas, oil, coal, and any form of solid, liquid, or gaseous fuel derived from such material.

*Fuel cell* means a boiler type in which the fuel is dropped onto suspended fixed grates and is fired in a pile. The refractory-lined fuel cell uses combustion air preheating and positioning of secondary and tertiary air injection ports to improve boiler efficiency. Fluidized bed, dutch oven, pile burner, hybrid suspension grate, and suspension burners are not part of the fuel cell subcategory.

*Fuel type* means each category of fuels that share a common name or classification. Examples include, but are not limited to, bituminous coal, sub-bituminous coal, lignite, anthracite, biomass, distillate oil, residual oil. Individual fuel types received from different suppliers are not considered new fuel types.

*Gaseous fuel* includes, but is not limited to, natural gas, process gas, landfill gas, coal derived gas, refinery gas, and biogas. Blast furnace gas and process gases that are regulated under another subpart of this part, or part 60, part 61, or part 65 of this chapter, are exempted from this definition.

*Heat input* means heat derived from combustion of fuel in a boiler or process heater and does not include the heat input from preheated combustion air, recirculated flue gases, returned condensate, or exhaust gases from other sources such as gas turbines, internal combustion engines, kilns, etc.

*Heavy liquid* includes residual oil and any other liquid fuel not classified as a light liquid.

*Hourly average* means the arithmetic average of at least four CMS data values representing the four 15-minute periods in an hour, or at least two 15-minute data values during an hour when CMS calibration, quality assurance, or maintenance activities are being performed.

*Hot water heater* means a closed vessel with a capacity of no more than 120 U.S. gallons in which water is heated by combustion of gaseous, liquid, or biomass/bio-based solid fuel and is withdrawn for use external to the vessel. Hot water boilers (i.e., not generating steam) combusting gaseous, liquid, or biomass fuel with a heat input capacity of less than 1.6 million Btu per hour are included in this definition. The 120 U.S. gallon capacity threshold to be considered a hot water heater is independent of the 1.6 MMBtu/hr heat input capacity threshold for hot water boilers. Hot water heater also means a tankless unit that provides on demand hot water.

*Hybrid suspension grate boiler* means a boiler designed with air distributors to spread the fuel material over the entire width and depth of the boiler combustion zone. The biomass fuel combusted in these units exceeds a moisture content of 40 percent on an as-fired annual heat input basis as demonstrated by monthly fuel analysis. The drying and much of the combustion of the fuel takes place in suspension, and the combustion is completed on the grate or floor of the boiler. Fluidized bed, dutch oven, and pile burner designs are not part of the hybrid suspension grate boiler design category.

*Industrial boiler* means a boiler used in manufacturing, processing, mining, and refining or any other industry to provide steam, hot water, and/or electricity.

*Light liquid* includes distillate oil, biodiesel, or vegetable oil.

*Limited-use boiler or process heater* means any boiler or process heater that burns any amount of solid, liquid, or gaseous fuels and has a federally enforceable annual capacity factor of no more than 10 percent.

*Liquid fuel* includes, but is not limited to, light liquid, heavy liquid, any form of liquid fuel derived from petroleum, used oil, liquid biofuels, biodiesel, and vegetable oil.

*Load fraction* means the actual heat input of a boiler or process heater divided by heat input during the performance test that established the minimum sorbent injection rate or minimum activated carbon injection rate, expressed as a fraction (e.g., for 50 percent load the load fraction is 0.5). For boilers and process heaters that co-fire natural gas or refinery gas with a solid or liquid fuel, the load fraction is

determined by the actual heat input of the solid or liquid fuel divided by heat input of the solid or liquid fuel fired during the performance test (e.g., if the performance test was conducted at 100 percent solid fuel firing, for 100 percent load firing 50 percent solid fuel and 50 percent natural gas the load fraction is 0.5).

*Major source for oil and natural gas production facilities*, as used in this subpart, shall have the same meaning as in §63.2, except that:

- (1) Emissions from any oil or gas exploration or production well (with its associated equipment, as defined in this section), and emissions from any pipeline compressor station or pump station shall not be aggregated with emissions from other similar units to determine whether such emission points or stations are major sources, even when emission points are in a contiguous area or under common control;
- (2) Emissions from processes, operations, or equipment that are not part of the same facility, as defined in this section, shall not be aggregated; and
- (3) For facilities that are production field facilities, only HAP emissions from glycol dehydration units and storage vessels with the potential for flash emissions shall be aggregated for a major source determination. For facilities that are not production field facilities, HAP emissions from all HAP emission units shall be aggregated for a major source determination.

*Metal process furnaces* are a subcategory of process heaters, as defined in this subpart, which include natural gas-fired annealing furnaces, preheat furnaces, reheat furnaces, aging furnaces, heat treat furnaces, and homogenizing furnaces.

*Million Btu (MMBtu)* means one million British thermal units.

*Minimum activated carbon injection rate* means load fraction multiplied by the lowest hourly average activated carbon injection rate measured according to Table 7 to this subpart during the most recent performance test demonstrating compliance with the applicable emission limit.

*Minimum oxygen level* means the lowest hourly average oxygen level measured according to Table 7 to this subpart during the most recent performance test demonstrating compliance with the applicable emission limit.

*Minimum pressure drop* means the lowest hourly average pressure drop measured according to Table 7 to this subpart during the most recent performance test demonstrating compliance with the applicable emission limit.

*Minimum scrubber effluent pH* means the lowest hourly average sorbent liquid pH measured at the inlet to the wet scrubber according to Table 7 to this subpart during the most recent performance test demonstrating compliance with the applicable hydrogen chloride emission limit.

*Minimum scrubber liquid flow rate* means the lowest hourly average liquid flow rate (e.g., to the PM scrubber or to the acid gas scrubber) measured according to Table 7 to this subpart during the most recent performance stack test demonstrating compliance with the applicable emission limit.



*Minimum scrubber pressure drop* means the lowest hourly average scrubber pressure drop measured according to Table 7 to this subpart during the most recent performance test demonstrating compliance with the applicable emission limit.

*Minimum sorbent injection rate* means:

- (1) The load fraction multiplied by the lowest hourly average sorbent injection rate for each sorbent measured according to Table 7 to this subpart during the most recent performance test demonstrating compliance with the applicable emission limits; or
- (2) For fluidized bed combustion not using an acid gas wet scrubber or dry sorbent injection control technology to comply with the HCl emission limit, the lowest average ratio of sorbent to sulfur measured during the most recent performance test.

*Minimum total secondary electric power* means the lowest hourly average total secondary electric power determined from the values of secondary voltage and secondary current to the electrostatic precipitator measured according to Table 7 to this subpart during the most recent performance test demonstrating compliance with the applicable emission limits.

*Natural gas* means:

- (1) A naturally occurring mixture of hydrocarbon and nonhydrocarbon gases found in geologic formations beneath the earth's surface, of which the principal constituent is methane; or
- (2) Liquefied petroleum gas, as defined in ASTM D1835 (incorporated by reference, see §63.14); or
- (3) A mixture of hydrocarbons that maintains a gaseous state at ISO conditions. Additionally, natural gas must either be composed of at least 70 percent methane by volume or have a gross calorific value between 35 and 41 megajoules (MJ) per dry standard cubic meter (950 and 1,100 Btu per dry standard cubic foot); or
- (4) Propane or propane derived synthetic natural gas. Propane means a colorless gas derived from petroleum and natural gas, with the molecular structure  $C_3H_8$ .

*Opacity* means the degree to which emissions reduce the transmission of light and obscure the view of an object in the background.

*Operating day* means a 24-hour period between 12 midnight and the following midnight during which any fuel is combusted at any time in the boiler or process heater unit. It is not necessary for fuel to be combusted for the entire 24-hour period. For calculating rolling average emissions, an operating day does not include the hours of operation during startup or shutdown.

*Other combustor* means a unit designed to burn solid fuel that is not classified as a dutch oven, fluidized bed, fuel cell, hybrid suspension grate boiler, pulverized coal boiler, stoker, sloped grate, or suspension boiler as defined in this subpart.

*Other gas 1 fuel* means a gaseous fuel that is not natural gas or refinery gas and does not exceed a maximum concentration of 40 micrograms/cubic meters of mercury.

*Oxygen analyzer system* means all equipment required to determine the oxygen content of a gas stream and used to monitor oxygen in the boiler or process heater flue gas, boiler or process heater, firebox, or other appropriate location. This definition includes oxygen trim systems. The source owner or operator must install, calibrate, maintain, and operate the oxygen analyzer system in accordance with the manufacturer's recommendations.

*Oxygen trim system* means a system of monitors that is used to maintain excess air at the desired level in a combustion device over its operating load range. A typical system consists of a flue gas oxygen and/or CO monitor that automatically provides a feedback signal to the combustion air controller or draft controller.

*Particulate matter (PM)* means any finely divided solid or liquid material, other than uncombined water, as measured by the test methods specified under this subpart, or an approved alternative method.

*Period of gas curtailment or supply interruption* means a period of time during which the supply of gaseous fuel to an affected boiler or process heater is restricted or halted for reasons beyond the control of the facility. The act of entering into a contractual agreement with a supplier of natural gas established for curtailment purposes does not constitute a reason that is under the control of a facility for the purposes of this definition. An increase in the cost or unit price of natural gas due to normal market fluctuations not during periods of supplier delivery restriction does not constitute a period of natural gas curtailment or supply interruption. On-site gaseous fuel system emergencies or equipment failures qualify as periods of supply interruption when the emergency or failure is beyond the control of the facility.

*Pile burner* means a boiler design incorporating a design where the anticipated biomass fuel has a high relative moisture content. Grates serve to support the fuel, and underfire air flowing up through the grates provides oxygen for combustion, cools the grates, promotes turbulence in the fuel bed, and fires the fuel. The most common form of pile burning is the dutch oven.

*Process heater* means an enclosed device using controlled flame, and the unit's primary purpose is to transfer heat indirectly to a process material (liquid, gas, or solid) or to a heat transfer material (e.g., glycol or a mixture of glycol and water) for use in a process unit, instead of generating steam. Process heaters are devices in which the combustion gases do not come into direct contact with process materials. A device combusting solid waste, as defined in §241.3 of this chapter, is not a process heater unless the device is exempt from the definition of a solid waste incineration unit as provided in section 129(g)(1) of the Clean Air Act. Process heaters do not include units used for comfort heat or space heat, food preparation for on-site consumption, or autoclaves. Waste heat process heaters are excluded from this definition.

*Pulverized coal boiler* means a boiler in which pulverized coal or other solid fossil fuel is introduced into an air stream that carries the coal to the combustion chamber of the boiler where it is fired in suspension.

*Qualified energy assessor* means:

(1) Someone who has demonstrated capabilities to evaluate energy savings opportunities for steam generation and major energy using systems, including, but not limited to:

(i) Boiler combustion management.

- (ii) Boiler thermal energy recovery, including
  - (A) Conventional feed water economizer,
  - (B) Conventional combustion air preheater, and
  - (C) Condensing economizer.
- (iii) Boiler blowdown thermal energy recovery.
- (iv) Primary energy resource selection, including
  - (A) Fuel (primary energy source) switching, and
  - (B) Applied steam energy versus direct-fired energy versus electricity.
- (v) Insulation issues.
- (vi) Steam trap and steam leak management.
- (vii) Condensate recovery.
- (viii) Steam end-use management.

(2) Capabilities and knowledge includes, but is not limited to:

- (i) Background, experience, and recognized abilities to perform the assessment activities, data analysis, and report preparation.
- (ii) Familiarity with operating and maintenance practices for steam or process heating systems.
- (iii) Additional potential steam system improvement opportunities including improving steam turbine operations and reducing steam demand.
- (iv) Additional process heating system opportunities including effective utilization of waste heat and use of proper process heating methods.
- (v) Boiler-steam turbine cogeneration systems.
- (vi) Industry specific steam end-use systems.

*Refinery gas* means any gas that is generated at a petroleum refinery and is combusted. Refinery gas includes natural gas when the natural gas is combined and combusted in any proportion with a gas generated at a refinery. Refinery gas includes gases generated from other facilities when that gas is combined and combusted in any proportion with gas generated at a refinery.

*Regulated gas stream* means an offgas stream that is routed to a boiler or process heater for the purpose of achieving compliance with a standard under another subpart of this part or part 60, part 61, or part 65 of this chapter.

*Residential boiler* means a boiler used to provide heat and/or hot water and/or as part of a residential combined heat and power system. This definition includes boilers located at an institutional facility (e.g., university campus, military base, church grounds) or commercial/industrial facility (e.g., farm) used primarily to provide heat and/or hot water for:

(1) A dwelling containing four or fewer families; or

(2) A single unit residence dwelling that has since been converted or subdivided into condominiums or apartments.

*Residual oil* means crude oil, fuel oil that does not comply with the specifications under the definition of distillate oil, and all fuel oil numbers 4, 5, and 6, as defined by the American Society of Testing and Materials in ASTM D396-10 (incorporated by reference, *see* §63.14(b)).

*Responsible official* means responsible official as defined in §70.2.

*Rolling average* means the average of all data collected during the applicable averaging period. For demonstration of compliance with a CO CEMS-based emission limit based on CO concentration a 30-day (10-day) rolling average is comprised of the average of all the hourly average concentrations over the previous 720 (240) operating hours calculated each operating day. To demonstrate compliance on a 30-day rolling average basis for parameters other than CO, you must indicate the basis of the 30-day rolling average period you are using for compliance, as discussed in §63.7545(e)(2)(iii). If you indicate the 30 operating day basis, you must calculate a new average value each operating day and shall include the measured hourly values for the preceding 30 operating days. If you select the 720 operating hours basis, you must average of all the hourly average concentrations over the previous 720 operating hours calculated each operating day.

*Secondary material* means the material as defined in §241.2 of this chapter.

*Shutdown* means the period in which cessation of operation of a boiler or process heater is initiated for any purpose. Shutdown begins when the boiler or process heater no longer supplies useful thermal energy (such as heat or steam) for heating, cooling, or process purposes and/or generates electricity or when no fuel is being fed to the boiler or process heater, whichever is earlier. Shutdown ends when the boiler or process heater no longer supplies useful thermal energy (such as steam or heat) for heating, cooling, or process purposes and/or generates electricity, and no fuel is being combusted in the boiler or process heater.

*Sloped grate* means a unit where the solid fuel is fed to the top of the grate from where it slides downwards; while sliding the fuel first dries and then ignites and burns. The ash is deposited at the bottom of the grate. Fluidized bed, dutch oven, pile burner, hybrid suspension grate, suspension burners, and fuel cells are not considered to be a sloped grate design.

*Solid fossil fuel* includes, but is not limited to, coal, coke, petroleum coke, and tire derived fuel.

*Solid fuel* means any solid fossil fuel or biomass or bio-based solid fuel.

*Startup* means:

(1) Either the first-ever firing of fuel in a boiler or process heater for the purpose of supplying useful thermal energy for heating and/or producing electricity, or for any other purpose, or the firing of fuel in a boiler after a shutdown event for any purpose. Startup ends when any of the useful thermal energy from the boiler or process heater is supplied for heating, and/or producing electricity, or for any other purpose, or

(2) The period in which operation of a boiler or process heater is initiated for any purpose. Startup begins with either the first-ever firing of fuel in a boiler or process heater for the purpose of supplying useful thermal energy (such as steam or heat) for heating, cooling or process purposes, or producing electricity, or the firing of fuel in a boiler or process heater for any purpose after a shutdown event. Startup ends four hours after when the boiler or process heater supplies useful thermal energy (such as heat or steam) for heating, cooling, or process purposes, or generates electricity, whichever is earlier.

*Steam output* means:

(1) For a boiler that produces steam for process or heating only (no power generation), the energy content in terms of MMBtu of the boiler steam output,

(2) For a boiler that cogenerates process steam and electricity (also known as combined heat and power), the total energy output, which is the sum of the energy content of the steam exiting the turbine and sent to process in MMBtu and the energy of the electricity generated converted to MMBtu at a rate of 10,000 Btu per kilowatt-hour generated (10 MMBtu per megawatt-hour), and

(3) For a boiler that generates only electricity, the alternate output-based emission limits would be the appropriate emission limit from Table 1 or 2 of this subpart in units of pounds per million Btu heat input (lb per MWh).

(4) For a boiler that performs multiple functions and produces steam to be used for any combination of paragraphs (1), (2), and (3) of this definition that includes electricity generation of paragraph (3) of this definition, the total energy output, in terms of MMBtu of steam output, is the sum of the energy content of steam sent directly to the process and/or used for heating ( $S_1$ ), the energy content of turbine steam sent to process plus energy in electricity according to paragraph (2) of this definition ( $S_2$ ), and the energy content of electricity generated by a electricity only turbine as paragraph (3) of this definition ( $MW_{(3)}$ ) and would be calculated using Equation 21 of this section. In the case of boilers supplying steam to one or more common heaters,  $S_1$ ,  $S_2$ , and  $MW_{(3)}$  for each boiler would be calculated based on the its (steam energy) contribution (fraction of total steam energy) to the common heater.

$$SO_M = S_1 + S_2 + (MW_{(3)} \times CFn) \quad (\text{Eq. 21})$$

[View or download PDF](#)

Where:

$SO_M$  = Total steam output for multi-function boiler, MMBtu

$S_1$  = Energy content of steam sent directly to the process and/or used for heating, MMBtu

$S_2$  = Energy content of turbine steam sent to the process plus energy in electricity according to (2) above, MMBtu

$MW_{(3)}$  = Electricity generated according to paragraph (3) of this definition, MWh

CFn = Conversion factor for the appropriate subcategory for converting electricity generated according to paragraph (3) of this definition to equivalent steam energy, MMBtu/MWh

CFn for emission limits for boilers in the unit designed to burn solid fuel subcategory = 10.8

CFn PM and CO emission limits for boilers in one of the subcategories of units designed to burn coal = 11.7

CFn PM and CO emission limits for boilers in one of the subcategories of units designed to burn biomass = 12.1

CFn for emission limits for boilers in one of the subcategories of units designed to burn liquid fuel = 11.2

CFn for emission limits for boilers in the unit designed to burn gas 2 (other) subcategory = 6.2

*Stoker* means a unit consisting of a mechanically operated fuel feeding mechanism, a stationary or moving grate to support the burning of fuel and admit under-grate air to the fuel, an overfire air system to complete combustion, and an ash discharge system. This definition of stoker includes air swept stokers. There are two general types of stokers: Underfeed and overfeed. Overfeed stokers include mass feed and spreader stokers. Fluidized bed, dutch oven, pile burner, hybrid suspension grate, suspension burners, and fuel cells are not considered to be a stoker design.

*Stoker/sloped grate/other unit designed to burn kiln dried biomass* means the unit is in the units designed to burn biomass/bio-based solid subcategory that is either a stoker, sloped grate, or other combustor design and is not in the stoker/sloped grate/other units designed to burn wet biomass subcategory.

*Stoker/sloped grate/other unit designed to burn wet biomass* means the unit is in the units designed to burn biomass/bio-based solid subcategory that is either a stoker, sloped grate, or other combustor design and any of the biomass/bio-based solid fuel combusted in the unit exceeds 20 percent moisture on an annual heat input basis.

*Suspension burner* means a unit designed to fire dry biomass/biobased solid particles in suspension that are conveyed in an airstream to the furnace like pulverized coal. The combustion of the fuel material is completed on a grate or floor below. The biomass/biobased fuel combusted in the unit shall not exceed 20 percent moisture on an annual heat input basis. Fluidized bed, dutch oven, pile burner, and hybrid suspension grate units are not part of the suspension burner subcategory.

*Temporary boiler* means any gaseous or liquid fuel boiler or process heater that is designed to, and is capable of, being carried or moved from one location to another by means of, for example, wheels, skids, carrying handles, dollies, trailers, or platforms. A boiler or process heater is not a temporary boiler or process heater if any one of the following conditions exists:

(1) The equipment is attached to a foundation.

(2) The boiler or process heater or a replacement remains at a location within the facility and performs the same or similar function for more than 12 consecutive months, unless the regulatory agency approves an extension. An extension may be granted by the regulating agency upon petition by the owner or operator of a unit specifying the basis for such a request. Any temporary boiler or process heater that replaces a temporary boiler or process heater at a location and performs the same or similar function will be included in calculating the consecutive time period.

(3) The equipment is located at a seasonal facility and operates during the full annual operating period of the seasonal facility, remains at the facility for at least 2 years, and operates at that facility for at least 3 months each year.

(4) The equipment is moved from one location to another within the facility but continues to perform the same or similar function and serve the same electricity, process heat, steam, and/or hot water system in an attempt to circumvent the residence time requirements of this definition.

*Total selected metals (TSM)* means the sum of the following metallic hazardous air pollutants: arsenic, beryllium, cadmium, chromium, lead, manganese, nickel and selenium.

*Traditional fuel* means the fuel as defined in §241.2 of this chapter.

*Tune-up* means adjustments made to a boiler or process heater in accordance with the procedures outlined in §63.7540(a)(10).

*Ultra low sulfur liquid fuel* means a distillate oil that has less than or equal to 15 ppm sulfur.

*Unit designed to burn biomass/bio-based solid subcategory* includes any boiler or process heater that burns at least 10 percent biomass or bio-based solids on an annual heat input basis in combination with solid fossil fuels, liquid fuels, or gaseous fuels.

*Unit designed to burn coal/solid fossil fuel subcategory* includes any boiler or process heater that burns any coal or other solid fossil fuel alone or at least 10 percent coal or other solid fossil fuel on an annual heat input basis in combination with liquid fuels, gaseous fuels, or less than 10 percent biomass and bio-based solids on an annual heat input basis.

*Unit designed to burn gas 1 subcategory* includes any boiler or process heater that burns only natural gas, refinery gas, and/or other gas 1 fuels. Gaseous fuel boilers and process heaters that burn liquid fuel for periodic testing of liquid fuel, maintenance, or operator training, not to exceed a combined total of 48 hours during any calendar year, are included in this definition. Gaseous fuel boilers and process heaters that burn liquid fuel during periods of gas curtailment or gas supply interruptions of any duration are also included in this definition.

*Unit designed to burn gas 2 (other) subcategory* includes any boiler or process heater that is not in the unit designed to burn gas 1 subcategory and burns any gaseous fuels either alone or in combination with less than 10 percent coal/solid fossil fuel, and less than 10 percent biomass/bio-based solid fuel on an annual heat input basis, and no liquid fuels. Gaseous fuel boilers and process heaters that are not in the unit designed to burn gas 1 subcategory and that burn liquid fuel for periodic testing of liquid fuel, maintenance, or operator training, not to exceed a combined total of 48 hours during any calendar year,

are included in this definition. Gaseous fuel boilers and process heaters that are not in the unit designed to burn gas 1 subcategory and that burn liquid fuel during periods of gas curtailment or gas supply interruption of any duration are also included in this definition.

*Unit designed to burn heavy liquid subcategory* means a unit in the unit designed to burn liquid subcategory where at least 10 percent of the heat input from liquid fuels on an annual heat input basis comes from heavy liquids.

*Unit designed to burn light liquid subcategory* means a unit in the unit designed to burn liquid subcategory that is not part of the unit designed to burn heavy liquid subcategory.

*Unit designed to burn liquid subcategory* includes any boiler or process heater that burns any liquid fuel, but less than 10 percent coal/solid fossil fuel and less than 10 percent biomass/bio-based solid fuel on an annual heat input basis, either alone or in combination with gaseous fuels. Units in the unit design to burn gas 1 or unit designed to burn gas 2 (other) subcategories that burn liquid fuel for periodic testing of liquid fuel, maintenance, or operator training, not to exceed a combined total of 48 hours during any calendar year are not included in this definition. Units in the unit design to burn gas 1 or unit designed to burn gas 2 (other) subcategories during periods of gas curtailment or gas supply interruption of any duration are also not included in this definition.

*Unit designed to burn liquid fuel that is a non-continental unit* means an industrial, commercial, or institutional boiler or process heater meeting the definition of the unit designed to burn liquid subcategory located in the State of Hawaii, the Virgin Islands, Guam, American Samoa, the Commonwealth of Puerto Rico, or the Northern Mariana Islands.

*Unit designed to burn solid fuel subcategory* means any boiler or process heater that burns only solid fuels or at least 10 percent solid fuel on an annual heat input basis in combination with liquid fuels or gaseous fuels.

*Useful thermal energy* means energy (*i.e.*, steam, hot water, or process heat) that meets the minimum operating temperature, flow, and/or pressure required by any energy use system that uses energy provided by the affected boiler or process heater.

*Vegetable oil* means oils extracted from vegetation.

*Voluntary Consensus Standards or VCS* mean technical standards (*e.g.*, materials specifications, test methods, sampling procedures, business practices) developed or adopted by one or more voluntary consensus bodies. EPA/Office of Air Quality Planning and Standards, by precedent, has only used VCS that are written in English. Examples of VCS bodies are: American Society of Testing and Materials (ASTM 100 Barr Harbor Drive, P.O. Box CB700, West Conshohocken, Pennsylvania 19428-B2959, (800) 262-1373, <http://www.astm.org>), American Society of Mechanical Engineers (ASME ASME, Three Park Avenue, New York, NY 10016-5990, (800) 843-2763, <http://www.asme.org>), International Standards Organization (ISO 1, ch. de la Voie-Creuse, Case postale 56, CH-1211 Geneva 20, Switzerland, + 41 22 749 01 11, <http://www.iso.org/iso/home.htm>), Standards Australia (AS Level 10, The Exchange Centre, 20 Bridge Street, Sydney, GPO Box 476, Sydney NSW 2001, + 61 2 9237 6171 <http://www.stadards.org.au>), British Standards Institution (BSI, 389 Chiswick High Road, London, W4 4AL, United Kingdom, + 44 (0)20 8996 9001, <http://www.bsigroup.com>), Canadian Standards



Association (CSA 5060 Spectrum Way, Suite 100, Mississauga, Ontario L4W 5N6, Canada, 800-463-6727, <http://www.csa.ca>), European Committee for Standardization (CEN CENELEC Management Centre Avenue Marnix 17 B-1000 Brussels, Belgium + 32 2 550 08 11, <http://www.cen.eu/cen>), and German Engineering Standards (VDI VDI Guidelines Department, P.O. Box 10 11 39 40002, Duesseldorf, Germany, + 49 211 6214-230, <http://www.vdi.eu>). The types of standards that are not considered VCS are standards developed by: The United States, *e.g.*, California (CARB) and Texas (TCEQ); industry groups, such as American Petroleum Institute (API), Gas Processors Association (GPA), and Gas Research Institute (GRI); and other branches of the U.S. government, *e.g.*, Department of Defense (DOD) and Department of Transportation (DOT). This does not preclude EPA from using standards developed by groups that are not VCS bodies within their rule. When this occurs, EPA has done searches and reviews for VCS equivalent to these non-EPA methods.

*Waste heat boiler* means a device that recovers normally unused energy (i.e., hot exhaust gas) and converts it to usable heat. Waste heat boilers are also referred to as heat recovery steam generators. Waste heat boilers are heat exchangers generating steam from incoming hot exhaust gas from an industrial (e.g., thermal oxidizer, kiln, furnace) or power (e.g., combustion turbine, engine) equipment. Duct burners are sometimes used to increase the temperature of the incoming hot exhaust gas.

*Waste heat process heater* means an enclosed device that recovers normally unused energy (i.e., hot exhaust gas) and converts it to usable heat. Waste heat process heaters are also referred to as recuperative process heaters. This definition includes both fired and unfired waste heat process heaters.

*Wet scrubber* means any add-on air pollution control device that mixes an aqueous stream or slurry with the exhaust gases from a boiler or process heater to control emissions of particulate matter or to absorb and neutralize acid gases, such as hydrogen chloride. A wet scrubber creates an aqueous stream or slurry as a byproduct of the emissions control process.

*Work practice standard* means any design, equipment, work practice, or operational standard, or combination thereof, that is promulgated pursuant to section 112(h) of the Clean Air Act.

[78 FR 15664, Mar. 21, 2011, as amended at 78 FR 7163, Jan. 31, 2013; 80 FR 72817, Nov. 20, 2015]

[↑ Back to Top](#)

**Table 1 to Subpart DDDDD of Part 63—Emission Limits for New or Reconstructed Boilers and Process Heaters**

As stated in §63.7500, you must comply with the following applicable emission limits:

[Units with heat input capacity of 10 million Btu per hour or greater]

If your boiler or process heater is in this subcategory . . .	For the following pollutants . . .	The emissions must not exceed the following emission limits, except during startup and shutdown	Or the emissions must not exceed the following alternative output-based limits, except	Using this specified sampling volume or test run duration . . .

		. . .	<b>during startup and shutdown . . .</b>	
1. Units in all subcategories designed to burn solid fuel.	a. HCl	2.2E-02 lb per MMBtu of heat input	2.5E-02 lb per MMBtu of steam output or 0.28 lb per MWh	For M26A, collect a minimum of 1 dscm per run; for M26 collect a minimum of 120 liters per run.
	b. Mercury	8.0E-07 <sup>a</sup> lb per MMBtu of heat input	8.7E-07 <sup>a</sup> lb per MMBtu of steam output or 1.1E-05 <sup>a</sup> lb per MWh	For M29, collect a minimum of 4 dscm per run; for M30A or M30B, collect a minimum sample as specified in the method; for ASTM D6784 <sup>b</sup> collect a minimum of 4 dscm.
2. Units designed to burn coal/solid fossil fuel	a. Filterable PM (or TSM)	1.1E-03 lb per MMBtu of heat input; or (2.3E-05 lb per MMBtu of heat input)	1.1E-03 lb per MMBtu of steam output or 1.4E-02 lb per MWh; or (2.7E-05 lb per MMBtu of steam output or 2.9E-04 lb per MWh)	Collect a minimum of 3 dscm per run.
3. Pulverized coal boilers designed to burn coal/solid fossil fuel	a. Carbon monoxide (CO) (or CEMS)	130 ppm by volume on a dry basis corrected to 3 percent oxygen, 3-run average; or (320 ppm by volume on a dry basis corrected to 3 percent oxygen, <sup>d</sup> 30-day rolling average)	0.11 lb per MMBtu of steam output or 1.4 lb per MWh; 3-run average	1 hr minimum sampling time.
4. Stokers/others designed to burn coal/solid fossil fuel	a. CO (or CEMS)	130 ppm by volume on a dry basis corrected to 3 percent oxygen, 3-run average; or (340 ppm by volume on a dry basis corrected to 3 percent	0.12 lb per MMBtu of steam output or 1.4 lb per MWh; 3-run average	1 hr minimum sampling time.

		oxygen, <sup>d</sup> 30-day rolling average)		
5. Fluidized bed units designed to burn coal/solid fossil fuel	a. CO (or CEMS)	130 ppm by volume on a dry basis corrected to 3 percent oxygen, 3-run average; or (230 ppm by volume on a dry basis corrected to 3 percent oxygen, <sup>d</sup> 30-day rolling average)	0.11 lb per MMBtu of steam output or 1.4 lb per MWh; 3-run average	1 hr minimum sampling time.
6. Fluidized bed units with an integrated heat exchanger designed to burn coal/solid fossil fuel	a. CO (or CEMS)	140 ppm by volume on a dry basis corrected to 3 percent oxygen, 3-run average; or (150 ppm by volume on a dry basis corrected to 3 percent oxygen, <sup>d</sup> 30-day rolling average)	1.2E-01 lb per MMBtu of steam output or 1.5 lb per MWh; 3-run average	1 hr minimum sampling time.
7. Stokers/sloped grate/others designed to burn wet biomass fuel	a. CO (or CEMS)	620 ppm by volume on a dry basis corrected to 3 percent oxygen, 3-run average; or (390 ppm by volume on a dry basis corrected to 3 percent oxygen, <sup>d</sup> 30-day rolling average)	5.8E-01 lb per MMBtu of steam output or 6.8 lb per MWh; 3-run average	1 hr minimum sampling time.
	b. Filterable PM (or TSM)	3.0E-02 lb per MMBtu of heat input; or (2.6E-05 lb per MMBtu of heat input)	3.5E-02 lb per MMBtu of steam output or 4.2E-01 lb per MWh; or (2.7E-05 lb per MMBtu of steam output or 3.7E-04 lb per MWh)	Collect a minimum of 2 dscm per run.
8. Stokers/sloped grate/others designed to burn kiln-dried biomass fuel	a. CO	460 ppm by volume on a dry basis corrected to 3 percent oxygen	4.2E-01 lb per MMBtu of steam output or 5.1 lb per MWh	1 hr minimum sampling time.

	b. Filterable PM (or TSM)	3.0E-02 lb per MMBtu of heat input; or (4.0E-03 lb per MMBtu of heat input)	3.5E-02 lb per MMBtu of steam output or 4.2E-01 lb per MWh; or (4.2E-03 lb per MMBtu of steam output or 5.6E-02 lb per MWh)	Collect a minimum of 2 dscm per run.
9. Fluidized bed units designed to burn biomass/bio-based solids	a. CO (or CEMS)	230 ppm by volume on a dry basis corrected to 3 percent oxygen, 3-run average; or (310 ppm by volume on a dry basis corrected to 3 percent oxygen, <sup>d</sup> 30-day rolling average)	2.2E-01 lb per MMBtu of steam output or 2.6 lb per MWh; 3-run average	1 hr minimum sampling time.
	b. Filterable PM (or TSM)	9.8E-03 lb per MMBtu of heat input; or (8.3E-05 <sup>a</sup> lb per MMBtu of heat input)	1.2E-02 lb per MMBtu of steam output or 0.14 lb per MWh; or (1.1E-04 <sup>a</sup> lb per MMBtu of steam output or 1.2E-03 <sup>a</sup> lb per MWh)	Collect a minimum of 3 dscm per run.
10. Suspension burners designed to burn biomass/bio-based solids	a. CO (or CEMS)	2,400 ppm by volume on a dry basis corrected to 3 percent oxygen, 3-run average; or (2,000 ppm by volume on a dry basis corrected to 3 percent oxygen, <sup>d</sup> 10-day rolling average)	1.9 lb per MMBtu of steam output or 27 lb per MWh; 3-run average	1 hr minimum sampling time.
	b. Filterable PM (or TSM)	3.0E-02 lb per MMBtu of heat input; or (6.5E-03 lb per MMBtu of heat input)	3.1E-02 lb per MMBtu of steam output or 4.2E-01 lb per MWh; or (6.6E-03 lb per MMBtu of steam output or 9.1E-02 lb per MWh)	Collect a minimum of 2 dscm per run.

11. Dutch Ovens/Pile burners designed to burn biomass/bio-based solids	a. CO (or CEMS)	330 ppm by volume on a dry basis corrected to 3 percent oxygen, 3-run average; or (520 ppm by volume on a dry basis corrected to 3 percent oxygen, <sup>d</sup> 10-day rolling average)	3.5E-01 lb per MMBtu of steam output or 3.6 lb per MWh; 3-run average	1 hr minimum sampling time.
	b. Filterable PM (or TSM)	3.2E-03 lb per MMBtu of heat input; or (3.9E-05 lb per MMBtu of heat input)	4.3E-03 lb per MMBtu of steam output or 4.5E-02 lb per MWh; or (5.2E-05 lb per MMBtu of steam output or 5.5E-04 lb per MWh)	Collect a minimum of 3 dscm per run.
12. Fuel cell units designed to burn biomass/bio-based solids	a. CO	910 ppm by volume on a dry basis corrected to 3 percent oxygen	1.1 lb per MMBtu of steam output or 1.0E + 01 lb per MWh	1 hr minimum sampling time.
	b. Filterable PM (or TSM)	2.0E-02 lb per MMBtu of heat input; or (2.9E-05 <sup>a</sup> lb per MMBtu of heat input)	3.0E-02 lb per MMBtu of steam output or 2.8E-01 lb per MWh; or (5.1E-05 lb per MMBtu of steam output or 4.1E-04 lb per MWh)	Collect a minimum of 2 dscm per run.
13. Hybrid suspension grate boiler designed to burn biomass/bio-based solids	a. CO (or CEMS)	1,100 ppm by volume on a dry basis corrected to 3 percent oxygen, 3-run average; or (900 ppm by volume on a dry basis corrected to 3 percent oxygen, <sup>d</sup> 30-day rolling average)	1.4 lb per MMBtu of steam output or 12 lb per MWh; 3-run average	1 hr minimum sampling time.
	b. Filterable PM (or TSM)	2.6E-02 lb per MMBtu of heat input; or (4.4E-04 lb per MMBtu of	3.3E-02 lb per MMBtu of steam output or 3.7E-01 lb	Collect a minimum of 3 dscm per run.

		heat input)	per MWh; or (5.5E-04 lb per MMBtu of steam output or 6.2E-03 lb per MWh)	
14. Units designed to burn liquid fuel	a. HCl	4.4E-04 lb per MMBtu of heat input	4.8E-04 lb per MMBtu of steam output or 6.1E-03 lb per MWh	For M26A: Collect a minimum of 2 dscm per run; for M26, collect a minimum of 240 liters per run.
	b. Mercury	4.8E-07 <sup>a</sup> lb per MMBtu of heat input	5.3E-07 <sup>a</sup> lb per MMBtu of steam output or 6.7E-06 <sup>a</sup> lb per MWh	For M29, collect a minimum of 4 dscm per run; for M30A or M30B, collect a minimum sample as specified in the method; for ASTM D6784 <sup>b</sup> collect a minimum of 4 dscm.
15. Units designed to burn heavy liquid fuel	a. CO	130 ppm by volume on a dry basis corrected to 3 percent oxygen, 3-run average	0.13 lb per MMBtu of steam output or 1.4 lb per MWh; 3-run average	1 hr minimum sampling time.
	b. Filterable PM (or TSM)	1.3E-02 lb per MMBtu of heat input; or (7.5E-05 lb per MMBtu of heat input)	1.5E-02 lb per MMBtu of steam output or 1.8E-01 lb per MWh; or (8.2E-05 lb per MMBtu of steam output or 1.1E-03 lb per MWh)	Collect a minimum of 3 dscm per run.
16. Units designed to burn light liquid fuel	a. CO	130 ppm by volume on a dry basis corrected to 3 percent oxygen	0.13 lb per MMBtu of steam output or 1.4 lb per MWh	1 hr minimum sampling time.
	b. Filterable PM (or TSM)	1.1E-03 <sup>a</sup> lb per MMBtu of heat input; or (2.9E-05 lb per MMBtu of heat input)	1.2E-03 <sup>a</sup> lb per MMBtu of steam output or 1.6E-02 <sup>a</sup> lb per MWh; or (3.2E-	Collect a minimum of 3 dscm per run.

			05 lb per MMBtu of steam output or 4.0E-04 lb per MWh)	
17. Units designed to burn liquid fuel that are non-continental units	a. CO	130 ppm by volume on a dry basis corrected to 3 percent oxygen, 3-run average based on stack test	0.13 lb per MMBtu of steam output or 1.4 lb per MWh; 3-run average	1 hr minimum sampling time.
	b. Filterable PM (or TSM)	2.3E-02 lb per MMBtu of heat input; or (8.6E-04 lb per MMBtu of heat input)	2.5E-02 lb per MMBtu of steam output or 3.2E-01 lb per MWh; or (9.4E-04 lb per MMBtu of steam output or 1.2E-02 lb per MWh)	Collect a minimum of 4 dscm per run.
18. Units designed to burn gas 2 (other) gases	a. CO	130 ppm by volume on a dry basis corrected to 3 percent oxygen	0.16 lb per MMBtu of steam output or 1.0 lb per MWh	1 hr minimum sampling time.
	b. HCl	1.7E-03 lb per MMBtu of heat input	2.9E-03 lb per MMBtu of steam output or 1.8E-02 lb per MWh	For M26A, Collect a minimum of 2 dscm per run; for M26, collect a minimum of 240 liters per run.
	c. Mercury	7.9E-06 lb per MMBtu of heat input	1.4E-05 lb per MMBtu of steam output or 8.3E-05 lb per MWh	For M29, collect a minimum of 3 dscm per run; for M30A or M30B, collect a minimum sample as specified in the method; for ASTM D6784 <sup>b</sup> collect a minimum of 3 dscm.
	d. Filterable PM (or TSM)	6.7E-03 lb per MMBtu of heat input; or (2.1E-04 lb per MMBtu of heat input)	1.2E-02 lb per MMBtu of steam output or 7.0E-02 lb per MWh; or (3.5E-	Collect a minimum of 3 dscm per run.

			04 lb per MMBtu of steam output or 2.2E-03 lb per MWh)	
--	--	--	--	--

<sup>a</sup>If you are conducting stack tests to demonstrate compliance and your performance tests for this pollutant for at least 2 consecutive years show that your emissions are at or below this limit, you can skip testing according to §63.7515 if all of the other provisions of §63.7515 are met. For all other pollutants that do not contain a footnote “a”, your performance tests for this pollutant for at least 2 consecutive years must show that your emissions are at or below 75 percent of this limit in order to qualify for skip testing.

<sup>b</sup>Incorporated by reference, see §63.14.

<sup>c</sup>If your affected source is a new or reconstructed affected source that commenced construction or reconstruction after June 4, 2010, and before April 1, 2013, you may comply with the emission limits in Tables 11, 12 or 13 to this subpart until January 31, 2016. On and after January 31, 2016, you must comply with the emission limits in Table 1 to this subpart.

<sup>d</sup>An owner or operator may request an alternative test method under §63.7 of this chapter, in order that compliance with the carbon monoxide emissions limit be determined using carbon dioxide as a diluent correction in place of oxygen at 3%. EPA Method 19 F-factors and EPA Method 19 equations must be used to generate the appropriate CO<sub>2</sub> correction percentage for the fuel type burned in the unit, and must also take into account that the 3% oxygen correction is to be done on a dry basis. The alternative test method request must account for any CO<sub>2</sub> being added to, or removed from, the emissions gas stream as a result of limestone injection, scrubber media, etc.

[78 FR 7193, Jan. 31, 2013, as amended at 80 FR 72819, Nov. 20, 2015]

[↑ Back to Top](#)

**Table 2 to Subpart DDDDD of Part 63—Emission Limits for Existing Boilers and Process Heaters**

As stated in §63.7500, you must comply with the following applicable emission limits:

[Units with heat input capacity of 10 million Btu per hour or greater]

<b>If your boiler or process heater is in this subcategory . . .</b>	<b>For the following pollutants . . .</b>	<b>The emissions must not exceed the following emission limits, except during startup and shutdown . . .</b>	<b>The emissions must not exceed the following alternative output-based limits, except during startup and shutdown . . .</b>	<b>Using this specified sampling volume or test run duration . . .</b>
1. Units in all subcategories designed to burn	a. HCl	2.2E-02 lb per MMBtu of heat input	2.5E-02 lb per MMBtu of steam output or 0.27 lb per	For M26A, Collect a minimum of 1 dscm per run; for M26,



solid fuel			MWh	collect a minimum of 120 liters per run.
	b. Mercury	5.7E-06 lb per MMBtu of heat input	6.4E-06 lb per MMBtu of steam output or 7.3E-05 lb per MWh	For M29, collect a minimum of 3 dscm per run; for M30A or M30B, collect a minimum sample as specified in the method; for ASTM D6784 <sup>b</sup> collect a minimum of 3 dscm.
2. Units design to burn coal/solid fossil fuel	a. Filterable PM (or TSM)	4.0E-02 lb per MMBtu of heat input; or (5.3E-05 lb per MMBtu of heat input)	4.2E-02 lb per MMBtu of steam output or 4.9E-01 lb per MWh; or (5.6E-05 lb per MMBtu of steam output or 6.5E-04 lb per MWh)	Collect a minimum of 2 dscm per run.
3. Pulverized coal boilers designed to burn coal/solid fossil fuel	a. CO (or CEMS)	130 ppm by volume on a dry basis corrected to 3 percent oxygen, 3-run average; or (320 ppm by volume on a dry basis corrected to 3 percent oxygen, <sup>c</sup> 30-day rolling average)	0.11 lb per MMBtu of steam output or 1.4 lb per MWh; 3-run average	1 hr minimum sampling time.
4. Stokers/others designed to burn coal/solid fossil fuel	a. CO (or CEMS)	160 ppm by volume on a dry basis corrected to 3 percent oxygen, 3-run average; or (340 ppm by volume on a dry basis corrected to 3 percent oxygen, <sup>c</sup> 30-day rolling average)	0.14 lb per MMBtu of steam output or 1.7 lb per MWh; 3-run average	1 hr minimum sampling time.
5. Fluidized bed units designed to burn coal/solid fossil	a. CO (or CEMS)	130 ppm by volume on a dry basis corrected to 3 percent oxygen, 3-run	0.12 lb per MMBtu of steam output or 1.4 lb per MWh; 3-run	1 hr minimum sampling time.

fuel		average; or (230 ppm by volume on a dry basis corrected to 3 percent oxygen, <sup>c</sup> 30-day rolling average)	average	
6. Fluidized bed units with an integrated heat exchanger designed to burn coal/solid fossil fuel	a. CO (or CEMS)	140 ppm by volume on a dry basis corrected to 3 percent oxygen, 3-run average; or (150 ppm by volume on a dry basis corrected to 3 percent oxygen, <sup>c</sup> 30-day rolling average)	1.3E-01 lb per MMBtu of steam output or 1.5 lb per MWh; 3-run average	1 hr minimum sampling time.
7. Stokers/sloped grate/others designed to burn wet biomass fuel	a. CO (or CEMS)	1,500 ppm by volume on a dry basis corrected to 3 percent oxygen, 3-run average; or (720 ppm by volume on a dry basis corrected to 3 percent oxygen, <sup>c</sup> 30-day rolling average)	1.4 lb per MMBtu of steam output or 17 lb per MWh; 3-run average	1 hr minimum sampling time.
	b. Filterable PM (or TSM)	3.7E-02 lb per MMBtu of heat input; or (2.4E-04 lb per MMBtu of heat input)	4.3E-02 lb per MMBtu of steam output or 5.2E-01 lb per MWh; or (2.8E-04 lb per MMBtu of steam output or 3.4E-04 lb per MWh)	Collect a minimum of 2 dscm per run.
8. Stokers/sloped grate/others designed to burn kiln-dried biomass fuel	a. CO	460 ppm by volume on a dry basis corrected to 3 percent oxygen	4.2E-01 lb per MMBtu of steam output or 5.1 lb per MWh	1 hr minimum sampling time.
	b. Filterable PM (or TSM)	3.2E-01 lb per MMBtu of heat input; or (4.0E-03 lb per MMBtu of heat input)	3.7E-01 lb per MMBtu of steam output or 4.5 lb per MWh; or (4.6E-03 lb per MMBtu of steam	Collect a minimum of 1 dscm per run.

			output or 5.6E-02 lb per MWh)	
9. Fluidized bed units designed to burn biomass/bio-based solid	a. CO (or CEMS)	470 ppm by volume on a dry basis corrected to 3 percent oxygen, 3-run average; or (310 ppm by volume on a dry basis corrected to 3 percent oxygen, <sup>c</sup> 30-day rolling average)	4.6E-01 lb per MMBtu of steam output or 5.2 lb per MWh; 3-run average	1 hr minimum sampling time.
	b. Filterable PM (or TSM)	1.1E-01 lb per MMBtu of heat input; or (1.2E-03 lb per MMBtu of heat input)	1.4E-01 lb per MMBtu of steam output or 1.6 lb per MWh; or (1.5E-03 lb per MMBtu of steam output or 1.7E-02 lb per MWh)	Collect a minimum of 1 dscm per run.
10. Suspension burners designed to burn biomass/bio-based solid	a. CO (or CEMS)	2,400 ppm by volume on a dry basis corrected to 3 percent oxygen, 3-run average; or (2,000 ppm by volume on a dry basis corrected to 3 percent oxygen, <sup>c</sup> 10-day rolling average)	1.9 lb per MMBtu of steam output or 27 lb per MWh; 3-run average	1 hr minimum sampling time.
	b. Filterable PM (or TSM)	5.1E-02 lb per MMBtu of heat input; or (6.5E-03 lb per MMBtu of heat input)	5.2E-02 lb per MMBtu of steam output or 7.1E-01 lb per MWh; or (6.6E-03 lb per MMBtu of steam output or 9.1E-02 lb per MWh)	Collect a minimum of 2 dscm per run.
11. Dutch Ovens/Pile burners designed to burn biomass/bio-based solid	a. CO (or CEMS)	770 ppm by volume on a dry basis corrected to 3 percent oxygen, 3-run average; or (520 ppm by volume on a dry basis	8.4E-01 lb per MMBtu of steam output or 8.4 lb per MWh; 3-run average	1 hr minimum sampling time.

		corrected to 3 percent oxygen, <sup>c</sup> 10-day rolling average)		
	b. Filterable PM (or TSM)	2.8E-01 lb per MMBtu of heat input; or (2.0E-03 lb per MMBtu of heat input)	3.9E-01 lb per MMBtu of steam output or 3.9 lb per MWh; or (2.8E-03 lb per MMBtu of steam output or 2.8E-02 lb per MWh)	Collect a minimum of 1 dscm per run.
12. Fuel cell units designed to burn biomass/bio-based solid	a. CO	1,100 ppm by volume on a dry basis corrected to 3 percent oxygen	2.4 lb per MMBtu of steam output or 12 lb per MWh	1 hr minimum sampling time.
	b. Filterable PM (or TSM)	2.0E-02 lb per MMBtu of heat input; or (5.8E-03 lb per MMBtu of heat input)	5.5E-02 lb per MMBtu of steam output or 2.8E-01 lb per MWh; or (1.6E-02 lb per MMBtu of steam output or 8.1E-02 lb per MWh)	Collect a minimum of 2 dscm per run.
13. Hybrid suspension grate units designed to burn biomass/bio-based solid	a. CO (or CEMS)	3,500 ppm by volume on a dry basis corrected to 3 percent oxygen, 3-run average; or (900 ppm by volume on a dry basis corrected to 3 percent oxygen, <sup>c</sup> 30-day rolling average)	3.5 lb per MMBtu of steam output or 39 lb per MWh; 3-run average	1 hr minimum sampling time.
	b. Filterable PM (or TSM)	4.4E-01 lb per MMBtu of heat input; or (4.5E-04 lb per MMBtu of heat input)	5.5E-01 lb per MMBtu of steam output or 6.2 lb per MWh; or (5.7E-04 lb per MMBtu of steam output or 6.3E-03 lb per MWh)	Collect a minimum of 1 dscm per run.

14. Units designed to burn liquid fuel	a. HCl	1.1E-03 lb per MMBtu of heat input	1.4E-03 lb per MMBtu of steam output or 1.6E-02 lb per MWh	For M26A, collect a minimum of 2 dscm per run; for M26, collect a minimum of 240 liters per run.
	b. Mercury	2.0E-06 <sup>a</sup> lb per MMBtu of heat input	2.5E-06 <sup>a</sup> lb per MMBtu of steam output or 2.8E-05 lb per MWh	For M29, collect a minimum of 3 dscm per run; for M30A or M30B collect a minimum sample as specified in the method, for ASTM D6784, <sup>b</sup> collect a minimum of 2 dscm.
15. Units designed to burn heavy liquid fuel	a. CO	130 ppm by volume on a dry basis corrected to 3 percent oxygen, 3-run average	0.13 lb per MMBtu of steam output or 1.4 lb per MWh; 3-run average	1 hr minimum sampling time.
	b. Filterable PM (or TSM)	6.2E-02 lb per MMBtu of heat input; or (2.0E-04 lb per MMBtu of heat input)	7.5E-02 lb per MMBtu of steam output or 8.6E-01 lb per MWh; or (2.5E-04 lb per MMBtu of steam output or 2.8E-03 lb per MWh)	Collect a minimum of 1 dscm per run.
16. Units designed to burn light liquid fuel	a. CO	130 ppm by volume on a dry basis corrected to 3 percent oxygen	0.13 lb per MMBtu of steam output or 1.4 lb per MWh	1 hr minimum sampling time.
	b. Filterable PM (or TSM)	7.9E-03 <sup>a</sup> lb per MMBtu of heat input; or (6.2E-05 lb per MMBtu of heat input)	9.6E-03 <sup>a</sup> lb per MMBtu of steam output or 1.1E-01 <sup>a</sup> lb per MWh; or (7.5E-05 lb per MMBtu of steam output or 8.6E-04 lb per MWh)	Collect a minimum of 3 dscm per run.
17. Units designed to	a. CO	130 ppm by volume on a	0.13 lb per MMBtu of	1 hr minimum

burn liquid fuel that are non-continental units		dry basis corrected to 3 percent oxygen, 3-run average based on stack test	steam output or 1.4 lb per MWh; 3-run average	sampling time.
	b. Filterable PM (or TSM)	2.7E-01 lb per MMBtu of heat input; or (8.6E-04 lb per MMBtu of heat input)	3.3E-01 lb per MMBtu of steam output or 3.8 lb per MWh; or (1.1E-03 lb per MMBtu of steam output or 1.2E-02 lb per MWh)	Collect a minimum of 2 dscm per run.
18. Units designed to burn gas 2 (other) gases	a. CO	130 ppm by volume on a dry basis corrected to 3 percent oxygen	0.16 lb per MMBtu of steam output or 1.0 lb per MWh	1 hr minimum sampling time.
	b. HCl	1.7E-03 lb per MMBtu of heat input	2.9E-03 lb per MMBtu of steam output or 1.8E-02 lb per MWh	For M26A, collect a minimum of 2 dscm per run; for M26, collect a minimum of 240 liters per run.
	c. Mercury	7.9E-06 lb per MMBtu of heat input	1.4E-05 lb per MMBtu of steam output or 8.3E-05 lb per MWh	For M29, collect a minimum of 3 dscm per run; for M30A or M30B, collect a minimum sample as specified in the method; for ASTM D6784 <sup>b</sup> collect a minimum of 2 dscm.
	d. Filterable PM (or TSM)	6.7E-03 lb per MMBtu of heat input or (2.1E-04 lb per MMBtu of heat input)	1.2E-02 lb per MMBtu of steam output or 7.0E-02 lb per MWh; or (3.5E-04 lb per MMBtu of steam output or 2.2E-03 lb per MWh)	Collect a minimum of 3 dscm per run.

<sup>a</sup>If you are conducting stack tests to demonstrate compliance and your performance tests for this pollutant for at least 2 consecutive years show that your emissions are at or below this limit, you can skip testing

according to §63.7515 if all of the other provisions of §63.7515 are met. For all other pollutants that do not contain a footnote a, your performance tests for this pollutant for at least 2 consecutive years must show that your emissions are at or below 75 percent of this limit in order to qualify for skip testing.

<sup>b</sup>Incorporated by reference, see §63.14.

<sup>c</sup>An owner or operator may request an alternative test method under §63.7 of this chapter, in order that compliance with the carbon monoxide emissions limit be determined using carbon dioxide as a diluent correction in place of oxygen at 3%. EPA Method 19 F-factors and EPA Method 19 equations must be used to generate the appropriate CO<sub>2</sub> correction percentage for the fuel type burned in the unit, and must also take into account that the 3% oxygen correction is to be done on a dry basis. The alternative test method request must account for any CO<sub>2</sub> being added to, or removed from, the emissions gas stream as a result of limestone injection, scrubber media, etc.

[78 FR 7195, Jan. 31, 2013, as amended at 80 FR 72821, Nov. 20, 2015]

[↑ Back to Top](#)

**Table 3 to Subpart DDDDD of Part 63—Work Practice Standards**

As stated in §63.7500, you must comply with the following applicable work practice standards:

<b>If your unit is . . .</b>	<b>You must meet the following . . .</b>
1. A new or existing boiler or process heater with a continuous oxygen trim system that maintains an optimum air to fuel ratio, or a heat input capacity of less than or equal to 5 million Btu per hour in any of the following subcategories: unit designed to burn gas 1; unit designed to burn gas 2 (other); or unit designed to burn light liquid, or a limited use boiler or process heater	Conduct a tune-up of the boiler or process heater every 5 years as specified in §63.7540.
2. A new or existing boiler or process heater without a continuous oxygen trim system and with heat input capacity of less than 10 million Btu per hour in the unit designed to burn heavy liquid or unit designed to burn solid fuel subcategories; or a new or existing boiler or process heater with heat input capacity of less than 10 million Btu per hour, but greater than 5 million Btu per hour, in any of the following subcategories: unit designed to burn gas 1; unit designed to burn gas 2 (other); or unit designed to burn light liquid	Conduct a tune-up of the boiler or process heater biennially as specified in §63.7540.

<p>3. A new or existing boiler or process heater without a continuous oxygen trim system and with heat input capacity of 10 million Btu per hour or greater</p>	<p>Conduct a tune-up of the boiler or process heater annually as specified in §63.7540. Units in either the Gas 1 or Metal Process Furnace subcategories will conduct this tune-up as a work practice for all regulated emissions under this subpart. Units in all other subcategories will conduct this tune-up as a work practice for dioxins/furans.</p>
<p>4. An existing boiler or process heater located at a major source facility, not including limited use units</p>	<p>Must have a one-time energy assessment performed by a qualified energy assessor. An energy assessment completed on or after January 1, 2008, that meets or is amended to meet the energy assessment requirements in this table, satisfies the energy assessment requirement. A facility that operated under an energy management program developed according to the ENERGY STAR guidelines for energy management or compatible with ISO 50001 for at least one year between January 1, 2008 and the compliance date specified in §63.7495 that includes the affected units also satisfies the energy assessment requirement. The energy assessment must include the following with extent of the evaluation for items a. to e. appropriate for the on-site technical hours listed in §63.7575:</p>
	<p>a. A visual inspection of the boiler or process heater system.</p>
	<p>b. An evaluation of operating characteristics of the boiler or process heater systems, specifications of energy using systems, operating and maintenance procedures, and unusual operating constraints.</p>
	<p>c. An inventory of major energy use systems consuming energy from affected boilers and process heaters and which are under the control of the boiler/process heater owner/operator.</p>
	<p>d. A review of available architectural and engineering plans, facility operation and maintenance procedures and logs, and fuel usage.</p>
	<p>e. A review of the facility's energy management</p>



	<p>program and provide recommendations for improvements consistent with the definition of energy management program, if identified.</p>
	<p>f. A list of cost-effective energy conservation measures that are within the facility's control.</p>
	<p>g. A list of the energy savings potential of the energy conservation measures identified.</p>
	<p>h. A comprehensive report detailing the ways to improve efficiency, the cost of specific improvements, benefits, and the time frame for recouping those investments.</p>
<p>5. An existing or new boiler or process heater subject to emission limits in Table 1 or 2 or 11 through 13 to this subpart during startup</p>	<p>a. You must operate all CMS during startup.</p> <p>b. For startup of a boiler or process heater, you must use one or a combination of the following clean fuels: Natural gas, synthetic natural gas, propane, other Gas 1 fuels, distillate oil, syngas, ultra-low sulfur diesel, fuel oil-soaked rags, kerosene, hydrogen, paper, cardboard, refinery gas, liquefied petroleum gas, clean dry biomass, and any fuels meeting the appropriate HCl, mercury and TSM emission standards by fuel analysis.</p> <p>c. You have the option of complying using either of the following work practice standards.</p> <p>(1) If you choose to comply using definition (1) of "startup" in §63.7575, once you start firing fuels that are not clean fuels, you must vent emissions to the main stack(s) and engage all of the applicable control devices except limestone injection in fluidized bed combustion (FBC) boilers, dry scrubber, fabric filter, and selective catalytic reduction (SCR). You must start your limestone injection in FBC boilers, dry scrubber, fabric filter, and SCR systems as expeditiously as possible. Startup ends when steam or heat is supplied for any purpose, OR</p> <p>(2) If you choose to comply using definition (2) of "startup" in §63.7575, once you start to feed fuels that are not clean fuels, you must vent emissions to the main stack(s) and engage all of the applicable control devices so as to comply with the emission limits</p>

	<p>within 4 hours of start of supplying useful thermal energy. You must engage and operate PM control within one hour of first feeding fuels that are not clean fuels<sup>a</sup>. You must start all applicable control devices as expeditiously as possible, but, in any case, when necessary to comply with other standards applicable to the source by a permit limit or a rule other than this subpart that require operation of the control devices. You must develop and implement a written startup and shutdown plan, as specified in §63.7505(e).</p> <p>d. You must comply with all applicable emission limits at all times except during startup and shutdown periods at which time you must meet this work practice. You must collect monitoring data during periods of startup, as specified in §63.7535(b). You must keep records during periods of startup. You must provide reports concerning activities and periods of startup, as specified in §63.7555.</p>
<p>6. An existing or new boiler or process heater subject to emission limits in Tables 1 or 2 or 11 through 13 to this subpart during shutdown</p>	<p>You must operate all CMS during shutdown. While firing fuels that are not clean fuels during shutdown, you must vent emissions to the main stack(s) and operate all applicable control devices, except limestone injection in FBC boilers, dry scrubber, fabric filter, and SCR but, in any case, when necessary to comply with other standards applicable to the source that require operation of the control device.</p> <p>If, in addition to the fuel used prior to initiation of shutdown, another fuel must be used to support the shutdown process, that additional fuel must be one or a combination of the following clean fuels: Natural gas, synthetic natural gas, propane, other Gas 1 fuels, distillate oil, syngas, ultra-low sulfur diesel, refinery gas, and liquefied petroleum gas.</p> <p>You must comply with all applicable emissions limits at all times except for startup or shutdown periods conforming with this work practice. You must collect monitoring data during periods of shutdown, as specified in §63.7535(b). You must keep records during periods of shutdown. You must provide reports concerning activities and periods of shutdown, as</p>

	specified in §63.7555.
--	------------------------

<sup>a</sup>As specified in §63.7555(d)(13), the source may request an alternative timeframe with the PM controls requirement to the permitting authority (state, local, or tribal agency) that has been delegated authority for this subpart by EPA. The source must provide evidence that (1) it is unable to safely engage and operate the PM control(s) to meet the “fuel firing + 1 hour” requirement and (2) the PM control device is appropriately designed and sized to meet the filterable PM emission limit. It is acknowledged that there may be another control device that has been installed other than ESP that provides additional PM control (e.g., scrubber).

[78 FR 7198, Jan. 31, 2013, as amended at 80 FR 72823, Nov. 20, 2015]

[↑ Back to Top](#)

**Table 4 to Subpart DDDDD of Part 63—Operating Limits for Boilers and Process Heaters**

As stated in §63.7500, you must comply with the applicable operating limits:

**Table 4 to Subpart DDDDD of Part 63—Operating Limits for Boilers and Process Heaters**

<b>When complying with a Table 1, 2, 11, 12, or 13 numerical emission limit using . . .</b>	<b>You must meet these operating limits . . .</b>
1. Wet PM scrubber control on a boiler or process heater not using a PM CPMS	Maintain the 30-day rolling average pressure drop and the 30-day rolling average liquid flow rate at or above the lowest one-hour average pressure drop and the lowest one-hour average liquid flow rate, respectively, measured during the performance test demonstrating compliance with the PM emission limitation according to §63.7530(b) and Table 7 to this subpart.
2. Wet acid gas (HCl) scrubber <sup>a</sup> control on a boiler or process heater not using a HCl CEMS	Maintain the 30-day rolling average effluent pH at or above the lowest one-hour average pH and the 30-day rolling average liquid flow rate at or above the lowest one-hour average liquid flow rate measured during the performance test demonstrating compliance with the HCl emission limitation according to §63.7530(b) and Table 7 to this subpart.
3. Fabric filter control on a boiler or process heater not using a PM CPMS	a. Maintain opacity to less than or equal to 10 percent opacity or the highest hourly average opacity reading measured during the performance test run demonstrating compliance with the PM (or TSM) emission limitation (daily block average); or
	b. Install and operate a bag leak detection system according to §63.7525 and operate the fabric filter such that the bag leak detection system alert is not

	activated more than 5 percent of the operating time during each 6-month period.
4. Electrostatic precipitator control on a boiler or process heater not using a PM CPMS	a. This option is for boilers and process heaters that operate dry control systems ( <i>i.e.</i> , an ESP without a wet scrubber). Existing and new boilers and process heaters must maintain opacity to less than or equal to 10 percent opacity or the highest hourly average opacity reading measured during the performance test run demonstrating compliance with the PM (or TSM) emission limitation (daily block average).
	b. This option is only for boilers and process heaters not subject to PM CPMS or continuous compliance with an opacity limit ( <i>i.e.</i> , dry ESP). Maintain the 30-day rolling average total secondary electric power input of the electrostatic precipitator at or above the operating limits established during the performance test according to §63.7530(b) and Table 7 to this subpart.
5. Dry scrubber or carbon injection control on a boiler or process heater not using a mercury CEMS	Maintain the minimum sorbent or carbon injection rate as defined in §63.7575 of this subpart.
6. Any other add-on air pollution control type on a boiler or process heater not using a PM CPMS	This option is for boilers and process heaters that operate dry control systems. Existing and new boilers and process heaters must maintain opacity to less than or equal to 10 percent opacity or the highest hourly average opacity reading measured during the performance test run demonstrating compliance with the PM (or TSM) emission limitation (daily block average).
7. Performance testing	For boilers and process heaters that demonstrate compliance with a performance test, maintain the 30-day rolling average operating load of each unit such that it does not exceed 110 percent of the highest hourly average operating load recorded during the performance test.
8. Oxygen analyzer system	For boilers and process heaters subject to a CO emission limit that demonstrate compliance with an O <sub>2</sub> analyzer system as specified in §63.7525(a), maintain the 30-day rolling average oxygen content at or above the lowest hourly average oxygen concentration measured during the CO performance test, as specified in Table 8. This requirement does not apply to units that install an oxygen trim system since these units will set the trim system to the level specified in §63.7525(a).

9. SO <sub>2</sub> CEMS	For boilers or process heaters subject to an HCl emission limit that demonstrate compliance with an SO <sub>2</sub> CEMS, maintain the 30-day rolling average SO <sub>2</sub> emission rate at or below the highest hourly average SO <sub>2</sub> concentration measured during the HCl performance test, as specified in Table 8.
-------------------------	---

<sup>a</sup>A wet acid gas scrubber is a control device that removes acid gases by contacting the combustion gas with an alkaline slurry or solution. Alkaline reagents include, but not limited to, lime, limestone and sodium.

[80 FR 72874, Nov. 20, 2015]

[↑ Back to Top](#)

**Table 5 to Subpart DDDDD of Part 63—Performance Testing Requirements**

As stated in §63.7520, you must comply with the following requirements for performance testing for existing, new or reconstructed affected sources:

<b>To conduct a performance test for the following pollutant . . .</b>	<b>You must. . .</b>	<b>Using, as appropriate . . .</b>
1. Filterable PM	a. Select sampling ports location and the number of traverse points	Method 1 at 40 CFR part 60, appendix A-1 of this chapter.
	b. Determine velocity and volumetric flow-rate of the stack gas	Method 2, 2F, or 2G at 40 CFR part 60, appendix A-1 or A-2 to part 60 of this chapter.
	c. Determine oxygen or carbon dioxide concentration of the stack gas	Method 3A or 3B at 40 CFR part 60, appendix A-2 to part 60 of this chapter, or ANSI/ASME PTC 19.10-1981. <sup>a</sup>
	d. Measure the moisture content of the stack gas	Method 4 at 40 CFR part 60, appendix A-3 of this chapter.
	e. Measure the PM emission concentration	Method 5 or 17 (positive pressure fabric filters must use Method 5D) at 40 CFR part 60, appendix A-3 or A-6 of this chapter.

	f. Convert emissions concentration to lb per MMBtu emission rates	Method 19 F-factor methodology at 40 CFR part 60, appendix A-7 of this chapter.
2. TSM	a. Select sampling ports location and the number of traverse points	Method 1 at 40 CFR part 60, appendix A-1 of this chapter.
	b. Determine velocity and volumetric flow-rate of the stack gas	Method 2, 2F, or 2G at 40 CFR part 60, appendix A-1 or A-2 of this chapter.
	c. Determine oxygen or carbon dioxide concentration of the stack gas	Method 3A or 3B at 40 CFR part 60, appendix A-1 of this chapter, or ANSI/ASME PTC 19.10-1981. <sup>a</sup>
	d. Measure the moisture content of the stack gas	Method 4 at 40 CFR part 60, appendix A-3 of this chapter.
	e. Measure the TSM emission concentration	Method 29 at 40 CFR part 60, appendix A-8 of this chapter
	f. Convert emissions concentration to lb per MMBtu emission rates	Method 19 F-factor methodology at 40 CFR part 60, appendix A-7 of this chapter.
3. Hydrogen chloride	a. Select sampling ports location and the number of traverse points	Method 1 at 40 CFR part 60, appendix A-1 of this chapter.
	b. Determine velocity and volumetric flow-rate of the stack gas	Method 2, 2F, or 2G at 40 CFR part 60, appendix A-2 of this chapter.
	c. Determine oxygen or carbon dioxide concentration of the stack gas	Method 3A or 3B at 40 CFR part 60, appendix A-2 of this chapter, or ANSI/ASME PTC 19.10-1981. <sup>a</sup>
	d. Measure the moisture	Method 4 at 40 CFR part 60, appendix A-3 of this

	content of the stack gas	chapter.
	e. Measure the hydrogen chloride emission concentration	Method 26 or 26A (M26 or M26A) at 40 CFR part 60, appendix A-8 of this chapter.
	f. Convert emissions concentration to lb per MMBtu emission rates	Method 19 F-factor methodology at 40 CFR part 60, appendix A-7 of this chapter.
4. Mercury	a. Select sampling ports location and the number of traverse points	Method 1 at 40 CFR part 60, appendix A-1 of this chapter.
	b. Determine velocity and volumetric flow-rate of the stack gas	Method 2, 2F, or 2G at 40 CFR part 60, appendix A-1 or A-2 of this chapter.
	c. Determine oxygen or carbon dioxide concentration of the stack gas	Method 3A or 3B at 40 CFR part 60, appendix A-1 of this chapter, or ANSI/ASME PTC 19.10-1981. <sup>a</sup>
	d. Measure the moisture content of the stack gas	Method 4 at 40 CFR part 60, appendix A-3 of this chapter.
	e. Measure the mercury emission concentration	Method 29, 30A, or 30B (M29, M30A, or M30B) at 40 CFR part 60, appendix A-8 of this chapter or Method 101A at 40 CFR part 61, appendix B of this chapter, or ASTM Method D6784. <sup>a</sup>
	f. Convert emissions concentration to lb per MMBtu emission rates	Method 19 F-factor methodology at 40 CFR part 60, appendix A-7 of this chapter.
5. CO	a. Select the sampling ports location and the number of traverse points	Method 1 at 40 CFR part 60, appendix A-1 of this chapter.
	b. Determine oxygen concentration of the stack	Method 3A or 3B at 40 CFR part 60, appendix A-3 of this chapter, or ASTM D6522-00 (Reapproved

	gas	2005), or ANSI/ASME PTC 19.10-1981. <sup>a</sup>
	c. Measure the moisture content of the stack gas	Method 4 at 40 CFR part 60, appendix A-3 of this chapter.
	d. Measure the CO emission concentration	Method 10 at 40 CFR part 60, appendix A-4 of this chapter. Use a measurement span value of 2 times the concentration of the applicable emission limit.

<sup>a</sup>Incorporated by reference, see §63.14.

[76 FR 15664, Mar. 21, 2011, as amended at 78 FR 7200, Jan. 31, 2013; 80 FR 72825, Nov. 20, 2015]

[↑ Back to Top](#)

### Table 6 to Subpart DDDDD of Part 63—Fuel Analysis Requirements

As stated in §63.7521, you must comply with the following requirements for fuel analysis testing for existing, new or reconstructed affected sources. However, equivalent methods (as defined in §63.7575) may be used in lieu of the prescribed methods at the discretion of the source owner or operator:

<b>To conduct a fuel analysis for the following pollutant . . .</b>	<b>You must . . .</b>	<b>Using . . .</b>
1. Mercury	a. Collect fuel samples	Procedure in §63.7521(c) or ASTM D5192, <sup>a</sup> or ASTM D7430, <sup>a</sup> or ASTM D6883, <sup>a</sup> or ASTM D2234/D2234M <sup>a</sup> (for coal) or ASTM D6323 <sup>a</sup> (for solid), or ASTM D4177 <sup>a</sup> (for liquid), or ASTM D4057 <sup>a</sup> (for liquid), or equivalent.
	b. Composite fuel samples	Procedure in §63.7521(d) or equivalent.
	c. Prepare composited fuel samples	EPA SW-846-3050B <sup>a</sup> (for solid samples), ASTM D2013/D2013M <sup>a</sup> (for coal), ASTM D5198 <sup>a</sup> (for biomass), or EPA 3050 <sup>a</sup> (for solid fuel), or EPA 821-R-01-013 <sup>a</sup> (for liquid or solid), or equivalent.
	d. Determine heat content of the fuel type	ASTM D5865 <sup>a</sup> (for coal) or ASTM E711 <sup>a</sup> (for biomass), or ASTM D5864 <sup>a</sup> for liquids and other solids, or ASTM D240 <sup>a</sup> or equivalent.



	e. Determine moisture content of the fuel type	ASTM D3173, <sup>a</sup> ASTM E871, <sup>a</sup> or ASTM D5864, <sup>a</sup> or ASTM D240, or ASTM D95 <sup>a</sup> (for liquid fuels), or ASTM D4006 <sup>a</sup> (for liquid fuels), or equivalent.
	f. Measure mercury concentration in fuel sample	ASTM D6722 <sup>a</sup> (for coal), EPA SW-846-7471B <sup>a</sup> or EPA 1631 or EPA 1631E (for solid samples), or EPA SW-846-7470A <sup>a</sup> (for liquid samples), or EPA 821-R-01-013 (for liquid or solid), or equivalent.
	g. Convert concentration into units of pounds of mercury per MMBtu of heat content	For fuel mixtures use Equation 8 in §63.7530.
2. HCl	a. Collect fuel samples	Procedure in §63.7521(c) or ASTM D5192, <sup>a</sup> or ASTM D7430, <sup>a</sup> or ASTM D6883, <sup>a</sup> or ASTM D2234/D2234M <sup>a</sup> (for coal) or ASTM D6323 <sup>a</sup> (for coal or biomass), ASTM D4177 <sup>a</sup> (for liquid fuels) or ASTM D4057 <sup>a</sup> (for liquid fuels), or equivalent.
	b. Composite fuel samples	Procedure in §63.7521(d) or equivalent.
	c. Prepare composited fuel samples	EPA SW-846-3050B <sup>a</sup> (for solid samples), ASTM D2013/D2013M <sup>a</sup> (for coal), or ASTM D5198 <sup>a</sup> (for biomass), or EPA 3050 <sup>a</sup> or equivalent.
	d. Determine heat content of the fuel type	ASTM D5865 <sup>a</sup> (for coal) or ASTM E711 <sup>a</sup> (for biomass), ASTM D5864, ASTM D240 <sup>a</sup> or equivalent.
	e. Determine moisture content of the fuel type	ASTM D3173 <sup>a</sup> or ASTM E871, <sup>a</sup> or D5864, <sup>a</sup> or ASTM D240, <sup>a</sup> or ASTM D95 <sup>a</sup> (for liquid fuels), or ASTM D4006 <sup>a</sup> (for liquid fuels), or equivalent.
	f. Measure chlorine concentration in fuel sample	EPA SW-846-9250, <sup>a</sup> ASTM D6721, <sup>a</sup> ASTM D4208 <sup>a</sup> (for coal), or EPA SW-846-5050 <sup>a</sup> or ASTM E776 <sup>a</sup> (for solid fuel), or EPA SW-846-9056 <sup>a</sup> or SW-846-9076 <sup>a</sup> (for solids or liquids) or equivalent.
	g. Convert concentrations into units of pounds of HCl per MMBtu of heat content	For fuel mixtures use Equation 7 in §63.7530 and convert from chlorine to HCl by multiplying by 1.028.

3. Mercury Fuel Specification for other gas 1 fuels	a. Measure mercury concentration in the fuel sample and convert to units of micrograms per cubic meter, or	Method 30B (M30B) at 40 CFR part 60, appendix A-8 of this chapter or ASTM D5954, <sup>a</sup> ASTM D6350, <sup>a</sup> ISO 6978-1:2003(E), <sup>a</sup> or ISO 6978-2:2003(E), <sup>a</sup> or EPA-1631 <sup>a</sup> or equivalent.
	b. Measure mercury concentration in the exhaust gas when firing only the other gas 1 fuel is fired in the boiler or process heater	Method 29, 30A, or 30B (M29, M30A, or M30B) at 40 CFR part 60, appendix A-8 of this chapter or Method 101A or Method 102 at 40 CFR part 61, appendix B of this chapter, or ASTM Method D6784 <sup>a</sup> or equivalent.
4. TSM	a. Collect fuel samples	Procedure in §63.7521(c) or ASTM D5192, <sup>a</sup> or ASTM D7430, <sup>a</sup> or ASTM D6883, <sup>a</sup> or ASTM D2234/D2234M <sup>a</sup> (for coal) or ASTM D6323 <sup>a</sup> (for coal or biomass), or ASTM D4177, <sup>a</sup> (for liquid fuels) or ASTM D4057 <sup>a</sup> (for liquid fuels), or equivalent.
	b. Composite fuel samples	Procedure in §63.7521(d) or equivalent.
	c. Prepare composited fuel samples	EPA SW-846-3050B <sup>a</sup> (for solid samples), ASTM D2013/D2013M <sup>a</sup> (for coal), ASTM D5198 <sup>a</sup> or TAPPI T266 <sup>a</sup> (for biomass), or EPA 3050 <sup>a</sup> or equivalent.
	d. Determine heat content of the fuel type	ASTM D5865 <sup>a</sup> (for coal) or ASTM E711 <sup>a</sup> (for biomass), or ASTM D5864 <sup>a</sup> for liquids and other solids, or ASTM D240 <sup>a</sup> or equivalent.
	e. Determine moisture content of the fuel type	ASTM D3173 <sup>a</sup> or ASTM E871, <sup>a</sup> or D5864, or ASTM D240, <sup>a</sup> or ASTM D95 <sup>a</sup> (for liquid fuels), or ASTM D4006 <sup>a</sup> (for liquid fuels), or ASTM D4177 <sup>a</sup> (for liquid fuels) or ASTM D4057 <sup>a</sup> (for liquid fuels), or equivalent.
	f. Measure TSM concentration in fuel sample	ASTM D3683, <sup>a</sup> or ASTM D4606, <sup>a</sup> or ASTM D6357 <sup>a</sup> or EPA 200.8 <sup>a</sup> or EPA SW-846-6020, <sup>a</sup> or EPA SW-846-6020A, <sup>a</sup> or EPA SW-846-6010C, <sup>a</sup> EPA 7060 <sup>a</sup> or EPA 7060A <sup>a</sup> (for arsenic only), or EPA SW-846-7740 <sup>a</sup> (for selenium only).

	g. Convert concentrations into units of pounds of TSM per MMBtu of heat content	For fuel mixtures use Equation 9 in §63.7530.
--	---	---

<sup>a</sup>Incorporated by reference, see §63.14.

[80 FR 72825, Nov. 20, 2015]

[↑ Back to Top](#)

**Table 7 to Subpart DDDDD of Part 63—Establishing Operating Limits<sup>ab</sup>**

As stated in §63.7520, you must comply with the following requirements for establishing operating limits:

**Table 7 to Subpart DDDDD of Part 63—Establishing Operating Limits<sup>ab</sup>**

<b>If you have an applicable emission limit for . . .</b>	<b>And your operating limits are based on . . .</b>	<b>You must . . .</b>	<b>Using . . .</b>	<b>According to the following requirements</b>
1. PM, TSM, or mercury	a. Wet scrubber operating parameters	i. Establish a site-specific minimum scrubber pressure drop and minimum flow rate operating limit according to §63.7530(b)	(1) Data from the scrubber pressure drop and liquid flow rate monitors and the PM, TSM, or mercury performance test	(a) You must collect scrubber pressure drop and liquid flow rate data every 15 minutes during the entire period of the performance tests. (b) Determine the lowest hourly average scrubber pressure drop and liquid flow rate by computing the hourly averages using all of the 15-minute readings taken during each performance test.
	b. Electrostatic precipitator operating parameters (option only for units that operate wet scrubbers)	i. Establish a site-specific minimum total secondary electric power input according to §63.7530(b)	(1) Data from the secondary voltage and secondary amperage monitors during the PM or mercury	(a) You must collect secondary voltage and secondary amperage for each ESP cell and calculate total secondary electric power input data every 15 minutes during the entire period of the performance

			performance test	tests. (b) Determine the average total secondary electric power input by computing the hourly averages using all of the 15-minute readings taken during each performance test.
	c. Opacity	i. Establish a site-specific maximum opacity level	(1) Data from the opacity monitoring system during the PM performance test	(a) You must collect opacity readings every 15 minutes during the entire period of the performance tests. (b) Determine the average hourly opacity reading for each performance test run by computing the hourly averages using all of the 15-minute readings taken during each performance test run. (c) Determine the highest hourly average opacity reading measured during the test run demonstrating compliance with the PM (or TSM) emission limitation.
2. HCl	a. Wet scrubber operating parameters	i. Establish site-specific minimum effluent pH and flow rate operating limits according to §63.7530(b)	(1) Data from the pH and liquid flow-rate monitors and the HCl performance test	(a) You must collect pH and liquid flow-rate data every 15 minutes during the entire period of the performance tests. (b) Determine the hourly average pH and liquid flow rate by computing the hourly averages using all of the 15-minute readings taken during each performance test.

	b. Dry scrubber operating parameters	i. Establish a site-specific minimum sorbent injection rate operating limit according to §63.7530(b). If different acid gas sorbents are used during the HCl performance test, the average value for each sorbent becomes the site-specific operating limit for that sorbent	(1) Data from the sorbent injection rate monitors and HCl or mercury performance test	(a) You must collect sorbent injection rate data every 15 minutes during the entire period of the performance tests. (b) Determine the hourly average sorbent injection rate by computing the hourly averages using all of the 15-minute readings taken during each performance test. (c) Determine the lowest hourly average of the three test run averages established during the performance test as your operating limit. When your unit operates at lower loads, multiply your sorbent injection rate by the load fraction, as defined in §63.7575, to determine the required injection rate.
	c. Alternative Maximum SO <sub>2</sub> emission rate	i. Establish a site-specific maximum SO <sub>2</sub> emission rate operating limit according to §63.7530(b)	(1) Data from SO <sub>2</sub> CEMS and the HCl performance test	(a) You must collect the SO <sub>2</sub> emissions data according to §63.7525(m) during the most recent HCl performance tests. (b) The maximum SO <sub>2</sub> emission rate is equal to the highest hourly average SO <sub>2</sub> emission rate measured during the most recent HCl performance tests.
3. Mercury	a. Activated carbon injection	i. Establish a site-specific minimum activated carbon injection rate operating limit according to	(1) Data from the activated carbon rate monitors and mercury	(a) You must collect activated carbon injection rate data every 15 minutes during the entire period of the performance tests.

		§63.7530(b)	performance test	(b) Determine the hourly average activated carbon injection rate by computing the hourly averages using all of the 15-minute readings taken during each performance test. (c) Determine the lowest hourly average established during the performance test as your operating limit. When your unit operates at lower loads, multiply your activated carbon injection rate by the load fraction, as defined in §63.7575, to determine the required injection rate.
4. Carbon monoxide for which compliance is demonstrated by a performance test	a. Oxygen	i. Establish a unit-specific limit for minimum oxygen level according to §63.7530(b)	(1) Data from the oxygen analyzer system specified in §63.7525(a)	(a) You must collect oxygen data every 15 minutes during the entire period of the performance tests. (b) Determine the hourly average oxygen concentration by computing the hourly averages using all of the 15-minute readings taken during each performance test. (c) Determine the lowest hourly average established during the performance test as your minimum operating limit.
5. Any pollutant for which compliance is demonstrated by a performance	a. Boiler or process heater operating load	i. Establish a unit specific limit for maximum operating load according to §63.7520(c)	(1) Data from the operating load monitors or from steam generation	(a) You must collect operating load or steam generation data every 15 minutes during the entire period of the performance

test			monitors	test. (b) Determine the average operating load by computing the hourly averages using all of the 15-minute readings taken during each performance test. (c) Determine the highest hourly average of the three test run averages during the performance test, and multiply this by 1.1 (110 percent) as your operating limit.
------	--	--	----------	--

<sup>a</sup>Operating limits must be confirmed or reestablished during performance tests.

<sup>b</sup>If you conduct multiple performance tests, you must set the minimum liquid flow rate and pressure drop operating limits at the higher of the minimum values established during the performance tests. For a minimum oxygen level, if you conduct multiple performance tests, you must set the minimum oxygen level at the lower of the minimum values established during the performance tests.

[80 FR 72827, Nov. 20, 2015]

[↑ Back to Top](#)

**Table 8 to Subpart DDDDD of Part 63—Demonstrating Continuous Compliance**

As stated in §63.7540, you must show continuous compliance with the emission limitations for each boiler or process heater according to the following:

<b>If you must meet the following operating limits or work practice standards . . .</b>	<b>You must demonstrate continuous compliance by . . .</b>
1. Opacity	a. Collecting the opacity monitoring system data according to §63.7525(c) and §63.7535; and
	b. Reducing the opacity monitoring data to 6-minute averages; and
	c. Maintaining daily block average opacity to less than or equal to 10 percent or the highest hourly average opacity reading measured during the

	performance test run demonstrating compliance with the PM (or TSM) emission limitation.
2. PM CPMS	a. Collecting the PM CPMS output data according to §63.7525;
	b. Reducing the data to 30-day rolling averages; and
	c. Maintaining the 30-day rolling average PM CPMS output data to less than the operating limit established during the performance test according to §63.7530(b)(4).
3. Fabric Filter Bag Leak Detection Operation	Installing and operating a bag leak detection system according to §63.7525 and operating the fabric filter such that the requirements in §63.7540(a)(7) are met.
4. Wet Scrubber Pressure Drop and Liquid Flow-rate	a. Collecting the pressure drop and liquid flow rate monitoring system data according to §§63.7525 and 63.7535; and
	b. Reducing the data to 30-day rolling averages; and
	c. Maintaining the 30-day rolling average pressure drop and liquid flow-rate at or above the operating limits established during the performance test according to §63.7530(b).
5. Wet Scrubber pH	a. Collecting the pH monitoring system data according to §§63.7525 and 63.7535; and
	b. Reducing the data to 30-day rolling averages; and
	c. Maintaining the 30-day rolling average pH at or above the operating limit established during the performance test according to §63.7530(b).
6. Dry Scrubber Sorbent or Carbon Injection Rate	a. Collecting the sorbent or carbon injection rate monitoring system data for the dry scrubber according to §§63.7525 and 63.7535; and
	b. Reducing the data to 30-day rolling averages; and
	c. Maintaining the 30-day rolling average sorbent or carbon injection rate at or above the minimum sorbent or carbon injection rate as defined in §63.7575.



7. Electrostatic Precipitator Total Secondary Electric Power Input	a. Collecting the total secondary electric power input monitoring system data for the electrostatic precipitator according to §§63.7525 and 63.7535; and
	b. Reducing the data to 30-day rolling averages; and
	c. Maintaining the 30-day rolling average total secondary electric power input at or above the operating limits established during the performance test according to §63.7530(b).
8. Emission limits using fuel analysis	a. Conduct monthly fuel analysis for HCl or mercury or TSM according to Table 6 to this subpart; and
	b. Reduce the data to 12-month rolling averages; and
	c. Maintain the 12-month rolling average at or below the applicable emission limit for HCl or mercury or TSM in Tables 1 and 2 or 11 through 13 to this subpart.
	d. Calculate the HCl, mercury, and/or TSM emission rate from the boiler or process heater in units of lb/MMBtu using Equation 15 and Equations 17, 18, and/or 19 in §63.7530.
9. Oxygen content	a. Continuously monitor the oxygen content using an oxygen analyzer system according to §63.7525(a). This requirement does not apply to units that install an oxygen trim system since these units will set the trim system to the level specified in §63.7525(a)(7).
	b. Reducing the data to 30-day rolling averages; and
	c. Maintain the 30-day rolling average oxygen content at or above the lowest hourly average oxygen level measured during the CO performance test.
10. Boiler or process heater operating load	a. Collecting operating load data or steam generation data every 15 minutes.
	b. Reducing the data to 30-day rolling averages; and
	c. Maintaining the 30-day rolling average operating load such that it does not exceed 110 percent of the highest hourly average operating load recorded during the performance test according to §63.7520(c).

11. SO <sub>2</sub> emissions using SO <sub>2</sub> CEMS	a. Collecting the SO <sub>2</sub> CEMS output data according to §63.7525;
	b. Reducing the data to 30-day rolling averages; and
	c. Maintaining the 30-day rolling average SO <sub>2</sub> CEMS emission rate to a level at or below the highest hourly SO <sub>2</sub> rate measured during the HCl performance test according to §63.7530.

[78 FR 7204, Jan. 31, 2013, as amended at 80 FR 72829, Nov. 20, 2015]

[↑ Back to Top](#)

**Table 9 to Subpart DDDDD of Part 63—Reporting Requirements**

As stated in §63.7550, you must comply with the following requirements for reports:

<b>You must submit a(n)</b>	<b>The report must contain . . .</b>	<b>You must submit the report . . .</b>
1. Compliance report	a. Information required in §63.7550(c)(1) through (5); and	Semiannually, annually, biennially, or every 5 years according to the requirements in §63.7550(b).
	b. If there are no deviations from any emission limitation (emission limit and operating limit) that applies to you and there are no deviations from the requirements for work practice standards for periods of startup and shutdown in Table 3 to this subpart that apply to you, a statement that there were no deviations from the emission limitations and work practice standards during the reporting period. If there were no periods during which the CMSs, including continuous emissions monitoring system, continuous opacity monitoring system, and operating parameter monitoring systems, were out-of-control as specified in §63.8(c)(7), a statement that there were no periods during which the CMSs were out-of-control during the reporting period; and	
	c. If you have a deviation from any emission limitation (emission limit and operating limit) where you are not using a CMS to comply with that emission limit or operating limit, or a	

	deviation from a work practice standard for periods of startup and shutdown, during the reporting period, the report must contain the information in §63.7550(d); and	
	d. If there were periods during which the CMSs, including continuous emissions monitoring system, continuous opacity monitoring system, and operating parameter monitoring systems, were out-of-control as specified in §63.8(c)(7), or otherwise not operating, the report must contain the information in §63.7550(e)	

[76 FR 15664, Mar. 21, 2011, as amended at 78 FR 7205, Jan. 31, 2013; 80 FR 72830, Nov. 20, 2015]

[↑ Back to Top](#)

**Table 10 to Subpart DDDDD of Part 63—Applicability of General Provisions to Subpart DDDDD**

As stated in §63.7565, you must comply with the applicable General Provisions according to the following:

<b>Citation</b>	<b>Subject</b>	<b>Applies to subpart DDDDD</b>
§63.1	Applicability	Yes.
§63.2	Definitions	Yes. Additional terms defined in §63.7575
§63.3	Units and Abbreviations	Yes.
§63.4	Prohibited Activities and Circumvention	Yes.
§63.5	Preconstruction Review and Notification Requirements	Yes.
§63.6(a), (b)(1)-(b)(5), (b)(7), (c)	Compliance with Standards and Maintenance Requirements	Yes.
§63.6(e)(1)(i)	General duty to minimize emissions.	No. See §63.7500(a)(3) for the general duty requirement.

§63.6(e)(1)(ii)	Requirement to correct malfunctions as soon as practicable.	No.
§63.6(e)(3)	Startup, shutdown, and malfunction plan requirements.	No.
§63.6(f)(1)	Startup, shutdown, and malfunction exemptions for compliance with non-opacity emission standards.	No.
§63.6(f)(2) and (3)	Compliance with non-opacity emission standards.	Yes.
§63.6(g)	Use of alternative standards	Yes, except §63.7555(d)(13) specifies the procedure for application and approval of an alternative timeframe with the PM controls requirement in the startup work practice (2).
§63.6(h)(1)	Startup, shutdown, and malfunction exemptions to opacity standards.	No. See §63.7500(a).
§63.6(h)(2) to (h)(9)	Determining compliance with opacity emission standards	No. Subpart DDDDD specifies opacity as an operating limit not an emission standard.
§63.6(i)	Extension of compliance	Yes. Note: Facilities may also request extensions of compliance for the installation of combined heat and power, waste heat recovery, or gas pipeline or fuel feeding infrastructure as a means of complying with this subpart.
§63.6(j)	Presidential exemption.	Yes.

§63.7(a), (b), (c), and (d)	Performance Testing Requirements	Yes.
§63.7(e)(1)	Conditions for conducting performance tests	No. Subpart DDDDD specifies conditions for conducting performance tests at §63.7520(a) to (c).
§63.7(e)(2)-(e)(9), (f), (g), and (h)	Performance Testing Requirements	Yes.
§63.8(a) and (b)	Applicability and Conduct of Monitoring	Yes.
§63.8(c)(1)	Operation and maintenance of CMS	Yes.
§63.8(c)(1)(i)	General duty to minimize emissions and CMS operation	No. See §63.7500(a)(3).
§63.8(c)(1)(ii)	Operation and maintenance of CMS	Yes.
§63.8(c)(1)(iii)	Startup, shutdown, and malfunction plans for CMS	No.
§63.8(c)(2) to (c)(9)	Operation and maintenance of CMS	Yes.
§63.8(d)(1) and (2)	Monitoring Requirements, Quality Control Program	Yes.
§63.8(d)(3)	Written procedures for CMS	Yes, except for the last sentence, which refers to a startup, shutdown, and malfunction plan. Startup, shutdown, and malfunction plans are not required.
§63.8(e)	Performance evaluation of a CMS	Yes.

§63.8(f)	Use of an alternative monitoring method.	Yes.
§63.8(g)	Reduction of monitoring data	Yes.
§63.9	Notification Requirements	Yes.
§63.10(a), (b)(1)	Recordkeeping and Reporting Requirements	Yes.
§63.10(b)(2)(i)	Recordkeeping of occurrence and duration of startups or shutdowns	Yes.
§63.10(b)(2)(ii)	Recordkeeping of malfunctions	No. See §63.7555(d)(7) for recordkeeping of occurrence and duration and §63.7555(d)(8) for actions taken during malfunctions.
§63.10(b)(2)(iii)	Maintenance records	Yes.
§63.10(b)(2)(iv) and (v)	Actions taken to minimize emissions during startup, shutdown, or malfunction	No.
§63.10(b)(2)(vi)	Recordkeeping for CMS malfunctions	Yes.
§63.10(b)(2)(vii) to (xiv)	Other CMS requirements	Yes.
§63.10(b)(3)	Recordkeeping requirements for applicability determinations	No.
§63.10(c)(1) to (9)	Recordkeeping for sources with CMS	Yes.

§63.10(c)(10) and (11)	Recording nature and cause of malfunctions, and corrective actions	No. See §63.7555(d)(7) for recordkeeping of occurrence and duration and §63.7555(d)(8) for actions taken during malfunctions.
§63.10(c)(12) and (13)	Recordkeeping for sources with CMS	Yes.
§63.10(c)(15)	Use of startup, shutdown, and malfunction plan	No.
§63.10(d)(1) and (2)	General reporting requirements	Yes.
§63.10(d)(3)	Reporting opacity or visible emission observation results	No.
§63.10(d)(4)	Progress reports under an extension of compliance	Yes.
§63.10(d)(5)	Startup, shutdown, and malfunction reports	No. See §63.7550(c)(11) for malfunction reporting requirements.
§63.10(e)	Additional reporting requirements for sources with CMS	Yes.
§63.10(f)	Waiver of recordkeeping or reporting requirements	Yes.
§63.11	Control Device Requirements	No.
§63.12	State Authority and Delegation	Yes.
§63.13-63.16	Addresses, Incorporation by Reference, Availability of Information, Performance Track	Yes.

	Provisions	
§63.1(a)(5),(a)(7)-(a)(9), (b)(2), (c)(3)-(4), (d), 63.6(b)(6), (c)(3), (c)(4), (d), (e)(2), (e)(3)(ii), (h)(3), (h)(5)(iv), 63.8(a)(3), 63.9(b)(3), (h)(4), 63.10(c)(2)-(4), (c)(9).	Reserved	No.

[76 FR 15664, Mar. 21, 2011, as amended at 78 FR 7205, Jan. 31, 2013; 80 FR 72830, Nov. 20, 2015]

[↑ Back to Top](#)

**Table 11 to Subpart DDDDD of Part 63—Alternative Emission Limits for New or Reconstructed Boilers and Process Heaters That Commenced Construction or Reconstruction After June 4, 2010, and Before May 20, 2011**

<b>If your boiler or process heater is in this subcategory . . .</b>	<b>For the following pollutants . . .</b>	<b>The emissions must not exceed the following emission limits, except during periods of startup and shutdown . . .</b>	<b>Using this specified sampling volume or test run duration . . .</b>
1. Units in all subcategories designed to burn solid fuel	a. HCl	0.022 lb per MMBtu of heat input	For M26A, collect a minimum of 1 dscm per run; for M26 collect a minimum of 120 liters per run.
2. Units in all subcategories designed to burn solid fuel that combust at least 10 percent biomass/bio-based solids on an annual heat input basis and less than 10 percent coal/solid fossil fuels on an annual heat input basis	a. Mercury	8.0E-07 <sup>a</sup> lb per MMBtu of heat input	For M29, collect a minimum of 4 dscm per run; for M30A or M30B, collect a minimum sample as specified in the method; for ASTM D6784 <sup>b</sup> collect a minimum of 4 dscm.
3. Units in all subcategories designed to burn solid fuel that combust at least 10 percent coal/solid fossil fuels on an annual heat input basis and less than 10 percent biomass/bio-based solids on an annual heat input basis	a. Mercury	2.0E-06 lb per MMBtu of heat input	For M29, collect a minimum of 4 dscm per run; for M30A or M30B, collect a minimum sample as specified in the method; for ASTM D6784 <sup>b</sup> collect a minimum of 4 dscm.



4. Units design to burn coal/solid fossil fuel	a. Filterable PM (or TSM)	1.1E-03 lb per MMBtu of heat input; or (2.3E-05 lb per MMBtu of heat input)	Collect a minimum of 3 dscm per run.
5. Pulverized coal boilers designed to burn coal/solid fossil fuel	a. Carbon monoxide (CO) (or CEMS)	130 ppm by volume on a dry basis corrected to 3 percent oxygen, 3-run average; or (320 ppm by volume on a dry basis corrected to 3 percent oxygen, <sup>c</sup> 30-day rolling average)	1 hr minimum sampling time.
6. Stokers designed to burn coal/solid fossil fuel	a. CO (or CEMS)	130 ppm by volume on a dry basis corrected to 3 percent oxygen, 3-run average; or (340 ppm by volume on a dry basis corrected to 3 percent oxygen, <sup>c</sup> 10-day rolling average)	1 hr minimum sampling time.
7. Fluidized bed units designed to burn coal/solid fossil fuel	a. CO (or CEMS)	130 ppm by volume on a dry basis corrected to 3 percent oxygen, 3-run average; or (230 ppm by volume on a dry basis corrected to 3 percent oxygen, <sup>c</sup> 30-day rolling average)	1 hr minimum sampling time.
8. Fluidized bed units with an integrated heat exchanger designed to burn coal/solid fossil fuel	a. CO (or CEMS)	140 ppm by volume on a dry basis corrected to 3 percent oxygen, 3-run average; or (150 ppm by volume on a dry basis corrected to 3 percent oxygen, <sup>c</sup> 30-day rolling average)	1 hr minimum sampling time.
9. Stokers/sloped grate/others designed to burn wet biomass fuel	a. CO (or CEMS)	620 ppm by volume on a dry basis corrected to 3	1 hr minimum sampling time.

		percent oxygen, 3-run average; or (390 ppm by volume on a dry basis corrected to 3 percent oxygen, <sup>c</sup> 30-day rolling average)	
	b. Filterable PM (or TSM)	3.0E-02 lb per MMBtu of heat input; or (2.6E-05 lb per MMBtu of heat input)	Collect a minimum of 2 dscm per run.
10. Stokers/sloped grate/others designed to burn kiln-dried biomass fuel	a. CO	560 ppm by volume on a dry basis corrected to 3 percent oxygen, 3-run average	1 hr minimum sampling time.
	b. Filterable PM (or TSM)	3.0E-02 lb per MMBtu of heat input; or (4.0E-03 lb per MMBtu of heat input)	Collect a minimum of 2 dscm per run.
11. Fluidized bed units designed to burn biomass/bio-based solids	a. CO (or CEMS)	230 ppm by volume on a dry basis corrected to 3 percent oxygen, 3-run average; or (310 ppm by volume on a dry basis corrected to 3 percent oxygen, <sup>c</sup> 30-day rolling average)	1 hr minimum sampling time.
	b. Filterable PM (or TSM)	9.8E-03 lb per MMBtu of heat input; or (8.3E-05 <sup>a</sup> lb per MMBtu of heat input)	Collect a minimum of 3 dscm per run.
12. Suspension burners designed to burn biomass/bio-based solids	a. CO (or CEMS)	2,400 ppm by volume on a dry basis corrected to 3 percent oxygen, 3-run average; or (2,000 ppm by volume on a dry basis corrected to 3 percent oxygen, <sup>c</sup> 10-day rolling average)	1 hr minimum sampling time.

	b. Filterable PM (or TSM)	3.0E-02 lb per MMBtu of heat input; or (6.5E-03 lb per MMBtu of heat input)	Collect a minimum of 2 dscm per run.
13. Dutch Ovens/Pile burners designed to burn biomass/bio-based solids	a. CO (or CEMS)	1,010 ppm by volume on a dry basis corrected to 3 percent oxygen, 3-run average; or (520 ppm by volume on a dry basis corrected to 3 percent oxygen, <sup>c</sup> 10-day rolling average)	1 hr minimum sampling time.
	b. Filterable PM (or TSM)	8.0E-03 lb per MMBtu of heat input; or (3.9E-05 lb per MMBtu of heat input)	Collect a minimum of 3 dscm per run.
14. Fuel cell units designed to burn biomass/bio-based solids	a. CO	910 ppm by volume on a dry basis corrected to 3 percent oxygen, 3-run average	1 hr minimum sampling time.
	b. Filterable PM (or TSM)	2.0E-02 lb per MMBtu of heat input; or (2.9E-05 lb per MMBtu of heat input)	Collect a minimum of 2 dscm per run.
15. Hybrid suspension grate boiler designed to burn biomass/bio-based solids	a. CO (or CEMS)	1,100 ppm by volume on a dry basis corrected to 3 percent oxygen, 3-run average; or (900 ppm by volume on a dry basis corrected to 3 percent oxygen, <sup>c</sup> 30-day rolling average)	1 hr minimum sampling time.
	b. Filterable PM (or TSM)	2.6E-02 lb per MMBtu of heat input; or (4.4E-04 lb per MMBtu of heat input)	Collect a minimum of 3 dscm per run.
16. Units designed to burn liquid fuel	a. HCl	4.4E-04 lb per MMBtu of heat input	For M26A: Collect a minimum of 2 dscm per run; for M26, collect a

			minimum of 240 liters per run.
	b. Mercury	4.8E-07 <sup>a</sup> lb per MMBtu of heat input	For M29, collect a minimum of 4 dscm per run; for M30A or M30B, collect a minimum sample as specified in the method; for ASTM D6784 <sup>b</sup> collect a minimum of 4 dscm.
17. Units designed to burn heavy liquid fuel	a. CO	130 ppm by volume on a dry basis corrected to 3 percent oxygen, 3-run average	1 hr minimum sampling time.
	b. Filterable PM (or TSM)	1.3E-02 lb per MMBtu of heat input; or (7.5E-05 lb per MMBtu of heat input)	Collect a minimum of 3 dscm per run.
18. Units designed to burn light liquid fuel	a. CO	130 ppm by volume on a dry basis corrected to 3 percent oxygen, 3-run average	1 hr minimum sampling time.
	b. Filterable PM (or TSM)	2.0E-03 <sup>a</sup> lb per MMBtu of heat input; or (2.9E-05 lb per MMBtu of heat input)	Collect a minimum of 3 dscm per run.
19. Units designed to burn liquid fuel that are non-continental units	a. CO	130 ppm by volume on a dry basis corrected to 3 percent oxygen, 3-run average based on stack test	1 hr minimum sampling time.
	b. Filterable PM (or TSM)	2.3E-02 lb per MMBtu of heat input; or (8.6E-04 lb per MMBtu of heat input)	Collect a minimum of 4 dscm per run.
20. Units designed to burn gas 2 (other) gases	a. CO	130 ppm by volume on a dry basis corrected to 3 percent oxygen, 3-run	1 hr minimum sampling time.

		average	
	b. HCl	1.7E-03 lb per MMBtu of heat input	For M26A, Collect a minimum of 2 dscm per run; for M26, collect a minimum of 240 liters per run.
	c. Mercury	7.9E-06 lb per MMBtu of heat input	For M29, collect a minimum of 3 dscm per run; for M30A or M30B, collect a minimum sample as specified in the method; for ASTM D6784 <sup>b</sup> collect a minimum of 3 dscm.
	d. Filterable PM (or TSM)	6.7E-03 lb per MMBtu of heat input; or (2.1E-04 lb per MMBtu of heat input)	Collect a minimum of 3 dscm per run.

<sup>a</sup>If you are conducting stack tests to demonstrate compliance and your performance tests for this pollutant for at least 2 consecutive years show that your emissions are at or below this limit, you can skip testing according to §63.7515 if all of the other provision of §63.7515 are met. For all other pollutants that do not contain a footnote “a”, your performance tests for this pollutant for at least 2 consecutive years must show that your emissions are at or below 75 percent of this limit in order to qualify for skip testing.

<sup>b</sup>Incorporated by reference, see §63.14.

<sup>c</sup>An owner or operator may request an alternative test method under §63.7 of this chapter, in order that compliance with the carbon monoxide emissions limit be determined using carbon dioxide as a diluent correction in place of oxygen at 3%. EPA Method 19 F-factors and EPA Method 19 equations must be used to generate the appropriate CO<sub>2</sub> correction percentage for the fuel type burned in the unit, and must also take into account that the 3% oxygen correction is to be done on a dry basis. The alternative test method request must account for any CO<sub>2</sub> being added to, or removed from, the emissions gas stream as a result of limestone injection, scrubber media, etc.

[80 FR 72831, Nov. 20, 2015]

[↑ Back to Top](#)

**Table 12 to Subpart DDDDD of Part 63—Alternative Emission Limits for New or Reconstructed Boilers and Process Heaters That Commenced Construction or Reconstruction After May 20, 2011, and Before December 23, 2011**

If your boiler or process heater is in this subcategory . . .	For the following pollutants . . .	The emissions must not exceed the following emission limits, except during periods of startup and shutdown . . .	Using this specified sampling volume or test run duration . . .
1. Units in all subcategories designed to burn solid fuel	a. HCl	0.022 lb per MMBtu of heat input	For M26A, collect a minimum of 1 dscm per run; for M26 collect a minimum of 120 liters per run.
	b. Mercury	3.5E-06 <sup>a</sup> lb per MMBtu of heat input	For M29, collect a minimum of 3 dscm per run; for M30A or M30B, collect a minimum sample as specified in the method; for ASTM D6784 <sup>b</sup> collect a minimum of 3 dscm.
2. Units design to burn coal/solid fossil fuel	a. Filterable PM (or TSM)	1.1E-03 lb per MMBtu of heat input; or (2.3E-05 lb per MMBtu of heat input)	Collect a minimum of 3 dscm per run.
3. Pulverized coal boilers designed to burn coal/solid fossil fuel	a. Carbon monoxide (CO) (or CEMS)	130 ppm by volume on a dry basis corrected to 3 percent oxygen, 3-run average; or (320 ppm by volume on a dry basis corrected to 3 percent oxygen, <sup>c</sup> 30-day rolling average)	1 hr minimum sampling time.
4. Stokers designed to burn coal/solid fossil fuel	a. CO (or CEMS)	130 ppm by volume on a dry basis corrected to 3 percent oxygen, 3-run average; or (340 ppm by volume on a dry basis corrected to 3 percent oxygen, <sup>c</sup> 10-day rolling average)	1 hr minimum sampling time.
5. Fluidized bed units designed to burn coal/solid fossil fuel	a. CO (or CEMS)	130 ppm by volume on a dry basis corrected to 3 percent oxygen, 3-run average; or (230 ppm by volume on a dry basis corrected to 3 percent oxygen, <sup>c</sup> 30-day rolling average)	1 hr minimum sampling time.

6. Fluidized bed units with an integrated heat exchanger designed to burn coal/solid fossil fuel	a. CO (or CEMS)	140 ppm by volume on a dry basis corrected to 3 percent oxygen, 3-run average; or (150 ppm by volume on a dry basis corrected to 3 percent oxygen, <sup>c</sup> 30-day rolling average)	1 hr minimum sampling time.
7. Stokers/sloped grate/others designed to burn wet biomass fuel	a. CO (or CEMS)	620 ppm by volume on a dry basis corrected to 3 percent oxygen, 3-run average; or (390 ppm by volume on a dry basis corrected to 3 percent oxygen, <sup>c</sup> 30-day rolling average)	1 hr minimum sampling time.
	b. Filterable PM (or TSM)	3.0E-02 lb per MMBtu of heat input; or (2.6E-05 lb per MMBtu of heat input)	Collect a minimum of 2 dscm per run.
8. Stokers/sloped grate/others designed to burn kiln-dried biomass fuel	a. CO b. Filterable PM (or TSM)	460 ppm by volume on a dry basis corrected to 3 percent oxygen, 3-run average 3.0E-02 lb per MMBtu of heat input; or (4.0E-03 lb per MMBtu of heat input)	1 hr minimum sampling time. Collect a minimum of 2 dscm per run.
9. Fluidized bed units designed to burn biomass/bio-based solids	a. CO (or CEMS)	260 ppm by volume on a dry basis corrected to 3 percent oxygen, 3-run average; or (310 ppm by volume on a dry basis corrected to 3 percent oxygen, <sup>c</sup> 30-day rolling average)	1 hr minimum sampling time.
	b. Filterable PM (or TSM)	9.8E-03 lb per MMBtu of heat input; or (8.3E-05 <sup>a</sup> lb per MMBtu of heat input)	Collect a minimum of 3 dscm per run.
10. Suspension burners designed to burn biomass/bio-based solids	a. CO (or CEMS)	2,400 ppm by volume on a dry basis corrected to 3 percent oxygen, 3-run average; or (2,000 ppm by volume on a dry basis corrected to 3 percent oxygen, <sup>c</sup> 10-day rolling average)	1 hr minimum sampling time.

	b. Filterable PM (or TSM)	3.0E-02 lb per MMBtu of heat input; or (6.5E-03 lb per MMBtu of heat input)	Collect a minimum of 2 dscm per run.
11. Dutch Ovens/Pile burners designed to burn biomass/bio-based solids	a. CO (or CEMS)	470 ppm by volume on a dry basis corrected to 3 percent oxygen, 3-run average; or (520 ppm by volume on a dry basis corrected to 3 percent oxygen, <sup>c</sup> 10-day rolling average)	1 hr minimum sampling time.
	b. Filterable PM (or TSM)	3.2E-03 lb per MMBtu of heat input; or (3.9E-05 lb per MMBtu of heat input)	Collect a minimum of 3 dscm per run.
12. Fuel cell units designed to burn biomass/bio-based solids	a. CO b. Filterable PM (or TSM)	910 ppm by volume on a dry basis corrected to 3 percent oxygen, 3-run average 2.0E-02 lb per MMBtu of heat input; or (2.9E-05 lb per MMBtu of heat input)	1 hr minimum sampling time. Collect a minimum of 2 dscm per run.
13. Hybrid suspension grate boiler designed to burn biomass/bio-based solids	a. CO (or CEMS)	1,500 ppm by volume on a dry basis corrected to 3 percent oxygen, 3-run average; or (900 ppm by volume on a dry basis corrected to 3 percent oxygen, <sup>c</sup> 30-day rolling average)	1 hr minimum sampling time.
	b. Filterable PM (or TSM)	2.6E-02 lb per MMBtu of heat input; or (4.4E-04 lb per MMBtu of heat input)	Collect a minimum of 3 dscm per run.
14. Units designed to burn liquid fuel	a. HCl	4.4E-04 lb per MMBtu of heat input	For M26A: Collect a minimum of 2 dscm per run; for M26, collect a minimum of 240 liters per run.
	b. Mercury	4.8E-07 <sup>a</sup> lb per MMBtu of heat input	For M29, collect a minimum of 4 dscm per run; for M30A or M30B, collect a minimum sample as specified in the



			method; for ASTM D6784 <sup>b</sup> collect a minimum of 4 dscm.
15. Units designed to burn heavy liquid fuel	a. CO	130 ppm by volume on a dry basis corrected to 3 percent oxygen, 3-run average	1 hr minimum sampling time.
	b. Filterable PM (or TSM)	1.3E-02 lb per MMBtu of heat input; or (7.5E-05 lb per MMBtu of heat input)	Collect a minimum of 2 dscm per run.
16. Units designed to burn light liquid fuel	a. CO	130 ppm by volume on a dry basis corrected to 3 percent oxygen, 3-run average	1 hr minimum sampling time.
	b. Filterable PM (or TSM)	1.3E-03 <sup>a</sup> lb per MMBtu of heat input; or (2.9E-05 lb per MMBtu of heat input)	Collect a minimum of 3 dscm per run.
17. Units designed to burn liquid fuel that are non-continental units	a. CO	130 ppm by volume on a dry basis corrected to 3 percent oxygen, 3-run average based on stack test	1 hr minimum sampling time.
	b. Filterable PM (or TSM)	2.3E-02 lb per MMBtu of heat input; or (8.6E-04 lb per MMBtu of heat input)	Collect a minimum of 4 dscm per run.
18. Units designed to burn gas 2 (other) gases	a. CO	130 ppm by volume on a dry basis corrected to 3 percent oxygen, 3-run average	1 hr minimum sampling time.
	b. HCl	1.7E-03 lb per MMBtu of heat input	For M26A, Collect a minimum of 2 dscm per run; for M26, collect a minimum of 240 liters per run.
	c. Mercury	7.9E-06 lb per MMBtu of heat input	For M29, collect a minimum of 3 dscm per run; for M30A or M30B, collect a minimum sample as specified in the method; for ASTM D6784 <sup>b</sup>

			collect a minimum of 3 dscm.
	d. Filterable PM (or TSM)	6.7E-03 lb per MMBtu of heat input; or (2.1E-04 lb per MMBtu of heat input)	Collect a minimum of 3 dscm per run.

<sup>a</sup>If you are conducting stack tests to demonstrate compliance and your performance tests for this pollutant for at least 2 consecutive years show that your emissions are at or below this limit, you can skip testing according to §63.7515 if all of the other provision of §63.7515 are met. For all other pollutants that do not contain a footnote “a”, your performance tests for this pollutant for at least 2 consecutive years must show that your emissions are at or below 75 percent of this limit in order to qualify for skip testing.

<sup>b</sup>Incorporated by reference, see §63.14.

<sup>c</sup>An owner or operator may request an alternative test method under §63.7 of this chapter, in order that compliance with the carbon monoxide emissions limit be determined using carbon dioxide as a diluent correction in place of oxygen at 3%. EPA Method 19 F-factors and EPA Method 19 equations must be used to generate the appropriate CO<sub>2</sub> correction percentage for the fuel type burned in the unit, and must also take into account that the 3% oxygen correction is to be done on a dry basis. The alternative test method request must account for any CO<sub>2</sub> being added to, or removed from, the emissions gas stream as a result of limestone injection, scrubber media, etc.

[80 FR 72834, Nov. 20, 2015]

[↑ Back to Top](#)

**Table 13 to Subpart DDDDD of Part 63—Alternative Emission Limits for New or Reconstructed Boilers and Process Heaters That Commenced Construction or Reconstruction After December 23, 2011, and Before April 1, 2013**

<b>If your boiler or process heater is in this subcategory . . .</b>	<b>For the following pollutants . . .</b>	<b>The emissions must not exceed the following emission limits, except during periods of startup and shutdown . . .</b>	<b>Using this specified sampling volume or test run duration . . .</b>
1. Units in all subcategories designed to burn solid fuel	a. HCl	0.022 lb per MMBtu of heat input	For M26A, collect a minimum of 1 dscm per run; for M26 collect a minimum of 120 liters per run.
	b. Mercury	8.6E-07 <sup>a</sup> lb per MMBtu of heat input	For M29, collect a minimum of 4 dscm per run; for M30A or M30B, collect a minimum sample as specified in the

			method; for ASTM D6784 <sup>b</sup> collect a minimum of 4 dscm.
2. Pulverized coal boilers designed to burn coal/solid fossil fuel	a. Carbon monoxide (CO) (or CEMS)	130 ppm by volume on a dry basis corrected to 3 percent oxygen, 3-run average; or (320 ppm by volume on a dry basis corrected to 3 percent oxygen, <sup>c</sup> 30-day rolling average)	1 hr minimum sampling time.
	b. Filterable PM (or TSM)	1.1E-03 lb per MMBtu of heat input; or (2.8E-05 lb per MMBtu of heat input)	Collect a minimum of 3 dscm per run.
3. Stokers designed to burn coal/solid fossil fuel	a. CO (or CEMS)	130 ppm by volume on a dry basis corrected to 3 percent oxygen, 3-run average; or (340 ppm by volume on a dry basis corrected to 3 percent oxygen, <sup>c</sup> 10-day rolling average)	1 hr minimum sampling time.
	b. Filterable PM (or TSM)	2.8E-02 lb per MMBtu of heat input; or (2.3E-05 lb per MMBtu of heat input)	Collect a minimum of 2 dscm per run.
4. Fluidized bed units designed to burn coal/solid fossil fuel	a. CO (or CEMS)	130 ppm by volume on a dry basis corrected to 3 percent oxygen, 3-run average; or (230 ppm by volume on a dry basis corrected to 3 percent oxygen, <sup>c</sup> 30-day rolling average)	1 hr minimum sampling time.
	b. Filterable PM (or TSM)	1.1E-03 lb per MMBtu of heat input; or (2.3E-05 lb per MMBtu of heat input)	Collect a minimum of 3 dscm per run.
5. Fluidized bed units with an integrated heat exchanger designed to burn coal/solid fossil fuel	a. CO (or CEMS)	140 ppm by volume on a dry basis corrected to 3 percent oxygen, 3-run average; or (150 ppm by volume on a dry basis corrected to 3 percent oxygen, <sup>c</sup>	1 hr minimum sampling time.

		30-day rolling average)	
	b. Filterable PM (or TSM)	1.1E-03 lb per MMBtu of heat input; or (2.3E-05 lb per MMBtu of heat input)	Collect a minimum of 3 dscm per run.
6. Stokers/sloped grate/others designed to burn wet biomass fuel	a. CO (or CEMS)	620 ppm by volume on a dry basis corrected to 3 percent oxygen, 3-run average; or (410 ppm by volume on a dry basis corrected to 3 percent oxygen, <sup>c</sup> 10-day rolling average)	1 hr minimum sampling time.
	b. Filterable PM (or TSM)	3.0E-02 lb per MMBtu of heat input; or (2.6E-05 lb per MMBtu of heat input)	Collect a minimum of 2 dscm per run.
7. Stokers/sloped grate/others designed to burn kiln-dried biomass fuel	a. CO	460 ppm by volume on a dry basis corrected to 3 percent oxygen	1 hr minimum sampling time.
	b. Filterable PM (or TSM)	3.2E-01 lb per MMBtu of heat input; or (4.0E-03 lb per MMBtu of heat input)	Collect a minimum of 2 dscm per run.
8. Fluidized bed units designed to burn biomass/bio-based solids	a. CO (or CEMS)	230 ppm by volume on a dry basis corrected to 3 percent oxygen, 3-run average; or (310 ppm by volume on a dry basis corrected to 3 percent oxygen, <sup>c</sup> 30-day rolling average)	1 hr minimum sampling time.
	b. Filterable PM (or TSM)	9.8E-03 lb per MMBtu of heat input; or (8.3E-05 <sup>d</sup> lb per MMBtu of heat input)	Collect a minimum of 3 dscm per run.
9. Suspension burners designed to burn biomass/bio-based solids	a. CO (or CEMS)	2,400 ppm by volume on a dry basis corrected to 3 percent oxygen, 3-run average; or (2,000 ppm by volume on a dry basis corrected to 3 percent oxygen, <sup>c</sup>	1 hr minimum sampling time.

		10-day rolling average)	
	b. Filterable PM (or TSM)	5.1E-02 lb per MMBtu of heat input; or (6.5E-03 lb per MMBtu of heat input)	Collect a minimum of 2 dscm per run.
10. Dutch Ovens/Pile burners designed to burn biomass/bio-based solids	a. CO (or CEMS)	810 ppm by volume on a dry basis corrected to 3 percent oxygen, 3-run average; or (520 ppm by volume on a dry basis corrected to 3 percent oxygen, <sup>c</sup> 10-day rolling average)	1 hr minimum sampling time.
	b. Filterable PM (or TSM)	3.6E-02 lb per MMBtu of heat input; or (3.9E-05 lb per MMBtu of heat input)	Collect a minimum of 2 dscm per run.
11. Fuel cell units designed to burn biomass/bio-based solids	a. CO	910 ppm by volume on a dry basis corrected to 3 percent oxygen	1 hr minimum sampling time.
	b. Filterable PM (or TSM)	2.0E-02 lb per MMBtu of heat input; or (2.9E-05 lb per MMBtu of heat input)	Collect a minimum of 2 dscm per run.
12. Hybrid suspension grate boiler designed to burn biomass/bio-based solids	a. CO (or CEMS)	1,500 ppm by volume on a dry basis corrected to 3 percent oxygen, 3-run average; or (900 ppm by volume on a dry basis corrected to 3 percent oxygen, <sup>c</sup> 30-day rolling average)	1 hr minimum sampling time.
	b. Filterable PM (or TSM)	2.6E-02 lb per MMBtu of heat input; or (4.4E-04 lb per MMBtu of heat input)	Collect a minimum of 3 dscm per run.
13. Units designed to burn liquid fuel	a. HCl	1.2E-03 lb per MMBtu of heat input	For M26A: Collect a minimum of 2 dscm per run; for M26, collect a minimum of 240 liters per run.

	b. Mercury	4.9E-07 <sup>a</sup> lb per MMBtu of heat input	For M29, collect a minimum of 4 dscm per run; for M30A or M30B, collect a minimum sample as specified in the method; for ASTM D6784 <sup>b</sup> collect a minimum of 4 dscm.
14. Units designed to burn heavy liquid fuel	a. CO (or CEMS)	130 ppm by volume on a dry basis corrected to 3 percent oxygen, 3-run average; or (18 ppm by volume on a dry basis corrected to 3 percent oxygen, <sup>c</sup> 10-day rolling average)	1 hr minimum sampling time.
15. Units designed to burn light liquid fuel	a. CO (or CEMS)	130 <sup>a</sup> ppm by volume on a dry basis corrected to 3 percent oxygen; or (60 ppm by volume on a dry basis corrected to 3 percent oxygen, <sup>c</sup> 1-day block average)	1 hr minimum sampling time.
	b. Filterable PM (or TSM)	1.1E-03 <sup>a</sup> lb per MMBtu of heat input; or (2.9E-05 lb per MMBtu of heat input)	Collect a minimum of 3 dscm per run.
16. Units designed to burn liquid fuel that are non-continental units	a. CO	130 ppm by volume on a dry basis corrected to 3 percent oxygen, 3-run average based on stack test; or (91 ppm by volume on a dry basis corrected to 3 percent oxygen, 3-hour rolling average)	1 hr minimum sampling time.
	b. Filterable PM (or TSM)	2.3E-02 lb per MMBtu of heat input; or (8.6E-04 lb per MMBtu of heat input)	Collect a minimum of 2 dscm per run.
17. Units designed to burn gas 2 (other) gases	a. CO	130 ppm by volume on a dry basis corrected to 3 percent oxygen	1 hr minimum sampling time.
	b. HCl	1.7E-03 lb per MMBtu of heat	For M26A, Collect a minimum of 2 dscm per run; for M26,

		input	collect a minimum of 240 liters per run.
	c. Mercury	7.9E-06 lb per MMBtu of heat input	For M29, collect a minimum of 3 dscm per run; for M30A or M30B, collect a minimum sample as specified in the method; for ASTM D6784 <sup>b</sup> collect a minimum of 3 dscm.
	d. Filterable PM (or TSM)	6.7E-03 lb per MMBtu of heat input; or (2.1E-04 lb per MMBtu of heat input)	Collect a minimum of 3 dscm per run.

<sup>a</sup>If you are conducting stack tests to demonstrate compliance and your performance tests for this pollutant for at least 2 consecutive years show that your emissions are at or below this limit and you are not required to conduct testing for CEMS or CPMS monitor certification, you can skip testing according to §63.7515 if all of the other provision of §63.7515 are met. For all other pollutants that do not contain a footnote “a”, your performance tests for this pollutant for at least 2 consecutive years must show that your emissions are at or below 75 percent of this limit in order to qualify for skip testing.

<sup>b</sup>Incorporated by reference, see §63.14.

<sup>c</sup>An owner or operator may request an alternative test method under §63.7 of this chapter, in order that compliance with the carbon monoxide emissions limit be determined using carbon dioxide as a diluent correction in place of oxygen at 3%. EPA Method 19 F-factors and EPA Method 19 equations must be used to generate the appropriate CO<sub>2</sub> correction percentage for the fuel type burned in the unit, and must also take into account that the 3% oxygen correction is to be done on a dry basis. The alternative test method request must account for any CO<sub>2</sub> being added to, or removed from, the emissions gas stream as a result of limestone injection, scrubber media, etc.

[78 FR 7210, Jan. 31, 2013, as amended at 80 FR 72836, Nov. 20, 2015]

[↑ Back to Top](#)

**CERTIFICATE OF SERVICE**

I, Cynthia Hook, hereby certify that a copy of this permit has been mailed by first class mail to Great Lakes Chemical Corporation - Central Plant, P.O. Box 7020, El Dorado, AR, 71731, on this 10<sup>th</sup> day of May, 2018.



\_\_\_\_\_  
Cynthia Hook, ASIII, Office of Air Quality